



FCC RF Test Report

APPLICANT : Motorola Mobility, LLC
EQUIPMENT : Mobile Cellular Phone
BRAND NAME : Motorola
MODEL NAME : 5137
FCC ID : IHDT56UC2
STANDARD : FCC Part 15 Subpart E §15.407
CLASSIFICATION : (NII) Unlicensed National Information Infrastructure

The product was received on Apr. 15, 2015 and testing was completed on May 19, 2015. We, SPORTON INTERNATIONAL INC., would like to declare that the tested sample has been evaluated in accordance with the test procedures and has been in compliance with the applicable technical standards.

The test results in this report apply exclusively to the tested model / sample. Without written approval of SPORTON INTERNATIONAL INC., the test report shall not be reproduced except in full.

Louis Wu

Reviewed by: Louis Wu / Manager

Jones Tsai

Approved by: Jones Tsai / Manager



SPORTON INTERNATIONAL INC.

No. 52, Hwa Ya 1st Rd., Hwa Ya Technology Park, Kwei-Shan District, Tao Yuan City, Taiwan, R.O.C.

SPORTON INTERNATIONAL INC.

TEL : 886-3-327-3456

FAX : 886-3-328-4978

FCC ID : IHDT56UC2

Page Number : 1 of 45

Report Issued Date : Jun. 18, 2015

Report Version : Rev. 01

Report Template No.: BU5-FR15EWLB4 AC MA Version 1.0



TABLE OF CONTENTS

REVISION HISTORY..... 3

SUMMARY OF TEST RESULT 4

1 GENERAL DESCRIPTION 5

 1.1 Applicant 5

 1.2 Manufacturer..... 5

 1.3 Feature of Equipment Under Test 5

 1.4 Product Specification of Equipment Under Test..... 7

 1.5 Modification of EUT 7

 1.6 Testing Location 8

 1.7 Applicable Standards..... 8

2 TEST CONFIGURATION OF EQUIPMENT UNDER TEST 9

 2.1 Carrier Frequency and Channel 9

 2.2 Pre-Scanned RF Power..... 10

 2.3 Test Mode..... 19

 2.4 Connection Diagram of Test System..... 21

 2.5 Support Unit used in test configuration and system 24

 2.6 EUT Operation Test Setup 24

 2.7 Measurement Results Explanation Example..... 24

3 TEST RESULT..... 25

 3.1 6dB Bandwidth Measurement 25

 3.2 Maximum Conducted Output Power Measurement 27

 3.3 Power Spectral Density Measurement 28

 3.4 Unwanted Emissions Measurement 31

 3.5 AC Conducted Emission Measurement..... 37

 3.6 Frequency Stability Measurement 41

 3.7 Automatically Discontinue Transmission 42

 3.8 Antenna Requirements 43

4 LIST OF MEASURING EQUIPMENT 44

5 UNCERTAINTY OF EVALUATION 45

APPENDIX A. CONDUCTED TEST RESULTS

APPENDIX B. RADIATED TEST RESULTS



SUMMARY OF TEST RESULT

Report Section	FCC Rule	Description	Limit	Result	Remark
3.1	15.403(i)	6dB Bandwidth	> 500kHz	Pass	-
3.2	15.407(a)	Maximum Conducted Output Power	≤ 30 dBm	Pass	-
3.3	15.407(a)	Power Spectral Density	≤ 30 dBm/500kHz	Pass	-
3.4	15.407(b)	Unwanted Emissions	≤ -17, -27 dBm/MHz & 15.209(a)	Pass	Under limit 1.36 dB at 5714.600 MHz
3.5	15.207	AC Conducted Emission	15.207(a)	Pass	Under limit 7.50 dB at 2.046 MHz
3.6	15.407(g)	Frequency Stability	Within Operation Band	Pass	-
3.7	15.407(c)	Automatically Discontinue Transmission	Discontinue Transmission	Pass	-
3.8	15.203 & 15.407(a)	Antenna Requirement	N/A	Pass	-



1 General Description

1.1 Applicant

Motorola Mobility, LLC

222 W Merchandise Mart Plaza, Suite 1800, Chicago, IL 60654, United States

1.2 Manufacturer

Motorola Mobility, LLC

222 W Merchandise Mart Plaza, Suite 1800, Chicago, IL 60654, United States

1.3 Feature of Equipment Under Test

Product Feature	
Equipment	Mobile Cellular Phone
Brand Name	Motorola
Model Name	5137
IMEI Code	355486060017664 (Radiation) 355486060017805 (Conduction)
FCC ID	IHDT56UC2
EUT supports Radios application	GSM/EGPRS/WCDMA/HSPA/LTE/NFC 2.4GHz WLAN 11b/g/n HT20 WLAN 11ac VHT20 5GHz WLAN 11a/n HT20/HT40 WLAN 11ac VHT20/VHT40/VHT80 Bluetooth v3.0 EDR Bluetooth v4.1 - LE
HW Version	P2
EUT Stage	Identical Prototype

Remark: The above EUT's information was declared by manufacturer. Please refer to the specifications or user's manual for more detailed description.



Accessory List	
AC Adapter 1	Brand Name : Motorola
	Model Name : SPN5791A
AC Adapter 2	Brand Name : Motorola
	Model Name : SPN5864A
AC Adapter 3	Brand Name : Motorola
	Model Name : SPN5886A
Earphone	Brand Name : Motorola
	Model Name : SJYN1305A
Battery	Brand Name : Motorola
	Model Name : FX30
USB cable	Brand Name : Motorola
	Model Name : SKN6461A



1.4 Product Specification of Equipment Under Test

Product Specification subjective to this standard										
Tx/Rx Channel Frequency Range	5725 MHz ~ 5850 MHz									
Maximum Output Power	<p>SISO <Ant. 1> 802.11a : 16.26 dBm / 0.0423 W 802.11n HT20 : 14.74 dBm / 0.0298 W 802.11n HT40 : 14.25 dBm / 0.0266 W 802.11ac VHT20: 14.69 dBm / 0.0294 W 802.11ac VHT40: 14.23 dBm / 0.0265 W 802.11ac VHT80: 11.56 dBm / 0.0143 W</p> <p>SISO <Ant. 2> 802.11a : 16.64 dBm / 0.0461 W 802.11n HT20 : 14.97 dBm / 0.0314 W 802.11n HT40 : 14.41 dBm / 0.0276 W 802.11ac VHT20: 14.92 dBm / 0.0310 W 802.11ac VHT40: 14.50 dBm / 0.0282 W 802.11ac VHT80: 12.16 dBm / 0.0164 W</p> <p>MIMO <Ant. Port 1 + 2> 802.11a : 19.45 dBm / 0.0881 W 802.11n HT20 : 17.92 dBm / 0.0619 W 802.11n HT40 : 18.66 dBm / 0.0735 W 802.11ac VHT20: 18.02 dBm / 0.0634 W 802.11ac VHT40: 17.96 dBm / 0.0625 W 802.11ac VHT80: 14.74 dBm / 0.0298 W</p>									
Type of Modulation	802.11a/n : OFDM (BPSK / QPSK / 16QAM / 64QAM) 802.11ac : OFDM (BPSK / QPSK / 16QAM / 64QAM / 256QAM)									
Antenna Type	Antenna 1 : IFA Antenna Antenna 2 : IFA Antenna									
Antenna Gain	Antenna 1 : 0.50 dBi Antenna 2 : 0.50 dBi									
Antenna Function Description	<table border="1"> <thead> <tr> <th></th> <th>Ant. 1</th> <th>Ant. 2</th> </tr> </thead> <tbody> <tr> <td>802.11 a/n/ac SISO</td> <td>V</td> <td>V</td> </tr> <tr> <td>802.11 a/n/ac MIMO</td> <td>V</td> <td>V</td> </tr> </tbody> </table>		Ant. 1	Ant. 2	802.11 a/n/ac SISO	V	V	802.11 a/n/ac MIMO	V	V
	Ant. 1	Ant. 2								
802.11 a/n/ac SISO	V	V								
802.11 a/n/ac MIMO	V	V								

1.5 Modification of EUT

No modifications are made to the EUT during all test items.



1.6 Testing Location

Sporton Lab is accredited to ISO 17025 by Taiwan Accreditation Foundation (TAF code : 1190) and the FCC designation No. TW1022 under the FCC 2.948(e) by Mutual Recognition Agreement (MRA) in FCC Test.

Test Site	SPORTON INTERNATIONAL INC.		
Test Site Location	No. 52, Hwa Ya 1 st Rd., Hwa Ya Technology Park, Kwei-Shan District, Tao Yuan City, Taiwan, R.O.C. TEL: +886-3-327-3456 FAX: +886-3-328-4978		
Test Site No.	Sporton Site No.		
	TH02-HY	CO05-HY	03CH07-HY

Note: The test site complies with ANSI C63.4 2009 requirement.

1.7 Applicable Standards

According to the specifications of the manufacturer, the EUT must comply with the requirements of the following standards:

- ♦ FCC Part 15 Subpart E
- ♦ FCC KDB 789033 D02 General UNII Test Procedures New Rules v01
- ♦ FCC KDB 662911 D01 Multiple Transmitter Output v02r01.
- ♦ ANSI C63.10-2009

Remark:

1. All test items were verified and recorded according to the standards and without any deviation during the test.
2. FCC permits the use of the 1.5 meter table as an alternative in C63.10-2013 through inquiry tracking number 961829.
3. This EUT has also been tested and complied with the requirements of FCC Part 15, Subpart B, recorded in a separate test report.



2 Test Configuration of Equipment Under Test

The EUT has been associated with peripherals and configuration operated in a manner tended to maximize its emission characteristics in a typical application. Frequency range investigated: conducted emission (150 kHz to 30 MHz) and radiated emission (9 kHz to the 10th harmonic of the highest fundamental frequency or to 40 GHz, whichever is lower). For radiated measurement, pre-scanned in three orthogonal panels, X, Y, Z. The worst cases (Y plane) were recorded in this report.

The final configuration from all the combinations and the worst-case data rates were investigated by measuring the maximum power across all the data rates and modulation modes under section 2.2.

Based on the worst configuration found above, the RF power setting is set individually to meet FCC compliance limit for the final conducted and radiated tests shown in section 2.3.

2.1 Carrier Frequency and Channel

Frequency Band	Channel	Freq. (MHz)	Channel	Freq. (MHz)
5725-5850 MHz Band 4 (U-NII-3)	149	5745	157	5785
	151	5755	159	5795
	153	5765	161	5805
	155	5775	165	5825

Note: The above Frequency and Channel in boldface were 802.11n HT40.



2.2 Pre-Scanned RF Power

Preliminary tests were performed in different data rate and data rate associated with the highest power were chosen for full test in the following tables.

SISO <Ant. 1>

Channel	Frequency	5GHz 802.11a Average Power (dBm)							
		Data Rate							
		6 Mbps	9 Mbps	12 Mbps	18 Mbps	24 Mbps	36 Mbps	48 Mbps	54 Mbps
CH 149	5745 MHz	14.92	14.91	14.89	14.87	14.86	14.13	13.33	13.34
CH 157	5785 MHz	16.26	16.03	15.97	16.06	15.98	13.56	12.81	12.69
CH 165	5825 MHz	15.76	15.75	15.74	15.73	15.72	12.91	12.61	12.40

Channel	Frequency	5GHz 802.11a Peak Power (dBm)							
		Data Rate							
		6 Mbps	9 Mbps	12 Mbps	18 Mbps	24 Mbps	36 Mbps	48 Mbps	54 Mbps
CH 149	5745 MHz	19.56	19.55	19.55	19.54	19.53	19.52	19.51	19.50
CH 157	5785 MHz	19.76	19.73	19.72	19.49	19.48	19.75	19.72	19.70
CH 165	5825 MHz	19.54	19.53	19.53	19.52	19.51	19.51	19.50	19.50

Channel	Frequency	5GHz 802.11n HT20 Average Power (dBm)							
		Data Rate							
		MCS0	MCS1	MCS2	MCS3	MCS4	MCS5	MCS6	MCS7
CH 149	5745 MHz	14.74	14.48	14.56	14.18	14.19	13.35	13.36	12.42
CH 157	5785 MHz	14.43	14.20	14.23	13.70	13.69	12.81	12.81	11.80
CH 165	5825 MHz	14.59	14.36	14.43	14.58	14.58	13.24	12.75	12.48

Channel	Frequency	5GHz 802.11n HT20 Peak Power (dBm)							
		Data Rate							
		MCS0	MCS1	MCS2	MCS3	MCS4	MCS5	MCS6	MCS7
CH 149	5745 MHz	20.16	20.15	20.08	20.10	20.15	20.14	20.13	20.13
CH 157	5785 MHz	19.86	19.48	19.66	19.64	19.77	19.64	19.83	18.95
CH 165	5825 MHz	19.81	19.71	19.77	19.74	19.77	19.78	19.74	19.24



Channel	Frequency	5GHz 802.11n HT40 Average Power (dBm)							
		Data Rate							
		MCS0	MCS1	MCS2	MCS3	MCS4	MCS5	MCS6	MCS7
CH 151	5755 MHz	12.26	12.02	11.95	12.09	11.99	12.00	12.11	11.01
CH 159	5795 MHz	14.25	14.07	14.16	13.08	13.19	12.12	12.18	11.21

Channel	Frequency	5GHz 802.11n HT40 Peak Power (dBm)							
		Data Rate							
		MCS0	MCS1	MCS2	MCS3	MCS4	MCS5	MCS6	MCS7
CH 151	5755 MHz	18.93	18.90	18.88	18.92	18.91	18.92	18.92	18.31
CH 159	5795 MHz	19.72	19.52	19.50	19.52	19.55	19.56	18.45	18.19

Channel	Frequency	5GHz 802.11ac VHT20 Average Power (dBm)								
		Data Rate								
		MCS0	MCS1	MCS2	MCS3	MCS4	MCS5	MCS6	MCS7	MCS8
CH 149	5745 MHz	14.69	14.50	14.61	14.22	14.19	13.33	13.37	12.40	11.60
CH 157	5785 MHz	14.48	14.12	14.33	13.78	13.74	12.89	12.85	11.79	10.81
CH 165	5825 MHz	14.60	14.32	14.39	13.96	13.93	13.09	13.04	11.97	11.05

Channel	Frequency	5GHz 802.11ac VHT20 Peak Power (dBm)								
		Data Rate								
		MCS0	MCS1	MCS2	MCS3	MCS4	MCS5	MCS6	MCS7	MCS8
CH 149	5745 MHz	20.12	19.90	19.95	20.10	20.10	20.08	20.08	20.09	19.97
CH 157	5785 MHz	19.87	19.66	19.61	19.75	19.85	19.84	19.80	18.86	18.78
CH 165	5825 MHz	19.53	19.52	19.52	19.50	19.51	19.51	19.52	19.21	19.50



Channel	Frequency	5GHz 802.11ac VHT40 Average Power (dBm)									
		Data Rate									
		MCS0	MCS1	MCS2	MCS3	MCS4	MCS5	MCS6	MCS7	MCS8	MCS9
CH 151	5755 MHz	12.66	12.47	12.42	12.48	12.64	12.00	12.05	10.91	10.90	10.04
CH 159	5795 MHz	14.23	14.02	14.03	13.17	13.28	12.16	12.21	11.16	10.30	9.23

Channel	Frequency	5GHz 802.11ac VHT40 Peak Power (dBm)									
		Data Rate									
		MCS0	MCS1	MCS2	MCS3	MCS4	MCS5	MCS6	MCS7	MCS8	MCS9
CH 151	5755 MHz	19.06	19.03	18.81	19.05	19.04	19.01	19.00	18.70	18.49	18.77
CH 159	5795 MHz	19.62	19.55	19.44	19.60	19.59	19.59	19.44	18.26	18.48	18.42

Channel	Frequency	5GHz 802.11ac VHT80 Average Power (dBm)									
		Data Rate									
		MCS0	MCS1	MCS2	MCS3	MCS4	MCS5	MCS6	MCS7	MCS8	MCS9
CH 155	5775MHz	11.56	11.48	11.31	11.03	10.91	11.07	10.98	9.96	9.04	8.89

Channel	Frequency	5GHz 802.11ac VHT80 Peak Power (dBm)									
		Data Rate									
		MCS0	MCS1	MCS2	MCS3	MCS4	MCS5	MCS6	MCS7	MCS8	MCS9
CH 155	5775MHz	18.04	17.94	17.76	18.01	18.02	18.03	18.02	18.03	18.01	17.98



SISO <Ant. 2>

Channel	Frequency	5GHz 802.11a Average Power (dBm)							
		Data Rate							
		6 Mbps	9 Mbps	12 Mbps	18 Mbps	24 Mbps	36 Mbps	48 Mbps	54 Mbps
CH 149	5745 MHz	15.69	15.47	15.37	15.32	15.31	14.47	13.65	13.48
CH 157	5785 MHz	16.64	16.34	16.32	16.52	16.45	14.04	13.26	13.24
CH 165	5825 MHz	16.04	16.03	16.02	16.01	16.00	14.16	13.45	13.33

Channel	Frequency	5GHz 802.11a Peak Power (dBm) (800ns)							
		Data Rate							
		6 Mbps	9 Mbps	12 Mbps	18 Mbps	24 Mbps	36 Mbps	48 Mbps	54 Mbps
CH 149	5745 MHz	20.40	20.19	20.18	20.19	20.18	20.39	20.38	20.39
CH 157	5785 MHz	20.67	20.35	20.38	20.42	20.44	20.35	20.46	20.52
CH 165	5825 MHz	20.20	20.09	20.08	20.08	20.07	20.19	20.19	20.19

Channel	Frequency	5GHz 802.11n HT20 Average Power (dBm)							
		Data Rate							
		MCS0	MCS1	MCS2	MCS3	MCS4	MCS5	MCS6	MCS7
CH 149	5745 MHz	14.97	14.83	14.85	14.51	14.36	13.58	13.54	12.75
CH 157	5785 MHz	14.82	14.50	14.50	14.10	14.09	13.28	13.26	12.25
CH 165	5825 MHz	14.89	14.54	14.56	14.23	14.20	13.47	13.40	12.40

Channel	Frequency	5GHz 802.11n HT20 Peak Power (dBm)							
		Data Rate							
		MCS0	MCS1	MCS2	MCS3	MCS4	MCS5	MCS6	MCS7
CH 149	5745 MHz	20.68	20.65	20.62	20.65	20.18	20.67	20.67	20.61
CH 157	5785 MHz	20.51	20.22	20.26	20.44	20.43	20.45	20.50	20.36
CH 165	5825 MHz	20.53	20.20	20.22	20.46	20.43	20.46	20.49	20.16



Channel	Frequency	5GHz 802.11n HT40 Average Power (dBm)							
		Data Rate							
		MCS0	MCS1	MCS2	MCS3	MCS4	MCS5	MCS6	MCS7
CH 151	5755 MHz	12.54	12.33	12.31	12.41	12.48	12.37	12.50	11.37
CH 159	5795 MHz	14.41	14.25	14.25	13.44	13.48	12.41	12.43	11.45

Channel	Frequency	5GHz 802.11n HT40 Peak Power (dBm)							
		Data Rate							
		MCS0	MCS1	MCS2	MCS3	MCS4	MCS5	MCS6	MCS7
CH 151	5755 MHz	19.60	19.58	19.57	19.59	19.59	19.59	19.59	19.41
CH 159	5795 MHz	20.21	19.95	19.94	20.19	20.18	20.13	20.06	19.61

Channel	Frequency	5GHz 802.11ac VHT20 Average Power (dBm)								
		Data Rate								
		MCS0	MCS1	MCS2	MCS3	MCS4	MCS5	MCS6	MCS7	MCS8
CH 149	5745 MHz	14.92	14.83	14.90	14.48	14.47	13.55	13.58	12.60	11.98
CH 157	5785 MHz	14.77	14.33	14.50	14.01	14.07	13.27	13.22	12.21	11.33
CH 165	5825 MHz	14.87	14.45	14.61	14.22	14.22	13.42	13.40	12.35	11.33

Channel	Frequency	5GHz 802.11ac VHT20 Peak Power (dBm)								
		Data Rate								
		MCS0	MCS1	MCS2	MCS3	MCS4	MCS5	MCS6	MCS7	MCS8
CH 149	5745 MHz	20.60	20.55	20.55	20.58	20.59	20.58	20.57	20.55	20.18
CH 157	5785 MHz	20.45	20.29	20.34	20.42	20.42	20.41	20.44	20.42	20.39
CH 165	5825 MHz	20.44	20.33	20.25	20.41	20.42	20.43	20.35	20.32	19.41



Channel	Frequency	5GHz 802.11ac VHT40 Average Power (dBm)									
		Data Rate									
		MCS0	MCS1	MCS2	MCS3	MCS4	MCS5	MCS6	MCS7	MCS8	MCS9
CH 151	5755 MHz	12.99	12.53	12.81	12.80	12.52	12.49	12.54	11.38	11.39	10.52
CH 159	5795 MHz	14.50	14.21	14.21	13.46	13.40	12.55	12.45	11.43	10.56	9.56

Channel	Frequency	5GHz 802.11ac VHT40 Peak Power (dBm)									
		Data Rate									
		MCS0	MCS1	MCS2	MCS3	MCS4	MCS5	MCS6	MCS7	MCS8	MCS9
CH 151	5755 MHz	19.66	19.54	19.52	19.65	19.65	19.65	19.64	19.45	19.57	19.48
CH 159	5795 MHz	20.25	20.03	20.02	19.23	20.17	20.19	20.06	19.77	18.73	18.94

Channel	Frequency	5GHz 802.11ac VHT80 Average Power (dBm)									
		Data Rate									
		MCS0	MCS1	MCS2	MCS3	MCS4	MCS5	MCS6	MCS7	MCS8	MCS9
CH 155	5775MHz	11.95	12.16	12.05	11.34	11.30	11.33	11.42	10.33	9.27	9.38

Channel	Frequency	5GHz 802.11ac VHT80 Peak Power (dBm)									
		Data Rate									
		MCS0	MCS1	MCS2	MCS3	MCS4	MCS5	MCS6	MCS7	MCS8	MCS9
CH 155	5775MHz	19.25	19.20	18.92	19.12	18.98	19.00	18.96	18.83	18.44	18.35



MIMO <Ant. 1+2>

Channel	Frequency	5GHz 802.11a Average Power (dBm)							
		Data Rate							
		6 Mbps	9 Mbps	12 Mbps	18 Mbps	24 Mbps	36 Mbps	48 Mbps	54 Mbps
CH 149	5745 MHz	18.18	18.09	18.06	18.05	18.04	17.40	16.53	16.58
CH 157	5785 MHz	19.45	19.10	19.11	19.27	19.15	16.90	16.09	16.08
CH 165	5825 MHz	18.38	18.36	18.34	18.34	18.32	17.02	16.22	16.23

Channel	Frequency	5GHz 802.11a Peak Power (dBm) (800ns)							
		Data Rate							
		6 Mbps	9 Mbps	12 Mbps	18 Mbps	24 Mbps	36 Mbps	48 Mbps	54 Mbps
CH 149	5745 MHz	22.66	22.65	22.64	22.64	22.64	22.60	22.63	22.63
CH 157	5785 MHz	23.00	22.55	22.46	22.56	22.68	22.76	22.87	22.84
CH 165	5825 MHz	22.44	22.43	22.42	22.41	22.41	22.40	22.39	22.40

Channel	Frequency	5GHz 802.11n HT20 Average Power (dBm)							
		Data Rate							
		MCS8	MCS9	MCS10	MCS11	MCS12	MCS13	MCS14	MCS15
CH 149	5745 MHz	17.92	17.87	17.89	17.69	17.38	16.66	16.58	15.80
CH 157	5785 MHz	17.76	17.62	17.52	17.24	17.02	16.25	16.13	15.03
CH 165	5825 MHz	17.84	17.61	17.62	17.29	17.11	16.38	16.25	15.28

Channel	Frequency	5GHz 802.11n HT20 Peak Power (dBm)							
		Data Rate							
		MCS8	MCS9	MCS10	MCS11	MCS12	MCS13	MCS14	MCS15
CH 149	5745 MHz	23.19	23.05	23.09	23.13	23.12	23.13	23.17	23.16
CH 157	5785 MHz	23.00	22.59	22.69	22.86	22.94	22.95	22.94	22.72
CH 165	5825 MHz	23.00	22.64	22.69	22.89	22.98	22.96	22.95	22.51



Channel	Frequency	5GHz 802.11n HT40 Average Power (dBm)							
		Data Rate							
		MCS8	MCS9	MCS10	MCS11	MCS12	MCS13	MCS14	MCS15
CH 151	5755 MHz	15.51	15.41	15.17	15.27	15.27	15.31	15.24	14.22
CH 159	5795 MHz	17.52	18.48	18.60	18.42	18.66	16.55	16.18	15.74

Channel	Frequency	5GHz 802.11n HT40 Peak Power (dBm)							
		Data Rate							
		MCS8	MCS9	MCS10	MCS11	MCS12	MCS13	MCS14	MCS15
CH 151	5755 MHz	21.99	21.98	21.93	21.98	21.98	21.95	21.92	21.93
CH 159	5795 MHz	22.82	22.73	22.69	22.73	22.73	22.67	22.19	22.21

Channel	Frequency	5GHz 802.11ac VHT20 Average Power (dBm)								
		Data Rate								
		MCS0	MCS1	MCS2	MCS3	MCS4	MCS5	MCS6	MCS7	MCS8
CH 149	5745 MHz	18.02	17.67	17.81	17.41	17.40	16.50	16.49	15.72	14.77
CH 157	5785 MHz	17.69	17.25	17.41	16.94	16.95	16.12	16.09	15.07	14.05
CH 165	5825 MHz	17.81	17.54	17.59	17.12	17.10	16.31	16.23	15.19	14.17

Channel	Frequency	5GHz 802.11ac VHT20 Peak Power (dBm)								
		Data Rate								
		MCS0	MCS1	MCS2	MCS3	MCS4	MCS5	MCS6	MCS7	MCS8
CH 149	5745 MHz	22.65	22.64	22.64	22.64	22.64	22.62	22.63	22.63	22.64
CH 157	5785 MHz	22.84	22.72	22.71	22.80	22.82	22.82	22.80	22.81	22.55
CH 165	5825 MHz	22.93	22.78	22.76	22.88	22.89	22.89	22.91	22.58	22.06



Channel	Frequency	5GHz 802.11ac VHT40 Average Power (dBm)									
		Data Rate									
		MCS0	MCS1	MCS2	MCS3	MCS4	MCS5	MCS6	MCS7	MCS8	MCS9
CH 151	5755 MHz	15.84	15.63	15.60	15.75	15.75	15.21	15.11	14.16	14.21	13.35
CH 159	5795 MHz	17.87	17.84	17.96	16.00	15.87	15.45	15.28	14.33	13.44	12.41

Channel	Frequency	5GHz 802.11ac VHT40 Peak Power (dBm)									
		Data Rate									
		MCS0	MCS1	MCS2	MCS3	MCS4	MCS5	MCS6	MCS7	MCS8	MCS9
CH 151	5755 MHz	22.44	22.35	22.33	22.42	22.38	22.42	22.40	22.19	21.85	22.00
CH 159	5795 MHz	22.74	22.67	22.67	22.72	22.70	22.71	22.38	21.89	21.75	21.56

Channel	Frequency	5GHz 802.11ac VHT80 Average Power (dBm)									
		Data Rate									
		MCS0	MCS1	MCS2	MCS3	MCS4	MCS5	MCS6	MCS7	MCS8	MCS9
CH 155	5775MHz	14.74	14.64	14.44	14.16	14.21	14.18	14.15	13.11	12.25	12.16

Channel	Frequency	5GHz 802.11ac VHT80 Peak Power (dBm)									
		Data Rate									
		MCS0	MCS1	MCS2	MCS3	MCS4	MCS5	MCS6	MCS7	MCS8	MCS9
CH 155	5775MHz	21.59	21.48	21.40	21.30	21.58	21.58	21.42	21.44	21.40	21.34

Note: MIMO Ant. 1+2 is a calculated result from sum of the power MIMO Ant. 1 and MIMO Ant. 2.



2.3 Test Mode

Final test mode of conducted test items and radiated spurious emissions are considering the modulation and worse data rates from the power table described in section 2.2.

Single Antenna

Modulation	Data Rate
802.11a	6 Mbps
802.11n HT20	MCS0
802.11n HT40	MCS0
802.11ac VHT20	MCS0
802.11ac VHT40	MCS0
802.11ac VHT80	MCS0 / MCS1

MIMO Antenna

Modulation	Data Rate
802.11a	6 Mbps
802.11n HT20	MCS8
802.11n HT40	MCS8 / MCS12
802.11ac VHT20	MCS0
802.11ac VHT40	MCS0 / MCS2
802.11ac VHT80	MCS0

Test Cases	
AC Conducted Emission	Mode 1 : GSM850 Idle + Bluetooth Link + WLAN (5GHz) Link + MP3 + Earphone + USB Cable (Charging from Adapter 1)
	Mode 2 : GSM850 Idle + Bluetooth Link + WLAN (5GHz) Link + MP3 + Earphone + USB Cable (Charging from Adapter 2)
	Mode 3 : GSM850 Idle + Bluetooth Link + WLAN (5GHz) Link + MP3 + Earphone + USB Cable (Charging from Adapter 3)
Remark: The worst case of conducted emission is mode 3; only the test data of it was reported.	



Ch. #		Band IV : 5725-5850 MHz		
		802.11a	802.11n HT20	802.11n HT40
L	Low	149	149	151
M	Middle	157	157	-
H	High	165	165	159

Ch. #		Band IV : 5725-5850 MHz		
		802.11ac VHT20	802.11ac VHT40	802.11ac VHT80
L	Low	149	151	-
M	Middle	157	-	155
H	High	165	159	-

2.4 Connection Diagram of Test System

<WLAN Tx Mode>

<for Adapter 1>

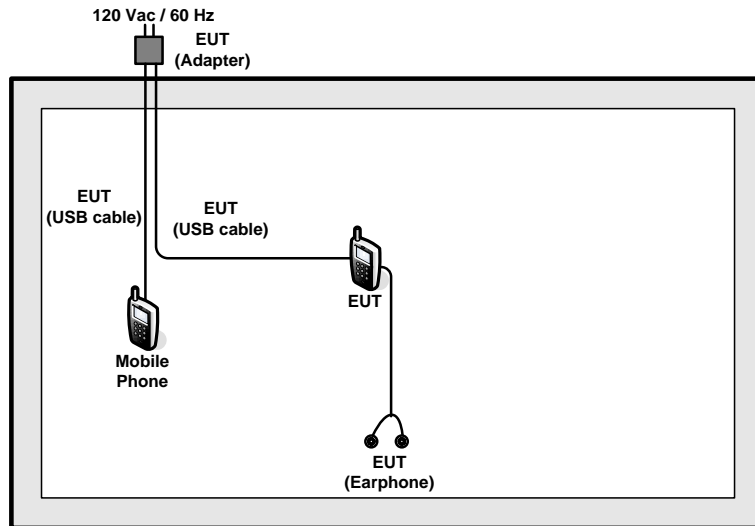

<for Adapter 2>

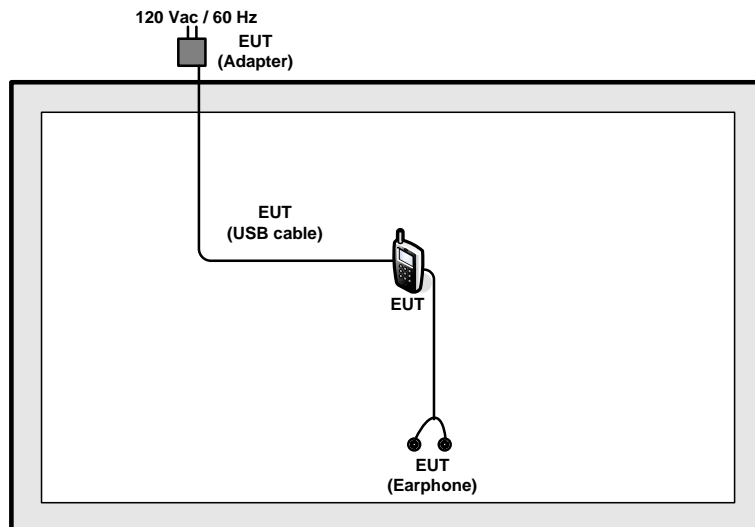

<for Adapter 3>

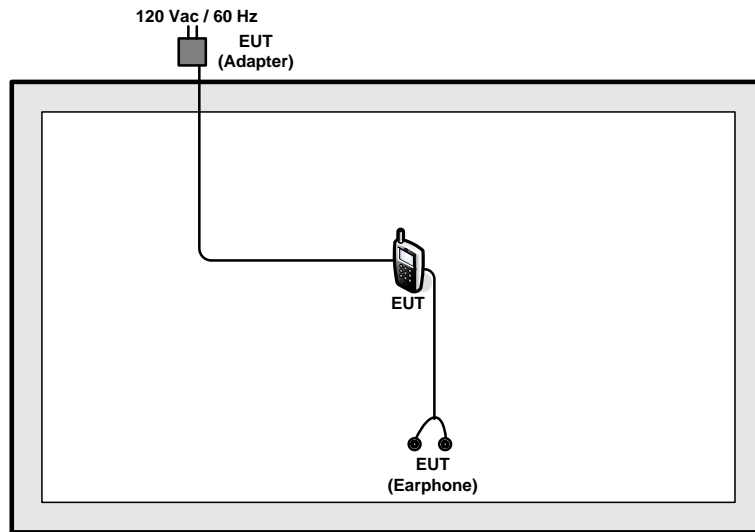

<AC Conducted Emission Mode>

<for Adapter 1>

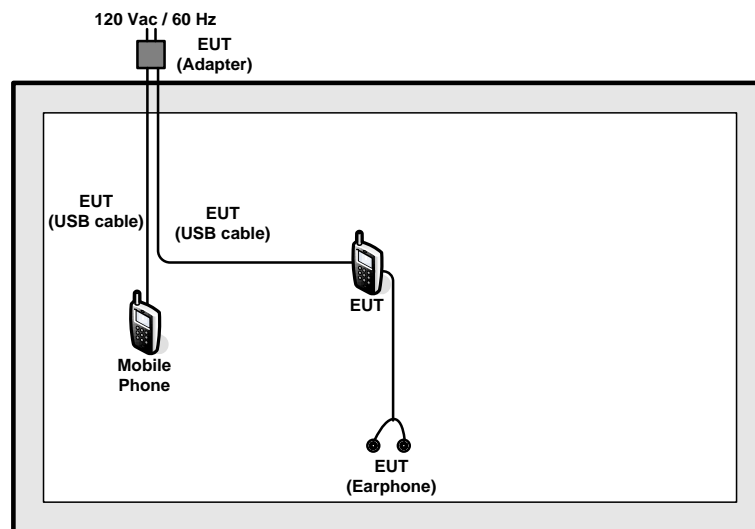

<for Adapter 2>

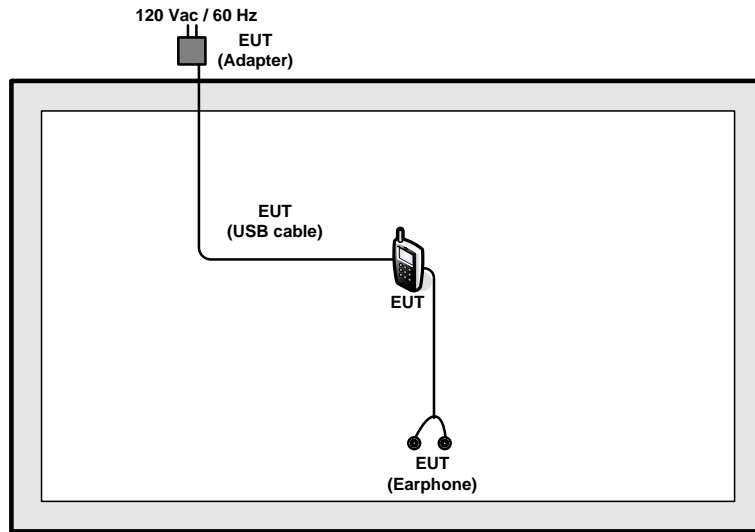

<for Adapter 3>

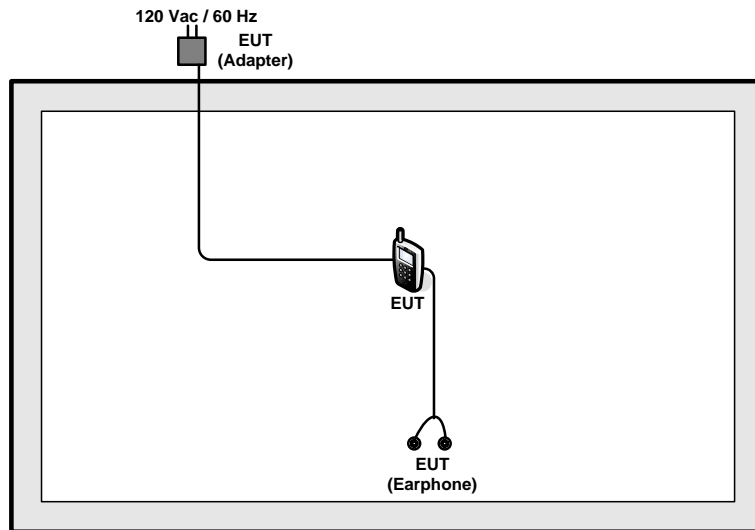



2.5 Support Unit used in test configuration and system

Item	Equipment	Trade Name	Model Name	FCC ID	Data Cable	Power Cord
1.	System Simulator	Anritsu	MT8820C	N/A	N/A	Unshielded, 1.8 m
2.	WLAN AP	D-Link	DIR-865L	KA2IR865LA1	N/A	Unshielded, 1.8 m
3.	Bluetooth Earphone	Sony Ericsson	MW600	PY7DDA-2029	N/A	N/A
4.	Notebook	DELL	Latitude E6320	FCC DoC/ Contains FCC ID: QDS-BRCM1054	N/A	AC I/P: Unshielded, 1.2 m DC O/P: Shielded, 1.8 m
5.	Mobile Phone	Motorola Mobility, LLC	5137	IHDT56UC2	N/A	N/A
6.	SD Card	SanDisk	MicroSD HC	FCC DoC	N/A	N/A

2.6 EUT Operation Test Setup

For WLAN function, programmed RF utility, "QRCT" installed in the EUT provide functions like channel selection and power level for continuous transmitting and receiving signals.

2.7 Measurement Results Explanation Example

For all conducted test items:

The offset level is set in the spectrum analyzer to compensate the RF cable loss and attenuator factor between EUT conducted output port and spectrum analyzer. With the offset compensation, the spectrum analyzer reading level is exactly the EUT RF output level.

Example :

The spectrum analyzer offset is derived from RF cable loss and attenuator factor.

Offset = RF cable loss + attenuator factor.

Following shows an offset computation example with cable loss 4.2 dB and 10dB attenuator.

$$\begin{aligned} \text{Offset(dB)} &= \text{RF cable loss(dB)} + \text{attenuator factor(dB)}. \\ &= 4.2 + 10 = 14.2 \text{ (dB)} \end{aligned}$$

3 Test Result

3.1 6dB Bandwidth Measurement

3.1.1 Description of 6dB Bandwidth

The minimum 6 dB bandwidth shall be at least 500 kHz.

3.1.2 Measuring Instruments

The measuring equipment is listed in the section 4 of this test report.

3.1.3 Test Procedures

1. The testing follows FCC KDB 789033 D02 General UNII Test Procedures New Rules v01. Section C) Emission bandwidth for the band 5.725-5.85GHz
2. Set RBW = 100kHz.
3. Set the VBW $\geq 3 \times$ RBW.
4. Detector = Peak.
5. Trace mode = max hold
6. Measure the maximum width of the emission that is 6 dB down from the peak of the emission.
7. Measure and record the results in the test report.

3.1.4 Test Setup

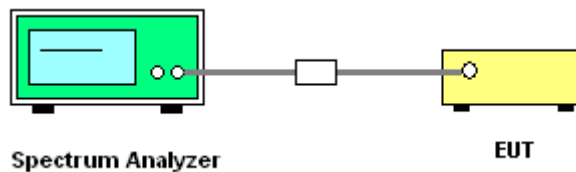



3.1.5 Test Result of 6dB Bandwidth

Please refer to Appendix A.

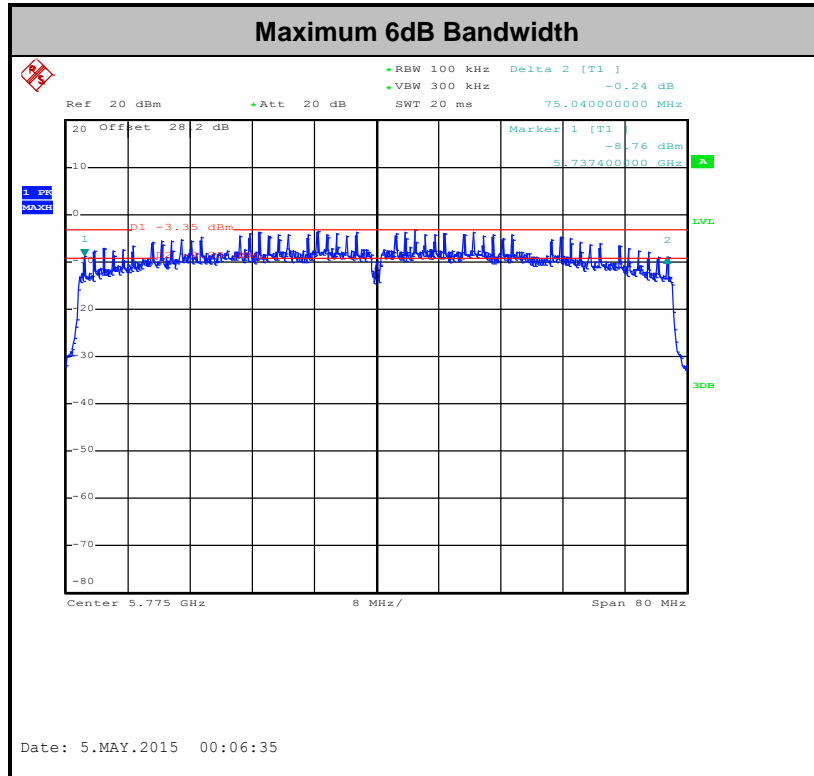

Note: The occupied channel bandwidth is maintained within the band of operation for all of the modulations.

3.2 Maximum Conducted Output Power Measurement

3.2.1 Limit of Maximum Conducted Output Power

<FCC 14-30 CFR 15.407>

For the band 5.725–5.85 GHz, the maximum conducted output power over the frequency band of operation shall not exceed 1 W.

If transmitting antennas of directional gain greater than 6 dBi are used, the peak output power shall be reduced by the amount in dB that the directional gain of the antenna exceeds 6 dBi.

3.2.2 Measuring Instruments

The measuring equipment is listed in the section 4 of this test report.

3.2.3 Test Procedures

The testing follows Method PM of FCC KDB 789033 D02 General UNII Test Procedures New Rules v01.

Method PM (Measurement using an RF average power meter):

1. Measurement is performed using a wideband RF power meter.
2. The EUT is configured to transmit continuously with a consistent duty cycle at its maximum power control level.
3. Measure the average power of the transmitter, and the average power is corrected with duty factor, $10 \log(1/x)$, where x is the duty cycle.

3.2.4 Test Setup

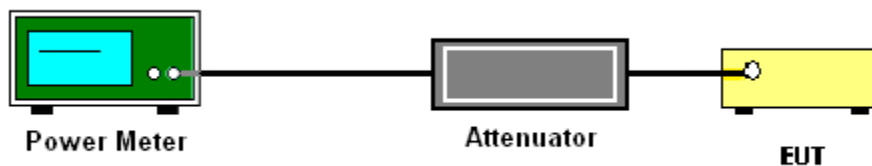

3.2.5 Test Result of Maximum Conducted Output Power

Please refer to Appendix A.



3.3 Power Spectral Density Measurement

3.3.1 Limit of Power Spectral Density

<FCC 14-30 CFR 15.407>

For the band 5.725–5.85 GHz, the maximum power spectral density shall not exceed 30 dBm in any 500-kHz band.

If transmitting antennas of directional gain greater than 6 dBi are used, the peak output power shall be reduced by the amount in dB that the directional gain of the antenna exceeds 6 dBi.

3.3.2 Measuring Instruments

The measuring equipment is listed in the section 4 of this test report.

3.3.3 Test Procedures

The testing follows FCC KDB 789033 D02 General UNII Test Procedures New Rules v01. Section F) Maximum power spectral density.

Method SA-2

(trace averaging across on and off times of the EUT transmissions, followed by duty cycle correction).

1. The testing follows Method SA-2 of FCC KDB 789033 D01 General UNII Test Procedures v01r03.
 - Measure the duty cycle.
 - Set span to encompass the entire emission bandwidth (EBW) of the signal.
 - Set RBW = 300 kHz.
 - Set VBW \geq 1 MHz.
 - Number of points in sweep \geq 2 Span / RBW.
 - Sweep time = auto.
 - Detector = RMS
 - Trace average at least 100 traces in power averaging mode.
 - Add $10 \log(500\text{kHz}/\text{RBW})$ to the test result.
 - Add $10 \log(1/x)$, where x is the duty cycle, to the measured power in order to compute the average power during the actual transmission times. For example, add $10 \log(1/0.25) = 6$ dB if the duty cycle is 25 percent.

2. The RF output of EUT was connected to the spectrum analyzer by a low loss cable.
3. Each plot has already offset with cable loss, and attenuator loss. Measure the PPSD and record it.
4. For **MIMO mode**, calculation method follows FCC KDB 662911 D01 Multiple Transmitter Output v02r01.

Method (1): Measure and sum the spectra across the outputs.

The total final Power Spectral Density is from a device with 2 transmitter outputs. The spectrum measurements of the individual outputs are all performed with the same span and number of points, the spectrum value in the first spectral bin of output 1 is summed with that in the first spectral bin of output 2 to obtain the value for the first frequency bin of the summed spectrum.

3.3.4 Test Setup

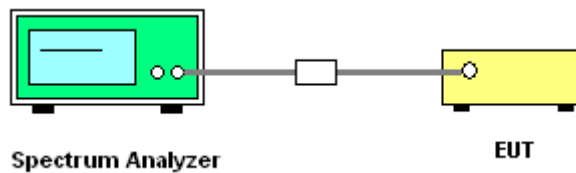



3.3.5 Test Result of Power Spectral Density

Please refer to Appendix A.

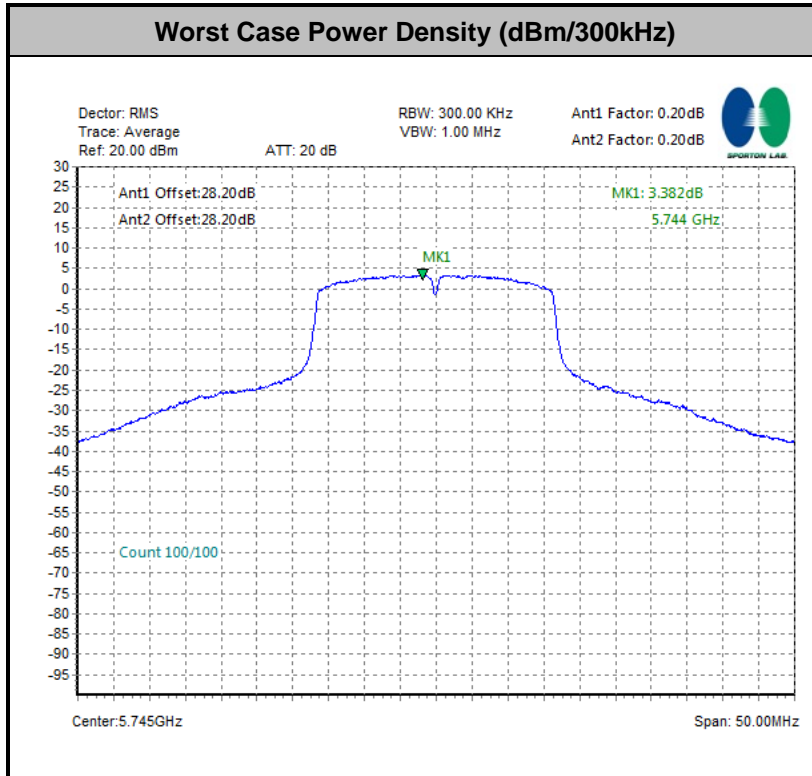



3.4 Unwanted Emissions Measurement

This section as specified in FCC Part 15.407(b) is to measure unwanted emissions through radiated measurement for band edge spurious emissions and out of band emissions measurement. The unwanted emissions shall comply with 15.407(b)(1) to (6), and restricted bands per FCC Part15.205.

3.4.1 Limit of Unwanted Emissions

- (1) For transmitters operating in the 5725-5850 MHz band: all emissions within the frequency range from the band edge to 10 MHz above or below the band edge shall not exceed an EIRP of -17 dBm/MHz (78.3dBμV/m); for frequencies 10 MHz or greater above or below the band edge, emissions shall not exceed an EIRP of -27 dBm/MHz (68.3dBμV/m).
- (2) Unwanted spurious emissions fallen in restricted bands per FCC Part15.205 shall comply with the general field strength limits set forth in § 15.209 as below table,

Frequency (MHz)	Field Strength (microvolts/meter)	Measurement Distance (meters)
0.009 – 0.490	2400/F(kHz)	300
0.490 – 1.705	24000/F(kHz)	30
1.705 – 30.0	30	30
30 – 88	100	3
88 – 216	150	3
216 - 960	200	3
Above 960	500	3

Note: The following formula is used to convert the EIRP to field strength.

$$E = \frac{1000000\sqrt{30P}}{3} \mu\text{V/m, where P is the eirp (Watts)}$$

EIRP (dBm)	Field Strength at 3m (dBμV/m)
-17	78.3
- 27	68.3

- (3) KDB789033 v01r03 H)2)c)(i) As specified in 15.407(b), emissions above 1000 MHz that are outside of the restricted bands are subject to a peak emission limit of -27 dBm/MHz (or -17 dBm/MHz as specified in 15.407(b)(4)). However, an out-of-band emission that complies with both the average and peak limits of 15.209 is not required to satisfy the -27 dBm/MHz or -17 dBm/MHz peak emission limit.



3.4.2 Measuring Instruments

The measuring equipment is listed in the section 4 of this test report.

3.4.3 Test Procedures

1. The testing follows FCC KDB 789033 D02 General UNII Test Procedures New Rules v01. Section G) Unwanted emissions measurement.

(1) Procedure for Unwanted Emissions Measurements Below 1000MHz

- RBW = 120 kHz
- VBW = 300 kHz
- Detector = Peak
- Trace mode = max hold

(2) Procedure for Peak Unwanted Emissions Measurements Above 1000 MHz

- RBW = 1 MHz
- VBW \geq 3 MHz
- Detector = Peak
- Sweep time = auto
- Trace mode = max hold

(3) Procedures for Average Unwanted Emissions Measurements Above 1000MHz

- RBW = 1 MHz
- VBW = 10 Hz, when duty cycle is no less than 98 percent.
- VBW \geq 1/T, when duty cycle is less than 98 percent where T is the minimum transmission duration over which the transmitter is on and is transmitting at its maximum power control level for the tested mode of operation.



Antenna	Band	Duty Cycle(%)	T(us)	1/T(kHz)	VBW Setting
1	802.11a	95.39	2070	0.483091787	1kHz
1	5GHz 802.11n HT20	95.54	1930	0.518134715	1kHz
1	5GHz 802.11n HT40	90.48	950	1.052631579	3kHz
2	802.11a	95.37	2060	0.485436893	1kHz
2	5GHz 802.11n HT20	94.61	1930	0.518134715	1kHz
2	5GHz 802.11n HT40	90.48	950	1.052631579	3kHz
1+2	5GHz 802.11a for Ant 1	95.39	2070	0.483091787	1kHz
1+2	5GHz 802.11a for Ant 2	95.39	2070	0.483091787	1kHz
1+2	5GHz 802.11n HT20 for Ant 1	90.83	990	1.01010101	3kHz
1+2	5GHz 802.11n HT20 for Ant 2	90.83	990	1.01010101	3kHz
1+2	5GHz 802.11n HT40 for Ant 1	83.22	496	2.016129032	3kHz
1+2	5GHz 802.11n HT40 for Ant 2	83.89	500	2	3kHz
1	5GHz 802.11ac VHT20	94.61	1930	0.518134715	1kHz
1	5GHz 802.11ac VHT40	90.57	960	1.041666667	3kHz
1	5GHz 802.11ac VHT80	82.27	464	2.155172414	3kHz
2	5GHz 802.11ac VHT20	95.07	1930	0.518134715	1kHz
2	5GHz 802.11ac VHT40	90.48	950	1.052631579	3kHz
2	5GHz 802.11ac VHT80	82.98	468	2.136752137	3kHz
1+2	5GHz 802.11ac VHT20 for Ant 1	94.61	1930	0.518134715	1kHz
1+2	5GHz 802.11ac VHT20 for Ant 2	95.57	1940	0.515463918	1kHz
1+2	5GHz 802.11ac VHT40 for Ant 1	90.48	950	1.052631579	3kHz
1+2	5GHz 802.11ac VHT40 for Ant 2	90.48	950	1.052631579	3kHz
1+2	5GHz 802.11ac VHT80 for Ant 1	82.98	468	2.136752137	3kHz
1+2	5GHz 802.11ac VHT80 for Ant 2	82.27	464	2.155172414	3kHz



2. The EUT was placed on a turntable with 0.8 meter for frequency below 1GHz and 1.5 meter for frequency above 1GHz respectively above ground.
3. The EUT was set 3 meters from the interference receiving antenna which was mounted on the top of a variable height antenna tower.
4. The antenna is a broadband antenna and its height is adjusted between one meter and four meters above ground to find the maximum value of the field strength for both horizontal polarization and vertical polarization of the antenna.
5. For each suspected emission, the EUT was arranged to its worst case and then adjust the antenna tower (from 1 m to 4 m) and turntable (from 0 degree to 360 degrees) to find the maximum reading.
6. For testing below 1GHz, if the emission level of the EUT in peak mode was 3 dB lower than the limit specified, then peak values of EUT will be reported, otherwise, the emissions will be repeated one by one using the CISPR quasi-peak method and reported.
7. For testing above 1GHz, the emission level of the EUT in peak mode was 20dB lower than average limit (that means the emission level in average mode also complies with the limit in average mode), then peak values of EUT will be reported, otherwise, the emissions will be measured in average mode again and reported.

3.4.4 Test Setup

For radiated emissions below 30MHz

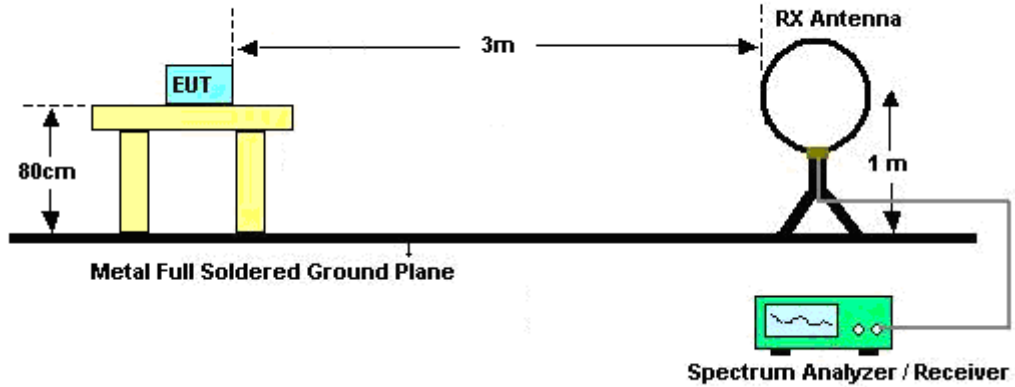

For radiated emissions from 30MHz to 1GHz

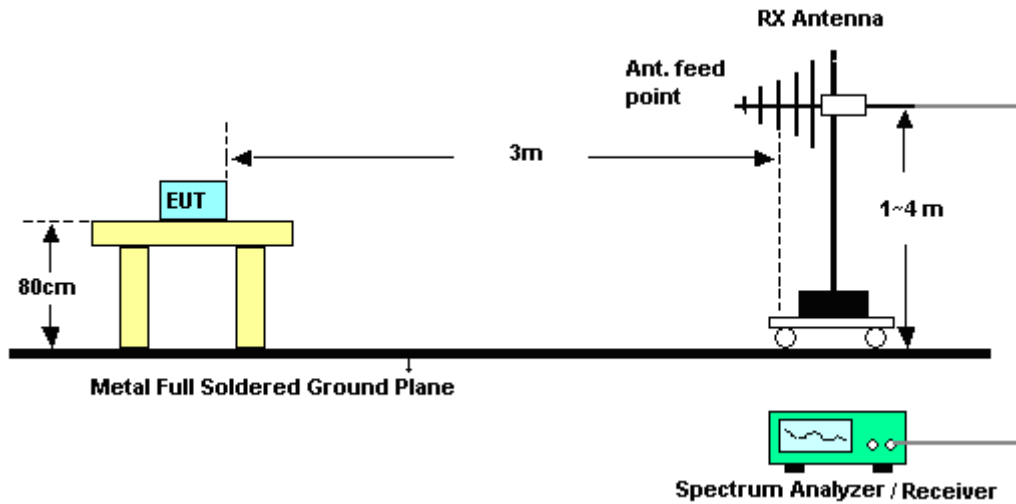

For radiated emissions above 1GHz

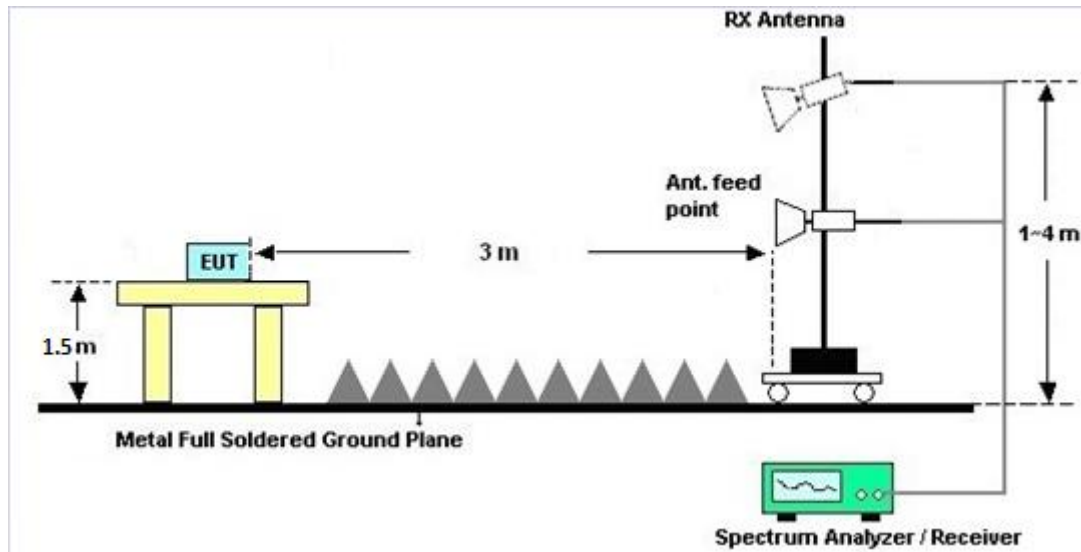

3.4.5 Test Results of Radiated Emissions (9 kHz ~ 30 MHz)

The low frequency, which started from 9 kHz to 30MHz, was pre-scanned and the result which was 20dB lower than the limit line per 15.31(o) was not reported.

3.4.6 Test Result of Radiated Band Edges

Please refer to Appendix A.

3.4.7 Test Result of Unwanted Radiated Emission (30MHz ~ 10th Harmonic)

Please refer to Appendix A.



3.5 AC Conducted Emission Measurement

3.5.1 Limit of AC Conducted Emission

For equipment that is designed to be connected to the public utility (AC) power line, the radio frequency voltage that is conducted back onto the AC power line on any frequency or frequencies within the band 150 kHz to 30 MHz shall not exceed the limits in the following table.

Frequency of emission (MHz)	Conducted limit (dB μ V)	
	Quasi-peak	Average
0.15-0.5	66 to 56*	56 to 46*
0.5-5	56	46
5-30	60	50

*Decreases with the logarithm of the frequency.

3.5.2 Measuring Instruments

The measuring equipment is listed in the section 4 of this test report.

3.5.3 Test Procedures

1. The EUT was placed 0.4 meter from the conducting wall of the shielding room was kept at least 80 centimeters from any other grounded conducting surface.
2. Connect EUT to the power mains through a line impedance stabilization network (LISN).
3. All the support units are connecting to the other LISN.
4. The LISN provides 50 ohm coupling impedance for the measuring instrument.
5. The FCC states that a 50 ohm, 50 microhenry LISN should be used.
6. Both sides of AC line were checked for maximum conducted interference.
7. The frequency range from 150 kHz to 30 MHz was searched.
8. Set the test-receiver system to Peak Detect Function and specified bandwidth with Maximum Hold Mode.

3.5.4 Test Setup

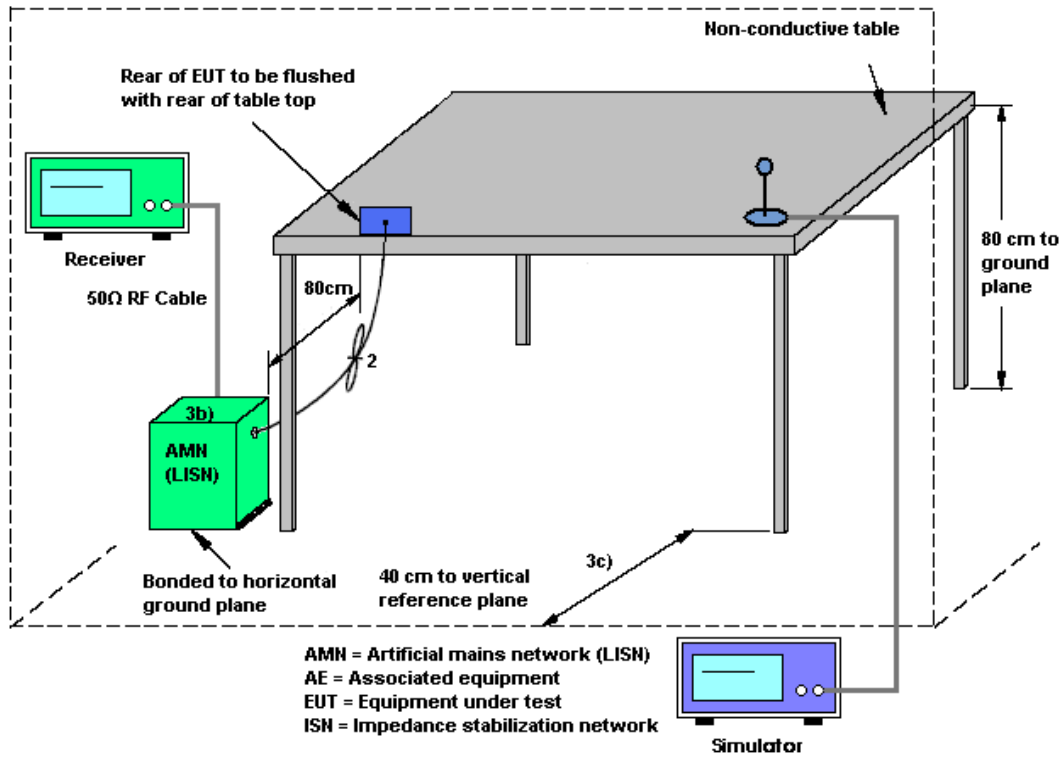



3.5.5 Test Result of AC Conducted Emission

Test Mode :	Mode 3	Temperature :	22~24°C
Test Engineer :	Eric Jeng	Relative Humidity :	49~51%
Test Voltage :	120Vac / 60Hz	Phase :	Line
Function Type :	GSM850 Idle + Bluetooth Link + WLAN (5GHz) Link + MP3 + Earphone + USB Cable (Charging from Adapter 3)		

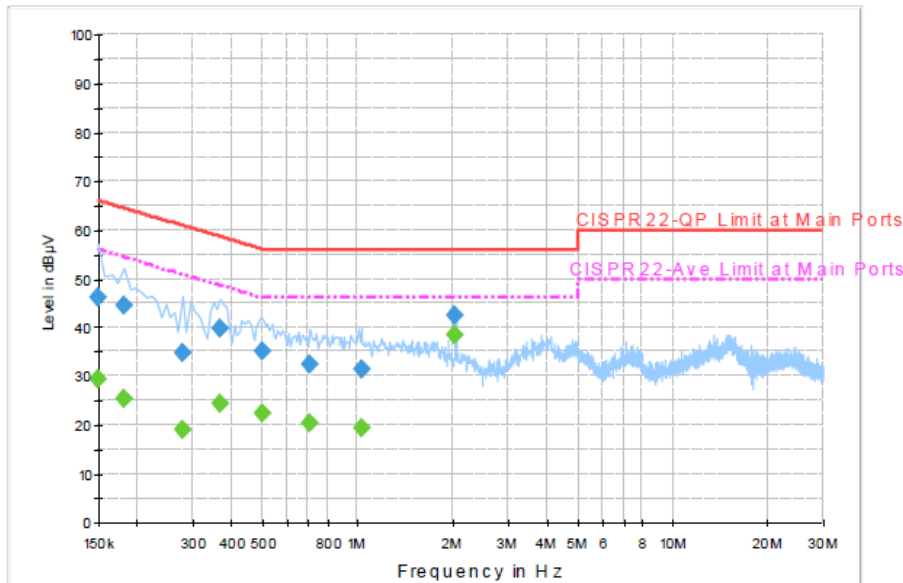

Final Result : QuasiPeak

Frequency (MHz)	QuasiPeak (dBµV)	Filter	Line	Corr. (dB)	Margin (dB)	Limit (dBµV)
0.150000	46.1	Off	L1	19.5	19.9	66.0
0.182000	44.6	Off	L1	19.5	19.8	64.4
0.278000	34.9	Off	L1	19.4	26.0	60.9
0.366000	39.8	Off	L1	19.5	18.8	58.6
0.502000	35.3	Off	L1	19.5	20.7	56.0
0.702000	32.4	Off	L1	19.6	23.6	56.0
1.030000	31.5	Off	L1	19.5	24.5	56.0
2.046000	42.5	Off	L1	19.7	13.5	56.0

Final Result : Average

Frequency (MHz)	Average (dBµV)	Filter	Line	Corr. (dB)	Margin (dB)	Limit (dBµV)
0.150000	29.4	Off	L1	19.5	26.6	56.0
0.182000	25.4	Off	L1	19.5	29.0	54.4
0.278000	19.1	Off	L1	19.4	31.8	50.9
0.366000	24.3	Off	L1	19.5	24.3	48.6
0.502000	22.4	Off	L1	19.5	23.6	46.0
0.702000	20.4	Off	L1	19.6	25.6	46.0
1.030000	19.4	Off	L1	19.5	26.6	46.0
2.046000	38.5	Off	L1	19.7	7.5	46.0



Test Mode :	Mode 3	Temperature :	22~24°C
Test Engineer :	Eric Jeng	Relative Humidity :	49~51%
Test Voltage :	120Vac / 60Hz	Phase :	Neutral
Function Type :	GSM850 Idle + Bluetooth Link + WLAN (5GHz) Link + MP3 + Earphone + USB Cable (Charging from Adapter 3)		

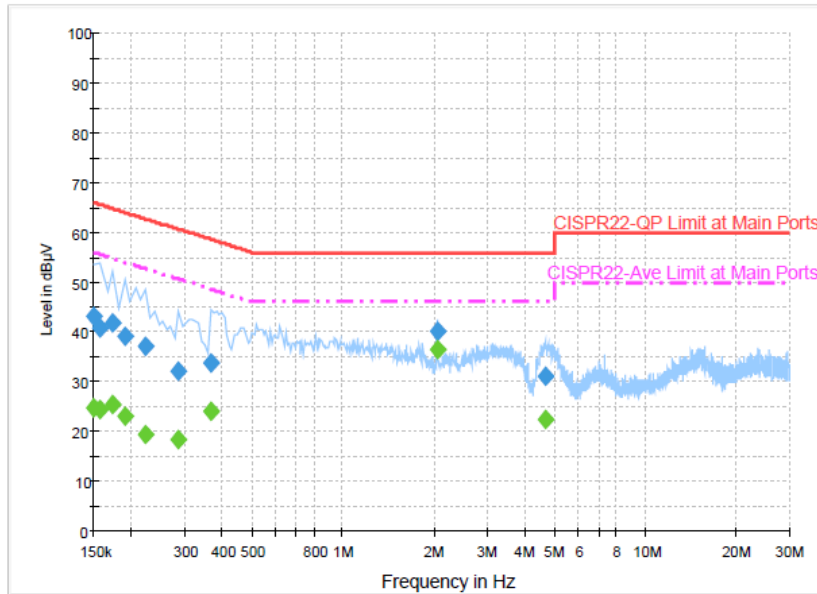

Final Result : QuasiPeak

Frequency (MHz)	QuasiPeak (dBµV)	Filter	Line	Corr. (dB)	Margin (dB)	Limit (dBµV)
0.150000	43.1	Off	N	19.5	22.9	66.0
0.158000	40.7	Off	N	19.4	24.9	65.6
0.174000	41.9	Off	N	19.4	22.9	64.8
0.190000	39.3	Off	N	19.5	24.7	64.0
0.222000	37.0	Off	N	19.4	25.7	62.7
0.286000	32.1	Off	N	19.4	28.5	60.6
0.366000	33.7	Off	N	19.5	24.9	58.6
2.054000	40.1	Off	N	19.7	15.9	56.0
4.702000	31.1	Off	N	19.7	24.9	56.0

Final Result : Average

Frequency (MHz)	Average (dBµV)	Filter	Line	Corr. (dB)	Margin (dB)	Limit (dBµV)
0.150000	24.8	Off	N	19.5	31.2	56.0
0.158000	24.5	Off	N	19.4	31.1	55.6
0.174000	25.4	Off	N	19.4	29.4	54.8
0.190000	23.0	Off	N	19.5	31.0	54.0
0.222000	19.5	Off	N	19.4	33.2	52.7
0.286000	18.4	Off	N	19.4	32.2	50.6
0.366000	24.1	Off	N	19.5	24.5	48.6
2.054000	36.4	Off	N	19.7	9.6	46.0
4.702000	22.4	Off	N	19.7	23.6	46.0

3.6 Frequency Stability Measurement

3.6.1 Limit of Frequency Stability

Manufacturers of U-NII devices are responsible for ensuring frequency stability such that an emission is maintained within the band of operation under all conditions of normal operation as specified in the user's manual.

3.6.2 Measuring Instruments

The measuring equipment is listed in the section 4 of this test report.

3.6.3 Test Procedures

1. To ensure emission at the band edge is maintained within the authorized band, those values shall be measured by radiation emissions at upper and lower frequency points, and finally compensated by frequency deviation as procedures below.
2. The EUT was operated at the maximum output power, and connected to the spectrum analyzer, which is set to maximum hold function and peak detector. The peak value of the power envelope was measured and noted. The upper and lower frequency points were respectively measured relatively 10dB lower than the measured peak value.
3. The frequency deviation was calculated by adding the upper frequency point and the lower frequency point divided by two. Those detailed values of frequency deviation are provided in table below.

3.6.4 Test Setup

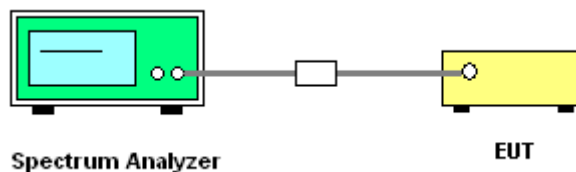

3.6.5 Test Result of Frequency Stability

Please refer to Appendix A.



3.7 Automatically Discontinue Transmission

3.7.1 Limit of Automatically Discontinue Transmission

The device shall automatically discontinue transmission in case of either absence of information to transmit or operational failure. These provisions are not intended to preclude the transmission of control or signaling information or the use of repetitive codes used by certain digital technologies to complete frame or burst intervals. Applicants shall include in their application for equipment authorization to describe how this requirement is met.

3.7.2 Measuring Instruments

The measuring equipment is listed in the section 4 of this test report.

3.7.3 Test Result of Automatically Discontinue Transmission

While the EUT is not transmitting any information, the EUT can automatically discontinue transmission and become standby mode for power saving. The EUT can detect the controlling signal of ACK message transmitting from remote device and verify whether it shall resend or discontinue transmission.



3.8 Antenna Requirements

3.8.1 Standard Applicable

According to FCC 47 CFR Section 15.407(a)(1)(2) ,if transmitting antenna directional gain is greater than 6 dBi, both the peak transmit power and the peak power spectral density shall be reduced by the amount in dB that the directional gain of the antenna exceeds 6 dBi.

3.8.2 Antenna Anti-Replacement Construction

An embedded-in antenna design is used.

3.8.3 Antenna Gain

FCC KDB 662911 D01 Multiple Transmitter Output v02r01

For CDD transmissions, directional gain is calculated as

Directional gain = G_{ANT} + Array Gain, where Array Gain is as follows.

For power spectral density (PSD) measurements on all devices,

Array Gain = $10 \log(N_{ANT}/N_{SS}=1)$ dB.

For power measurements on IEEE 802.11 devices,

Array Gain = 0 dB (i.e., no array gain) for $N_{ANT} \leq 4$.

The EUT supports CDD mode.

The power and PSD limit should be modified if the directional gain of EUT is over 6 dBi,

The directional gain “DG” is calculated as following table.

			DG	DG	Power	PSD
			for	for	Limit	Limit
	Ant 1	Ant 2	Power	PSD	Reduction	Reduction
	(dBi)	(dBi)	(dBi)	(dBi)	(dB)	(dB)
Band IV	0.50	0.50	0.50	3.51	0.00	0.00

Power limit reduction = Composite gain – 6dBi, (min = 0)

PSD limit reduction = Composite gain + PSD Array gain – 6dBi, (min = 0)



4 List of Measuring Equipment

Instrument	Manufacturer	Model No.	Serial No.	Characteristics	Calibration Date	Test Date	Due Date	Remark
Power Meter	Anritsu	ML2495A	1036004	300MHz~40GHz	Aug. 09, 2014	Apr. 21, 2015 ~ May 19, 2015	Aug. 08, 2015	Conducted (TH02-HY)
Power Sensor	Anritsu	MA2411B	1027253	300MHz~40GHz	Aug. 11, 2014	Apr. 21, 2015 ~ May 19, 2015	Aug. 10, 2015	Conducted (TH02-HY)
Spectrum Analyzer	Rohde & Schwarz	FSP40	100055	9kHz~40GHz	Jun. 09, 2014	Apr. 21, 2015 ~ May 19, 2015	Jun. 08, 2015	Conducted (TH02-HY)
Bilog Antenna	Schaffner	CBL6111C	2726	30MHz ~ 1GHz	Sep. 27, 2014	Apr. 27, 2015 ~ May 15, 2015	Sep. 26, 2015	Radiation (03CH07-HY)
Double Ridge Horn Antenna	ESCO	3117	00075962	1GHz ~ 18GHz	Aug. 19, 2014	Apr. 27, 2015 ~ May 15, 2015	Aug. 18, 2015	Radiation (03CH07-HY)
EMI Test Receiver	Rohde & Schwarz	ESCI 7	100724	9kHz~7GHz	Aug. 30, 2014	Apr. 27, 2015 ~ May 15, 2015	Aug. 29, 2015	Radiation (03CH07-HY)
Horn Antenna	SCHWARZBECK	BBHA 9170	BBHA9170584	18GHz- 40GHz	Nov. 03, 2014	Apr. 27, 2015 ~ May 15, 2015	Nov. 02, 2015	Radiation (03CH07-HY)
Loop Antenna	Rohde & Schwarz	HFH2-Z2	100315	9 kHz~30 MHz	Jul. 28, 2014	Apr. 27, 2015 ~ May 15, 2015	Jul. 27, 2015	Radiation (03CH07-HY)
Preamplifier	MITEQ	AMF-7D-0010 1800-30-10P	1590075	1GHz ~ 18GHz	Apr. 20, 2015	Apr. 27, 2015 ~ May 15, 2015	Apr. 19, 2016	Radiation (03CH07-HY)
Preamplifier	COM-POWER	PA-103A	161241	10MHz-1000MHz	Mar. 12, 2015	Apr. 27, 2015 ~ May 15, 2015	Mar. 11, 2016	Radiation (03CH07-HY)
Preamplifier	Agilent	8449B	3008A02362	1GHz~ 26.5GHz	Oct. 21, 2014	Apr. 27, 2015 ~ May 15, 2015	Oct. 20, 2015	Radiation (03CH07-HY)
Signal Analyzer	Rohde & Schwarz	FSV 30	101749	10Hz~30GHz	Mar. 10, 2015	Apr. 27, 2015 ~ May 15, 2015	Mar. 09, 2016	Radiation (03CH07-HY)
Antenna Mast	Max-Full	MFA520BS	N/A	1m~4m	N/A	Apr. 27, 2015 ~ May 15, 2015	N/A	Radiation (03CH07-HY)
Turn Table	ChainTek	Chaintek 3000	N/A	0~360 degree	N/A	Apr. 27, 2015 ~ May 15, 2015	N/A	Radiation (03CH07-HY)
Preamplifier	MITEQ	JS44-1800400 0-33-8P	1840917	18GHz ~ 40GHz	Jun. 09, 2014	Apr. 27, 2015 ~ May 15, 2015	Jun. 08, 2015	Radiation (03CH07-HY)
EMI Test Receiver	Rohde & Schwarz	ESCS 30	100356	9kHz ~ 2.75GHz	Dec. 01, 2014	Apr. 21, 2015 ~ May 17, 2015	Nov. 30, 2015	Conduction (CO05-HY)
LISN (for auxiliary equipment)	Rohde & Schwarz	ENV216	100081	9kHz ~ 30MHz	Dec. 08, 2014	Apr. 21, 2015 ~ May 17, 2015	Dec. 07, 2015	Conduction (CO05-HY)
LISN	Rohde & Schwarz	ENV216	100080	9kHz~30MHz	Dec. 02, 2014	Apr. 21, 2015 ~ May 17, 2015	Dec. 01, 2015	Conduction (CO05-HY)
AC Power Source	ChainTek	APC-1000W	N/A	N/A	N/A	Apr. 21, 2015 ~ May 17, 2015	N/A	Conduction (CO05-HY)



5 Uncertainty of Evaluation

Uncertainty of Conducted Emission Measurement (150kHz ~ 30MHz)

Measuring Uncertainty for a Level of Confidence of 95% ($U = 2Uc(y)$)	2.26
---	------

Uncertainty of Radiated Emission Measurement (30 MHz ~ 1000 MHz)

Measuring Uncertainty for a Level of Confidence of 95% ($U = 2Uc(y)$)	4.50
---	------



Appendix A. Conducted Test Results

Test Engineer:	Derek Hsu	Temperature:	24~26	°C
Test Date:	2015/04/21 ~ 2015/05/19	Relative Humidity:	45~49	%

TEST RESULTS DATA
6dB and 99% OBW

FCC Band IV									
Mod.	Data Rate	NTX	CH.	Freq. (MHz)	6 dB Bandwidth (MHz)		FCC 6 dB Bandwidth Min. Limit (MHz)		Pass/Fail
					Ant 1	Ant 2	Ant 1	Ant 2	
11a	6Mbps	2	149	5745	15.12	15.08	0.5		Pass
11a	6Mbps	2	157	5785	15.12	15.12	0.5		Pass
11a	6Mbps	2	165	5825	15.12	15.12	0.5		Pass
HT20	MCS8	2	149	5745	15.10	15.12	0.5		Pass
HT20	MCS8	2	157	5785	15.12	15.12	0.5		Pass
HT20	MCS8	2	165	5825	15.12	15.12	0.5		Pass
HT40	MCS8	2	151	5755	35.04	35.04	0.5		Pass
HT40	MCS12	2	159	5795	36.48	36.48	0.5		Pass
VHT20	MCS0	2	149	5745	15.12	15.12	0.5		Pass
VHT20	MCS0	2	157	5785	15.12	15.12	0.5		Pass
VHT20	MCS0	2	165	5825	15.12	15.12	0.5		Pass
VHT40	MCS0	2	151	5755	35.04	35.04	0.5		Pass
VHT40	MCS2	2	159	5795	35.12	35.12	0.5		Pass
VHT80	MCS0	2	155	5775	75.04	75.04	0.5		Pass

TEST RESULTS DATA
Average Power Table

FCC Band IV														
Mod.	Data Rate	NTX	CH.	Freq. (MHz)	Duty Factor (dB)		Average Conducted Power (dBm)			FCC Conducted Power Limit (dBm)		DG (dBi)		Pass/Fail
					Ant 1	Ant 2	Ant 1	Ant 2	SUM	Ant 1	Ant 2	Ant 1	Ant 2	
11a	6Mbps	2	149	5745	0.20	0.20	14.90	15.42	18.18	30.00		0.50		Pass
11a	6Mbps	2	157	5785	0.20	0.20	16.16	16.69	19.45	30.00		0.50		Pass
11a	6Mbps	2	165	5825	0.20	0.20	14.64	15.98	18.38	30.00		0.50		Pass
HT20	MCS8	2	149	5745	0.42	0.42	14.73	15.08	17.92	30.00		0.50		Pass
HT20	MCS8	2	157	5785	0.42	0.42	14.56	14.94	17.76	30.00		0.50		Pass
HT20	MCS8	2	165	5825	0.42	0.42	14.68	14.98	17.84	30.00		0.50		Pass
HT40	MCS8	2	151	5755	0.80	0.76	12.40	12.59	15.51	30.00		0.50		Pass
HT40	MCS12	2	159	5795	0.80	0.76	14.33	14.69	18.66	30.00		0.50		Pass
VHT20	MCS0	2	149	5745	0.24	0.20	14.72	15.28	18.02	30.00		0.50		Pass
VHT20	MCS0	2	157	5785	0.24	0.20	14.45	14.91	17.69	30.00		0.50		Pass
VHT20	MCS0	2	165	5825	0.24	0.20	14.67	14.93	17.81	30.00		0.50		Pass
VHT40	MCS0	2	151	5755	0.43	0.43	12.45	13.17	15.84	30.00		0.50		Pass
VHT40	MCS2	2	159	5795	1.11	1.06	14.09	15.66	17.96	30.00		0.50		Pass
VHT80	MCS0	2	155	5775	0.81	0.85	11.45	11.99	14.74	30.00		0.50		Pass

TEST RESULTS DATA
Power Spectral Density

FCC Band IV																
Mod.	Data Rate	NTX	CH.	Freq. (MHz)	Duty Factor (dB)		10log (500kHz /RBW) Factor (dB)		Average Power Density (dBm/500kHz)			Average PSD Limit (dBm/500kHz)		DG (dBi)		Pass /Fail
					Ant 1	Ant 2	Ant 1	Ant 2	Ant 1	Ant 2	SUM	Ant 1	Ant 2	Ant 1	Ant 2	
11a	6Mbps	2	149	5745	0.20	0.20	2.22				5.60	30.00	3.51		Pass	
11a	6Mbps	2	157	5785	0.20	0.20	2.22				5.05	30.00	3.51		Pass	
11a	6Mbps	2	165	5825	0.20	0.20	2.22				4.94	30.00	3.51		Pass	
HT20	MCS8	2	149	5745	0.42	0.42	2.22				3.47	30.00	3.51		Pass	
HT20	MCS8	2	157	5785	0.42	0.42	2.22				3.29	30.00	3.51		Pass	
HT20	MCS8	2	165	5825	0.42	0.42	2.22				2.92	30.00	3.51		Pass	
HT40	MCS8	2	151	5755	0.80	0.76	2.22				-1.08	30.00	3.51		Pass	
HT40	MCS12	2	159	5795	0.80	0.76	2.22				-0.55	30.00	3.51		Pass	
VHT20	MCS0	2	149	5745	0.24	0.20	2.22				3.60	30.00	3.51		Pass	
VHT20	MCS0	2	157	5785	0.24	0.20	2.22				3.64	30.00	3.51		Pass	
VHT20	MCS0	2	165	5825	0.24	0.20	2.22				3.85	30.00	3.51		Pass	
VHT40	MCS0	2	151	5755	0.43	0.43	2.22				-0.62	30.00	3.51		Pass	
VHT40	MCS2	2	159	5795	0.43	0.43	2.22				0.12	30.00	3.51		Pass	
VHT80	MCS0	2	155	5775	0.81	0.85	2.22				0.06	30.00	3.51		Pass	

TEST RESULTS DATA
Frequency Stability

Band IV										
Mod.	Data Rate	NTX	CH.	Freq. (MHz)	Center Frequency (MHz)	Frequency Deviation (MHz)	Frequency Stability (ppm)	Temperature (°C)	Voltage (V)	Note
11a	6Mbps	1	149	5745	5744.950	-0.050	-8.70	20	3.4	
11a	6Mbps	1	149	5745	5744.950	-0.050	-8.70	20	4.35	
11a	6Mbps	1	149	5745	5744.950	-0.050	-8.70	20	3.9	
11a	6Mbps	1	149	5745	5745.050	0.050	8.70	-30	3.9	
11a	6Mbps	1	149	5745	5744.950	-0.050	-8.70	55	3.9	



Appendix B. Radiated Spurious Emission

Test Engineer :	Nick Yu, Ken Wu, and James Chiu	Temperature :	21~23°C
		Relative Humidity :	60~63%

15E Band 4 - 5725~5850MHz

WIFI 802.11a (Band Edge @ 3m)(with adapter1)

WIFI	Note	Frequency	Level	Over	Limit	Read	Antenna	Cable	Preamp	Ant	Table	Peak	Pol.	
Ant.				Limit	Line	Level	Factor	Loss	Factor	Pos	Pos	Avg.		
1+2		(MHz)	(dBμV/m)	(dB)	(dBμV/m)	(dBμV)	(dB/m)	(dB)	(dB)	(cm)	(deg)	(P/A)	(H/V)	
802.11a CH 149 5745MHz		5708.68	70.66	-3.34	74	57.33	35.22	12.26	34.15	129	315	P	H	
		5724.76	75.66	-2.64	78.3	62.32	35.23	12.26	34.15	129	315	P	H	
		5714.84	51.55	-2.45	54	38.22	35.22	12.26	34.15	129	315	A	H	
	*	5745	106.65	-	-	93.25	35.24	12.33	34.17	129	315	P	H	
	*	5745	97.19	-	-	83.79	35.24	12.33	34.17	129	315	A	H	
														H
														H
														H
			5714.28	67.61	-6.39	74	54.28	35.22	12.26	34.15	302	114	P	V
			5722.84	71.94	-6.36	78.3	58.6	35.23	12.26	34.15	302	114	P	V
			5714.76	48.81	-5.19	54	35.48	35.22	12.26	34.15	302	114	A	V
	*		5743	104.68	-	-	91.28	35.24	12.33	34.17	302	114	P	V
	*		5743	95.05	-	-	81.65	35.24	12.33	34.17	302	114	A	V
														V
														V
													V	



WIFI	Note	Frequency	Level	Over	Limit	Read	Antenna	Cable	Preamp	Ant	Table	Peak	Pol.
Ant.				Limit	Line	Level	Factor	Loss	Factor	Pos	Pos	Avg.	
1+2		(MHz)	(dBμV/m)	(dB)	(dBμV/m)	(dBμV)	(dB/m)	(dB)	(dB)	(cm)	(deg)	(P/A)	(H/V)
802.11a CH 157 5785MHz		5714.6	58.47	-15.53	74	45.14	35.22	12.26	34.15	104	317	P	H
		5715.08	60.24	-18.06	78.3	46.91	35.22	12.26	34.15	104	317	P	H
		5712.44	44.31	-9.69	54	30.98	35.22	12.26	34.15	104	317	A	H
	*	5783	107.47	-	-	94.03	35.27	12.4	34.23	104	317	P	H
	*	5783	98.16	-	-	84.72	35.27	12.4	34.23	104	317	A	H
		5850.08	59.23	-19.07	78.3	45.78	35.31	12.45	34.31	104	317	P	H
		5861.68	58.35	-15.65	74	44.89	35.32	12.49	34.35	104	317	P	H
		5860.96	44.6	-9.4	54	31.14	35.32	12.49	34.35	104	317	A	H
		5693.8	57.35	-16.65	74	44.08	35.21	12.18	34.12	393	93	P	V
		5722.52	57.37	-20.93	78.3	44.03	35.23	12.26	34.15	393	93	P	V
		5713.48	44.12	-9.88	54	30.79	35.22	12.26	34.15	393	93	A	V
	*	5783	106.03	-	-	92.59	35.27	12.4	34.23	393	93	P	V
	*	5783	95.32	-	-	81.88	35.27	12.4	34.23	393	93	A	V
		5856.08	56.95	-21.35	78.3	43.49	35.32	12.45	34.31	393	93	P	V
		5889.04	58.11	-15.89	74	44.67	35.34	12.49	34.39	393	93	P	V
	5863.28	44.33	-9.67	54	30.87	35.32	12.49	34.35	393	93	A	V	



WIFI	Note	Frequency	Level	Over	Limit	Read	Antenna	Cable	Preamp	Ant	Table	Peak	Pol.	
Ant.				Limit	Line	Level	Factor	Loss	Factor	Pos	Pos	Avg.		
1+2		(MHz)	(dBμV/m)	(dB)	(dBμV/m)	(dBμV)	(dB/m)	(dB)	(dB)	(cm)	(deg)	(P/A)	(H/V)	
802.11a CH 165 5825MHz	*	5825	108.53	-	-	95.05	35.3	12.45	34.27	139	312	P	H	
	*	5825	98.02	-	-	84.54	35.3	12.45	34.27	139	312	A	H	
		5851.12	72.28	-6.02	78.3	58.83	35.31	12.45	34.31	139	312	P	H	
		5861.44	68.4	-5.6	74	54.94	35.32	12.49	34.35	139	312	P	H	
		5860	51.02	-2.98	54	37.6	35.32	12.45	34.35	139	312	A	H	
														H
														H
														H
	*	5825	104.62	-	-	91.14	35.3	12.45	34.27	281	29	P	V	
	*	5825	94.13	-	-	80.65	35.3	12.45	34.27	281	29	A	V	
		5852.24	69.72	-8.58	78.3	56.27	35.31	12.45	34.31	281	29	P	V	
		5861.44	64.15	-9.85	74	50.69	35.32	12.49	34.35	281	29	P	V	
		5860.88	47.52	-6.48	54	34.06	35.32	12.49	34.35	281	29	A	V	
														V
														V
														V
													V	
Remark	1. No other spurious found. 2. All results are PASS against Peak and Average limit line.													



15E Band 4 5725~5850MHz

WIFI 802.11a (Harmonic @ 3m) (with adapter1)

WIFI	Note	Frequency	Level	Over	Limit	Read	Antenna	Cable	Preamp	Ant	Table	Peak	Pol.
Ant.				Limit	Line	Level	Factor	Loss	Factor	Pos	Pos	Avg.	
1+2		(MHz)	(dBμV/m)	(dB)	(dBμV/m)	(dBμV)	(dB/m)	(dB)	(dB)	(cm)	(deg)	(P/A)	(H/V)
802.11a CH 149 5745MHz		11490	47.37	-26.63	74	49.64	38.19	17.38	57.84	100	0	P	H
		17235	50.84	-23.16	74	43.79	42.21	21.38	56.54	100	0	P	H
													H
													H
		11490	50.44	-23.56	74	52.71	38.19	17.38	57.84	100	0	P	V
		17235	50.96	-23.04	74	43.91	42.21	21.38	56.54	100	0	P	V
													V
													V
802.11a CH 157 5785MHz		11570	46.44	-27.56	74	48.37	38.3	17.46	57.69	100	0	P	H
		17352	50.55	-23.45	74	43.59	42.12	21.45	56.61	100	0	P	H
													H
													H
		11570	49.45	-24.55	74	51.38	38.3	17.46	57.69	100	0	P	V
		17355	59.47	-14.53	74	52.51	42.12	21.45	56.61	222	0	P	V
		17355	45.21	-28.79	74	38.25	42.12	21.45	56.61	222	0	A	V
													V
802.11a CH 165 5825MHz		11650	44.93	-29.07	74	46.59	38.39	17.53	57.58	100	0	P	H
		17472	51.66	-22.34	74	44.78	42.03	21.53	56.68	100	0	P	H
													H
													H
		11650	48.33	-25.67	74	49.99	38.39	17.53	57.58	100	0	P	V
		17472	58.9	-15.1	74	52.02	42.03	21.53	56.68	221	355	P	V
		17472	43.89	-10.11	54	37.01	42.03	21.53	56.68	221	355	A	V
													V
Remark	1. No other spurious found. 2. All results are PASS against Peak and Average limit line.												



15E Band 4 5725~5850MHz

WIFI 802.11n HT20 (Band Edge @ 3m) (with adapter1)

WIFI	Note	Frequency	Level	Over	Limit	Read	Antenna	Cable	Preamp	Ant	Table	Peak	Pol.	
Ant.				Limit	Line	Level	Factor	Loss	Factor	Pos	Pos	Avg.		
1+2		(MHz)	(dBμV/m)	(dB)	(dBμV/m)	(dBμV)	(dB/m)	(dB)	(dB)	(cm)	(deg)	(P/A)	(H/V)	
802.11n HT20 CH 149 5745MHz		5713.4	69.23	-4.77	74	55.9	35.22	12.26	34.15	124	315	P	H	
		5724.52	73.86	-4.44	78.3	60.52	35.23	12.26	34.15	124	315	P	H	
		5714.92	48.64	-5.36	54	35.31	35.22	12.26	34.15	124	315	A	H	
	*	5745	106.11	-	-	92.71	35.24	12.33	34.17	124	315	P	H	
	*	5745	94.89	-	-	81.49	35.24	12.33	34.17	124	315	A	H	
														H
														H
														H
			5714.2	66.71	-7.29	74	53.38	35.22	12.26	34.15	302	57	P	V
			5724.92	71.13	-7.17	78.3	57.79	35.23	12.26	34.15	302	57	P	V
			5714.84	48.25	-5.75	54	34.92	35.22	12.26	34.15	302	57	A	V
	*		5745	103.03	-	-	89.63	35.24	12.33	34.17	302	57	P	V
	*		5745	91.51	-	-	78.11	35.24	12.33	34.17	302	57	A	V
														V
														V
														V



WIFI	Note	Frequency	Level	Over	Limit	Read	Antenna	Cable	Preamp	Ant	Table	Peak	Pol.
Ant.				Limit	Line	Level	Factor	Loss	Factor	Pos	Pos	Avg.	
1+2		(MHz)	(dBμV/m)	(dB)	(dBμV/m)	(dBμV)	(dB/m)	(dB)	(dB)	(cm)	(deg)	(P/A)	(H/V)
802.11n HT20 CH 157 5785MHz		5713.56	58.2	-15.8	74	44.87	35.22	12.26	34.15	151	313	P	H
		5719.32	59	-19.3	78.3	45.66	35.23	12.26	34.15	151	313	P	H
		5713.48	44.55	-9.45	54	31.22	35.22	12.26	34.15	151	313	A	H
	*	5785	106.77	-	-	93.33	35.27	12.4	34.23	151	313	P	H
	*	5785	95.43	-	-	81.99	35.27	12.4	34.23	151	313	A	H
		5854	57.93	-20.37	78.3	44.47	35.32	12.45	34.31	151	313	P	H
		5881.12	57.5	-16.5	74	44.03	35.33	12.49	34.35	151	313	P	H
		5879.04	44.87	-9.13	54	31.4	35.33	12.49	34.35	151	313	A	H
		5695.8	57.45	-16.55	74	44.18	35.21	12.18	34.12	296	114	P	V
		5715.88	57.27	-21.03	78.3	43.94	35.22	12.26	34.15	296	114	P	V
		5711	44.65	-9.35	54	31.32	35.22	12.26	34.15	296	114	A	V
	*	5785	103.12	-	-	89.68	35.27	12.4	34.23	296	114	P	V
	*	5785	91.42	-	-	77.98	35.27	12.4	34.23	296	114	A	V
		5855.04	57.48	-20.82	78.3	44.02	35.32	12.45	34.31	296	114	P	V
		5865.68	58.63	-15.37	74	45.17	35.32	12.49	34.35	296	114	P	V
	5880.88	44.85	-9.15	54	31.38	35.33	12.49	34.35	296	114	A	V	



WIFI	Note	Frequency	Level	Over	Limit	Read	Antenna	Cable	Preamp	Ant	Table	Peak	Pol.	
Ant.				Limit	Line	Level	Factor	Loss	Factor	Pos	Pos	Avg.		
1+2		(MHz)	(dBμV/m)	(dB)	(dBμV/m)	(dBμV)	(dB/m)	(dB)	(dB)	(cm)	(deg)	(P/A)	(H/V)	
802.11n HT20 CH 165 5825MHz	*	5825	106.75	-	-	93.27	35.3	12.45	34.27	146	313	P	H	
	*	5825	95.67	-	-	82.19	35.3	12.45	34.27	146	313	A	H	
		5850.16	71.83	-6.47	78.3	58.38	35.31	12.45	34.31	146	313	P	H	
		5863.36	65.97	-8.03	74	52.51	35.32	12.49	34.35	146	313	P	H	
		5860.16	47.63	-6.37	54	34.17	35.32	12.49	34.35	146	313	A	H	
														H
														H
														H
	*	5825	102.28	-	-	88.8	35.3	12.45	34.27	308	119	P	V	
	*	5825	90.72	-	-	77.24	35.3	12.45	34.27	308	119	A	V	
		5854.32	65.56	-12.74	78.3	52.1	35.32	12.45	34.31	308	119	P	V	
		5860.56	61.16	-12.84	74	47.7	35.32	12.49	34.35	308	119	P	V	
		5861.68	45.51	-8.49	54	32.05	35.32	12.49	34.35	308	119	A	V	
														V
														V
													V	
Remark	1. No other spurious found. 2. All results are PASS against Peak and Average limit line.													



15E Band 4 5725~5850MHz

WIFI 802.11n HT20 (Harmonic @ 3m) (with adapter1)

WIFI	Note	Frequency	Level	Over	Limit	Read	Antenna	Cable	Preamp	Ant	Table	Peak	Pol.
Ant.				Limit	Line	Level	Factor	Loss	Factor	Pos	Pos	Avg.	
1+2		(MHz)	(dBµV/m)	(dB)	(dBµV/m)	(dBµV)	(dB/m)	(dB)	(dB)	(cm)	(deg)	(P/A)	(H/V)
802.11n HT20 CH 149 5745MHz		11490	45.27	-28.73	74	47.54	38.19	17.38	57.84	100	0	P	H
		17232	51.23	-22.77	74	44.18	42.21	21.38	56.54	100	0	P	H
													H
													H
		11490	50	-24	74	52.27	38.19	17.38	57.84	100	0	P	V
		17232	55.75	-18.25	74	48.7	42.21	21.38	56.54	226	358	P	V
		17232	41.94	-12.06	54	34.89	42.21	21.38	56.54	226	358	A	V
													V
802.11n HT20 CH 157 5785MHz		11570	45	-29	74	46.93	38.3	17.46	57.69	100	0	P	H
		17334	50.16	-23.84	74	43.2	42.13	21.43	56.6	100	0	P	H
													H
													H
		11570	47.7	-26.3	74	49.63	38.3	17.46	57.69	100	0	P	V
		17334	51.21	-22.79	74	44.25	42.13	21.43	56.6	100	0	P	V
													V
802.11n HT20 CH 165 5825MHz		11650	44.47	-29.53	74	46.13	38.39	17.53	57.58	100	0	P	H
		17472	50.71	-23.29	74	43.83	42.03	21.53	56.68	100	0	P	H
													H
													H
		11650	47.38	-26.62	74	49.04	38.39	17.53	57.58	100	0	P	V
		17472	56.72	-17.28	74	49.84	42.03	21.53	56.68	207	360	P	V
		17472	43.04	-10.96	54	36.16	42.03	21.53	56.68	207	360	A	V
													V
Remark	1. No other spurious found. 2. All results are PASS against Peak and Average limit line.												



15E Band 4 5725~5850MHz

WIFI 802.11n HT40 (Band Edge @ 3m) (with adapter1)

WIFI	Note	Frequency	Level	Over	Limit	Read	Antenna	Cable	Preamp	Ant	Table	Peak	Pol.
Ant.				Limit	Line	Level	Factor	Loss	Factor	Pos	Pos	Avg.	
1+2		(MHz)	(dBμV/m)	(dB)	(dBμV/m)	(dBμV)	(dB/m)	(dB)	(dB)	(cm)	(deg)	(P/A)	(H/V)
802.11n HT40 CH 151 5755MHz		5714.52	68.64	-5.36	74	55.31	35.22	12.26	34.15	165	310	P	H
		5721	71.59	-6.71	78.3	58.25	35.23	12.26	34.15	165	310	P	H
		5714.6	52.64	-1.36	54	39.31	35.22	12.26	34.15	165	310	A	H
	*	5755	101.05	-	-	87.63	35.26	12.33	34.17	165	310	P	H
	*	5755	89.9	-	-	76.48	35.26	12.33	34.17	165	310	A	H
		5857.84	58.23	-20.07	78.3	44.81	35.32	12.45	34.35	165	310	P	H
		5860.08	59.16	-14.84	74	45.7	35.32	12.49	34.35	165	310	P	H
		5862.24	45.17	-8.83	54	31.71	35.32	12.49	34.35	165	310	A	H
		5714.68	67.43	-6.57	74	54.1	35.22	12.26	34.15	302	72	P	V
		5720.84	69.06	-9.24	78.3	55.72	35.23	12.26	34.15	302	72	P	V
		5715	48.95	-5.05	54	35.62	35.22	12.26	34.15	302	72	A	V
	*	5755	97.85	-	-	84.43	35.26	12.33	34.17	302	72	P	V
	*	5755	86.48	-	-	73.06	35.26	12.33	34.17	302	72	A	V
		5850.64	57.31	-20.99	78.3	43.86	35.31	12.45	34.31	302	72	P	V
		5869.04	57	-17	74	43.54	35.32	12.49	34.35	302	72	P	V
	5878.88	45.25	-8.75	54	31.78	35.33	12.49	34.35	302	72	A	V	



WIFI	Note	Frequency	Level	Over	Limit	Read	Antenna	Cable	Preamp	Ant	Table	Peak	Pol.
Ant.				Limit	Line	Level	Factor	Loss	Factor	Pos	Pos	Avg.	
1+2		(MHz)	(dBμV/m)	(dB)	(dBμV/m)	(dBμV)	(dB/m)	(dB)	(dB)	(cm)	(deg)	(P/A)	(H/V)
802.11n HT40 CH 159 5795MHz		5709.32	62.18	-11.82	74	48.85	35.22	12.26	34.15	131	314	P	H
		5721.96	62.95	-15.35	78.3	49.61	35.23	12.26	34.15	131	314	P	H
		5714.68	45.73	-8.27	54	32.4	35.22	12.26	34.15	131	314	A	H
	*	5795	103.26	-	-	89.81	35.28	12.4	34.23	131	314	P	H
	*	5795	92.5	-	-	79.05	35.28	12.4	34.23	131	314	A	H
		5851.12	66.23	-12.07	78.3	52.78	35.31	12.45	34.31	131	314	P	H
		5863.44	62.26	-11.74	74	48.8	35.32	12.49	34.35	131	314	P	H
		5860.64	49.17	-4.83	54	35.71	35.32	12.49	34.35	131	314	A	H
		5705.8	58.16	-15.84	74	44.83	35.22	12.26	34.15	375	81	P	V
		5721.8	59.59	-18.71	78.3	46.25	35.23	12.26	34.15	375	81	P	V
		5711.96	45.01	-8.99	54	31.68	35.22	12.26	34.15	375	81	A	V
	*	5795	99.8	-	-	86.35	35.28	12.4	34.23	375	81	P	V
	*	5795	88.56	-	-	75.11	35.28	12.4	34.23	375	81	A	V
		5851.6	60.31	-17.99	78.3	46.86	35.31	12.45	34.31	375	81	P	V
		5868.16	58.4	-15.6	74	44.94	35.32	12.49	34.35	375	81	P	V
	5860.08	45.79	-8.21	54	32.33	35.32	12.49	34.35	375	81	A	V	
Remark	1. No other spurious found. 2. All results are PASS against Peak and Average limit line.												



15E Band 4 5725~5850MHz

WIFI 802.11n HT40 (Harmonic @ 3m) (with adapter1)

WIFI	Note	Frequency	Level	Over	Limit	Read	Antenna	Cable	Preamp	Ant	Table	Peak	Pol.
Ant.				Limit	Line	Level	Factor	Loss	Factor	Pos	Pos	Avg.	
1+2		(MHz)	(dBμV/m)	(dB)	(dBμV/m)	(dBμV)	(dB/m)	(dB)	(dB)	(cm)	(deg)	(P/A)	(H/V)
802.11n HT40 CH 151 5755MHz		11510	44.9	-29.1	74	47.08	38.2	17.42	57.8	100	0	P	H
		17268	50.37	-23.63	74	43.34	42.19	21.4	56.56	100	0	P	H
													H
													H
		11510	44.44	-29.56	74	46.62	38.2	17.42	57.8	100	0	P	V
		17268	50.67	-23.33	74	43.64	42.19	21.4	56.56	100	0	P	V
													V
802.11n HT40 CH 159 5795MHz		11590	44.29	-29.71	74	46.13	38.32	17.5	57.66	100	0	P	H
		17388	50.71	-23.29	74	43.77	42.09	21.48	56.63	100	0	P	H
													H
													H
		11590	45.36	-28.64	74	47.2	38.32	17.5	57.66	100	0	P	V
		17388	52.92	-21.08	74	45.98	42.09	21.48	56.63	100	0	P	V
													V
Remark	1. No other spurious found. 2. All results are PASS against Peak and Average limit line.												



15E Band 4 5725~5850MHz

WIFI 802.11ac VHT20 (Band Edge @ 3m) (with adapter1)

WIFI	Note	Frequency	Level	Over	Limit	Read	Antenna	Cable	Preamp	Ant	Table	Peak	Pol.
Ant.				Limit	Line	Level	Factor	Loss	Factor	Pos	Pos	Avg.	
1+2		(MHz)	(dBμV/m)	(dB)	(dBμV/m)	(dBμV)	(dB/m)	(dB)	(dB)	(cm)	(deg)	(P/A)	(H/V)
802.11ac VHT20 CH 149 5745MHz		5714.76	69.1	-4.9	74	55.77	35.22	12.26	34.15	199	236	P	H
		5722.28	74.31	-3.99	78.3	60.97	35.23	12.26	34.15	199	236	P	H
		5715	49.02	-4.98	54	35.69	35.22	12.26	34.15	199	236	A	H
	*	5744	105.36	-	-	91.96	35.24	12.33	34.17	199	236	P	H
	*	5744	95.42	-	-	82.02	35.24	12.33	34.17	199	236	A	H
		5851.36	57.12	-21.18	78.3	43.67	35.31	12.45	34.31	199	236	P	H
		5870.24	57.45	-16.55	74	43.99	35.32	12.49	34.35	199	236	P	H
		5863.6	44.86	-9.14	54	31.4	35.32	12.49	34.35	199	236	A	H
		5712.36	67.7	-6.3	74	54.37	35.22	12.26	34.15	346	92	P	V
		5725	71.09	-7.21	78.3	57.75	35.23	12.26	34.15	346	92	P	V
		5714.28	48.06	-5.94	54	34.73	35.22	12.26	34.15	346	92	A	V
	*	5747	103.39	-	-	89.99	35.24	12.33	34.17	346	92	P	V
	*	5747	92.82	-	-	79.42	35.24	12.33	34.17	346	92	A	V
		5853.76	57.13	-21.17	78.3	43.67	35.32	12.45	34.31	346	92	P	V
		5874.8	57.15	-16.85	74	43.68	35.33	12.49	34.35	346	92	P	V
	5877.68	44.73	-9.27	54	31.26	35.33	12.49	34.35	346	92	A	V	



WIFI	Note	Frequency	Level	Over	Limit	Read	Antenna	Cable	Preamp	Ant	Table	Peak	Pol.
Ant.				Limit	Line	Level	Factor	Loss	Factor	Pos	Pos	Avg.	
1+2		(MHz)	(dBμV/m)	(dB)	(dBμV/m)	(dBμV)	(dB/m)	(dB)	(dB)	(cm)	(deg)	(P/A)	(H/V)
802.11ac VHT20 CH 157 5785MHz		5713.4	63.94	-10.06	74	50.61	35.22	12.26	34.15	248	327	P	H
		5722.12	65.41	-12.89	78.3	52.07	35.23	12.26	34.15	248	327	P	H
		5701.72	46.39	-7.61	54	33.03	35.22	12.26	34.12	248	327	A	H
	*	5785	104.22	-	-	90.78	35.27	12.4	34.23	248	327	P	H
	*	5785	93.84	-	-	80.4	35.27	12.4	34.23	248	327	A	H
		5854.24	61.44	-16.86	78.3	47.98	35.32	12.45	34.31	248	327	P	H
		5861.28	60.39	-13.61	74	46.93	35.32	12.49	34.35	248	327	P	H
		5860.48	45.72	-8.28	54	32.26	35.32	12.49	34.35	248	327	A	H
		5713.48	64.61	-9.39	74	51.28	35.22	12.26	34.15	395	82	P	V
		5720.68	65.93	-12.37	78.3	52.59	35.23	12.26	34.15	395	82	P	V
		5689	46.52	-7.48	54	33.25	35.21	12.18	34.12	395	82	A	V
	*	5787	102.53	-	-	89.08	35.28	12.4	34.23	395	82	P	V
	*	5787	93.1	-	-	79.65	35.28	12.4	34.23	395	82	A	V
		5851.28	62.86	-15.44	78.3	49.41	35.31	12.45	34.31	395	82	P	V
		5862.56	60.37	-13.63	74	46.91	35.32	12.49	34.35	395	82	P	V
	5877.28	46	-8	54	32.53	35.33	12.49	34.35	395	82	A	V	



WIFI	Note	Frequency	Level	Over	Limit	Read	Antenna	Cable	Preamp	Ant	Table	Peak	Pol.
Ant.				Limit	Line	Level	Factor	Loss	Factor	Pos	Pos	Avg.	
1+2		(MHz)	(dBμV/m)	(dB)	(dBμV/m)	(dBμV)	(dB/m)	(dB)	(dB)	(cm)	(deg)	(P/A)	(H/V)
802.11ac VHT20 CH 165 5825MHz		5697	57.26	-16.74	74	43.99	35.21	12.18	34.12	199	232	P	H
		5722.52	56.83	-21.47	78.3	43.49	35.23	12.26	34.15	199	232	P	H
		5703.16	44.61	-9.39	54	31.25	35.22	12.26	34.12	199	232	A	H
	*	5825	104.59	-	-	91.11	35.3	12.45	34.27	199	232	P	H
	*	5825	95.16	-	-	81.68	35.3	12.45	34.27	199	232	A	H
		5850.88	69.48	-8.82	78.3	56.03	35.31	12.45	34.31	199	232	P	H
		5860.08	65.17	-8.83	74	51.71	35.32	12.49	34.35	199	232	P	H
		5860.32	46.69	-7.31	54	33.23	35.32	12.49	34.35	199	232	A	H
		5704.76	57.04	-16.96	74	43.71	35.22	12.26	34.15	352	76	P	V
		5720.28	57.49	-20.81	78.3	44.15	35.23	12.26	34.15	352	76	P	V
		5693.56	44.59	-9.41	54	31.32	35.21	12.18	34.12	352	76	A	V
	*	5825	102.01	-	-	88.53	35.3	12.45	34.27	352	76	P	V
	*	5825	90.67	-	-	77.19	35.3	12.45	34.27	352	76	A	V
		5855.68	63.34	-14.96	78.3	49.88	35.32	12.45	34.31	352	76	P	V
		5861.36	62.25	-11.75	74	48.79	35.32	12.49	34.35	352	76	P	V
	5860.72	45.79	-8.21	54	32.33	35.32	12.49	34.35	352	76	A	V	
Remark	1. No other spurious found. 2. All results are PASS against Peak and Average limit line.												



15E Band 4 5725~5850MHz

WIFI 802.11ac VHT20 (Harmonic @ 3m) (with adapter1)

WIFI	Note	Frequency	Level	Over	Limit	Read	Antenna	Cable	Preamp	Ant	Table	Peak	Pol.
Ant.				Limit	Line	Level	Factor	Loss	Factor	Pos	Pos	Avg.	
1+2		(MHz)	(dBμV/m)	(dB)	(dBμV/m)	(dBμV)	(dB/m)	(dB)	(dB)	(cm)	(deg)	(P/A)	(H/V)
802.11ac VHT20 CH 149 5745MHz		11490	45.68	-28.32	74	47.95	38.19	17.38	57.84	100	0	P	H
		17232	50.84	-23.16	74	43.79	42.21	21.38	56.54	100	0	P	H
													H
													H
		11490	47.99	-26.01	74	50.26	38.19	17.38	57.84	100	0	P	V
		17232	51.89	-22.11	74	44.84	42.21	21.38	56.54	100	0	P	V
													V
802.11ac VHT20 CH 157 5785MHz		11570	44.43	-29.57	74	46.36	38.3	17.46	57.69	100	0	P	H
		17352	51.34	-22.66	74	44.38	42.12	21.45	56.61	100	0	P	H
													H
													H
		11570	48.48	-25.52	74	50.41	38.3	17.46	57.69	100	0	P	V
		17352	52.99	-21.01	74	46.03	42.12	21.45	56.61	100	0	P	V
													V
802.11ac VHT20 CH 165 5825MHz		11650	44.72	-29.28	74	46.38	38.39	17.53	57.58	100	0	P	H
		17472	51.28	-22.72	74	44.4	42.03	21.53	56.68	100	0	P	H
													H
													H
		11650	47.42	-26.58	74	49.08	38.39	17.53	57.58	100	0	P	V
		17472	54.21	-19.79	74	47.33	42.03	21.53	56.68	221	357	P	V
		17472	43.01	-30.99	54	36.13	42.03	21.53	56.68	221	357	A	V
Remark	1. No other spurious found. 2. All results are PASS against Peak and Average limit line.												



15E Band 4 5725~5850MHz

WIFI 802.11ac VHT40 (Band Edge @ 3m) (with adapter1)

WIFI	Note	Frequency	Level	Over	Limit	Read	Antenna	Cable	Preamp	Ant	Table	Peak	Pol.
Ant.				Limit	Line	Level	Factor	Loss	Factor	Pos	Pos	Avg.	
1+2		(MHz)	(dBμV/m)	(dB)	(dBμV/m)	(dBμV)	(dB/m)	(dB)	(dB)	(cm)	(deg)	(P/A)	(H/V)
802.11ac VHT40 CH 151 5755MHz		5707.32	68.44	-5.56	74	55.11	35.22	12.26	34.15	200	235	P	H
		5721.48	71.16	-7.14	78.3	57.82	35.23	12.26	34.15	200	235	P	H
		5715	52.15	-1.85	54	38.82	35.22	12.26	34.15	200	235	A	H
	*	5752	99.46	-	-	86.04	35.26	12.33	34.17	200	235	P	H
	*	5752	89.49	-	-	76.07	35.26	12.33	34.17	200	235	A	H
		5858.88	56.97	-21.33	78.3	43.55	35.32	12.45	34.35	200	235	P	H
		5879.36	57.49	-16.51	74	44.02	35.33	12.49	34.35	200	235	P	H
		5881.04	44.91	-9.09	54	31.44	35.33	12.49	34.35	200	235	A	H
		5714.2	66.42	-7.58	74	53.09	35.22	12.26	34.15	344	90	P	V
		5724.52	68.92	-9.38	78.3	55.58	35.23	12.26	34.15	344	90	P	V
		5714.92	48.88	-5.12	54	35.55	35.22	12.26	34.15	344	90	A	V
	*	5755	97.42	-	-	84	35.26	12.33	34.17	344	90	P	V
	*	5755	86.96	-	-	73.54	35.26	12.33	34.17	344	90	A	V
		5852.88	56.99	-21.31	78.3	43.54	35.31	12.45	34.31	344	90	P	V
		5885.28	57.8	-16.2	74	44.37	35.33	12.49	34.39	344	90	P	V
	5888.96	45.02	-8.98	54	31.58	35.34	12.49	34.39	344	90	A	V	



WIFI	Note	Frequency	Level	Over	Limit	Read	Antenna	Cable	Preamp	Ant	Table	Peak	Pol.
Ant.				Limit	Line	Level	Factor	Loss	Factor	Pos	Pos	Avg.	
1+2		(MHz)	(dBμV/m)	(dB)	(dBμV/m)	(dBμV)	(dB/m)	(dB)	(dB)	(cm)	(deg)	(P/A)	(H/V)
802.11ac VHT40 CH 159 5795MHz		5702.44	61.95	-12.05	74	48.59	35.22	12.26	34.12	110	301	P	H
		5723.24	64	-14.3	78.3	50.66	35.23	12.26	34.15	110	301	P	H
		5712.68	45.11	-8.89	54	31.78	35.22	12.26	34.15	110	301	A	H
	*	5795	101.2	-	-	87.75	35.28	12.4	34.23	110	301	P	H
	*	5795	91.21	-	-	77.76	35.28	12.4	34.23	110	301	A	H
		5851.68	64.4	-13.9	78.3	50.95	35.31	12.45	34.31	110	301	P	H
		5862.48	61.77	-12.23	74	48.31	35.32	12.49	34.35	110	301	P	H
		5860.88	48.84	-5.16	54	35.38	35.32	12.49	34.35	110	301	A	H
		5704.6	58.6	-15.4	74	45.24	35.22	12.26	34.12	101	20	P	V
		5723.56	60.53	-17.77	78.3	47.19	35.23	12.26	34.15	101	20	P	V
		5715	44.7	-9.3	54	31.37	35.22	12.26	34.15	101	20	A	V
	*	5795	96.94	-	-	83.49	35.28	12.4	34.23	101	20	P	V
	*	5795	87.49	-	-	74.04	35.28	12.4	34.23	101	20	A	V
		5853.28	61.83	-16.47	78.3	48.38	35.31	12.45	34.31	101	20	P	V
		5862.96	59.11	-14.89	74	45.65	35.32	12.49	34.35	101	20	P	V
	5862.24	45.94	-8.06	54	32.48	35.32	12.49	34.35	101	20	A	V	
Remark	1. No other spurious found. 2. All results are PASS against Peak and Average limit line.												



15E Band 4 5725~5850MHz

WIFI 802.11ac VHT40 (Harmonic @ 3m) (with adapter1)

WIFI	Note	Frequency	Level	Over	Limit	Read	Antenna	Cable	Preamp	Ant	Table	Peak	Pol.
Ant.				Limit	Line	Level	Factor	Loss	Factor	Pos	Pos	Avg.	
1+2		(MHz)	(dBµV/m)	(dB)	(dBµV/m)	(dBµV)	(dB/m)	(dB)	(dB)	(cm)	(deg)	(P/A)	(H/V)
802.11ac VHT40 CH 151 5755MHz		11510	44.55	-29.45	74	46.73	38.2	17.42	57.8	100	0	P	H
		17268	50.42	-23.58	74	43.39	42.19	21.4	56.56	100	0	P	H
													H
													H
		11510	46.9	-27.1	74	49.08	38.2	17.42	57.8	100	0	P	V
		17268	50.17	-23.83	74	43.14	42.19	21.4	56.56	100	0	P	V
													V
802.11ac VHT40 CH 159 5795MHz		11589	43.98	-30.02	74	45.82	38.32	17.5	57.66	100	0	P	H
		17385	50.86	-23.14	74	43.92	42.09	21.48	56.63	100	0	P	H
													H
													H
		11589	45.64	-28.36	74	47.48	38.32	17.5	57.66	100	0	P	V
		17385	50.89	-23.11	74	43.95	42.09	21.48	56.63	100	0	P	V
													V
Remark	1. No other spurious found. 2. All results are PASS against Peak and Average limit line.												



15E Band 4 5725~5850MHz

WIFI 802.11ac VHT80 (Band Edge @ 3m) (with adapter1)

WIFI	Note	Frequency	Level	Over	Limit	Read	Antenna	Cable	Preamp	Ant	Table	Peak	Pol.
Ant.				Limit	Line	Level	Factor	Loss	Factor	Pos	Pos	Avg.	
1+2		(MHz)	(dBμV/m)	(dB)	(dBμV/m)	(dBμV)	(dB/m)	(dB)	(dB)	(cm)	(deg)	(P/A)	(H/V)
802.11ac VHT80 CH 155 5775MHz		5713.72	64.16	-9.84	74	50.83	35.22	12.26	34.15	102	302	P	H
		5719.08	67.76	-10.54	78.3	54.42	35.23	12.26	34.15	102	302	P	H
		5712.92	52.52	-1.48	54	39.19	35.22	12.26	34.15	102	302	A	H
	*	5776	97.94	-	-	84.54	35.27	12.33	34.2	102	302	P	H
	*	5776	86.32	-	-	72.92	35.27	12.33	34.2	102	302	A	H
		5852.08	61.42	-16.88	78.3	47.97	35.31	12.45	34.31	102	302	P	H
		5862.56	61.12	-12.88	74	47.66	35.32	12.49	34.35	102	302	P	H
		5862.96	48.61	-5.39	54	35.15	35.32	12.49	34.35	102	302	A	H
		5712.36	61.1	-12.9	74	47.77	35.22	12.26	34.15	101	20	P	V
		5724.92	62.13	-16.17	78.3	48.79	35.23	12.26	34.15	101	20	P	V
		5713.4	49.6	-4.4	54	36.27	35.22	12.26	34.15	101	20	A	V
	*	5775	92.56	-	-	79.16	35.27	12.33	34.2	101	20	P	V
	*	5775	81.84	-	-	68.44	35.27	12.33	34.2	101	20	A	V
		5857.92	57.38	-20.92	78.3	43.96	35.32	12.45	34.35	101	20	P	V
		5864.32	57.71	-16.29	74	44.25	35.32	12.49	34.35	101	20	P	V
	5878.32	46.02	-7.98	54	32.55	35.33	12.49	34.35	101	20	A	V	
Remark	1. No other spurious found. 2. All results are PASS against Peak and Average limit line.												



15E Band 4 5725~5850MHz

WIFI 802.11ac VHT80 (Harmonic @ 3m) (with adapter1)

WIFI	Note	Frequency	Level	Over	Limit	Read	Antenna	Cable	Preamp	Ant	Table	Peak	Pol.
Ant.				Limit	Line	Level	Factor	Loss	Factor	Pos	Pos	Avg.	
1+2		(MHz)	(dBμV/m)	(dB)	(dBμV/m)	(dBμV)	(dB/m)	(dB)	(dB)	(cm)	(deg)	(P/A)	(H/V)
802.11ac VHT80 CH 155 5775MHz		11550	43.76	-30.24	74	45.75	38.27	17.46	57.72	100	0	P	H
		17328	50.2	-23.8	74	43.21	42.15	21.43	56.59	100	0	P	H
													H
													H
		11550	44.16	-29.84	74	46.15	38.27	17.46	57.72	100	0	P	V
		17328	50.53	-23.47	74	43.54	42.15	21.43	56.59	100	0	P	V
													V
													V
Remark	1. No other spurious found. 2. All results are PASS against Peak and Average limit line.												



15E Emission below 1GHz

5GHz WIFI 802.11n HT40 (LF @ 3m) (with adapter1)

WIFI	Note	Frequency	Level	Over	Limit	Read	Antenna	Cable	Preamp	Ant	Table	Peak	Pol.	
Ant.				Limit	Line	Level	Factor	Loss	Factor	Pos	Pos	Avg.		
1+2		(MHz)	(dBμV/m)	(dB)	(dBμV/m)	(dBμV)	(dB/m)	(dB)	(dB)	(cm)	(deg)	(P/A)	(H/V)	
5GHz 802.11n HT40 LF		30.54	31.94	-8.06	40	43.35	18.28	1.77	31.46	253	220	P	H	
		59.43	30.47	-9.53	40	53.9	6.08	1.77	31.28			P	H	
		211.98	29.45	-14.05	43.5	48.62	9.22	2.69	31.08			P	H	
		515.6	21.71	-24.29	46	30.38	18.1	3.89	30.66			P	H	
		643	24.85	-21.15	46	30.74	20.4	4.22	30.51			P	H	
		948.2	29.09	-16.91	46	30.16	24.39	4.94	30.4			P	H	
														H
														H
														H
														H
														H
														H
														H
			30	34.44	-5.56	40	45.37	18.8	1.77	31.5			P	V
			43.77	35.72	-4.28	40	53.95	11.2	1.77	31.2			P	V
			78.33	36.04	-3.96	40	58.25	6.93	2.06	31.2	100	97	P	V
			461.7	27.3	-18.7	46	36.91	17.42	3.77	30.8			P	V
			660.5	24.56	-21.44	46	30.38	20.31	4.35	30.48			P	V
			927.2	28.98	-17.02	46	30.32	24.21	4.8	30.35			P	V
														V
													V	
													V	
													V	
													V	
													V	
Remark	1. No other spurious found. 2. All results are PASS against limit line.													



15E Band 4 5725~5850MHz

WIFI 802.11n HT40 (Band Edge @ 3m) (with adapter2)

WIFI	Note	Frequency	Level	Over	Limit	Read	Antenna	Cable	Preamp	Ant	Table	Peak	Pol.
Ant.				Limit	Line	Level	Factor	Loss	Factor	Pos	Pos	Avg.	
1+2		(MHz)	(dBμV/m)	(dB)	(dBμV/m)	(dBμV)	(dB/m)	(dB)	(dB)	(cm)	(deg)	(P/A)	(H/V)
802.11n HT40 CH 151 5755MHz		5714.36	67.96	-6.04	74	54.63	35.22	12.26	34.15	155	306	P	H
		5721.32	72.1	-6.2	78.3	58.76	35.23	12.26	34.15	155	306	P	H
		5714.92	52.51	-1.49	54	39.18	35.22	12.26	34.15	155	306	A	H
	*	5760	100.97	-	-	87.58	35.26	12.33	34.2	155	306	P	H
	*	5760	91	-	-	77.61	35.26	12.33	34.2	155	306	A	H
		5856.08	58.99	-19.31	78.3	45.53	35.32	12.45	34.31	155	306	P	H
		5862.48	58.2	-15.8	74	44.74	35.32	12.49	34.35	155	306	P	H
		5862.48	44.87	-9.13	54	31.41	35.32	12.49	34.35	155	306	A	H
		5714.44	67.57	-6.43	74	54.24	35.22	12.26	34.15	287	82	P	V
		5725	70.01	-8.29	78.3	56.67	35.23	12.26	34.15	287	82	P	V
		5714.52	50.78	-3.22	54	37.45	35.22	12.26	34.15	287	82	A	V
	*	5755	97.21	-	-	83.79	35.26	12.33	34.17	287	82	P	V
	*	5755	86.66	-	-	73.24	35.26	12.33	34.17	287	82	A	V
		5851.36	57.58	-20.72	78.3	44.13	35.31	12.45	34.31	287	82	P	V
		5876.64	57.48	-16.52	74	44.01	35.33	12.49	34.35	287	82	P	V
	5862.08	44.74	-9.26	54	31.28	35.32	12.49	34.35	287	82	A	V	



15E Band 4 5725~5850MHz

WIFI 802.11n HT40 (Harmonic @ 3m) (with adapter2)

WIFI	Note	Frequency	Level	Over	Limit	Read	Antenna	Cable	Preamp	Ant	Table	Peak	Pol.
Ant.				Limit	Line	Level	Factor	Loss	Factor	Pos	Pos	Avg.	
1+2		(MHz)	(dBμV/m)	(dB)	(dBμV/m)	(dBμV)	(dB/m)	(dB)	(dB)	(cm)	(deg)	(P/A)	(H/V)
802.11n HT40 CH 151 5755MHz		11511	44.61	-29.39	74	46.79	38.2	17.42	57.8	100	0	P	H
		17265	50.21	-23.79	74	43.18	42.19	21.4	56.56	100	0	P	H
													H
													H
		11511	45.16	-28.84	74	47.34	38.2	17.42	57.8	100	0	P	V
		17265	50.2	-23.8	74	43.17	42.19	21.4	56.56	100	0	P	V
													V
													V
Remark	3. No other spurious found. 4. All results are PASS against Peak and Average limit line.												



15E Band 4 5725~5850MHz

WIFI 802.11n HT40 (Band Edge @ 3m) (with adapter3)

WIFI	Note	Frequency	Level	Over	Limit	Read	Antenna	Cable	Preamp	Ant	Table	Peak	Pol.
Ant.				Limit	Line	Level	Factor	Loss	Factor	Pos	Pos	Avg.	
1+2		(MHz)	(dBμV/m)	(dB)	(dBμV/m)	(dBμV)	(dB/m)	(dB)	(dB)	(cm)	(deg)	(P/A)	(H/V)
802.11n HT40 CH 151 5755MHz		5707.56	67.98	-6.02	74	54.65	35.22	12.26	34.15	155	306	P	H
		5721.24	71.79	-6.51	78.3	58.45	35.23	12.26	34.15	155	306	P	H
		5715	52.63	-1.37	54	39.3	35.22	12.26	34.15	155	306	A	H
	*	5755	100.36	-	-	86.94	35.26	12.33	34.17	155	306	P	H
	*	5755	90.09	-	-	76.67	35.26	12.33	34.17	155	306	A	H
		5854.4	59.27	-19.03	78.3	45.81	35.32	12.45	34.31	155	306	P	H
		5863.76	57.31	-16.69	74	43.85	35.32	12.49	34.35	155	306	P	H
		5875.12	44.8	-9.2	54	31.33	35.33	12.49	34.35	155	306	A	H
		5714.12	67.91	-6.09	74	54.58	35.22	12.26	34.15	287	82	P	V
		5722.2	69.21	-9.09	78.3	55.87	35.23	12.26	34.15	287	82	P	V
		5713.96	50.69	-3.31	54	37.36	35.22	12.26	34.15	287	82	A	V
	*	5755	97.36	-	-	83.94	35.26	12.33	34.17	287	82	P	V
	*	5755	86.93	-	-	73.51	35.26	12.33	34.17	287	82	A	V
		5850.56	56.86	-21.44	78.3	43.41	35.31	12.45	34.31	287	82	P	V
		5885.6	57.44	-16.56	74	44.01	35.33	12.49	34.39	287	82	P	V
	5882.08	44.78	-9.22	54	31.31	35.33	12.49	34.35	287	82	A	V	



15E Band 4 5725~5850MHz

WIFI 802.11n HT40 (Harmonic @ 3m) (with adapter3)

WIFI	Note	Frequency	Level	Over	Limit	Read	Antenna	Cable	Preamp	Ant	Table	Peak	Pol.
Ant.				Limit	Line	Level	Factor	Loss	Factor	Pos	Pos	Avg.	
1+2		(MHz)	(dBμV/m)	(dB)	(dBμV/m)	(dBμV)	(dB/m)	(dB)	(dB)	(cm)	(deg)	(P/A)	(H/V)
802.11n HT40 CH 151 5755MHz		11510	44.25	-29.75	74	46.43	38.2	17.42	57.8	100	0	P	H
		17265	49.9	-24.1	74	42.87	42.19	21.4	56.56	100	0	P	H
													H
													H
		11510	45.37	-28.63	74	47.55	38.2	17.42	57.8	100	0	P	V
		17268	50.56	-23.44	74	43.53	42.19	21.4	56.56	100	0	P	V
													V
													V
Remark	5. No other spurious found. 6. All results are PASS against Peak and Average limit line.												



Note symbol

*	Fundamental Frequency which can be ignored. However, the level of any unwanted emissions shall not exceed the level of the fundamental frequency per 15.209(c).
!	Test result is over limit line.
P/A	Peak or Average
H/V	Horizontal or Vertical



A calculation example for radiated spurious emission is shown as below:

WIFI	Note	Frequency	Level	Over	Limit	Read	Antenna	Cable	Preamp	Ant	Table	Peak	Pol.
Ant.				Limit	Line	Level	Factor	Loss	Factor	Pos	Pos	Avg.	
1+2		(MHz)	(dBμV/m)	(dB)	(dBμV/m)	(dBμV)	(dB/m)	(dB)	(dB)	(cm)	(deg)	(P/A)	(H/V)
802.11b		2390	55.45	-18.55	74	54.51	32.22	4.58	35.86	103	308	P	H
CH 01		2390	43.54	-10.46	54	42.6	32.22	4.58	35.86	103	308	A	H
2412MHz													

- Level(dBμV/m) =
Antenna Factor(dB/m) + Cable Loss(dB) + Read Level(dBμV) - Preamp Factor(dB)
- Over Limit(dB) = Level(dBμV/m) – Limit Line(dBμV/m)

For Peak Limit @ 2390MHz:

- Level(dBμV/m)
= Antenna Factor(dB/m) + Cable Loss(dB) + Read Level(dBμV) - Preamp Factor(dB)
= 32.22(dB/m) + 4.58(dB) + 54.51(dBμV) – 35.86 (dB)
= 55.45 (dBμV/m)
- Over Limit(dB)
= Level(dBμV/m) – Limit Line(dBμV/m)
= 55.45(dBμV/m) – 74(dBμV/m)
= -18.55(dB)

For Average Limit @ 2390MHz:

- Level(dBμV/m)
= Antenna Factor(dB/m) + Cable Loss(dB) + Read Level(dBμV) - Preamp Factor(dB)
= 32.22(dB/m) + 4.58(dB) + 42.6(dBμV) – 35.86 (dB)
= 43.54 (dBμV/m)
- Over Limit(dB)
= Level(dBμV/m) – Limit Line(dBμV/m)
= 43.54(dBμV/m) – 54(dBμV/m)
= -10.46(dB)

Both peak and average measured complies with the limit line, so test result is “PASS”.