



FCC RF Test Report

APPLICANT : Motorola Mobility, LLC
EQUIPMENT : Mobile Cellular Phone
BRAND NAME : Motorola
MODEL NAME : 5136
FCC ID : IHDT56UC1
STANDARD : FCC 47 CFR Part 2, and 90(S)
CLASSIFICATION : PCS Licensed Transmitter Held to Ear (PCE)

The product was received on Apr. 16, 2015 and testing was completed on May 27, 2015. We, SPORTON INTERNATIONAL INC., would like to declare that the tested sample has been evaluated in accordance with the procedures given in ANSI / TIA / EIA-603-C-2004 and shown compliance with the applicable technical standards.

The test results in this report apply exclusively to the tested model / sample. Without written approval of SPORTON INTERNATIONAL INC., the test report shall not be reproduced except in full.

Reviewed by: Joseph Lin / Supervisor

Approved by: Jones Tsai / Manager



SPORTON INTERNATIONAL INC.

No. 52, Hwa Ya 1st Rd., Hwa Ya Technology Park, Kwei-Shan District, Tao Yuan City, Taiwan, R.O.C.



TABLE OF CONTENTS

REVISION HISTORY..... 3

SUMMARY OF TEST RESULT 4

1 GENERAL DESCRIPTION 5

 1.1 Applicant..... 5

 1.2 Manufacturer 5

 1.3 Feature of Equipment Under Test..... 5

 1.4 Product Specification of Equipment Under Test 6

 1.5 Modification of EUT 6

 1.6 Maximum Conducted Power, Frequency Tolerance, and Emission Designator..... 6

 1.7 Testing Site..... 7

 1.8 Applied Standards 7

2 TEST CONFIGURATION OF EQUIPMENT UNDER TEST 8

 2.1 Test Mode..... 8

 2.2 Connection Diagram of Test System 9

 2.3 Support Unit used in test configuration 9

 2.4 Measurement Results Explanation Example 9

3 TEST RESULT 10

 3.1 Conducted Output Power Measurement..... 10

 3.2 Bandwidth Limitations Measurement 12

 3.3 Emissions Mask Measurement 20

 3.4 Emissions Mask – Out Of Band Emissions Measurement..... 25

 3.5 Field Strength of Spurious Radiation Measurement 30

 3.6 Frequency Stability Measurement..... 38

4 LIST OF MEASURING EQUIPMENT 41

5 UNCERTAINTY OF EVALUATION 42



SUMMARY OF TEST RESULT

Report Section	FCC Rule	Description	Limit	Result	Remark
3.1	§2.1046 §90.635	Conducted Output Power	< 100 Watts	PASS	-
3.2	§2.1049 §90.209	Bandwidth limitations	N/A (Reporting only)	PASS	-
3.3	§2.1051 §90.691	Emission masks – In-band emissions	< 50+10log ₁₀ (P[Watts])	PASS	-
3.4	§2.1051 §90.691	Emission masks – Out of band emissions	< 43+10log ₁₀ (P[Watts])	PASS	-
3.5	§2.1053 §90.691	Field Strength of Spurious Radiation	< 43+10log ₁₀ (P[Watts])	PASS	Under limit 39.77 dB at 2456.000 MHz
3.6	§2.1055 §90.213	Frequency Stability for Temperature & Voltage	< 2.5 ppm	PASS	-



1 General Description

1.1 Applicant

Motorola Mobility, LLC

222 W Merchandise Mart Plaza, Suite 1800, Chicago, IL 60654, United States

1.2 Manufacturer

Motorola Mobility, LLC

222 W Merchandise Mart Plaza, Suite 1800, Chicago, IL 60654, United States

1.3 Feature of Equipment Under Test

Product Feature & Specification	
Equipment	Mobile Cellular Phone
Brand Name	Motorola
Model Name	5136
FCC ID	IHDT56UC1
IMEI Code	990006250037586
EUT supports Radios application	CDMA/EV-DO/GSM/EGPRS/WCDMA/HSPA/LTE/NFC 2.4GHz WLAN 11b/g/n HT20 WLAN 11ac VHT20 5GHz WLAN 11a/n HT20/HT40 WLAN 11ac VHT20/VHT40/VHT80 Bluetooth v3.0 EDR Bluetooth v4.1 - LE
HW Version	P2B
EUT Stage	Identical Prototype

Remark: The above EUT's information was declared by manufacturer. Please refer to the specifications or user's manual for more detailed description.

Accessory List	
AC Adapter	Brand Name : Motorola
	Model Name : SPN5886A
Battery	Brand Name : Motorola
	Model Name : FX30
Earphone	Brand Name : Motorola
	Model Name : SJYN1305A



1.4 Product Specification of Equipment Under Test

Product Specification subjective to this standard	
Tx Frequency	817.9 MHz ~ 823.1 MHz
Rx Frequency	862.9 MHz ~ 868.1 MHz
Maximum Output Power to Antenna	23.40 dBm
Antenna Type	Fixed Internal Antenna
Type of Modulation	CDMA2000 : QPSK CDMA2000 1xEV-DO : QPSK/8PSK

Remark: This test report recorded only product characteristics and test results of PCS Licensed Transmitter Held to Ear (PCE).

1.5 Modification of EUT

No modifications are made to the EUT during all test items.

1.6 Maximum Conducted Power, Frequency Tolerance, and Emission Designator

FCC Rule	System	Type of Modulation	Maximum Conducted Power (W)	Frequency Tolerance (ppm)	Emission Designator
Part 90(S)	CDMA2000 BC10 1xRTT	QPSK	0.2183	0.0256 ppm	1M28F9W
Part 90(S)	CDMA2000 BC10 1xEV-DO Rev. 0	QPSK	0.2188	0.0256 ppm	1M29F9W



1.7 Testing Site

Sporton Lab is accredited to ISO 17025 by Taiwan Accreditation Foundation (TAF code : 1190) and the FCC designation No. TW1022 under the FCC 2.948(e) by Mutual Recognition Agreement (MRA) in FCC Test.

Test Site	SPORTON INTERNATIONAL INC.	
Test Site Location	No. 52, Hwa Ya 1 st Rd., Hwa Ya Technology Park, Kwei-Shan District, Tao Yuan City, Taiwan, R.O.C. TEL: +886-3-327-3456 FAX: +886-3-328-4978	
Test Site No.	Sporton Site No.	
	TH03-HY	03CH07-HY

1.8 Applied Standards

According to the specifications of the manufacturer, the EUT must comply with the requirements of the following standards:

- ♦ FCC 47 CFR Part 2, 90
- ♦ ANSI / TIA / EIA-603-C-2004
- ♦ FCC KDB 971168 D01 Power Meas. License Digital Systems v02r02

Remark:

1. All test items were verified and recorded according to the standards and without any deviation during the test.
2. This EUT has also been tested and complied with the requirements of FCC Part 15, Subpart B, recorded in a separate test report.



2 Test Configuration of Equipment Under Test

2.1 Test Mode

Antenna port conducted and radiated test items were performed according to KDB 971168 D01 Power Meas. License Digital Systems v02r02 with maximum output power.

Radiated measurements were performed with rotating EUT in different three orthogonal test planes to find the maximum emission.

Frequency range investigated for radiated emission is 30 MHz to 9000 MHz for CDMA2000 BC10.

Test Modes		
Band	Radiated TCs	Conducted TCs
CDMA2000 BC10	<ul style="list-style-type: none"> ■ 1xRTT Link ■ 1xEV-DO Rev. 0 Link 	<ul style="list-style-type: none"> ■ 1xRTT Link ■ 1xEV-DO Rev. 0 Link

The conducted power table is as follows:

Conducted Power (*Unit: dBm)			
Band	CDMA2000 BC10		
	476	580	684
Channel	476	580	684
Frequency	817.90	820.50	823.10
1xRTT RC1 SO55	23.37	23.30	23.04
1xRTT RC3 SO55	23.35	23.28	23.02
1xRTT RC3 SO32 (+ F-SCH)	23.33	23.33	23.08
1xRTT RC3 SO32 (+SCH)	23.39	23.30	23.04
1xEV-DO RTAP 153.6kbps	23.40	23.36	23.10
1xEV-DO RETAP 4096Bits	23.30	23.27	23.07

2.2 Connection Diagram of Test System

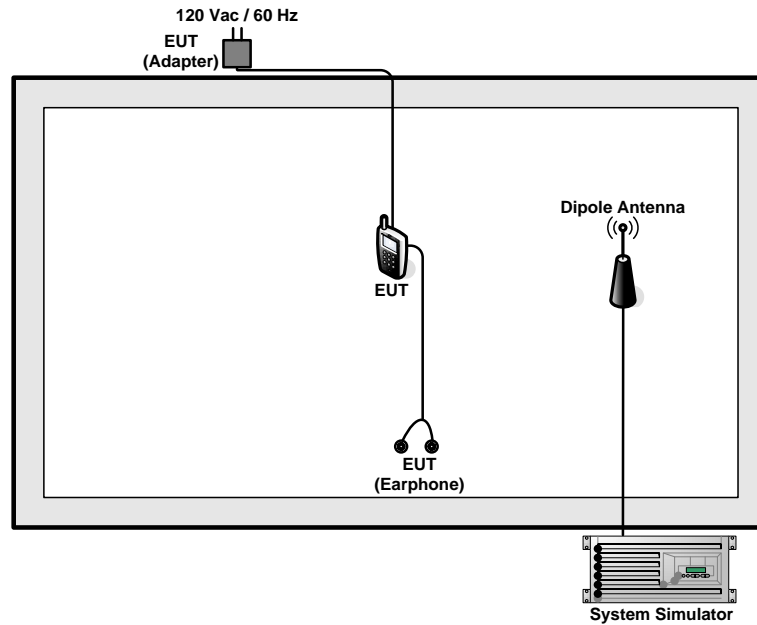

2.3 Support Unit used in test configuration

Item	Equipment	Trade Name	Model No.	FCC ID	Data Cable	Power Cord
1.	System Simulator	R&S	CMU 200	N/A	N/A	Unshielded, 1.8 m

2.4 Measurement Results Explanation Example

For all conducted test items:

The offset level is set in the spectrum analyzer to compensate the RF cable loss and attenuator factor between RF conducted output port and spectrum analyzer. With the offset compensation, the spectrum analyzer reading level will be exactly the RF output level.

The spectrum analyzer offset is derived from RF cable loss and attenuator factor.

Offset = RF cable loss + attenuator factor.

The following shows an offset computation example with RF cable loss 4.2 dB and a 10dB attenuator.

Example :

$$\begin{aligned} \text{Offset(dB)} &= \text{RF cable loss(dB)} + \text{attenuator factor(dB)} \\ &= 4.2 + 10 = 14.2 \text{ (dB)} \end{aligned}$$

3 Test Result

3.1 Conducted Output Power Measurement

3.1.1 Description of the Conducted Output Power Measurement

A system simulator was used to establish communication with the EUT. Its parameters were set to enforce EUT transmitting at the maximum power. The measured power in the radio frequency on the transmitter output terminals shall be reported.

3.1.2 Measuring Instruments

The measuring equipment is listed in the section 4 of this test report.

3.1.3 Test Procedures

1. The transmitter output port was connected to the system simulator.
2. Set EUT at maximum power through system simulator.
3. Select lowest, middle, and highest channels for each band and different modulation.
4. Measure the maximum burst average power for GSM and maximum average power for other modulation signal.

3.1.4 Test Setup

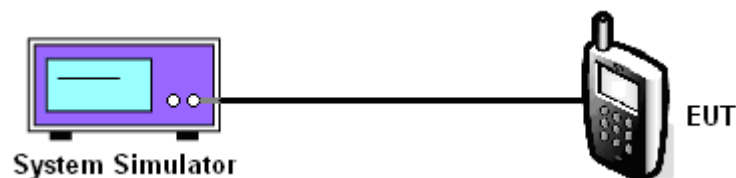



3.1.5 Test Result of Conducted Output Power

CDMA 2000 BC10			
Modes	CDMA 2000 1xRTT		
Test Status	RC3 SO32(+SCH)		
Channel	476 (Low)	580 (Mid)	684 (High)
Frequency (MHz)	817.9	820.5	823.1
Conducted Power (dBm)	23.39	23.30	23.04

CDMA 2000 BC10			
Modes	CDMA 2000 1xEV-DO Rev. 0		
Test Status	RTAP 153.6K		
Channel	476 (Low)	580 (Mid)	684 (High)
Frequency (MHz)	817.9	820.5	823.1
Conducted Power (dBm)	23.40	23.36	23.10

Note: maximum average power for CDMA2000.

3.2 Bandwidth Limitations Measurement

3.2.1 Description of (Occupied) Bandwidth Limitations Measurement

The 99% occupied bandwidth is the width of a frequency band such that, below the lower and above the upper frequency limits, the mean powers emitted are each equal to a specified percentage 0.5% of the total mean transmitted power.

The emission bandwidth is defined as the width of the signal between two points, located at the 2 sides of the carrier frequency, outside of which all emissions are attenuated at least 26 dB below the transmitter power.

3.2.2 Measuring Instruments

The measuring equipment is listed in the section 4 of this test report.

3.2.3 Test Procedures

1. The EUT was connected to the spectrum analyzer and system simulator via a power divider.
2. The RF output of the EUT was connected to the spectrum analyzer by RF cable and attenuator. The path loss was compensated to the results for each measurement.
3. The 99% occupied bandwidth were measured, set RBW= 1% of span, VBW \geq 3*RBW, sample detector, trace maximum hold.
4. The 26dB bandwidth were measured, set RBW= 1% of EBW, VBW \geq 3*RBW, peak detector, trace maximum hold.

3.2.4 Test Setup

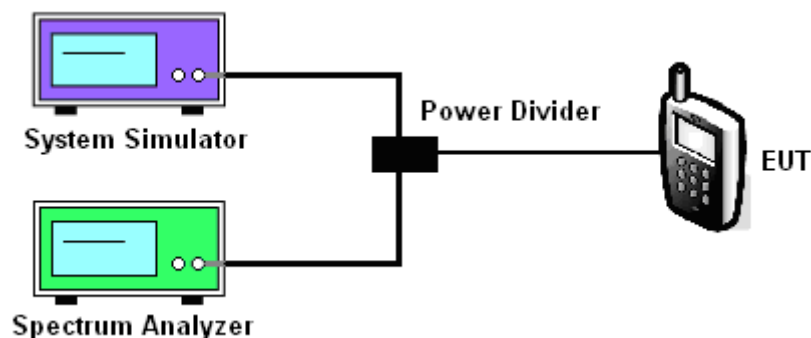



3.2.5 Test Result of Occupied Bandwidth and 26dB Bandwidth

CDMA2000 BC10			
Test Mode	CDMA 2000 1xRTT		
Test Status	RC3 SO32(+SCH)		
Channel	476 (Low)	580 (Mid)	684 (High)
Frequency (MHz)	817.9	820.5	823.1
99% OBW (MHz)	1.28	1.28	1.28
26dB BW (MHz)	1.41	1.42	1.43

CDMA2000 BC10			
Test Mode	CDMA 2000 1xEV-DO Rev. 0		
Test Status	RTAP 153.6K		
Channel	476 (Low)	580 (Mid)	684 (High)
Frequency (MHz)	817.9	820.5	823.1
99% OBW (MHz)	1.28	1.28	1.29
26dB BW (MHz)	1.41	1.41	1.43



3.2.6 Test Result (Plots) of Occupied Bandwidth and 26dB Bandwidth

Band :	CDMA2000 BC 10	Test Mode :	1xRTT_RC3 SO32(+SCH)
--------	----------------	-------------	----------------------

99% Occupied Bandwidth Plot on Channel 476 (817.9 MHz)

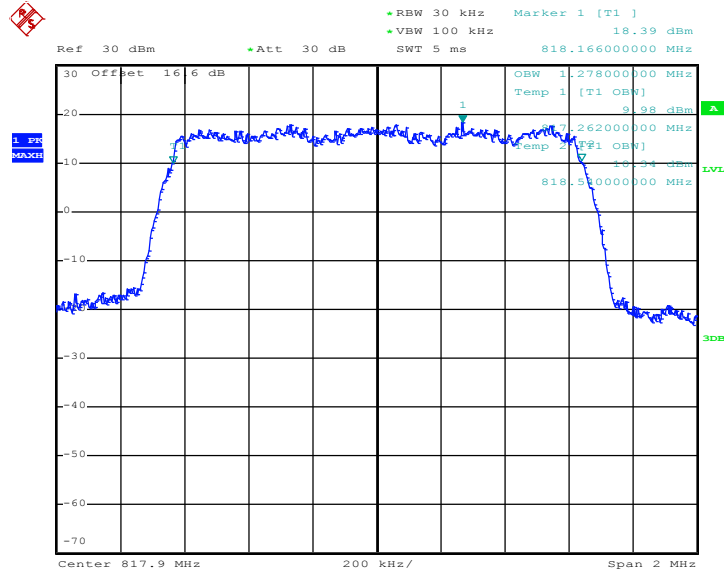

Date: 14.MAY.2015 17:01:53

26dB Bandwidth Plot on Channel 476 (817.9 MHz)

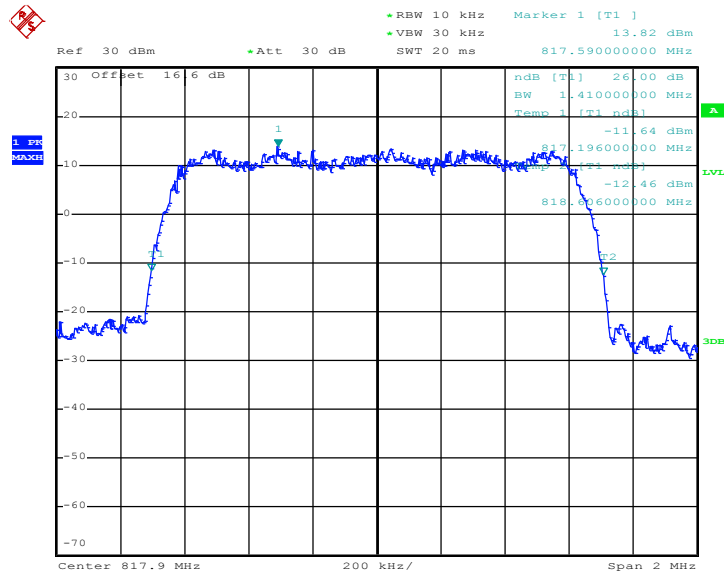

Date: 14.MAY.2015 17:00:10



99% Occupied Bandwidth Plot on Channel 580 (820.5 MHz)

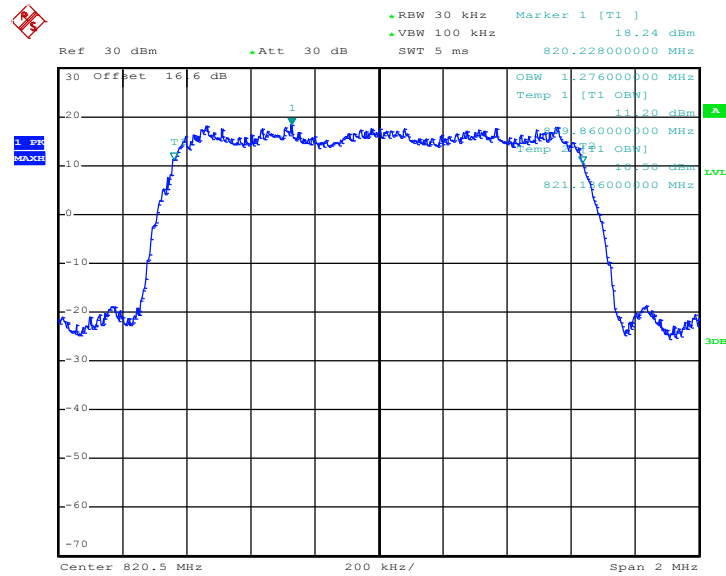

Date: 14.MAY.2015 17:02:24

26dB Bandwidth Plot on Channel 580 (820.5 MHz)

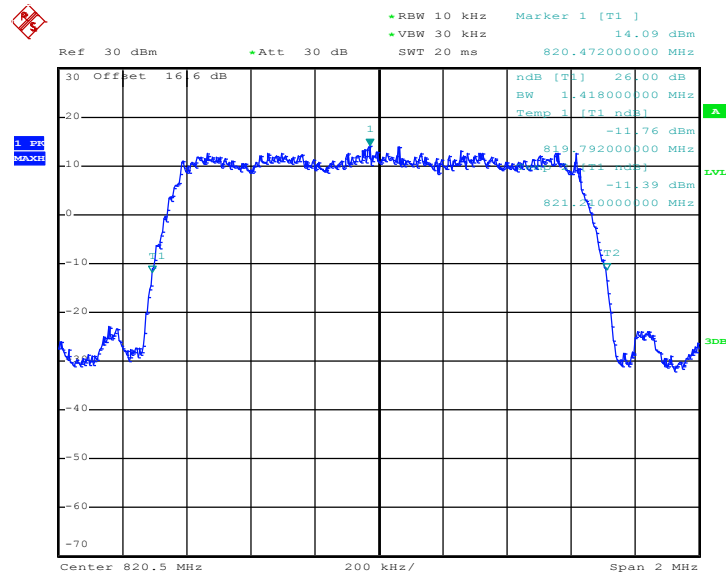

Date: 14.MAY.2015 17:00:39



99% Occupied Bandwidth Plot on Channel 684 (823.1 MHz)

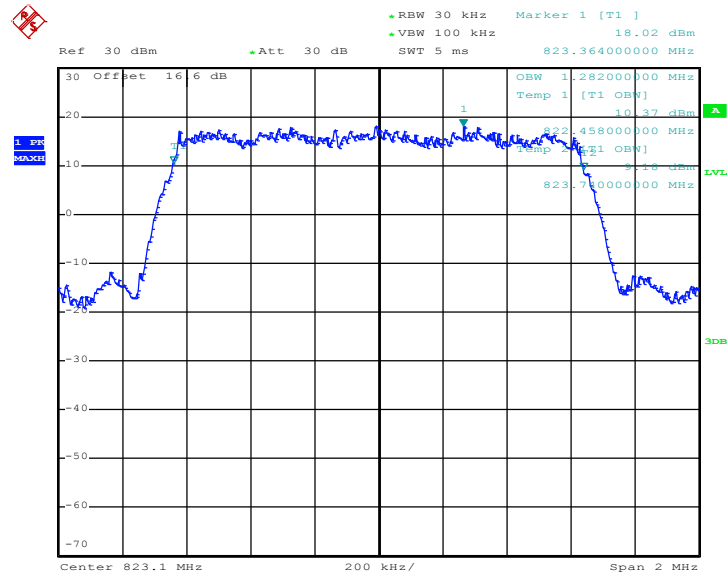

Date: 14.MAY.2015 17:02:54

26dB Bandwidth Plot on Channel 684 (823.1 MHz)

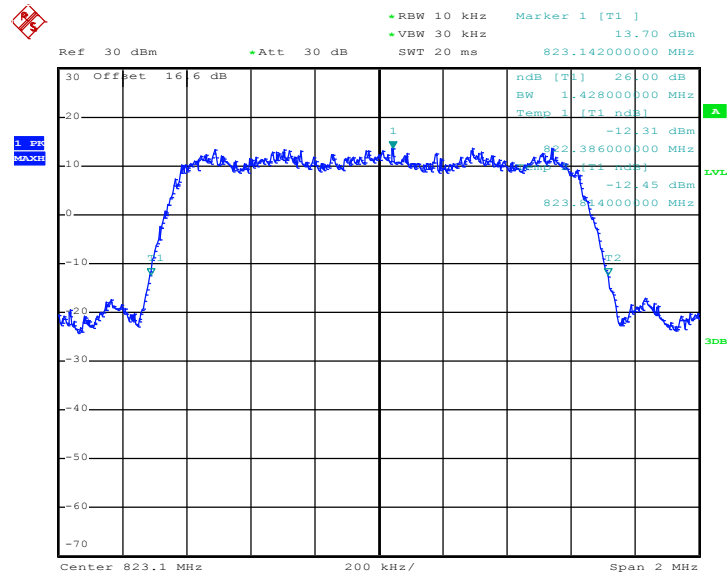

Date: 14.MAY.2015 17:01:12



Band :	CDMA2000 BC 10	Test Mode :	1xEV-DO Rev. 0_RTAP 153.6K
--------	----------------	-------------	----------------------------

99% Occupied Bandwidth Plot on Channel 476 (817.9 MHz)

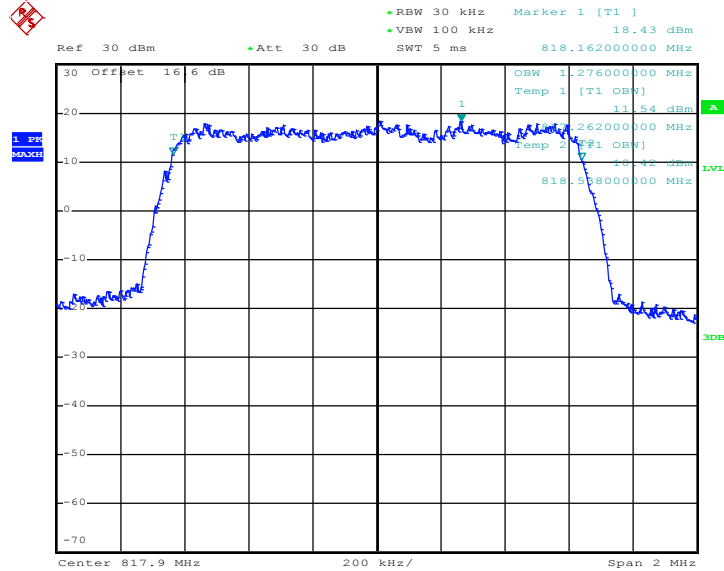

Date: 27.MAY.2015 17:14:45

26dB Bandwidth Plot on Channel 476 (817.9 MHz)

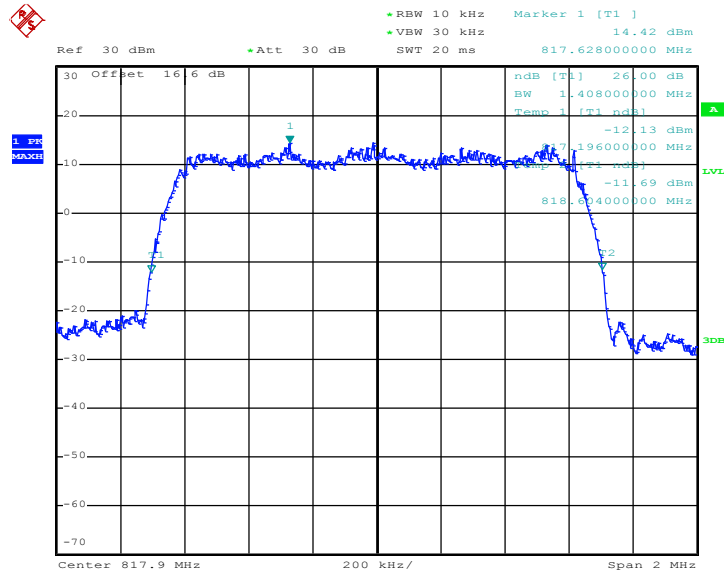

Date: 14.MAY.2015 17:17:10



99% Occupied Bandwidth Plot on Channel 580 (820.5 MHz)

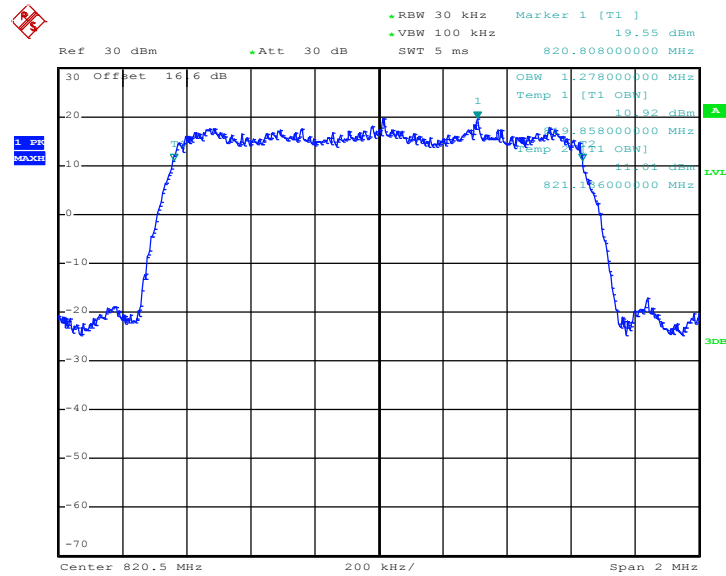

Date: 27.MAY.2015 17:15:18

26dB Bandwidth Plot on Channel 580 (820.5 MHz)

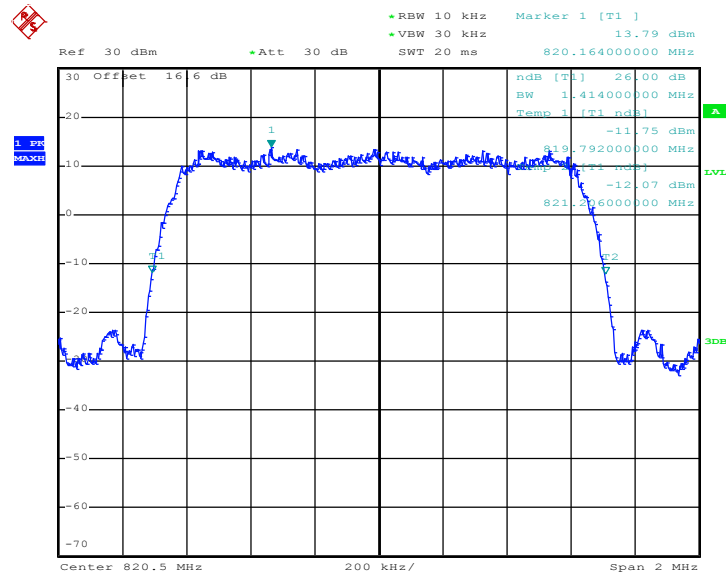

Date: 14.MAY.2015 17:17:51



99% Occupied Bandwidth Plot on Channel 684 (823.1 MHz)

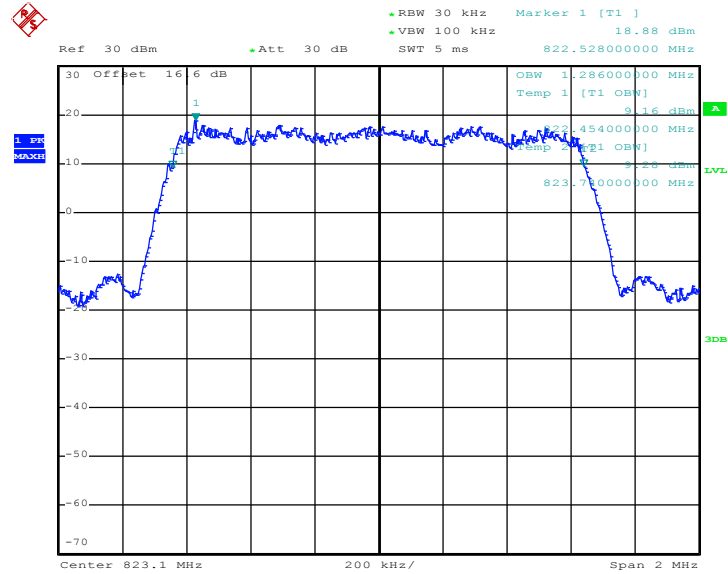

Date: 27.MAY.2015 17:15:49

26dB Bandwidth Plot on Channel 684 (823.1 MHz)

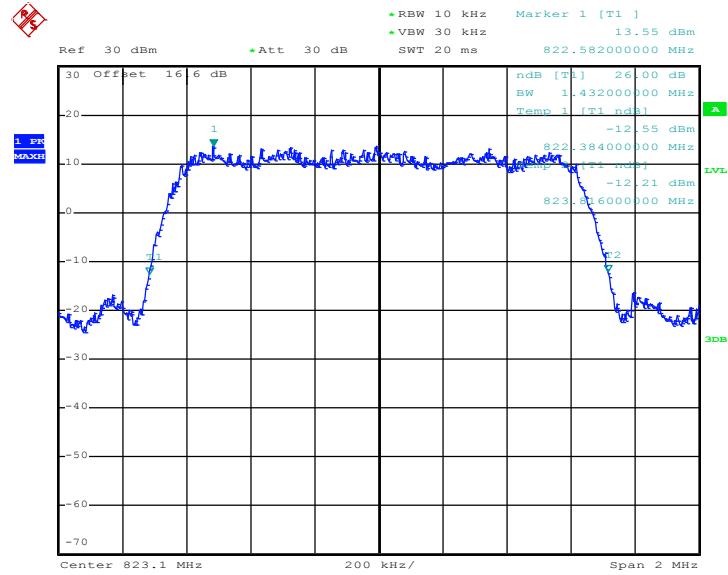

Date: 14.MAY.2015 17:18:28

3.3 Emissions Mask Measurement

3.3.1 Description of Emissions Mask Measurement

Equipment used in this licensed to EA or non-EA systems shall comply with the emission mask provisions of FCC Part 90.691.(a)(1)

(a). Out-of-band emission requirement shall apply only to the “outer” channels included in an EA license and to spectrum adjacent to interior channels used by incumbent licensees. The emission limits are as follows:

- (1) For any frequency removed from the EA licensee's frequency block by up to and including 37.5 kHz, the power of any emission shall be attenuated below the transmitter power (P) in watts by at least $116 \text{ Log}_{10}(f/6.1)$ decibels or $50 + 10 \text{ Log}_{10}(P)$ decibels or 80 decibels, whichever is the lesser attenuation, where f is the frequency removed from the center of the outer channel in the block in kilohertz and where f is greater than 12.5 kHz.

3.3.2 Measuring Instruments

The measuring equipment is listed in the section 4 of this test report.

3.3.3 Test Procedures

1. The EUT was connected to spectrum analyzer and system simulator via power divider.
2. The emissions mask of low and high channels for the highest RF powers were measured.
3. The measured RBW and the VBW set 3 times of RBW are then set in spectrum analyzer, and the RBW correction factor $10 \log (1\% \text{ of OBW}/\text{measured RBW})(\text{dB})$ was compensated, if required.
4. The test results were shown below plots with a correction offset factor including cable loss, insertion loss of power divider.

3.3.4 Test Setup

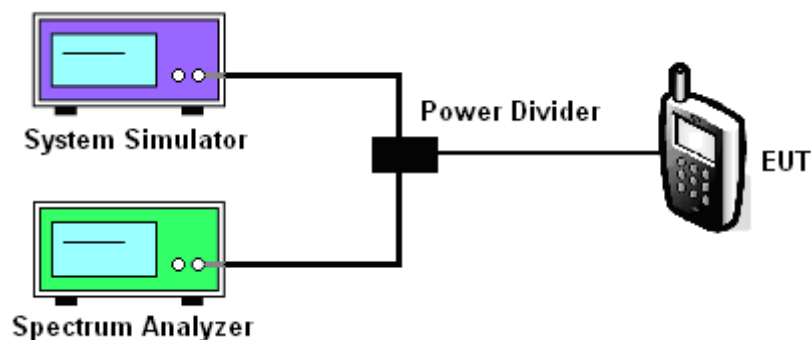



3.3.5 Test Result (Plots) of Conducted Emissions Mask

Band :	CDMA2000 BC 10	Test Mode :	1xRTT_RC3 SO32(+SCH)
--------	----------------	-------------	----------------------

Lower Band Edge Plot on Channel 476 (817.9 MHz)

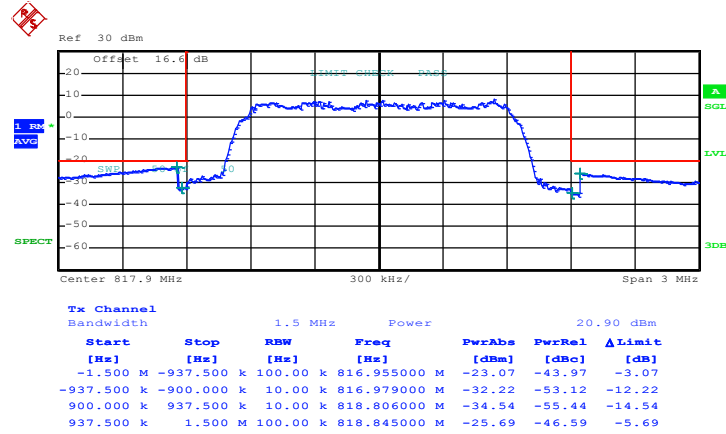

Date: 27.MAY.2015 16:12:24

Remark:

Test Result(dBm)

$$= \text{PwrAbs(dBm)} + (1\% \text{ of OBW/measured RBW}) \text{ (dB)}$$

$$= \text{PwrAbs(dBm)} + 10 * \text{LOG}(13\text{kHz}/10\text{kHz}) \text{ (dB)}$$

$$= \text{PwrAbs(dBm)} + 1.14 \text{ (dB)}$$

- <1> Test result of 816.979MHz:
-32.22 (dBm) + 1.14 (dB) = -31.08 (dBm)
- <2> Test result of 818.806MHz:
-34.54 (dBm) + 1.14 (dB) = -33.40 (dBm)



Higher Band Edge Plot on Channel 684 (823.1 MHz)

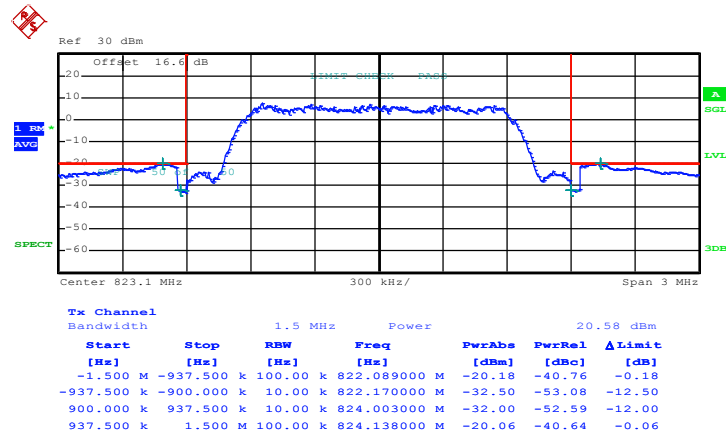

Date: 27.MAY.2015 16:26:48

Remark:

Test Result(dBm)

$$= \text{PwrAbs(dBm)} + (1\% \text{ of OBW/measured RBW}) \text{ (dB)}$$

$$= \text{PwrAbs(dBm)} + 10 \cdot \text{LOG}(13\text{kHz}/10\text{kHz}) \text{ (dB)}$$

$$= \text{PwrAbs(dBm)} + 1.14 \text{ (dB)}$$

<1> Test result of 822.170MHz:

$$-32.50 \text{ (dBm)} + 1.14 \text{ (dB)} = -31.36 \text{ (dBm)}$$

<2> Test result of 824.003MHz:

$$-32.00 \text{ (dBm)} + 1.14 \text{ (dB)} = -30.86 \text{ (dBm)}$$



Band :	CDMA2000 BC 10	Test Mode :	1xEV-DO Rev. 0_RTAP 153.6K
--------	----------------	-------------	----------------------------

Lower Band Edge Plot on Channel 476 (817.9 MHz)

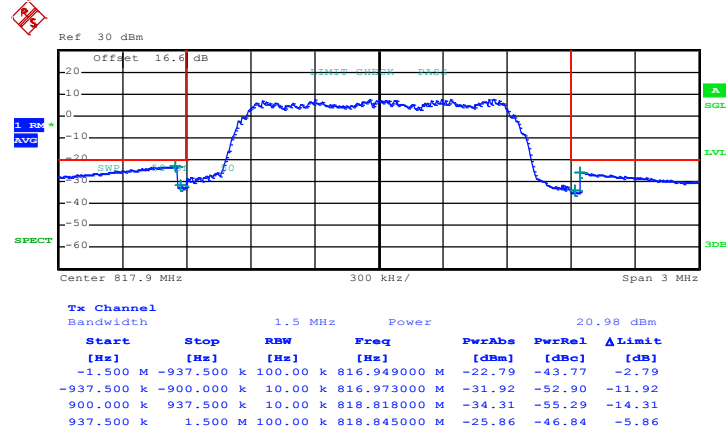

Date: 27.MAY.2015 16:13:09

Remark:

Test Result(dBm)

$$= \text{PwrAbs(dBm)} + (1\% \text{ of OBW/measured RBW}) \text{ (dB)}$$

$$= \text{PwrAbs(dBm)} + 10 \cdot \text{LOG}(13\text{kHz}/10\text{kHz}) \text{ (dB)}$$

$$= \text{PwrAbs(dBm)} + 1.14 \text{ (dB)}$$

<1> Test result of 816.973MHz:

$$-31.92 \text{ (dBm)} + 1.14 \text{ (dB)} = -30.78 \text{ (dBm)}$$

<2> Test result of 818.818MHz:

$$-34.31 \text{ (dBm)} + 1.14 \text{ (dB)} = -33.17 \text{ (dBm)}$$



Higher Band Edge Plot on Channel 684 (823.1 MHz)

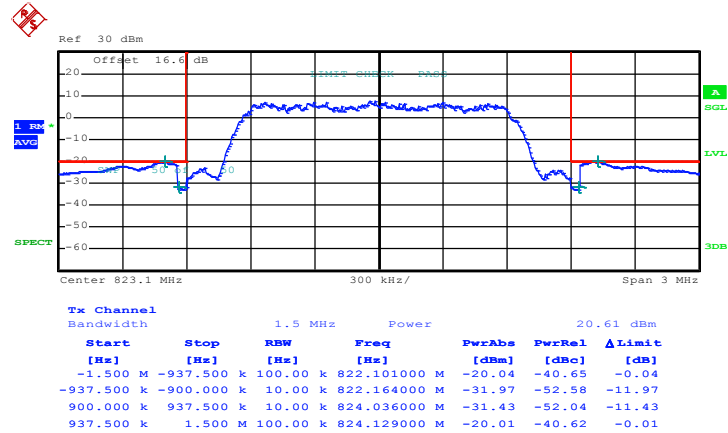

Date: 27.MAY.2015 16:28:37

Remark:

Test Result(dBm)

$$= \text{PwrAbs(dBm)} + (1\% \text{ of OBW/measured RBW}) \text{ (dB)}$$

$$= \text{PwrAbs(dBm)} + 10 * \text{LOG}(13\text{kHz}/10\text{kHz}) \text{ (dB)}$$

$$= \text{PwrAbs(dBm)} + 1.14 \text{ (dB)}$$

<1> Test result of 822.164MHz:

$$-31.97 \text{ (dBm)} + 1.14 \text{ (dB)} = -30.83 \text{ (dBm)}$$

<2> Test result of 824.036MHz:

$$-31.43 \text{ (dBm)} + 1.14 \text{ (dB)} = -30.39 \text{ (dBm)}$$

3.4 Emissions Mask – Out Of Band Emissions Measurement

3.4.1 Description of Conducted Spurious Emissions Out of band emissions measurement

The power of any emission FCC Part 90.691 (a)(2) on any frequency removed from the assigned frequency by more than 250 percent of the authorized bandwidth at least $43 + 10 \log(P)$ dB.

It is measured by means of a calibrated spectrum analyzer and scanned from 30 MHz up to a frequency including its 10th harmonic.

3.4.2 Measuring Instruments

The measuring equipment is listed in the section 4 of this test report.

3.4.3 Test Procedures

1. The EUT was connected to the spectrum analyzer and system simulator via a power divider.
2. The RF output of EUT was connected to the spectrum analyzer by an RF cable and attenuator. The path loss was compensated to the results for each measurement.
3. The middle channel for the highest RF power within the transmitting frequency was measured.
4. The conducted spurious emission for the whole frequency range was taken.
5. The RF fundamental frequency should be excluded against the limit line in the operating frequency band.
6. The limit line is derived from $43 + 10\log(P)$ dB below the transmitter power P(Watts)
 - = $P(W) - [43 + 10\log(P)]$ (dB)
 - = $[30 + 10\log(P)]$ (dBm) - $[43 + 10\log(P)]$ (dB)
 - = -13dBm.

3.4.4 Test Setup

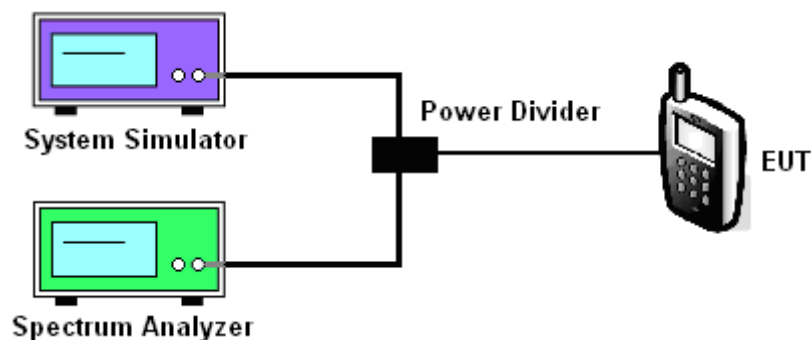



3.4.5 Test Result (Plots) of Conducted Spurious Emission

Band :	CDMA2000 BC 10	Test Mode :	1xRTT_RC3 SO32(+SCH)
--------	----------------	-------------	----------------------

Conducted Spurious Emission Plot on Channel 476 (817.9 MHz)

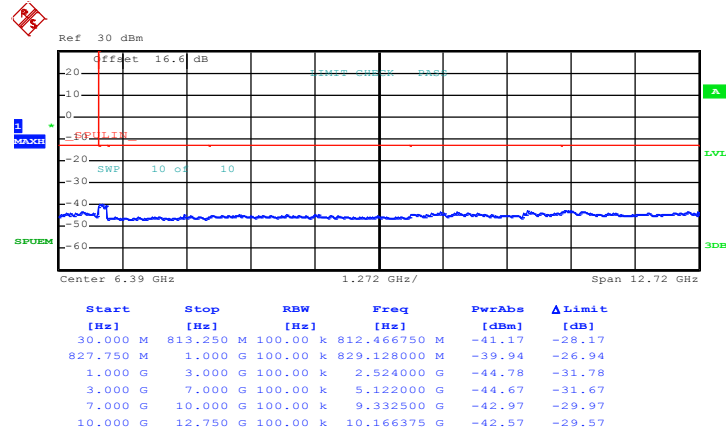

Date: 14.MAY.2015 17:11:51

Conducted Spurious Emission Plot on Channel 580 (820.5 MHz)

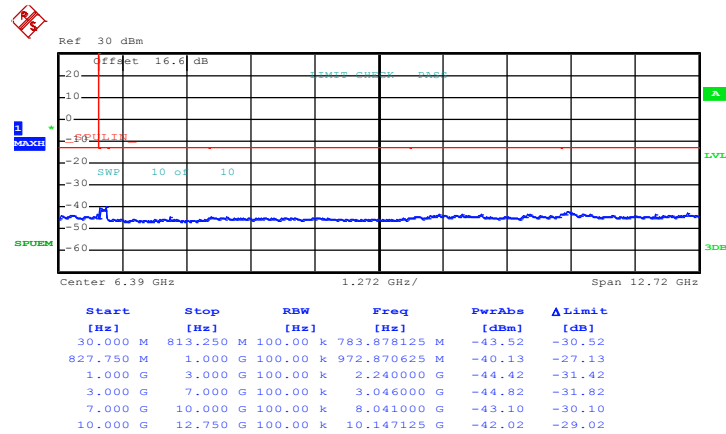

Date: 14.MAY.2015 17:12:43



Conducted Spurious Emission Plot on Channel 684 (823.1 MHz)

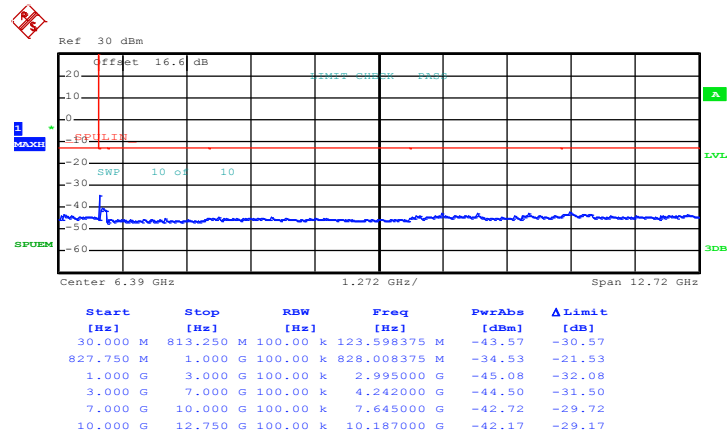

Date: 14.MAY.2015 17:13:27



Band :	CDMA2000 BC 10	Test Mode :	1xEV-DO Rev. 0_RTAP 153.6K
--------	----------------	-------------	----------------------------

Conducted Spurious Emission Plot on Channel 476 (817.9 MHz)

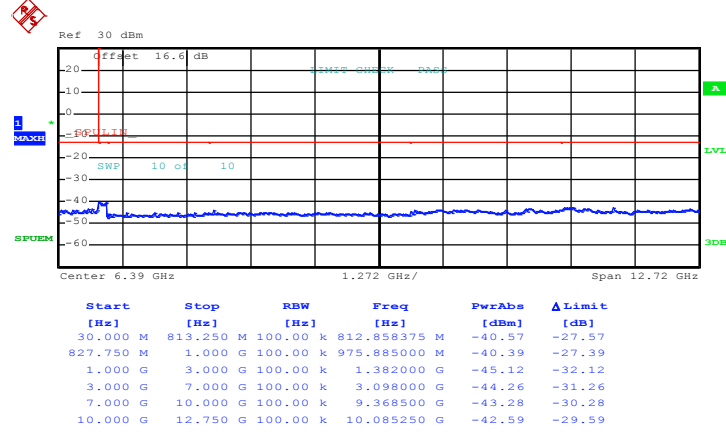

Date: 19.MAY.2015 11:40:43

Conducted Spurious Emission Plot on Channel 580 (820.5 MHz)

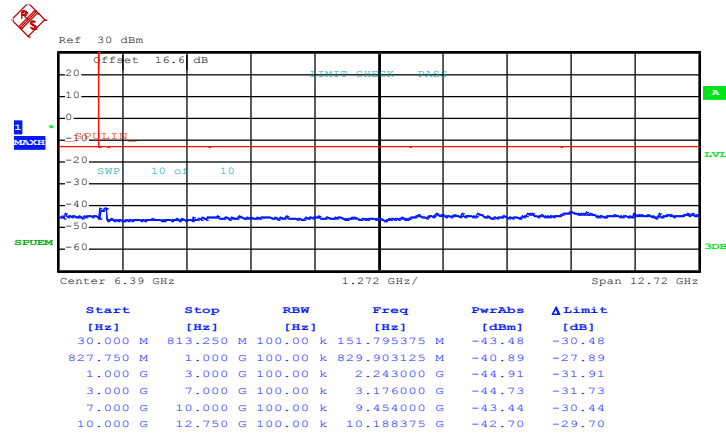

Date: 19.MAY.2015 11:41:34



Conducted Spurious Emission Plot on Channel 684 (823.1 MHz)

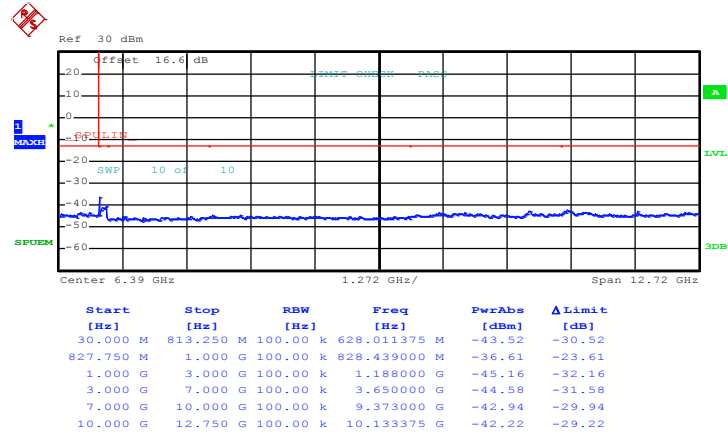

Date: 19.MAY.2015 11:42:28



3.5 Field Strength of Spurious Radiation Measurement

3.5.1 Description of Field Strength of Spurious Radiated Measurement

The radiated spurious emission was measured by substitution method according to ANSI / TIA / EIA-603-C-2004. The power of any emission FCC Part 90.691 on any frequency removed from the assigned frequency by more than 250 percent of the authorized bandwidth at least $43 + 10 \log (P)$ dB. The spectrum is scanned from 30 MHz up to a frequency including its 10th harmonic.

The power of any emission outside of the authorized operating frequency ranges must be attenuated below the transmitter power (P) by a factor of at least $43+10\log_{10}(P[\text{Watts}])$ dB. The spectrum is scanned from 30 MHz up to a frequency including its 10th harmonic.

3.5.2 Measuring Instruments

The measuring equipment is listed in the section 4 of this test report.

3.5.3 Test Procedures

1. The EUT was placed on a rotatable wooden table with 0.8 meter about ground.
2. The EUT was set 3 meters from the receiving antenna, which was mounted on the antenna tower.
3. The table was rotated 360 degrees to determine the position of the highest spurious emission.
4. The height of the receiving antenna is varied between one meter and four meters to search the maximum spurious emission for both horizontal and vertical polarizations.
5. Make the measurement with the spectrum analyzer's RBW = 1MHz, VBW = 3MHz, Sweep = 500ms, Taking the record of maximum spurious emission.
6. A horn antenna was substituted in place of the EUT and was driven by a signal generator.
7. Tune the output power of signal generator to the same emission level with EUT maximum spurious emission.
8. Taking the record of output power at antenna port.
9. Repeat step 7 to step 8 for another polarization.
10. $\text{EIRP (dBm)} = \text{S.G. Power} - \text{Tx Cable Loss} + \text{Tx Antenna Gain}$
11. $\text{ERP (dBm)} = \text{EIRP} - 2.15$
12. The RF fundamental frequency should be excluded against the limit line in the operating frequency band.
13. The limit line is derived from $43 + 10\log(P)$ dB below the transmitter power P(Watts)
 $= P(W) - [43 + 10\log(P)]$ (dB)
 $= [30 + 10\log(P)]$ (dBm) - $[43 + 10\log(P)]$ (dB)
 $= -13\text{dBm}$.

3.5.4 Test Setup

For radiated emissions from 30MHz to 1GHz

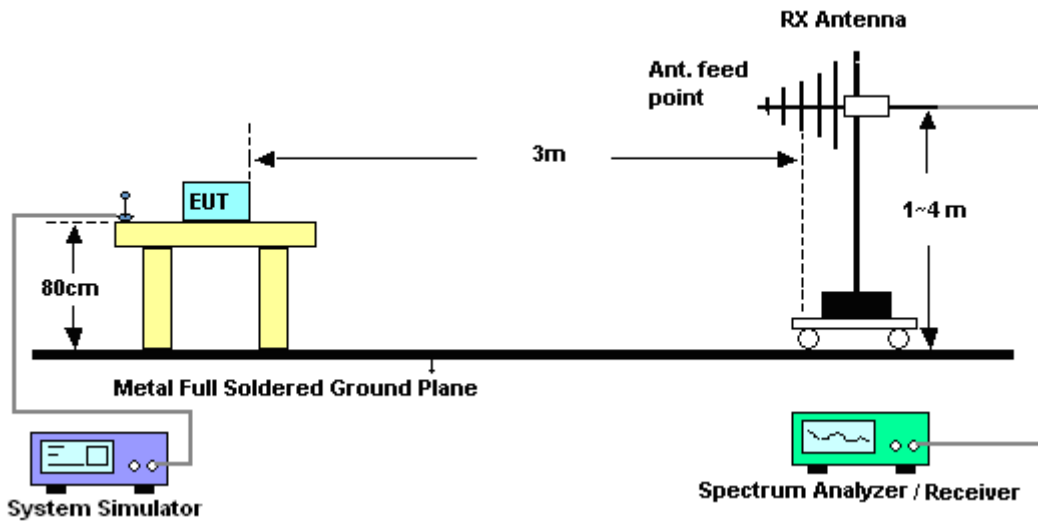

For radiated emissions above 1GHz

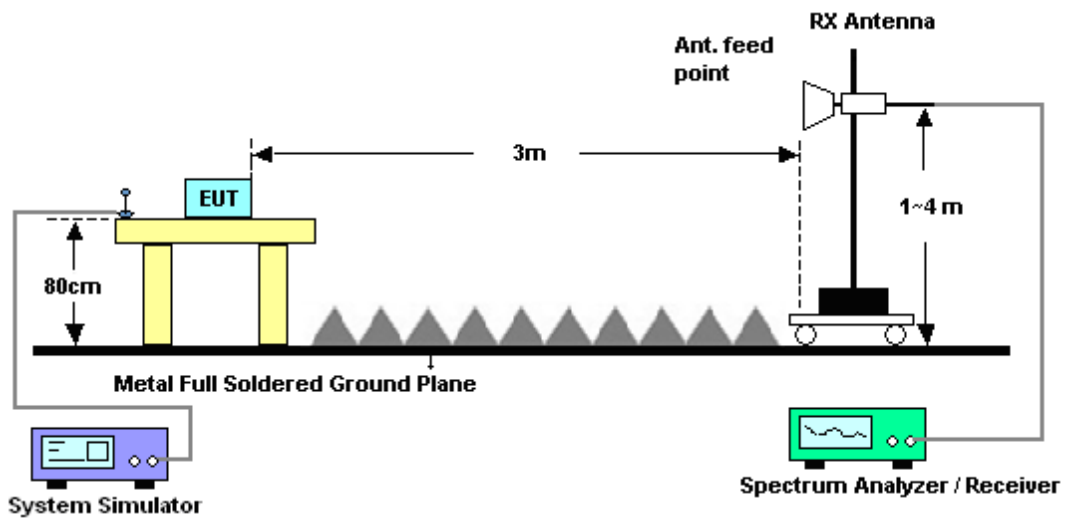



3.5.5 Test Result of Field Strength of Spurious Radiated

<Low Channel>

Band :	CDMA2000 BC10					Temperature :	22~24°C		
Test Mode :	1xRTT_RC3 SO32(+SCH)					Relative Humidity :	51~53%		
Test Engineer :	Nick Yu, Ken Wu, and James Chiu					Polarization :	Horizontal		
Remark :	Spurious emissions within 30-1000MHz were found more than 20dB below limit line.								
Frequency (MHz)	ERP (dBm)	Limit (dBm)	Over Limit (dB)	SPA Reading (dBm)	S.G. Power (dBm)	TX Cable loss (dB)	TX Antenna Gain (dBi)	Polarization (H/V)	Result
1632	-58.40	-13	-45.40	-68.86	-60.21	0.97	4.93	H	Pass
2456	-57.03	-13	-44.03	-72.5	-58.87	1.28	5.27	H	Pass
3272	-60.07	-13	-47.07	-76.87	-63.38	1.53	7.00	H	Pass

Band :	CDMA2000 BC10					Temperature :	22~24°C		
Test Mode :	1xRTT_RC3 SO32(+SCH)					Relative Humidity :	51~53%		
Test Engineer :	Nick Yu, Ken Wu, and James Chiu					Polarization :	Vertical		
Remark :	Spurious emissions within 30-1000MHz were found more than 20dB below limit line.								
Frequency (MHz)	ERP (dBm)	Limit (dBm)	Over Limit (dB)	SPA Reading (dBm)	S.G. Power (dBm)	TX Cable loss (dB)	TX Antenna Gain (dBi)	Polarization (H/V)	Result
1632	-57.51	-13	-44.51	-68.75	-59.32	0.97	4.93	V	Pass
2456	-52.77	-13	-39.77	-69.68	-54.61	1.28	5.27	V	Pass
3272	-58.41	-13	-45.41	-76.83	-61.72	1.53	7.00	V	Pass



<Middle Channel>

Band :	CDMA2000 BC10						Temperature :	22~24°C	
Test Mode :	1xRTT_RC3 SO32(+SCH)						Relative Humidity :	51~53%	
Test Engineer :	Nick Yu, Ken Wu, and James Chiu						Polarization :	Horizontal	
Remark :	Spurious emissions within 30-1000MHz were found more than 20dB below limit line.								
Frequency (MHz)	ERP (dBm)	Limit (dBm)	Over Limit (dB)	SPA Reading (dBm)	S.G. Power (dBm)	TX Cable loss (dB)	TX Antenna Gain (dBi)	Polarization (H/V)	Result
1640	-59.56	-13	-46.56	-70.1	-61.34	0.97	4.91	H	Pass
2464	-55.63	-13	-42.63	-71.68	-57.49	1.28	5.29	H	Pass
3282	-59.84	-13	-46.84	-76.71	-63.19	1.54	7.04	H	Pass

Band :	CDMA2000 BC10						Temperature :	22~24°C	
Test Mode :	1xRTT_RC3 SO32(+SCH)						Relative Humidity :	51~53%	
Test Engineer :	Nick Yu, Ken Wu, and James Chiu						Polarization :	Vertical	
Remark :	Spurious emissions within 30-1000MHz were found more than 20dB below limit line.								
Frequency (MHz)	ERP (dBm)	Limit (dBm)	Over Limit (dB)	SPA Reading (dBm)	S.G. Power (dBm)	TX Cable loss (dB)	TX Antenna Gain (dBi)	Polarization (H/V)	Result
1640	-58.85	-13	-45.85	-69.87	-60.63	0.97	4.91	V	Pass
2464	-53.65	-13	-40.65	-70.9	-55.51	1.28	5.29	V	Pass
3282	-58.24	-13	-45.24	-76.7	-61.59	1.54	7.04	V	Pass



<High Channel>

Band :	CDMA2000 BC10						Temperature :	22~24°C	
Test Mode :	1xRTT_RC3 SO32(+SCH)						Relative Humidity :	51~53%	
Test Engineer :	Nick Yu, Ken Wu, and James Chiu						Polarization :	Horizontal	
Remark :	Spurious emissions within 30-1000MHz were found more than 20dB below limit line.								
Frequency (MHz)	ERP (dBm)	Limit (dBm)	Over Limit (dB)	SPA Reading (dBm)	S.G. Power (dBm)	TX Cable loss (dB)	TX Antenna Gain (dBi)	Polarization (H/V)	Result
1648	-59.58	-13	-46.58	-70.45	-61.34	0.98	4.89	H	Pass
2472	-59.01	-13	-46.01	-75.06	-60.89	1.28	5.32	H	Pass
3288	-59.80	-13	-46.80	-76.6	-63.18	1.54	7.07	H	Pass

Band :	CDMA2000 BC10						Temperature :	22~24°C	
Test Mode :	1xRTT_RC3 SO32(+SCH)						Relative Humidity :	51~53%	
Test Engineer :	Nick Yu, Ken Wu, and James Chiu						Polarization :	Vertical	
Remark :	Spurious emissions within 30-1000MHz were found more than 20dB below limit line.								
Frequency (MHz)	ERP (dBm)	Limit (dBm)	Over Limit (dB)	SPA Reading (dBm)	S.G. Power (dBm)	TX Cable loss (dB)	TX Antenna Gain (dBi)	Polarization (H/V)	Result
1648	-58.93	-13	-45.93	-70.6	-60.69	0.98	4.89	V	Pass
2472	-53.10	-13	-40.10	-70.76	-54.98	1.28	5.32	V	Pass
3288	-58.43	-13	-45.43	-76.92	-61.81	1.54	7.07	V	Pass



<Low Channel>

Band :	CDMA2000 BC10						Temperature :	22~24°C	
Test Mode :	1xEV-DO Rev. 0_RTAP 153.6K						Relative Humidity :	51~53%	
Test Engineer :	Nick Yu, Ken Wu, and James Chiu						Polarization :	Horizontal	
Remark :	Spurious emissions within 30-1000MHz were found more than 20dB below limit line.								
Frequency (MHz)	ERP (dBm)	Limit (dBm)	Over Limit (dB)	SPA Reading (dBm)	S.G. Power (dBm)	TX Cable loss (dB)	TX Antenna Gain (dBi)	Polarization (H/V)	Result
1632	-58.91	-13	-45.91	-69.73	-60.72	0.97	4.93	H	Pass
2456	-59.77	-13	-46.77	-75.5	-61.61	1.28	5.27	H	Pass
3272	-59.86	-13	-46.86	-76.56	-63.17	1.53	7.00	H	Pass

Band :	CDMA2000 BC10						Temperature :	22~24°C	
Test Mode :	1xEV-DO Rev. 0_RTAP 153.6K						Relative Humidity :	51~53%	
Test Engineer :	Nick Yu, Ken Wu, and James Chiu						Polarization :	Vertical	
Remark :	Spurious emissions within 30-1000MHz were found more than 20dB below limit line.								
Frequency (MHz)	ERP (dBm)	Limit (dBm)	Over Limit (dB)	SPA Reading (dBm)	S.G. Power (dBm)	TX Cable loss (dB)	TX Antenna Gain (dBi)	Polarization (H/V)	Result
1632	-57.82	-13	-44.82	-69.02	-59.63	0.97	4.93	V	Pass
2456	-56.63	-13	-43.63	-73.79	-58.47	1.28	5.27	V	Pass
3272	-58.40	-13	-45.40	-76.82	-61.71	1.53	7.00	V	Pass



<Middle Channel>

Band :	CDMA2000 BC10					Temperature :	22~24°C		
Test Mode :	1xEV-DO Rev. 0_RTAP 153.6K					Relative Humidity :	51~53%		
Test Engineer :	Nick Yu, Ken Wu, and James Chiu					Polarization :	Horizontal		
Remark :	Spurious emissions within 30-1000MHz were found more than 20dB below limit line.								
Frequency (MHz)	ERP (dBm)	Limit (dBm)	Over Limit (dB)	SPA Reading (dBm)	S.G. Power (dBm)	TX Cable loss (dB)	TX Antenna Gain (dBi)	Polarization (H/V)	Result
1640	-59.68	-13	-46.68	-70.61	-61.46	0.97	4.91	H	Pass
2464	-59.72	-13	-46.72	-75.77	-61.58	1.28	5.29	H	Pass
3280	-60.13	-13	-47.13	-77	-63.48	1.54	7.03	H	Pass

Band :	CDMA2000 BC10					Temperature :	22~24°C		
Test Mode :	1xEV-DO Rev. 0_RTAP 153.6K					Relative Humidity :	51~53%		
Test Engineer :	Nick Yu, Ken Wu, and James Chiu					Polarization :	Vertical		
Remark :	Spurious emissions within 30-1000MHz were found more than 20dB below limit line.								
Frequency (MHz)	ERP (dBm)	Limit (dBm)	Over Limit (dB)	SPA Reading (dBm)	S.G. Power (dBm)	TX Cable loss (dB)	TX Antenna Gain (dBi)	Polarization (H/V)	Result
1640	-58.88	-13	-45.88	-70.57	-60.66	0.97	4.91	V	Pass
2464	-58.55	-13	-45.55	-76.16	-60.41	1.28	5.29	V	Pass
3280	-58.47	-13	-45.47	-76.93	-61.82	1.54	7.03	V	Pass



<High Channel>

Band :	CDMA2000 BC10						Temperature :	22~24°C	
Test Mode :	1xEV-DO Rev. 0_RTAP 153.6K						Relative Humidity :	51~53%	
Test Engineer :	Nick Yu, Ken Wu, and James Chiu						Polarization :	Horizontal	
Remark :	Spurious emissions within 30-1000MHz were found more than 20dB below limit line.								
Frequency (MHz)	ERP (dBm)	Limit (dBm)	Over Limit (dB)	SPA Reading (dBm)	S.G. Power (dBm)	TX Cable loss (dB)	TX Antenna Gain (dBi)	Polarization (H/V)	Result
1648	-60.16	-13	-47.16	-71.07	-61.92	0.98	4.89	H	Pass
2472	-60.73	-13	-47.73	-76.52	-62.61	1.28	5.32	H	Pass
3288	-59.75	-13	-46.75	-76.55	-63.13	1.54	7.07	H	Pass

Band :	CDMA2000 BC10						Temperature :	22~24°C	
Test Mode :	1xEV-DO Rev. 0_RTAP 153.6K						Relative Humidity :	51~53%	
Test Engineer :	Nick Yu, Ken Wu, and James Chiu						Polarization :	Vertical	
Remark :	Spurious emissions within 30-1000MHz were found more than 20dB below limit line.								
Frequency (MHz)	ERP (dBm)	Limit (dBm)	Over Limit (dB)	SPA Reading (dBm)	S.G. Power (dBm)	TX Cable loss (dB)	TX Antenna Gain (dBi)	Polarization (H/V)	Result
1648	-59.40	-13	-46.40	-70.97	-61.16	0.98	4.89	V	Pass
2472	-59.01	-13	-46.01	-76.54	-60.89	1.28	5.32	V	Pass
3288	-58.07	-13	-45.07	-76.56	-61.45	1.54	7.07	V	Pass

3.6 Frequency Stability Measurement

3.6.1 Description of Frequency Stability Measurement

The frequency stability shall be measured by variation of ambient temperature and variation of primary supply voltage to ensure that the fundamental emission stays within the authorized frequency block. The frequency stability of the transmitter shall be maintained within $\pm 0.00025\%$ ($\pm 2.5\text{ppm}$) of the center frequency according to FCC Part 90.213.

3.6.2 Measuring Instruments

The measuring equipment is listed in the section 4 of this test report.

3.6.3 Test Procedures for Temperature Variation

1. The EUT was set up in the thermal chamber and connected with the base station.
2. With power OFF, the temperature was decreased to -30°C and the EUT was stabilized for three hours. Power was applied and the maximum change in frequency was recorded within one minute.
3. With power OFF, the temperature was raised in 10°C step up to 50°C . The EUT was stabilized at each step for at least half an hour. Power was applied and the maximum frequency change was recorded within one minute.

3.6.4 Test Procedures for Voltage Variation

1. The EUT was placed in a temperature chamber at $25\pm 5^{\circ}\text{C}$ and connected with the base station.
2. The power supply voltage to the EUT was varied from BEP to 115% of the nominal value measured at the input to the EUT.
3. The variation in frequency was measured for the worst case.

3.6.5 Test Setup

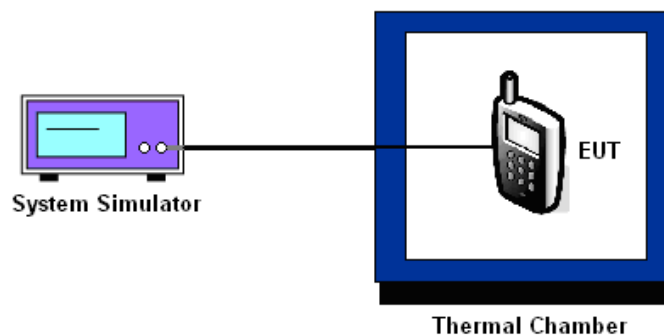



3.6.6 Test Result of Temperature Variation

Band :	CDMA2000 BC10 1xRTT_RC3 SO32(+SCH)	Channel :	580
Limit (ppm) :	2.5	Frequency :	820.5

Temperature (°C)	Deviation (ppm)	Result
50	0.0012	PASS
40	0.0024	
30	0.0012	
20 (Ref.)	0.0000	
10	0.0061	
0	0.0219	
-10	0.0207	
-20	0.0256	
-30	0.0232	

Band :	CDMA2000 BC10 1xEV-DO Rev. 0_RTAP 153.6K	Channel :	580
Limit (ppm) :	2.5	Frequency :	820.5

Temperature (°C)	Deviation (ppm)	Result
50	0.0024	PASS
40	0.0012	
30	0.0012	
20 (Ref.)	0.0000	
10	0.0024	
0	0.0037	
-10	0.0232	
-20	0.0219	
-30	0.0244	



3.6.7 Test Result of Voltage Variation

Band & Channel	Mode	Voltage (Volt)	Deviation (ppm)	Limit (ppm)	Result
CDMA2000 BC10 CH580	1xRTT_RC3 SO32(+SCH)	4.35	0.0232	2.5	PASS
		3.87	0.0219		
		BEP	0.0244		
CDMA2000 BC10 CH580	1xEV-DO Rev. 0_RTAP 153.6K	4.35	0.0256		
		3.87	0.0219		
		BEP	0.0232		

Note:

- 1. Normal Voltage = 3.87V.
- 2. Battery End Point (BEP) = 3.40 V.



4 List of Measuring Equipment

Instrument	Manufacturer	Model No.	Serial No.	Characteristics	Calibration Date	Test Date	Due Date	Remark
Spectrum Analyzer	Rohde & Schwarz	FSP30	101329	9kHz~30GHz	Jun. 14, 2014	May 14, 2015 ~ May 27, 2015	Jun. 13, 2015	Conducted (TH03-HY)
Signal Generator	Rohde & Schwarz	SMU200A	102502	9kHz~6GHz	Jul. 07, 2014	May 14, 2015 ~ May 27, 2015	Jul. 06, 2015	Conducted (TH03-HY)
Temperature Chamber	ESPEC	SU-641	92013721	-30°C~70°C	Dec. 01, 2014	May 14, 2015 ~ May 27, 2015	Nov. 30, 2015	Conducted (TH03-HY)
Base Station(Measure)	Rohde & Schwarz	CMU200	117995	GSM / GPRS / WCDMA / CDMA	Jul. 29, 2014	May 14, 2015 ~ May 27, 2015	Jul. 28, 2015	Conducted (TH03-HY)
Bilog Antenna	Schaffner	CBL6111C	2726	30MHz ~ 1GHz	Sep. 27, 2014	May 20, 2015	Sep. 26, 2015	Radiation (03CH07-HY)
Double Ridge Horn Antenna	ESCO	3117	00075962	1GHz ~ 18GHz	Aug. 19, 2014	May 20, 2015	Aug. 18, 2015	Radiation (03CH07-HY)
Horn Antenna	SCHWARZBEC K	BBHA 9120D	9120D-1328	1GHz ~ 18GHz	Nov. 05, 2014	May 20, 2015	Nov. 04, 2015	Radiation (03CH07-HY)
Preamplifier	COM-POWER	PA-103A	161241	10MHz-1000MHz	Mar. 12, 2015	May 20, 2015	Mar. 11, 2016	Radiation (03CH07-HY)
Preamplifier	Agilent	8449B	3008A02362	1GHz~ 26.5GHz	Oct. 21, 2014	May 20, 2015	Oct. 20, 2015	Radiation (03CH07-HY)
Signal Analyzer	Rohde & Schwarz	FSV 30	101749	10Hz~30GHz	Mar. 10, 2015	May 20, 2015	Mar. 09, 2016	Radiation (03CH07-HY)
Antenna Mast	Max-Full	MFA520BS	N/A	1m~4m	N/A	May 20, 2015	N/A	Radiation (03CH07-HY)
Turn Table	ChainTek	Chaintek 3000	N/A	0~360 degree	N/A	May 20, 2015	N/A	Radiation (03CH07-HY)
Signal Generator	Rohde & Schwarz	SMF100A	101107	100kHz~40GHz	May 23, 2014	May 20, 2015	May 22, 2015	Radiation (03CH07-HY)



5 Uncertainty of Evaluation

Uncertainty of Radiated Emission Measurement (30 MHz ~ 1000 MHz)

Measuring Uncertainty for a Level of Confidence of 95% ($U = 2Uc(y)$)	4.50
---	------