



FCC RF Test Report

APPLICANT : Motorola Mobility, LLC
EQUIPMENT : Mobile Cellular Phone
BRAND NAME : Motorola
MODEL NAME : 5062
FCC ID : IHDT56UB3
STANDARD : 47 CFR Part 2, 22(H), 27
CLASSIFICATION : PCS Licensed Transmitter Held to Ear (PCE)

The product was received on May 01, 2015 and completely tested on Jul. 09, 2015. We, SPORTON INTERNATIONAL INC., would like to declare that the tested sample has been evaluated in accordance with the test procedures given in ANSI / TIA / EIA-603-C-2004 and the testing has shown the tested sample to be in compliance with the applicable technical standards.

The test results in this report apply exclusively to the tested model / sample. Without written approval of SPORTON INTERNATIONAL INC., the test report shall not be reproduced except in full.

Reviewed by: Joseph Lin / Supervisor

Approved by: Jones Tsai / Manager



Testing Laboratory
1190

SPORTON INTERNATIONAL INC.

No. 52, Hwa Ya 1st Rd., Hwa Ya Technology Park, Kwei-Shan District, Tao Yuan City, Taiwan, R.O.C.

SPORTON INTERNATIONAL INC.
TEL : 886-3-327-3456
FAX : 886-3-328-4978
FCC ID : IHDT56UB3

Page Number : 1 of 24
Report Issued Date : Jul. 10, 2015
Report Version : Rev. 01
Report Template No.: BU5-FGLTE Version 1.3



TABLE OF CONTENTS

REVISION HISTORY..... 3
SUMMARY OF TEST RESULT 4
1 GENERAL DESCRIPTION 5
1.1 Applicant 5
1.2 Manufacturer 5
1.3 Product Feature of Equipment Under Test 5
1.4 Product Specification subjective to this standard 6
1.5 Modification of EUT 6
1.6 Emission Designator 7
1.7 Testing Location 8
1.8 Applicable Standards 8
2 TEST CONFIGURATION OF EQUIPMENT UNDER TEST 9
2.1 Test Mode 9
2.2 Connection Diagram of Test System 11
2.3 Support Unit used in test configuration and system 11
2.4 Measurement Results Explanation Example 11
3 CONDUCTED TEST ITEMS 12
3.1 Measuring Instruments 12
3.2 Test Setup 12
3.3 Test Result of Conducted Test 12
3.4 Conducted Output Power 13
3.5 Peak-to-Average Ratio 14
3.6 Occupied Bandwidth 15
3.7 Conducted Band Edge 16
3.8 Conducted Spurious Emission 17
3.9 Frequency Stability 18
4 RADIATED TEST ITEMS 19
4.1 Measuring Instruments 19
4.2 Test Setup 19
4.3 Test Result of Radiated Test 19
4.4 Effective Radiated Power and Effective Isotropic Radiated Power 20
4.5 Radiated Spurious Emission 22
5 LIST OF MEASURING EQUIPMENT 23
6 UNCERTAINTY OF EVALUATION 24
APPENDIX A. TEST RESULTS OF CONDUCTED TEST
APPENDIX B. TEST RESULTS OF RADIATED TEST



SUMMARY OF TEST RESULT

Report Section	FCC Rule	Description	Limit	Result	Remark
3.4	§2.1046	Conducted Output Power	Reporting Only	PASS	-
3.5	N/A	Peak-to-Average Ratio	<13 dB	PASS	-
3.6	§2.1049	Occupied Bandwidth	Reporting Only	PASS	-
3.7	§2.1051 §22.917(a) §27.53(m)(4)	Conducted Band Edge Measurement (Band 5) (Band 7) (Band 38) (Band 41)	< 43+10log ₁₀ (P[Watts])	PASS	-
3.8	§2.1051 §22.917(a)	Conducted Spurious Emission (Band 5)	< 43+10log ₁₀ (P[Watts])	PASS	-
	§2.1051 §27.53(m)(4)	Conducted Spurious Emission (Band 7) (Band 38) (Band 41)	< 55+10log ₁₀ (P[Watts])		-
3.9	§2.1055 §22.355	Frequency Stability Temperature & Voltage	< 2.5 ppm	PASS	-
	§2.1055 §27.54		Within Authorized Band		
4.4	§22.913(a)(2)	Effective Radiated Power (Band 5)	ERP < 7 Watt	PASS	-
	§27.50(h)(2)	Equivalent Isotropic Radiated Power (Band 7) (Band 38) (Band 41)	EIRP < 2Watt	PASS	-
4.5	§2.1053 §22.917(a)	Radiated Spurious Emission (Band 5)	< 43+10log ₁₀ (P[Watts])	PASS	Under limit 23.70 dB at 10280.000 MHz
	§2.1053 §27.53(m)(4)	Radiated Spurious Emission (Band 7) (Band 38) (Band 41)	< 55+10log ₁₀ (P[Watts])	PASS	



1 General Description

1.1 Applicant

Motorola Mobility, LLC

222 W Merchandise Mart Plaza, Suite 1800, Chicago, IL 60654, United States

1.2 Manufacturer

Motorola Mobility, LLC

222 W Merchandise Mart Plaza, Suite 1800, Chicago, IL 60654, United States

1.3 Product Feature of Equipment Under Test

Product Feature	
Equipment	Mobile Cellular Phone
Brand Name	Motorola
Model Name	5062
FCC ID	IHDT56UB3
IMEI	358967060006499
EUT supports Radios application	GSM/EGPRS/WCDMA/HSPA/LTE/NFC/FM 2.4GHz WLAN 11b/g/n HT20 5GHz WLAN 11a/n HT20/HT40 Bluetooth v2.1 EDR Bluetooth v4.1 - LE
HW Version	P2
EUT Stage	Identical Prototype

Accessory List	
AC Adapter	Brand Name : Motorola
	Model Name : SPN5801A
Battery	Brand Name : Motorola
	Model Name : FL40
Earphone	Brand Name : Motorola
	Model Name : SJYN1181B
USB Cable	Brand Name : Motorola
	Model Name : SKN6462A



1.4 Product Specification subjective to this standard

Product Specification subjective to this standard	
Tx Frequency	LTE Band 7 : 2502.5 MHz ~ 2567.5 MHz LTE Band 5 : 824.7 MHz ~ 848.3 MHz LTE Band 38 : 2572.5 MHz ~ 2617.5 MHz LTE Band 41 : 2498.5 MHz ~ 2687.5 MHz
Rx Frequency	LTE Band 7 : 2622.5MHz ~ 2687.5 MHz LTE Band 5 : 869.7 MHz ~ 893.3 MHz LTE Band 38 : 2572.5 MHz ~ 2617.5 MHz LTE Band 41 : 2498.5 MHz ~ 2687.5 MHz
Bandwidth	LTE Band 7 : 5MHz/ 10MHz / 15MHz / 20MHz LTE Band 5 : 1.4MHz / 3MHz / 5MHz / 10MHz LTE Band 38 : 5MHz/ 10MHz / 15MHz / 20MHz LTE Band 41 : 5MHz / 10MHz / 15MHz / 20MHz
Maximum Output Power to Antenna	LTE Band 7 : 22.49 dBm LTE Band 5 : 22.58 dBm LTE Band 38 : 22.43 dBm LTE Band 41 : 21.56 dBm
Antenna Type	Fixed Internal Antenna
Type of Modulation	QPSK / 16QAM

1.5 Modification of EUT

No modifications are made to the EUT during all test items.



1.6 Emission Designator

LTE Band 7		QPSK			16QAM		
BW(MHz)	Emission Designator (99%OBW)	Frequency Tolerance (ppm)	Maximum EIRP(W)	Emission Designator (99%OBW)	Frequency Tolerance (ppm)	Maximum EIRP(W)	
5	4M51G7D	-	0.3119	4M51W7D	-	0.1879	
10	9M13G7D	0.0073	0.3184	9M07W7D	-	0.1892	
15	13M5G7D	-	0.3334	13M5W7D	-	0.1936	
20	18M4G7D	-	0.3162	18M4W7D	-	0.1932	
LTE Band 38		QPSK			16QAM		
BW(MHz)	Emission Designator (99%OBW)	Frequency Tolerance (ppm)	Maximum EIRP(W)	Emission Designator (99%OBW)	Frequency Tolerance (ppm)	Maximum EIRP(W)	
5	4M53G7D	-	0.1807	4M52W7D	-	0.1107	
10	9M07G7D	0.0086	0.1824	9M07W7D	-	0.1102	
15	13M5G7D	-	0.1807	13M5W7D	-	0.1138	
20	18M5G7D	-	0.1832	18M5W7D	-	0.1132	
LTE Band 41		QPSK			16QAM		
BW(MHz)	Emission Designator (99%OBW)	Frequency Tolerance (ppm)	Maximum EIRP(W)	Emission Designator (99%OBW)	Frequency Tolerance (ppm)	Maximum EIRP(W)	
5	4M52G7D	-	0.1663	4M51W7D	-	0.1358	
10	9M09G7D	0.0078	0.1706	9M07W7D	-	0.1426	
15	13M5G7D	-	0.1738	13M5W7D	-	0.1462	
20	18M4G7D	-	0.1791	18M4W7D	-	0.1517	
LTE Band 5		QPSK			16QAM		
BW(MHz)	Emission Designator (99%OBW)	Frequency Tolerance (ppm)	Maximum ERP(W)	Emission Designator (99%OBW)	Frequency Tolerance (ppm)	Maximum ERP(W)	
1.4	1M10G7D	-	0.0653	1M10W7D	-	0.0457	
3	2M73G7D	-	0.0619	2M72W7D	-	0.0456	
5	4M51G7D	-	0.1002	4M50W7D	-	0.0738	
10	9M13G7D	0.0053	0.1038	9M05W7D	-	0.0762	



1.7 Testing Location

Sporton Lab is accredited to ISO 17025 by Taiwan Accreditation Foundation (TAF code : 1190) and the FCC designation No. TW1022 under the FCC 2.948(e) by Mutual Recognition Agreement (MRA) in FCC Test.

Test Site	SPORTON INTERNATIONAL INC.
Test Site Location	No. 52, Hwa Ya 1 st Rd., Hwa Ya Technology Park, Kwei-Shan District, Tao Yuan City, Taiwan, R.O.C. TEL: +886-3-327-3456 FAX: +886-3-328-4978
Test Site No.	Sporton Site No.
	TH05HY

Test Site	SPORTON INTERNATIONAL INC.
Test Site Location	No.58, Aly. 75, Ln. 564, Wenhua 3rd Rd. Kwei-Shan District, Tao Yuan City, Taiwan (R.O.C.) TEL: +886-3-327-0855
Test Site No.	Sporton Site No.
	03CH11-HY

1.8 Applicable Standards

According to the specifications of the manufacturer, the EUT must comply with the requirements of the following standards:

- ♦ 47 CFR Part 2, 22(H), 27
- ♦ ANSI / TIA / EIA-603-C-2004
- ♦ FCC KDB 971168 D01 Power Meas. License Digital Systems v02r02

Remark:

1. All test items were verified and recorded according to the standards and without any deviation during the test.
2. This EUT has also been tested and complied with the requirements of FCC Part 15, Subpart B, recorded in a separate test report.



2 Test Configuration of Equipment Under Test

2.1 Test Mode

Antenna port conducted and radiated test items listed below are performed according to KDB 971168 D01 Power Meas. License Digital Systems v02r02 with maximum output power.

Radiated measurements are performed by rotating the EUT in three different orthogonal test planes to find the maximum emission.

Test Items	Band	Bandwidth (MHz)						Modulation		RB #			Test Channel		
		1.4	3	5	10	15	20	QPSK	16QAM	1	Half	Full	L	M	H
Max. Output Power	5	Y	Y	Y	Y	-	-	Y	Y	Y	Y	Y	Y	Y	Y
	7	-	-	Y	Y	Y	Y	Y	Y	Y	Y	Y	Y	Y	Y
	38	-	-	Y	Y	Y	Y	Y	Y	Y	Y	Y	Y	Y	Y
	41	-	-	Y	Y	Y	Y	Y	Y	Y	Y	Y	Y	Y	Y
Peak-to-Average Ratio	5				Y	-	-	Y	Y	Y		Y	Y	Y	Y
	7	-	-				Y	Y	Y	Y		Y	Y	Y	Y
	38	-	-				Y	Y	Y	Y		Y	Y	Y	Y
	41	-	-				Y	Y	Y	Y		Y	Y	Y	Y
26dB and 99% Bandwidth	5	Y	Y	Y	Y	-	-	Y	Y			Y	Y	Y	Y
	7	-	-	Y	Y	Y	Y	Y	Y			Y	Y	Y	Y
	38	-	-	Y	Y	Y	Y	Y	Y			Y	Y	Y	Y
	41	-	-	Y	Y	Y	Y	Y	Y			Y	Y	Y	Y
Conducted Band Edge	5	Y	Y	Y	Y	-	-	Y	Y	Y		Y			Y
	7	-	-	Y	Y	Y	Y	Y	Y	Y		Y			Y
	38	-	-	Y	Y	Y	Y	Y	Y	Y		Y			Y
	41	-	-	Y	Y	Y	Y	Y	Y	Y		Y			Y



Test Items	Band	Bandwidth (MHz)						Modulation		RB #			Test Channel		
		1.4	3	5	10	15	20	QPSK	16QAM	1	Half	Full	L	M	H
Conducted Spurious Emission	5	√	√	√	√	-	-	√	√	√			√	√	√
	7	-	-	√	√	√	√	√	√	√			√	√	√
	38	-	-	√	√	√	√	√	√	√			√	√	√
	41	-	-	√	√	√	√	√	√	√			√	√	√
Frequency Stability	5				√	-	-	√				√		√	
	7	-	-		√			√				√		√	
	38	-	-		√			√				√		√	
	41	-	-		√			√				√		√	
E.R.P./ E.I.R.P.	5	√	√	√	√	-	-	√	√	√			√	√	√
	7	-	-	√	√	√	√	√	√	√			√	√	√
	38	-	-	√	√	√	√	√	√	√			√	√	√
	41	-	-	√	√	√	√	√	√	√			√	√	√
Radiated Spurious Emission	5	√	√	√	√	-	-	√		√			√	√	√
	7	-	-	√	√	√	√	√		√			√	√	√
	38	-	-	√	√	√	√	√		√			√	√	√
	41	-	-	√	√	√	√	√		√			√	√	√
Note	<p>1. The mark “√” means that this configuration is chosen for testing</p> <p>2. The mark “-” means that this bandwidth is not supported.</p> <p>3. The device is investigated from 30MHz to 10 times of fundamental signal for radiated spurious emission test under different RB size/offset and modulations in exploratory test. Subsequently, only the worst case emissions are reported.</p>														

3 Conducted Test Items

3.1 Measuring Instruments

See list of measuring instruments of this test report.

3.2 Test Setup

3.2.1 Conducted Output Power

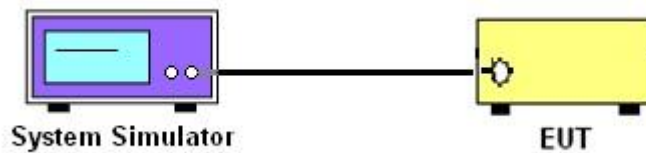

3.2.2 Peak-to-Average Ratio, Occupied Bandwidth ,Conducted Band-Edge and Conducted Spurious Emission

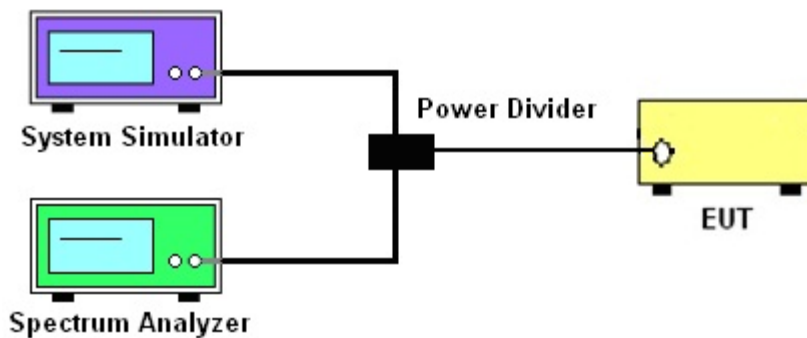

3.2.3 Frequency Stability

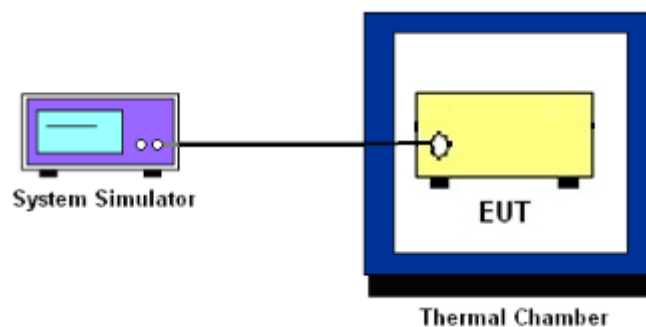

3.3 Test Result of Conducted Test

Please refer to Appendix A.



3.4 Conducted Output Power

3.4.1 Description of the Conducted Output Power Measurement

A system simulator was used to establish communication with the EUT. Its parameters were set to force the EUT transmitting at maximum output power. The measured power in the radio frequency on the transmitter output terminals shall be reported.

3.4.2 Test Procedures

1. The transmitter output port was connected to the system simulator.
2. Set EUT at maximum power through the system simulator.
3. Select lowest, middle, and highest channels for each band and different modulation.
4. Measure and record the power level from the system simulator.



3.5 Peak-to-Average Ratio

3.5.1 Description of the PAR Measurement

Power Complementary Cumulative Distribution Function (CCDF) curves provide a means for characterizing the power peaks of a digitally modulated signal on a statistical basis. A CCDF curve depicts the probability of the peak signal amplitude exceeding the average power level. Most contemporary measurement instrumentation include the capability to produce CCDF curves for an input signal provided that the instrument's resolution bandwidth can be set wide enough to accommodate the entire input signal bandwidth. In measuring transmissions in this band using an average power technique, the peak-to-average ratio (PAR) of the transmission may not exceed 13 dB.

3.5.2 Test Procedures

1. The testing follows FCC KDB 971168 v02r02 Section 5.7.1.
2. The EUT was connected to spectrum and system simulator via a power divider.
3. Set the CCDF (Complementary Cumulative Distribution Function) option in spectrum analyzer.
4. The highest RF powers were measured and recorded the maximum PAPR level associated with a probability of 0.1 %.
5. Record the deviation as Peak to Average Ratio.



3.6 Occupied Bandwidth

3.6.1 Description of Occupied Bandwidth Measurement

The occupied bandwidth is the width of a frequency band such that, below the lower and above the upper frequency limits, the mean powers emitted are each equal to a specified percentage 0.5% of the total mean transmitted power.

The 26 dB emission bandwidth is defined as the frequency range between two points, one above and one below the carrier frequency, at which the spectral density of the emission is attenuated 26 dB below the maximum in-band spectral density of the modulated signal. Spectral density (power per unit bandwidth) is to be measured with a detector of resolution bandwidth equal to approximately 1.0% of the emission bandwidth.

3.6.2 Test Procedures

1. The testing follows FCC KDB 971168 v02r02 Section 4.2.
2. The EUT was connected to spectrum analyzer and system simulator via a power divider.



3.7 Conducted Band Edge

3.7.1 Description of Conducted Band Edge Measurement

22.917(a)

For operations in the 824 – 849 MHz band, the FCC limit is $43 + 10\log_{10}(P[\text{Watts}])$ dB below the transmitter power $P(\text{Watts})$ in a 100kHz bandwidth. However, in the 1MHz bands immediately outside and adjacent to the licensee's frequency block, a resolution bandwidth of at least one percent of the emission bandwidth of the fundamental emission of the transmitter may be employed.

27.53(m)(4)

For mobile digital stations, the attenuation factor shall be not less than $40 + 10 \log (P)$ dB on all frequencies between the channel edge and 5 megahertz from the channel edge, $43 + 10 \log (P)$ dB on all frequencies between 5 megahertz and X megahertz from the channel edge, and $55 + 10 \log (P)$ dB on all frequencies more than X megahertz from the channel edge, where X is the greater of 6 megahertz or the actual emission bandwidth as defined in paragraph (m)(6) of this section. In addition, the attenuation factor shall not be less that $43 + 10 \log (P)$ dB on all frequencies between 2490.5 MHz and 2496 MHz and $55 + 10 \log (P)$ dB at or below 2490.5 MHz. Mobile Satellite Service licensees operating on frequencies below 2495 MHz may also submit a documented interference complaint against BRS licensees operating on channel BRS Channel 1 on the same terms and conditions as adjacent channel BRS or EBS licensees.

3.7.2 Test Procedures

1. The testing follows FCC KDB 971168 v02r02 Section 6.0.
2. The EUT was connected to spectrum analyzer and system simulator via a power divider.
3. The band edges of low and high channels for the highest RF powers were measured. Set RBW $\geq 1\%$ EBW in the 1MHz band immediately outside and adjacent to the band edge.
4. Set spectrum analyzer with RMS detector.
5. The RF fundamental frequency should be excluded against the limit line in the operating frequency band.
6. The limit line is derived from $43 + 10\log(P)$ dB below the transmitter power $P(\text{Watts})$
 $= P(\text{W}) - [43 + 10\log(P)]$ (dB)
 $= [30 + 10\log(P)]$ (dBm) - $[43 + 10\log(P)]$ (dB)
 $= -13\text{dBm}$.



3.8 Conducted Spurious Emission

3.8.1 Description of Conducted Spurious Emission Measurement

The power of any emission outside of the authorized operating frequency ranges must be lower than the transmitter power (P) by a factor of at least $43 + 10 \log (P)$ dB.

For Band 7, 38, 41

The power of any emission outside of the authorized operating frequency ranges must be lower than the transmitter power (P) by a factor of at least $55 + 10 \log (P)$ dB.

It is measured by means of a calibrated spectrum analyzer and scanned from 30 MHz up to a frequency including its 10th harmonic.

3.8.2 Test Procedures

1. The testing follows FCC KDB 971168 v02r02 Section 6.0.
2. The EUT was connected to spectrum analyzer and system simulator via a power divider.
3. The RF output of EUT was connected to the spectrum analyzer by RF cable and attenuator. The path loss was compensated to the results for each measurement.
4. The middle channel for the highest RF power within the transmitting frequency was measured.
5. The conducted spurious emission for the whole frequency range was taken.
6. Make the measurement with the spectrum analyzer's RBW = 1MHz, VBW = 3MHz, taking the record of maximum spurious emission.
7. The RF fundamental frequency should be excluded against the limit line in the operating frequency band.
8. The limit line is derived from $43 + 10\log(P)$ dB below the transmitter power P(Watts)
 $= P(W) - [43 + 10\log(P)]$ (dB)
 $= [30 + 10\log(P)]$ (dBm) - $[43 + 10\log(P)]$ (dB)
 $= -13$ dBm.
9. For Band 7, 38, 41
The limit line is derived from $55 + 10\log(P)$ dB below the transmitter power P(Watts)



3.9 Frequency Stability

3.9.1 Description of Frequency Stability Measurement

The frequency stability shall be measured by variation of ambient temperature and variation of primary supply voltage to ensure that the fundamental emission stays within the authorized frequency block. The frequency stability of the transmitter shall be maintained within $\pm 0.00025\%$ ($\pm 2.5\text{ppm}$) of the center frequency.

3.9.2 Test Procedures for Temperature Variation

1. The EUT was set up in the thermal chamber and connected with the system simulator.
2. With power OFF, the temperature was decreased to -30°C and the EUT was stabilized before testing. Power was applied and the maximum change in frequency was recorded within one minute.
3. With power OFF, the temperature was raised in 10°C step up to 50°C . The EUT was stabilized at each step for at least half an hour. Power was applied and the maximum frequency change was recorded within one minute.

3.9.3 Test Procedures for Voltage Variation

1. The testing follows FCC KDB 971168 v02r02 Section 9.0.
2. The EUT was placed in a temperature chamber at $25\pm 5^{\circ}\text{C}$ and connected with the system simulator.
3. The power supply voltage to the EUT was varied from 85% to 115% of the nominal value measured at the input to the EUT.
4. The variation in frequency was measured for the worst case.

4 Radiated Test Items

4.1 Measuring Instruments

See list of measuring instruments of this test report.

4.2 Test Setup

4.2.1 For radiated test from 30MHz to 1GHz

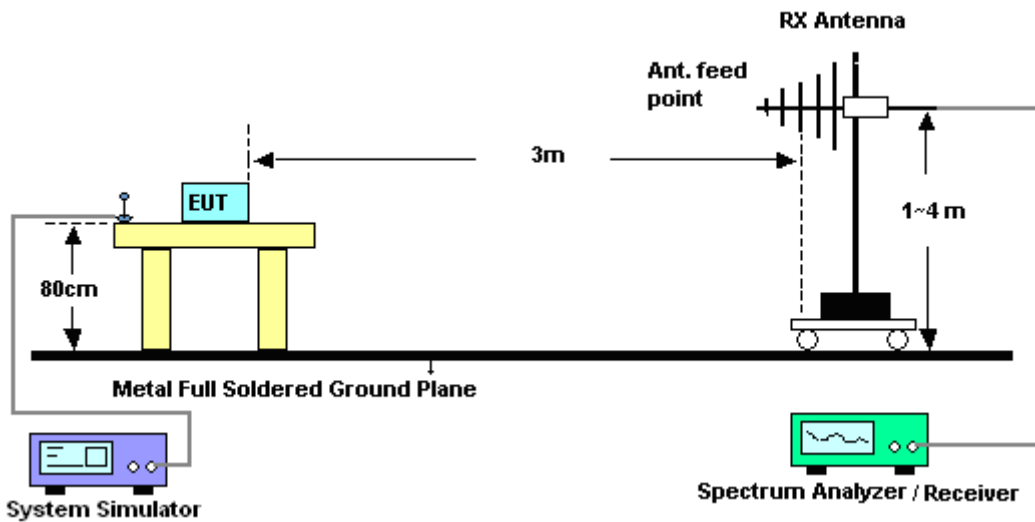

4.2.2 For radiated test above 1GHz

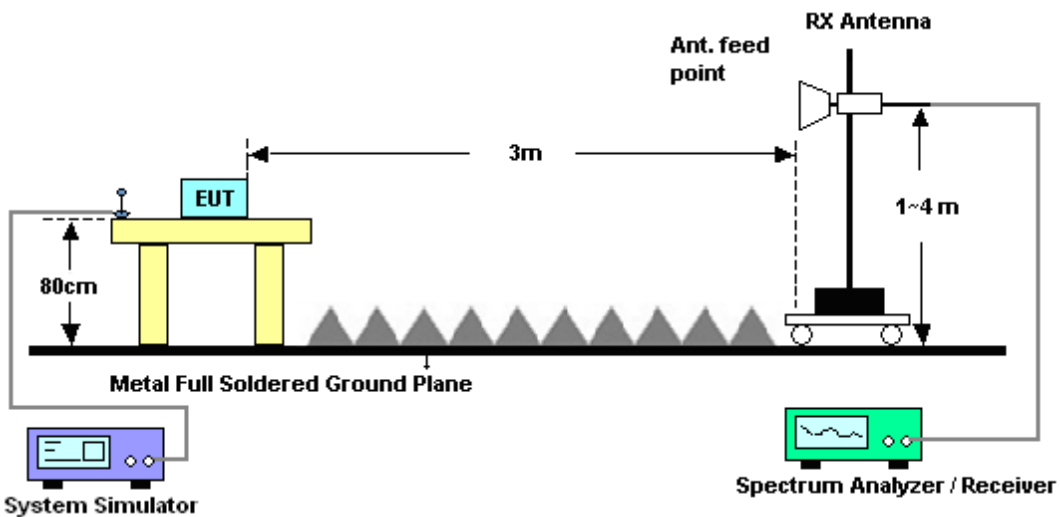

4.3 Test Result of Radiated Test

Please refer to Appendix B.



4.4 Effective Radiated Power and Effective Isotropic Radiated Power

4.4.1 Description of the ERP/EIRP Measurement

Effective radiated power output measurements by substitution method according to ANSI / TIA / EIA-603-C-2004, and the spectrum analyzer configuration follows KDB 971168 D01 Power Meas. License Digital Systems v02r02. Mobile and portable (hand-held) stations operating are limited to average ERP of 7 watts with LTE band 5.

Equivalent isotropic radiated power output measurements by substitution method according to ANSI / TIA / EIA-603-C-2004, and the spectrum analyzer configuration follows KDB 971168 D01 Power Meas. License Digital Systems v02r02. Mobile and portable (hand-held) stations operating are limited to average EIRP of 2 watts with LTE band 7, 38, 41.

4.4.2 Test Procedures

1. The EUT was placed on a non-conductive rotating platform 0.8 meters high in a semi-anechoic chamber. The radiated emission at the fundamental frequency was measured at 3 m with a test antenna and a spectrum analyzer with RMS detector per section 5. of KDB 971168 D01.
2. During the measurement, the system simulator parameters were set to force the EUT transmitting at maximum output power. The maximum emission was recorded from analyzer power level (LVL) from the 360 degrees rotation of the turntable and the test antenna raised and lowered over a range from 1 to 4 meters in both horizontally and vertically polarized orientations.
3. Effective Isotropic Radiated Power (EIRP) was measured by substitution method according to TIA/EIA-603-C. The EUT was replaced by the substitution antenna at same location, and then a known power from S.G. was applied into the dipole antenna through a Tx cable, and then recorded the maximum Analyzer reading through raised and lowered the test antenna. The correction factor (in dB) = S.G. - Tx Cable loss + Substitution antenna gain - Analyzer reading. Then the EUT's EIRP was calculated with the correction factor, $EIRP = LVL + \text{Correction factor}$ and $ERP = EIRP - 2.15$. Take the record of the output power at substitution antenna.



	LTE					
LTE BW	1.4M	3M	5M	10M	15M	20M
Span	3MHz	6MHz	10MHz	20MHz	30MHz	40MHz
RBW	30kHz	100kHz	100kHz	300kHz	300kHz	300kHz
VBW	100kHz	300kHz	300kHz	1MHz	1MHz	1MHz
Detector	RMS	RMS	RMS	RMS	RMS	RMS
Trace	Average	Average	Average	Average	Average	Average
Average Type	Power	Power	Power	Power	Power	Power
Sweep Count	100	100	100	100	100	100



4.5 Radiated Spurious Emission

4.5.1 Description of Radiated Spurious Emission

The radiated spurious emission was measured by substitution method according to ANSI / TIA / EIA-603-C-2004. The power of any emission outside of the authorized operating frequency ranges must be attenuated below the transmitter power (P) by a factor of at least $43 + 10 \log (P)$ dB.

For Band 7, 38, 41

The power of any emission outside of the authorized operating frequency ranges must be attenuated below the transmitter power (P) by a factor of at least $55 + 10 \log (P)$ dB.

The spectrum is scanned from 30 MHz up to a frequency including its 10th harmonic.

4.5.2 Test Procedures

1. The testing follows FCC KDB 971168 v02r02 Section 5.8 and ANSI / TIA-603-C-2004 Section 2.2.12.
2. The EUT was placed on a rotatable wooden table with 0.8 meter above ground.
3. The EUT was set 3 meters from the receiving antenna, which was mounted on the antenna tower.
4. The table was rotated 360 degrees to determine the position of the highest spurious emission.
5. The height of the receiving antenna is varied between one meter and four meters to search the maximum spurious emission for both horizontal and vertical polarizations.
6. Make the measurement with the spectrum analyzer's RBW = 1MHz, VBW = 3MHz, taking the record of maximum spurious emission.
7. A horn antenna was substituted in place of the EUT and was driven by a signal generator.
8. Tune the output power of signal generator to the same emission level with EUT maximum spurious emission.
9. Taking the record of output power at antenna port.
10. Repeat step 7 to step 8 for another polarization.
11. The RF fundamental frequency should be excluded against the limit line in the operating frequency band.

The limit line is derived from $43 + 10\log(P)$ dB below the transmitter power P(Watts)
= P(W)- [43 + 10log(P)] (dB)
= [30 + 10log(P)] (dBm) - [43 + 10log(P)] (dB)
= -13dBm.

For Band 7, 38, 41:

The limit line is derived from $55 + 10\log(P)$ dB below the transmitter power P(Watts)



5 List of Measuring Equipment

Instrument	Manufacturer	Model No.	Serial No.	Characteristics	Calibration Date	Test Date	Due Date	Remark
LTE Base Station	Anritsu	MT8820C	6201432821	GSM/GPRS /WCDMA/LTE	Oct. 27, 2014	Jun. 04, 2015~ Jul. 09, 2015	Oct. 26, 2015	Conducted (TH05-HY)
Spectrum Analyzer	Rohde & Schwarz	FSV40	101397	10Hz~40GHz	Sep. 17, 2014	Jun. 04, 2015~ Jul. 09, 2015	Sep. 16, 2015	Conducted (TH05-HY)
Temperature Chamber	ESPEC	SH-641	92013720	-30°C ~70°C	Dec. 04, 2014	Jun. 04, 2015~ Jul. 09, 2015	Dec. 03, 2015	Conducted (TH05-HY)
Bilog Antenna	TESEQ	CBL 6111D	35413	30MHz~1GHz	Oct. 24, 2014	Jun. 03, 2015~ Jul. 09, 2015	Oct. 23, 2015	Radiation (03CH11-HY)
Horn Antenna	SCHWARZBECK	BBHA 9120 D	9120D-1325	1GHz ~ 18GHz	Oct. 03, 2014	Jun. 03, 2015~ Jul. 09, 2015	Oct. 02, 2015	Radiation (03CH11-HY)
Amplifier	SONOMA	310N	187312	9kHz~1GHz	Nov. 24, 2014	Jun. 03, 2015~ Jul. 09, 2015	Nov. 23, 2015	Radiation (03CH11-HY)
Horn Antenna	SCHWARZBECK	BBHA 9120 D	9120D-1326	1GHz ~ 18GHz	Oct. 03, 2014	Jun. 03, 2015~ Jul. 09, 2015	Oct. 02, 2015	Radiation (03CH11-HY)
Preamplifier	Keysight	83017A	MY53270080	1GHz~26.5GHz	Nov. 20, 2014	Jun. 03, 2015~ Jul. 09, 2015	Nov. 19, 2015	Radiation (03CH11-HY)
Spectrum Analyzer	Keysight	N9010A	MY54200486	10Hz ~ 44GHZ	Sep. 24, 2014	Jun. 03, 2015~ Jul. 09, 2015	Sep. 23, 2015	Radiation (03CH11-HY)
Antenna Mast	EMEC	AM-BS-4500-B	N/A	1~4m	NA	Jun. 03, 2015~ Jul. 09, 2015	NA	Radiation (03CH11-HY)
Turn Table	EMEC	TT 2000	N/A	0-360 degree	NA	Jun. 03, 2015~ Jul. 09, 2015	NA	Radiation (03CH11-HY)
Signal Generator	Rohde & Schwarz	SMF100A	101107	100kHz~40GHz	May 22, 2015	Jun. 03, 2015~ Jul. 09, 2015	May 21, 2016	Radiation (03CH11-HY)
SHF-EHF Horn Antenna	SCHWARZBECK	BBHA 9170	BBHA9170251	18GHz- 40GHz	Oct. 02, 2014	Jun. 03, 2015~ Jul. 09, 2015	Oct. 01, 2015	Radiation (03CH11-HY)



6 Uncertainty of Evaluation

Uncertainty of Radiated Emission Measurement (30 MHz ~ 1000 MHz)

Measuring Uncertainty for a Level of Confidence of 95% ($U = 2Uc(y)$)	2.54
---	------

Uncertainty of Radiated Emission Measurement (1 GHz ~ 40 GHz)

Measuring Uncertainty for a Level of Confidence of 95% ($U = 2Uc(y)$)	4.90
---	------



Appendix A. Test Results of Conducted Test

Conducted Output Power(Average power)

LTE Band 7 Maximum Average Power [dBm]						
BW [MHz]	RB Size	RB Offset	Mod	Lowest	Middle	Highest
5	1	0	QPSK	22.29	22.48	22.39
5	1	12		22.45	22.37	22.38
5	1	24		22.17	22.16	22.10
5	12	0		21.35	21.26	21.40
5	12	6		21.37	21.39	21.27
5	12	11		21.33	21.26	21.31
5	25	0		21.36	21.29	21.29
5	1	0	16-QAM	21.64	21.68	21.58
5	1	12		21.61	21.65	21.66
5	1	24		21.65	21.55	21.48
5	12	0		20.29	20.29	20.32
5	12	6		20.25	20.31	20.32
5	12	11		20.08	20.28	20.33
5	25	0		20.20	20.39	20.30
10	1	0	QPSK	22.45	22.40	22.48
10	1	24		22.41	22.34	22.32
10	1	49		22.42	22.21	22.22
10	25	0		21.37	21.46	21.39
10	25	12		21.41	21.34	21.28
10	25	24		21.38	21.34	21.31
10	50	0		21.35	21.40	21.40
10	1	0	16-QAM	22.19	21.81	21.77
10	1	24		21.54	21.54	21.52
10	1	49		21.65	21.61	21.52
10	25	0		20.31	20.47	20.33
10	25	12		20.35	20.35	20.32
10	25	24		20.41	20.35	20.27
10	50	0		20.18	20.39	20.20



LTE Band 7 Maximum Average Power [dBm]						
BW [MHz]	RB Size	RB Offset	Mod	Lowest	Middle	Highest
15	1	0	QPSK	22.45	22.34	22.35
15	1	37		22.28	22.27	22.26
15	1	74		22.29	22.21	22.09
15	36	0		21.37	21.51	21.38
15	36	18		21.32	21.21	21.28
15	36	37		21.25	21.30	21.21
15	75	0		21.32	21.40	21.29
15	1	0	16-QAM	21.75	21.61	21.65
15	1	37		21.57	21.54	21.47
15	1	74		21.43	21.49	21.44
15	36	0		20.18	20.49	20.35
15	36	18		20.01	20.15	20.20
15	36	37		20.07	20.28	20.25
15	75	0		20.12	20.40	20.22
20	1	0	QPSK	22.47	22.49	22.23
20	1	49		22.44	22.21	22.31
20	1	99		22.19	22.34	22.07
20	50	0		21.38	21.39	21.37
20	50	24		21.19	21.37	21.26
20	50	49		21.23	21.26	21.20
20	100	0		21.19	21.41	21.23
20	1	0	16-QAM	21.73	21.60	21.58
20	1	49		21.55	21.51	21.74
20	1	99		21.43	21.43	21.42
20	50	0		20.29	20.28	20.42
20	50	24		20.22	20.25	20.42
20	50	49		20.04	20.16	20.13
20	100	0		20.10	20.41	20.26



LTE Band 38 Maximum Average Power [dBm]						
BW [MHz]	RB Size	RB Offset	Mod	Lowest	Middle	Highest
5	1	0	QPSK	22.35	22.18	22.36
5	1	12		22.40	22.33	22.40
5	1	24		22.21	22.05	22.31
5	12	0		21.38	21.17	21.74
5	12	6		21.40	21.21	21.58
5	12	11		21.32	21.13	21.55
5	25	0		21.36	21.27	21.50
5	1	0	16-QAM	21.49	21.34	21.43
5	1	12		21.43	21.37	21.39
5	1	24		21.55	21.35	21.81
5	12	0		20.22	20.00	20.69
5	12	6		20.15	20.35	20.70
5	12	11		20.17	20.28	20.61
5	25	0		20.22	20.40	20.78
10	1	0	QPSK	22.21	22.13	22.41
10	1	24		22.07	22.32	22.32
10	1	49		22.07	22.05	22.38
10	25	0		21.38	21.26	21.59
10	25	12		21.31	21.22	21.50
10	25	24		21.51	21.26	21.59
10	50	0		21.46	21.27	21.61
10	1	0	16-QAM	21.67	21.51	21.76
10	1	24		21.55	21.47	21.60
10	1	49		21.39	21.21	21.67
10	25	0		20.36	20.20	20.45
10	25	12		20.55	20.41	20.49
10	25	24		20.57	20.45	20.77
10	50	0		20.31	20.24	20.40



LTE Band 38 Maximum Average Power [dBm]						
BW [MHz]	RB Size	RB Offset	Mod	Lowest	Middle	Highest
15	1	0	QPSK	22.40	22.25	22.40
15	1	37		22.27	22.19	22.38
15	1	74		22.39	22.11	22.34
15	36	0		21.43	21.29	21.65
15	36	18		21.32	21.43	21.55
15	36	37		21.31	21.33	21.48
15	75	0		21.33	21.37	21.66
15	1	0	16-QAM	21.59	21.35	22.03
15	1	37		21.35	21.19	21.88
15	1	74		21.49	21.14	21.74
15	36	0		20.12	20.01	20.64
15	36	18		20.31	20.01	20.63
15	36	37		20.31	20.00	20.58
15	75	0		20.15	20.15	20.45
20	1	0	QPSK	22.36	22.41	22.43
20	1	49		22.40	22.28	22.38
20	1	99		22.07	22.11	22.32
20	50	0		21.44	21.30	21.75
20	50	24		21.36	21.33	21.76
20	50	49		21.24	21.25	21.71
20	100	0		21.43	21.32	21.83
20	1	0	16-QAM	21.74	21.50	21.94
20	1	49		21.69	21.68	21.93
20	1	99		21.43	21.26	21.59
20	50	0		20.25	20.33	20.61
20	50	24		20.26	20.26	20.59
20	50	49		20.28	20.19	20.55
20	100	0		20.26	20.25	20.56



LTE Band 41 Maximum Average Power [dBm]						
BW [MHz]	RB Size	RB Offset	Mod	Lowest	Middle	Highest
5	1	0	QPSK	21.52	21.33	21.24
5	1	12		21.45	21.32	21.20
5	1	24		21.21	21.13	21.15
5	12	0		20.37	20.21	20.34
5	12	6		20.39	20.15	20.26
5	12	11		20.48	20.19	20.34
5	25	0		20.44	20.20	20.29
5	1	0	16-QAM	20.58	20.15	20.40
5	1	12		20.57	20.03	20.24
5	1	24		20.54	20.12	20.37
5	12	0		19.64	19.13	19.40
5	12	6		19.32	19.02	19.35
5	12	11		19.52	19.01	19.14
5	25	0		19.42	19.16	19.25
10	1	0	QPSK	21.24	21.26	21.14
10	1	24		21.21	21.02	21.01
10	1	49		21.15	21.25	21.13
10	25	0		20.45	20.25	20.28
10	25	12		20.54	20.25	20.24
10	25	24		20.51	20.20	20.21
10	50	0		20.49	20.20	20.26
10	1	0	16-QAM	20.76	20.61	20.45
10	1	24		20.59	20.49	20.41
10	1	49		20.59	20.35	20.34
10	25	0		19.40	19.32	19.50
10	25	12		19.48	19.22	19.52
10	25	24		19.51	19.36	19.33
10	50	0		19.53	19.43	19.26



LTE Band 41 Maximum Average Power [dBm]						
BW [MHz]	RB Size	RB Offset	Mod	Lowest	Middle	Highest
15	1	0	QPSK	21.52	21.32	21.25
15	1	37		21.39	21.14	21.13
15	1	74		21.32	21.10	21.19
15	36	0		20.51	20.23	20.38
15	36	18		20.53	20.17	20.32
15	36	37		20.48	20.20	20.24
15	75	0		20.45	20.17	20.31
15	1	0	16-QAM	20.70	20.33	20.48
15	1	37		20.53	20.25	20.35
15	1	74		20.52	20.30	20.42
15	36	0		19.32	19.30	19.30
15	36	18		19.26	19.26	19.09
15	36	37		19.46	19.28	19.10
15	75	0		19.49	19.19	19.20
20	1	0	QPSK	21.56	21.39	21.32
20	1	49		21.41	21.01	21.02
20	1	99		21.29	21.12	21.06
20	50	0		20.71	20.32	20.48
20	50	24		20.57	20.25	20.42
20	50	49		20.57	20.28	20.30
20	100	0		20.58	20.24	20.39
20	1	0	16-QAM	20.81	20.72	20.62
20	1	49		20.56	20.31	20.61
20	1	99		20.56	20.40	20.47
20	50	0		19.55	19.37	19.48
20	50	24		19.41	19.18	19.33
20	50	49		19.61	19.33	19.22
20	100	0		19.55	19.29	19.31



LTE Band 5 Maximum Average Power [dBm]						
BW [MHz]	RB Size	RB Offset	Mod	Lowest	Middle	Highest
1.4	1	0	QPSK	22.30	22.32	22.33
1.4	1	2		22.43	22.40	22.56
1.4	1	5		22.24	22.32	22.33
1.4	3	0		22.28	22.28	22.30
1.4	3	1		22.41	22.30	22.57
1.4	3	2		22.28	22.33	22.27
1.4	6	0		21.34	21.29	21.39
1.4	1	0	16-QAM	21.60	21.58	21.52
1.4	1	2		21.44	21.62	21.90
1.4	1	5		21.64	21.54	21.63
1.4	3	0		21.46	21.35	21.35
1.4	3	1		21.44	21.36	21.36
1.4	3	2		21.36	21.50	21.46
1.4	6	0		20.28	20.08	20.26
3	1	0	QPSK	22.15	22.20	22.34
3	1	7		22.24	22.20	22.29
3	1	14		22.20	22.20	22.26
3	8	0		21.34	21.37	21.29
3	8	4		21.40	21.36	21.45
3	8	7		21.36	21.36	21.40
3	15	0		21.28	21.40	21.33
3	1	0	16-QAM	21.59	21.67	21.59
3	1	7		21.51	21.43	21.55
3	1	14		21.66	21.66	21.62
3	8	0		20.23	20.34	20.36
3	8	4		20.32	20.32	20.45
3	8	7		20.58	20.33	20.64
3	15	0		20.45	20.43	20.27



LTE Band 5 Maximum Average Power [dBm]						
BW [MHz]	RB Size	RB Offset	Mod	Lowest	Middle	Highest
5	1	0	QPSK	22.20	22.29	22.46
5	1	12		22.22	22.29	22.32
5	1	24		22.06	22.13	22.21
5	12	0		21.24	21.29	21.30
5	12	6		21.24	21.33	21.27
5	12	11		21.21	21.26	21.34
5	25	0		21.24	21.25	21.38
5	1	0	16-QAM	21.57	21.56	21.67
5	1	12		21.50	21.58	21.48
5	1	24		21.45	21.52	21.61
5	12	0		20.25	20.29	20.32
5	12	6		20.18	20.17	20.20
5	12	11		20.23	20.18	20.24
5	25	0		20.30	20.34	20.36
10	1	0	QPSK	22.51	22.47	22.58
10	1	24		22.43	22.23	22.22
10	1	49		22.14	22.02	22.27
10	25	0		21.23	21.34	21.34
10	25	12		21.26	21.32	21.28
10	25	24		21.19	21.19	21.34
10	50	0		21.27	21.18	21.25
10	1	0	16-QAM	21.66	21.80	21.61
10	1	24		21.43	21.52	21.30
10	1	49		21.35	21.40	21.52
10	25	0		20.13	20.44	20.33
10	25	12		20.26	20.40	20.27
10	25	24		20.29	20.24	20.26
10	50	0		20.13	20.21	20.25



LTE Band 7

Peak-to-Average Ratio

Mode	LTE Band 7 / 20MHz				
Mod.	QPSK		16QAM		Limit: 13dB
RB Size	1RB	Full RB	1RB	Full RB	Result
Lowest CH	3.86	4.99	4.84	6.03	PASS
Middle CH	4.58	5.1	5.59	6.14	
Highest CH	4.26	5.04	5.22	6.12	



LTE Band 7 / 20MHz / QPSK

Lowest Channel / 1RB

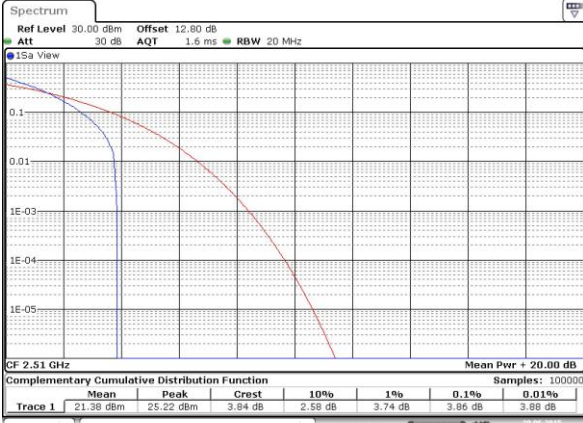

Date: 20 JUN 2015 15:27:52

Lowest Channel / Full RB



Date: 20 JUN 2015 15:28:04

Middle Channel / 1RB



Date: 20 JUN 2015 15:28:16

Middle Channel / Full RB

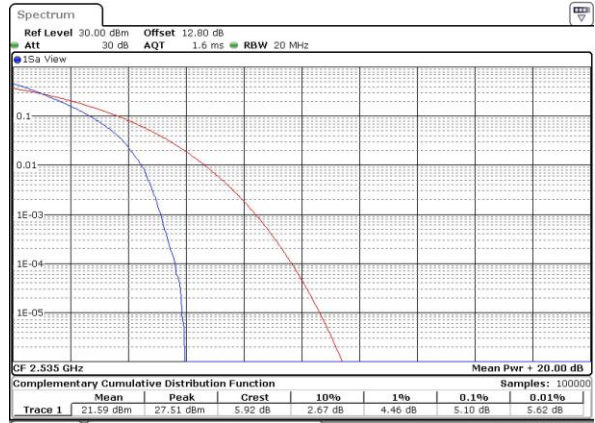

Date: 20 JUN 2015 15:28:27

Highest Channel / 1RB



Date: 20 JUN 2015 15:28:39

Highest Channel / Full RB



Date: 20 JUN 2015 15:28:50



LTE Band 7 / 20MHz / 16QAM

Lowest Channel / 1RB

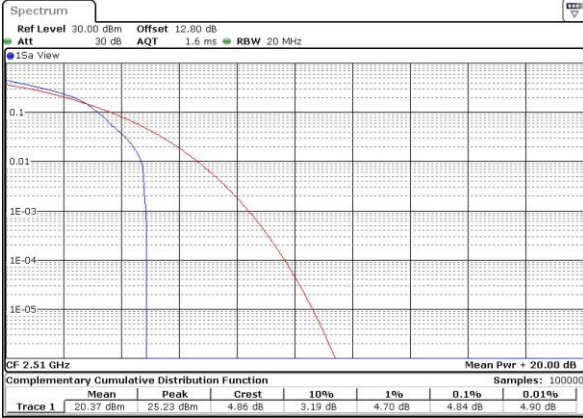

Date: 20 JUN 2015 15:26:34

Lowest Channel / Full RB

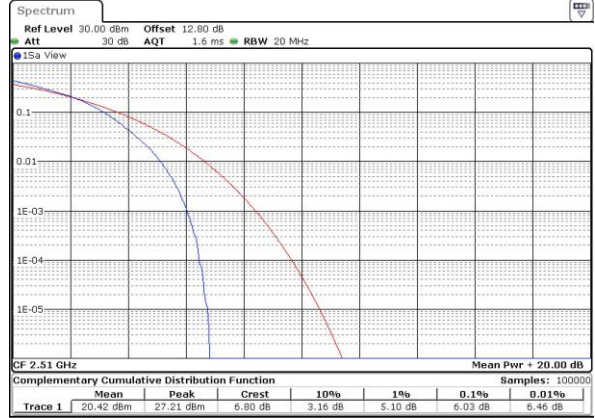

Date: 20 JUN 2015 15:26:49

Middle Channel / 1RB



Date: 20 JUN 2015 15:27:01

Middle Channel / Full RB

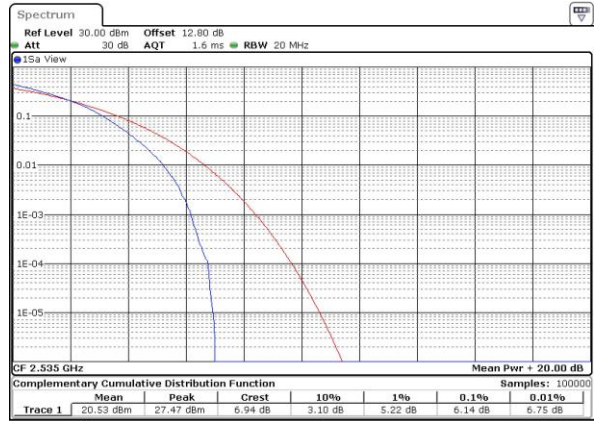

Date: 20 JUN 2015 15:27:14

Highest Channel / 1RB



Date: 20 JUN 2015 15:27:26

Highest Channel / Full RB



Date: 20 JUN 2015 15:27:38



26dB Bandwidth

Mode	LTE Band 7 : 26dB BW(MHz)											
	1.4MHz		3MHz		5MHz		10MHz		15MHz		20MHz	
BW	QPSK	16QAM	QPSK	16QAM	QPSK	16QAM	QPSK	16QAM	QPSK	16QAM	QPSK	16QAM
Lowest CH	-	-	-	-	5.05	5.06	9.89	9.97	14.63	14.6	20.38	20.18
Middle CH	-	-	-	-	5.05	5.05	10.07	9.97	14.66	14.66	20.38	20.18
Highest CH	-	-	-	-	5.05	5.07	10.07	10.01	14.69	14.72	20.3	20.3



LTE Band 7

Lowest Channel / 5MHz / QPSK

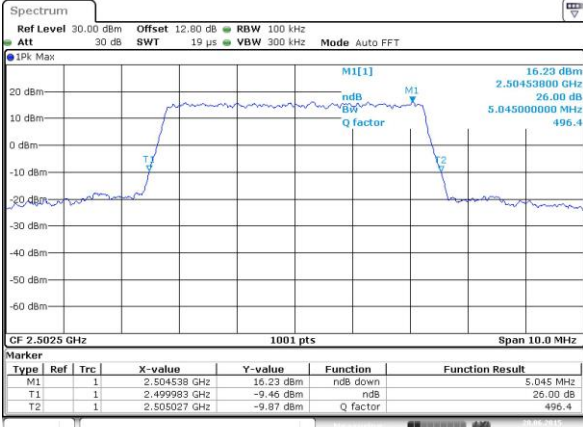

Date: 20 JUN 2015 14:12:15

Lowest Channel / 5MHz / 16QAM

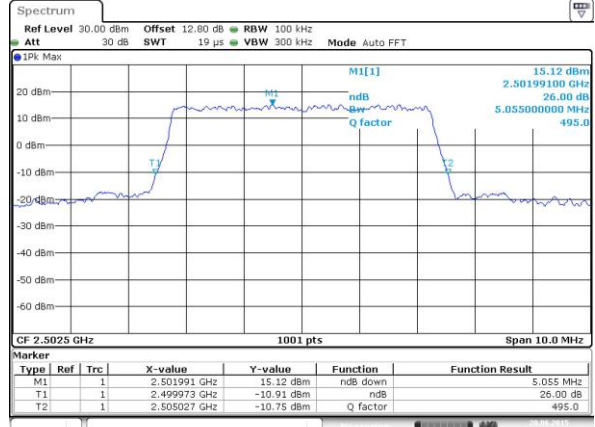

Date: 20 JUN 2015 14:12:28

Middle Channel / 5MHz / QPSK

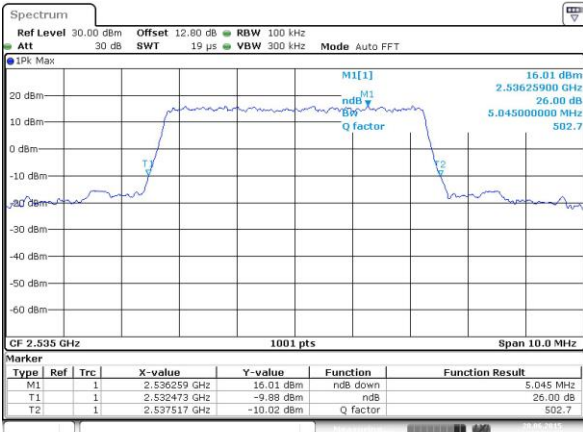

Date: 20 JUN 2015 14:20:02

Middle Channel / 5MHz / 16QAM

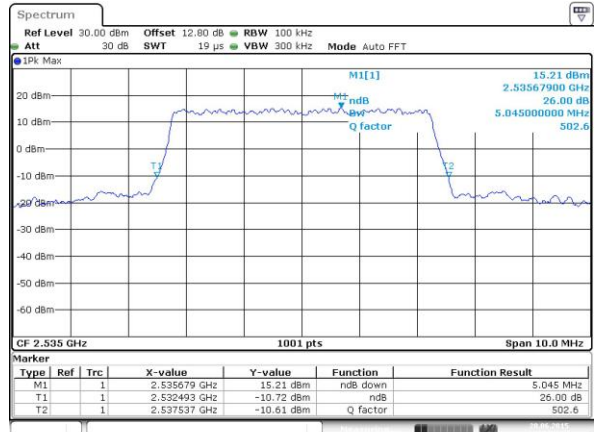

Date: 20 JUN 2015 14:20:14

Highest Channel / 5MHz / QPSK

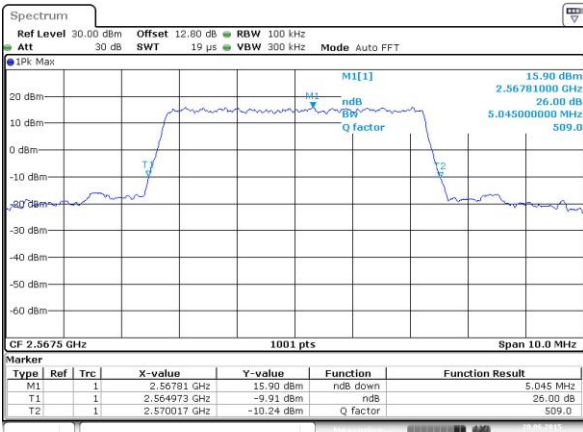

Date: 20 JUN 2015 14:23:08

Highest Channel / 5MHz / 16QAM

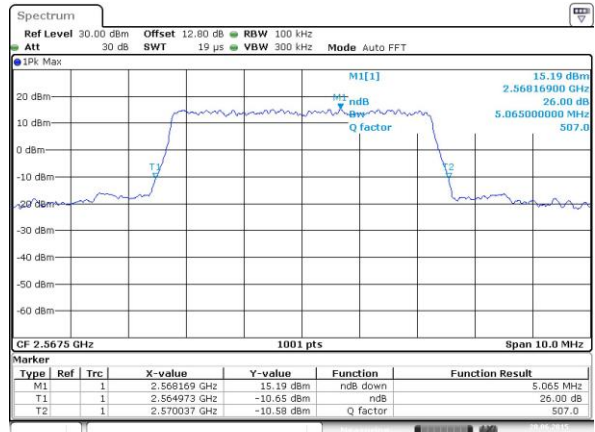

Date: 20 JUN 2015 14:23:21



LTE Band 7

Lowest Channel / 10MHz / QPSK

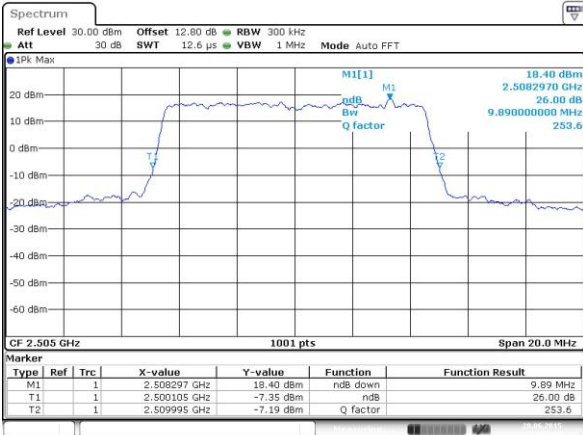

Date: 20 JUN 2015 14:30:55

Lowest Channel / 10MHz / 16QAM

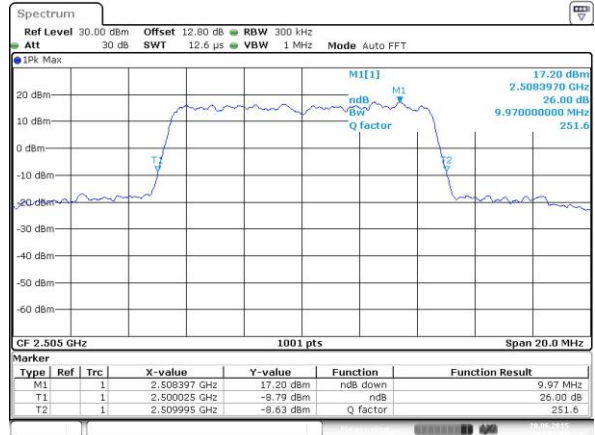

Date: 20 JUN 2015 14:31:08

Middle Channel / 10MHz / QPSK

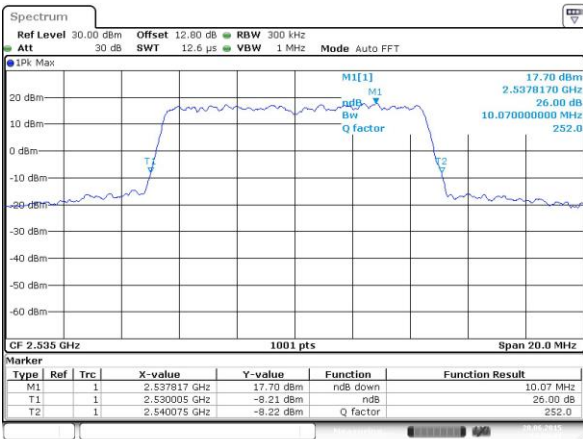

Date: 20 JUN 2015 14:38:41

Middle Channel / 10MHz / 16QAM

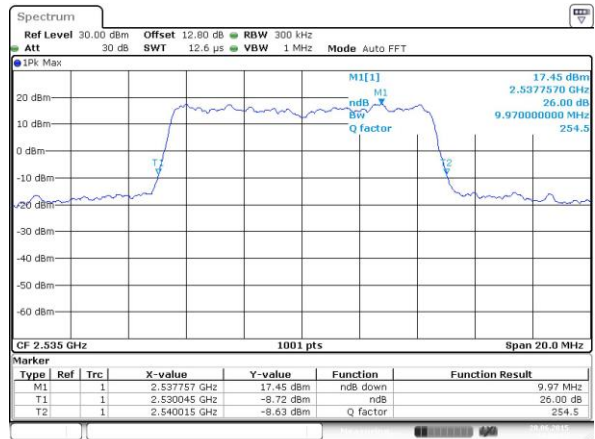

Date: 20 JUN 2015 14:38:54

Highest Channel / 10MHz / QPSK

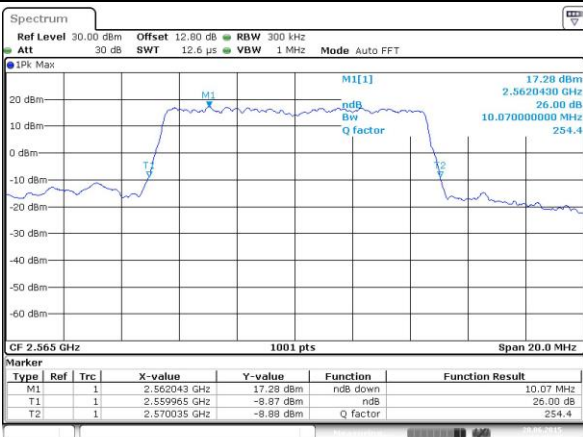

Date: 20 JUN 2015 14:41:48

Highest Channel / 10MHz / 16QAM

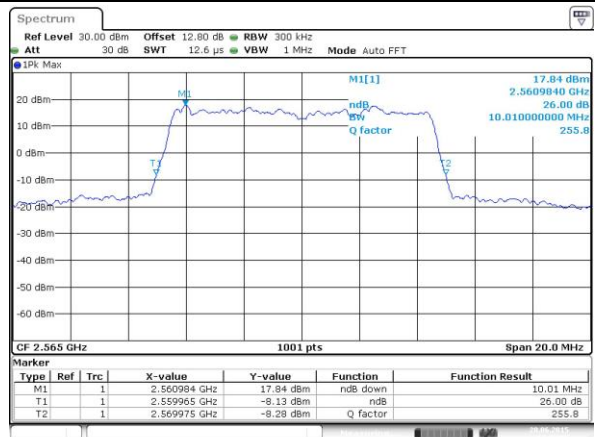

Date: 20 JUN 2015 14:42:01



LTE Band 7

Lowest Channel / 15MHz / QPSK

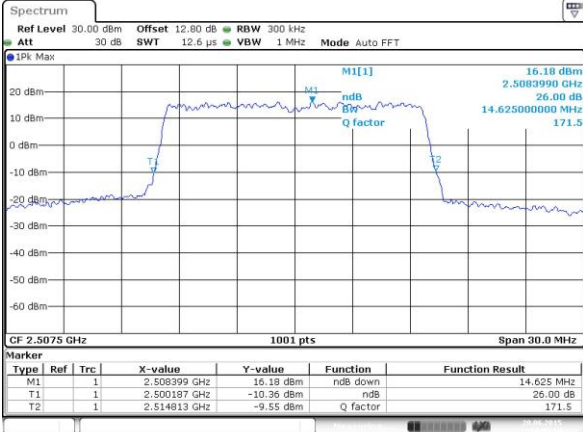

Date: 20 JUN 2015 14:49:34

Lowest Channel / 15MHz / 16QAM

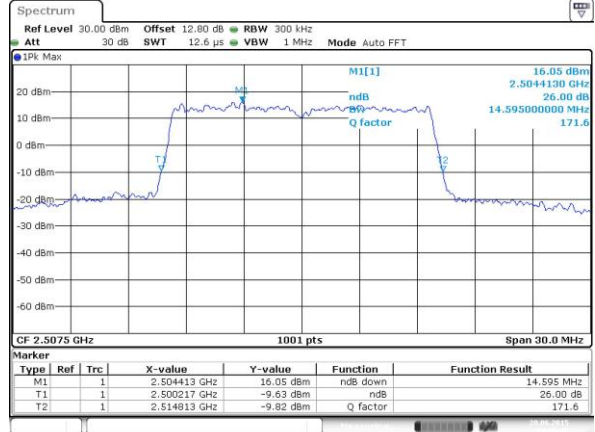

Date: 20 JUN 2015 14:49:47

Middle Channel / 15MHz / QPSK

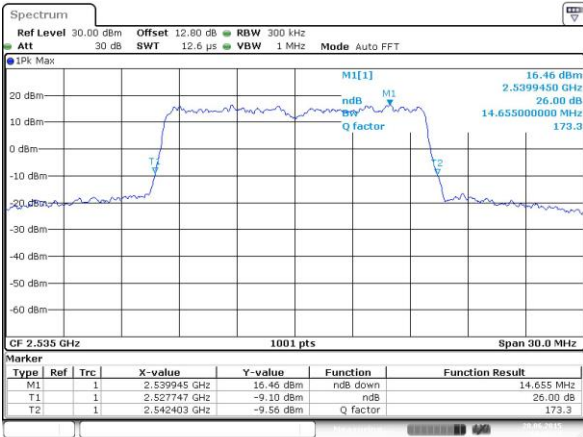

Date: 20 JUN 2015 14:57:21

Middle Channel / 15MHz / 16QAM

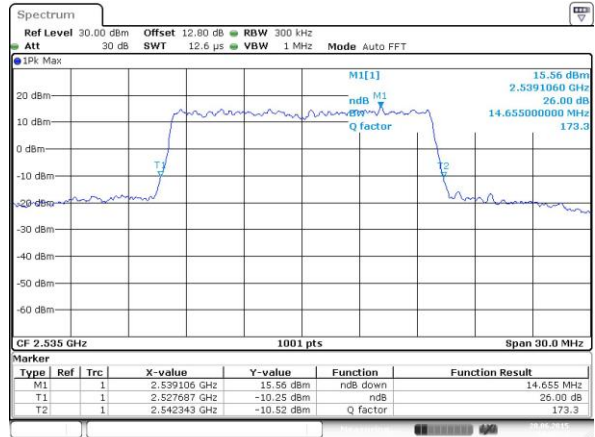

Date: 20 JUN 2015 14:57:33

Highest Channel / 15MHz / QPSK

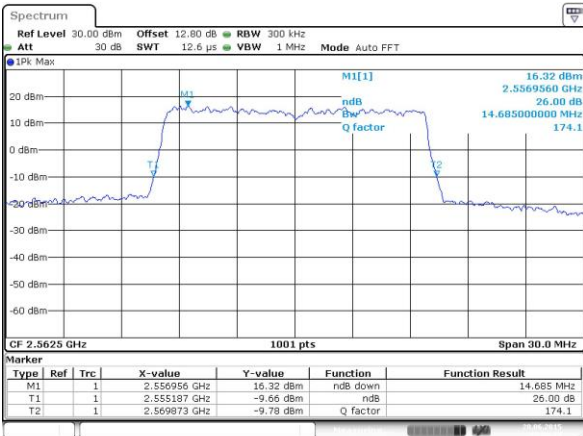

Date: 20 JUN 2015 15:00:27

Highest Channel / 15MHz / 16QAM

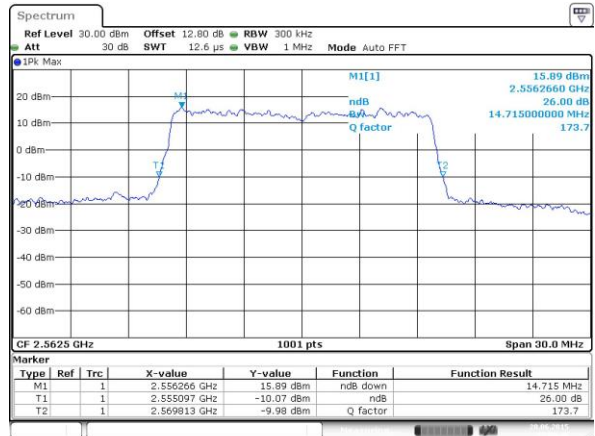

Date: 20 JUN 2015 15:00:40



LTE Band 7

Lowest Channel / 20MHz / QPSK

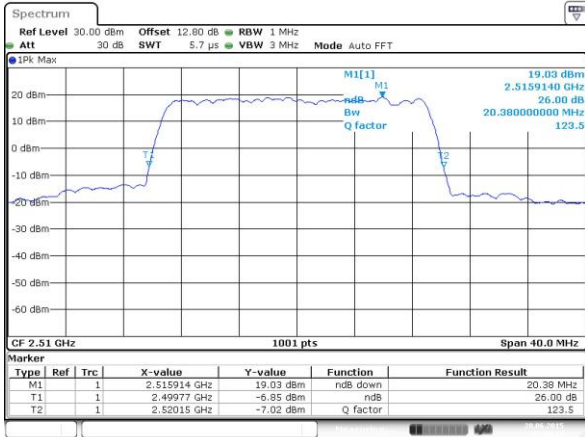

Date: 20 JUN 2015 15:08:14

Lowest Channel / 20MHz / 16QAM

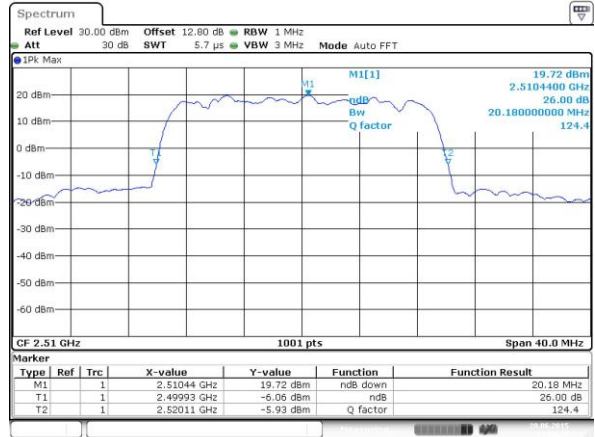

Date: 20 JUN 2015 15:08:27

Middle Channel / 20MHz / QPSK

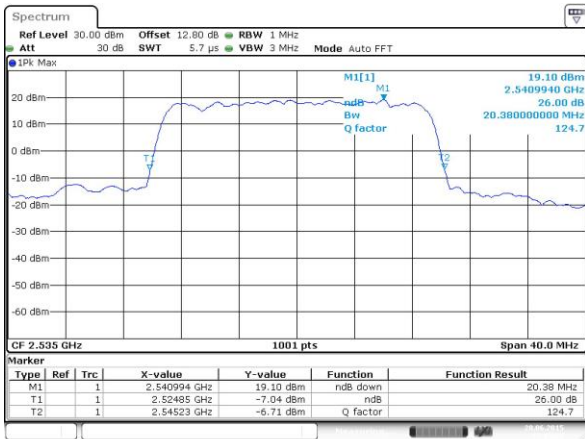

Date: 20 JUN 2015 15:16:00

Middle Channel / 20MHz / 16QAM

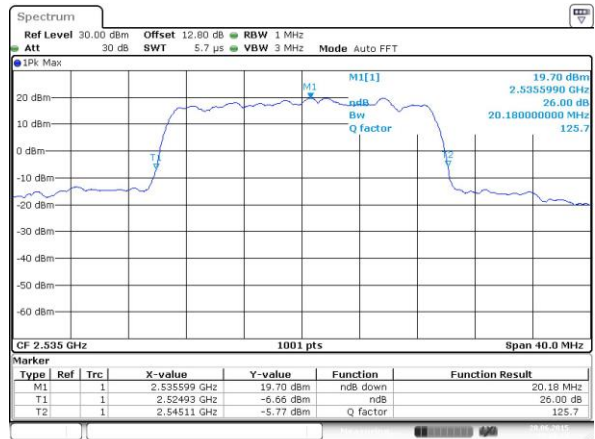

Date: 20 JUN 2015 15:16:13

Highest Channel / 20MHz / QPSK

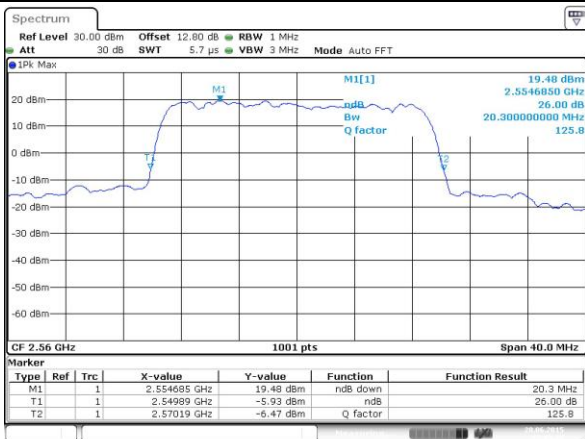

Date: 20 JUN 2015 15:19:07

Highest Channel / 20MHz / 16QAM

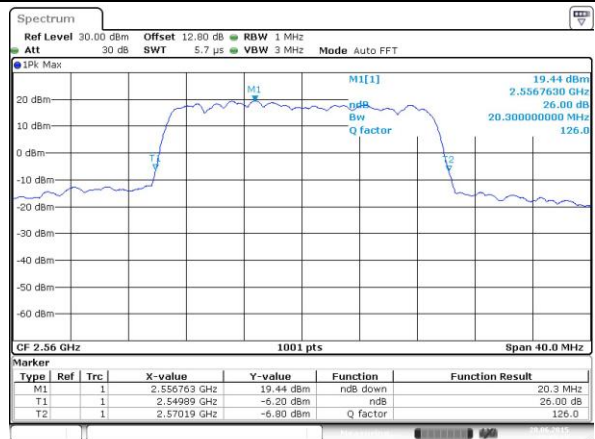

Date: 20 JUN 2015 15:19:19



Occupied Bandwidth

Mode	LTE Band 7 : 99%OBW(MHz)											
	1.4MHz		3MHz		5MHz		10MHz		15MHz		20MHz	
BW	QPSK	16QAM	QPSK	16QAM	QPSK	16QAM	QPSK	16QAM	QPSK	16QAM	QPSK	16QAM
Lowest CH	-	-	-	-	4.51	4.51	9.13	8.99	13.52	13.46	18.42	18.38
Middle CH	-	-	-	-	4.5	4.5	9.09	9.05	13.49	13.46	18.3	18.34
Highest CH	-	-	-	-	4.5	4.5	9.07	9.07	13.49	13.49	18.42	18.42



LTE Band 7

Lowest Channel / 5MHz / QPSK

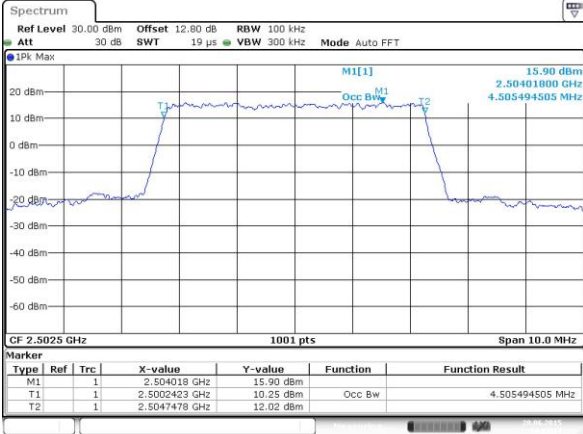

Date: 20 JUN 2015 14:11:52

Lowest Channel / 5MHz / 16QAM

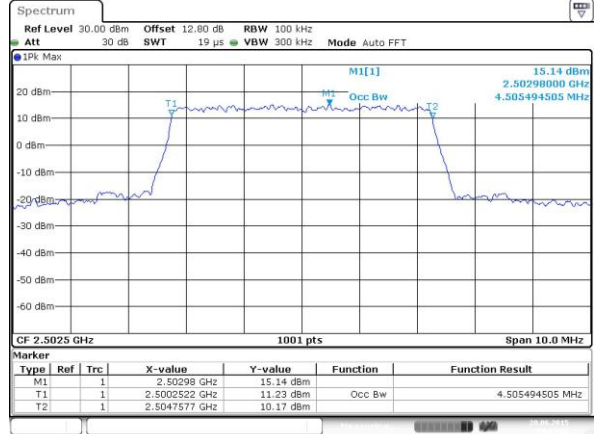

Date: 20 JUN 2015 14:12:02

Middle Channel / 5MHz / QPSK

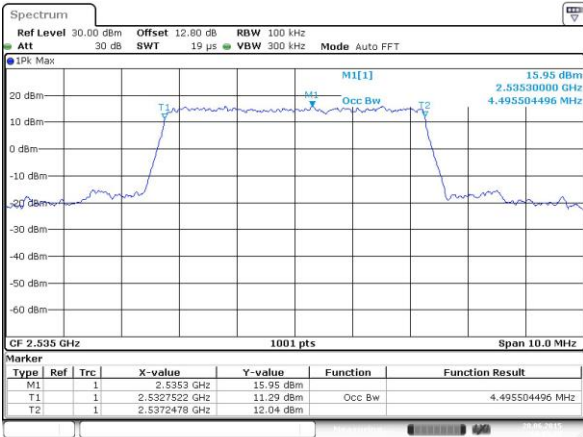

Date: 20 JUN 2015 14:19:38

Middle Channel / 5MHz / 16QAM

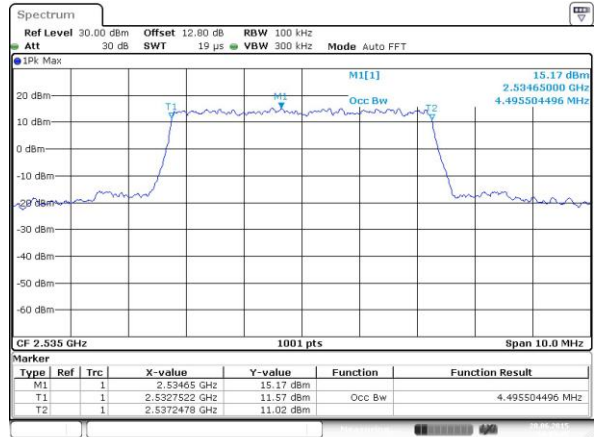

Date: 20 JUN 2015 14:19:49

Highest Channel / 5MHz / QPSK

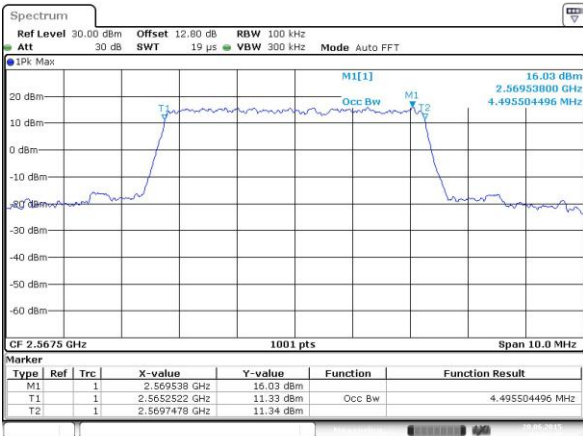

Date: 20 JUN 2015 14:22:45

Highest Channel / 5MHz / 16QAM

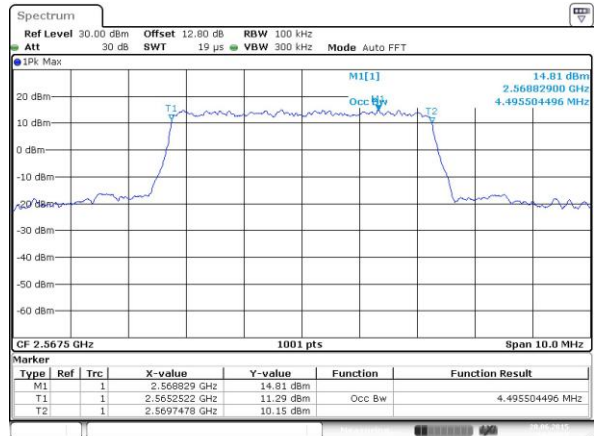

Date: 20 JUN 2015 14:22:56