



FCC RF Test Report

APPLICANT : Motorola Mobility, LLC
EQUIPMENT : Mobile Cellular Phone
BRAND NAME : Motorola
MODEL NAME : 4603
FCC ID : IHDT56UB2
STANDARD : FCC Part 15 Subpart C §15.247
CLASSIFICATION : (DTS) Digital Transmission System

The product was received on May 01, 2015. We, SPORTON INTERNATIONAL INC., would like to declare that the tested sample has been evaluated in accordance with the test procedures and has been in compliance with the applicable technical standards.

The test results in this report apply exclusively to the tested model / sample. Without written approval of SPORTON INTERNATIONAL INC., the test report shall not be reproduced except in full.

Reviewed by: Joseph Lin / Supervisor

Approved by: Jones Tsai / Manager



SPORTON INTERNATIONAL INC.

No. 52, Hwa Ya 1st Rd., Hwa Ya Technology Park, Kwei-Shan District, Tao Yuan City, Taiwan, R.O.C.

SPORTON INTERNATIONAL INC.

TEL : 886-3-327-3456

FAX : 886-3-328-4978

FCC ID : IHDT56UB2

Page Number : 1 of 4

Report Issued Date : Jul. 08, 2015

Report Version : Rev. 01

Report Template No.: BU5-FR15CBT4.0 Version 1.0



TABLE OF CONTENTS

REVISION HISTORY..... 3

1 GENERAL DESCRIPTION..... 4

 1.1 Applicant..... 4

 1.2 Manufacturer..... 4

 1.3 Product Feature of Equipment Under Test..... 4

 1.4 Product Specification subjective to this standard 4

 1.5 Modification of EUT 4

APPENDIX A. ORIGINAL REPORT



1 General Description

1.1 Applicant

Motorola Mobility, LLC

222 W Merchandise Mart Plaza, Suite 1800, Chicago, IL 60654, United States

1.2 Manufacturer

Motorola Mobility, LLC

222 W Merchandise Mart Plaza, Suite 1800, Chicago, IL 60654, United States

1.3 Product Feature of Equipment Under Test

Product Feature	
Equipment	Mobile Cellular Phone
Brand Name	Motorola
Model Name	4603
FCC ID	IHDT56UB2
EUT supports Radios application	GSM/EGPRS/WCDMA/HSPA/LTE/NFC/FM 2.4GHz WLAN 11b/g/n HT20 5GHz WLAN 11a/n HT20/HT40 Bluetooth v2.1 EDR Bluetooth v4.1 - LE
HW Version	P2
EUT Stage	Identical Prototype

Remark: The above EUT's information was declared by manufacturer. Please refer to the specifications or user's manual for more detailed description.

1.4 Product Specification subjective to this standard

Product Specification subjective to this standard	
Tx/Rx Frequency Range	2402 MHz ~ 2480 MHz
Number of Channels	40
Carrier Frequency of Each Channel	40 Channel(37 hopping + 3 advertising channel)
Antenna Type	Fixed Internal Antenna type (The antenna peak gain of EUT is less than 6 dBi)
Type of Modulation	Bluetooth LE : GFSK

1.5 Modification of EUT

No modifications are made to the EUT during all test items.



Appendix A. Original Report

Please refer to Sporton report number FR550147B as below.



FCC RF Test Report

APPLICANT : Motorola Mobility, LLC
EQUIPMENT : Mobile Cellular Phone
BRAND NAME : Motorola
MODEL NAME : 4602
FCC ID : IHDT56UB1
STANDARD : FCC Part 15 Subpart C §15.247
CLASSIFICATION : (DTS) Digital Transmission System

The product was received on May 01, 2015 and testing was completed on Jun. 11, 2015. We, SPORTON INTERNATIONAL INC., would like to declare that the tested sample has been evaluated in accordance with the test procedures and has been in compliance with the applicable technical standards.

The test results in this report apply exclusively to the tested model / sample. Without written approval of SPORTON INTERNATIONAL INC., the test report shall not be reproduced except in full.

Reviewed by: Joseph Lin / Supervisor

Approved by: Jones Tsai / Manager



SPORTON INTERNATIONAL INC.

No. 52, Hwa Ya 1st Rd., Hwa Ya Technology Park, Kwei-Shan District, Tao Yuan City, Taiwan, R.O.C.

SPORTON INTERNATIONAL INC.

TEL : 886-3-327-3456

FAX : 886-3-328-4978

FCC ID : IHDT56UB1

Page Number : 1 of 47

Report Issued Date : Jul. 01, 2015

Report Version : Rev. 01

Report Template No.: BU5-FR15CBT4.0 Version 1.0



TABLE OF CONTENTS

SUMMARY OF TEST RESULT 4

1 GENERAL DESCRIPTION..... 5

1.1 Applicant 5

1.2 Manufacturer..... 5

1.3 Product Feature of Equipment Under Test..... 5

1.4 Product Specification subjective to this standard 6

1.5 Modification of EUT 6

1.6 Testing Location 6

1.7 Applicable Standards..... 7

2 TEST CONFIGURATION OF EQUIPMENT UNDER TEST..... 8

2.1 Descriptions of Test Mode 8

2.2 Test Mode..... 9

2.3 Connection Diagram of Test System..... 10

2.4 Support Unit used in test configuration and system 12

2.5 EUT Operation Test Setup 12

2.6 Measurement Results Explanation Example..... 12

3 TEST RESULT 13

3.1 6dB Bandwidth Measurement 13

3.2 Peak Output Power Measurement 16

3.3 Power Spectral Density Measurement 18

3.4 Conducted Band Edges and Spurious Emission Measurement 23

3.5 Radiated Band Edges and Spurious Emission Measurement 31

3.6 AC Conducted Emission Measurement..... 35

3.7 Antenna Requirements..... 45

4 LIST OF MEASURING EQUIPMENT..... 46

5 UNCERTAINTY OF EVALUATION..... 47

APPENDIX A. RADIATED TEST RESULTS



SUMMARY OF TEST RESULT

Report Section	FCC Rule	Description	Limit	Result	Remark
3.1	15.247(a)(2)	6dB Bandwidth	$\geq 0.5\text{MHz}$	Pass	-
3.2	15.247(b)(1)	Peak Output Power	$\leq 30\text{dBm}$	Pass	-
3.3	15.247(e)	Power Spectral Density	$\leq 8\text{dBm}/3\text{kHz}$	Pass	-
3.4	15.247(d)	Conducted Band Edges and Spurious Emission	$\leq 20\text{dBc}$	Pass	-
3.5	15.247(d)	Radiated Band Edges and Spurious Emission	15.209(a) & 15.247(d)	Pass	Under limit 4.67 dB at 31.080 MHz
3.6	15.207	AC Conducted Emission	15.207(a)	Pass	Under limit 8.10 dB at 2.862 MHz
3.7	15.203 & 15.247(b)	Antenna Requirement	N/A	Pass	-



1 General Description

1.1 Applicant

Motorola Mobility, LLC

222 W Merchandise Mart Plaza, Suite 1800, Chicago, IL 60654, United States

1.2 Manufacturer

Motorola Mobility, LLC

222 W Merchandise Mart Plaza, Suite 1800, Chicago, IL 60654, United States

1.3 Product Feature of Equipment Under Test

Product Feature	
Equipment	Mobile Cellular Phone
Brand Name	Motorola
Model Name	4602
FCC ID	IHDT56UB1
IMEI Code	990006240086388 (for AC Conducted Emission) 990006240060151 (for Radiated Spurious Emission)
EUT supports Radios application	CDMA/EV-DO/GSM/EGPRS/WCDMA/HSPA/LTE/NFC WLAN 11b/g/n HT20 WLAN 11a/n HT20/HT40 Bluetooth 2.1 EDR Bluetooth 4.1 - LE
HW Version	P2
EUT Stage	Identical Prototype

Remark: The above EUT's information was declared by manufacturer. Please refer to the specifications or user's manual for more detailed description.

Accessory List	
AC Adapter 1	Brand Name : Motorola
	Model Name : SPN5791A
AC Adapter 2	Brand Name : Motorola
	Model Name : SPN5865A
Battery	Brand Name : Motorola
	Model Name : FL40
USB Cable	Brand Name : Motorola
	Model Name : SKN6461A
Earphone	Brand Name : Motorola
	Model Name : 89719N



1.4 Product Specification subjective to this standard

Product Specification subjective to this standard	
Tx/Rx Frequency Range	2402 MHz ~ 2480 MHz
Number of Channels	40
Carrier Frequency of Each Channel	40 Channel(37 hopping + 3 advertising channel)
Maximum Output Power to Antenna	2.54 dBm (0.0018 W)
Antenna Type	Fixed Internal Antenna Type (The antenna peak gain of EUT is less than 6 dBi)
Type of Modulation	Bluetooth LE : GFSK

1.5 Modification of EUT

No modifications are made to the EUT during all test items.

1.6 Testing Location

Sporton Lab is accredited to ISO 17025 by Taiwan Accreditation Foundation (TAF code : 1190) and the FCC designation No. TW1022 under the FCC 2.948(e) by Mutual Recognition Agreement (MRA) in FCC Test.

Test Site	SPORTON INTERNATIONAL INC.		
Test Site Location	No. 52, Hwa Ya 1 st Rd., Hwa Ya Technology Park, Kwei-Shan District, Tao Yuan City, Taiwan, R.O.C. TEL: +886-3-327-3456 FAX: +886-3-328-4978		
Test Site No.	Sporton Site No.		
	TH02-HY	CO05-HY	03CH07-HY

Note: The test site complies with ANSI C63.4 2009 requirement.



1.7 Applicable Standards

According to the specifications of the manufacturer, the EUT must comply with the requirements of the following standards:

- ♦ FCC Part 15 Subpart C §15.247
- ♦ FCC KDB Publication No. 558074 D01 DTS Meas. Guidance v03r03
- ♦ ANSI C63.10-2009

Remark:

1. All test items were verified and recorded according to the standards and without any deviation during the test.
2. FCC permits the use of the 1.5 meter table as an alternative in C63.10-2013 through inquiry tracking number 961829.
3. This EUT has also been tested and complied with the requirements of FCC Part 15, Subpart B, recorded in a separate test report.



2 Test Configuration of Equipment Under Test

2.1 Descriptions of Test Mode

The RF output power was recorded in the following table:

Channel	Frequency	Bluetooth 4.1 – LE RF Output Power (Peak)	
		Data Rate / Modulation	
		GFSK	
		1Mbps	
Ch00	2402MHz	2.29 dBm	
Ch19	2440MHz	2.54 dBm	
Ch39	2480MHz	2.03 dBm	

Channel	Frequency	Bluetooth 4.1 – LE RF Output Power (Average)	
		Data Rate / Modulation	
		GFSK	
		1Mbps	
Ch00	2402MHz	1.55 dBm	
Ch19	2440MHz	1.82 dBm	
Ch39	2480MHz	1.18 dBm	

- a. The EUT has been associated with peripherals and configuration operated in a manner tended to maximize its emission characteristics in a typical application. Frequency range investigated: conduction (150 kHz to 30 MHz), radiation (9 kHz to the 10th harmonic of the highest fundamental frequency or to 40 GHz, whichever is lower). Pre-scanned tests, X, Y, Z in three orthogonal panels to determine the final configuration (X plane as worst plane) from all possible combinations.
- b. AC power line Conducted Emission was tested under maximum output power.



2.2 Test Mode

The following summary table is showing all test modes to demonstrate in compliance with the standard.

Summary table of Test Cases	
Test Item	Data Rate / Modulation
	Bluetooth 4.1 – LE / GFSK
Conducted TCs	Mode 1: Bluetooth Tx CH00_2402 MHz_1Mbps Mode 2: Bluetooth Tx CH19_2440 MHz_1Mbps Mode 3: Bluetooth Tx CH39_2480 MHz_1Mbps
Radiated TCs	Mode 1: Bluetooth Tx CH00_2402 MHz_1Mbps Mode 2: Bluetooth Tx CH19_2440 MHz_1Mbps Mode 3: Bluetooth Tx CH39_2480 MHz_1Mbps
AC Conducted Emission	Mode 1 :GSM850 Idle + Bluetooth Link + WLAN (2.4GHz) Link + Earphone + USB Cable (Charging from Adapter 1) + MP3 Mode 2 :GSM850 Idle + Bluetooth Link + WLAN (2.4GHz) Link + Earphone + USB Cable (Charging from Adapter 2) + MP3
Remark: The worst case of conducted emission is mode 2; only the test data of it was reported.	

2.3 Connection Diagram of Test System

<Bluetooth 4.1 – LE Tx Mode>

<For Adapter 1>

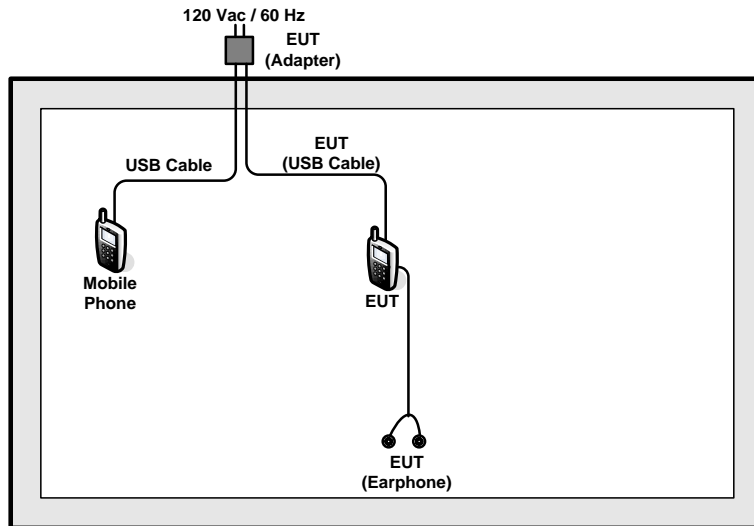

<For Adapter 2>

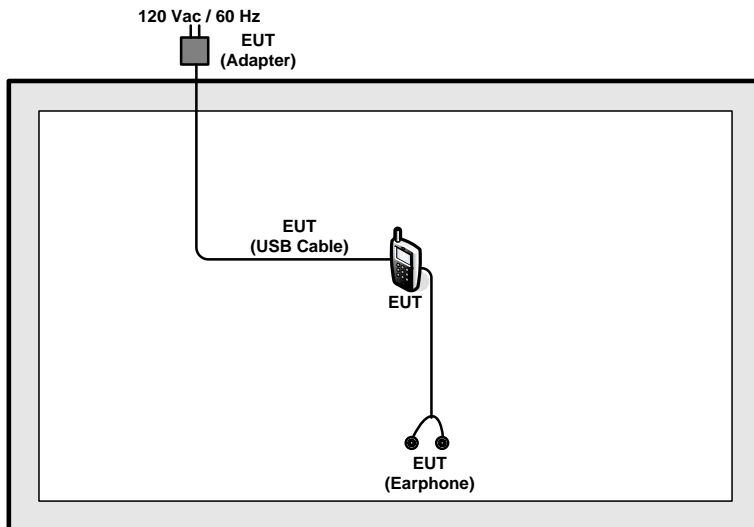

<AC Conducted Emission Mode>

<For Adapter 1>

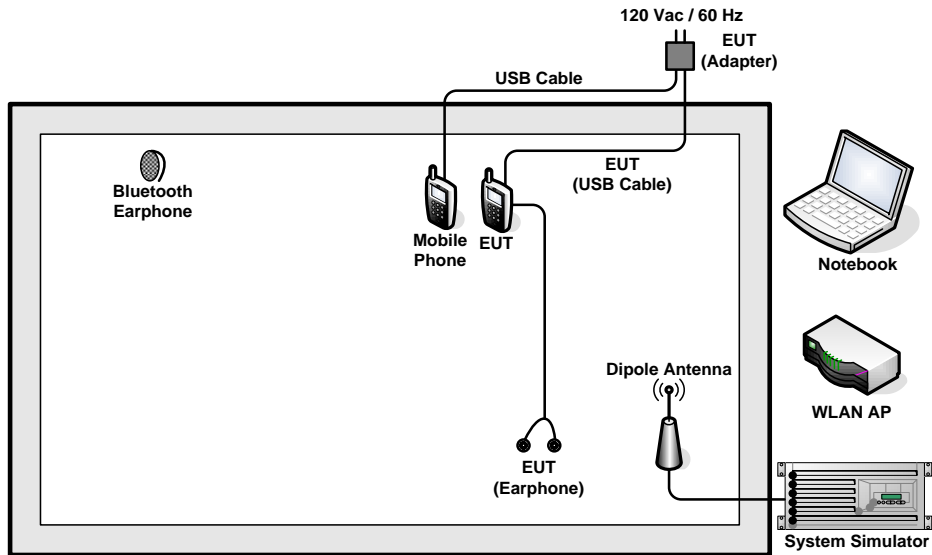

<For Adapter 2>

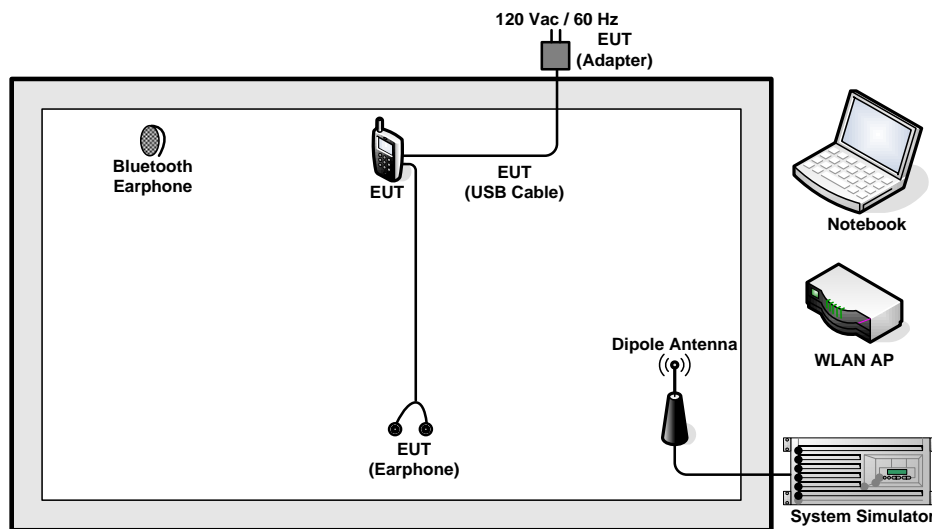



2.4 Support Unit used in test configuration and system

Item	Equipment	Trade Name	Model Name	FCC ID	Data Cable	Power Cord
1.	System Simulator	Anritsu	MT8820C	N/A	N/A	Unshielded, 1.8 m
2.	Bluetooth Earphone	Sony Ericsson	MW600	PY7DDA-2029	N/A	N/A
3.	WLAN AP	D-Link	DIR-628	KA2DIR628A2	N/A	Unshielded, 1.8 m
4.	Notebook	DELL	Latitude E6320	FCC DoC/ Contains FCC ID: QDS-BRCM1054	N/A	AC I/P: Unshielded, 1.2 m DC O/P: Shielded, 1.8 m
5.	Mobile Cellular Phone	Motorola	4602	IHDT56UB1	N/A	N/A
6.	SD Card	SanDisk	MicroSD HC	FCC DoC	N/A	N/A

2.5 EUT Operation Test Setup

For Bluetooth function, programmed RF utility, "QRCT" installed in the EUT provide functions like channel selection and power level for continuous transmitting and receiving signals.

2.6 Measurement Results Explanation Example

For all conducted test items:

The offset level is set in the spectrum analyzer to compensate the RF cable loss and attenuator factor between EUT conducted output port and spectrum analyzer. With the offset compensation, the spectrum analyzer reading level is exactly the EUT RF output level.

Example :

The spectrum analyzer offset is derived from RF cable loss and attenuator factor.

Offset = RF cable loss + attenuator factor.

Following shows an offset computation example with cable loss 4.2 dB and 10dB attenuator.

$$\begin{aligned} \text{Offset(dB)} &= \text{RF cable loss(dB)} + \text{attenuator factor(dB)}. \\ &= 4.2 + 10 = 14.2 \text{ (dB)} \end{aligned}$$

3 Test Result

3.1 6dB Bandwidth Measurement

3.1.1 Limit of 6dB Bandwidth

The minimum 6 dB bandwidth shall be at least 500 kHz.

3.1.2 Measuring Instruments

The measuring equipment is listed in the section 4 of this test report.

3.1.3 Test Procedures

1. The testing follows FCC KDB Publication No. 558074 D01 DTS Meas. Guidance v03r03.
2. The RF output of EUT was connected to the spectrum analyzer by RF cable and attenuator. The path loss was compensated to the results for each measurement.
3. Set to the maximum power setting and enable the EUT transmit continuously.
4. Make the measurement with the spectrum analyzer's resolution bandwidth (RBW) = 100 kHz. Set the Video bandwidth (VBW) = 300 kHz. In order to make an accurate measurement. The 6 dB bandwidth must be greater than 500 kHz.
5. Measure and record the results in the test report.

3.1.4 Test Setup

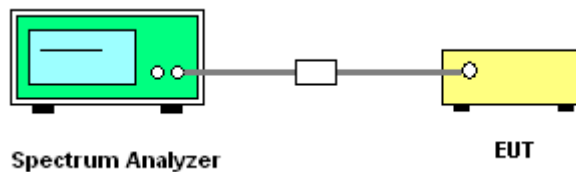



3.1.5 Test Result of 6dB Bandwidth

Test Mode :	Bluetooth 4.1 - LE	Temperature :	22~25°C
Test Engineer :	Luffy Lin	Relative Humidity :	51~55%

Channel	Frequency (MHz)	6dB Bandwidth (MHz)	6dB Bandwidth Min. Limit (MHz)	Pass/Fail
00	2402	0.648	0.5	Pass
19	2440	0.668	0.5	Pass
39	2480	0.672	0.5	Pass

6 dB Bandwidth Plot on Channel 00

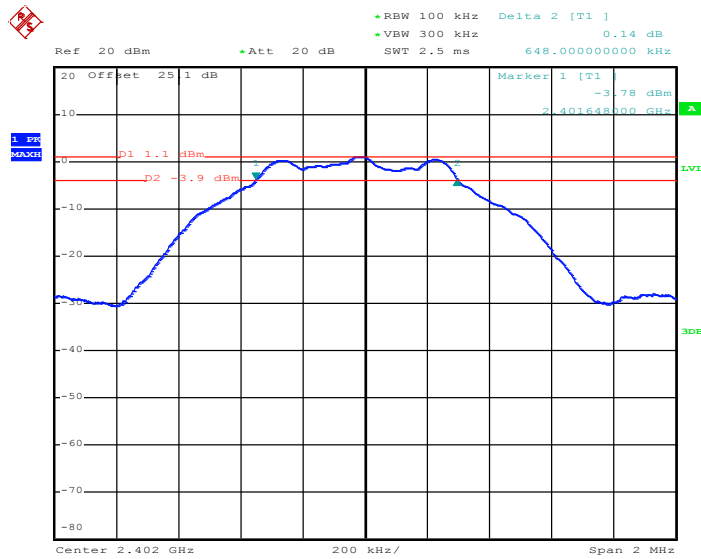

Date: 24.MAY.2015 05:52:12



6 dB Bandwidth Plot on Channel 19

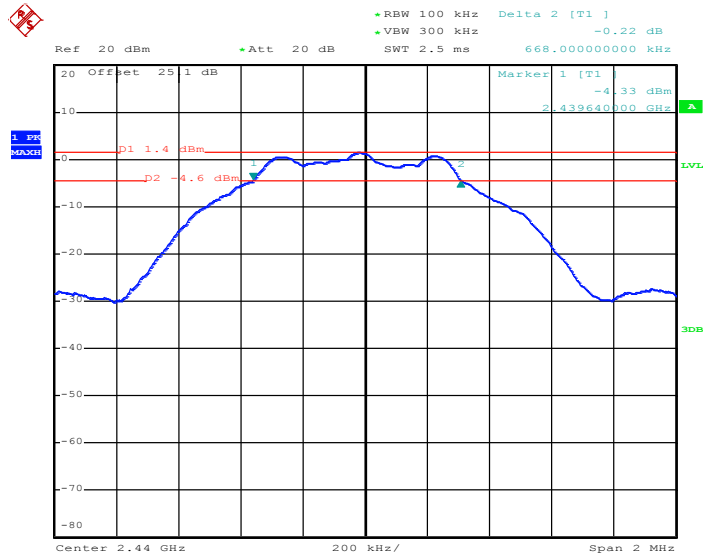

Date: 24.MAY.2015 05:58:25

6 dB Bandwidth Plot on Channel 39

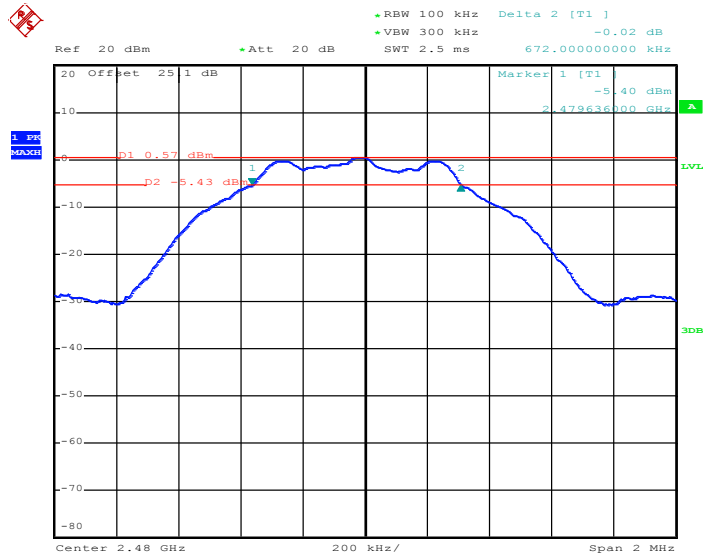

Date: 24.MAY.2015 06:03:33

3.2 Peak Output Power Measurement

3.2.1 Limit of Peak Output Power

For systems using digital modulation in the 2400-2483.5MHz, the limit for peak output power is 30dBm. If transmitting antenna of directional gain greater than 6dBi is used, the peak output power from the intentional radiator shall be reduced below the above stated value by the amount in dB that the directional gain of the antenna exceeds 6 dBi. In case of point-to-point operation, the limit has to be reduced by 1dB for every 3dB that the directional gain of the antenna exceeds 6dBi.

3.2.2 Measuring Instruments

The measuring equipment is listed in the section 4 of this test report.

3.2.3 Test Procedures

1. The testing follows the Measurement Procedure of FCC KDB No. 558074 DTS D01 Meas. Guidance v03r03.
2. The RF output of EUT was connected to the power meter by RF cable and attenuator. The path loss was compensated to the results for each measurement.
3. Set to the maximum power setting and enable the EUT transmit continuously.
4. Measure the conducted output power and record the results in the test report.

3.2.4 Test Setup

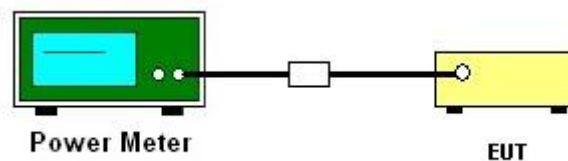



3.2.5 Test Result of Peak Output Power

Test Mode :	Bluetooth 4.1 - LE	Temperature :	22~25°C
Test Engineer :	Luffy Lin	Relative Humidity :	51~55%

Channel	Frequency (MHz)	RF Power (dBm)		
		GFSK	Max. Limits (dBm)	Pass/Fail
		1 Mbps		
00	2402	2.29	30.00	Pass
19	2440	2.54	30.00	Pass
39	2480	2.03	30.00	Pass

3.3 Power Spectral Density Measurement

3.3.1 Limit of Power Spectral Density

The peak power spectral density shall not be greater than 8dBm in any 3kHz band at any time interval of continuous transmission.

3.3.2 Measuring Instruments

The measuring equipment is listed in the section 4 of this test report.

3.3.3 Test Procedures

1. The testing follows Measurement Procedure 10.2 Method PKPSD of FCC KDB Publication No. 558074 D01 DTS Meas. Guidance v03r03
2. The RF output of EUT was connected to the spectrum analyzer by RF cable and attenuator. The path loss was compensated to the results for each measurement.
3. Set to the maximum power setting and enable the EUT transmit continuously.
4. Make the measurement with the spectrum analyzer's resolution bandwidth (RBW) = 3 kHz. Video bandwidth VBW = 10 kHz In order to make an accurate measurement, set the span to 1.5 times DTS Channel Bandwidth. (6dB BW)
5. Detector = peak, Sweep time = auto couple, Trace mode = max hold, Allow trace to fully stabilize. Use the peak marker function to determine the maximum power level.
6. Measure and record the results in the test report.
7. The Measured power density (dBm)/ 100kHz is a reference level and used as 20dBc down limit line for Conducted Band Edges and Conducted Spurious Emission.

3.3.4 Test Setup

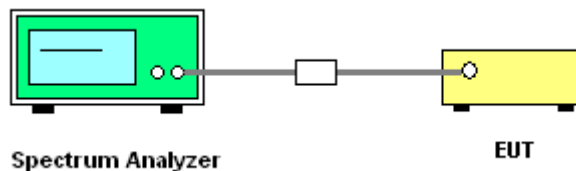



3.3.5 Test Result of Power Spectral Density

Test Mode :	Bluetooth 4.1 - LE	Temperature :	22~25°C
Test Engineer :	Luffy Lin	Relative Humidity :	51~55%

Channel	Frequency (MHz)	Power Density		Max. Limits (dBm/3kHz)	Pass/Fail
		PSD/100kHz (dBm)	PSD/3kHz (dBm)		
00	2402	1.08	-14.16	8	Pass
19	2440	1.39	-13.73	8	Pass
39	2480	0.58	-14.59	8	Pass

Note:

1. Measured power density (dBm) has offset with cable loss.
2. The Measured power density (dBm)/ 100kHz is reference level and used as 20dBc down for Conducted Band Edges and Conducted Spurious Emission limit line.

3.3.6 Test Result of Power Spectral Density Plots (100kHz)

PSD 100kHz Plot on Channel 00

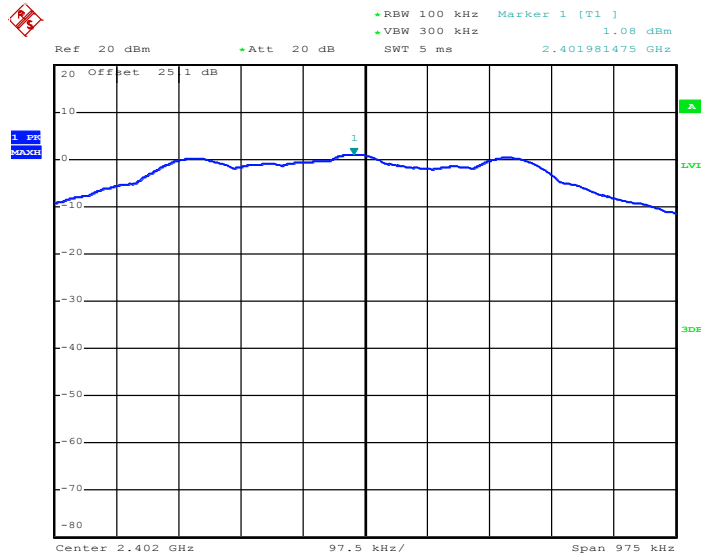

Date: 24.MAY.2015 05:52:57



PSD 100kHz Plot on Channel 19

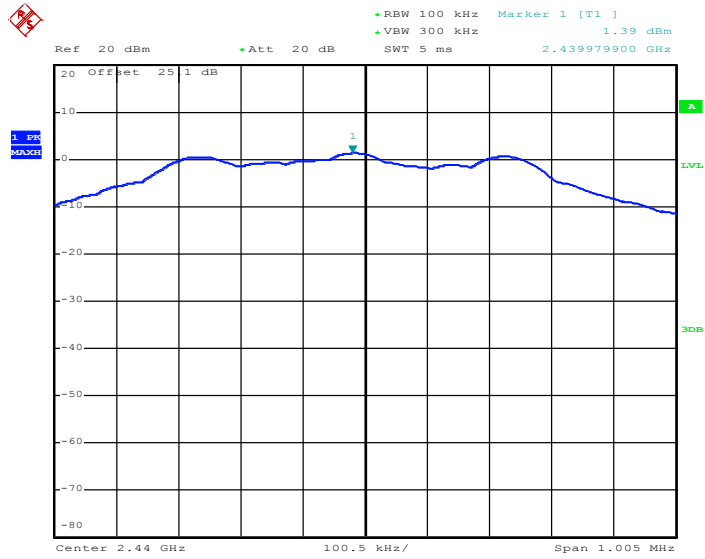

Date: 24.MAY.2015 05:59:10

PSD 100kHz Plot on Channel 39

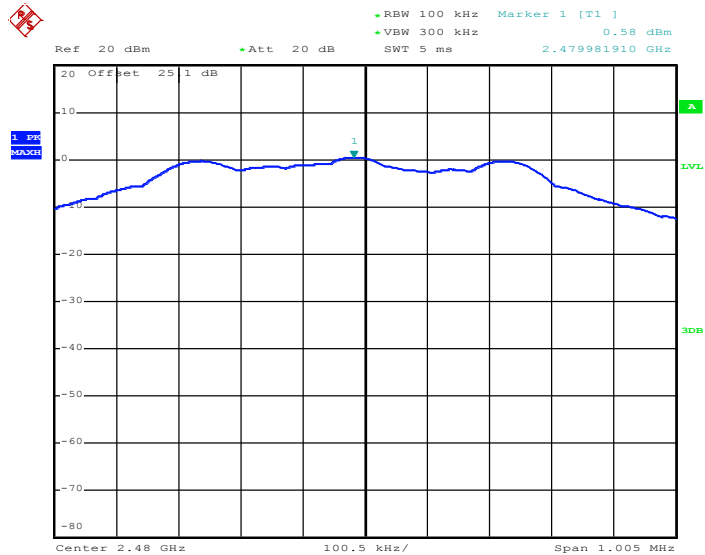

Date: 24.MAY.2015 06:04:18



3.3.7 Test Result of Power Spectral Density Plots (3kHz)

PSD 3kHz Plot on Channel 00

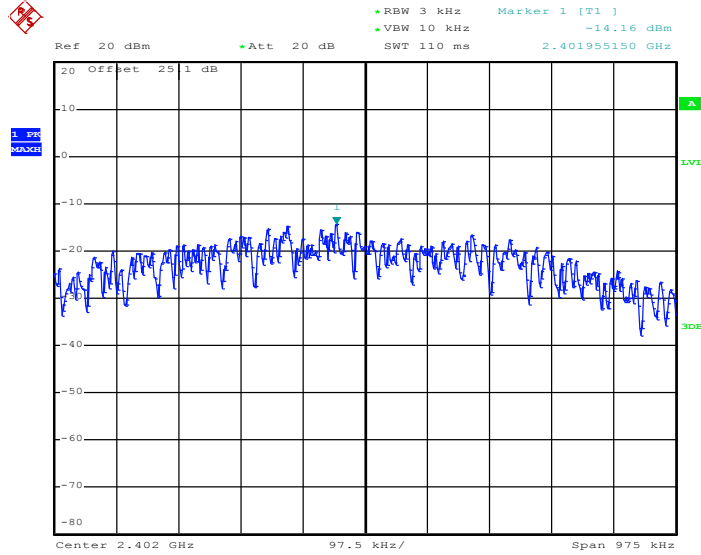

Date: 24.MAY.2015 05:52:36

PSD 3kHz Plot on Channel 19

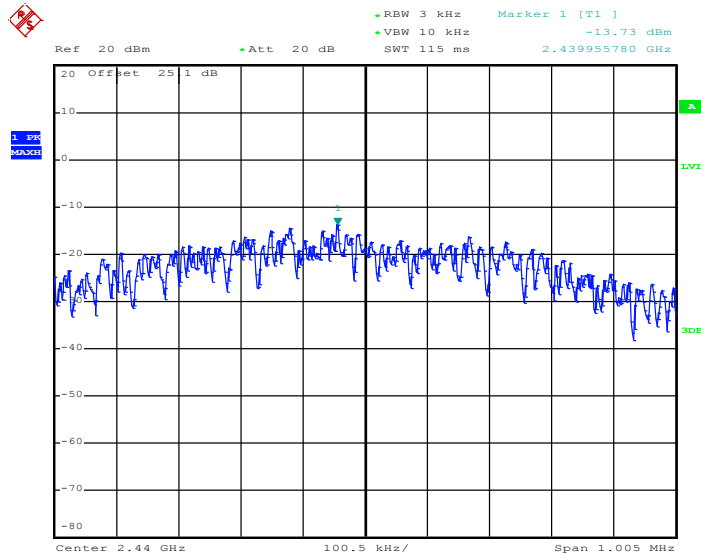

Date: 24.MAY.2015 05:58:48

3.4 Conducted Band Edges and Spurious Emission Measurement

3.4.1 Limit of Conducted Band Edges and Spurious Emission

All harmonics/spurious must be at least 20 dB down from the highest emission level within the authorized band.

3.4.2 Measuring Instruments

The measuring equipment is listed in the section 4 of this test report.

3.4.3 Test Procedure

1. The testing follows FCC KDB Publication No. 558074 D01 DTS Meas. Guidance v03r03.
2. The RF output of EUT was connected to the spectrum analyzer by RF cable and attenuator. The path loss was compensated to the results for each measurement.
3. Set to the maximum power setting and enable the EUT transmit continuously.
4. Set RBW = 100 kHz, VBW=300 kHz, Peak Detector. Unwanted Emissions measured in any 100 kHz bandwidth outside of the authorized frequency band shall be attenuated by at least 20 dB relative to the maximum in-band peak PSD level in 100 kHz when maximum peak conducted output power procedure is used. If the transmitter complies with the conducted power limits based on the use of RMS averaging over a time interval, the attenuation required under this paragraph shall be 30 dB instead of 20 dB per 15.247(d).
5. Measure and record the results in the test report.
6. The RF fundamental frequency should be excluded against the limit line in the operating frequency band.

3.4.4 Test Setup

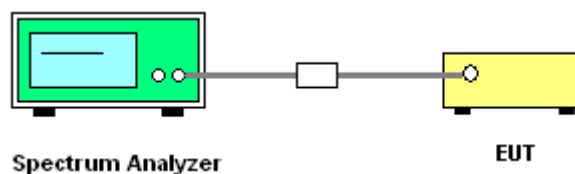



3.4.5 Test Result of Conducted Band Edges

Test Mode :	Bluetooth 4.1 - LE	Temperature :	22~25°C
Test Channel :	00 and 39	Relative Humidity :	51~55%
		Test Engineer :	Luffy Lin

Low Band Edge Plot on Channel 00

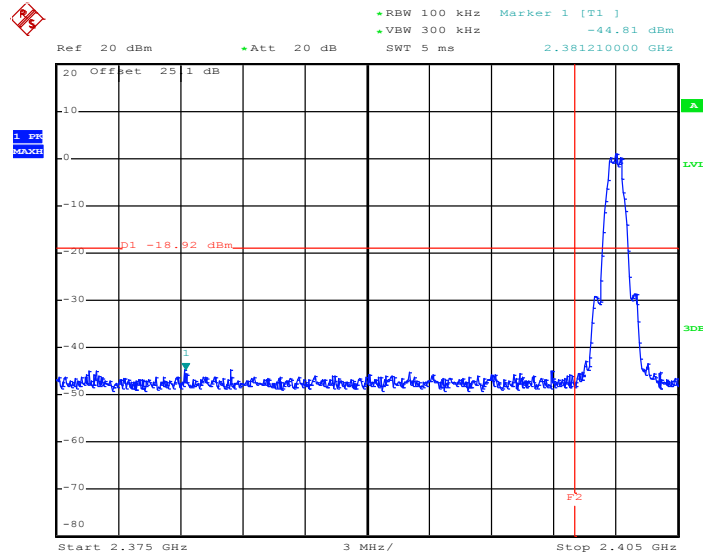

Date: 24.MAY.2015 05:53:13

High Band Edge Plot on Channel 39

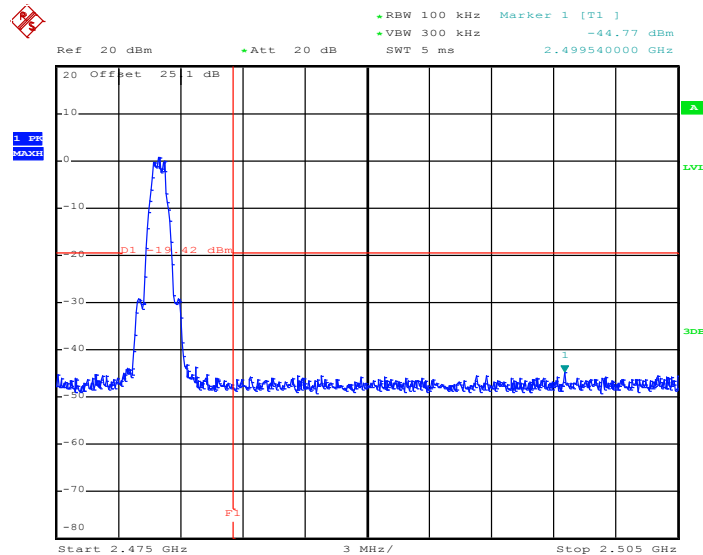

Date: 24.MAY.2015 06:04:35



3.4.6 Test Result of Conducted Spurious Emission

Test Mode :	Bluetooth 4.1 - LE	Temperature :	22~25°C
Test Channel :	00	Relative Humidity :	51~55%
		Test Engineer :	Luffy Lin

Conducted Spurious Emission Plot on Bluetooth LE 1Mbps GFSK Channel 00

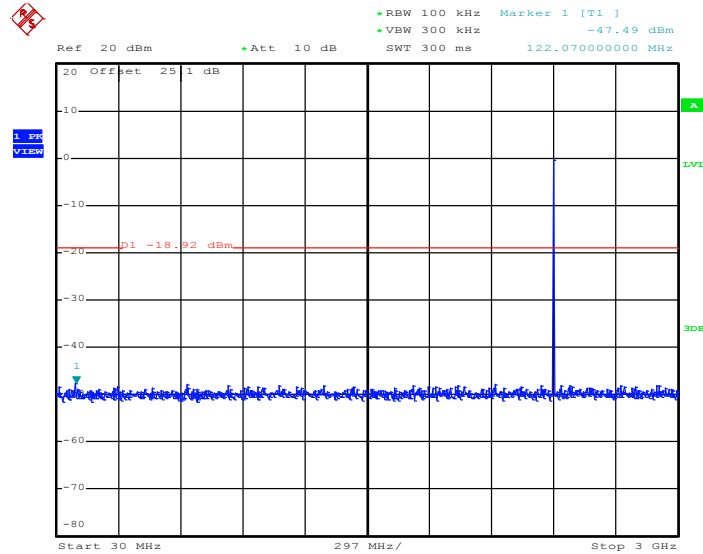

Date: 24.MAY.2015 05:53:35



Conducted Spurious Emission Plot on Bluetooth LE 1Mbps
GFSK Channel 00

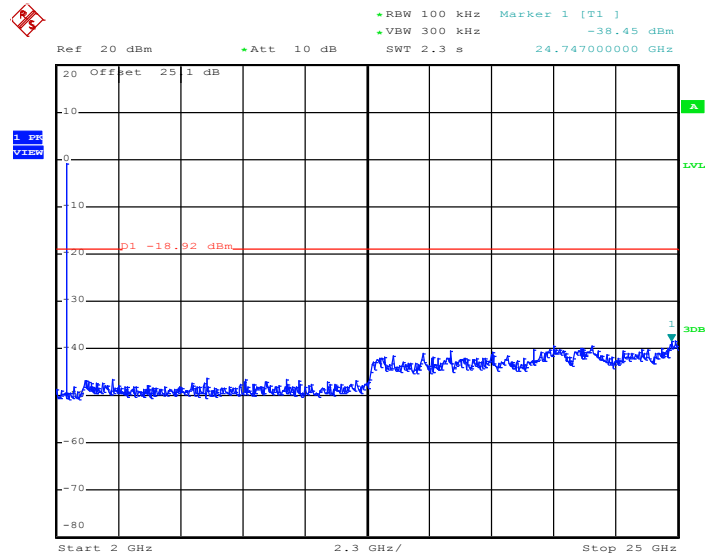

Date: 24.MAY.2015 05:53:53



Test Mode :	Bluetooth 4.1 - LE	Temperature :	22~25°C
Test Channel :	19	Relative Humidity :	51~55%
		Test Engineer :	Luffy Lin

Conducted Spurious Emission Plot on Bluetooth LE 1Mbps
GFSK Channel 19

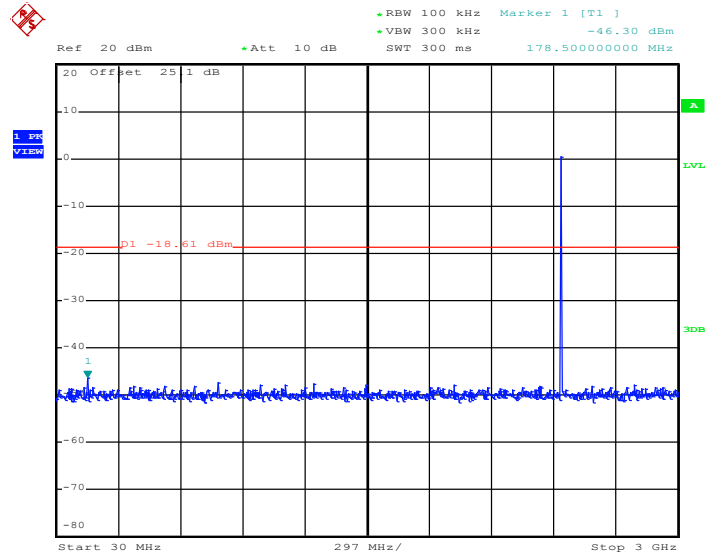

Date: 24.MAY.2015 05:59:34



Conducted Spurious Emission Plot on Bluetooth LE 1Mbps
GFSK Channel 19

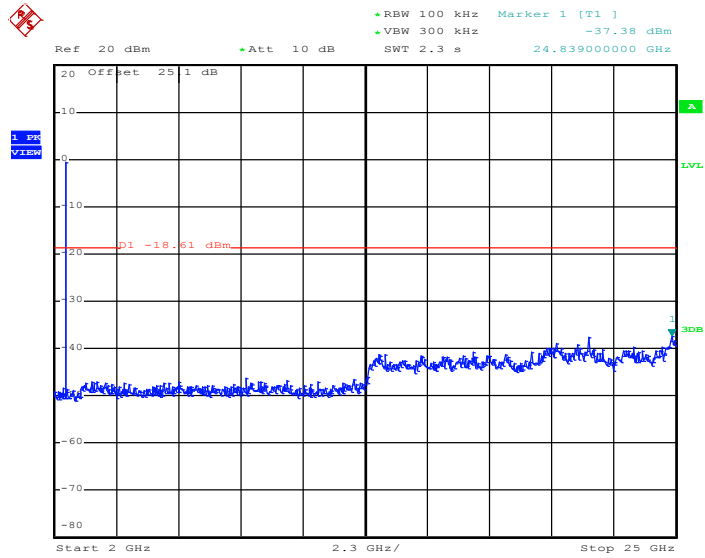

Date: 24.MAY.2015 05:59:52



Test Mode :	Bluetooth 4.1 - LE	Temperature :	22~25°C
Test Channel :	39	Relative Humidity :	51~55%
		Test Engineer :	Luffy Lin

Conducted Spurious Emission Plot on Bluetooth LE 1Mbps
GFSK Channel 39

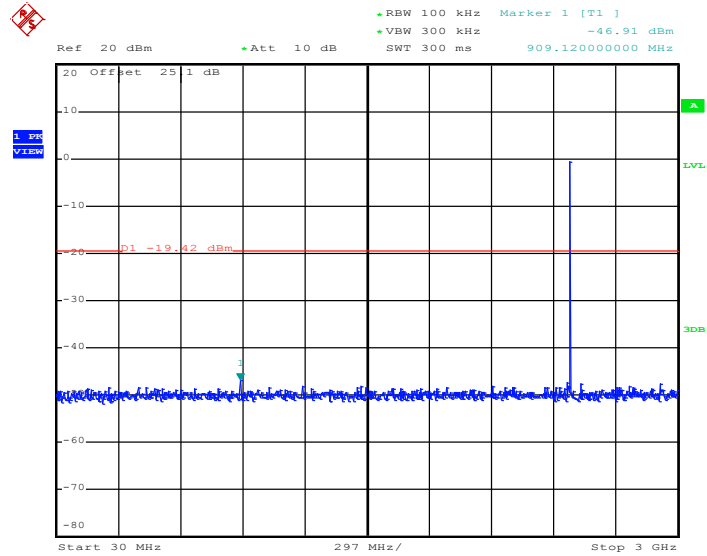

Date: 24.MAY.2015 06:05:00



Conducted Spurious Emission Plot on Bluetooth LE 1Mbps
GFSK Channel 39

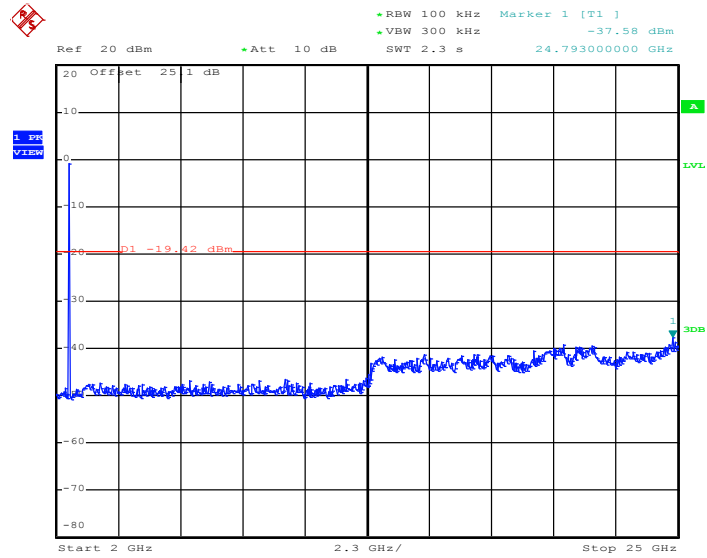

Date: 24.MAY.2015 06:05:18



3.5 Radiated Band Edges and Spurious Emission Measurement

3.5.1 Limit of Radiated Band Edges and Spurious Emission

In any 100 kHz bandwidth outside the intentional radiator frequency band, all harmonics/spurious must be at least 20 dB below the highest emission level within the authorized band. If the output power of this device was measured by spectrum analyzer, the attenuation under this paragraph shall be 30 dB instead of 20 dB. In addition, radiated emissions which fall in the restricted bands must also comply with the FCC section 15.209 limits as below.

Frequency (MHz)	Field Strength (microvolts/meter)	Measurement Distance (meters)
0.009 – 0.490	2400/F(kHz)	300
0.490 – 1.705	24000/F(kHz)	30
1.705 – 30.0	30	30
30 – 88	100	3
88 – 216	150	3
216 - 960	200	3
Above 960	500	3

3.5.2 Measuring Instruments

The measuring equipment is listed in the section 4 of this test report.



3.5.3 Test Procedures

1. The testing follows FCC KDB Publication No. 558074 D01 DTS Meas. Guidance v03r03.
2. The EUT was arranged to its worst case and then tune the antenna tower (from 1 m to 4 m) and turntable (from 0 degree to 360 degrees) to find the maximum reading. A pre-amp and a high pass filter are used for the test in order to get better signal level.
3. The EUT was placed on a turntable with 0.8 meter for frequency below 1GHz and 1.5 meter for frequency above 1GHz respectively above ground.
4. The EUT was set 3 meters from the interference receiving antenna, which was mounted on the top of a variable height antenna tower.
5. Corrected Reading: Antenna Factor + Cable Loss + Read Level - Preamp Factor = Level
6. For measurement below 1GHz, If the emission level of the EUT measured by the peak detector is 3 dB lower than the applicable limit, the peak emission level will be reported. Otherwise, the emission measurement will be repeated using the quasi-peak detector and reported.
7. Use the following spectrum analyzer settings:
 - (1) Span shall wide enough to fully capture the emission being measured;
 - (2) Set RBW=100 kHz for $f < 1 \text{ GHz}$; $\text{VBW} \geq \text{RBW}$; Sweep = auto; Detector function = peak; Trace = max hold;
 - (3) Set RBW = 1 MHz, VBW= 3MHz for $f \geq 1 \text{ GHz}$ for peak measurement.

For average measurement:

 - $\text{VBW} = 10 \text{ Hz}$, when duty cycle is no less than 98 percent.
 - $\text{VBW} \geq 1/T$, when duty cycle is less than 98 percent where T is the minimum transmission duration over which the transmitter is on and is transmitting at its maximum power control level for the tested mode of operation.

Band	Duty Cycle(%)	T(μs)	1/T(kHz)	VBW Setting
Bluetooth 4.1 - LE	60.31	380.00	2.63	3kHz

3.5.4 Test Setup

For radiated emissions below 30MHz

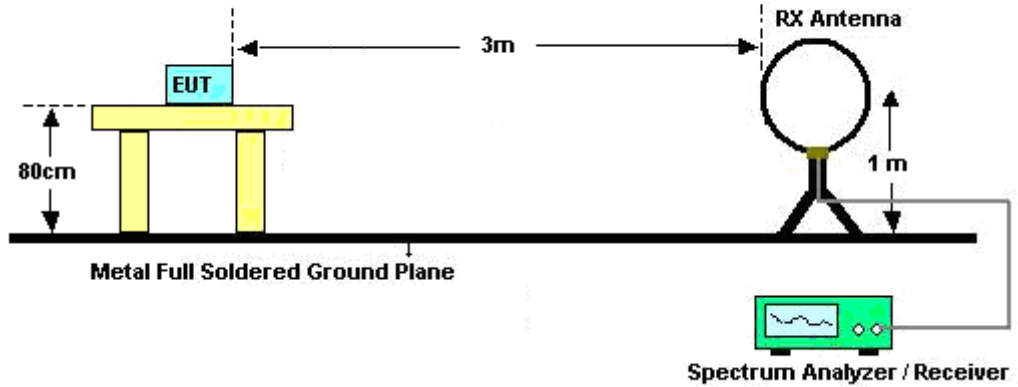

For radiated emissions from 30MHz to 1GHz

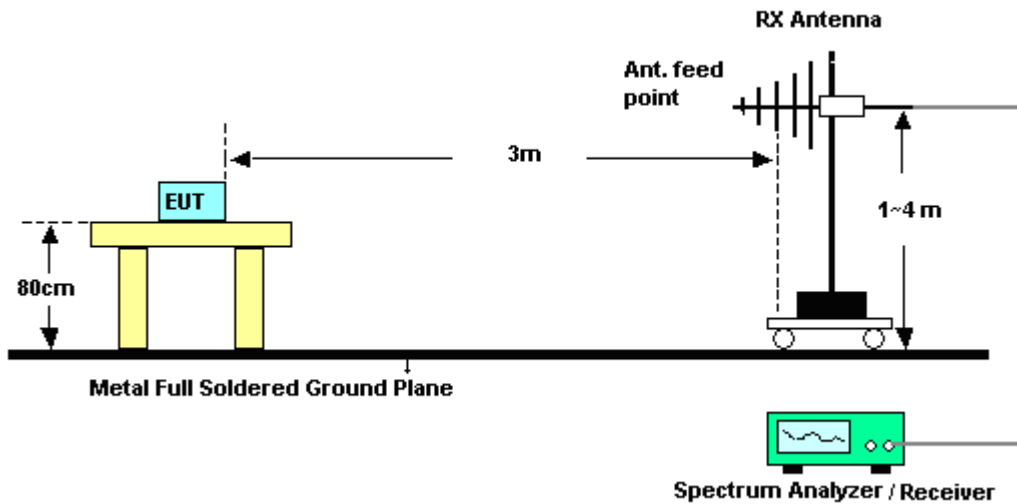

For radiated emissions above 1GHz

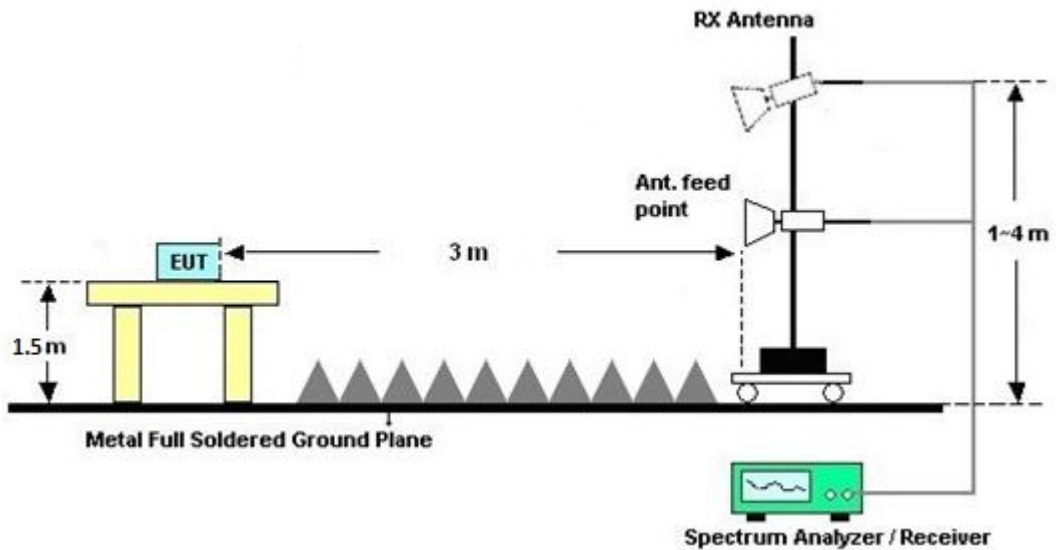

3.5.5 Test Results of Radiated Spurious Emissions (9 kHz ~ 30 MHz)

The low frequency, which started from 9 kHz to 30MHz, was pre-scanned and the result which was 20dB lower than the limit line per 15.31(o) was not reported.

3.5.6 Test Result of Radiated Spurious at Band Edges

Please refer to Appendix A.

3.5.7 Test Result of Radiated Spurious Emission (30MHz ~ 10th Harmonic)

Please refer to Appendix A.



3.6 AC Conducted Emission Measurement

3.6.1 Limit of AC Conducted Emission

For equipment that is designed to be connected to the public utility (AC) power line, the radio frequency voltage that is conducted back onto the AC power line on any frequency or frequencies within the band 150 kHz to 30 MHz shall not exceed the limits in the following table.

Frequency of emission (MHz)	Conducted limit (dB μ V)	
	Quasi-peak	Average
0.15-0.5	66 to 56*	56 to 46*
0.5-5	56	46
5-30	60	50

*Decreases with the logarithm of the frequency.

3.6.2 Measuring Instruments

The measuring equipment is listed in the section 4 of this test report.

3.6.3 Test Procedures

1. The EUT was placed 0.4 meter from the conducting wall of the shielding room was kept at least 80 centimeters from any other grounded conducting surface.
2. Connect EUT to the power mains through a line impedance stabilization network (LISN).
3. All the support units are connecting to the other LISN.
4. The LISN provides 50 ohm coupling impedance for the measuring instrument.
5. The FCC states that a 50 ohm, 50 microhenry LISN should be used.
6. Both sides of AC line were checked for maximum conducted interference.
7. The frequency range from 150 kHz to 30 MHz was searched.
8. Set the test-receiver system to Peak Detect Function and specified bandwidth (IF Bandwidth = 9kHz) with Maximum Hold Mode. Then measurement is also conducted by Average Detector and Quasi-Peak Detector Function respectively.

3.6.4 Test Setup

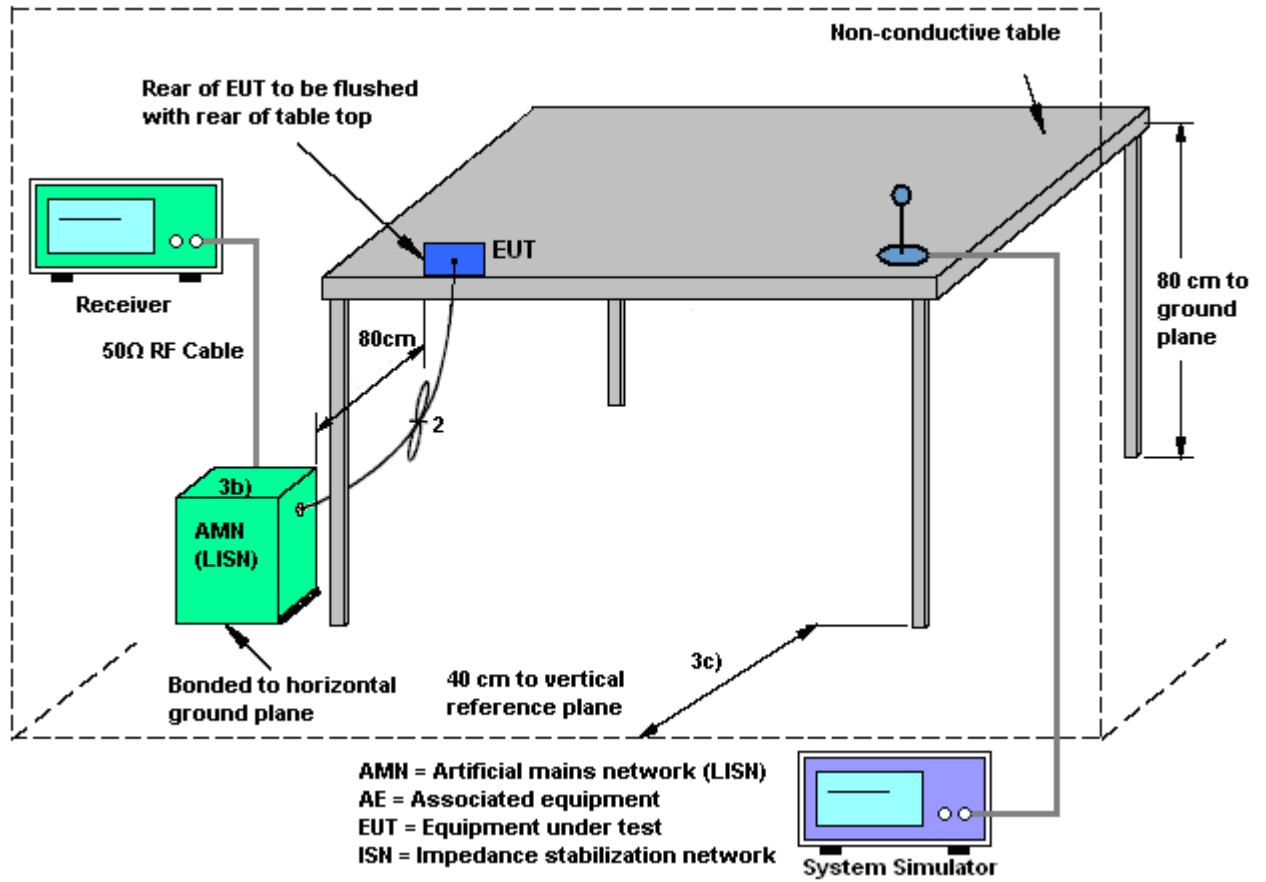



3.6.5 Test Result of AC Conducted Emission

Test Mode :	Mode 2	Temperature :	21~23°C
Test Engineer :	Eric Jeng	Relative Humidity :	59~61%
Test Voltage :	120Vac / 60Hz	Phase :	Line
Function Type :	GSM850 Idle + Bluetooth Link + WLAN (2.4GHz) Link + Earphone + USB Cable (Charging from Adapter 2) + MP3		

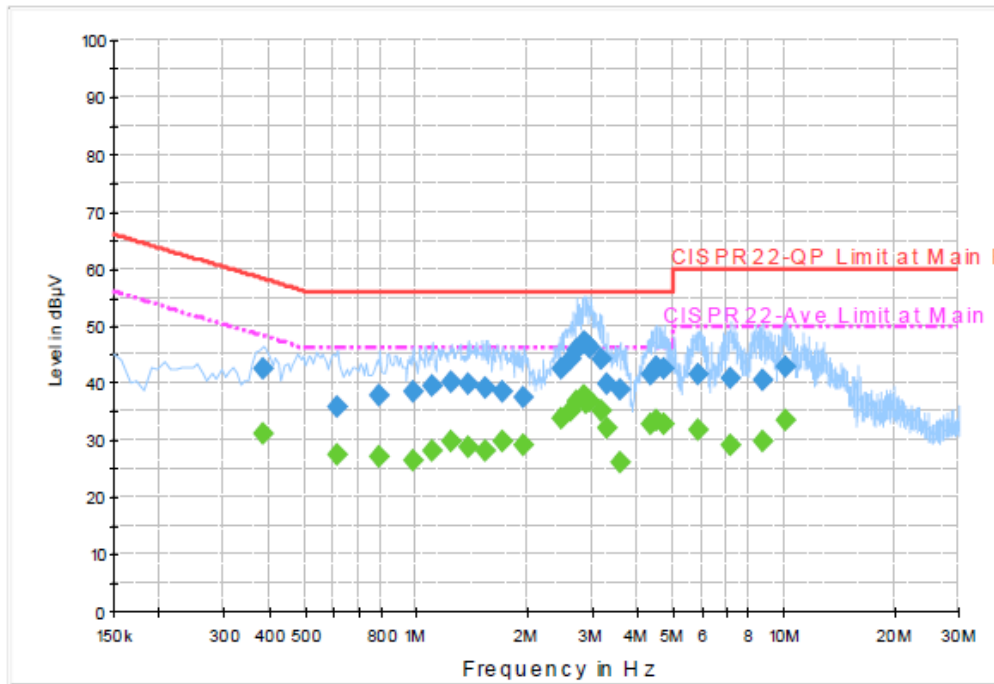

Final Result : Quasi-Peak

Frequency (MHz)	Quasi-Peak (dBµV)	Filter	Line	Corr. (dB)	Margin (dB)	Limit (dBµV)
0.382000	42.4	Off	L1	19.5	15.8	58.2
0.614000	35.7	Off	L1	19.5	20.3	56.0
0.798000	37.7	Off	L1	19.5	18.3	56.0
0.982000	38.4	Off	L1	19.6	17.6	56.0
1.110000	39.4	Off	L1	19.5	16.6	56.0
1.246000	40.2	Off	L1	19.6	15.8	56.0
1.382000	39.8	Off	L1	19.6	16.2	56.0
1.550000	39.0	Off	L1	19.5	17.0	56.0
1.718000	38.6	Off	L1	19.6	17.4	56.0
1.966000	37.4	Off	L1	19.6	18.6	56.0
2.502000	42.5	Off	L1	19.7	13.5	56.0
2.646000	44.2	Off	L1	19.7	11.8	56.0
2.734000	45.8	Off	L1	19.7	10.2	56.0
2.862000	47.1	Off	L1	19.7	8.9	56.0
2.918000	46.9	Off	L1	19.7	9.1	56.0
2.990000	46.1	Off	L1	19.7	9.9	56.0



Test Mode :	Mode 2	Temperature :	21~23°C
Test Engineer :	Eric Jeng	Relative Humidity :	59~61%
Test Voltage :	120Vac / 60Hz	Phase :	Line
Function Type :	GSM850 Idle + Bluetooth Link + WLAN (2.4GHz) Link + Earphone + USB Cable (Charging from Adapter 2) + MP3		

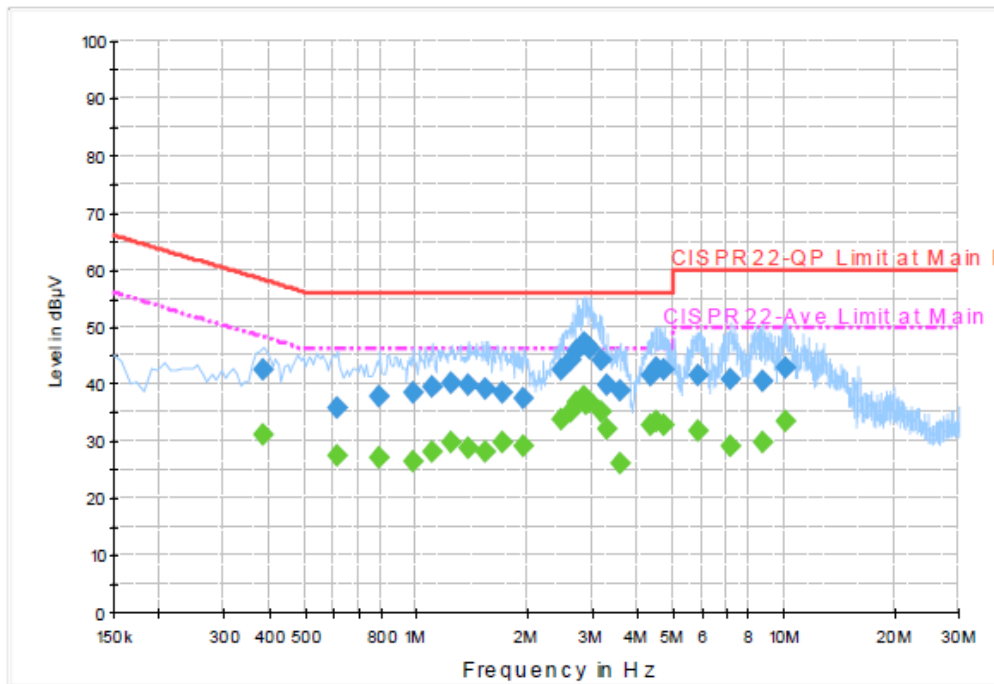

Final Result : Quasi-Peak

Frequency (MHz)	Quasi-Peak (dBµV)	Filter	Line	Corr. (dB)	Margin (dB)	Limit (dBµV)
3.198000	44.1	Off	L1	19.7	11.9	56.0
3.326000	39.9	Off	L1	19.8	16.1	56.0
3.582000	38.7	Off	L1	19.7	17.3	56.0
4.342000	41.4	Off	L1	19.7	14.6	56.0
4.518000	42.7	Off	L1	19.8	13.3	56.0
4.742000	42.3	Off	L1	19.7	13.7	56.0
5.862000	41.5	Off	L1	19.7	18.5	60.0
7.206000	40.8	Off	L1	19.8	19.2	60.0
8.782000	40.4	Off	L1	19.8	19.6	60.0
10.190000	42.7	Off	L1	19.8	17.3	60.0



Test Mode :	Mode 2	Temperature :	21~23°C
Test Engineer :	Eric Jeng	Relative Humidity :	59~61%
Test Voltage :	120Vac / 60Hz	Phase :	Line
Function Type :	GSM850 Idle + Bluetooth Link + WLAN (2.4GHz) Link + Earphone + USB Cable (Charging from Adapter 2) + MP3		

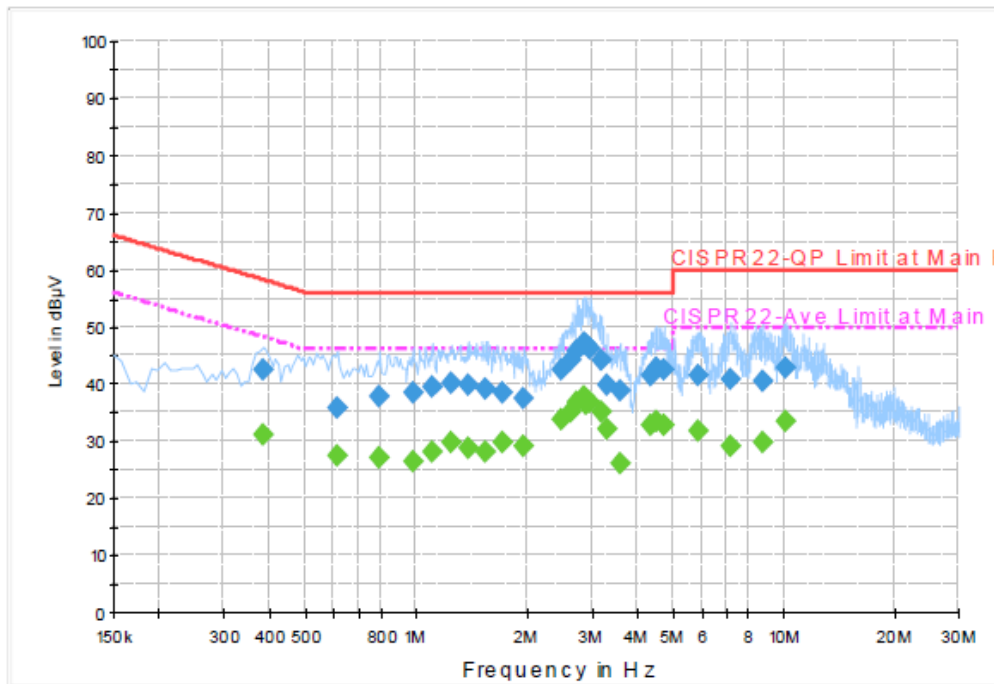

Final Result : Average

Frequency (MHz)	Average (dBµV)	Filter	Line	Corr. (dB)	Margin (dB)	Limit (dBµV)
0.382000	31.0	Off	L1	19.5	17.2	48.2
0.614000	27.6	Off	L1	19.5	18.4	46.0
0.798000	27.2	Off	L1	19.5	18.8	46.0
0.982000	26.3	Off	L1	19.6	19.7	46.0
1.110000	28.1	Off	L1	19.5	17.9	46.0
1.246000	29.6	Off	L1	19.6	16.4	46.0
1.382000	28.8	Off	L1	19.6	17.2	46.0
1.550000	28.2	Off	L1	19.5	17.8	46.0
1.718000	29.7	Off	L1	19.6	16.3	46.0
1.966000	29.0	Off	L1	19.6	17.0	46.0
2.502000	33.6	Off	L1	19.7	12.4	46.0
2.646000	35.3	Off	L1	19.7	10.7	46.0
2.734000	36.7	Off	L1	19.7	9.3	46.0
2.862000	37.9	Off	L1	19.7	8.1	46.0
2.918000	36.6	Off	L1	19.7	9.4	46.0
2.990000	36.6	Off	L1	19.7	9.4	46.0



Test Mode :	Mode 2	Temperature :	21~23°C
Test Engineer :	Eric Jeng	Relative Humidity :	59~61%
Test Voltage :	120Vac / 60Hz	Phase :	Line
Function Type :	GSM850 Idle + Bluetooth Link + WLAN (2.4GHz) Link + Earphone + USB Cable (Charging from Adapter 2) + MP3		

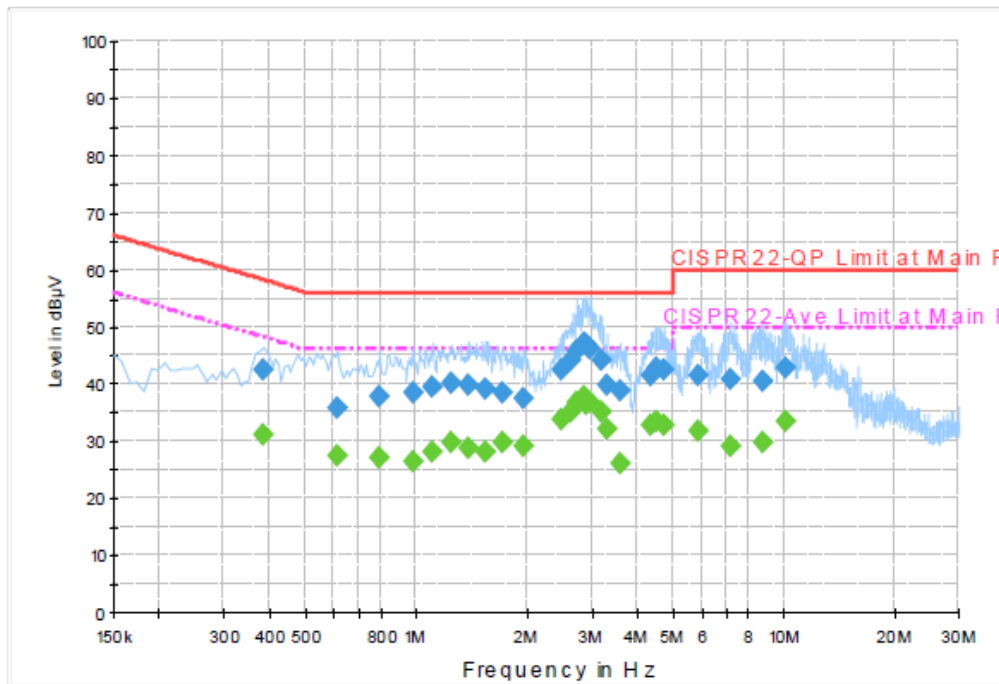

Final Result : Average

Frequency (MHz)	Average (dBµV)	Filter	Line	Corr. (dB)	Margin (dB)	Limit (dBµV)
3.198000	35.3	Off	L1	19.7	10.7	46.0
3.326000	32.3	Off	L1	19.8	13.7	46.0
3.582000	26.0	Off	L1	19.7	20.0	46.0
4.342000	32.7	Off	L1	19.7	13.3	46.0
4.518000	33.4	Off	L1	19.8	12.6	46.0
4.742000	32.6	Off	L1	19.7	13.4	46.0
5.862000	31.9	Off	L1	19.7	18.1	50.0
7.206000	29.1	Off	L1	19.8	20.9	50.0
8.782000	29.7	Off	L1	19.8	20.3	50.0
10.190000	33.5	Off	L1	19.8	16.5	50.0



Test Mode :	Mode 2	Temperature :	21~23°C
Test Engineer :	Eric Jeng	Relative Humidity :	59~61%
Test Voltage :	120Vac / 60Hz	Phase :	Neutral
Function Type :	GSM850 Idle + Bluetooth Link + WLAN (2.4GHz) Link + Earphone + USB Cable (Charging from Adapter 2) + MP3		

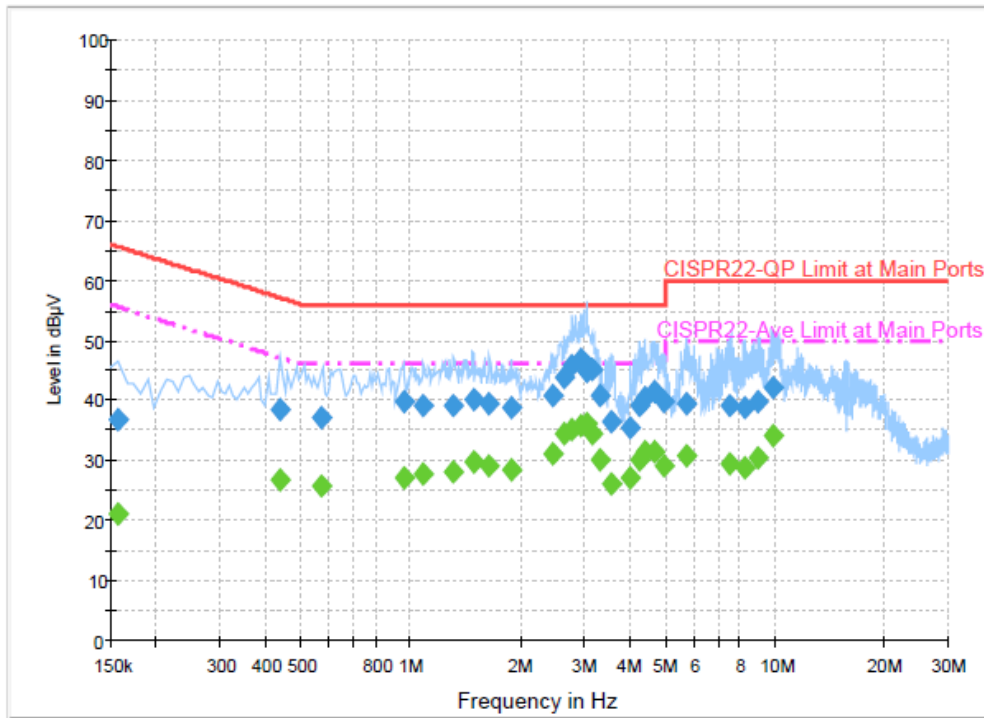

Final Result : Quasi-Peak

Frequency (MHz)	Quasi-Peak (dBµV)	Filter	Line	Corr. (dB)	Margin (dB)	Limit (dBµV)
0.158000	36.9	Off	N	19.5	28.7	65.6
0.438000	38.6	Off	N	19.5	18.5	57.1
0.566000	37.0	Off	N	19.4	19.0	56.0
0.958000	39.6	Off	N	19.6	16.4	56.0
1.086000	39.2	Off	N	19.5	16.8	56.0
1.310000	39.0	Off	N	19.6	17.0	56.0
1.486000	40.3	Off	N	19.6	15.7	56.0
1.646000	39.6	Off	N	19.6	16.4	56.0
1.886000	38.8	Off	N	19.5	17.2	56.0
2.462000	40.9	Off	N	19.7	15.1	56.0
2.630000	43.7	Off	N	19.7	12.3	56.0
2.782000	45.7	Off	N	19.7	10.3	56.0
2.934000	46.8	Off	N	19.7	9.2	56.0



Test Mode :	Mode 2	Temperature :	21~23°C
Test Engineer :	Eric Jeng	Relative Humidity :	59~61%
Test Voltage :	120Vac / 60Hz	Phase :	Neutral
Function Type :	GSM850 Idle + Bluetooth Link + WLAN (2.4GHz) Link + Earphone + USB Cable (Charging from Adapter 2) + MP3		

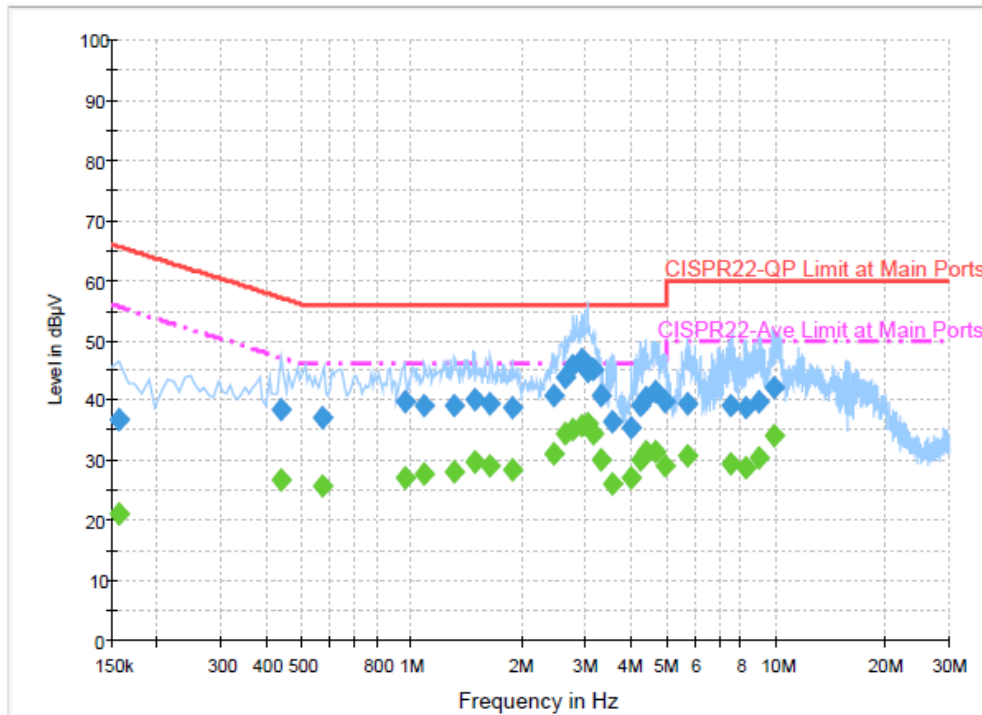

Final Result : Quasi-Peak

Frequency (MHz)	Quasi-Peak (dBµV)	Filter	Line	Corr. (dB)	Margin (dB)	Limit (dBµV)
3.046000	44.8	Off	N	19.7	11.2	56.0
3.158000	45.2	Off	N	19.7	10.8	56.0
3.310000	40.7	Off	N	19.8	15.3	56.0
3.566000	36.4	Off	N	19.7	19.6	56.0
4.030000	35.6	Off	N	19.7	20.4	56.0
4.238000	39.0	Off	N	19.7	17.0	56.0
4.390000	40.4	Off	N	19.7	15.6	56.0
4.670000	41.3	Off	N	19.7	14.7	56.0
4.982000	39.9	Off	N	19.8	16.1	56.0
5.702000	39.6	Off	N	19.7	20.4	60.0
7.574000	39.0	Off	N	19.8	21.0	60.0
8.334000	38.9	Off	N	19.8	21.1	60.0
9.054000	39.9	Off	N	19.9	20.1	60.0
9.950000	42.3	Off	N	19.9	17.7	60.0



Test Mode :	Mode 2	Temperature :	21~23°C
Test Engineer :	Eric Jeng	Relative Humidity :	59~61%
Test Voltage :	120Vac / 60Hz	Phase :	Neutral
Function Type :	GSM850 Idle + Bluetooth Link + WLAN (2.4GHz) Link + Earphone + USB Cable (Charging from Adapter 2) + MP3		

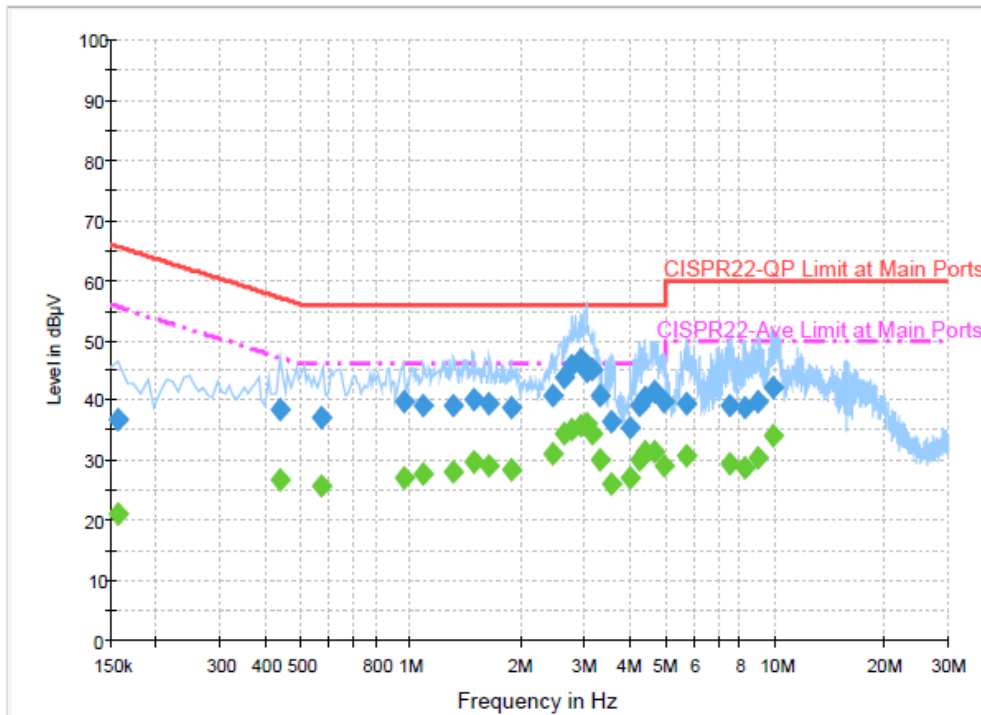

Final Result : Average

Frequency (MHz)	Average (dBµV)	Filter	Line	Corr. (dB)	Margin (dB)	Limit (dBµV)
0.158000	21.1	Off	N	19.5	34.5	55.6
0.438000	26.7	Off	N	19.5	20.4	47.1
0.566000	25.6	Off	N	19.4	20.4	46.0
0.958000	27.2	Off	N	19.6	18.8	46.0
1.086000	27.8	Off	N	19.5	18.2	46.0
1.310000	28.1	Off	N	19.6	17.9	46.0
1.486000	29.9	Off	N	19.6	16.1	46.0
1.646000	29.2	Off	N	19.6	16.8	46.0
1.886000	28.5	Off	N	19.5	17.5	46.0
2.462000	31.2	Off	N	19.7	14.8	46.0
2.630000	34.4	Off	N	19.7	11.6	46.0
2.782000	35.0	Off	N	19.7	11.0	46.0
2.934000	35.9	Off	N	19.7	10.1	46.0



Test Mode :	Mode 2	Temperature :	21~23°C
Test Engineer :	Eric Jeng	Relative Humidity :	59~61%
Test Voltage :	120Vac / 60Hz	Phase :	Neutral
Function Type :	GSM850 Idle + Bluetooth Link + WLAN (2.4GHz) Link + Earphone + USB Cable (Charging from Adapter 2) + MP3		

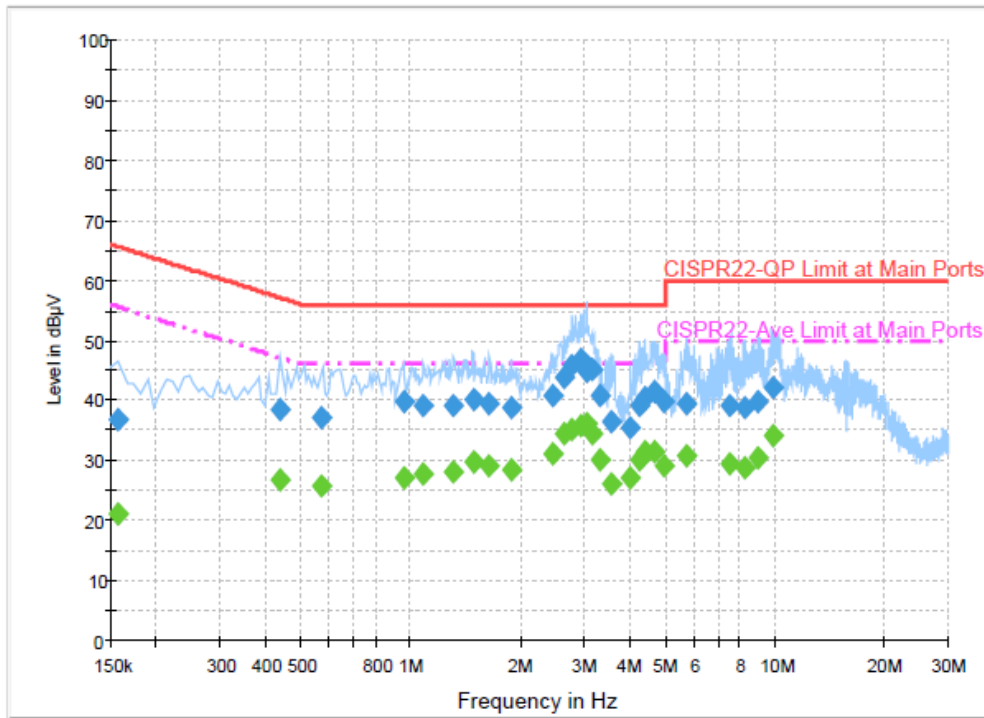

Final Result : Average

Frequency (MHz)	Average (dBµV)	Filter	Line	Corr. (dB)	Margin (dB)	Limit (dBµV)
3.046000	36.1	Off	N	19.7	9.9	46.0
3.158000	34.3	Off	N	19.7	11.7	46.0
3.310000	30.0	Off	N	19.8	16.0	46.0
3.566000	26.0	Off	N	19.7	20.0	46.0
4.030000	27.1	Off	N	19.7	18.9	46.0
4.238000	30.0	Off	N	19.7	16.0	46.0
4.390000	31.4	Off	N	19.7	14.6	46.0
4.670000	31.4	Off	N	19.7	14.6	46.0
4.982000	29.1	Off	N	19.8	16.9	46.0
5.702000	30.8	Off	N	19.7	19.2	50.0
7.574000	29.4	Off	N	19.8	20.6	50.0
8.334000	28.7	Off	N	19.8	21.3	50.0
9.054000	30.3	Off	N	19.9	19.7	50.0
9.950000	34.1	Off	N	19.9	15.9	50.0



3.7 Antenna Requirements

3.7.1 Standard Applicable

If directional gain of transmitting antennas is greater than 6dBi, the power shall be reduced by the same level in dB comparing to gain minus 6dBi. The use of a permanently attached antenna or of an antenna that uses a unique coupling to the intentional radiator shall be considered sufficient to comply with the FCC rule.

3.7.2 Antenna Anti-Replacement Construction

An embedded-in antenna design is used.

3.7.3 Antenna Gain

The antenna peak gain of EUT is less than 6 dBi. Therefore, it is not necessary to reduce maximum peak output power limit.



4 List of Measuring Equipment

Instrument	Manufacturer	Model No.	Serial No.	Characteristics	Calibration Date	Test Date	Due Date	Remark
Power Meter	Agilent	E4416A	GB412923 44	300MHz~40GHz	Jan. 14, 2015	May 15, 2015~ May 24, 2015	Jan. 13, 2016	Conducted (TH02-HY)
Power Sensor	Agilent	E9327A	US404415 48	300MHz~40GHz	Jan. 14, 2015	May 15, 2015~ May 24, 2015	Jan. 13, 2016	Conducted (TH02-HY)
Spectrum Analyzer	Rohde & Schwarz	FSP40	100057	9kHz-40GHz	Oct. 17, 2014	May 15, 2015~ May 24, 2015	Oct. 16, 2015	Conducted (TH02-HY)
EMI Test Receiver	Rohde & Schwarz	ESCS 30	100356	9kHz – 2.75GHz	Dec. 01, 2014	May 16, 2015~ Jun. 09, 2015	Nov. 30, 2015	Conduction (CO05-HY)
LISN	Rohde & Schwarz	ENV216	100080	9kHz~30MHz	Dec. 02, 2014	May 16, 2015~ Jun. 09, 2015	Dec. 01, 2015	Conduction (CO05-HY)
AC Power Source	ChainTek	APC-1000W	N/A	N/A	N/A	May 16, 2015~ Jun. 09, 2015	N/A	Conduction (CO05-HY)
Bilog Antenna	Schaffner	CBL6111C	2726	30MHz ~ 1GHz	Sep. 27, 2014	Jun. 10, 2015~ Jun. 11, 2015	Sep. 26, 2015	Radiation (03CH07-HY)
Double Ridge Horn Antenna	ESCO	3117	00075962	1GHz ~ 18GHz	Aug. 19, 2014	Jun. 10, 2015~ Jun. 11, 2015	Aug. 18, 2015	Radiation (03CH07-HY)
EMI Test Receiver	Rohde & Schwarz	ESCI 7	100724	9kHz~7GHz	Aug. 30, 2014	Jun. 10, 2015~ Jun. 11, 2015	Aug. 29, 2015	Radiation (03CH07-HY)
Horn Antenna	SCHWARZBECK	BBHA 9170	BBHA9170 584	18GHz- 40GHz	Nov. 03, 2014	Jun. 10, 2015~ Jun. 11, 2015	Nov. 02, 2015	Radiation (03CH07-HY)
Preamplifier	MITEQ	AMF-7D-0010 1800-30-10P	1590075	1GHz ~ 18GHz	Apr. 20, 2015	Jun. 10, 2015~ Jun. 11, 2015	Apr. 19, 2016	Radiation (03CH07-HY)
Preamplifier	COM-POWER	PA-103A	161241	10MHz-1000MHz	Mar. 12, 2015	Jun. 10, 2015~ Jun. 11, 2015	Mar. 11, 2016	Radiation (03CH07-HY)
Preamplifier	Agilent	8449B	3008A023 62	1GHz~ 26.5GHz	Oct. 21, 2014	Jun. 10, 2015~ Jun. 11, 2015	Oct. 20, 2015	Radiation (03CH07-HY)
Signal Analyzer	Rohde & Schwarz	FSV 30	101749	10Hz~30GHz	Mar. 10, 2015	Jun. 10, 2015~ Jun. 11, 2015	Mar. 09, 2016	Radiation (03CH07-HY)
Antenna Mast	Max-Full	MFA520BS	N/A	1m~4m	N/A	Jun. 10, 2015~ Jun. 11, 2015	N/A	Radiation (03CH07-HY)
Turn Table	ChainTek	Chaintek 3000	N/A	0~360 degree	N/A	Jun. 10, 2015~ Jun. 11, 2015	N/A	Radiation (03CH07-HY)
Preamplifier	MITEQ	JS44-180040 00-33-8P	1840917	18GHz ~ 40GHz	Jun. 02, 2015	Jun. 10, 2015~ Jun. 11, 2015	Jun. 01, 2016	Radiation (03CH07-HY)
Loop Antenna	Rohde & Schwarz	HFH2-Z2	100315	9 kHz~30 MHz	Jul. 28, 2014	Jun. 10, 2015~ Jun. 11, 2015	Jul. 27, 2015	Radiation (03CH07-HY)



5 Uncertainty of Evaluation

Uncertainty of Conducted Emission Measurement (150 kHz ~ 30 MHz)

Measuring Uncertainty for a Level of Confidence of 95% ($U = 2Uc(y)$)	2.26
---	------

Uncertainty of Radiated Emission Measurement (30 MHz ~ 1000 MHz)

Measuring Uncertainty for a Level of Confidence of 95% ($U = 2Uc(y)$)	5.2
---	-----



Appendix A. Radiated Spurious Emission

Test Engineer :	Nick Yu, Ken Wu, and James Chiu	Temperature :	22~23°C
		Relative Humidity :	58~62%

15C 2.4GHz 2400~2483.5MHz

BLE (Band Edge @ 3m) (with adapter1)

BLE	Note	Frequency	Level	Over	Limit	Read	Antenna	Cable	Preamp	Ant	Table	Peak	Pol.	
		(MHz)	(dBµV/m)	(dB)	Limit	Level	Factor	Loss	Factor	Pos	Pos	Avg.		
		(MHz)	(dBµV/m)	(dB)	(dBµV/m)	(dBµV)	(dB/m)	(dB)	(dB)	(cm)	(deg)	(P/A)	(H/V)	
BLE CH 00 2402MHz		2322.96	47.56	-26.44	74	42.09	32.09	7.6	34.22	103	288	P	H	
		2344.65	35.16	-18.84	54	29.62	32.11	7.68	34.25	103	288	A	H	
	*	2402.254	93.78	-	-	88.15	32.18	7.75	34.3	103	288	P	H	
	*	2401.92	92.98	-	-	87.35	32.18	7.75	34.3	103	288	A	H	
													H	
														H
			2389.83	48.35	-25.65	74	42.72	32.18	7.75	34.3	315	22	P	V
			2322.6	35.16	-18.84	54	29.69	32.09	7.6	34.22	315	22	A	V
	*		2401.67	87.85	-	-	82.22	32.18	7.75	34.3	315	22	P	V
	*		2401.92	87.07	-	-	81.44	32.18	7.75	34.3	315	22	A	V
														V
														V
BLE CH 19 2440MHz		2345.55	47.5	-26.5	74	41.96	32.11	7.68	34.25	115	306	P	H	
		2368.77	35.06	-18.94	54	29.49	32.16	7.68	34.27	115	306	A	H	
	*	2440.247	93.6	-	-	87.88	32.24	7.83	34.35	115	306	P	H	
	*	2439.997	92.84	-	-	87.12	32.24	7.83	34.35	115	306	A	H	
			2491.32	47.7	-26.3	74	41.92	32.3	7.91	34.43	115	306	P	H
			2484.16	35.53	-18.47	54	29.77	32.28	7.91	34.43	115	306	A	H
			2350.77	48.33	-25.67	74	42.79	32.11	7.68	34.25	304	33	P	V
			2317.83	35.57	-18.43	54	30.1	32.09	7.6	34.22	304	33	A	V
	*		2439.83	88.49	-	-	82.77	32.24	7.83	34.35	304	33	P	V
	*		2439.997	87.71	-	-	81.99	32.24	7.83	34.35	304	33	A	V
			2489.44	47.18	-26.82	74	41.4	32.3	7.91	34.43	304	33	P	V
			2493.32	35.04	-18.96	54	29.31	32.3	7.91	34.48	304	33	A	V



BLE CH 39 2480MHz	*	2479.826	92.92	-	-	87.16	32.28	7.91	34.43	100	302	P	H
	*	2479.993	92.06	-	-	86.3	32.28	7.91	34.43	100	302	A	H
		2492.72	47.58	-26.42	74	41.85	32.3	7.91	34.48	100	302	P	H
		2494.56	35.1	-18.9	54	29.37	32.3	7.91	34.48	100	302	A	H
													H
													H
	*	2479.826	88	-	-	82.24	32.28	7.91	34.43	326	22	P	V
	*	2479.993	87.16	-	-	81.4	32.28	7.91	34.43	326	22	A	V
		2491.32	47.3	-26.7	74	41.52	32.3	7.91	34.43	326	22	P	V
		2492.64	35.21	-18.79	54	29.48	32.3	7.91	34.48	326	22	A	V
													V
													V
Remark	1. No other spurious found. 2. All results are PASS against Peak and Average limit line.												



15C 2.4GHz 2400~2483.5MHz

BLE (Harmonic @ 3m) (with adapter1)

BLE	Note	Frequency	Level	Over	Limit	Read	Antenna	Cable	Preamp	Ant	Table	Peak	Pol.
		(MHz)	(dBμV/m)	(dB)	Limit	Level	Factor	Loss	Factor	Pos	Pos	Avg.	
					Line	(dBμV)	(dB/m)	(dB)	(dB)	(cm)	(deg)	(P/A)	(H/V)
BLE CH 00 2402MHz		4804	41.24	-32.76	74	55.55	34.25	11.11	59.67	100	0	P	H
													H
													H
													H
		4804	41.39	-32.61	74	55.7	34.25	11.11	59.67	100	0	P	V
													V
													V
													V
BLE CH 19 2440MHz		4880	41.54	-32.46	74	55.6	34.3	11.21	59.57	100	0	P	H
		7320	43.66	-30.34	74	51.47	35.6	15.08	58.49	100	0	P	H
													H
													H
		4880	41.47	-32.53	74	55.53	34.3	11.21	59.57	100	0	P	V
		7320	43.73	-30.27	74	51.54	35.6	15.08	58.49	100	0	P	V
													V
													V
BLE CH 39 2480MHz		4962	41.92	-32.08	74	55.68	34.37	11.32	59.45	100	0	P	H
		7440	42.92	-31.08	74	50.83	35.6	15.13	58.64	100	0	P	H
													H
													H
		4960	41.88	-32.12	74	55.64	34.37	11.32	59.45	100	0	P	V
		7440	42.27	-31.73	74	50.18	35.6	15.13	58.64	100	0	P	V
													V
													V
Remark	1. No other spurious found. 2. All results are PASS against Peak and Average limit line.												



15C Emission below 1GHz
2.4GHz BLE (LF) (with adapter1)

BLE	Note	Frequency	Level	Over	Limit	Read	Antenna	Cable	Preamp	Ant	Table	Peak	Pol.	
		(MHz)	(dBμV/m)	(dB)	(dBμV/m)	(dBμV)	(dB/m)	(dB)	(dB)	(cm)	(deg)	(P/A)	(H/V)	
2.4GHz BLE LF		31.08	25.34	-14.66	40	36.75	18.28	1.77	31.46	100	288	P	H	
		105.06	24.27	-19.23	43.5	42.54	10.5	2.38	31.15	-	-	P	H	
		219	24.36	-21.64	46	43.39	9.29	2.69	31.01	-	-	P	H	
		316.8	22.87	-23.13	46	37.22	13.37	3.28	31	-	-	P	H	
		559.7	23.32	-22.68	46	30.07	20	4.01	30.76	-	-	P	H	
		766.2	27.03	-18.97	46	30.82	22.1	4.48	30.37	-	-	P	H	
														H
														H
														H
														H
														H
														H
														H
			31.08	35.33	-4.67	40	46.74	18.28	1.77	31.46	305	46	P	V
			35.4	31.95	-8.05	40	45.7	15.76	1.77	31.28	-	-	P	V
			98.85	27.78	-15.72	43.5	46.66	10.16	2.06	31.1	-	-	P	V
			440.7	21.14	-24.86	46	31.21	17	3.63	30.7	-	-	P	V
			556.9	24.63	-21.37	46	31.45	19.94	4.01	30.77	-	-	P	V
			937	29.53	-16.47	46	30.8	24.3	4.8	30.37	-	-	P	V
														V
													V	
													V	
													V	
													V	
													V	
Remark	1. No other spurious found. 2. All results are PASS against limit line.													



15C 2.4GHz 2400~2483.5MHz

BLE (Band Edge @ 3m) (with adapter2)

BLE	Note	Frequency (MHz)	Level (dBµV/m)	Over	Limit	Read	Antenna	Cable	Preamp	Ant	Table	Peak	Pol.
				Limit (dB)	Line (dBµV/m)	Level (dBµV)	Factor (dB/m)	Loss (dB)	Factor (dB)	Pos (cm)	Pos (deg)	Avg. (P/A)	
BLE CH 19 2440MHz		2368.32	47.59	-26.41	74	42.05	32.13	7.68	34.27	115	306	P	H
		2388.39	35.25	-18.75	54	29.59	32.18	7.75	34.27	115	306	A	H
	*	2439.746	91.73	-	-	86.01	32.24	7.83	34.35	115	306	P	H
	*	2439.997	90.98	-	-	85.26	32.24	7.83	34.35	115	306	A	H
		2490.24	47.28	-26.72	74	41.5	32.3	7.91	34.43	115	306	P	H
		2494.68	35.15	-18.85	54	29.42	32.3	7.91	34.48	115	306	A	H
		2374.98	47.32	-26.68	74	41.75	32.16	7.68	34.27	342	25	P	V
		2313.15	35.13	-18.87	54	29.65	32.07	7.6	34.19	342	25	A	V
	*	2440.247	87.44	-	-	81.72	32.24	7.83	34.35	342	25	P	V
	*	2439.997	86.64	-	-	80.92	32.24	7.83	34.35	342	25	A	V
		2491.44	47.18	-26.82	74	41.4	32.3	7.91	34.43	342	25	P	V
		2489.84	35.16	-18.84	54	29.38	32.3	7.91	34.43	342	25	A	V
Remark	1. No other spurious found. 2. All results are PASS against Peak and Average limit line.												

15C 2.4GHz 2400~2483.5MHz

BLE (Harmonic @ 3m) (with adapter2)

BLE	Note	Frequency (MHz)	Level (dBµV/m)	Over	Limit	Read	Antenna	Cable	Preamp	Ant	Table	Peak	Pol.	
				Limit (dB)	Line (dBµV/m)	Level (dBµV)	Factor (dB/m)	Loss (dB)	Factor (dB)	Pos (cm)	Pos (deg)	Avg. (P/A)		
BLE CH 19 2440MHz		4880	41.04	-32.96	74	55.1	34.3	11.21	59.57	100	0	P	H	
		7320	43.72	-30.28	74	51.53	35.6	15.08	58.49	100	0	P	H	
													H	
													H	
		4880	41.36	-32.64	74	55.42	34.3	11.21	59.57	100	0	P	V	
		7320	43.68	-30.32	74	51.49	35.6	15.08	58.49	100	0	P	V	
														V
														V
Remark	1. No other spurious found. 2. All results are PASS against Peak and Average limit line.													



15C Emission below 1GHz
2.4GHz BLE (LF) (with adapter2)

BLE	Note	Frequency	Level	Over	Limit	Read	Antenna	Cable	Preamp	Ant	Table	Peak	Pol.	
		(MHz)	(dBµV/m)	(dB)	(dBµV/m)	(dBµV)	(dB/m)	(dB)	(dB)	(cm)	(deg)	(P/A)	(H/V)	
2.4GHz BLE LF		103.44	29.12	-14.38	43.5	47.39	10.48	2.38	31.13	-	-	P	H	
		157.17	34.81	-8.69	43.5	52.76	10.62	2.61	31.18	152	317	P	H	
		204.15	32.88	-10.62	43.5	52.14	9.15	2.69	31.1	-	-	P	H	
		359.5	21.47	-24.53	46	34.48	14.7	3.39	31.1	-	-	P	H	
		429.5	23.59	-22.41	46	33.81	16.9	3.63	30.75	-	-	P	H	
		745.2	27.7	-18.3	46	31.47	22.15	4.48	30.4	-	-	P	H	
														H
														H
														H
														H
														H
														H
			41.61	34.79	-5.21	40	51.62	12.6	1.77	31.2	275	88	P	V
			102.09	32.23	-11.27	43.5	50.53	10.44	2.38	31.12	-	-	P	V
			203.34	30.98	-12.52	43.5	50.25	9.14	2.69	31.1	-	-	P	V
			385.4	20.86	-25.14	46	33.01	15.3	3.52	30.97	-	-	P	V
			582.1	23.43	-22.57	46	30.44	19.58	4.08	30.67	-	-	P	V
			839	28.69	-17.31	46	31.21	23.16	4.7	30.38	-	-	P	V
														V
														V
													V	
													V	
													V	
													V	
Remark	1 No other spurious found. 2 All results are PASS against limit line.													



Note symbol

*	Fundamental Frequency which can be ignored. However, the level of any unwanted emissions shall not exceed the level of the fundamental frequency per 15.209(c).
!	Test result is over limit line.
P/A	Peak or Average
H/V	Horizontal or Vertical



A calculation example for radiated spurious emission is shown as below:

WIFI	Note	Frequency	Level	Over	Limit	Read	Antenna	Cable	Preamp	Ant	Table	Peak	Pol.
Ant.				Limit	Line	Level	Factor	Loss	Factor	Pos	Pos	Avg.	
1+2		(MHz)	(dBμV/m)	(dB)	(dBμV/m)	(dBμV)	(dB/m)	(dB)	(dB)	(cm)	(deg)	(P/A)	(H/V)
802.11b		2390	55.45	-18.55	74	54.51	32.22	4.58	35.86	103	308	P	H
CH 01													
2412MHz		2390	43.54	-10.46	54	42.6	32.22	4.58	35.86	103	308	A	H

- Level(dBμV/m) =
Antenna Factor(dB/m) + Cable Loss(dB) + Read Level(dBμV) - Preamp Factor(dB)
- Over Limit(dB) = Level(dBμV/m) – Limit Line(dBμV/m)

For Peak Limit @ 2390MHz:

- Level(dBμV/m)
= Antenna Factor(dB/m) + Cable Loss(dB) + Read Level(dBμV) - Preamp Factor(dB)
= 32.22(dB/m) + 4.58(dB) + 54.51(dBμV) – 35.86 (dB)
= 55.45 (dBμV/m)
- Over Limit(dB)
= Level(dBμV/m) – Limit Line(dBμV/m)
= 55.45(dBμV/m) – 74(dBμV/m)
= -18.55(dB)

For Average Limit @ 2390MHz:

- Level(dBμV/m)
= Antenna Factor(dB/m) + Cable Loss(dB) + Read Level(dBμV) - Preamp Factor(dB)
= 32.22(dB/m) + 4.58(dB) + 42.6(dBμV) – 35.86 (dB)
= 43.54 (dBμV/m)
- Over Limit(dB)
= Level(dBμV/m) – Limit Line(dBμV/m)
= 43.54(dBμV/m) – 54(dBμV/m)
= -10.46(dB)

Both peak and average measured complies with the limit line, so test result is “PASS”.