



FCC RF Test Report

APPLICANT : Motorola Mobility, LLC
EQUIPMENT : Mobile Cellular Phone
BRAND NAME : Motorola
MODEL NAME : 4598
FCC ID : IHDT56QG4
STANDARD : FCC Part 15 Subpart C §15.247
CLASSIFICATION : (DTS) Digital Transmission System

The product was received on Apr. 20, 2015. We, SPORTON INTERNATIONAL INC., would like to declare that the tested sample has been evaluated in accordance with the test procedures and has been in compliance with the applicable technical standards.

The test results in this report apply exclusively to the tested model / sample. Without written approval of SPORTON INTERNATIONAL INC., the test report shall not be reproduced except in full.

Reviewed by: Joseph Lin / Supervisor

Approved by: Jones Tsai / Manager



SPORTON INTERNATIONAL INC.

No. 52, Hwa Ya 1st Rd., Hwa Ya Technology Park, Kwei-Shan District, Tao Yuan City, Taiwan, R.O.C.



TABLE OF CONTENTS

REVISION HISTORY 3

1 GENERAL DESCRIPTION 4

 1.1 Applicant 4

 1.2 Manufacturer 4

 1.3 Product Feature of Equipment Under Test 4

 1.4 Product Specification subjective to this standard 4

 1.5 Modification of EUT 4

APPENDIX A. ORIGINAL REPORT



1 General Description

1.1 Applicant

Motorola Mobility, LLC

222 W Merchandise Mart Plaza, Suite 1800, Chicago, IL 60654, United States

1.2 Manufacturer

Motorola Mobility, LLC

222 W Merchandise Mart Plaza, Suite 1800, Chicago, IL 60654, United States

1.3 Product Feature of Equipment Under Test

Product Feature	
Equipment	Mobile Cellular Phone
Brand Name	Motorola
Model Name	4598
FCC ID	IHDT56QG4
EUT supports Radios application	GSM/EGPRS/WCDMA/HSPA/LTE WLAN 11b/g/n HT20 Bluetooth v3.0 EDR Bluetooth v4.0 - LE
HW Version	P2B
EUT Stage	Identical Prototype

Remark: The above EUT's information was declared by manufacturer. Please refer to the specifications or user's manual for more detailed description.

1.4 Product Specification subjective to this standard

Product Specification subjective to this standard	
Tx/Rx Channel Frequency Range	2412 MHz ~ 2462 MHz
Antenna Type	Fixed Internal Antenna type (The antenna peak gain of EUT is less than 6 dBi)
Type of Modulation	802.11b : DSSS (DBPSK / DQPSK / CCK) 802.11g/n : OFDM (BPSK / QPSK / 16QAM / 64QAM)

1.5 Modification of EUT

No modifications are made to the EUT during all test items.



Appendix A. Original Report

Please refer to Sporton report number FR542019C as below.



FCC RF Test Report

APPLICANT : Motorola Mobility, LLC
EQUIPMENT : Mobile Cellular Phone
BRAND NAME : Motorola
MODEL NAME : 4247
FCC ID : IHDT56QG1
STANDARD : FCC Part 15 Subpart C §15.247
CLASSIFICATION : (DTS) Digital Transmission System

The product was received on Apr. 20, 2015 and testing was completed on May 05, 2015. We, SPORTON INTERNATIONAL INC., would like to declare that the tested sample has been evaluated in accordance with the test procedures and has been in compliance with the applicable technical standards.

The test results in this report apply exclusively to the tested model / sample. Without written approval of SPORTON INTERNATIONAL INC., the test report shall not be reproduced except in full.

Reviewed by: Joseph Lin / Supervisor

Approved by: Jones Tsai / Manager



SPORTON INTERNATIONAL INC.

No. 52, Hwa Ya 1st Rd., Hwa Ya Technology Park, Kwei-Shan District, Tao Yuan City, Taiwan, R.O.C.



TABLE OF CONTENTS

REVISION HISTORY.....3

SUMMARY OF TEST RESULT4

1 GENERAL DESCRIPTION.....5

1.1 Applicant.....5

1.2 Manufacturer.....5

1.3 Product Feature of Equipment Under Test.....5

1.4 Product Specification subjective to this standard6

1.5 Modification of EUT6

1.6 Testing Location6

1.7 Applicable Standards.....7

2 TEST CONFIGURATION OF EQUIPMENT UNDER TEST.....8

2.1 Carrier Frequency Channel8

2.2 Pre-Scanned RF Power.....9

2.3 Test Mode..... 11

2.4 Connection Diagram of Test System..... 12

2.5 Support Unit used in test configuration and system 13

2.6 EUT Operation Test Setup 13

2.7 Measurement Results Explanation Example..... 13

3 TEST RESULT..... 14

3.1 6dB and 99% Bandwidth Measurement 14

3.2 Output Power Measurement..... 16

3.3 Power Spectral Density Measurement 18

3.4 Conducted Band Edges and Spurious Emission Measurement20

3.5 Radiated Band Edges and Spurious Emission Measurement30

3.6 AC Conducted Emission Measurement.....34

3.7 Antenna Requirements.....38

4 LIST OF MEASURING EQUIPMENT.....39

5 UNCERTAINTY OF EVALUATION.....40

APPENDIX A. CONDUCTED TEST RESULTS

APPENDIX B. RADIATED TEST RESULTS



SUMMARY OF TEST RESULT

Report Section	FCC Rule	Description	Limit	Result	Remark
3.1	15.247(a)(2)	6dB Bandwidth	$\geq 0.5\text{MHz}$	Pass	-
3.1	-	99% Bandwidth	-	Pass	-
3.2	15.247(b)	Power Output Measurement	$\leq 30\text{dBm}$	Pass	-
3.3	15.247(e)	Power Spectral Density	$\leq 8\text{dBm}/3\text{kHz}$	Pass	-
3.4	15.247(d)	Conducted Band Edges	$\leq 20\text{dBc}$	Pass	-
		Conducted Spurious Emission		Pass	-
3.5	15.247(d)	Radiated Band Edges and Radiated Spurious Emission	15.209(a) & 15.247(d)	Pass	Under limit 0.54 dB at 4872.000 MHz
3.6	15.207	AC Conducted Emission	15.207(a)	Pass	Under limit 19.20 dB at 1.782 MHz
3.7	15.203 & 15.247(b)	Antenna Requirement	N/A	Pass	-



1 General Description

1.1 Applicant

Motorola Mobility, LLC

222 W Merchandise Mart Plaza, Suite 1800, Chicago, IL 60654, United States

1.2 Manufacturer

Motorola Mobility, LLC

222 W Merchandise Mart Plaza, Suite 1800, Chicago, IL 60654, United States

1.3 Product Feature of Equipment Under Test

Product Feature	
Equipment	Mobile Cellular Phone
Brand Name	Motorola
Model Name	4247
FCC ID	IHDT56QG1
IMEI Code	355488060037809 (for Radiated Spurious Emission) 355488060028949 (for AC Conducted Emission)
EUT supports Radios application	GSM/EGPRS/WCDMA/HSPA/LTE WLAN 11b/g/n HT20 Bluetooth v3.0 EDR Bluetooth v4.0 - LE
HW Version	P2B
EUT Stage	Identical Prototype

Remark: The above EUT's information was declared by manufacturer. Please refer to the specifications or user's manual for more detailed description.

Accessory List	
AC Adapter	Brand Name : Motorola
	Model Name : SPN5810A
Earphone	Brand Name : Motorola
	Model Name : SJYN1181B
Battery	Brand Name : Motorola
	Model Name : FC40



1.4 Product Specification subjective to this standard

Product Specification subjective to this standard	
Tx/Rx Channel Frequency Range	802.11b/g/n : 2412 MHz ~ 2462 MHz
Maximum (Peak) Output Power to antenna	802.11b : 18.47 dBm (0.0703 W) 802.11g : 22.25 dBm (0.1679 W) 802.11n HT20 : 21.95 dBm (0.1567 W)
99% Occupied Bandwidth	802.11b : 13.55MHz 802.11g : 18.50MHz 802.11n HT20 : 19.30MHz
Antenna Type	802.11b/g/n : Fixed Internal Antenna type (The antenna peak gain of EUT is less than 6 dBi)
Type of Modulation	802.11b : DSSS (DBPSK / DQPSK / CCK) 802.11g/n : OFDM (BPSK / QPSK / 16QAM / 64QAM)

1.5 Modification of EUT

No modifications are made to the EUT during all test items.

1.6 Testing Location

Sporton Lab is accredited to ISO 17025 by Taiwan Accreditation Foundation (TAF code : 1190) and the FCC designation No. TW1022 under the FCC 2.948(e) by Mutual Recognition Agreement (MRA) in FCC Test.

Test Site	SPORTON INTERNATIONAL INC.		
Test Site Location	No. 52, Hwa Ya 1 st Rd., Hwa Ya Technology Park, Kwei-Shan District, Tao Yuan City, Taiwan, R.O.C. TEL: +886-3-327-3456 FAX: +886-3-328-4978		
Test Site No.	Sporton Site No.		
	TH02-HY	CO05-HY	03CH07-HY

Note: The test site complies with ANSI C63.4 2009 requirement.



1.7 Applicable Standards

According to the specifications of the manufacturer, the EUT must comply with the requirements of the following standards:

- ♦ FCC Part 15 Subpart C §15.247
- ♦ FCC KDB Publication No. 558074 D01 DTS Meas. Guidance v03r02
- ♦ ANSI C63.10-2009

Remark:

1. All test items were verified and recorded according to the standards and without any deviation during the test.
2. FCC permits the use of the 1.5 meter table as an alternative in C63.10-2013 through inquiry tracking number 961829.
3. This EUT has also been tested and complied with the requirements of FCC Part 15, Subpart B, recorded in a separate test report.



2 Test Configuration of Equipment Under Test

The EUT has been associated with peripherals and configuration operated in a manner tended to maximize its emission characteristics in a typical application. Frequency range investigated: conducted emission (150 kHz to 30 MHz) and radiated emission (9 kHz to the 10th harmonic of the highest fundamental frequency or to 40 GHz, whichever is lower). For radiated measurement, pre-scanned in three orthogonal panels, X, Y, Z. The worst cases (X plane) were recorded in this report.

The final configuration from all the combinations and the worst-case data rates were investigated by measuring the maximum power across all the data rates and modulation modes under section 2.2.

Based on the worst configuration found above, the RF power setting is set individually to meet FCC compliance limit for the final conducted and radiated tests shown in section 2.3.

2.1 Carrier Frequency Channel

Frequency Band	Channel	Freq. (MHz)	Channel	Freq. (MHz)
2400-2483.5 MHz	1	2412	7	2442
	2	2417	8	2447
	3	2422	9	2452
	4	2427	10	2457
	5	2432	11	2462
	6	2437	-	-



2.2 Pre-Scanned RF Power

Preliminary tests were performed in different data rate and data rate associated with the highest power were chosen for full test shown in the following tables.

Channel	Frequency	2.4GHz 802.11b RF Power (dBm)			
		DSSS Data Rate			
		1 Mbps	2 Mbps	5.5 Mbps	11 Mbps
CH 01	2412MHz	17.81	17.80	17.75	17.77
CH 06	2437MHz	18.14	18.11	18.07	18.08
CH 11	2462MHz	18.47	15.41	18.39	18.37

Channel	Frequency	2.4GHz 802.11b Average Power (dBm)			
		DSSS Data Rate			
		1 Mbps	2 Mbps	5.5 Mbps	11 Mbps
CH 01	2412MHz	15.31	15.18	15.26	15.26
CH 06	2437MHz	15.48	15.37	15.47	15.43
CH 11	2462MHz	15.88	15.63	15.82	15.76

Channel	Frequency	2.4GHz 802.11g RF Power (dBm)							
		OFDM Data Rate							
		6 Mbps	9 Mbps	12 Mbps	18 Mbps	24 Mbps	36 Mbps	48 Mbps	54 Mbps
CH 01	2412MHz	21.47	21.28	21.33	21.15	21.03	21.07	20.87	20.47
CH 06	2437MHz	22.25	22.17	22.23	22.16	21.75	21.71	21.83	21.23
CH 11	2462MHz	20.56	20.40	20.44	20.52	20.42	20.49	20.38	20.39

Channel	Frequency	2.4GHz 802.11g Average Power (dBm)							
		OFDM Data Rate							
		6 Mbps	9 Mbps	12 Mbps	18 Mbps	24 Mbps	36 Mbps	48 Mbps	54 Mbps
CH 01	2412MHz	13.57	13.56	13.49	13.53	13.12	13.14	13.17	12.28
CH 06	2437MHz	15.16	15.13	15.14	15.03	14.34	14.52	14.49	13.59
CH 11	2462MHz	11.75	11.71	11.73	11.73	11.62	11.71	11.68	11.70



Channel	Frequency	2.4GHz 802.11n HT20 RF Power (dBm)							
		OFDM Data Rate							
		MCS0	MCS1	MCS2	MCS3	MCS4	MCS5	MCS6	MCS7
CH 01	2412MHz	21.24	21.23	20.97	20.53	20.12	19.71	19.44	19.55
CH 06	2437MHz	21.95	21.87	21.46	21.32	21.05	20.84	20.41	20.55
CH 11	2462MHz	18.74	18.65	18.54	18.66	18.46	18.71	18.52	18.54

Channel	Frequency	2.4GHz 802.11n HT20 Average Power (dBm)							
		OFDM Data Rate							
		MCS0	MCS1	MCS2	MCS3	MCS4	MCS5	MCS6	MCS7
CH 01	2412MHz	12.86	12.81	12.29	11.82	11.62	11.08	10.54	10.59
CH 06	2437MHz	14.30	14.22	13.89	13.45	13.16	12.61	12.14	12.13
CH 11	2462MHz	9.17	9.02	9.10	9.10	9.13	9.15	9.08	9.14



2.3 Test Mode

Final test mode of conducted test items and radiated spurious emissions are considering the modulation and worse data rates from the power table described in section 2.2.

<2.4GHz>

Modulation	Data Rate
802.11b	1 Mbps
802.11g	6 Mbps
802.11n HT20	MCS0

Test Cases	
AC Conducted Emission	Mode 1 : GSM850 Idle + Bluetooth Link + WLAN Link + MP3 + Earphone + USB Cable (Charging from Adapter)

2.4 Connection Diagram of Test System

<WLAN Tx Mode>

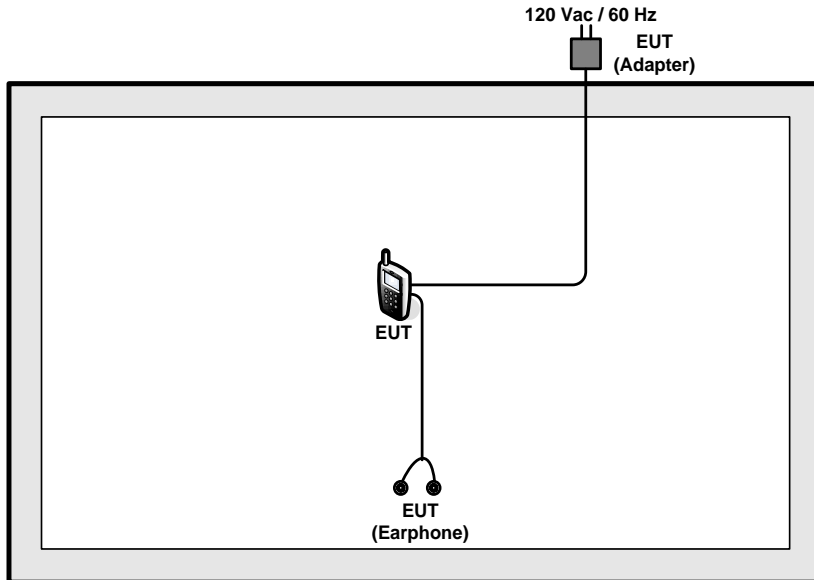

<AC Conducted Emission Mode>

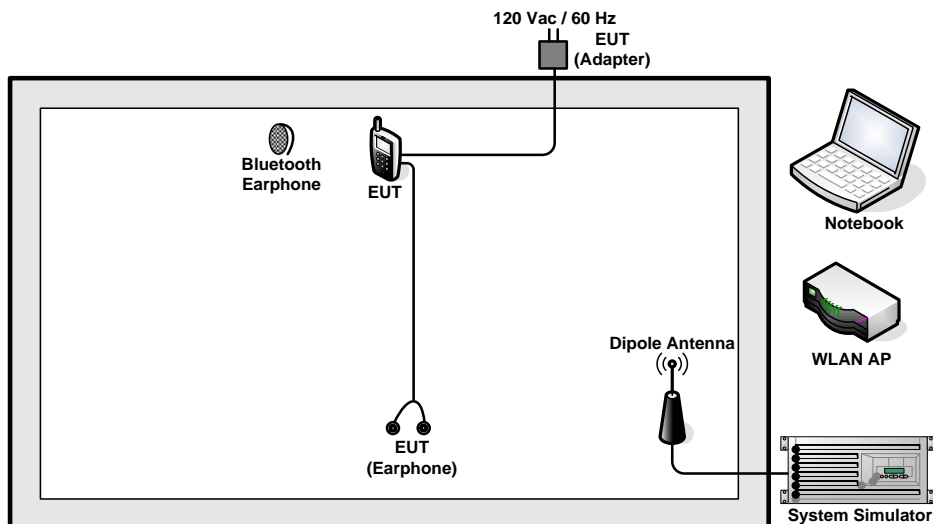



2.5 Support Unit used in test configuration and system

Item	Equipment	Trade Name	Model Name	FCC ID	Data Cable	Power Cord
1.	System Simulator	Anritsu	MT8820C	N/A	N/A	Unshielded, 1.8 m
2.	WLAN AP	D-Link	DIR-865L	KA2IR865LA1	N/A	Unshielded, 1.8 m
3.	Notebook	DELL	Latitude E6320	FCC DoC/ Contains FCC ID: QDS-BRCM1054	N/A	AC I/P: Unshielded, 1.2 m DC O/P: Shielded, 1.8 m
4.	Bluetooth Earphone	Sony Ericsson	MW600	PY7DDA-2029	N/A	N/A
5.	SD Card	SanDisk	MicroSD HC	FCC DoC	N/A	N/A

2.6 EUT Operation Test Setup

For WLAN function, programmed RF utility, "QRCT" installed in the notebook make the EUT provide functions like channel selection and power level for continuous transmitting and receiving signals.

2.7 Measurement Results Explanation Example

For all conducted test items:

The offset level is set in the spectrum analyzer to compensate the RF cable loss and attenuator factor between EUT conducted output port and spectrum analyzer. With the offset compensation, the spectrum analyzer reading level is exactly the EUT RF output level.

Example :

The spectrum analyzer offset is derived from RF cable loss and attenuator factor.

$$\text{Offset} = \text{RF cable loss} + \text{attenuator factor}.$$

Following shows an offset computation example with cable loss 4.2 dB and 10dB attenuator.

$$\begin{aligned} \text{Offset(dB)} &= \text{RF cable loss(dB)} + \text{attenuator factor(dB)}. \\ &= 4.2 + 10 = 14.2 \text{ (dB)} \end{aligned}$$

3 Test Result

3.1 6dB and 99% Bandwidth Measurement

3.1.1 Limit of 6dB and 99% Bandwidth

The minimum 6 dB bandwidth shall be at least 500 kHz.

3.1.2 Measuring Instruments

The measuring equipment is listed in the section 4 of this test report.

3.1.3 Test Procedures

1. The testing follows FCC KDB Publication No. 558074 DTS D01 Meas. Guidance v03r02.
2. The RF output of EUT was connected to the spectrum analyzer by RF cable and attenuator. The path loss was compensated to the results for each measurement.
3. Set to the maximum power setting and enable the EUT transmit continuously.
4. Make the measurement with the spectrum analyzer's resolution bandwidth (RBW) = 100 kHz. Set the Video bandwidth (VBW) = 300 kHz. In order to make an accurate measurement. The 6 dB bandwidth must be greater than 500 kHz.
5. For 99% Bandwidth Measurement, the spectrum analyzer's resolution bandwidth (RBW) = 1MHz and set the Video bandwidth (VBW) = 3MHz.
6. Measure and record the results in the test report.

3.1.4 Test Setup

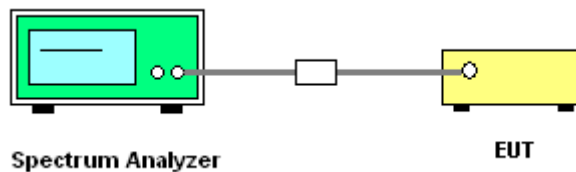



3.1.5 Test Result of 6dB and 99% Occupied Bandwidth

Please refer to Appendix A of this test report.

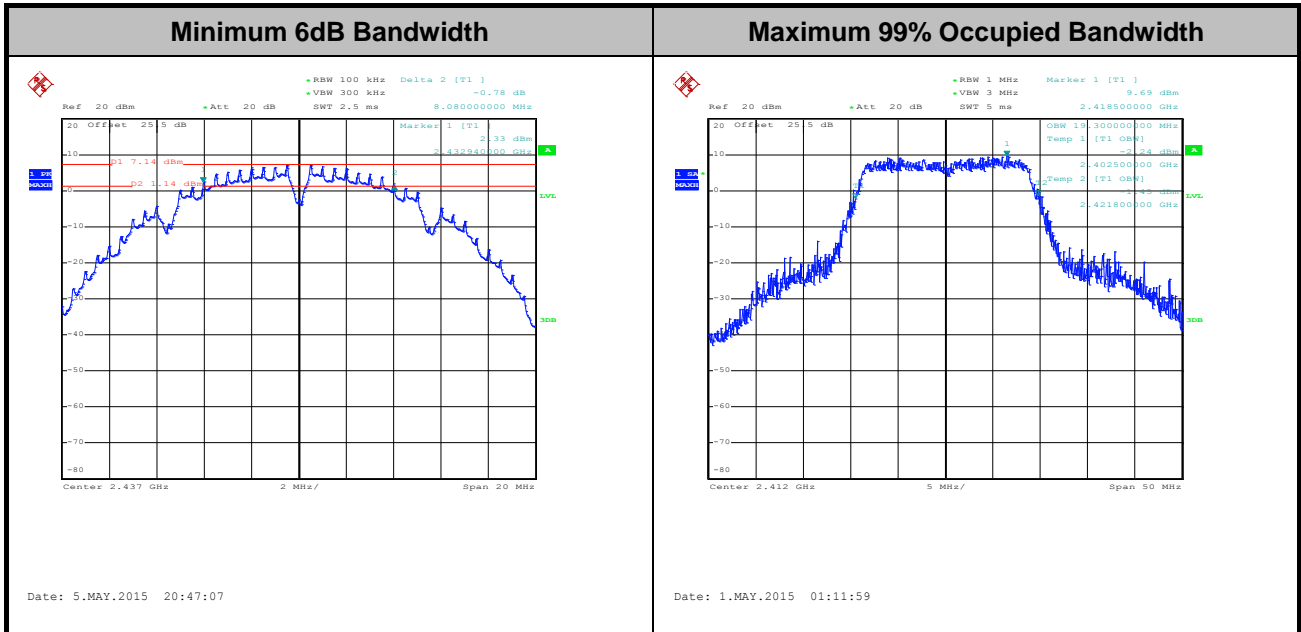

Note : The occupied channel bandwidth is maintained within the band of operation for all of the modulations.

3.2 Output Power Measurement

3.2.1 Limit of Output Power

For systems using digital modulation in the 2400-2483.5MHz, the limit for peak output power is 30dBm. If transmitting Antenna of directional gain greater than 6dBi are used the peak output power from the intentional radiator shall be reduced below the above stated value by the amount in dB that the directional gain of the Antenna exceeds 6 dBi. In case of point-to-point operation, the limit has to be reduced by 1dB for every 3dB that the directional gain of the Antenna exceeds 6dBi.

3.2.2 Measuring Instruments

The measuring equipment is listed in the section 4 of this test report.

3.2.3 Test Procedures

1. The testing follows the Measurement Procedure of FCC KDB No. 558074 DTS D01 Meas. Guidance v03r02.
2. The RF output of EUT was connected to the power meter by RF cable and attenuator. The path loss was compensated to the results for each measurement.
3. Set to the maximum power setting and enable the EUT transmit continuously.
4. Measure the conducted output power and record the results in the test report.

3.2.4 Test Setup

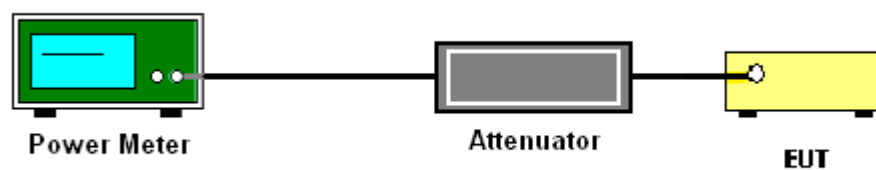



3.2.5 Test Result of Peak Output Power

Please refer to Appendix A of this test report.

3.2.6 Test Result of Average output Power (Reporting Only)

Please refer to Appendix A of this test report.

3.3 Power Spectral Density Measurement

3.3.1 Limit of Power Spectral Density

The peak power spectral density shall not be greater than 8dBm in any 3kHz band at any time interval of continuous transmission.

3.3.2 Measuring Instruments

The measuring equipment is listed in the section 4 of this test report.

3.3.3 Test Procedures

1. The testing follows Measurement Procedure 10.2 Method PKPSD of FCC KDB Publication No. 558074 D01 DTS Meas. Guidance v03r02
2. The RF output of EUT was connected to the spectrum analyzer by RF cable and attenuator. The path loss was compensated to the results for each measurement.
3. Set to the maximum power setting and enable the EUT transmit continuously.
4. Make the measurement with the spectrum analyzer's resolution bandwidth (RBW) = 3 kHz. Video bandwidth VBW = 10 kHz In order to make an accurate measurement, set the span to 1.5 times DTS Channel Bandwidth. (6dB BW)
5. Detector = peak, Sweep time = auto couple, Trace mode = max hold, Allow trace to fully stabilize. Use the peak marker function to determine the maximum power level.
6. Measure and record the results in the test report.

3.3.4 Test Setup

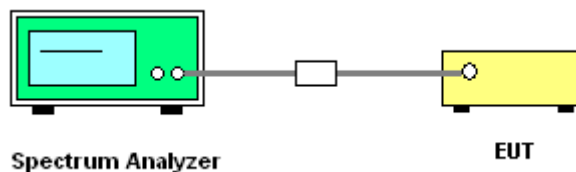



3.3.5 Test Result of Power Spectral Density

Please refer to Appendix A of this test report.

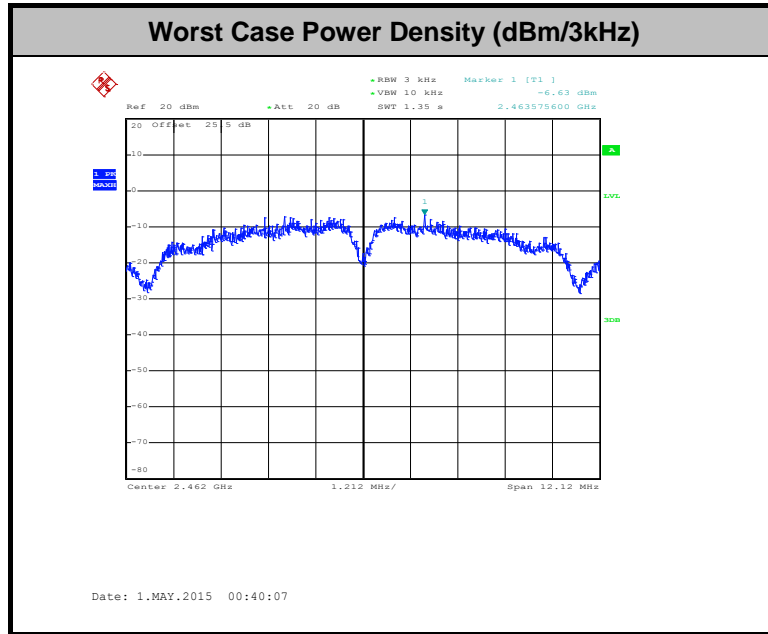

3.4 Conducted Band Edges and Spurious Emission Measurement

3.4.1 Limit of Conducted Band Edges and Spurious Emission Measurement

In any 100 kHz bandwidth outside of the authorized frequency band, the emissions which fall in the non-restricted bands shall be attenuated at least 20 dB / 30dB relative to the maximum PSD level in 100 kHz by RF conducted measurement and radiated emissions which fall in the restricted bands, as defined in Section 15.205(a), must also comply with the radiated emission limits specified in Section 15.209(a).

3.4.2 Measuring Instruments

The measuring equipment is listed in the section 4 of this test report.

3.4.3 Test Procedures

1. The testing follows FCC KDB Publication No. 558074 D01 DTS Meas. Guidance v03r02.
2. The RF output of EUT was connected to the spectrum analyzer by RF cable and attenuator. The path loss was compensated to the results for each measurement.
3. Set to the maximum power setting and enable the EUT transmit continuously.
4. Set RBW = 100 kHz, VBW=300 kHz, Peak Detector. Unwanted Emissions measured in any 100 kHz bandwidth outside of the authorized frequency band shall be attenuated by at least 20 dB relative to the maximum in-band peak PSD level in 100 kHz when maximum peak conducted output power procedure is used. If the transmitter complies with the conducted power limits based on the use of RMS averaging over a time interval, the attenuation required under this paragraph shall be 30 dB instead of 20 dB per 15.247(d).
5. Measure and record the results in the test report.
6. The RF fundamental frequency should be excluded against the limit line in the operating frequency band.

3.4.4 Test Setup

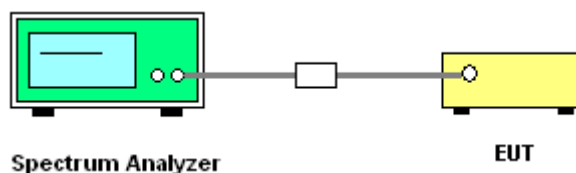



3.4.5 Test Result of Conducted Band Edges and Spurious Emission

Test Mode :	802.11b	Temperature :	21~25°C
Test Band :	2.4GHz Low	Relative Humidity :	51~54%
Test Channel :	01	Test Engineer :	Osolemio Chang

WLAN 802.11b Channel 01

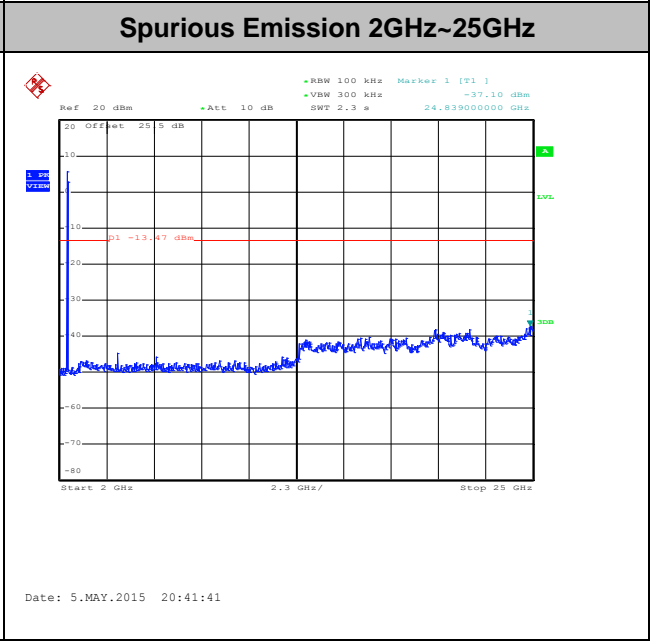
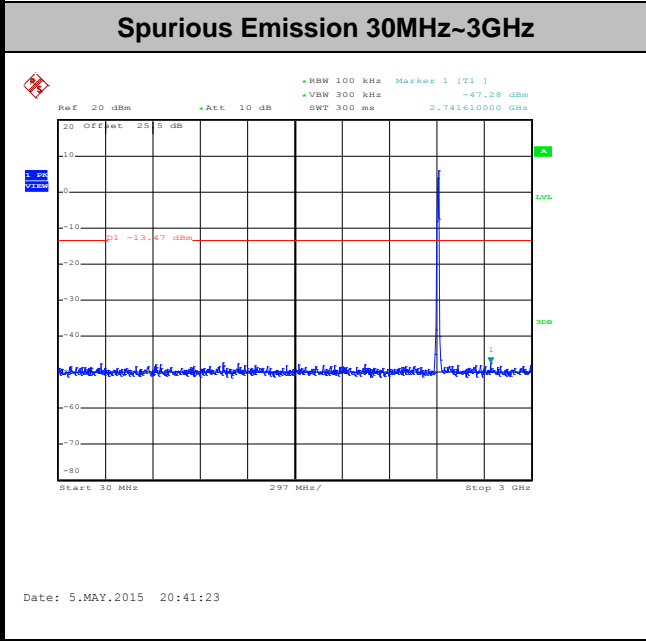
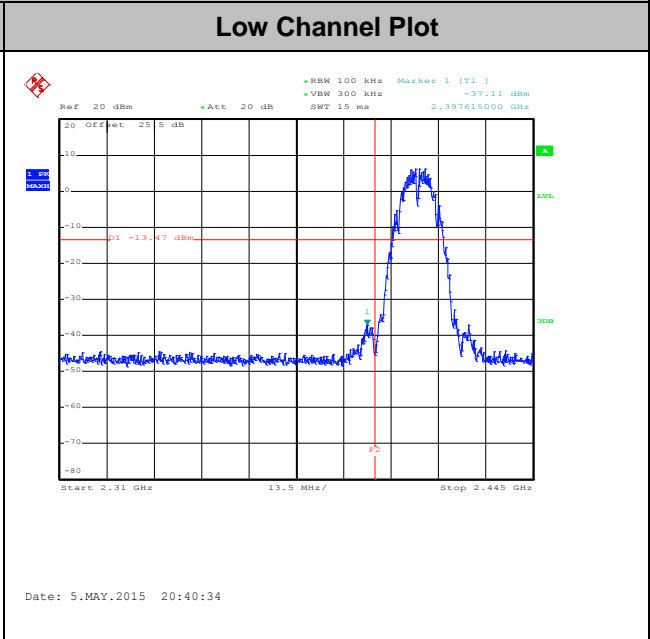
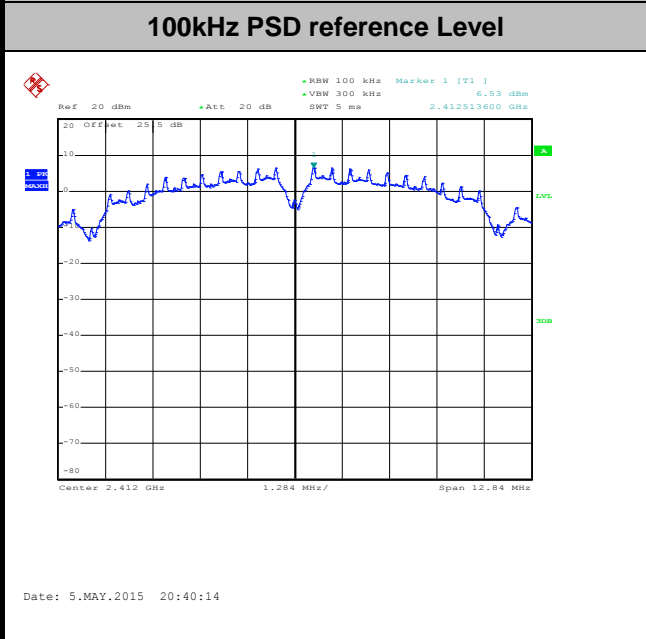



Test Mode :	802.11b	Temperature :	21~25°C
Test Band :	2.4GHz Mid	Relative Humidity :	51~54%
Test Channel :	06	Test Engineer :	Osolemio Chang

WLAN 802.11b Channel 06

100kHz PSD reference Level

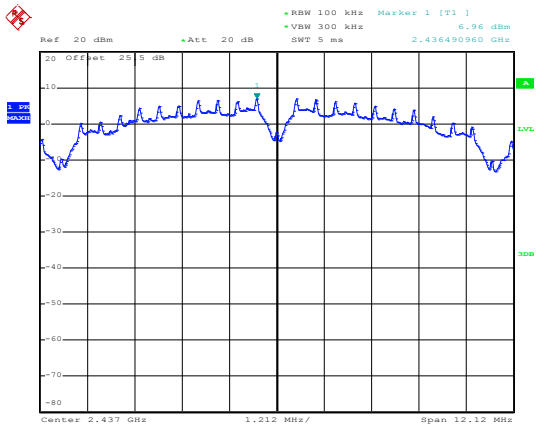

Date: 5.MAY.2015 20:48:31

Spurious Emission 30MHz~3GHz

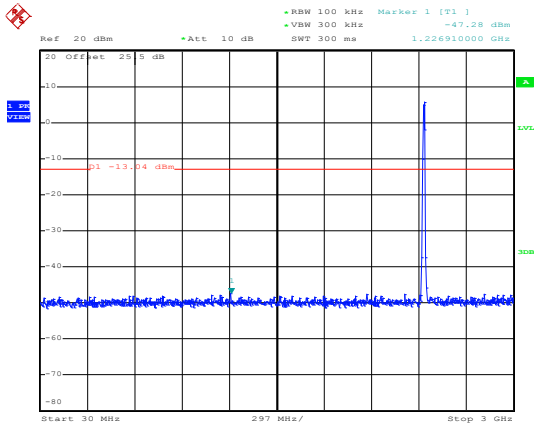

Date: 5.MAY.2015 20:48:59

Spurious Emission 2GHz~25GHz

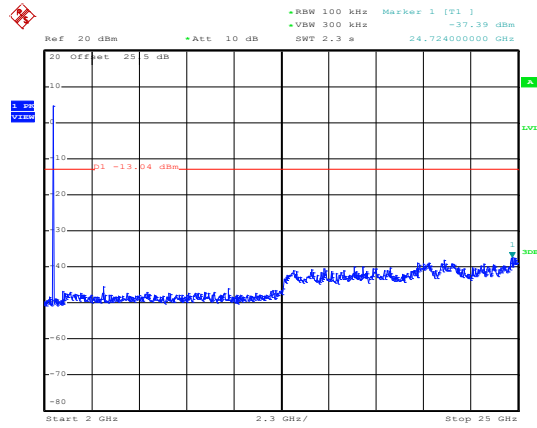

Date: 5.MAY.2015 20:49:17



Test Mode :	802.11b	Temperature :	21~25°C
Test Band :	2.4GHz High	Relative Humidity :	51~54%
Test Channel :	11	Test Engineer :	Osolemio Chang

WLAN 802.11b Channel 11

100kHz PSD reference Level

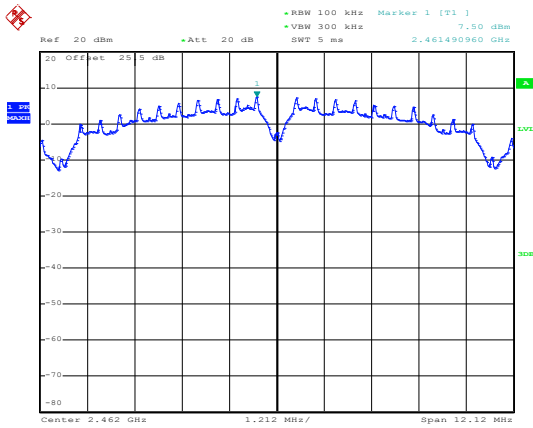

Date: 1.MAY.2015 00:40:55

High Channel Plot

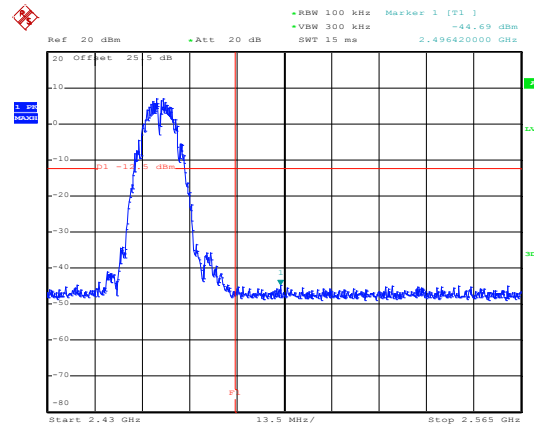

Date: 1.MAY.2015 00:41:41

Spurious Emission 30MHz~3GHz

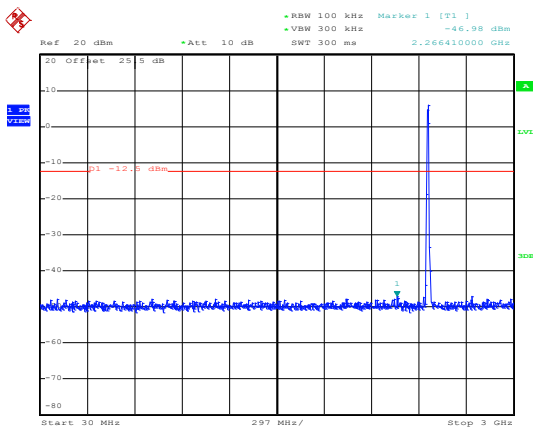

Date: 1.MAY.2015 00:42:52

Spurious Emission 2GHz~25GHz

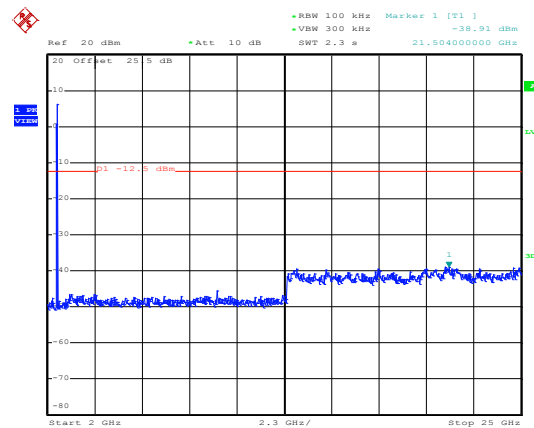

Date: 1.MAY.2015 00:43:10



Test Mode :	802.11g	Temperature :	21~25°C
Test Band :	2.4GHz Low	Relative Humidity :	51~54%
Test Channel :	01	Test Engineer :	Osolemio Chang

WLAN 802.11g Channel 01

100kHz PSD reference Level

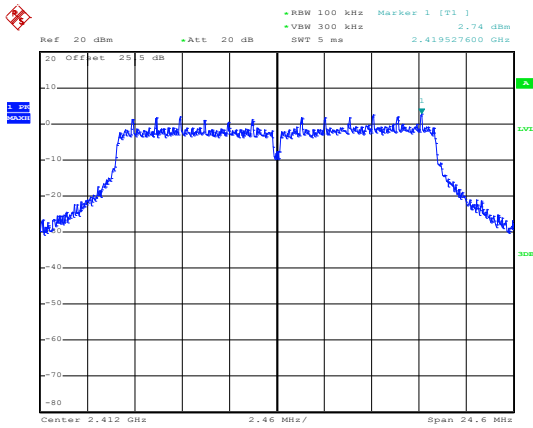

Date: 5.MAY.2015 21:07:50

Low Channel Plot

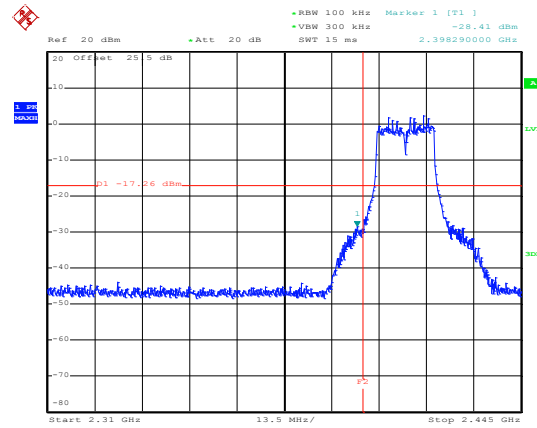

Date: 5.MAY.2015 21:08:17

Spurious Emission 30MHz~3GHz

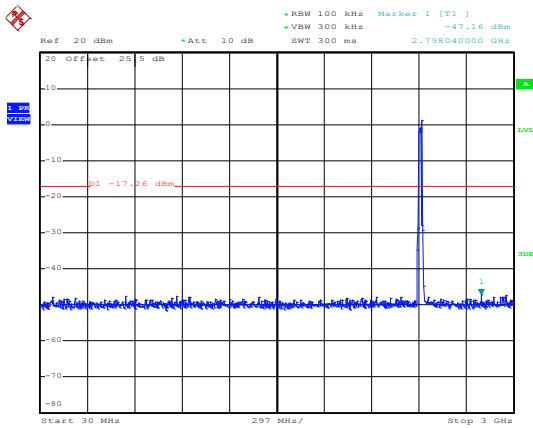

Date: 5.MAY.2015 21:08:46

Spurious Emission 2GHz~25GHz

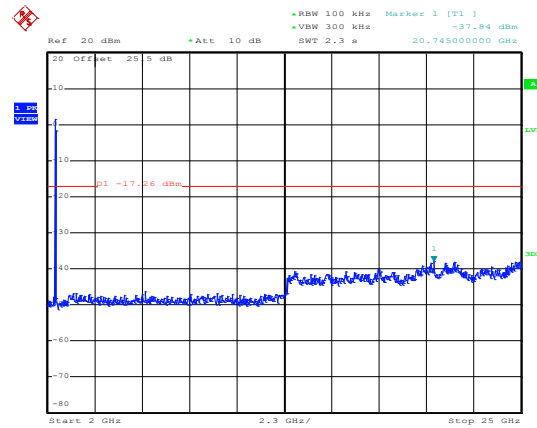

Date: 5.MAY.2015 21:09:04



Test Mode :	802.11g	Temperature :	21~25°C
Test Band :	2.4GHz Mid	Relative Humidity :	51~54%
Test Channel :	06	Test Engineer :	Osolemio Chang

WLAN 802.11g Channel 06

100kHz PSD reference Level

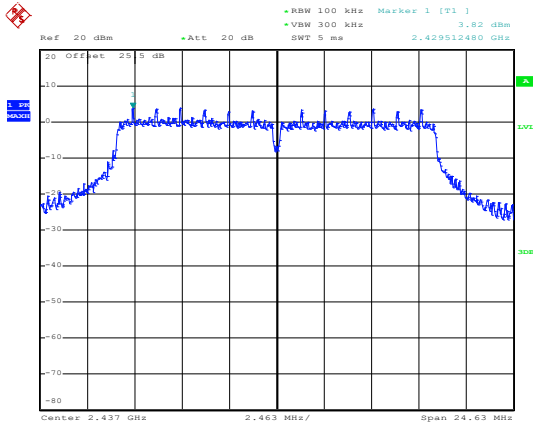

Date: 1.MAY.2015 00:52:47

Spurious Emission 30MHz~3GHz

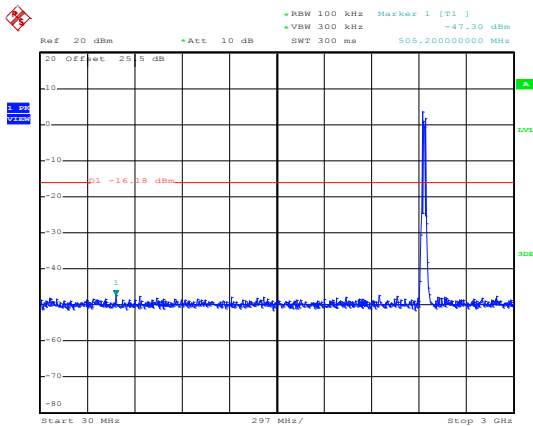

Date: 1.MAY.2015 00:53:14

Spurious Emission 2GHz~25GHz

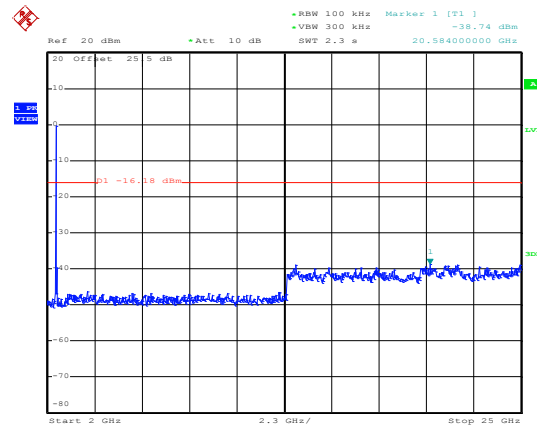

Date: 1.MAY.2015 00:53:32



Test Mode :	802.11g	Temperature :	21~25°C
Test Band :	2.4GHz High	Relative Humidity :	51~54%
Test Channel :	11	Test Engineer :	Osolemio Chang

WLAN 802.11g Channel 11

100kHz PSD reference Level

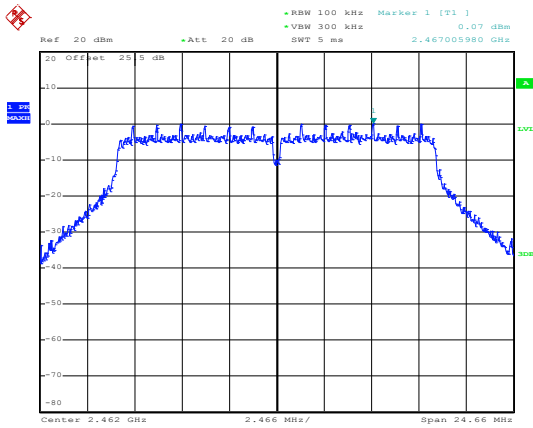

Date: 5.MAY.2015 21:21:10

High Channel Plot

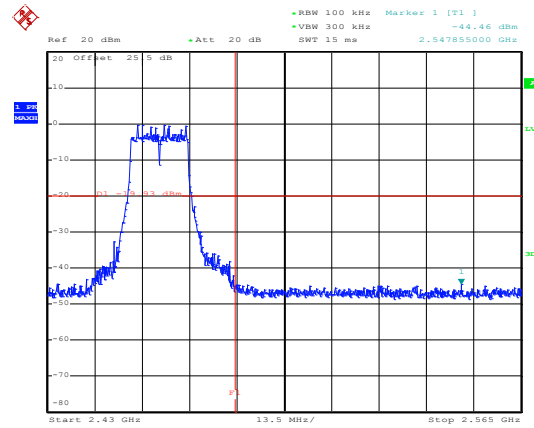

Date: 5.MAY.2015 21:22:03

Spurious Emission 30MHz~3GHz

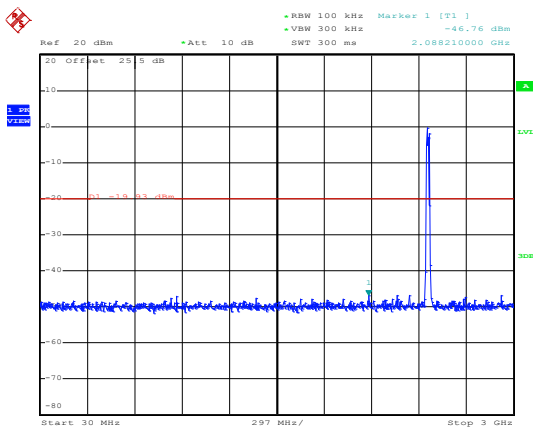

Date: 5.MAY.2015 21:22:46

Spurious Emission 2GHz~25GHz

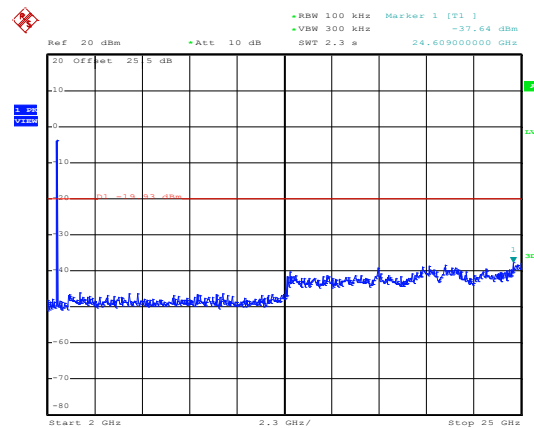

Date: 5.MAY.2015 21:23:04



Test Mode :	802.11n HT20	Temperature :	21~25°C
Test Band :	2.4GHz Low	Relative Humidity :	51~54%
Test Channel :	01	Test Engineer :	Osolemio Chang

WLAN 802.11n HT20 Channel 01

100kHz PSD reference Level

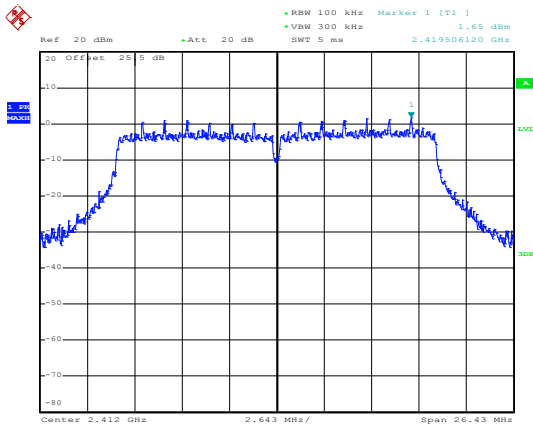

Date: 1.MAY.2015 01:09:14

Low Channel Plot

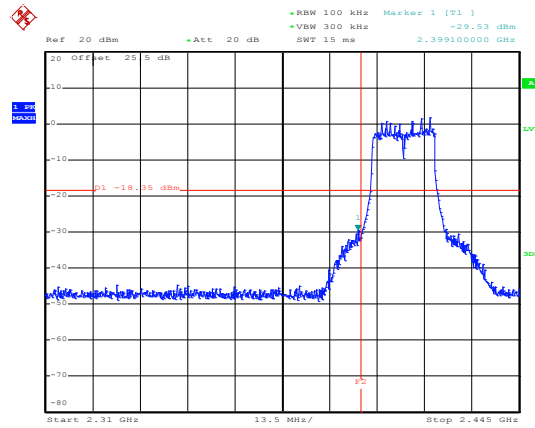

Date: 1.MAY.2015 01:10:38

Spurious Emission 30MHz~3GHz

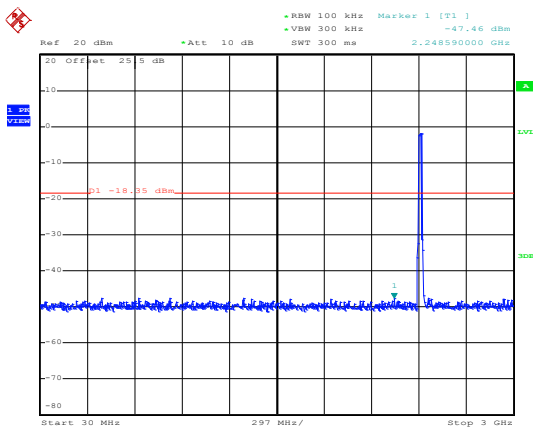

Date: 1.MAY.2015 01:11:10

Spurious Emission 2GHz~25GHz

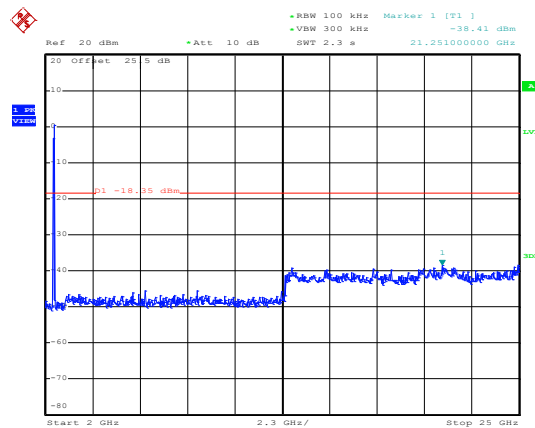

Date: 1.MAY.2015 01:11:28



Test Mode :	802.11n HT20	Temperature :	21~25°C
Test Band :	2.4GHz Mid	Relative Humidity :	51~54%
Test Channel :	06	Test Engineer :	Osolemio Chang

WLAN 802.11n HT20 Channel 06

100kHz PSD reference Level

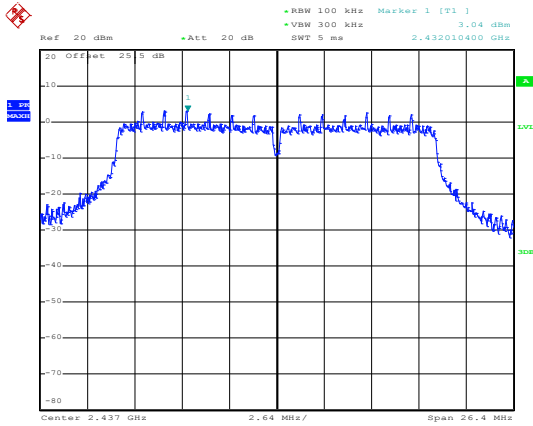

Date: 1.MAY.2015 01:16:11

Spurious Emission 30MHz~3GHz

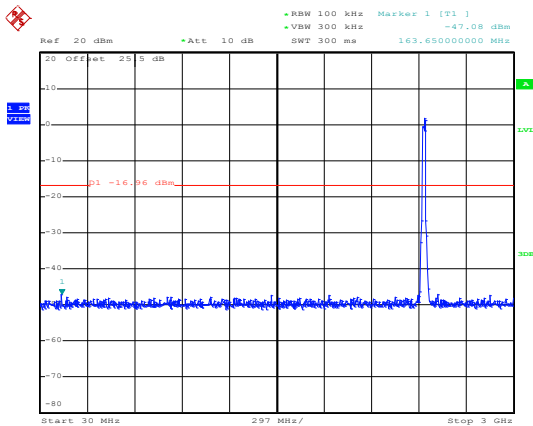

Date: 1.MAY.2015 01:16:54

Spurious Emission 2GHz~25GHz

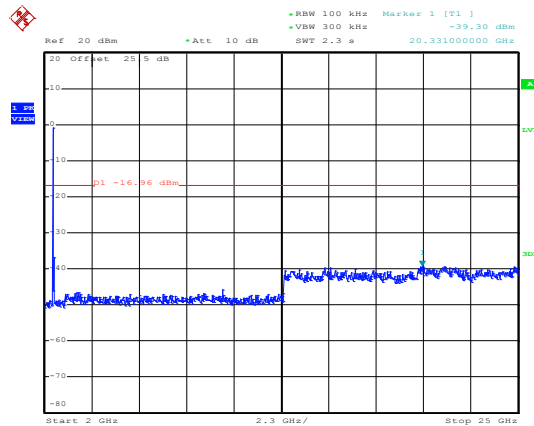

Date: 1.MAY.2015 01:17:12



Test Mode :	802.11n HT20	Temperature :	21~25°C
Test Band :	2.4GHz High	Relative Humidity :	51~54%
Test Channel :	11	Test Engineer :	Osolemio Chang

WLAN 802.11n HT20 Channel 11

100kHz PSD reference Level	High Channel Plot
----------------------------	-------------------

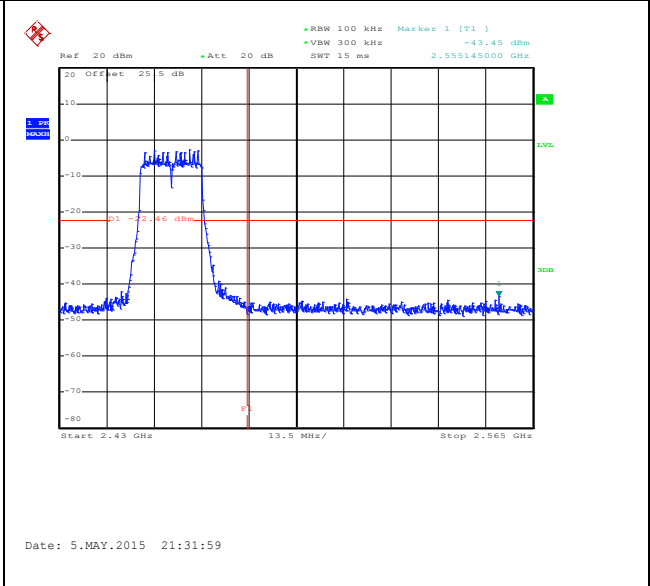
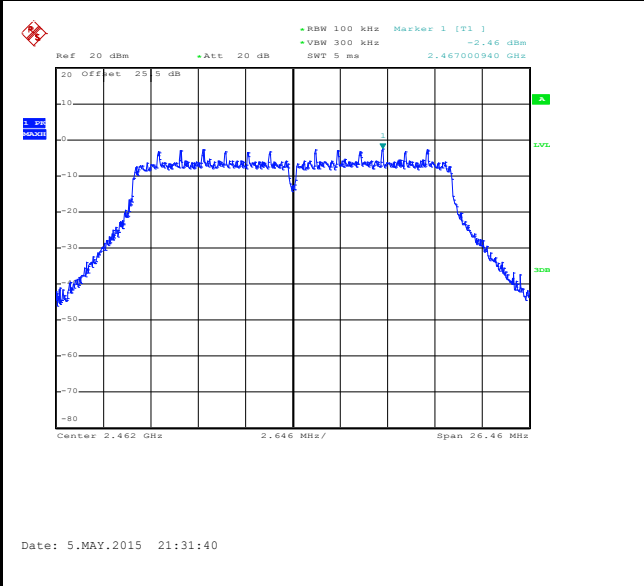

Spurious Emission 30MHz~3GHz

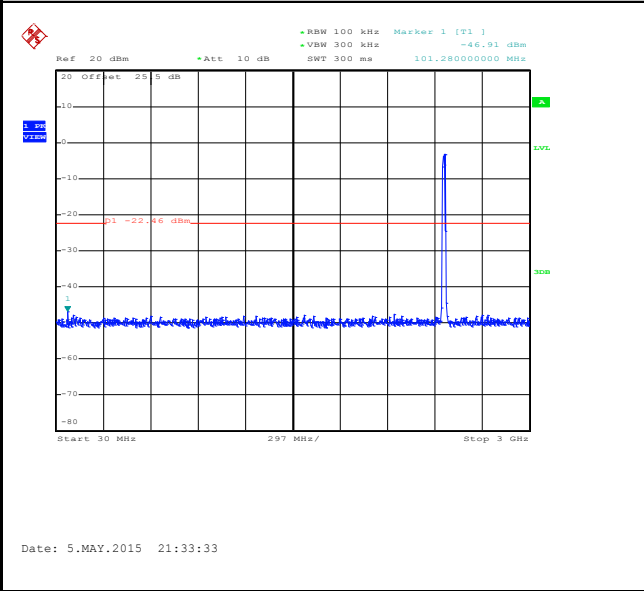

Spurious Emission 2GHz~25GHz

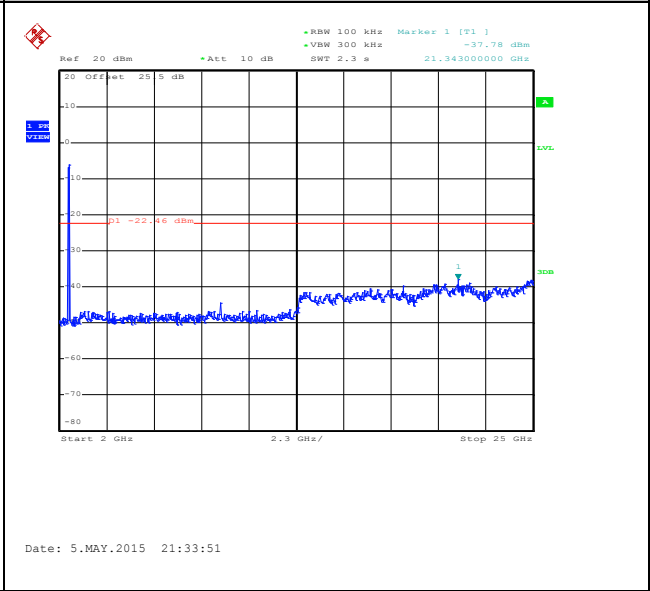



3.5 Radiated Band Edges and Spurious Emission Measurement

3.5.1 Limit of Radiated band edge and Spurious Emission Measurement

In any 100 kHz bandwidth outside the intentional radiator frequency band, all harmonics/spurious must be at least 20 dB below the highest emission level within the authorized band. If the output power of this device was measured by spectrum analyzer, the attenuation under this paragraph shall be 30 dB instead of 20 dB. In addition, radiated emissions which fall in the restricted bands must also comply with the FCC section 15.209 limits as below.

Frequency (MHz)	Field Strength (microvolts/meter)	Measurement Distance (meters)
0.009 – 0.490	2400/F(kHz)	300
0.490 – 1.705	24000/F(kHz)	30
1.705 – 30.0	30	30
30 – 88	100	3
88 – 216	150	3
216 - 960	200	3
Above 960	500	3

3.5.2 Measuring Instruments

The measuring equipment is listed in the section 4 of this test report.



3.5.3 Test Procedures

1. The testing follows FCC KDB Publication No. 558074 D01 DTS Meas. Guidance v03r02.
2. The EUT was arranged to its worst case and then tune the antenna tower (from 1 m to 4 m) and turntable (from 0 degree to 360 degrees) to find the maximum reading. A pre-amp and a high pass filter are used for the test in order to get better signal level.
3. The EUT was placed on a turntable with 0.8 meter for frequency below 1GHz and 1.5 meter for frequency above 1GHz respectively above ground.
4. The EUT was set 3 meters from the interference receiving antenna, which was mounted on the top of a variable height antenna tower.
5. Corrected Reading: Antenna Factor + Cable Loss + Read Level - Preamp Factor = Level
6. For measurement below 1GHz, If the emission level of the EUT measured by the peak detector is 3 dB lower than the applicable limit, the peak emission level will be reported. Otherwise, the emission measurement will be repeated using the quasi-peak detector and reported.
7. Use the following spectrum analyzer settings:
 - (1) Span shall wide enough to fully capture the emission being measured;
 - (2) Set RBW=100 kHz for $f < 1 \text{ GHz}$; $\text{VBW} \geq \text{RBW}$; Sweep = auto; Detector function = peak; Trace = max hold;
 - (3) Set RBW = 1 MHz, VBW= 3MHz for $f \geq 1 \text{ GHz}$ for peak measurement.
For average measurement:
 - $\text{VBW} = 10 \text{ Hz}$, when duty cycle is no less than 98 percent.
 - $\text{VBW} \geq 1/T$, when duty cycle is less than 98 percent where T is the minimum transmission duration over which the transmitter is on and is transmitting at its maximum power control level for the tested mode of operation.

Band	Duty Cycle(%)	T(μs)	1/T(kHz)	VBW Setting
802.11b	97.16	8220	0.12	300Hz
802.11g	86.73	1360	0.74	1kHz
2.4GHz 802.11n HT20	86.49	1280	0.78	1kHz

3.5.4 Test Setup

For radiated emissions below 30MHz

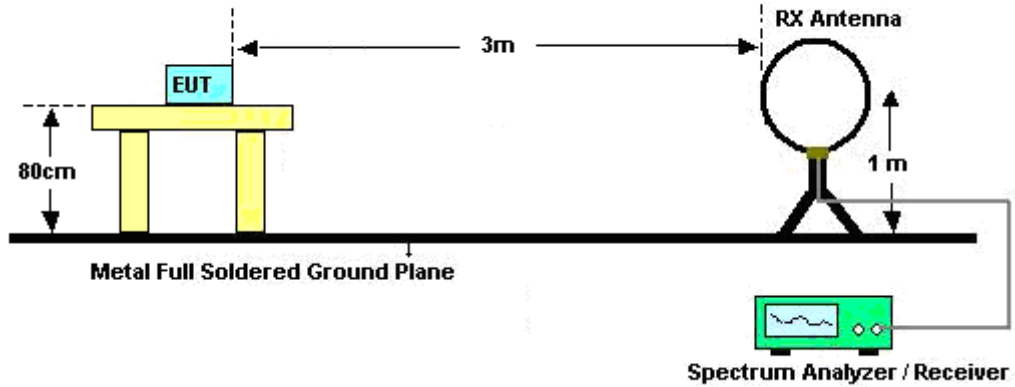

For radiated emissions from 30MHz to 1GHz

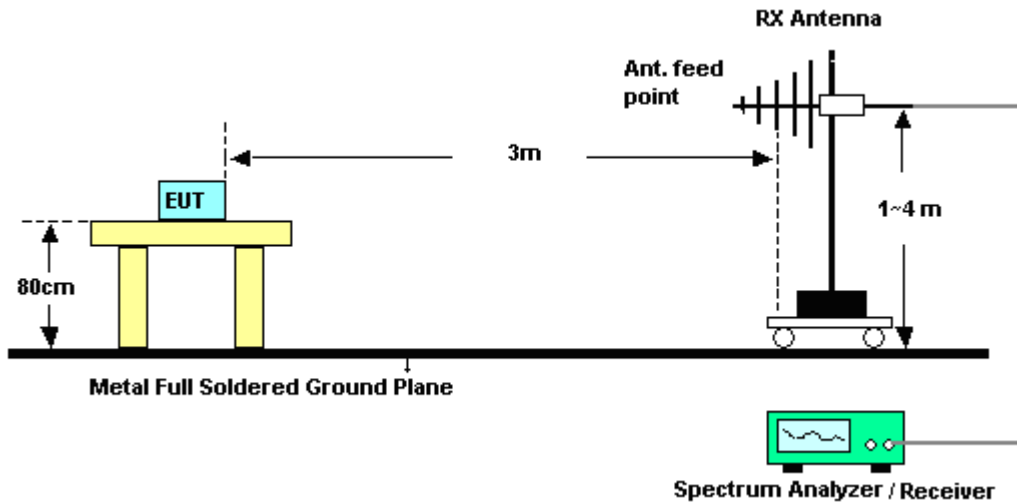

For radiated emissions above 1GHz

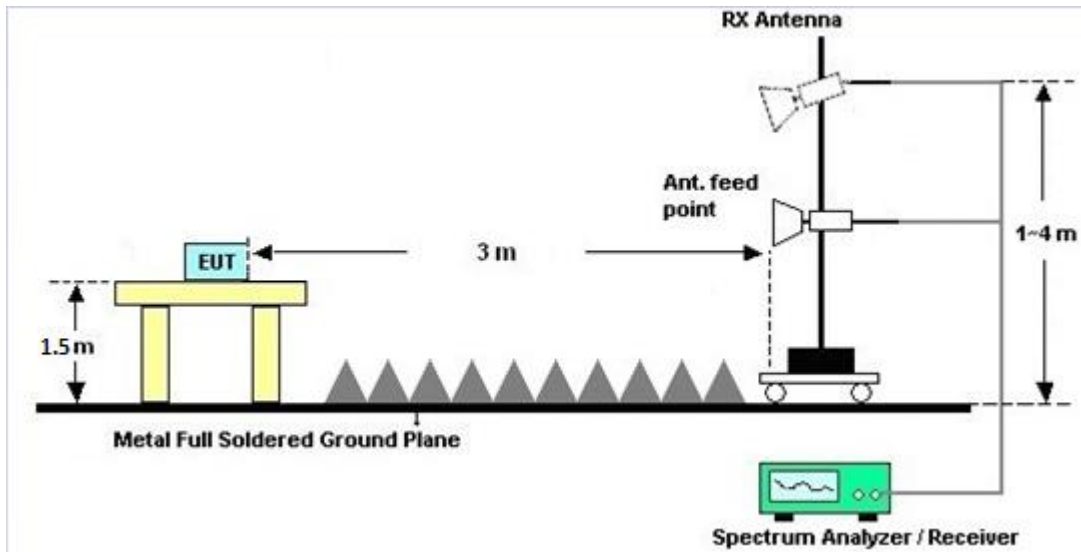

3.5.5 Test Results of Radiated Spurious Emissions (9kHz ~ 30MHz)

The low frequency, which started from 9 kHz to 30MHz, was pre-scanned and the result which was 20dB lower than the limit line per 15.31(o) was not reported.

3.5.6 Test Result of Radiated Spurious at Band Edges

Please refer to Appendix B.

3.5.7 Test Result of Radiated Spurious Emission (30MHz ~ 10th Harmonic)

Please refer to Appendix B.



3.6 AC Conducted Emission Measurement

3.6.1 Limit of AC Conducted Emission

For equipment that is designed to be connected to the public utility (AC) power line, the radio frequency voltage that is conducted back onto the AC power line on any frequency or frequencies within the band 150 kHz to 30 MHz shall not exceed the limits in the following table.

Frequency of Emission (MHz)	Conducted Limit (dB μ V)	
	Quasi-Peak	Average
0.15-0.5	66 to 56*	56 to 46*
0.5-5	56	46
5-30	60	50

*Decreases with the logarithm of the frequency.

3.6.2 Measuring Instruments

The measuring equipment is listed in the section 4 of this test report.

3.6.3 Test Procedures

1. The EUT was placed 0.4 meter from the conducting wall of the shielding room, and it was kept at least 80 centimeters from any other grounded conducting surface.
2. Connect EUT to the power mains through a line impedance stabilization network (LISN).
3. All the support units are connecting to the other LISN.
4. The LISN provides 50 ohm coupling impedance for the measuring instrument.
5. The FCC states that a 50 ohm, 50 microhenry LISN should be used.
6. Both sides of AC line were checked for maximum conducted interference.
7. The frequency range from 150 kHz to 30 MHz was searched.
8. Set the test-receiver system to Peak Detect Function and specified bandwidth (IF bandwidth = 9kHz) with Maximum Hold Mode.

3.6.4 Test Setup

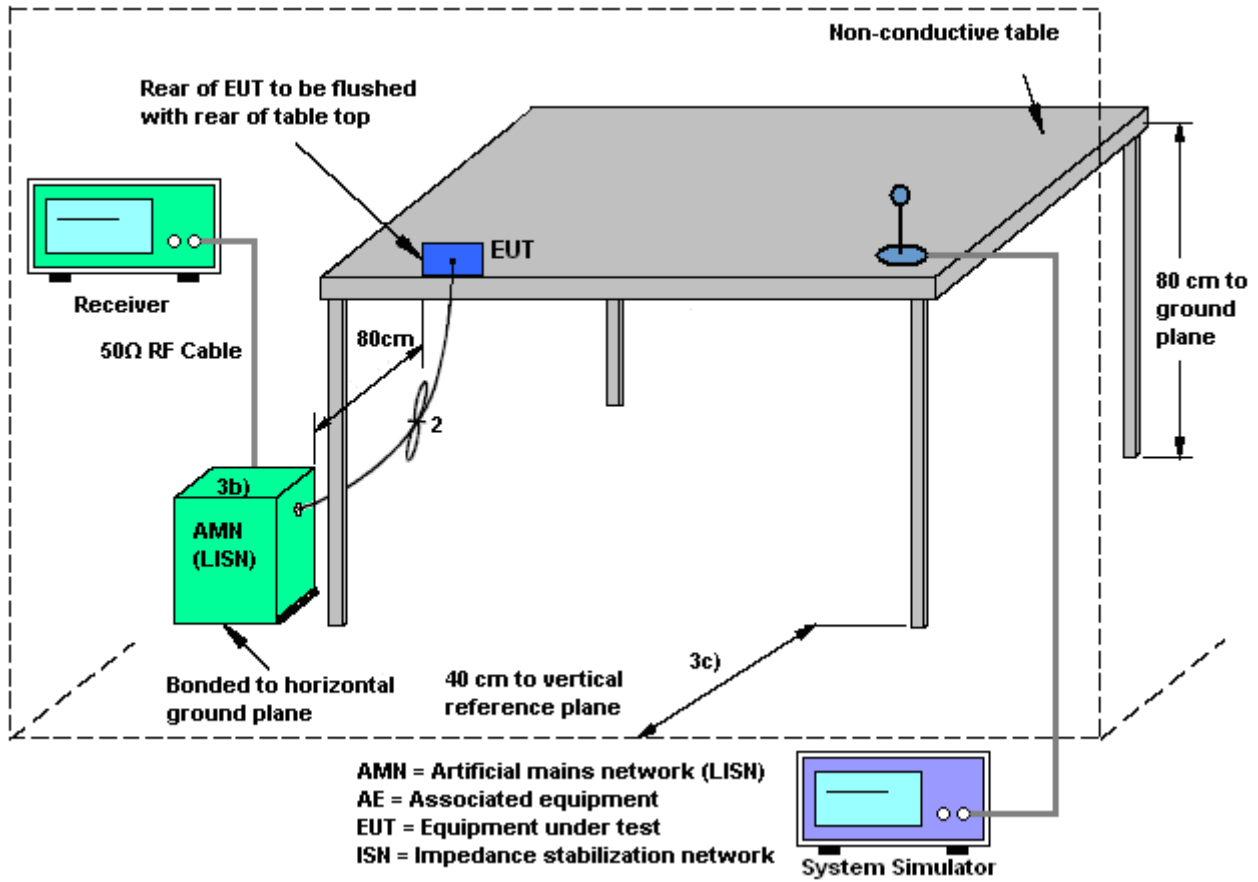

3.6.5 Test Result of AC Conducted Emission

Test Mode :	Mode 1	Temperature :	24~26°C
Test Engineer :	Eric Jeng	Relative Humidity :	53~55%
Test Voltage :	120Vac / 60Hz	Phase :	Line
Function Type :	GSM850 Idle + Bluetooth Link + WLAN Link + MP3 + Earphone + USB Cable (Charging from Adapter)		

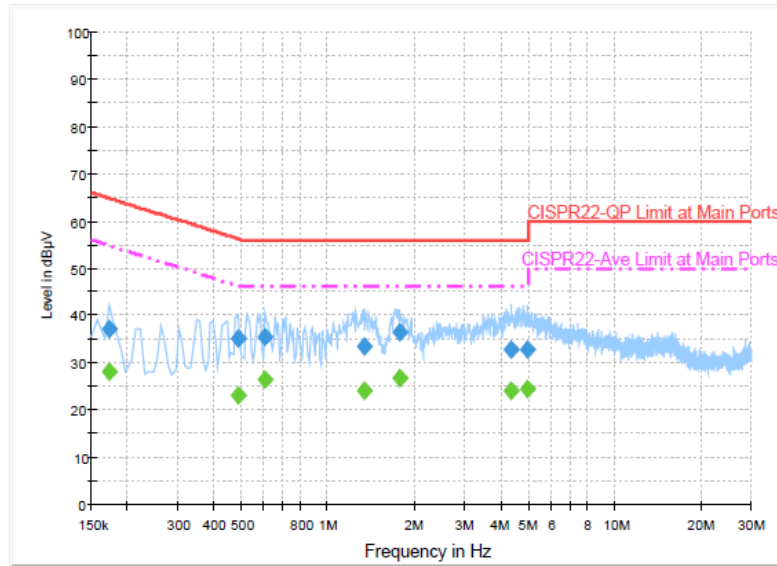

Final Result : Quasi-Peak

Frequency (MHz)	Quasi-Peak (dBμV)	Filter	Line	Corr. (dB)	Margin (dB)	Limit (dBμV)
0.174000	37.0	Off	L1	19.4	27.8	64.8
0.486000	35.0	Off	L1	19.5	21.2	56.2
0.606000	35.6	Off	L1	19.4	20.4	56.0
1.334000	33.5	Off	L1	19.6	22.5	56.0
1.782000	36.4	Off	L1	19.6	19.6	56.0
4.358000	32.7	Off	L1	19.7	23.3	56.0
4.950000	32.9	Off	L1	19.8	23.1	56.0

Final Result : Average

Frequency (MHz)	Average (dBμV)	Filter	Line	Corr. (dB)	Margin (dB)	Limit (dBμV)
0.174000	28.1	Off	L1	19.4	26.7	54.8
0.486000	23.2	Off	L1	19.5	23.0	46.2
0.606000	26.5	Off	L1	19.4	19.5	46.0
1.334000	24.2	Off	L1	19.6	21.8	46.0
1.782000	26.8	Off	L1	19.6	19.2	46.0
4.358000	24.2	Off	L1	19.7	21.8	46.0
4.950000	24.6	Off	L1	19.8	21.4	46.0



Test Mode :	Mode 1	Temperature :	24~26°C
Test Engineer :	Eric Jeng	Relative Humidity :	53~55%
Test Voltage :	120Vac / 60Hz	Phase :	Neutral
Function Type :	GSM850 Idle + Bluetooth Link + WLAN Link + MP3 + Earphone + USB Cable (Charging from Adapter)		

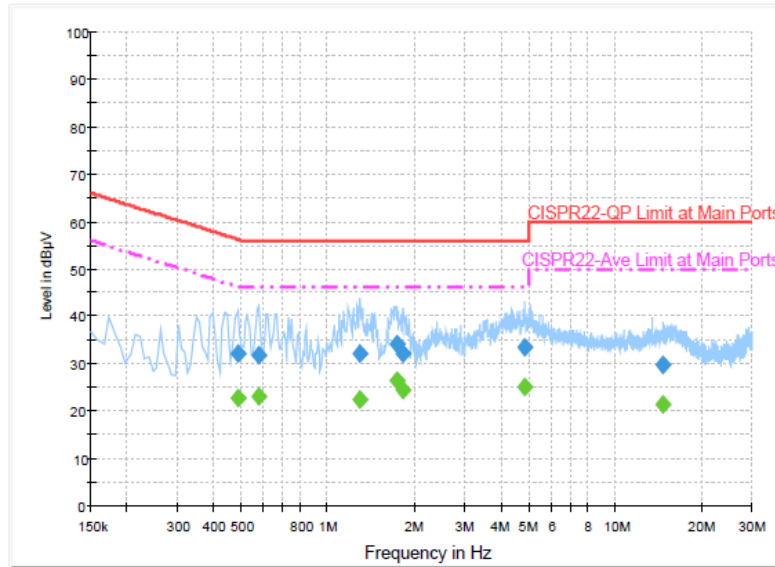

Final Result : Quasi-Peak

Frequency (MHz)	Quasi-Peak (dBµV)	Filter	Line	Corr. (dB)	Margin (dB)	Limit (dBµV)
0.486000	32.2	Off	N	19.5	24.0	56.2
0.574000	31.9	Off	N	19.4	24.1	56.0
1.294000	32.2	Off	N	19.6	23.8	56.0
1.742000	34.0	Off	N	19.6	22.0	56.0
1.830000	32.0	Off	N	19.6	24.0	56.0
4.862000	33.5	Off	N	19.7	22.5	56.0
14.686000	29.8	Off	N	20.0	30.2	60.0

Final Result : Average

Frequency (MHz)	Average (dBµV)	Filter	Line	Corr. (dB)	Margin (dB)	Limit (dBµV)
0.486000	22.7	Off	N	19.5	23.5	46.2
0.574000	23.1	Off	N	19.4	22.9	46.0
1.294000	22.5	Off	N	19.6	23.5	46.0
1.742000	26.3	Off	N	19.6	19.7	46.0
1.830000	24.4	Off	N	19.6	21.6	46.0
4.862000	25.0	Off	N	19.7	21.0	46.0
14.686000	21.3	Off	N	20.0	28.7	50.0



3.7 Antenna Requirements

3.7.1 Standard Applicable

If directional gain of transmitting antennas is greater than 6dBi, the power shall be reduced by the same level in dB comparing to gain minus 6dBi. For the fixed point-to-point operation, the power shall be reduced by one dB for every 3 dB that the directional gain of the antenna exceeds 6 dBi. The use of a permanently attached antenna or of an antenna that uses a unique coupling to the intentional radiator shall be considered sufficient to comply with the FCC rule.

3.7.2 Antenna Anti-Replacement Construction

An embedded-in antenna design is used.

3.7.3 Antenna Gain

The antenna peak gain of EUT is less than 6 dBi. Therefore, it is not necessary to reduce maximum peak output power limit.



4 List of Measuring Equipment

Instrument	Manufacturer	Model No.	Serial No.	Characteristics	Calibration Date	Test Date	Due Date	Remark
Power Meter	Anritsu	ML2495A	1036004	300MHz~40GHz	Aug. 09, 2014	Apr. 30. 2015~ May. 05. 2015	Aug. 08, 2015	Conducted (TH02-HY)
Power Sensor	Anritsu	MA2411B	1027253	300MHz~40GHz	Aug. 11, 2014	Apr. 30. 2015~ May. 05. 2015	Aug. 10, 2015	Conducted (TH02-HY)
Spectrum Analyzer	Rohde & Schwarz	FSP40	100055	9kHz~40GHz	Jun. 09, 2014	Apr. 30. 2015~ May. 05. 2015	Jun. 08, 2015	Conducted (TH02-HY)
SHF-EHF Horn Antenna	SCHWARZBECK	BBHA 9170	BBHA9170 251	18GHz- 40GHz	Oct. 02, 2014	May 04, 2015~ May 05, 2015	Oct. 01, 2015	Radiation (03CH07-HY)
EMI Test Receiver	Rohde & Schwarz	ESCI 7	100724	9 kHz~7 GHz	Aug. 30, 2014	May 04, 2015~ May 05, 2015	Aug. 29, 2015	Radiation (03CH07-HY)
Bilog Antenna	Schaffner	CBL6111C	2726	30MHz ~ 1GHz	Sep. 27, 2014	May 04, 2015~ May 05, 2015	Sep. 26, 2015	Radiation (03CH07-HY)
Double Ridge Horn Antenna	ESCO	3117	00075962	1GHz ~ 18GHz	Aug. 19, 2014	May 04, 2015~ May 05, 2015	Aug. 18, 2015	Radiation (03CH07-HY)
Preamplifier	MITEQ	AMF-7D-0010 1800-30-10P	1590075	1GHz ~ 18GHz	Apr. 20, 2015	May 04, 2015~ May 05, 2015	Apr. 19, 2016	Radiation (03CH07-HY)
Signal Analyzer	Rohde & Schwarz	FSV 30	101749	10Hz~30GHz	Mar. 10, 2015	May 04, 2015~ May 05, 2015	Mar. 09, 2016	Radiation (03CH07-HY)
Antenna Mast	Max-Full	MFA520BS	N/A	1m~4m	N/A	May 04, 2015~ May 05, 2015	N/A	Radiation (03CH07-HY)
Turn Table	ChainTek	Chaintek 3000	N/A	0~360 degree	N/A	May 04, 2015~ May 05, 2015	N/A	Radiation (03CH07-HY)
Preamplifier	MITEQ	JS44-180040 00-33-8P	1840917	18GHz ~ 40GHz	Nov. 19, 2014	May 04, 2015~ May 05, 2015	Nov. 18, 2015	Radiation (03CH07-HY)
Preamplifier	COM-POWER	PA-103A	161241	10 MHz ~ 1000MHz	Mar. 12, 2015	May 04, 2015~ May 05, 2015	Mar. 11, 2016	Radiation (03CH07-HY)
Preamplifier	Agilent	8449B	3008A023 62	1 GHz~26.5 GHz	Oct. 21, 2014	May 04, 2015~ May 05, 2015	Oct. 20, 2015	Radiation (03CH07-HY)
Loop Antenna	R&S	HFH2-Z2	100315	9 kHz~30 MHz	Jul. 28, 2014	May 04, 2015~ May 05, 2015	Jul. 27, 2015	Radiation (03CH07-HY)
EMI Test Receiver	Rohde & Schwarz	ESCS 30	100356	9kHz – 2.75GHz	Dec. 01, 2014	May 05, 2015	Nov. 30, 2015	Conduction (CO05-HY)
LISN	Rohde & Schwarz	ENV216	100080	9kHz~30MHz	Dec. 02, 2014	May 05, 2015	Dec. 01, 2015	Conduction (CO05-HY)
LISN (for auxiliary equipment)	Rohde & Schwarz	ENV216	100081	9kHz ~ 30MHz	Dec. 08, 2014	May 05, 2015	Dec. 07, 2015	Conduction (CO05-HY)
AC Power Source	ChainTek	APC-1000W	N/A	N/A	N/A	May 05, 2015	N/A	Conduction (CO05-HY)



5 Uncertainty of Evaluation

Uncertainty of Conducted Emission Measurement (150kHz ~ 30MHz)

Measuring Uncertainty for a Level of Confidence of 95% ($U = 2Uc(y)$)	2.26
---	------

Uncertainty of Radiated Emission Measurement (30 MHz ~ 1000 MHz)

Measuring Uncertainty for a Level of Confidence of 95% ($U = 2Uc(y)$)	4.50
---	------



Appendix A. Conducted Test Results

A1 - DTS Part

Test Engineer:	osolemio Chang	Temperature:	21~25	°C
Test Date:	2015/4/30	Relative Humidity:	51~54	%

TEST RESULTS DATA
6dB and 99% Occupied Bandwidth

2.4GHz Band								
Mod.	Data Rate	N _{TX}	CH.	Freq. (MHz)	99% Occupied BW (MHz)	6dB BW (MHz)	6dB BW Limit (MHz)	Pass/Fail
11b	1Mbps	1	1	2412	13.55	8.56	0.50	Pass
11b	1Mbps	1	6	2437	13.50	8.08	0.50	Pass
11b	1Mbps	1	11	2462	13.45	8.08	0.50	Pass
11g	6Mbps	1	1	2412	18.35	16.40	0.50	Pass
11g	6Mbps	1	6	2437	18.50	16.42	0.50	Pass
11g	6Mbps	1	11	2462	18.15	16.44	0.50	Pass
HT20	MCS0	1	1	2412	19.30	17.62	0.50	Pass
HT20	MCS0	1	6	2437	19.25	17.60	0.50	Pass
HT20	MCS0	1	11	2462	18.95	17.64	0.50	Pass

TEST RESULTS DATA
Peak Power Table

2.4GHz Band										
Mod.	Data Rate	N _{TX}	CH.	Freq. (MHz)	Peak Conducted Power (dBm)	Conducted Power Limit (dBm)	DG (dBi)	EIRP Power (dBm)	EIRP Power Limit (dBm)	Pass /Fail
11b	1Mbps	1	1	2412	17.81	30.00	0.50	18.31	36.00	Pass
11b	1Mbps	1	6	2437	18.14	30.00	0.50	18.64	36.00	Pass
11b	1Mbps	1	11	2462	18.47	30.00	0.50	18.97	36.00	Pass
11g	6Mbps	1	1	2412	21.47	30.00	0.50	21.97	36.00	Pass
11g	6Mbps	1	6	2437	22.25	30.00	0.50	22.75	36.00	Pass
11g	6Mbps	1	11	2462	20.56	30.00	0.50	21.06	36.00	Pass
HT20	MCS0	1	1	2412	21.24	30.00	0.50	21.74	36.00	Pass
HT20	MCS0	1	6	2437	21.95	30.00	0.50	22.45	36.00	Pass
HT20	MCS0	1	11	2462	18.74	30.00	0.50	19.24	36.00	Pass

TEST RESULTS DATA
Average Power Table
(Reporting Only)

2.4GHz Band						
Mod.	Data Rate	N _{TX}	CH.	Freq. (MHz)	Duty Factor (dB)	Average Conducted Power (dBm)
11b	1Mbps	1	1	2412	0.13	15.31
11b	1Mbps	1	6	2437	0.13	15.48
11b	1Mbps	1	11	2462	0.13	15.88
11g	6Mbps	1	1	2412	0.62	13.57
11g	6Mbps	1	6	2437	0.62	15.16
11g	6Mbps	1	11	2462	0.62	11.75
HT20	MCS0	1	1	2412	0.63	12.86
HT20	MCS0	1	6	2437	0.63	14.30
HT20	MCS0	1	11	2462	0.63	9.17

TEST RESULTS DATA
Peak Power Density

2.4GHz Band								
Mod.	Data Rate	N _{TX}	CH.	Freq. (MHz)	Peak PSD (dBm /3kHz)	DG (dBi)	Peak PSD Limit (dBm /3kHz)	Pass/Fail
11b	1Mbps	1	1	2412	-7.02	0.50	8.00	Pass
11b	1Mbps	1	6	2437	-6.94	0.50	8.00	Pass
11b	1Mbps	1	11	2462	-6.63	0.50	8.00	Pass
11g	6Mbps	1	1	2412	-12.02	0.50	8.00	Pass
11g	6Mbps	1	6	2437	-10.17	0.50	8.00	Pass
11g	6Mbps	1	11	2462	-13.27	0.50	8.00	Pass
HT20	MCS0	1	1	2412	-12.92	0.50	8.00	Pass
HT20	MCS0	1	6	2437	-11.59	0.50	8.00	Pass
HT20	MCS0	1	11	2462	-16.48	0.50	8.00	Pass



Appendix B. Radiated Spurious Emission

Test Engineer :	Nick Yu and Ken Wu and James Chiu	Temperature :	22~23°C
		Relative Humidity :	58~62%

15C 2.4GHz 2400~2483.5MHz

WIFI 802.11b (Band Edge @ 3m)

WIFI	Note	Frequency	Level	Over	Limit	Read	Antenna	Cable	Preamp	Ant	Table	Peak	Pol.	
Ant.				Limit	Line	Level	Factor	Loss	Factor	Pos	Pos	Avg.		
1		(MHz)	(dB μ V/m)	(dB)	(dB μ V/m)	(dB μ V)	(dB/m)	(dB)	(dB)	(cm)	(deg)	(P/A)	(H/V)	
802.11b CH 01 2412MHz		2311.26	58.37	-15.63	74	52.89	32.07	7.6	34.19	102	130	P	H	
		2387.76	45.27	-8.73	54	39.61	32.18	7.75	34.27	102	130	A	H	
	*	2412	107.82	-	-	102.17	32.2	7.75	34.3	102	130	P	H	
	*	2412	104.2	-	-	98.55	32.2	7.75	34.3	102	130	A	H	
													H	
														H
			2337.36	58.17	-15.83	74	52.68	32.11	7.6	34.22	396	71	P	V
			2378.76	44.89	-9.11	54	39.32	32.16	7.68	34.27	396	71	A	V
	*		2412	105.37	-	-	99.72	32.2	7.75	34.3	396	71	P	V
	*		2412	101.69	-	-	96.04	32.2	7.75	34.3	396	71	A	V
														V
														V
802.11b CH 06 2437MHz		2373	58.58	-15.42	74	53.01	32.16	7.68	34.27	102	109	P	H	
		2330.7	44.95	-9.05	54	39.48	32.09	7.6	34.22	102	109	A	H	
	*	2437	109.96	-	-	104.24	32.24	7.83	34.35	102	109	P	H	
	*	2437	106.2	-	-	100.48	32.24	7.83	34.35	102	109	A	H	
			2483.64	59.24	-14.76	74	53.48	32.28	7.91	34.43	102	109	P	H
			2483.84	45.25	-8.75	54	39.49	32.28	7.91	34.43	102	109	A	H
			2363.73	59.42	-14.58	74	53.86	32.13	7.68	34.25	397	88	P	V
			2331.33	44.86	-9.14	54	39.39	32.09	7.6	34.22	397	88	A	V
	*		2437	107.13	-	-	101.41	32.24	7.83	34.35	397	88	P	V
	*		2437	103.23	-	-	97.51	32.24	7.83	34.35	397	88	A	V
			2484.68	59.24	-14.76	74	53.48	32.28	7.91	34.43	397	88	P	V
			2486.52	45.15	-8.85	54	39.39	32.28	7.91	34.43	397	88	A	V



802.11b CH 11 2462MHz	*	2462	109.31	-	-	103.53	32.26	7.91	34.39	100	96	P	H
	*	2462.792	105.57	-	-	99.79	32.26	7.91	34.39	100	96	A	H
		2483.64	60.71	-13.29	74	54.95	32.28	7.91	34.43	100	96	P	H
		2483.52	49.27	-4.73	54	43.51	32.28	7.91	34.43	100	96	A	H
													H
													H
	*	2462	105.55	-	-	99.77	32.26	7.91	34.39	385	57	P	V
	*	2462	101.86	-	-	96.08	32.26	7.91	34.39	385	57	A	V
		2483.96	59.53	-14.47	74	53.77	32.28	7.91	34.43	385	57	P	V
		2483.52	46.38	-7.62	54	40.62	32.28	7.91	34.43	385	57	A	V
													V
													V
Remark	1. No other spurious found. 2. All results are PASS against Peak and Average limit line.												



15C 2.4GHz 2400~2483.5MHz

WIFI 802.11b (Harmonic @ 3m)

WIFI	Note	Frequency	Level	Over	Limit	Read	Antenna	Cable	Preamp	Ant	Table	Peak	Pol.
Ant.				Limit	Line	Level	Factor	Loss	Factor	Pos	Pos	Avg.	
1		(MHz)	(dBμV/m)	(dB)	(dBμV/m)	(dBμV)	(dB/m)	(dB)	(dB)	(cm)	(deg)	(P/A)	(H/V)
802.11b CH 01 2412MHz		4824	54.97	-19.03	74	69.19	34.26	11.16	59.64	100	229	P	H
		4824	53.17	-0.83	54	67.39	34.26	11.16	59.64	100	229	A	H
													H
													H
		4824	52.94	-21.06	74	67.16	34.26	11.16	59.64	255	45	P	V
		4824	51.31	-2.69	54	65.53	34.26	11.16	59.64	255	45	A	V
													V
													V
802.11b CH 06 2437MHz		4872	55.3	-18.7	74	69.36	34.3	11.21	59.57	105	114	P	H
		4872	53.46	-0.54	54	67.52	34.3	11.21	59.57	105	114	A	H
		7311	41.36	-32.64	74	49.15	35.6	15.08	58.47	100	0	P	H
													H
		4872	52.3	-21.7	74	66.36	34.3	11.21	59.57	264	52	P	V
		4872	49.7	-4.3	54	63.76	34.3	11.21	59.57	264	52	A	V
		7311	45.54	-28.46	74	53.33	35.6	15.08	58.47	100	0	P	V
													V
802.11b CH 11 2462MHz		4926	52.63	-21.37	74	66.52	34.34	11.27	59.5	100	110	P	H
		4926	50.86	-3.14	54	64.75	34.34	11.27	59.5	100	110	A	H
		7386	42.27	-31.73	74	50.11	35.6	15.14	58.58	100	0	P	H
													H
		4924	50.64	-23.36	74	64.53	34.34	11.27	59.5	100	0	P	V
		7386	43.49	-30.51	74	51.33	35.6	15.14	58.58	100	0	P	V
													V
													V
Remark	1. No other spurious found. 2. All results are PASS against Peak and Average limit line.												



15C 2.4GHz 2400~2483.5MHz

WIFI 802.11g (Band Edge @ 3m)

WIFI	Note	Frequency	Level	Over	Limit	Read	Antenna	Cable	Preamp	Ant	Table	Peak	Pol.	
Ant.				Limit	Line	Level	Factor	Loss	Factor	Pos	Pos	Avg.		
1		(MHz)	(dBμV/m)	(dB)	(dBμV/m)	(dBμV)	(dB/m)	(dB)	(dB)	(cm)	(deg)	(P/A)	(H/V)	
802.11g CH 01 2412MHz		2389.65	72.02	-1.98	74	66.36	32.18	7.75	34.27	129	99	P	H	
		2390	52.03	-1.97	54	46.4	32.18	7.75	34.3	129	99	A	H	
	*	2412	108.27	-	-	102.62	32.2	7.75	34.3	129	99	P	H	
	*	2412	98.29	-	-	92.64	32.2	7.75	34.3	129	99	A	H	
													H	
													H	
			2389.83	66.89	-7.11	74	61.26	32.18	7.75	34.3	397	72	P	V
			2390	48.62	-5.38	54	42.99	32.18	7.75	34.3	397	72	A	V
	*		2412	105.82	-	-	100.17	32.2	7.75	34.3	397	72	P	V
	*		2412	95.14	-	-	89.49	32.2	7.75	34.3	397	72	A	V
													V	
													V	
802.11g CH 06 2437MHz		2363.1	59.63	-14.37	74	54.07	32.13	7.68	34.25	102	106	P	H	
		2376.42	45.41	-8.59	54	39.84	32.16	7.68	34.27	102	106	A	H	
	*	2437	110.6	-	-	104.88	32.24	7.83	34.35	102	106	P	H	
	*	2437	100.11	-	-	94.39	32.24	7.83	34.35	102	106	A	H	
			2485.48	61.57	-12.43	74	55.81	32.28	7.91	34.43	102	106	P	H
			2489.32	46.5	-7.5	54	40.72	32.3	7.91	34.43	102	106	A	H
			2340.78	58.48	-15.52	74	52.94	32.11	7.68	34.25	396	88	P	V
			2348.97	45.44	-8.56	54	39.9	32.11	7.68	34.25	396	88	A	V
	*		2437	107.39	-	-	101.67	32.24	7.83	34.35	396	88	P	V
	*		2437	97.41	-	-	91.69	32.24	7.83	34.35	396	88	A	V
			2486.72	59.08	-14.92	74	53.32	32.28	7.91	34.43	396	88	P	V
			2489.48	45.51	-8.49	54	39.73	32.3	7.91	34.43	396	88	A	V



802.11g CH 11 2462MHz	*	2462	108.08	-	-	102.3	32.26	7.91	34.39	100	96	P	H
	*	2462	96.76	-	-	90.98	32.26	7.91	34.39	100	96	A	H
		2483.6	73.41	-0.59	74	67.65	32.28	7.91	34.43	100	96	P	H
		2483.52	53.38	-0.62	54	47.62	32.28	7.91	34.43	100	96	A	H
													H
													H
	*	2462	104.15	-	-	98.37	32.26	7.91	34.39	384	68	P	V
	*	2462	93.12	-	-	87.34	32.26	7.91	34.39	384	68	A	V
		2483.56	70.71	-3.29	74	64.95	32.28	7.91	34.43	384	68	P	V
		2483.64	50.15	-3.85	54	44.39	32.28	7.91	34.43	384	68	A	V
													V
													V
Remark	1. No other spurious found. 2. All results are PASS against Peak and Average limit line.												



15C 2.4GHz 2400~2483.5MHz

WIFI 802.11g (Harmonic @ 3m)

WIFI	Note	Frequency	Level	Over	Limit	Read	Antenna	Cable	Preamp	Ant	Table	Peak	Pol.
Ant.				Limit	Line	Level	Factor	Loss	Factor	Pos	Pos	Avg.	
1		(MHz)	(dBμV/m)	(dB)	(dBμV/m)	(dBμV)	(dB/m)	(dB)	(dB)	(cm)	(deg)	(P/A)	(H/V)
802.11g CH 01 2412MHz		4824	52.77	-21.23	74	66.99	34.26	11.16	59.64	100	112	P	H
		4824	41.49	-12.51	54	55.71	34.26	11.16	59.64	100	112	A	H
													H
													H
		4824	49.06	-24.94	74	63.28	34.26	11.16	59.64	100	0	P	V
													V
													V
													V
802.11g CH 06 2437MHz		4872	55.97	-18.03	74	70.03	34.3	11.21	59.57	107	126	P	H
		4872	40.68	-13.32	54	54.74	34.3	11.21	59.57	107	126	A	H
		7308	43.61	-30.39	74	51.4	35.6	15.08	58.47	100	0	P	H
													H
		4872	49.17	-24.83	74	63.23	34.3	11.21	59.57	100	0	P	V
		7308	44.07	-29.93	74	51.86	35.6	15.08	58.47	100	0	P	V
													V
													V
802.11g CH 11 2462MHz		4926	44.4	-29.6	74	58.29	34.34	11.27	59.5	100	0	P	H
		7386	44.08	-29.92	74	51.92	35.6	15.14	58.58	100	0	P	H
													H
													H
		4926	44.21	-29.79	74	58.1	34.34	11.27	59.5	100	0	P	V
		7386	43.29	-30.71	74	51.13	35.6	15.14	58.58	100	0	P	V
													V
													V
Remark	1. No other spurious found. 2. All results are PASS against Peak and Average limit line.												



15C 2.4GHz 2400~2483.5MHz

WIFI 802.11n HT20 (Band Edge @ 3m)

WIFI	Note	Frequency	Level	Over	Limit	Read	Antenna	Cable	Preamp	Ant	Table	Peak	Pol.	
Ant.				Limit	Line	Level	Factor	Loss	Factor	Pos	Pos	Avg.		
1		(MHz)	(dBμV/m)	(dB)	(dBμV/m)	(dBμV)	(dB/m)	(dB)	(dB)	(cm)	(deg)	(P/A)	(H/V)	
802.11n HT20 CH 01 2412MHz		2389.74	72.77	-1.23	74	67.11	32.18	7.75	34.27	103	129	P	H	
		2389.92	52.92	-1.08	54	47.29	32.18	7.75	34.3	103	129	A	H	
	*	2412	107.68	-	-	102.03	32.2	7.75	34.3	103	129	P	H	
	*	2412	97.13	-	-	91.48	32.2	7.75	34.3	103	129	A	H	
													H	
														H
			2389.47	67.73	-6.27	74	62.07	32.18	7.75	34.27	396	64	P	V
			2390	50.4	-3.6	54	44.77	32.18	7.75	34.3	396	64	A	V
		*	2412	105.85	-	-	100.2	32.2	7.75	34.3	396	64	P	V
		*	2412	94.66	-	-	89.01	32.2	7.75	34.3	396	64	A	V
													V	
													V	
802.11n HT20 CH 06 2437MHz		2387.31	58.44	-15.56	74	52.78	32.18	7.75	34.27	102	121	P	H	
		2344.29	45.44	-8.56	54	39.9	32.11	7.68	34.25	102	121	A	H	
	*	2437	108.63	-	-	102.91	32.24	7.83	34.35	102	121	P	H	
	*	2437	98.49	-	-	92.77	32.24	7.83	34.35	102	121	A	H	
			2489.32	59.63	-14.37	74	53.85	32.3	7.91	34.43	102	121	P	H
			2488.56	46.51	-7.49	54	40.73	32.3	7.91	34.43	102	121	A	H
			2328.81	58.73	-15.27	74	53.26	32.09	7.6	34.22	396	86	P	V
			2333.31	45.28	-8.72	54	39.81	32.09	7.6	34.22	396	86	A	V
		*	2437	107.33	-	-	101.61	32.24	7.83	34.35	396	86	P	V
		*	2437	96.76	-	-	91.04	32.24	7.83	34.35	396	86	A	V
		2485.12	58.76	-15.24	74	53	32.28	7.91	34.43	396	86	P	V	
		2488.56	45.62	-8.38	54	39.84	32.3	7.91	34.43	396	86	A	V	



802.11n HT20 CH 11 2462MHz	*	2462	105.38	-	-	99.6	32.26	7.91	34.39	100	94	P	H
	*	2462	94.21	-	-	88.43	32.26	7.91	34.39	100	94	A	H
		2483.6	71.17	-2.83	74	65.41	32.28	7.91	34.43	100	94	P	H
		2483.64	50.41	-3.59	54	44.65	32.28	7.91	34.43	100	94	A	H
													H
													H
	*	2462	101.66	-	-	95.88	32.26	7.91	34.39	385	57	P	V
	*	2462	90.96	-	-	85.18	32.26	7.91	34.39	385	57	A	V
		2483.56	65.32	-8.68	74	59.56	32.28	7.91	34.43	385	57	P	V
		2483.56	47.6	-6.4	54	41.84	32.28	7.91	34.43	385	57	A	V
													V
													V
Remark	1. No other spurious found. 2. All results are PASS against Peak and Average limit line.												



15C 2.4GHz 2400~2483.5MHz

WIFI 802.11n HT20 (Harmonic @ 3m)

WIFI	Note	Frequency	Level	Over	Limit	Read	Antenna	Cable	Preamp	Ant	Table	Peak	Pol.
Ant.				Limit	Line	Level	Factor	Loss	Factor	Pos	Pos	Avg.	
1		(MHz)	(dBμV/m)	(dB)	(dBμV/m)	(dBμV)	(dB/m)	(dB)	(dB)	(cm)	(deg)	(P/A)	(H/V)
802.11n HT20 CH 01 2412MHz		4824	55.81	-18.19	74	70.03	34.26	11.16	59.64	100	233	P	H
		4824	39.05	-14.95	54	53.27	34.26	11.16	59.64	100	233	A	H
													H
													H
		4824	49.11	-24.89	74	63.33	34.26	11.16	59.64	100	0	P	V
													V
													V
802.11n HT20 CH 06 2437MHz		4872	55.19	-18.81	74	69.25	34.3	11.21	59.57	103	124	P	H
		4872	40.07	-13.93	54	54.13	34.3	11.21	59.57	103	124	A	H
		7308	44.31	-29.69	74	52.1	35.6	15.08	58.47	100	0	P	H
													H
		4872	48.66	-25.34	74	62.72	34.3	11.21	59.57	100	0	P	V
		7308	43.41	-30.59	74	51.2	35.6	15.08	58.47	100	0	P	V
													V
802.11n HT20 CH 11 2462MHz		4926	42.74	-31.26	74	56.63	34.34	11.27	59.5	100	0	P	H
		7386	43.11	-30.89	74	50.95	35.6	15.14	58.58	100	0	P	H
													H
													H
		4926	42.62	-31.38	74	56.51	34.34	11.27	59.5	100	0	P	V
		7386	43.33	-30.67	74	51.17	35.6	15.14	58.58	100	0	P	V
													V
Remark	1. No other spurious found.												
	2. All results are PASS against Peak and Average limit line.												



15C Emission below 1GHz

2.4GHz WIFI 802.11b (LF)

WIFI	Note	Frequency	Level	Over	Limit	Read	Antenna	Cable	Preamp	Ant	Table	Peak	Pol.	
Ant.				Limit	Line	Level	Factor	Loss	Factor	Pos	Pos	Avg.		
1		(MHz)	(dBμV/m)	(dB)	(dBμV/m)	(dBμV)	(dB/m)	(dB)	(dB)	(cm)	(deg)	(P/A)	(H/V)	
2.4GHz 802.11b LF		64.02	32.95	-7.05	40	56.11	6	2.06	31.22	109	323	P	H	
		191.46	16.06	-27.44	43.5	35.64	8.83	2.69	31.1			P	H	
		280.02	27.36	-18.64	46	42.3	12.8	3.16	30.9			P	H	
		421.8	23.49	-22.51	46	33.91	16.74	3.63	30.79			P	H	
		811.7	29.22	-16.78	46	32.66	22.26	4.62	30.32			P	H	
		955.2	31.51	-14.49	46	32.39	24.56	4.94	30.38			P	H	
														H
														H
														H
														H
														H
														H
														H
			81.57	32.92	-7.08	40	54.81	7.22	2.06	31.17	101	154	P	V
			172.83	23.54	-19.96	43.5	42.51	9.46	2.61	31.04			P	V
			259.5	23.91	-22.09	46	37.95	14	2.96	31			P	V
			413.4	26.23	-19.77	46	37.19	16.35	3.52	30.83			P	V
			730.5	26.64	-19.36	46	30.63	22	4.41	30.4			P	V
			951.7	32.88	-13.12	46	33.89	24.45	4.94	30.4			P	V
														V
													V	
													V	
													V	
													V	
													V	
Remark	1. No other spurious found. 2. All results are PASS against limit line.													



Note symbol

*	Fundamental Frequency which can be ignored. However, the level of any unwanted emissions shall not exceed the level of the fundamental frequency per 15.209(c).
!	Test result is over limit line.
P/A	Peak or Average
H/V	Horizontal or Vertical



A calculation example for radiated spurious emission is shown as below:

WIFI	Note	Frequency	Level	Over	Limit	Read	Antenna	Cable	Preamp	Ant	Table	Peak	Pol.
Ant.				Limit	Line	Level	Factor	Loss	Factor	Pos	Pos	Avg.	
1+2		(MHz)	(dBμV/m)	(dB)	(dBμV/m)	(dBμV)	(dB/m)	(dB)	(dB)	(cm)	(deg)	(P/A)	(H/V)
802.11b		2390	55.45	-18.55	74	54.51	32.22	4.58	35.86	103	308	P	H
CH 01		2390	43.54	-10.46	54	42.6	32.22	4.58	35.86	103	308	A	H
2412MHz													

- Level(dBμV/m) =
Antenna Factor(dB/m) + Cable Loss(dB) + Read Level(dBμV) - Preamp Factor(dB)
- Over Limit(dB) = Level(dBμV/m) – Limit Line(dBμV/m)

For Peak Limit @ 2390MHz:

- Level(dBμV/m)
= Antenna Factor(dB/m) + Cable Loss(dB) + Read Level(dBμV) - Preamp Factor(dB)
= 32.22(dB/m) + 4.58(dB) + 54.51(dBμV) – 35.86 (dB)
= 55.45 (dBμV/m)
- Over Limit(dB)
= Level(dBμV/m) – Limit Line(dBμV/m)
= 55.45(dBμV/m) – 74(dBμV/m)
= -18.55(dB)

For Average Limit @ 2390MHz:

- Level(dBμV/m)
= Antenna Factor(dB/m) + Cable Loss(dB) + Read Level(dBμV) - Preamp Factor(dB)
= 32.22(dB/m) + 4.58(dB) + 42.6(dBμV) – 35.86 (dB)
= 43.54 (dBμV/m)
- Over Limit(dB)
= Level(dBμV/m) – Limit Line(dBμV/m)
= 43.54(dBμV/m) – 54(dBμV/m)
= -10.46(dB)

Both peak and average measured complies with the limit line, so test result is “PASS”.