

# FCC SAR Test Report

APPLICANT : Motorola Mobility LLC  
EQUIPMENT : Cellular Mobile Phone  
BRAND NAME : Motorola  
MODEL NAME : 4107  
FCC ID : IHDT56QE3  
STANDARD : FCC 47 CFR Part 2 (2.1093)  
ANSI/IEEE C95.1-1992  
IEEE 1528-2003

We, SPORTON INTERNATIONAL INC., would like to declare that the tested sample has been evaluated in accordance with the procedures and had been in compliance with the applicable technical standards.

The test results in this report apply exclusively to the tested model / sample. Without written approval of SPORTON INTERNATIONAL INC., the test report shall not be reproduced except in full.

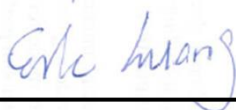

Reviewed by: Eric Huang / Deputy Manager



Approved by: Jones Tsai / Manager



## SPORTON INTERNATIONAL INC.

No. 52, Hwa Ya 1<sup>st</sup> Rd., Hwa Ya Technology Park, Kwei-Shan Hsiang, Tao Yuan Hsien, Taiwan, R.O.C.



**Table of Contents**

**1. Statement of Compliance ..... 4**

**2. Administration Data ..... 4**

**3. Guidance Standard ..... 5**

**4. Equipment Under Test (EUT) ..... 5**

    4.1 General Information ..... 5

    4.2 Maximum Tune-up Limit..... 6

**5. RF Exposure Limits..... 7**

    5.1 Uncontrolled Environment..... 7

    5.2 Controlled Environment..... 7

**6. Specific Absorption Rate (SAR)..... 8**

    6.1 Introduction ..... 8

    6.2 SAR Definition..... 8

**7. System Description and Setup ..... 9**

**8. Measurement Procedures .....10**

    8.1 Spatial Peak SAR Evaluation.....10

    8.2 Power Reference Measurement.....11

    8.3 Area Scan .....11

    8.4 Zoom Scan.....12

    8.5 Volume Scan Procedures.....12

    8.6 Power Drift Monitoring.....12

**9. Test Equipment List .....13**

**10. System Verification .....14**

    10.1 Tissue Verification .....14

    10.2 System Performance Check Results.....15

**11. RF Exposure Positions .....16**

    11.1 Ear and handset reference point .....16

    11.2 Definition of the cheek position.....17

    11.3 Definition of the tilt position.....18

    11.4 Body Worn Accessory .....19

    11.5 Wireless Router.....19

**12. Conducted RF Output Power (Unit: dBm).....20**

**13. Antenna Location .....25**

**14. SAR Test Results .....26**

    14.1 Head SAR .....26

    14.2 Hotspot SAR .....27

    14.3 Body Worn Accessory SAR.....28

    14.4 Repeated SAR Measurement .....28

**15. Simultaneous Transmission Analysis .....29**

    15.1 Head Exposure Conditions .....29

    15.2 Hotspot Exposure Conditions.....30

    15.3 Body-Worn Accessory Exposure Conditions .....30

    15.4 SPLSR Evaluation and Analysis.....31

**16. Uncertainty Assessment .....32**

**17. References .....34**

**Appendix A. Plots of System Performance Check**

**Appendix B. Plots of High SAR Measurement**

**Appendix C. DASYS Calibration Certificate**

**Appendix D. BT/WiFi Reference Report**



### Revision History

REPORT NO.	VERSION	DESCRIPTION	ISSUED DATE
FA4O1411-01	Rev. 01	Initial issue of report	Nov. 19, 2014
FA4O1411-01	Rev. 02	Update KDB 941225 D06 version of the report.	Dec. 09, 2014



1. Statement of Compliance

The maximum results of Specific Absorption Rate (SAR) found during testing for Motorola Mobility LLC, Cellular Mobile Phone, 4107, are as follows.

Table with columns: Equipment Class, Frequency Band, Highest SAR Summary (Head, Body-worn, Wireless Router), Highest Simultaneous Transmission. Includes data for PCE across GSM850, GSM1900, WCDMA Band V, and WCDMA Band II.

This device is in compliance with Specific Absorption Rate (SAR) for general population/uncontrolled exposure limits (1.6 W/kg) specified in FCC 47 CFR part 2 (2.1093) and ANSI/IEEE C95.1-1992, and had been tested in accordance with the measurement methods and procedures specified in IEEE 1528-2003.

2. Administration Data

Table for Testing Laboratory: Test Site (SPORTON INTERNATIONAL INC.), Test Site Location (No. 52, Hwa Ya 1st Rd., Hwa Ya Technology Park, Kwei-Shan Hsiang, Tao Yuan Hsien, Taiwan, R.O.C.).

Table for Applicant: Company Name (Motorola Mobility LLC), Address (222 W. Merchandise Mart Plaza, Suite 1800, Chicago IL. 60654, United States).

Table for Manufacturer: Company Name (Motorola Mobility LLC), Address (222 W. Merchandise Mart Plaza, Suite 1800, Chicago IL. 60654, United States).



### 3. Guidance Standard

The Specific Absorption Rate (SAR) testing specification, method, and procedure for this device is in accordance with the following standards:

- FCC 47 CFR Part 2 (2.1093)
- ANSI/IEEE C95.1-1992
- IEEE 1528-2003
- FCC KDB 865664 D01 SAR Measurement 100 MHz to 6 GHz v01r03
- FCC KDB 865664 D02 SAR Reporting v01r01
- FCC KDB 447498 D01 General RF Exposure Guidance v05r02
- FCC KDB 648474 D04 SAR Evaluation Considerations for Wireless Handsets v01r02
- FCC KDB 941225 D01 3G SAR Procedures v03
- FCC KDB 941225 D06 Hotspot Mode SAR v02

### 4. Equipment Under Test (EUT)

#### 4.1 General Information

Product Feature & Specification	
Equipment Name	Cellular Mobile Phone
Brand Name	Motorola
Model Name	4107
FCC ID	IHDT56QE3
IMEI Code	353310060006216
Wireless Technology and Frequency Range	GSM850: 824.2 MHz ~ 848.8 MHz GSM1900: 1850.2 MHz ~ 1909.8 MHz WCDMA Band V: 826.4 MHz ~ 846.6 MHz WCDMA Band II: 1852.4 MHz ~ 1907.6 MHz WLAN 2.4GHz Band: 2412 MHz ~ 2462 MHz Bluetooth: 2402 MHz ~ 2480 MHz
Mode	<ul style="list-style-type: none"> <li>• GSM/GPRS/EGPRS</li> <li>• RMC / AMR 12.2Kbps</li> <li>• HSDPA</li> <li>• HSUPA</li> <li>• DC-HSDPA</li> <li>• 802.11b/g/n HT20</li> <li>• Bluetooth v3.0+EDR , Bluetooth v4.0-LE</li> </ul>
GSM / (E)GPRS Transfer mode	Class B – EUT cannot support Packet Switched and Circuit Switched Network simultaneously but can automatically switch between Packet and Circuit Switched Network.
EUT Stage	Identical Prototype
<b>Remark:</b> <ol style="list-style-type: none"> <li>1. This device supported VoIP in EGPRS, WCDMA (e.g. 3rd party VoIP).</li> <li>2. The 2.4GHz WLAN and Bluetooth conducted power and SAR testing results were referred to Sporton FCC SAR Test Report, Brand Name: Motorola, Model Name: 4486, FCC ID: IHDT56QE2, Report No: FA4O1411 or Appendix D and also used perform transmission simultaneous analysis.</li> </ol>	



**4.2 Maximum Tune-up Limit**

Band	Burst average power (dBm)	
	GSM 850	GSM 1900
GSM (GMSK, 1 Tx slot)	33.50	31.00
GPRS/EDGE (GMSK, 1 Tx slot)	33.50	31.00
GPRS/EDGE (GMSK, 2 Tx slots)	31.50	29.00
GPRS/EDGE (GMSK, 3 Tx slots)	29.50	27.00
GPRS/EDGE (GMSK, 4 Tx slots)	27.50	25.00
EDGE (8PSK, 1 Tx slot)	27.50	26.50
EDGE (8PSK, 2 Tx slots)	24.50	23.50
EDGE (8PSK, 3 Tx slots)	22.70	21.70
EDGE (8PSK, 4 Tx slots)	21.50	20.50

Mode	Average Power (dBm)	
	WCDMA Band II	WCDMA Band V
AMR / RMC 12.2K	24.00	24.70
HSDPA Subtest-1	23.00	23.70
DC-HSDPA Subtest-1	23.00	23.70
HSUPA Subtest-5	23.00	23.70



**5. RF Exposure Limits**

**5.1 Uncontrolled Environment**

Uncontrolled Environments are defined as locations where there is the exposure of individuals who have no knowledge or control of their exposure. The general population/uncontrolled exposure limits are applicable to situations in which the general public may be exposed or in which persons who are exposed as a consequence of their employment may not be made fully aware of the potential for exposure or cannot exercise control over their exposure. Members of the general public would come under this category when exposure is not employment-related; for example, in the case of a wireless transmitter that exposes persons in its vicinity.

**5.2 Controlled Environment**

Controlled Environments are defined as locations where there is exposure that may be incurred by persons who are aware of the potential for exposure, (i.e. as a result of employment or occupation). In general, occupational/controlled exposure limits are applicable to situations in which persons are exposed as a consequence of their employment, who have been made fully aware of the potential for exposure and can exercise control over their exposure. The exposure category is also applicable when the exposure is of a transient nature due to incidental passage through a location where the exposure levels may be higher than the general population/uncontrolled limits, but the exposed person is fully aware of the potential for exposure and can exercise control over his or her exposure by leaving the area or by some other appropriate means.

**Limits for Occupational/Controlled Exposure (W/kg)**

Whole-Body	Partial-Body	Hands, Wrists, Feet and Ankles
0.4	8.0	20.0

**Limits for General Population/Uncontrolled Exposure (W/kg)**

Whole-Body	Partial-Body	Hands, Wrists, Feet and Ankles
0.08	1.6	4.0

1. Whole-Body SAR is averaged over the entire body, partial-body SAR is averaged over any 1gram of tissue defined as a tissue volume in the shape of a cube. SAR for hands, wrists, feet and ankles is averaged over any 10 grams of tissue defined as a tissue volume in the shape of a cube.

## **6. Specific Absorption Rate (SAR)**

### **6.1 Introduction**

SAR is related to the rate at which energy is absorbed per unit mass in an object exposed to a radio field. The SAR distribution in a biological body is complicated and is usually carried out by experimental techniques or numerical modeling. The standard recommends limits for two tiers of groups, occupational/controlled and general population/uncontrolled, based on a person's awareness and ability to exercise control over his or her exposure. In general, occupational/controlled exposure limits are higher than the limits for general population/uncontrolled.

### **6.2 SAR Definition**

The SAR definition is the time derivative (rate) of the incremental energy (dW) absorbed by (dissipated in) an incremental mass (dm) contained in a volume element (dv) of a given density ( $\rho$ ). The equation description is as below:

$$SAR = \frac{d}{dt} \left( \frac{dW}{dm} \right) = \frac{d}{dt} \left( \frac{dW}{\rho dv} \right)$$

SAR is expressed in units of Watts per kilogram (W/kg)

$$SAR = \frac{\sigma |E|^2}{\rho}$$

Where:  $\sigma$  is the conductivity of the tissue,  $\rho$  is the mass density of the tissue and E is the RMS electrical field strength.

## 7. System Description and Setup

The DASY system used for performing compliance tests consists of the following items:

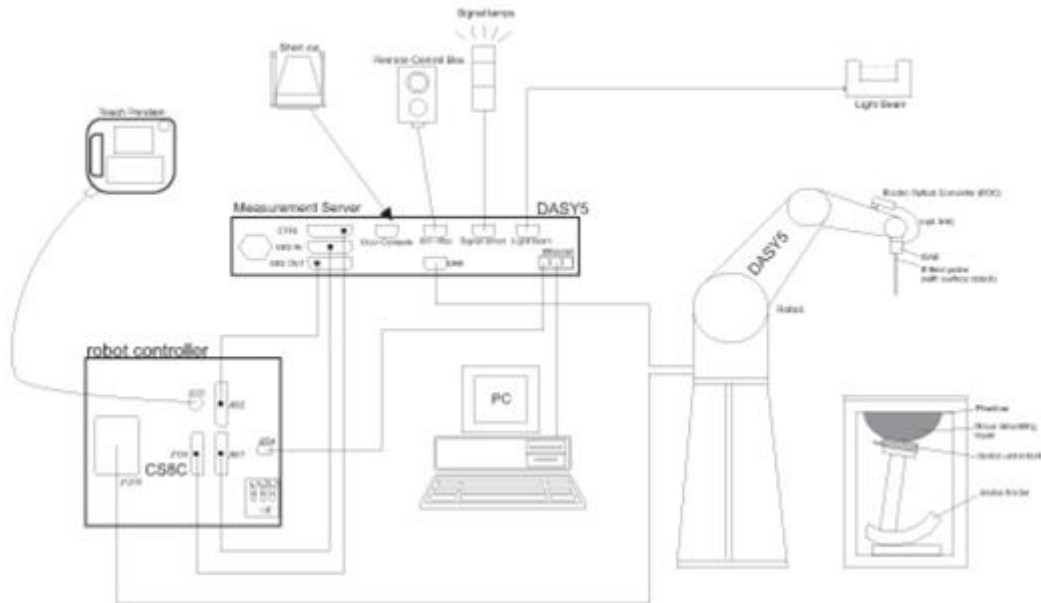

- A standard high precision 6-axis robot with controller, teach pendant and software. An arm extension for accommodating the data acquisition electronics (DAE).
- An isotropic Field probe optimized and calibrated for the targeted measurement.
- A data acquisition electronics (DAE) which performs the signal amplification, signal multiplexing, AD-conversion, offset measurements, mechanical surface detection, collision detection, etc. The unit is battery powered with standard or rechargeable batteries. The signal is optically transmitted to the EOC.
- The Electro-optical converter (EOC) performs the conversion from optical to electrical signals for the digital communication to the DAE. To use optical surface detection, a special version of the EOC is required. The EOC signal is transmitted to the measurement server.
- The function of the measurement server is to perform the time critical tasks such as signal filtering, control of the robot operation and fast movement interrupts.
- The Light Beam used is for probe alignment. This improves the (absolute) accuracy of the probe positioning.
- A computer running WinXP or Win7 and the DASY5 software.
- Remote control and teach pendant as well as additional circuitry for robot safety such as warning lamps, etc.
- The phantom, the device holder and other accessories according to the targeted measurement.

## **8. Measurement Procedures**

The measurement procedures are as follows:

### <Conducted power measurement>

- (a) For WWAN power measurement, use base station simulator to configure EUT WWAN transmission in conducted connection with RF cable, at maximum power in each supported wireless interface and frequency band.
- (b) Read the WWAN RF power level from the base station simulator.
- (c) For WLAN/BT power measurement, use engineering software to configure EUT WLAN/BT continuously transmission, at maximum RF power in each supported wireless interface and frequency band
- (d) Connect EUT RF port through RF cable to the power meter, and measure WLAN/BT output power

### <SAR measurement>

- (a) Use base station simulator to configure EUT WWAN transmission in radiated connection, and engineering software to configure EUT WLAN/BT continuously transmission, at maximum RF power, in the highest power channel.
- (b) Place the EUT in the positions as Appendix D demonstrates.
- (c) Set scan area, grid size and other setting on the DASY software.
- (d) Measure SAR results for the highest power channel on each testing position.
- (e) Find out the largest SAR result on these testing positions of each band
- (f) Measure SAR results for other channels in worst SAR testing position if the reported SAR of highest power channel is larger than 0.8 W/kg

According to the test standard, the recommended procedure for assessing the peak spatial-average SAR value consists of the following steps:

- (a) Power reference measurement
- (b) Area scan
- (c) Zoom scan
- (d) Power drift measurement

### **8.1 Spatial Peak SAR Evaluation**

The procedure for spatial peak SAR evaluation has been implemented according to the test standard. It can be conducted for 1g and 10g, as well as for user-specific masses. The DASY software includes all numerical procedures necessary to evaluate the spatial peak SAR value.

The base for the evaluation is a "cube" measurement. The measured volume must include the 1g and 10g cubes with the highest averaged SAR values. For that purpose, the center of the measured volume is aligned to the interpolated peak SAR value of a previously performed area scan.

The entire evaluation of the spatial peak values is performed within the post-processing engine (SEMCAD). The system always gives the maximum values for the 1g and 10g cubes. The algorithm to find the cube with highest averaged SAR is divided into the following stages:

- (a) Extraction of the measured data (grid and values) from the Zoom Scan
- (b) Calculation of the SAR value at every measurement point based on all stored data (A/D values and measurement parameters)
- (c) Generation of a high-resolution mesh within the measured volume
- (d) Interpolation of all measured values from the measurement grid to the high-resolution grid
- (e) Extrapolation of the entire 3-D field distribution to the phantom surface over the distance from sensor to surface
- (f) Calculation of the averaged SAR within masses of 1g and 10g

**8.2 Power Reference Measurement**

The Power Reference Measurement and Power Drift Measurements are for monitoring the power drift of the device under test in the batch process. The minimum distance of probe sensors to surface determines the closest measurement point to phantom surface. This distance cannot be smaller than the distance of sensor calibration points to probe tip as defined in the probe properties.

**8.3 Area Scan**

The area scan is used as a fast scan in two dimensions to find the area of high field values, before doing a fine measurement around the hot spot. The sophisticated interpolation routines implemented in DASY software can find the maximum found in the scanned area, within a range of the global maximum. The range (in dB0 is specified in the standards for compliance testing. For example, a 2 dB range is required in IEEE standard 1528 and IEC 62209 standards, whereby 3 dB is a requirement when compliance is assessed in accordance with the ARIB standard (Japan), if only one zoom scan follows the area scan, then only the absolute maximum will be taken as reference. For cases where multiple maximums are detected, the number of zoom scans has to be increased accordingly.

Area scan parameters extracted from FCC KDB 865664 D01v01r03 SAR measurement 100 MHz to 6 GHz.

	≤ 3 GHz	> 3 GHz
Maximum distance from closest measurement point (geometric center of probe sensors) to phantom surface	5 ± 1 mm	$\frac{1}{2} \cdot \delta \cdot \ln(2) \pm 0.5 \text{ mm}$
Maximum probe angle from probe axis to phantom surface normal at the measurement location	30° ± 1°	20° ± 1°
Maximum area scan spatial resolution: $\Delta x_{Area}, \Delta y_{Area}$	≤ 2 GHz: ≤ 15 mm 2 – 3 GHz: ≤ 12 mm	3 – 4 GHz: ≤ 12 mm 4 – 6 GHz: ≤ 10 mm
	When the x or y dimension of the test device, in the measurement plane orientation, is smaller than the above, the measurement resolution must be ≤ the corresponding x or y dimension of the test device with at least one measurement point on the test device.	

### 8.4 Zoom Scan

Zoom scans are used assess the peak spatial SAR values within a cubic averaging volume containing 1 gram and 10 gram of simulated tissue. The zoom scan measures points (refer to table below) within a cube shoes base faces are centered on the maxima found in a preceding area scan job within the same procedure. When the measurement is done, the zoom scan evaluates the averaged SAR for 1 gram and 10 gram and displays these values next to the job's label.

Zoom scan parameters extracted from FCC KDB 865664 D01v01r03 SAR measurement 100 MHz to 6 GHz.

		≤ 3 GHz	> 3 GHz	
Maximum zoom scan spatial resolution: $\Delta x_{Zoom}, \Delta y_{Zoom}$		$\leq 2$ GHz: $\leq 8$ mm 2 – 3 GHz: $\leq 5$ mm*	3 – 4 GHz: $\leq 5$ mm* 4 – 6 GHz: $\leq 4$ mm*	
Maximum zoom scan spatial resolution, normal to phantom surface	uniform grid: $\Delta z_{Zoom}(n)$	$\leq 5$ mm	3 – 4 GHz: $\leq 4$ mm 4 – 5 GHz: $\leq 3$ mm 5 – 6 GHz: $\leq 2$ mm	
	graded grid	$\Delta z_{Zoom}(1)$ : between 1 <sup>st</sup> two points closest to phantom surface	$\leq 4$ mm	3 – 4 GHz: $\leq 3$ mm 4 – 5 GHz: $\leq 2.5$ mm 5 – 6 GHz: $\leq 2$ mm
		$\Delta z_{Zoom}(n>1)$ : between subsequent points	$\leq 1.5 \cdot \Delta z_{Zoom}(n-1)$	
Minimum zoom scan volume	x, y, z	$\geq 30$ mm	3 – 4 GHz: $\geq 28$ mm 4 – 5 GHz: $\geq 25$ mm 5 – 6 GHz: $\geq 22$ mm	
Note: $\delta$ is the penetration depth of a plane-wave at normal incidence to the tissue medium; see draft standard IEEE P1528-2011 for details. * When zoom scan is required and the <i>reported</i> SAR from the <i>area scan based 1-g SAR estimation</i> procedures of KDB 447498 is $\leq 1.4$ W/kg, $\leq 8$ mm, $\leq 7$ mm and $\leq 5$ mm zoom scan resolution may be applied, respectively, for 2 GHz to 3 GHz, 3 GHz to 4 GHz and 4 GHz to 6 GHz.				

### 8.5 Volume Scan Procedures

The volume scan is used for assess overlapping SAR distributions for antennas transmitting in different frequency bands. It is equivalent to an oversized zoom scan used in standalone measurements. The measurement volume will be used to enclose all the simultaneous transmitting antennas. For antennas transmitting simultaneously in different frequency bands, the volume scan is measured separately in each frequency band. In order to sum correctly to compute the 1g aggregate SAR, the EUT remain in the same test position for all measurements and all volume scan use the same spatial resolution and grid spacing. When all volume scan were completed, the software, SEMCAD postprocessor can combine and subsequently superpose these measurement data to calculating the multiband SAR.

### 8.6 Power Drift Monitoring

All SAR testing is under the EUT install full charged battery and transmit maximum output power. In DASYS measurement software, the power reference measurement and power drift measurement procedures are used for monitoring the power drift of EUT during SAR test. Both these procedures measure the field at a specified reference position before and after the SAR testing. The software will calculate the field difference in dB. If the power drifts more than 5%, the SAR will be retested.



### 9. Test Equipment List

Manufacturer	Name of Equipment	Type/Model	Serial Number	Calibration	
				Last Cal.	Due Date
SPEAG	835MHz System Validation Kit	D835V2	4d162	Nov. 11, 2013	Nov. 10, 2014
SPEAG	1900MHz System Validation Kit	D1900V2	5d182	Nov. 12, 2013	Nov. 11, 2014
SPEAG	Data Acquisition Electronics	DAE3	577	Oct. 06, 2014	Oct. 05, 2015
SPEAG	Data Acquisition Electronics	DAE3	495	May. 19, 2014	May. 18, 2015
SPEAG	Data Acquisition Electronics	DAE4	1399	Nov. 07, 2013	Nov. 06, 2014
SPEAG	Dosimetric E-Field Probe	EX3DV4	3931	Sep. 25, 2014	Sep. 24, 2015
SPEAG	Dosimetric E-Field Probe	EX3DV4	3925	May. 22, 2014	May. 21, 2015
SPEAG	Dosimetric E-Field Probe	EX3DV4	3955	Nov. 12, 2013	Nov. 11, 2014
Wisewind	Thermometer	ETP-101	TM685	Oct. 21, 2014	Oct. 20, 2015
Wisewind	Thermometer	HTC-1	TM642	Oct. 21, 2014	Oct. 20, 2015
Wisewind	Thermometer	HTC-1	TM281	Oct. 21, 2014	Oct. 20, 2015
Anritsu	Radio Communication Analyzer	MT8820C	6201074414	Feb. 11, 2014	Feb. 10, 2015
SPEAG	Device Holder	N/A	N/A	NCR	NCR
R&S	Signal Generator	SMU200A	102502	Jul. 07, 2014	Jul. 06, 2015
SPEAG	Dielectric Probe Kit	DAKS-3.5	0004	Mar. 04, 2014	Mar. 03, 2015
Agilent	ENA Network Analyzer	E5071C	MY46101588	May. 31, 2014	May. 30, 2015
Anritsu	Power Meter	ML2495A	1036004	Aug. 09, 2014	Aug. 08, 2015
Anritsu	Power Sensor	MA2411B	1027253	Aug. 11, 2014	Aug. 10, 2015
R&S	Spectrum Analyzer	FSP 7	101131	Jul. 10, 2014	Jul. 09, 2015
Agilent	Dual Directional Coupler	778D	50422	Note1	
Woken	Attenuator 1	WK0602-XX	N/A	Note1	
PE	Attenuator 2	PE7005-10	N/A	Note1	
PE	Attenuator 3	PE7005- 3	N/A	Note1	
AR	Power Amplifier	5S1G4M2	0328767	Note1	
Mini-Circuits	Power Amplifier	ZVE-3W	162601250	Note1	
Mini-Circuits	Power Amplifier	ZHL-42W+	13440021344	Note1	

**General Note:**

1. Prior to system verification and validation, the path loss from the signal generator to the system check source and the power meter, which includes the amplifier, cable, attenuator and directional coupler, was measured by the network analyzer. The reading of the power meter was offset by the path loss difference between the path to the power meter and the path to the system check source to monitor the actual power level fed to the system check source.



## 10. System Verification

### 10.1 Tissue Verification

The following tissue formulations are provided for reference only as some of the parameters have not been thoroughly verified. The composition of ingredients may be modified accordingly to achieve the desired target tissue parameters required for routine SAR evaluation.

Frequency (MHz)	Water (%)	Sugar (%)	Cellulose (%)	Salt (%)	Preventol (%)	DGBE (%)	Conductivity ( $\sigma$ )	Permittivity ( $\epsilon_r$ )
<b>For Head</b>								
750	41.1	57.0	0.2	1.4	0.2	0	0.89	41.9
835	40.3	57.9	0.2	1.4	0.2	0	0.90	41.5
900	40.3	57.9	0.2	1.4	0.2	0	0.97	41.5
1800, 1900, 2000	55.2	0	0	0.3	0	44.5	1.40	40.0
2450	55.0	0	0	0	0	45.0	1.80	39.2
2600	54.8	0	0	0.1	0	45.1	1.96	39.0
<b>For Body</b>								
750	51.7	47.2	0	0.9	0.1	0	0.96	55.5
835	50.8	48.2	0	0.9	0.1	0	0.97	55.2
900	50.8	48.2	0	0.9	0.1	0	1.05	55.0
1800, 1900, 2000	70.2	0	0	0.4	0	29.4	1.52	53.3
2450	68.6	0	0	0	0	31.4	1.95	52.7
2600	68.1	0	0	0.1	0	31.8	2.16	52.5

#### Simulating Liquid for 5GHz, Manufactured by SPEAG

Ingredients	(% by weight)
Water	64~78%
Mineral oil	11~18%
Emulsifiers	9~15%
Additives and Salt	2~3%

#### <Tissue Dielectric Parameter Check Results>

Frequency (MHz)	Tissue Type	Liquid Temp. (°C)	Conductivity ( $\sigma$ )	Permittivity ( $\epsilon_r$ )	Conductivity Target ( $\sigma$ )	Permittivity Target ( $\epsilon_r$ )	Delta ( $\sigma$ ) (%)	Delta ( $\epsilon_r$ ) (%)	Limit (%)	Date
835	HSL	22.5	0.885	42.615	0.90	41.50	-1.67	2.69	±5	2014/10/27
835	HSL	22.3	0.921	41.254	0.90	41.50	2.33	-0.59	±5	2014/11/7
835	MSL	22.4	0.963	54.527	0.97	55.20	-0.72	-1.22	±5	2014/10/28
835	MSL	22.6	0.994	56.003	0.97	55.20	2.47	1.45	±5	2014/11/7
1900	HSL	22.6	1.432	39.198	1.40	40.00	2.29	-2.01	±5	2014/10/27
1900	HSL	22.3	1.446	38.797	1.40	40.00	3.29	-3.01	±5	2014/11/7
1900	MSL	22.5	1.553	53.818	1.52	53.30	2.17	0.97	±5	2014/10/28
1900	MSL	22.2	1.545	51.942	1.52	53.30	1.64	-2.55	±5	2014/11/6

**10.2 System Performance Check Results**

Comparing to the original SAR value provided by SPEAG, the verification data should be within its specification of 10 %. Below table shows the target SAR and measured SAR after normalized to 1W input power. The table below indicates the system performance check can meet the variation criterion and the plots can be referred to Appendix A of this report.

Date	Frequency (MHz)	Tissue Type	Input Power (mW)	Dipole S/N	Probe S/N	DAE S/N	Measured 1g SAR (W/kg)	Targeted 1g SAR (W/kg)	Normalized 1g SAR (W/kg)	Deviation (%)
2014/10/27	835	HSL	250	D835V2-4d162	EX3DV4 - SN3955	DAE4 Sn1399	2.41	9.53	9.64	1.15
2014/11/7	835	HSL	250	D835V2-4d162	EX3DV4 - SN3931	DAE3 Sn577	2.40	9.53	9.60	0.73
2014/10/28	835	MSL	250	D835V2-4d162	EX3DV4 - SN3955	DAE4 Sn1399	2.31	9.28	9.24	-0.43
2014/11/7	835	MSL	250	D835V2-4d162	EX3DV4 - SN3931	DAE3 Sn577	2.34	9.28	9.36	0.86
2014/10/27	1900	HSL	250	D1900V2-5d182	EX3DV4 - SN3955	DAE4 Sn1399	9.35	40.10	37.40	-6.73
2014/11/7	1900	HSL	250	D1900V2-5d182	EX3DV4 - SN3925	DAE3 Sn495	9.86	40.10	39.44	-1.65
2014/10/28	1900	MSL	250	D1900V2-5d182	EX3DV4 - SN3955	DAE4 Sn1399	9.97	39.50	39.88	0.96
2014/11/6	1900	MSL	250	D1900V2-5d182	EX3DV4 - SN3931	DAE3 Sn577	9.93	39.50	39.72	0.56

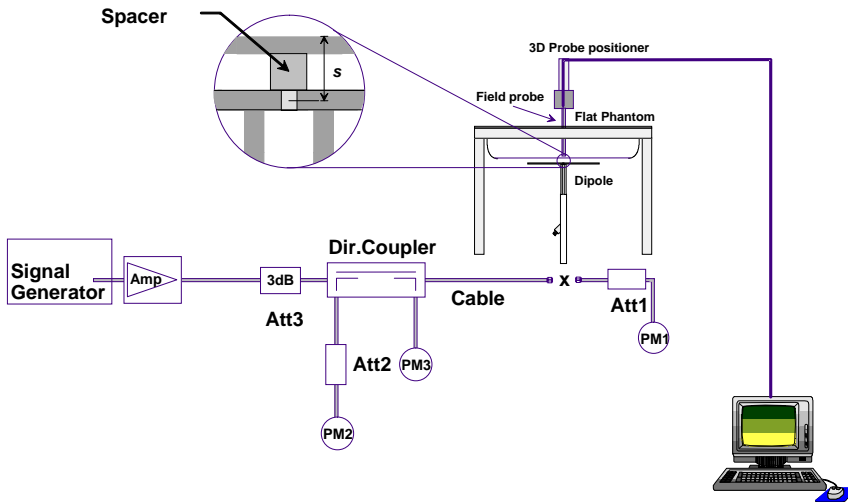

**Fig 8.3.1 System Performance Check Setup**



**Fig 8.3.2 Setup Photo**

## 11. RF Exposure Positions

### 11.1 Ear and handset reference point

Figure 9.1.1 shows the front, back, and side views of the SAM phantom. The center-of-mouth reference point is labeled "M," the left ear reference point (ERP) is marked "LE," and the right ERP is marked "RE." Each ERP is 15 mm along the B-M (back-mouth) line behind the entrance-to-ear-canal (EEC) point, as shown in Figure 9.1.2. The Reference Plane is defined as passing through the two ear reference points and point M. The line N-F (neck-front), also called the reference pivoting line, is normal to the Reference Plane and perpendicular to both a line passing through RE and LE and the B-M line (see Figure 9.1.3). Both N-F and B-M lines should be marked on the exterior of the phantom shell to facilitate handset positioning. Posterior to the N-F line the ear shape is a flat surface with 6 mm thickness at each ERP, and forward of the N-F line the ear is truncated, as illustrated in Figure 9.1.2. The ear truncation is introduced to preclude the ear lobe from interfering with handset tilt, which could lead to unstable positioning at the cheek.

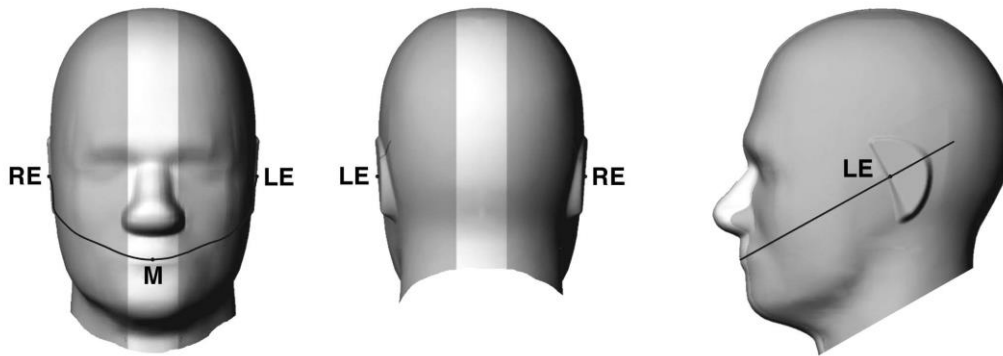

Fig 9.1.1 Front, back, and side views of SAM twin phantom

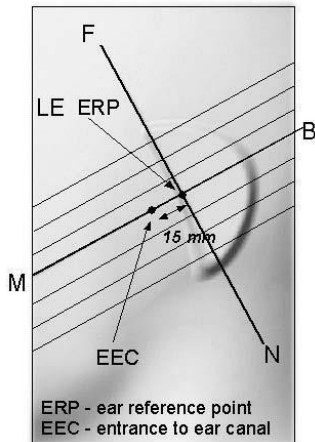

Fig 9.1.2 Close-up side view of phantom showing the ear region.

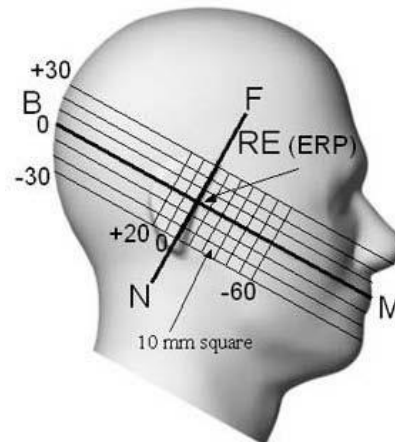

Fig 9.1.3 Side view of the phantom showing relevant markings and seven cross-sectional plane locations

### 11.2 Definition of the cheek position

1. Ready the handset for talk operation, if necessary. For example, for handsets with a cover piece (flip cover), open the cover. If the handset can transmit with the cover closed, both configurations must be tested.
2. Define two imaginary lines on the handset—the vertical centerline and the horizontal line. The vertical centerline passes through two points on the front side of the handset—the midpoint of the width  $w_t$  of the handset at the level of the acoustic output (point A in Figure 9.2.1 and Figure 9.2.2), and the midpoint of the width  $w_b$  of the bottom of the handset (point B). The horizontal line is perpendicular to the vertical centerline and passes through the center of the acoustic output (see Figure 9.2.1). The two lines intersect at point A. Note that for many handsets, point A coincides with the center of the acoustic output; however, the acoustic output may be located elsewhere on the horizontal line. Also note that the vertical centerline is not necessarily parallel to the front face of the handset (see Figure 9.2.2), especially for clamshell handsets, handsets with flip covers, and other irregularly-shaped handsets.
3. Position the handset close to the surface of the phantom such that point A is on the (virtual) extension of the line passing through points RE and LE on the phantom (see Figure 9.2.3), such that the plane defined by the vertical centerline and the horizontal line of the handset is approximately parallel to the sagittal plane of the phantom.
4. Translate the handset towards the phantom along the line passing through RE and LE until handset point A touches the pinna at the ERP.
5. While maintaining the handset in this plane, rotate it around the LE-RE line until the vertical centerline is in the plane normal to the plane containing B-M and N-F lines, i.e., the Reference Plane.
6. Rotate the handset around the vertical centerline until the handset (horizontal line) is parallel to the N-F line.
7. While maintaining the vertical centerline in the Reference Plane, keeping point A on the line passing through RE and LE, and maintaining the handset contact with the pinna, rotate the handset about the N-F line until any point on the handset is in contact with a phantom point below the pinna on the cheek. See Figure 9.2.3. The actual rotation angles should be documented in the test report.

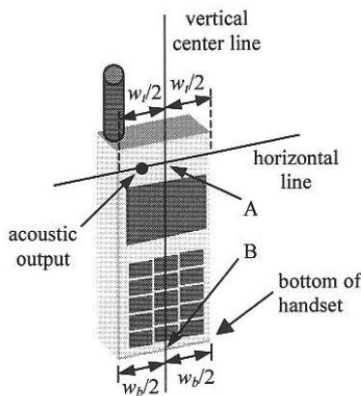

Fig 9.2.1 Handset vertical and horizontal reference lines—“fixed case”

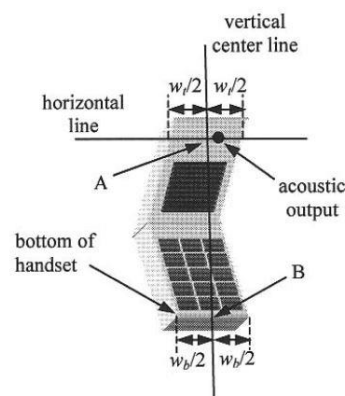

Fig 9.2.2 Handset vertical and horizontal reference lines—“clam-shell case”

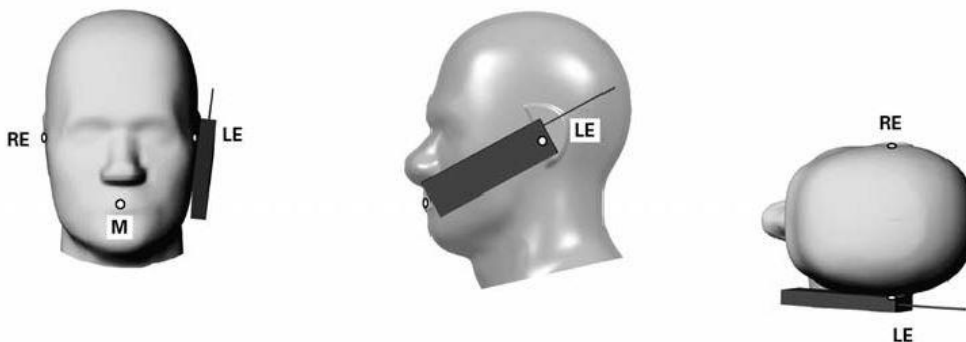
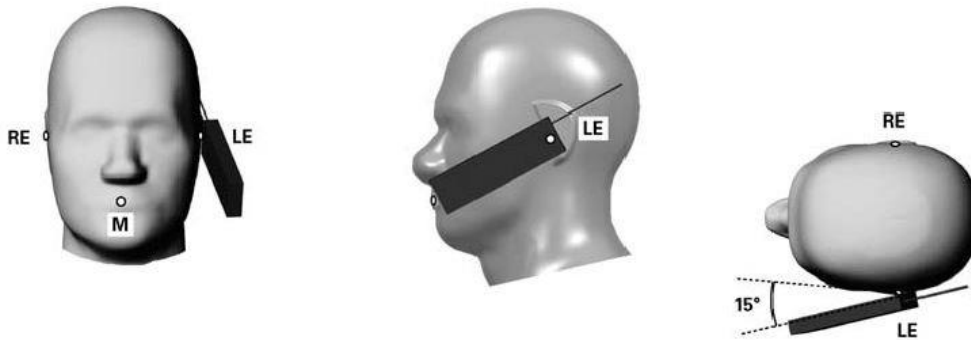

Fig 9.2.3 cheek or touch position. The reference points for the right ear (RE), left ear (LE), and mouth (M), which establish the Reference Plane for handset positioning, are indicated.

**11.3 Definition of the tilt position**

1. Ready the handset for talk operation, if necessary. For example, for handsets with a cover piece (flip cover), open the cover. If the handset can transmit with the cover closed, both configurations must be tested.
2. While maintaining the orientation of the handset, move the handset away from the pinna along the line passing through RE and LE far enough to allow a rotation of the handset away from the cheek by 15°.
3. Rotate the handset around the horizontal line by 15°.
4. While maintaining the orientation of the handset, move the handset towards the phantom on the line passing through RE and LE until any part of the handset touches the ear. The tilt position is obtained when the contact point is on the pinna. See Figure 9.3.1. If contact occurs at any location other than the pinna, e.g., the antenna at the back of the phantom head, the angle of the handset should be reduced. In this case, the tilt position is obtained if any point on the handset is in contact with the pinna and a second point

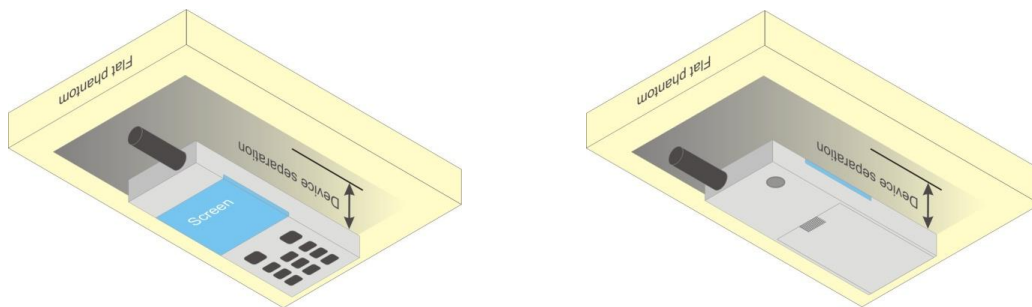

**Fig 9.3.1 Tilt position. The reference points for the right ear (RE), left ear (LE), and mouth (M), which define the Reference Plane for handset positioning, are indicated.**

**11.4 Body Worn Accessory**

Body-worn operating configurations are tested with the belt-clips and holsters attached to the device and positioned against a flat phantom in a normal use configuration (see Figure 9.4). Per KDB 648474 D04v01r02, body-worn accessory exposure is typically related to voice mode operations when handsets are carried in body-worn accessories. The body-worn accessory procedures in FCC KDB 447498 D01v05r02 should be used to test for body-worn accessory SAR compliance, without a headset connected to it. This enables the test results for such configuration to be compatible with that required for hotspot mode when the body-worn accessory test separation distance is greater than or equal to that required for hotspot mode, when applicable. When the reported SAR for body-worn accessory, measured without a headset connected to the handset is < 1.2 W/kg, the highest reported SAR configuration for that wireless mode and frequency band should be repeated for that body-worn accessory with a headset attached to the handset.

Accessories for body-worn operation configurations are divided into two categories: those that do not contain metallic components and those that do contain metallic components. When multiple accessories that do not contain metallic components are supplied with the device, the device is tested with only the accessory that dictates the closest spacing to the body. Then multiple accessories that contain metallic components are test with the device with each accessory. If multiple accessories share an identical metallic component (i.e. the same metallic belt-clip used with different holsters with no other metallic components) only the accessory that dictates the closest spacing to the body is tested.



**Fig 9.4 Body Worn Position**

**11.5 Wireless Router**

Some battery-operated handsets have the capability to transmit and receive user through simultaneous transmission of WIFI simultaneously with a separate licensed transmitter. The FCC has provided guidance in FCC HDB Publication 941225 D06 v02 where SAR test considerations for handsets (L x W ≥ 9 cm x 5 cm) are based on a composite test separation distance of 10mm from the front, back and edges of the device containing transmitting antennas within 2.5cm of their edges, determined from general mixed use conditions for this type of devices. Since the hotspot SAR results may overlap with the body-worn accessory SAR requirements, the more conservative configurations can be considered, thus excluding some body-worn accessory SAR tests.

When the user enables the personal wireless router functions for the handset, actual operations include simultaneous transmission of both the WIFI transmitter and another licensed transmitter. Both transmitters often do not transmit at the same transmitting frequency and thus cannot be evaluated for SAR under actual use conditions due to the limitations of the SAR assessment probes. Therefore, SAR must be evaluated for each frequency transmission and mode separately and spatially summed with the WIFI transmitter according to FCC KDB Publication 447498 D01v05r02 publication procedures. The “Portable Hotspot” feature on the handset was NOT activated during SAR assessments, to ensure the SAR measurements were evaluated for a single transmission frequency RF signal at a time.



**12. Conducted RF Output Power (Unit: dBm)**

**<GSM Conducted Power>**

**General Note:**

1. Per KDB 447498 D01v05r02, the maximum output power channel is used for SAR testing and for further SAR test reduction.
2. Per KDB 941225 D01v03, considering the possibility of e.g. 3rd party VoIP operation for Head and body-worn SAR test reduction for GSM and GPRS and EDGE modes is determined by the source-based time-averaged output power including tune-up tolerance. The mode with highest specified time-averaged output power should be tested for SAR compliance in the applicable exposure conditions. For modes with the same specified maximum output power and tolerance, the higher number time-slot configuration should be tested. Therefore, the EUT was set in GPRS (2Tx slots) for GSM850/GSM1900.
3. Per KDB 941225 D01v03, for Hotspot SAR test reduction for GPRS and EDGE modes is determined by the source-based time-averaged output power including tune-up tolerance, for modes with the same specified maximum output power and tolerance, the higher number time-slot configuration should be tested, therefore, the EUT was set in GPRS (2Tx slots) for GSM850/GSM1900.

Band GSM850	Burst Average Power (dBm)			Tune-up Limit (dBm)	Frame-Average Power (dBm)			Tune-up Limit (dBm)
	TX Channel	128	189		251	128	189	
Frequency (MHz)	824.2	836.4	848.8		824.2	836.4	848.8	
GSM (GMSK, 1 Tx slot)	32.84	32.81	32.66	33.50	23.84	23.81	23.66	24.50
GPRS (GMSK, 1 Tx slot)	32.98	32.91	32.77	33.50	23.98	23.91	23.77	24.50
GPRS (GMSK, 2 Tx slots)	30.48	30.35	30.23	31.50	24.48	24.35	24.23	25.50
GPRS (GMSK, 3 Tx slots)	28.16	27.99	27.94	29.50	23.90	23.73	23.68	25.24
GPRS (GMSK, 4 Tx slots)	26.54	26.46	26.33	27.50	23.54	23.46	23.33	24.50
EDGE (8PSK, 1 Tx slot)	26.73	26.71	26.62	27.50	17.73	17.71	17.62	18.50
EDGE (8PSK, 2 Tx slots)	24.49	24.38	24.42	24.50	18.49	18.38	18.42	18.50
EDGE (8PSK, 3 Tx slots)	22.56	22.40	22.34	22.70	18.30	18.14	18.08	18.44
EDGE (8PSK, 4 Tx slots)	21.09	20.98	20.89	21.50	18.09	17.98	17.89	18.50

Band GSM1900	Burst Average Power (dBm)			Tune-up Limit (dBm)	Frame-Average Power (dBm)			Tune-up Limit (dBm)
	TX Channel	512	661		810	512	661	
Frequency (MHz)	1850.2	1880	1909.8		1850.2	1880	1909.8	
GSM (GMSK, 1 Tx slot)	29.79	29.76	29.65	31.00	20.79	20.76	20.65	22.00
GPRS (GMSK, 1 Tx slot)	29.88	29.82	29.69	31.00	20.88	20.82	20.69	22.00
GPRS (GMSK, 2 Tx slots)	27.85	27.82	27.87	29.00	21.85	21.82	21.87	23.00
GPRS (GMSK, 3 Tx slots)	25.78	25.87	25.88	27.00	21.52	21.61	21.62	22.74
GPRS (GMSK, 4 Tx slots)	23.72	23.78	23.90	25.00	20.72	20.78	20.90	22.00
EDGE (8PSK, 1 Tx slot)	25.69	25.73	25.76	26.50	16.69	16.73	16.76	17.50
EDGE (8PSK, 2 Tx slots)	23.37	23.43	23.47	23.50	17.37	17.43	17.47	17.50
EDGE (8PSK, 3 Tx slots)	21.56	21.57	21.64	21.70	17.30	17.31	17.38	17.44
EDGE (8PSK, 4 Tx slots)	20.15	20.22	20.32	20.50	17.15	17.22	17.32	17.50

**<WCDMA Conducted Power>**

1. The following tests were conducted according to the test requirements outlines in 3GPP TS 34.121 specification.
2. The procedures in KDB 941225 D01 are applied for 3GPP Rel. 6 HSPA to configure the device in the required sub-test mode(s) to determine SAR test exclusion.
3. For DC-HSDPA, the device was configured according to the H-Set 12, Fixed Reference Channel (FRC) configuration in Table C.8.1.12 of 3GPP TS 34.121-1, with the primary and the secondary serving HS-DSCH Cell enabled during the power measurement.

A summary of these settings are illustrated below:

**HSDPA Setup Configuration:**

- a. The EUT was connected to Base Station Agilent E5515C referred to the Setup Configuration.
- b. The RF path losses were compensated into the measurements.
- c. A call was established between EUT and Base Station with following setting:
  - i. Set Gain Factors ( $\beta_c$  and  $\beta_d$ ) and parameters were set according to each
  - ii. Specific sub-test in the following table, C10.1.4, quoted from the TS 34.121
  - iii. Set RMC 12.2Kbps + HSDPA mode.
  - iv. Set Cell Power = -86 dBm
  - v. Set HS-DSCH Configuration Type to FRC (H-set 1, QPSK)
  - vi. Select HSDPA Uplink Parameters
  - vii. Set Delta ACK, Delta NACK and Delta CQI = 8
  - viii. Set Ack-Nack Repetition Factor to 3
  - ix. Set CQI Feedback Cycle (k) to 4 ms
  - x. Set CQI Repetition Factor to 2
  - xi. Power Ctrl Mode = All Up bits
- d. The transmitted maximum output power was recorded.

**Table C.10.1.4:  $\beta$  values for transmitter characteristics tests with HS-DPCCH**

Sub-test	$\beta_c$	$\beta_d$	$\beta_d$ (SF)	$\beta_c/\beta_d$	$\beta_{HS}$ (Note 1, Note 2)	CM (dB) (Note 3)	MPR (dB) (Note 3)
1	2/15	15/15	64	2/15	4/15	0.0	0.0
2	12/15 (Note 4)	15/15 (Note 4)	64	12/15 (Note 4)	24/15	1.0	0.0
3	15/15	8/15	64	15/8	30/15	1.5	0.5
4	15/15	4/15	64	15/4	30/15	1.5	0.5

Note 1:  $\Delta_{ACK}, \Delta_{NACK}$  and  $\Delta_{CQI} = 30/15$  with  $\beta_{HS} = 30/15 * \beta_c$ .

Note 2: For the HS-DPCCH power mask requirement test in clause 5.2C, 5.7A, and the Error Vector Magnitude (EVM) with HS-DPCCH test in clause 5.13.1A, and HSDPA EVM with phase discontinuity in clause 5.13.1AA,  $\Delta_{ACK}$  and  $\Delta_{NACK} = 30/15$  with  $\beta_{HS} = 30/15 * \beta_c$ , and  $\Delta_{CQI} = 24/15$  with  $\beta_{HS} = 24/15 * \beta_c$ .

Note 3: CM = 1 for  $\beta_c/\beta_d = 12/15, \beta_{HS}/\beta_c = 24/15$ . For all other combinations of DPCCH, DPDCCH and HS-DPCCH the MPR is based on the relative CM difference. This is applicable for only UEs that support HSDPA in release 6 and later releases.

Note 4: For subtest 2 the  $\beta_c/\beta_d$  ratio of 12/15 for the TFC during the measurement period (TF1, TF0) is achieved by setting the signalled gain factors for the reference TFC (TF1, TF1) to  $\beta_c = 11/15$  and  $\beta_d = 15/15$ .

**Setup Configuration**

**HSUPA Setup Configuration:**

- a. The EUT was connected to Base Station Agilent E5515C referred to the Setup Configuration.
- b. The RF path losses were compensated into the measurements.
- c. A call was established between EUT and Base Station with following setting \* :
  - i. Call Configs = 5.2B, 5.9B, 5.10B, and 5.13.2B with QPSK
  - ii. Set the Gain Factors ( $\beta_c$  and  $\beta_d$ ) and parameters (AG Index) were set according to each specific sub-test in the following table, C11.1.3, quoted from the TS 34.121
  - iii. Set Cell Power = -86 dBm
  - iv. Set Channel Type = 12.2k + HSPA
  - v. Set UE Target Power
  - vi. Power Ctrl Mode= Alternating bits
  - vii. Set and observe the E-TFCl
  - viii. Confirm that E-TFCl is equal to the target E-TFCl of 75 for sub-test 1, and other subtest's E-TFCl
- d. The transmitted maximum output power was recorded.

**Table C.11.1.3:  $\beta$  values for transmitter characteristics tests with HS-DPCCH and E-DCH**

Sub-test	$\beta_c$	$\beta_d$	$\beta_d$ (SF)	$\beta_c/\beta_d$	$\beta_{HS}$ (Note 1)	$\beta_{ec}$	$\beta_{ed}$ (Note 5) (Note 6)	$\beta_{ed}$ (SF)	$\beta_{ed}$ (Codes)	CM (dB) (Note 2)	MPR (dB) (Note 2)	AG Index (Note 6)	E-TFCl
1	11/15 (Note 3)	15/15 (Note 3)	64	11/15 (Note 3)	22/15	209/25	1309/225	4	1	1.0	0.0	20	75
2	6/15	15/15	64	6/15	12/15	12/15	94/75	4	1	3.0	2.0	12	67
3	15/15	9/15	64	15/9	30/15	30/15	$\beta_{ed1}: 47/15$ $\beta_{ed2}: 47/15$	4 4	2	2.0	1.0	15	92
4	2/15	15/15	64	2/15	4/15	2/15	56/75	4	1	3.0	2.0	17	71
5	15/15 (Note 4)	15/15 (Note 4)	64	15/15 (Note 4)	30/15	24/15	134/15	4	1	1.0	0.0	21	81

Note 1:  $\Delta_{ACK}, \Delta_{NACK}$  and  $\Delta_{CQI} = 30/15$  with  $\beta_{hs} = 30/15 * \beta_c$ .

Note 2: CM = 1 for  $\beta_c/\beta_d = 12/15, \beta_{hs}/\beta_c = 24/15$ . For all other combinations of DPDCH, DPCCH, HS- DPCCH, E-DPDCH and E-DPCCH the MPR is based on the relative CM difference.

Note 3: For subtest 1 the  $\beta_c/\beta_d$  ratio of 11/15 for the TFC during the measurement period (TF1, TF0) is achieved by setting the signalled gain factors for the reference TFC (TF1, TF1) to  $\beta_c = 10/15$  and  $\beta_d = 15/15$ .

Note 4: For subtest 5 the  $\beta_c/\beta_d$  ratio of 15/15 for the TFC during the measurement period (TF1, TF0) is achieved by setting the signalled gain factors for the reference TFC (TF1, TF1) to  $\beta_c = 14/15$  and  $\beta_d = 15/15$ .

Note 5: In case of testing by UE using E-DPDCH Physical Layer category 1, Sub-test 3 is omitted according to TS25.306 Table 5.1g.

Note 6:  $\beta_{ed}$  can not be set directly, it is set by Absolute Grant Value.

**Setup Configuration**

**DC-HSDPA 3GPP release 8 Setup Configuration:**

- a. The EUT was connected to Base Station Agilent E5515C referred to the Setup Configuration below
- b. The RF path losses were compensated into the measurements.
- c. A call was established between EUT and Base Station with following setting:
  - i. Set RMC 12.2Kbps + HSDPA mode.
  - ii. Set Cell Power = -25 dBm
  - iii. Set HS-DSCH Configuration Type to FRC (H-set 12, QPSK)
  - iv. Select HSDPA Uplink Parameters
  - v. Set Gain Factors ( $\beta_c$  and  $\beta_d$ ) and parameters were set according to each Specific sub-test in the following table, C10.1.4, quoted from the TS 34.121
    - a). Subtest 1:  $\beta_c/\beta_d=2/15$
    - b). Subtest 2:  $\beta_c/\beta_d=12/15$
    - c). Subtest 3:  $\beta_c/\beta_d=15/8$
    - d). Subtest 4:  $\beta_c/\beta_d=15/4$
  - vi. Set Delta ACK, Delta NACK and Delta CQI = 8
  - vii. Set Ack-Nack Repetition Factor to 3
  - viii. Set CQI Feedback Cycle (k) to 4 ms
  - ix. Set CQI Repetition Factor to 2
  - x. Power Ctrl Mode = All Up bits
- d. The transmitted maximum output power was recorded.

The following tests were conducted according to the test requirements outlines in 3GPP TS 34.121 specification. A summary of these settings are illustrated below:

**C.8.1.12 Fixed Reference Channel Definition H-Set 12**

**Table C.8.1.12: Fixed Reference Channel H-Set 12**

Parameter	Unit	Value
Nominal Avg. Inf. Bit Rate	kbps	60
Inter-TTI Distance	TTI's	1
Number of HARQ Processes	Processes	6
Information Bit Payload ( $N_{INF}$ )	Bits	120
Number Code Blocks	Blocks	1
Binary Channel Bits Per TTI	Bits	960
Total Available SML's in UE	SML's	19200
Number of SML's per HARQ Proc.	SML's	3200
Coding Rate		0.15
Number of Physical Channel Codes	Codes	1
Modulation		QPSK
Note 1: The RMC is intended to be used for DC-HSDPA mode and both cells shall transmit with identical parameters as listed in the table. Note 2: Maximum number of transmission is limited to 1, i.e., retransmission is not allowed. The redundancy and constellation version 0 shall be used.		

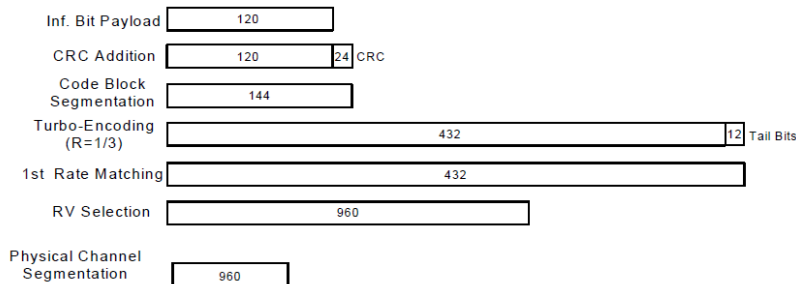

**Figure C.8.19: Coding rate for Fixed reference Channel H-Set 12 (QPSK)**

**Setup Configuration**



**<WCDMA Conducted Power>**

**General Note:**

1. Per KDB 941225 D01v03, SAR for Head / Hotspot / Body-worn exposure is measured using a 12.2 kbps RMC with TPC bits configured to all "1's".
2. Per KDB 941225 D01v03, RMC 12.2kbps setting is used to evaluate SAR. If the maximum output power and tune-up tolerance specified for production units in HSDPA / HSUPA / DC-HSDPA is  $\leq \frac{1}{4}$  dB higher than RMC 12.2Kbps or when the highest reported SAR of the RMC12.2Kbps is scaled by the ratio of specified maximum output power and tune-up tolerance of HSDPA / HSUPA / DC-HSDPA to RMC12.2Kbps and the adjusted SAR is  $\leq 1.2$  W/kg, SAR measurement is not required for HSDPA / HSUPA / DC-HSDPA.

Band			WCDMA V			WCDMA II		
TX Channel			4132	4182	4233	9262	9400	9538
Frequency (MHz)			826.4	836.4	846.6	1852.4	1880	1907.6
MPR (dB)	3GPP Rel 99	AMR 12.2Kbps	23.81	23.77	23.71	22.72	22.68	22.74
		RMC 12.2Kbps	23.84	23.83	23.78	22.74	22.71	22.81
0	3GPP Rel 6	HSDPA Subtest-1	22.74	22.88	22.83	21.83	21.98	22.11
0	3GPP Rel 6	HSDPA Subtest-2	22.78	22.86	22.88	21.89	21.95	22.17
0.5	3GPP Rel 6	HSDPA Subtest-3	22.38	22.40	22.38	21.40	21.38	21.67
0.5	3GPP Rel 6	HSDPA Subtest-4	22.37	22.45	22.31	21.40	21.52	21.67
0	3GPP Rel 8	DC-HSDPA Subtest-1	22.73	22.87	22.82	21.81	21.96	22.10
0	3GPP Rel 8	DC-HSDPA Subtest-2	22.76	22.85	22.86	21.85	21.94	22.13
0.5	3GPP Rel 8	DC-HSDPA Subtest-3	22.36	22.39	22.36	21.39	21.37	21.64
0.5	3GPP Rel 8	DC-HSDPA Subtest-4	22.35	22.43	22.29	21.36	21.50	21.62
0	3GPP Rel 6	HSUPA Subtest-1	22.57	22.47	22.93	21.83	21.99	21.56
2	3GPP Rel 6	HSUPA Subtest-2	21.42	21.69	21.70	20.30	20.75	20.36
1	3GPP Rel 6	HSUPA Subtest-3	21.90	21.73	21.40	20.36	20.42	20.86
2	3GPP Rel 6	HSUPA Subtest-4	21.66	21.63	21.67	20.93	20.66	21.00
0	3GPP Rel 6	HSUPA Subtest-5	23.00	22.70	22.70	21.80	21.90	22.00

### 13. Antenna Location

<Mobile Phone>

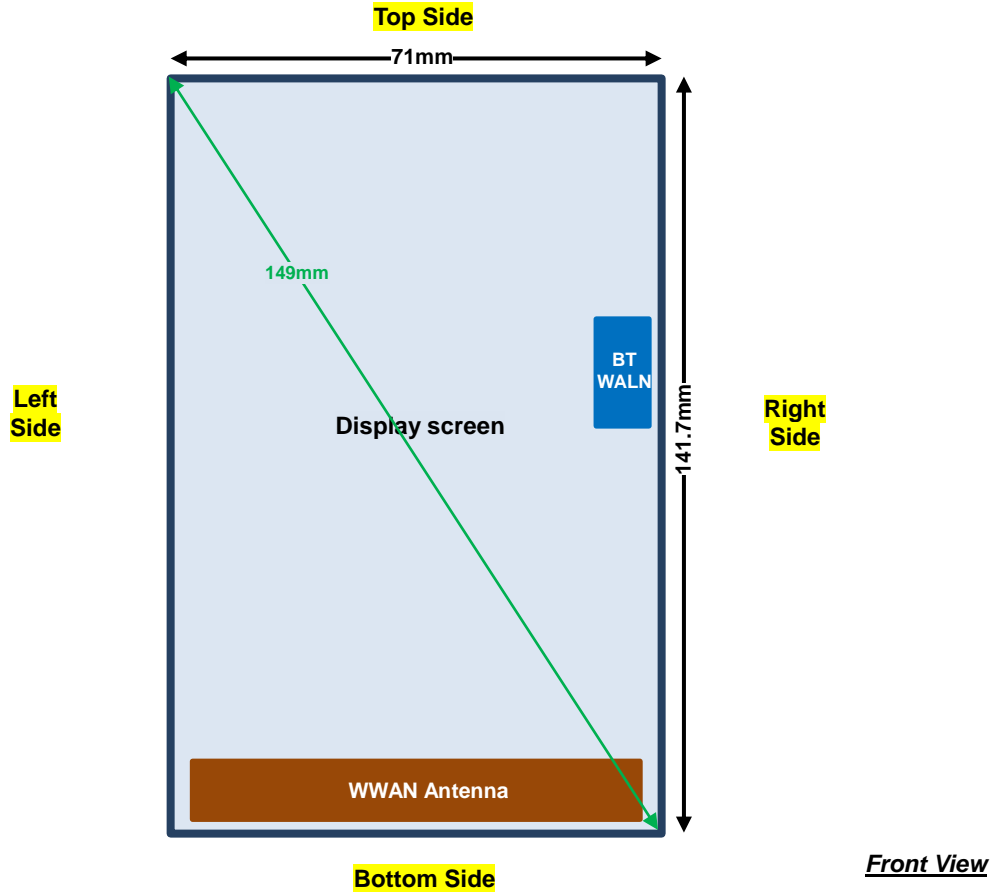

Distance of the Antenna to the EUT surface/edge						
Antennas	Back	Front	Top Side	Bottom Side	Right Side	Left Side
WWAN	≤ 25mm	≤ 25mm	> 25mm	≤ 25mm	≤ 25mm	≤ 25mm
Positions for SAR tests; Hotspot mode						
Antennas	Back	Front	Top Side	Bottom Side	Right Side	Left Side
WWAN	Yes	Yes	No	Yes	Yes	Yes

**General Note:**

- Referring to KDB 941225 D06 v02, when the overall device length and width are ≥ 9cm\*5cm, the test distance is 10 mm. SAR must be measured for all sides and surfaces with a transmitting antenna located within 25mm from that surface or edge.



## 14. SAR Test Results

### General Note:

1. Per KDB 447498 D01v05r02, the reported SAR is the measured SAR value adjusted for maximum tune-up tolerance.
  - a. Tune-up scaling Factor = tune-up limit power (mW) / EUT RF power (mW), where tune-up limit is the maximum rated power among all production units.
  - b. For WWAN: Reported SAR(W/kg)= Measured SAR(W/kg)\*Tune-up Scaling Factor
2. Per KDB 447498 D01v05r02, for each exposure position, testing of other required channels within the operating mode of a frequency band is not required when the *reported* 1-g or 10-g SAR for the mid-band or highest output power channel is:
  - $\leq 0.8$  W/kg or  $2.0$  W/kg, for 1-g or 10-g respectively, when the transmission band is  $\leq 100$  MHz
  - $\leq 0.6$  W/kg or  $1.5$  W/kg, for 1-g or 10-g respectively, when the transmission band is between  $100$  MHz and  $200$  MHz
  - $\leq 0.4$  W/kg or  $1.0$  W/kg, for 1-g or 10-g respectively, when the transmission band is  $\geq 200$  MHz
3. Per KDB 941225 D01v03, considering the possibility of e.g. 3rd party VoIP operation for Head and body-worn SAR test reduction for GSM and GPRS and EDGE modes is determined by the source-based time-averaged output power including tune-up tolerance. The mode with highest specified time-averaged output power should be tested for SAR compliance in the applicable exposure conditions. For modes with the same specified maximum output power and tolerance, the higher number time-slot configuration should be tested. Therefore, the EUT was set in GPRS (2Tx slots) for GSM850/GSM1900.
4. Per KDB 941225 D01v03, for Hotspot SAR test reduction for GPRS and EDGE modes is determined by the source-based time-averaged output power including tune-up tolerance, for modes with the same specified maximum output power and tolerance, the higher number time-slot configuration should be tested, therefore, the EUT was set in GPRS (2Tx slots) for GSM850/GSM1900.
5. Per KDB 941225 D01v03, SAR for next to the ear head / Hotspot / Body-worn exposure is measured using a 12.2 kbps RMC with TPC bits configured to all "1's".
6. Per KDB 941225 D01v03, RMC 12.2kbps setting is used to evaluate SAR. If the maximum output power and tune-up tolerance specified for production units in HSDPA / HSUPA / DC-HSDPA is  $\leq \frac{1}{4}$  dB higher than RMC 12.2Kbps or when the highest reported SAR of the RMC12.2Kbps is scaled by the ratio of specified maximum output power and tune-up tolerance of HSDPA / HSUPA / DC-HSDPA to RMC12.2Kbps and the adjusted SAR is  $\leq 1.2$  W/kg, SAR measurement is not required for HSDPA / HSUPA / DC-HSDPA.
7. Per KDB 648474 D04v01r02, when the reported SAR for a body-worn accessory measured without a headset connected to the handset is  $\leq 1.2$  W/kg, SAR testing with a headset connected to the handset is not required.

### 14.1 Head SAR

#### <GSM SAR>

Plot No.	Band	Mode	Test Position	Ch.	Freq. (MHz)	Average Power (dBm)	Tune-Up Limit (dBm)	Tune-up Scaling Factor	Power Drift (dB)	Measured 1g SAR (W/kg)	Reported 1g SAR (W/kg)
01	GSM850	GPRS (2 Tx slots)	Right Cheek	128	824.2	30.48	31.50	1.265	-0.05	0.400	<b>0.506</b>
	GSM850	GPRS (2 Tx slots)	Right Tilted	128	824.2	30.48	31.50	1.265	0.14	0.227	0.287
	GSM850	GPRS (2 Tx slots)	Left Cheek	128	824.2	30.48	31.50	1.265	0.13	0.329	0.416
	GSM850	GPRS (2 Tx slots)	Left Tilted	128	824.2	30.48	31.50	1.265	0.06	0.212	0.268
02	GSM1900	GPRS (2 Tx slots)	Right Cheek	810	1909.8	27.87	29.00	1.297	-0.05	0.437	<b>0.567</b>
	GSM1900	GPRS (2 Tx slots)	Right Tilted	810	1909.8	27.87	29.00	1.297	-0.03	0.169	0.219
	GSM1900	GPRS (2 Tx slots)	Left Cheek	810	1909.8	27.87	29.00	1.297	0	0.246	0.319
	GSM1900	GPRS (2 Tx slots)	Left Tilted	810	1909.8	27.87	29.00	1.297	0.02	0.176	0.228



<WCDMA SAR>

Plot No.	Band	Mode	Test Position	Ch.	Freq. (MHz)	Average Power (dBm)	Tune-Up Limit (dBm)	Tune-up Scaling Factor	Power Drift (dB)	Measured 1g SAR (W/kg)	Reported 1g SAR (W/kg)
03	WCDMA V	RMC 12.2Kbps	Right Cheek	4132	826.4	23.84	24.70	1.219	-0.08	0.218	0.266
	WCDMA V	RMC 12.2Kbps	Right Tilted	4132	826.4	23.84	24.70	1.219	-0.04	0.119	0.145
	WCDMA V	RMC 12.2Kbps	Left Cheek	4132	826.4	23.84	24.70	1.219	0.01	0.187	0.228
	WCDMA V	RMC 12.2Kbps	Left Tilted	4132	826.4	23.84	24.70	1.219	-0.08	0.105	0.128
04	WCDMA II	RMC 12.2Kbps	Right Cheek	9538	1907.6	22.81	24.00	1.315	0.03	0.821	1.080
	WCDMA II	RMC 12.2Kbps	Right Cheek	9262	1852.4	22.74	24.00	1.337	0.02	0.629	0.841
	WCDMA II	RMC 12.2Kbps	Right Cheek	9400	1880	22.71	24.00	1.346	0.06	0.699	0.941
	WCDMA II	RMC 12.2Kbps	Right Tilted	9538	1907.6	22.81	24.00	1.315	0.08	0.267	0.351
	WCDMA II	RMC 12.2Kbps	Left Cheek	9538	1907.6	22.81	24.00	1.315	-0.06	0.413	0.543
	WCDMA II	RMC 12.2Kbps	Left Tilted	9538	1907.6	22.81	24.00	1.315	-0.09	0.265	0.349

14.2 Hotspot SAR

<GSM SAR>

Plot No.	Band	Mode	Test Position	Gap (cm)	Ch.	Freq. (MHz)	Average Power (dBm)	Tune-Up Limit (dBm)	Tune-up Scaling Factor	Power Drift (dB)	Measured 1g SAR (W/kg)	Reported 1g SAR (W/kg)
	GSM850	GPRS (2 Tx slots)	Front	1cm	128	824.2	30.48	31.50	1.265	0.01	0.220	0.278
05	GSM850	GPRS (2 Tx slots)	Back	1cm	128	824.2	30.48	31.50	1.265	-0.03	0.329	0.416
	GSM850	GPRS (2 Tx slots)	Left Side	1cm	128	824.2	30.48	31.50	1.265	-0.02	0.117	0.148
	GSM850	GPRS (2 Tx slots)	Right Side	1cm	128	824.2	30.48	31.50	1.265	0.04	0.213	0.269
	GSM850	GPRS (2 Tx slots)	Bottom Side	1cm	128	824.2	30.48	31.50	1.265	-0.01	0.118	0.149
	GSM1900	GPRS (2 Tx slots)	Front	1cm	810	1909.8	27.87	29.00	1.297	-0.03	0.333	0.432
06	GSM1900	GPRS (2 Tx slots)	Back	1cm	810	1909.8	27.87	29.00	1.297	-0.1	0.664	0.861
	GSM1900	GPRS (2 Tx slots)	Back	1cm	512	1850.2	27.85	29.00	1.303	-0.1	0.629	0.820
	GSM1900	GPRS (2 Tx slots)	Back	1cm	661	1880	27.82	29.00	1.312	-0.04	0.542	0.711
	GSM1900	GPRS (2 Tx slots)	Left Side	1cm	810	1909.8	27.87	29.00	1.297	-0.03	0.046	0.060
	GSM1900	GPRS (2 Tx slots)	Right Side	1cm	810	1909.8	27.87	29.00	1.297	-0.01	0.313	0.406
	GSM1900	GPRS (2 Tx slots)	Bottom Side	1cm	810	1909.8	27.87	29.00	1.297	-0.06	0.596	0.773

<WCDMA SAR>

Plot No.	Band	Mode	Test Position	Gap (cm)	Ch.	Freq. (MHz)	Average Power (dBm)	Tune-Up Limit (dBm)	Tune-up Scaling Factor	Power Drift (dB)	Measured 1g SAR (W/kg)	Reported 1g SAR (W/kg)
	WCDMA V	RMC 12.2Kbps	Front	1cm	4132	826.4	23.84	24.70	1.219	0.07	0.249	0.304
07	WCDMA V	RMC 12.2Kbps	Back	1cm	4132	826.4	23.84	24.70	1.219	0.04	0.297	0.362
	WCDMA V	RMC 12.2Kbps	Left Side	1cm	4132	826.4	23.84	24.70	1.219	0	0.110	0.134
	WCDMA V	RMC 12.2Kbps	Right Side	1cm	4132	826.4	23.84	24.70	1.219	-0.11	0.213	0.260
	WCDMA V	RMC 12.2Kbps	Bottom Side	1cm	4132	826.4	23.84	24.70	1.219	0.04	0.087	0.106
	WCDMA II	RMC 12.2Kbps	Front	1cm	9538	1907.6	22.81	24.00	1.315	-0.05	0.603	0.793
	WCDMA II	RMC 12.2Kbps	Back	1cm	9538	1907.6	22.81	24.00	1.315	0.05	0.985	1.295
	WCDMA II	RMC 12.2Kbps	Back	1cm	9262	1852.4	22.74	24.00	1.337	0.02	1.060	1.417
	WCDMA II	RMC 12.2Kbps	Back	1cm	9400	1880	22.71	24.00	1.346	0.04	1.070	1.440
	WCDMA II	RMC 12.2Kbps	Left Side	1cm	9538	1907.6	22.81	24.00	1.315	-0.03	0.079	0.104
	WCDMA II	RMC 12.2Kbps	Right Side	1cm	9538	1907.6	22.81	24.00	1.315	0.09	0.574	0.755
	WCDMA II	RMC 12.2Kbps	Bottom Side	1cm	9538	1907.6	22.81	24.00	1.315	-0.09	1.060	1.394
08	WCDMA II	RMC 12.2Kbps	Bottom Side	1cm	9262	1852.4	22.74	24.00	1.337	-0.03	1.100	1.470
	WCDMA II	RMC 12.2Kbps	Bottom Side	1cm	9400	1880	22.71	24.00	1.346	-0.03	1.010	1.359

**14.3 Body Worn Accessory SAR**

**<GSM SAR>**

Plot No.	Band	Mode	Test Position	Gap (cm)	Ch.	Freq. (MHz)	Average Power (dBm)	Tune-Up Limit (dBm)	Tune-up Scaling Factor	Power Drift (dB)	Measured 1g SAR (W/kg)	Reported 1g SAR (W/kg)
	GSM850	GPRS (2 Tx slots)	Front	1.5cm	128	824.2	30.48	31.50	1.265	0.02	0.197	0.249
09	GSM850	GPRS (2 Tx slots)	Back	1.5cm	128	824.2	30.48	31.50	1.265	0.08	0.248	<b>0.314</b>
	GSM1900	GPRS (2 Tx slots)	Front	1.5cm	810	1909.8	27.87	29.00	1.297	-0.04	0.203	0.263
10	GSM1900	GPRS (2 Tx slots)	Back	1.5cm	810	1909.8	27.87	29.00	1.297	-0.1	0.277	<b>0.359</b>

**<WCDMA SAR>**

Plot No.	Band	Mode	Test Position	Gap (cm)	Ch.	Freq. (MHz)	Average Power (dBm)	Tune-Up Limit (dBm)	Tune-up Scaling Factor	Power Drift (dB)	Measured 1g SAR (W/kg)	Reported 1g SAR (W/kg)
	WCDMA V	RMC 12.2Kbps	Front	1.5cm	4132	826.4	23.84	24.70	1.219	0.04	0.214	0.261
11	WCDMA V	RMC 12.2Kbps	Back	1.5cm	4132	826.4	23.84	24.70	1.219	0.02	0.237	<b>0.289</b>
	WCDMA II	RMC 12.2Kbps	Front	1.5cm	9538	1907.6	22.81	24.00	1.315	0	0.375	0.493
12	WCDMA II	RMC 12.2Kbps	Back	1.5cm	9538	1907.6	22.81	24.00	1.315	-0.02	0.453	<b>0.596</b>

**14.4 Repeated SAR Measurement**

No.	Band	Mode	Test Position	Gap (cm)	Ch.	Freq. (MHz)	Average Power (dBm)	Tune-Up Limit (dBm)	Tune-up Scaling Factor	Power Drift (dB)	Measured 1g SAR (W/kg)	Ratio	Reported 1g SAR (W/kg)
1st	WCDMA II	RMC 12.2Kbps	Bottom Side	1cm	9262	1852.4	22.74	24.00	1.337	-0.03	1.100	-	1.470
2nd	WCDMA II	RMC 12.2Kbps	Bottom Side	1cm	9262	1852.4	22.74	24.00	1.337	-0.02	1.090	1.01	1.457

**General Note:**

1. Per KDB 865664 D01v01r03, for each frequency band, repeated SAR measurement is required only when the measured SAR is  $\geq 0.8$ W/kg
2. Per KDB 865664 D01v01r03, if the ratio among the repeated measurement is  $\leq 1.2$  and the measured SAR  $< 1.45$ W/kg, only one repeated measurement is required.
3. The ratio is the difference in percentage between original and repeated *measured SAR*.
4. All measurement SAR result is scaled-up to account for tune-up tolerance and is compliant.

**15. Simultaneous Transmission Analysis**

NO.	Simultaneous Transmission Configurations	Portable Handset			Note
		Head	Body-worn	Hotspot	
1.	GSM(Voice) + WLAN2.4GHz(data)	Yes	Yes		
2.	WCDMA(Voice) + WLAN2.4GHz(data)	Yes	Yes		
3.	GSM(Voice) + Bluetooth(data)	Yes	Yes		
4.	WCDMA((Voice) + Bluetooth(data)	Yes	Yes		
5.	GPRS/EDGE(Data) + WLAN2.4GHz(data)	Yes	Yes	Yes	2.4GHz Hotspot
6.	WCDMA(Data) + WLAN2.4GHz(data)	Yes	Yes	Yes	2.4GHz Hotspot
7.	GPRS/EDGE(Data) + Bluetooth(data)	Yes	Yes	Yes	Bluetooth Tethering
8.	WCDMA(Data) + Bluetooth(data)	Yes	Yes	Yes	Bluetooth Tethering

**General Note:**

1. This device supported VoIP in EGPRS, WCDMA (e.g. 3rd party VoIP).
2. The 2.4GHz WLAN and Bluetooth SAR testing results were referred to Sporton FCC SAR Test Report, Brand Name: Motorola Mobility LLC, Model Name: 4486, FCC ID: IHDT56QE2, Report No: FA4O1411 or Appendix D and also used perform transmission simultaneous analysis.
3. WLAN and Bluetooth share the same antenna, and cannot transmit simultaneously.
4. The Scaled SAR summation is calculated based on the same configuration and test position.
5. Per KDB 447498 D01v05r02, simultaneous transmission SAR is compliant if,
  - i) Scalar SAR summation < 1.6W/kg.
  - ii)  $SPLSR = (SAR_1 + SAR_2)^{1.5} / (\text{min. separation distance, mm})$ , and the peak separation distance is determined from the square root of  $[(x_1-x_2)^2 + (y_1-y_2)^2 + (z_1-z_2)^2]$ , where  $(x_1, y_1, z_1)$  and  $(x_2, y_2, z_2)$  are the coordinates of the extrapolated peak SAR locations in the zoom scan.
  - iii) If  $SPLSR \leq 0.04$ , simultaneously transmission SAR measurement is not necessary.
  - iv) Simultaneously transmission SAR measurement, and the reported multi-band SAR < 1.6W/kg.
  - v) The SPLSR calculated results please refer to section 15.4.

**15.1 Head Exposure Conditions**

WWAN Band	Exposure Position	1	2	3	1+2 Summed 1g SAR (W/kg)	1+3 Summed 1g SAR (W/kg)	SPLSR	Case No
		WWAN	2.4GHz WLAN	2.4GHz Bluetooth				
		1g SAR (W/kg)	1g SAR (W/kg)	1g SAR (W/kg)				
GSM	GSM850	Right Cheek	0.506	0.167	0.012	<b>0.67</b>	<b>0.52</b>	
		Right Tilted	0.287	0.068	0.028	<b>0.36</b>	<b>0.32</b>	
		Left Cheek	0.416	0.147	0.017	<b>0.56</b>	<b>0.43</b>	
		Left Tilted	0.268	0.077	0.009	<b>0.35</b>	<b>0.28</b>	
	GSM1900	Right Cheek	0.567	0.167	0.012	<b>0.73</b>	<b>0.58</b>	
		Right Tilted	0.219	0.068	0.028	<b>0.29</b>	<b>0.25</b>	
		Left Cheek	0.319	0.147	0.017	<b>0.47</b>	<b>0.34</b>	
		Left Tilted	0.228	0.077	0.009	<b>0.31</b>	<b>0.24</b>	
WCDMA	Band V	Right Cheek	0.266	0.167	0.012	<b>0.43</b>	<b>0.28</b>	
		Right Tilted	0.145	0.068	0.028	<b>0.21</b>	<b>0.17</b>	
		Left Cheek	0.228	0.147	0.017	<b>0.38</b>	<b>0.25</b>	
		Left Tilted	0.128	0.077	0.009	<b>0.21</b>	<b>0.14</b>	
	Band II	Right Cheek	1.080	0.167	0.012	<b>1.25</b>	<b>1.09</b>	
		Right Tilted	0.351	0.068	0.028	<b>0.42</b>	<b>0.38</b>	
		Left Cheek	0.543	0.147	0.017	<b>0.69</b>	<b>0.56</b>	
		Left Tilted	0.349	0.077	0.009	<b>0.43</b>	<b>0.36</b>	

**15.2 Hotspot Exposure Conditions**

WWAN Band	Exposure Position	1	2	3	1+2 Summed 1g SAR (W/kg)	1+3 Summed 1g SAR (W/kg)	SPLSR	Case No	
		WWAN	2.4GHz WLAN	2.4GHz Bluetooth					
		1g SAR (W/kg)	1g SAR (W/kg)	1g SAR (W/kg)					
GSM	GSM850	Front	0.278	0.054	0.013	<b>0.33</b>	<b>0.29</b>		
		Back	0.416	0.351	0.056	<b>0.77</b>	<b>0.47</b>		
		Left side	0.148			<b>0.15</b>	<b>0.15</b>		
		Right side	0.269	0.229	0.032	<b>0.50</b>	<b>0.30</b>		
		Bottom side	0.149			<b>0.15</b>	<b>0.15</b>		
	GSM1900	Front	0.432	0.054	0.013	<b>0.49</b>	<b>0.45</b>		
		Back	0.861	0.351	0.056	<b>1.21</b>	<b>0.92</b>		
		Left side	0.060			<b>0.06</b>	<b>0.06</b>		
		Right side	0.406	0.229	0.032	<b>0.64</b>	<b>0.44</b>		
		Bottom side	0.773			<b>0.77</b>	<b>0.77</b>		
WCDMA	Band V	Front	0.304	0.054	0.013	<b>0.36</b>	<b>0.32</b>		
		Back	0.362	0.351	0.056	<b>0.71</b>	<b>0.42</b>		
		Left side	0.134			<b>0.13</b>	<b>0.13</b>		
		Right side	0.260	0.229	0.032	<b>0.49</b>	<b>0.29</b>		
		Bottom side	0.106			<b>0.11</b>	<b>0.11</b>		
	Band II	Front	0.793	0.054	0.013	<b>0.85</b>	<b>0.81</b>		
		Back	1.440	0.351	0.056	<b>1.79</b>	<b>1.50</b>	0.03	Case 1
		Left side	0.104			<b>0.10</b>	<b>0.10</b>		
		Right side	0.755	0.229	0.032	<b>0.98</b>	<b>0.79</b>		
		Bottom side	1.470			<b>1.47</b>	<b>1.47</b>		

**15.3 Body-Worn Accessory Exposure Conditions**

WWAN Band	Exposure Position	1	2	3	1+2 Summed 1g SAR (W/kg)	1+3 Summed 1g SAR (W/kg)	SPLSR	Case No	
		WWAN	2.4GHz WLAN	2.4GHz Bluetooth					
		1g SAR (W/kg)	1g SAR (W/kg)	1g SAR (W/kg)					
GSM	GSM850	Front	0.249	0.035	0.005	<b>0.28</b>	<b>0.25</b>		
		Back	0.314	0.189	0.019	<b>0.50</b>	<b>0.33</b>		
	GSM1900	Front	0.263	0.035	0.005	<b>0.30</b>	<b>0.27</b>		
		Back	0.359	0.189	0.019	<b>0.55</b>	<b>0.38</b>		
WCDMA	Band V	Front	0.261	0.035	0.005	<b>0.30</b>	<b>0.27</b>		
		Back	0.289	0.189	0.019	<b>0.48</b>	<b>0.31</b>		
	Band II	Front	0.493	0.035	0.005	<b>0.53</b>	<b>0.50</b>		
		Back	0.596	0.189	0.019	<b>0.79</b>	<b>0.62</b>		

**15.4 SPLSR Evaluation and Analysis**

**General Note:**

- SPLSR =  $(SAR_1 + SAR_2)^{1.5} / (\text{min. separation distance, mm})$ . If  $SPLSR \leq 0.04$ , simultaneously transmission SAR measurement is not necessary

Case 1	Band	Position	SAR (W/kg)	Gap (cm)	SAR peak location (m)			3D distance (mm)	Summed SAR (W/kg)	SPLSR Results	Simultaneous SAR
					X	Y	Z				
	WLAN2.4GHz	Back	0.351	1cm	-0.047	0.0146	-0.205	79.1	1.79	0.03	Not required
	WCDMA II		1.440	1cm	-0.0345	-0.0635	-0.205				

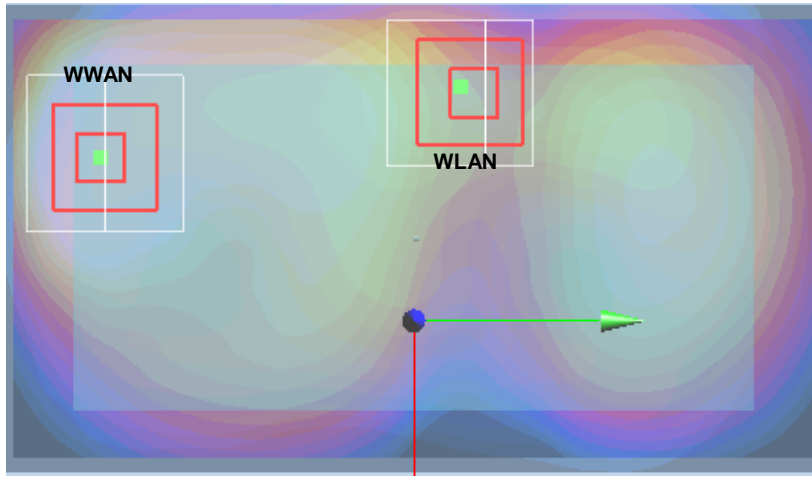

**Test Engineer :** San Lin, Galen Zhang, Thomas Wang, Kurt Liu, and Iran Wang

## 16. Uncertainty Assessment

The component of uncertainty may generally be categorized according to the methods used to evaluate them. The evaluation of uncertainty by the statistical analysis of a series of observations is termed a Type A evaluation of uncertainty. The evaluation of uncertainty by means other than the statistical analysis of a series of observation is termed a Type B evaluation of uncertainty. Each component of uncertainty, however evaluated, is represented by an estimated standard deviation, termed standard uncertainty, which is determined by the positive square root of the estimated variance.

A Type A evaluation of standard uncertainty may be based on any valid statistical method for treating data. This includes calculating the standard deviation of the mean of a series of independent observations; using the method of least squares to fit a curve to the data in order to estimate the parameter of the curve and their standard deviations; or carrying out an analysis of variance in order to identify and quantify random effects in certain kinds of measurement.

A type B evaluation of standard uncertainty is typically based on scientific judgment using all of the relevant information available. These may include previous measurement data, experience, and knowledge of the behavior and properties of relevant materials and instruments, manufacture’s specification, data provided in calibration reports and uncertainties assigned to reference data taken from handbooks. Broadly speaking, the uncertainty is either obtained from an outdoor source or obtained from an assumed distribution, such as the normal distribution, rectangular or triangular distributions indicated in table below.

Uncertainty Distributions	Normal	Rectangular	Triangular	U-Shape
Multi-plying Factor <sup>(a)</sup>	1/k <sup>(b)</sup>	1/√3	1/√6	1/√2

(a) standard uncertainty is determined as the product of the multiplying factor and the estimated range of variations in the measured quantity

(b)  $\kappa$  is the coverage factor

**Table 16.1. Standard Uncertainty for Assumed Distribution**

The combined standard uncertainty of the measurement result represents the estimated standard deviation of the result. It is obtained by combining the individual standard uncertainties of both Type A and Type B evaluation using the usual “root-sum-squares” (RSS) methods of combining standard deviations by taking the positive square root of the estimated variances.

Expanded uncertainty is a measure of uncertainty that defines an interval about the measurement result within which the measured value is confidently believed to lie. It is obtained by multiplying the combined standard uncertainty by a coverage factor. Typically, the coverage factor ranges from 2 to 3. Using a coverage factor allows the true value of a measured quantity to be specified with a defined probability within the specified uncertainty range. For purpose of this document, a coverage factor two is used, which corresponds to confidence interval of about 95 %. The DASY uncertainty Budget is shown in the following tables.



Error Description	Uncertainty Value (±%)	Probability Distribution	Divisor	Ci (1g)	Ci (10g)	Standard Uncertainty (1g)	Standard Uncertainty (10g)
<b>Measurement System</b>							
Probe Calibration	6.0	Normal	1	1	1	± 6.0 %	± 6.0 %
Axial Isotropy	4.7	Rectangular	√3	0.7	0.7	± 1.9 %	± 1.9 %
Hemispherical Isotropy	9.6	Rectangular	√3	0.7	0.7	± 3.9 %	± 3.9 %
Boundary Effects	1.0	Rectangular	√3	1	1	± 0.6 %	± 0.6 %
Linearity	4.7	Rectangular	√3	1	1	± 2.7 %	± 2.7 %
System Detection Limits	1.0	Rectangular	√3	1	1	± 0.6 %	± 0.6 %
Readout Electronics	0.3	Normal	1	1	1	± 0.3 %	± 0.3 %
Response Time	0.8	Rectangular	√3	1	1	± 0.5 %	± 0.5 %
Integration Time	2.6	Rectangular	√3	1	1	± 1.5 %	± 1.5 %
RF Ambient Noise	3.0	Rectangular	√3	1	1	± 1.7 %	± 1.7 %
RF Ambient Reflections	3.0	Rectangular	√3	1	1	± 1.7 %	± 1.7 %
Probe Positioner	0.4	Rectangular	√3	1	1	± 0.2 %	± 0.2 %
Probe Positioning	2.9	Rectangular	√3	1	1	± 1.7 %	± 1.7 %
Max. SAR Eval.	1.0	Rectangular	√3	1	1	± 0.6 %	± 0.6 %
<b>Test Sample Related</b>							
Device Positioning	2.9	Normal	1	1	1	± 2.9 %	± 2.9 %
Device Holder	3.6	Normal	1	1	1	± 3.6 %	± 3.6 %
Power Drift	5.0	Rectangular	√3	1	1	± 2.9 %	± 2.9 %
<b>Phantom and Setup</b>							
Phantom Uncertainty	4.0	Rectangular	√3	1	1	± 2.3 %	± 2.3 %
Liquid Conductivity (Target)	5.0	Rectangular	√3	0.64	0.43	± 1.8 %	± 1.2 %
Liquid Conductivity (Meas.)	2.5	Normal	1	0.64	0.43	± 1.6 %	± 1.1 %
Liquid Permittivity (Target)	5.0	Rectangular	√3	0.6	0.49	± 1.7 %	± 1.4 %
Liquid Permittivity (Meas.)	2.5	Normal	1	0.6	0.49	± 1.5 %	± 1.2 %
<b>Combined Standard Uncertainty</b>						± 11.0 %	± 10.8 %
<b>Coverage Factor for 95 %</b>						K=2	
<b>Expanded Uncertainty</b>						± 22.0 %	± 21.5 %

Table 16.2. Uncertainty Budget for frequency range 300 MHz to 3 GHz



## **17. References**

- [1] FCC 47 CFR Part 2 "Frequency Allocations and Radio Treaty Matters; General Rules and Regulations"
- [2] ANSI/IEEE Std. C95.1-1992, "IEEE Standard for Safety Levels with Respect to Human Exposure to Radio Frequency Electromagnetic Fields, 3 kHz to 300 GHz", September 1992
- [3] IEEE Std. 1528-2003, "Recommended Practice for Determining the Peak Spatial-Average Specific Absorption Rate (SAR) in the Human Head from Wireless Communications Devices: Measurement Techniques", December 2003
- [4] SPEAG DASY System Handbook
- [5] FCC KDB 447498 D01 v05r02, "Mobile and Portable Device RF Exposure Procedures and Equipment Authorization Policies", Feb 2014
- [6] FCC KDB 648474 D04 v01r02, "SAR Evaluation Considerations for Wireless Handsets", Dec 2013.
- [7] FCC KDB 941225 D01 v03, "3G SAR MEAUREMENT PROCEDURES", Oct 2014
- [8] FCC KDB 941225 D06 v02, "SAR Evaluation Procedures for Portable Devices with Wireless Router Capabilities", Oct 2014.
- [9] FCC KDB 865664 D01 v01r03, "SAR Measurement Requirements for 100 MHz to 6 GHz", Feb 2014.
- [10] FCC KDB 865664 D02 v01r01, "RF Exposure Compliance Reporting and Documentation Considerations" May 2013.