

FCC SAR Test Report

APPLICANT : Motorola Mobility, LLC
EQUIPMENT : Mobile Cellular Phone
BRAND NAME : Motorola
MODEL NAME : 4241
FCC ID : IHDT56QC8
STANDARD : FCC 47 CFR Part 2 (2.1093)
ANSI/IEEE C95.1-1992
IEEE 1528-2003

We, SPORTON INTERNATIONAL INC., would like to declare that the tested sample has been evaluated in accordance with the procedures and had been in compliance with the applicable technical standards.

The test results in this report apply exclusively to the tested model / sample. Without written approval of SPORTON INTERNATIONAL INC., the test report shall not be reproduced except in full.

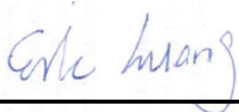

Reviewed by: Eric Huang / Deputy Manager



Approved by: Jones Tsai / Manager



SPORTON INTERNATIONAL INC.

No. 52, Hwa Ya 1st Rd., Hwa Ya Technology Park, Kwei-Shan Hsiang, Tao Yuan Hsien, Taiwan, R.O.C.



Table of Contents

- 1. Statement of Compliance 4
- 2. Administration Data 5
- 3. Guidance Standard 5
- 4. Equipment Under Test (EUT) 6
 - 4.1 General Information 6
 - 4.2 Maximum Tune-up Limit..... 7
 - 4.3 General LTE SAR Test and Reporting Considerations 8
- 5. RF Exposure Limits..... 9
 - 5.1 Uncontrolled Environment..... 9
 - 5.2 Controlled Environment..... 9
- 6. Specific Absorption Rate (SAR).....10
 - 6.1 Introduction10
 - 6.2 SAR Definition.....10
- 7. System Description and Setup11
- 8. Measurement Procedures12
 - 8.1 Spatial Peak SAR Evaluation.....12
 - 8.2 Power Reference Measurement.....13
 - 8.3 Area Scan13
 - 8.4 Zoom Scan.....14
 - 8.5 Volume Scan Procedures.....14
 - 8.6 Power Drift Monitoring.....14
- 9. Test Equipment List15
- 10. System Verification16
 - 10.1 Tissue Verification16
 - 10.2 System Performance Check Results.....17
- 11. RF Exposure Positions18
 - 11.1 Ear and handset reference point18
 - 11.2 Definition of the cheek position.....19
 - 11.3 Definition of the tilt position.....20
 - 11.4 Body Worn Accessory21
 - 11.5 Wireless Router.....21
- 12. Conducted RF Output Power (Unit: dBm).....22
- 13. Antenna Location25
- 14. SAR Test Results26
 - 14.1 Head SAR26
 - 14.2 Hotspot SAR27
 - 14.3 Body Worn Accessory SAR.....28
 - 14.4 Repeated SAR Measurement28
- 15. Simultaneous Transmission Analysis.....29
 - 15.1 Head Exposure Conditions30
 - 15.2 Hotspot Exposure Conditions.....30
 - 15.3 Body-Worn Accessory Exposure Conditions31
 - 15.4 SPLSR Evaluation and Analysis.....31
- 16. Uncertainty Assessment32
- 17. References.....34
- Appendix A. Plots of System Performance Check
- Appendix B. Plots of High SAR Measurement
- Appendix C. DASY Calibration Certificate
- Appendix D. WWAN Reference Report
- Appendix E. BT/WiFi Reference Report



1. Statement of Compliance

The maximum results of Specific Absorption Rate (SAR) found during testing for **Motorola Mobility, LLC, Mobile Cellular Phone, 4241**, are as follows.

Equipment Class	Frequency Band	Highest SAR Summary			
		Head (Separation 0mm) 1g SAR (W/kg)	Body-worn (Separation 15mm) 1g SAR (W/kg)	Wireless Router (Separation 10mm) 1g SAR (W/kg)	Highest Simultaneous Transmission 1g SAR (W/kg)
PCE	GSM850	0.43	0.45	0.55	1.57
	GSM1900	0.26	0.22	0.53	
	WCDMA Band V	0.68	0.64	0.98	
	WCDMA Band IV	1.08	0.66	1.46	
	WCDMA Band II	0.73	0.77	1.32	
	CDMA 2000 BC0	0.49	0.68	0.92	
	CDMA 2000 BC1	1.01	0.82	0.86	
	LTE Band 13	0.47	0.29	0.41	
	LTE Band 5	0.59	0.76	0.89	
	LTE Band 4	0.83	0.59	1.08	
LTE Band 2	0.72	0.65	1.37		
DTS	2.4GHz WLAN	0.89	0.09	0.15	1.57
DSS	Bluetooth	0.15	0.01	0.02	1.49
Date of Testing:		2014/12/22~2014/12/29			

This device is in compliance with Specific Absorption Rate (SAR) for general population/uncontrolled exposure limits (1.6 W/kg) specified in FCC 47 CFR part 2 (2.1093) and ANSI/IEEE C95.1-1992, and had been tested in accordance with the measurement methods and procedures specified in IEEE 1528-2003.

2. Administration Data

Testing Laboratory	
Test Site	SPORTON INTERNATIONAL INC.
Test Site Location	No. 52, Hwa Ya 1 st Rd., Hwa Ya Technology Park, Kwei-Shan Hsiang, Tao Yuan Hsien, Taiwan, R.O.C. TEL: +886-3-327-3456 FAX: +886-3-328-4978

Applicant	
Company Name	Motorola Mobility, LLC
Address	222 W. Merchandise Mart Plaza, Chicago IL 60654 USA

Manufacturer	
Company Name	Motorola Mobility, LLC
Address	222 W. Merchandise Mart Plaza, Chicago IL 60654 USA

3. Guidance Standard

The Specific Absorption Rate (SAR) testing specification, method, and procedure for this device is in accordance with the following standards:

- FCC 47 CFR Part 2 (2.1093)
- ANSI/IEEE C95.1-1992
- IEEE 1528-2003
- FCC KDB 865664 D01 SAR Measurement 100 MHz to 6 GHz v01r03
- FCC KDB 865664 D02 SAR Reporting v01r01
- FCC KDB 447498 D01 General RF Exposure Guidance v05r02
- FCC KDB 648474 D04 SAR Evaluation Considerations for Wireless Handsets v01r02
- FCC KDB 248227 D01 SAR meas for 802 11abg v01r02
- FCC KDB 941225 D01 3G SAR Procedures v03
- FCC KDB 941225 D05 SAR for LTE Devices v02r03
- FCC KDB 941225 D06 Hotspot Mode SAR v02

4. Equipment Under Test (EUT)

4.1 General Information

Product Feature & Specification	
Equipment Name	Mobile Cellular Phone
Brand Name	Motorola
Model Name	4241
FCC ID	IHDT56QC8
IMEI Code	990005450005740
Wireless Technology and Frequency Range	GSM850: 824.2 MHz ~ 848.8 MHz GSM1900: 1850.2 MHz ~ 1909.8 MHz WCDMA Band V: 826.4 MHz ~ 846.6 MHz WCDMA Band IV: 1712.4 MHz ~ 1752.6 MHz WCDMA Band II: 1852.4 MHz ~ 1907.6 MHz CDMA2000 BC0: 824.7 MHz ~ 848.31 MHz CDMA 2000 BC1: 1851.25 MHz ~ 1908.75 MHz LTE Band 13: 779.5 MHz ~ 784.5 MHz LTE Band 5: 824.7 MHz ~ 848.3 MHz LTE Band 4: 1710.7 MHz ~ 1754.3 MHz LTE Band 2: 1850.7 MHz ~ 1909.3 MHz WLAN 2.4GHz Band: 2412 MHz ~ 2462 MHz Bluetooth: 2402 MHz ~ 2480 MHz
Mode	<ul style="list-style-type: none"> • GSM/GPRS/EGPRS • RMC/AMR 12.2Kbps • HSDPA • HSUPA • DC-HSDPA • CDMA2000: 1xRTT/1xEv-Do(Rev.0)/1xEv-Do(Rev.A) • LTE: QPSK, 16QAM • 802.11b/g/n HT20 • Bluetooth v3.0+EDR , Bluetooth v4.0-LE
GSM / (E)GPRS Transfer mode	Class B – EUT cannot support Packet Switched and Circuit Switched Network simultaneously but can automatically switch between Packet and Circuit Switched Network.
EUT Stage	Identical Prototype
Remark:	
<ol style="list-style-type: none"> 1. This device supported VoIP in EGPRS, CDMA, WCDMA, LTE (e.g. 3rd party VoIP). 2. This report only assessed CDMA BC0 / BC1 and LTE B13, other cellular frequency band evaluation which refer to the Sporton FCC SAR Report, FCC ID: IHDT56QC1, Report No: FA4N1482A or Appendix D, and the BT/WLAN evaluation which refer to the Sporton FCC SAR Report, FCC ID: IHDT56QC4, Report No: FA4N1482-01 or Appendix E and the SAR results also used perform simultaneous transmission analysis. 3. While operating in body-adjacent exposure configurations during a mobile hotspot session, reduced power limits are enforced on the WCDMA B2, CDMA BC1 and LTE B2 transmitter. More detailed information which can be referred to “operational description”. 	



4.2 Maximum Tune-up Limit

Mode	Burst average power(dBm)	
	GSM 850	GSM 1900
GSM (GMSK, 1 Tx slot)	33.50	30.50
GPRS (GMSK, 1 Tx slot)	33.50	30.50
GPRS (GMSK, 2 Tx slots)	30.50	27.50
GPRS (GMSK, 3 Tx slots)	28.75	25.75
GPRS (GMSK, 4 Tx slots)	27.50	24.50
EDGE (8PSK, 1 Tx slot)	28.00	27.00
EDGE (8PSK, 2 Tx slots)	25.50	24.50
EDGE (8PSK, 3 Tx slots)	23.25	22.25
EDGE (8PSK, 4 Tx slots)	22.00	21.00

Band / Mode			Average power(dBm)
WCDMA	Band V / IV / II	AMR / RMC 12.2Kbps	24.0
		HSDPA Subtest-1	23.0
		DC-HSDPA Subtest-1	23.0
		HSUPA Subtest-5	23.0
LTE		Band 13	24.0
		Band 5	24.0
		Band 4	24.0
		Band 2	24.0
CDMA		BC 0	25.0
		BC 1	25.0

Mode			Average Power (dBm)	
2.4GHz WLAN	802.11b		18.00	
	802.11g	CH 1	16.00	
		CH 6	16.00	
		CH 11	14.00	
	802.11n-HT20	CH 1	16.00	
		CH 6	16.00	
CH 11		14.00		
Bluetooth	v3.0+EDR	1Mbps	Low	13.00
			Middle	12.00
			High	10.00
		2Mbps	Low	10.00
			Middle	10.00
			High	8.00
	v4.0+LE	3Mbps	Low	10.00
			Middle	10.00
			High	8.00
			Low	10.50
			Middle	12.00
			High	9.00



4.3 General LTE SAR Test and Reporting Considerations

Summarized necessary items addressed in KDB 941225 D05 v02r03																																																		
FCC ID	IHDT56QC8																																																	
Equipment Name	Mobile Cellular Phone																																																	
Operating Frequency Range of each LTE transmission band	LTE Band 13: 779.5 MHz ~ 784.5 MHz LTE Band 05: 824.7 MHz ~ 848.3 MHz LTE Band 04: 1710.7 MHz ~ 1754.3 MHz LTE Band 02: 1850.7 MHz ~ 1909.3 MHz																																																	
Channel Bandwidth	LTE Band 13: 5MHz, 10MHz LTE Band 05: 1.4MHz, 3MHz, 5MHz, 10MHz LTE Band 04: 1.4MHz, 3MHz, 5MHz, 10MHz, 15MHz, 20MHz LTE Band 02: 1.4MHz, 3MHz, 5MHz, 10MHz, 15MHz, 20MHz																																																	
Release and Category	Rel8, Cat4																																																	
uplink modulations used	QPSK, and 16QAM																																																	
LTE Voice / Data requirements	Data only																																																	
LTE MPR permanently built-in by design	<p style="text-align: center;">Table 6.2.3-1: Maximum Power Reduction (MPR) for Power Class 3</p> <table border="1" style="width: 100%; border-collapse: collapse;"> <thead> <tr> <th rowspan="2">Modulation</th> <th colspan="6">Channel bandwidth / Transmission bandwidth (RB)</th> <th rowspan="2">MPR (dB)</th> </tr> <tr> <th>1.4 MHz</th> <th>3.0 MHz</th> <th>5 MHz</th> <th>10 MHz</th> <th>15 MHz</th> <th>20 MHz</th> </tr> </thead> <tbody> <tr> <td>QPSK</td> <td>> 5</td> <td>> 4</td> <td>> 8</td> <td>> 12</td> <td>> 16</td> <td>> 18</td> <td>≤ 1</td> </tr> <tr> <td>16 QAM</td> <td>≤ 5</td> <td>≤ 4</td> <td>≤ 8</td> <td>≤ 12</td> <td>≤ 16</td> <td>≤ 18</td> <td>≤ 1</td> </tr> <tr> <td>16 QAM</td> <td>> 5</td> <td>> 4</td> <td>> 8</td> <td>> 12</td> <td>> 16</td> <td>> 18</td> <td>≤ 2</td> </tr> </tbody> </table>												Modulation	Channel bandwidth / Transmission bandwidth (RB)						MPR (dB)	1.4 MHz	3.0 MHz	5 MHz	10 MHz	15 MHz	20 MHz	QPSK	> 5	> 4	> 8	> 12	> 16	> 18	≤ 1	16 QAM	≤ 5	≤ 4	≤ 8	≤ 12	≤ 16	≤ 18	≤ 1	16 QAM	> 5	> 4	> 8	> 12	> 16	> 18	≤ 2
Modulation	Channel bandwidth / Transmission bandwidth (RB)						MPR (dB)																																											
	1.4 MHz	3.0 MHz	5 MHz	10 MHz	15 MHz	20 MHz																																												
QPSK	> 5	> 4	> 8	> 12	> 16	> 18	≤ 1																																											
16 QAM	≤ 5	≤ 4	≤ 8	≤ 12	≤ 16	≤ 18	≤ 1																																											
16 QAM	> 5	> 4	> 8	> 12	> 16	> 18	≤ 2																																											
LTE A-MPR	In the base station simulator configuration, Network Setting value is set to NS_01 to disable A-MPR during SAR testing and the LTE SAR tests was transmitting on all TTI frames (Maximum TTI)																																																	
Spectrum plots for RB configuration	A properly configured base station simulator was used for the SAR and power measurement; therefore, spectrum plots for each RB allocation and offset configuration are not included in the SAR report.																																																	
Power reduction applied to satisfy SAR compliance	Yes, When operating in hotspot mode that LTE B2 power reduction applied to satisfy SAR compliance.																																																	
Transmission (H, M, L) channel numbers and frequencies in each LTE band																																																		
LTE Band 13																																																		
	Bandwidth 5 MHz				Bandwidth 10 MHz																																													
	Channel #		Freq.(MHz)		Channel #		Freq.(MHz)																																											
L	23205		779.5																																															
M	23230		782		23230		782																																											
H	23255		784.5																																															
LTE Band 5																																																		
	Bandwidth 1.4 MHz		Bandwidth 3 MHz		Bandwidth 5 MHz		Bandwidth 10 MHz																																											
	Ch. #	Freq. (MHz)	Ch. #	Freq. (MHz)	Ch. #	Freq. (MHz)	Ch. #	Freq. (MHz)																																										
L	20407	824.7	20415	825.5	20425	826.5	20450	829																																										
M	20525	836.5	20525	836.5	20525	836.5	20525	836.5																																										
H	20643	848.3	20635	847.5	20625	846.5	20600	844																																										
LTE Band 4																																																		
	Bandwidth 1.4 MHz		Bandwidth 3 MHz		Bandwidth 5 MHz		Bandwidth 10 MHz		Bandwidth 15 MHz		Bandwidth 20 MHz																																							
	Ch. #	Freq. (MHz)	Ch. #	Freq. (MHz)	Ch. #	Freq. (MHz)	Ch. #	Freq. (MHz)	Ch. #	Freq. (MHz)	Ch. #	Freq. (MHz)																																						
L	19957	1710.7	19965	1711.5	19975	1712.5	20000	1715	20025	1717.5	20050	1720																																						
M	20175	1732.5	20175	1732.5	20175	1732.5	20175	1732.5	20175	1732.5	20175	1732.5																																						
H	20393	1754.3	20385	1753.5	20375	1752.5	20350	1750	20325	1747.5	20300	1745																																						
LTE Band 2																																																		
	Bandwidth 1.4 MHz		Bandwidth 3 MHz		Bandwidth 5 MHz		Bandwidth 10 MHz		Bandwidth 15 MHz		Bandwidth 20 MHz																																							
	Ch. #	Freq. (MHz)	Ch. #	Freq. (MHz)	Ch. #	Freq. (MHz)	Ch. #	Freq. (MHz)	Ch. #	Freq. (MHz)	Ch. #	Freq. (MHz)																																						
L	18607	1850.7	18615	1851.5	18625	1852.5	18650	1855	18675	1857.5	18700	1860																																						
M	18900	1880	18900	1880	18900	1880	18900	1880	18900	1880	18900	1880																																						
H	19193	1909.3	19185	1908.5	19175	1907.5	19150	1905	19125	1902.5	19100	1900																																						



5. RF Exposure Limits

5.1 Uncontrolled Environment

Uncontrolled Environments are defined as locations where there is the exposure of individuals who have no knowledge or control of their exposure. The general population/uncontrolled exposure limits are applicable to situations in which the general public may be exposed or in which persons who are exposed as a consequence of their employment may not be made fully aware of the potential for exposure or cannot exercise control over their exposure. Members of the general public would come under this category when exposure is not employment-related; for example, in the case of a wireless transmitter that exposes persons in its vicinity.

5.2 Controlled Environment

Controlled Environments are defined as locations where there is exposure that may be incurred by persons who are aware of the potential for exposure, (i.e. as a result of employment or occupation). In general, occupational/controlled exposure limits are applicable to situations in which persons are exposed as a consequence of their employment, who have been made fully aware of the potential for exposure and can exercise control over their exposure. The exposure category is also applicable when the exposure is of a transient nature due to incidental passage through a location where the exposure levels may be higher than the general population/uncontrolled limits, but the exposed person is fully aware of the potential for exposure and can exercise control over his or her exposure by leaving the area or by some other appropriate means.

Limits for Occupational/Controlled Exposure (W/kg)

Whole-Body	Partial-Body	Hands, Wrists, Feet and Ankles
0.4	8.0	20.0

Limits for General Population/Uncontrolled Exposure (W/kg)

Whole-Body	Partial-Body	Hands, Wrists, Feet and Ankles
0.08	1.6	4.0

1. Whole-Body SAR is averaged over the entire body, partial-body SAR is averaged over any 1gram of tissue defined as a tissue volume in the shape of a cube. SAR for hands, wrists, feet and ankles is averaged over any 10 grams of tissue defined as a tissue volume in the shape of a cube.

6. Specific Absorption Rate (SAR)

6.1 Introduction

SAR is related to the rate at which energy is absorbed per unit mass in an object exposed to a radio field. The SAR distribution in a biological body is complicated and is usually carried out by experimental techniques or numerical modeling. The standard recommends limits for two tiers of groups, occupational/controlled and general population/uncontrolled, based on a person's awareness and ability to exercise control over his or her exposure. In general, occupational/controlled exposure limits are higher than the limits for general population/uncontrolled.

6.2 SAR Definition

The SAR definition is the time derivative (rate) of the incremental energy (dW) absorbed by (dissipated in) an incremental mass (dm) contained in a volume element (dv) of a given density (ρ). The equation description is as below:

$$SAR = \frac{d}{dt} \left(\frac{dW}{dm} \right) = \frac{d}{dt} \left(\frac{dW}{\rho dv} \right)$$

SAR is expressed in units of Watts per kilogram (W/kg)

$$SAR = \frac{\sigma |E|^2}{\rho}$$

Where: σ is the conductivity of the tissue, ρ is the mass density of the tissue and E is the RMS electrical field strength.

7. System Description and Setup

The DASY system used for performing compliance tests consists of the following items:

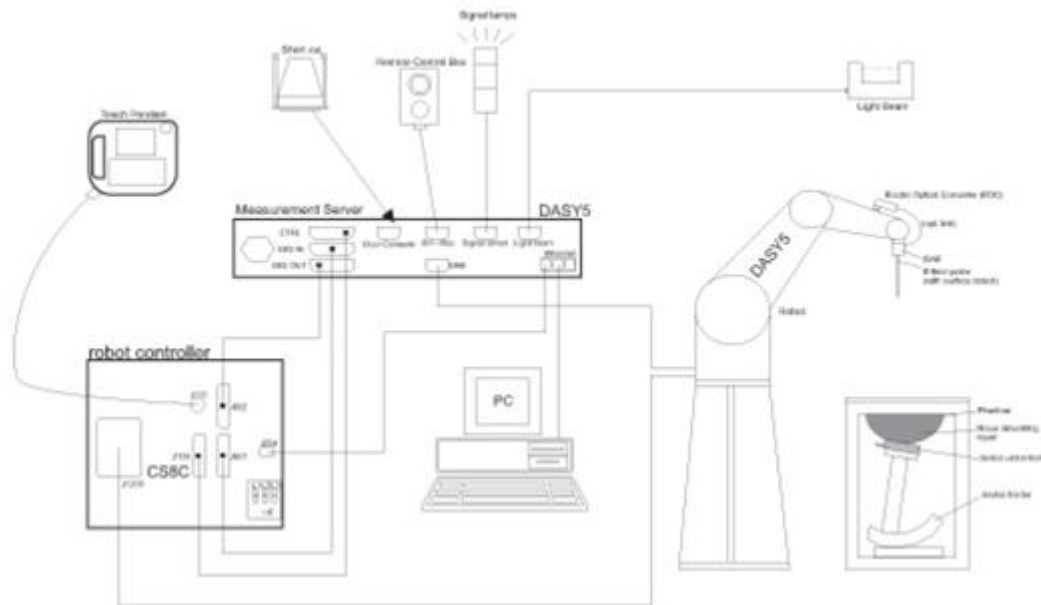

- A standard high precision 6-axis robot with controller, teach pendant and software. An arm extension for accommodating the data acquisition electronics (DAE).
- An isotropic Field probe optimized and calibrated for the targeted measurement.
- A data acquisition electronics (DAE) which performs the signal amplification, signal multiplexing, AD-conversion, offset measurements, mechanical surface detection, collision detection, etc. The unit is battery powered with standard or rechargeable batteries. The signal is optically transmitted to the EOC.
- The Electro-optical converter (EOC) performs the conversion from optical to electrical signals for the digital communication to the DAE. To use optical surface detection, a special version of the EOC is required. The EOC signal is transmitted to the measurement server.
- The function of the measurement server is to perform the time critical tasks such as signal filtering, control of the robot operation and fast movement interrupts.
- The Light Beam used is for probe alignment. This improves the (absolute) accuracy of the probe positioning.
- A computer running WinXP or Win7 and the DASY5 software.
- Remote control and teach pendant as well as additional circuitry for robot safety such as warning lamps, etc.
- The phantom, the device holder and other accessories according to the targeted measurement.

8. Measurement Procedures

The measurement procedures are as follows:

<Conducted power measurement>

- (a) For WWAN power measurement, use base station simulator to configure EUT WWAN transmission in conducted connection with RF cable, at maximum power in each supported wireless interface and frequency band.
- (b) Read the WWAN RF power level from the base station simulator.
- (c) For WLAN/BT power measurement, use engineering software to configure EUT WLAN/BT continuously transmission, at maximum RF power in each supported wireless interface and frequency band
- (d) Connect EUT RF port through RF cable to the power meter, and measure WLAN/BT output power

<SAR measurement>

- (a) Use base station simulator to configure EUT WWAN transmission in radiated connection, and engineering software to configure EUT WLAN/BT continuously transmission, at maximum RF power, in the highest power channel.
- (b) Place the EUT in the positions as Appendix D demonstrates.
- (c) Set scan area, grid size and other setting on the DASY software.
- (d) Measure SAR results for the highest power channel on each testing position.
- (e) Find out the largest SAR result on these testing positions of each band
- (f) Measure SAR results for other channels in worst SAR testing position if the reported SAR of highest power channel is larger than 0.8 W/kg

According to the test standard, the recommended procedure for assessing the peak spatial-average SAR value consists of the following steps:

- (a) Power reference measurement
- (b) Area scan
- (c) Zoom scan
- (d) Power drift measurement

8.1 Spatial Peak SAR Evaluation

The procedure for spatial peak SAR evaluation has been implemented according to the test standard. It can be conducted for 1g and 10g, as well as for user-specific masses. The DASY software includes all numerical procedures necessary to evaluate the spatial peak SAR value.

The base for the evaluation is a "cube" measurement. The measured volume must include the 1g and 10g cubes with the highest averaged SAR values. For that purpose, the center of the measured volume is aligned to the interpolated peak SAR value of a previously performed area scan.

The entire evaluation of the spatial peak values is performed within the post-processing engine (SEMCAD). The system always gives the maximum values for the 1g and 10g cubes. The algorithm to find the cube with highest averaged SAR is divided into the following stages:

- (a) Extraction of the measured data (grid and values) from the Zoom Scan
- (b) Calculation of the SAR value at every measurement point based on all stored data (A/D values and measurement parameters)
- (c) Generation of a high-resolution mesh within the measured volume
- (d) Interpolation of all measured values from the measurement grid to the high-resolution grid
- (e) Extrapolation of the entire 3-D field distribution to the phantom surface over the distance from sensor to surface
- (f) Calculation of the averaged SAR within masses of 1g and 10g

8.2 Power Reference Measurement

The Power Reference Measurement and Power Drift Measurements are for monitoring the power drift of the device under test in the batch process. The minimum distance of probe sensors to surface determines the closest measurement point to phantom surface. This distance cannot be smaller than the distance of sensor calibration points to probe tip as defined in the probe properties.

8.3 Area Scan

The area scan is used as a fast scan in two dimensions to find the area of high field values, before doing a fine measurement around the hot spot. The sophisticated interpolation routines implemented in DASY software can find the maximum found in the scanned area, within a range of the global maximum. The range (in dB0 is specified in the standards for compliance testing. For example, a 2 dB range is required in IEEE standard 1528 and IEC 62209 standards, whereby 3 dB is a requirement when compliance is assessed in accordance with the ARIB standard (Japan), if only one zoom scan follows the area scan, then only the absolute maximum will be taken as reference. For cases where multiple maximums are detected, the number of zoom scans has to be increased accordingly.

Area scan parameters extracted from FCC KDB 865664 D01v01r03 SAR measurement 100 MHz to 6 GHz.

	≤ 3 GHz	> 3 GHz
Maximum distance from closest measurement point (geometric center of probe sensors) to phantom surface	5 ± 1 mm	$\frac{1}{2} \cdot \delta \cdot \ln(2) \pm 0.5$ mm
Maximum probe angle from probe axis to phantom surface normal at the measurement location	$30^\circ \pm 1^\circ$	$20^\circ \pm 1^\circ$
Maximum area scan spatial resolution: Δx_{Area} , Δy_{Area}	≤ 2 GHz: ≤ 15 mm $2 - 3$ GHz: ≤ 12 mm	$3 - 4$ GHz: ≤ 12 mm $4 - 6$ GHz: ≤ 10 mm
	When the x or y dimension of the test device, in the measurement plane orientation, is smaller than the above, the measurement resolution must be \leq the corresponding x or y dimension of the test device with at least one measurement point on the test device.	

8.4 Zoom Scan

Zoom scans are used assess the peak spatial SAR values within a cubic averaging volume containing 1 gram and 10 gram of simulated tissue. The zoom scan measures points (refer to table below) within a cube shoes base faces are centered on the maxima found in a preceding area scan job within the same procedure. When the measurement is done, the zoom scan evaluates the averaged SAR for 1 gram and 10 gram and displays these values next to the job's label.

Zoom scan parameters extracted from FCC KDB 865664 D01v01r03 SAR measurement 100 MHz to 6 GHz.

		≤ 3 GHz	> 3 GHz	
Maximum zoom scan spatial resolution: $\Delta x_{Zoom}, \Delta y_{Zoom}$		≤ 2 GHz: ≤ 8 mm 2 – 3 GHz: ≤ 5 mm*	3 – 4 GHz: ≤ 5 mm* 4 – 6 GHz: ≤ 4 mm*	
Maximum zoom scan spatial resolution, normal to phantom surface	uniform grid: $\Delta z_{Zoom}(n)$	≤ 5 mm	3 – 4 GHz: ≤ 4 mm 4 – 5 GHz: ≤ 3 mm 5 – 6 GHz: ≤ 2 mm	
	graded grid	$\Delta z_{Zoom}(1)$: between 1 st two points closest to phantom surface	≤ 4 mm	3 – 4 GHz: ≤ 3 mm 4 – 5 GHz: ≤ 2.5 mm 5 – 6 GHz: ≤ 2 mm
		$\Delta z_{Zoom}(n>1)$: between subsequent points	$\leq 1.5 \cdot \Delta z_{Zoom}(n-1)$	
Minimum zoom scan volume	x, y, z	≥ 30 mm	3 – 4 GHz: ≥ 28 mm 4 – 5 GHz: ≥ 25 mm 5 – 6 GHz: ≥ 22 mm	
Note: δ is the penetration depth of a plane-wave at normal incidence to the tissue medium; see draft standard IEEE P1528-2011 for details. * When zoom scan is required and the <i>reported</i> SAR from the <i>area scan based 1-g SAR estimation</i> procedures of KDB 447498 is ≤ 1.4 W/kg, ≤ 8 mm, ≤ 7 mm and ≤ 5 mm zoom scan resolution may be applied, respectively, for 2 GHz to 3 GHz, 3 GHz to 4 GHz and 4 GHz to 6 GHz.				

8.5 Volume Scan Procedures

The volume scan is used for assess overlapping SAR distributions for antennas transmitting in different frequency bands. It is equivalent to an oversized zoom scan used in standalone measurements. The measurement volume will be used to enclose all the simultaneous transmitting antennas. For antennas transmitting simultaneously in different frequency bands, the volume scan is measured separately in each frequency band. In order to sum correctly to compute the 1g aggregate SAR, the EUT remain in the same test position for all measurements and all volume scan use the same spatial resolution and grid spacing. When all volume scan were completed, the software, SEMCAD postprocessor can combine and subsequently superpose these measurement data to calculating the multiband SAR.

8.6 Power Drift Monitoring

All SAR testing is under the EUT install full charged battery and transmit maximum output power. In DASYS measurement software, the power reference measurement and power drift measurement procedures are used for monitoring the power drift of EUT during SAR test. Both these procedures measure the field at a specified reference position before and after the SAR testing. The software will calculate the field difference in dB. If the power drifts more than 5%, the SAR will be retested.



9. Test Equipment List

Manufacturer	Name of Equipment	Type/Model	Serial Number	Calibration	
				Last Cal.	Due Date
SPEAG	750MHz System Validation Kit	D750V3	1099	Nov. 19, 2014	Nov. 18, 2015
SPEAG	835MHz System Validation Kit	D835V2	4d162	Nov. 19, 2014	Nov. 18, 2015
SPEAG	1900MHz System Validation Kit	D1900V2	5d182	Nov. 14, 2014	Nov. 13, 2015
SPEAG	Data Acquisition Electronics	DAE3	577	Oct. 06, 2014	Oct. 05, 2015
SPEAG	Data Acquisition Electronics	DAE4	1399	Nov. 13, 2014	Nov. 12, 2015
SPEAG	Dosimetric E-Field Probe	EX3DV4	3931	Sep. 25, 2014	Sep. 24, 2015
SPEAG	Dosimetric E-Field Probe	EX3DV4	3955	Nov. 21, 2014	Nov. 20, 2015
Wisewind	Thermometer	ETP-101	TM560	Oct. 21, 2014	Oct. 20, 2015
Wisewind	Thermometer	ETP-101	TM685	Oct. 21, 2014	Oct. 20, 2015
Anritsu	Radio Communication Analyzer	MT8820C	6201074414	Feb. 11, 2014	Feb. 10, 2015
Agilent	Wireless Communication Test Set	E5515C	MY50266977	May. 27, 2014	May. 26, 2015
SPEAG	Device Holder	N/A	N/A	NCR	NCR
R&S	Signal Generator	SMU200A	102502	Jul. 07, 2014	Jul. 06, 2015
SPEAG	Dielectric Probe Kit	DAKS-3.5	0004	Mar. 04, 2014	Mar. 03, 2015
Agilent	ENA Network Analyzer	E5071C	MY46101588	May. 31, 2014	May. 30, 2015
Anritsu	Power Meter	ML2495A	1036004	Aug. 09, 2014	Aug. 08, 2015
Anritsu	Power Sensor	MA2411B	1027253	Aug. 11, 2014	Aug. 10, 2015
R&S	Spectrum Analyzer	FSP 7	101131	Jul. 10, 2014	Jul. 09, 2015
Agilent	Dual Directional Coupler	778D	50422	Note1	
Woken	Attenuator 1	WK0602-XX	N/A	Note1	
PE	Attenuator 2	PE7005-10	N/A	Note1	
PE	Attenuator 3	PE7005- 3	N/A	Note1	
AR	Power Amplifier	5S1G4M2	0328767	Note1	
Mini-Circuits	Power Amplifier	ZVE-3W	162601250	Note1	
Mini-Circuits	Power Amplifier	ZHL-42W+	13440021344	Note1	

General Note:

1. Prior to system verification and validation, the path loss from the signal generator to the system check source and the power meter, which includes the amplifier, cable, attenuator and directional coupler, was measured by the network analyzer. The reading of the power meter was offset by the path loss difference between the path to the power meter and the path to the system check source to monitor the actual power level fed to the system check source.



10. System Verification

10.1 Tissue Verification

The following tissue formulations are provided for reference only as some of the parameters have not been thoroughly verified. The composition of ingredients may be modified accordingly to achieve the desired target tissue parameters required for routine SAR evaluation.

Frequency (MHz)	Water (%)	Sugar (%)	Cellulose (%)	Salt (%)	Preventol (%)	DGBE (%)	Conductivity (σ)	Permittivity (ϵ_r)
For Head								
750	41.1	57.0	0.2	1.4	0.2	0	0.89	41.9
835	40.3	57.9	0.2	1.4	0.2	0	0.90	41.5
900	40.3	57.9	0.2	1.4	0.2	0	0.97	41.5
1800, 1900, 2000	55.2	0	0	0.3	0	44.5	1.40	40.0
2450	55.0	0	0	0	0	45.0	1.80	39.2
2600	54.8	0	0	0.1	0	45.1	1.96	39.0
For Body								
750	51.7	47.2	0	0.9	0.1	0	0.96	55.5
835	50.8	48.2	0	0.9	0.1	0	0.97	55.2
900	50.8	48.2	0	0.9	0.1	0	1.05	55.0
1800, 1900, 2000	70.2	0	0	0.4	0	29.4	1.52	53.3
2450	68.6	0	0	0	0	31.4	1.95	52.7
2600	68.1	0	0	0.1	0	31.8	2.16	52.5

Simulating Liquid for 5GHz, Manufactured by SPEAG

Ingredients	(% by weight)
Water	64~78%
Mineral oil	11~18%
Emulsifiers	9~15%
Additives and Salt	2~3%

<Tissue Dielectric Parameter Check Results>

Frequency (MHz)	Tissue Type	Liquid Temp. (°C)	Conductivity (σ)	Permittivity (ϵ_r)	Conductivity Target (σ)	Permittivity Target (ϵ_r)	Delta (σ) (%)	Delta (ϵ_r) (%)	Limit (%)	Date
750	HSL	22.5	0.879	40.711	0.89	41.90	-1.24	-2.84	±5	2014/12/22
750	MSL	22.6	0.966	53.934	0.96	55.50	0.63	-2.82	±5	2014/12/23
750	MSL	22.6	0.971	54.159	0.96	55.50	1.15	-2.42	±5	2014/12/29
835	HSL	22.4	0.902	43.342	0.90	41.50	0.22	4.44	±5	2014/12/22
835	MSL	22.3	0.964	54.475	0.97	55.20	-0.62	-1.31	±5	2014/12/23
835	MSL	22.2	0.972	53.016	0.97	55.20	0.21	-3.96	±5	2014/12/29
1900	HSL	22.6	1.378	40.752	1.40	40.00	-1.57	1.88	±5	2014/12/22
1900	MSL	22.5	1.531	52.652	1.52	53.30	0.72	-1.22	±5	2014/12/23
1900	MSL	22.4	1.534	51.986	1.52	53.30	0.92	-2.47	±5	2014/12/29

10.2 System Performance Check Results

Comparing to the original SAR value provided by SPEAG, the verification data should be within its specification of 10 %. Below table shows the target SAR and measured SAR after normalized to 1W input power. The table below indicates the system performance check can meet the variation criterion and the plots can be referred to Appendix A of this report.

Date	Frequency (MHz)	Tissue Type	Input Power (mW)	Dipole S/N	Probe S/N	DAE S/N	Measured 1g SAR (W/kg)	Targeted 1g SAR (W/kg)	Normalized 1g SAR (W/kg)	Deviation (%)
2014/12/22	750	HSL	250	D750V3-1099	EX3DV4 - SN3931	DAE3 Sn577	2.02	8.06	8.08	0.25
2014/12/23	750	MSL	250	D750V3-1099	EX3DV4 - SN3931	DAE3 Sn577	2.01	8.56	8.04	-6.07
2014/12/29	750	MSL	250	D750V3-1099	EX3DV4 - SN3955	DAE4 Sn1399	2.10	8.56	8.40	-1.87
2014/12/22	835	HSL	250	D835V2-4d162	EX3DV4 - SN3931	DAE3 Sn577	2.30	9.15	9.20	0.55
2014/12/23	835	MSL	250	D835V2-4d162	EX3DV4 - SN3931	DAE3 Sn577	2.53	9.56	10.12	5.86
2014/12/29	835	MSL	250	D835V2-4d162	EX3DV4 - SN3955	DAE4 Sn1399	2.43	9.56	9.72	1.67
2014/12/22	1900	HSL	250	D1900V2-5d182	EX3DV4 - SN3931	DAE3 Sn577	9.37	39.80	37.48	-5.83
2014/12/23	1900	MSL	250	D1900V2-5d182	EX3DV4 - SN3931	DAE3 Sn577	10.60	40.00	42.40	6.00
2014/12/29	1900	MSL	250	D1900V2-5d182	EX3DV4 - SN3955	DAE4 Sn1399	10.20	40.00	40.80	2.00

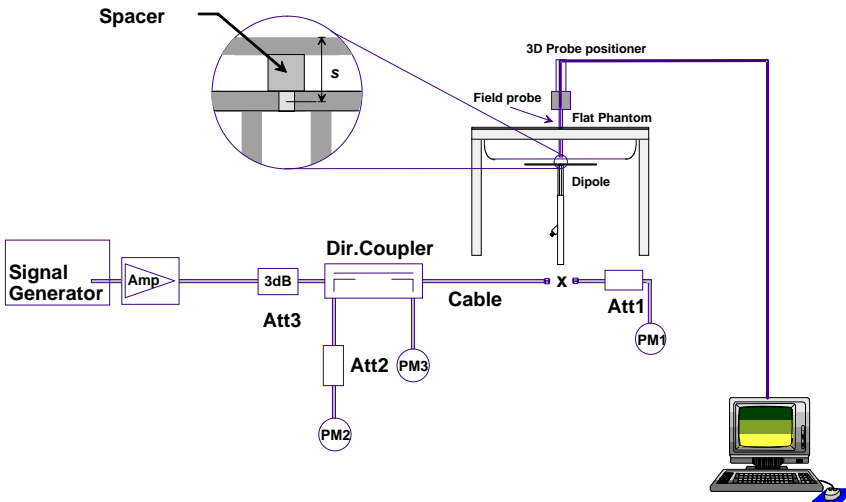

Fig 8.3.1 System Performance Check Setup



Fig 8.3.2 Setup Photo

11. RF Exposure Positions

11.1 Ear and handset reference point

Figure 9.1.1 shows the front, back, and side views of the SAM phantom. The center-of-mouth reference point is labeled "M," the left ear reference point (ERP) is marked "LE," and the right ERP is marked "RE." Each ERP is 15 mm along the B-M (back-mouth) line behind the entrance-to-ear-canal (EEC) point, as shown in Figure 9.1.2 The Reference Plane is defined as passing through the two ear reference points and point M. The line N-F (neck-front), also called the reference pivoting line, is normal to the Reference Plane and perpendicular to both a line passing through RE and LE and the B-M line (see Figure 9.1.3). Both N-F and B-M lines should be marked on the exterior of the phantom shell to facilitate handset positioning. Posterior to the N-F line the ear shape is a flat surface with 6 mm thickness at each ERP, and forward of the N-F line the ear is truncated, as illustrated in Figure 9.1.2. The ear truncation is introduced to preclude the ear lobe from interfering with handset tilt, which could lead to unstable positioning at the cheek.

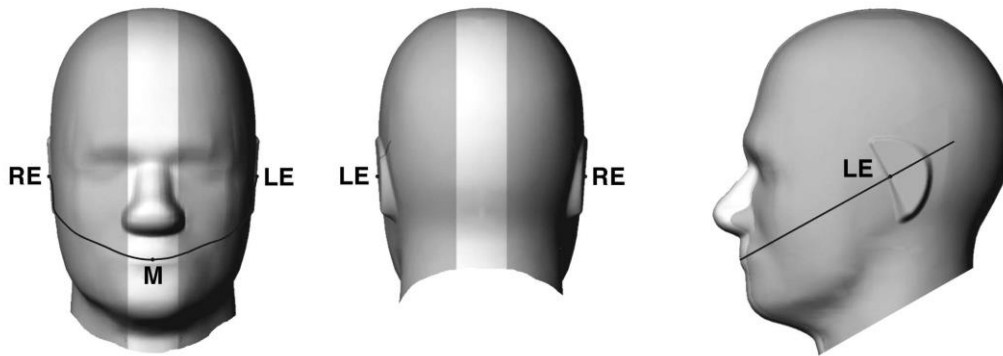

Fig 9.1.1 Front, back, and side views of SAM twin phantom

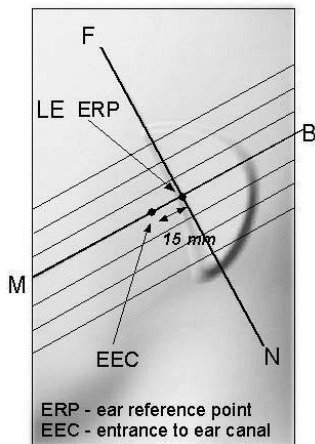

Fig 9.1.2 Close-up side view of phantom showing the ear region.

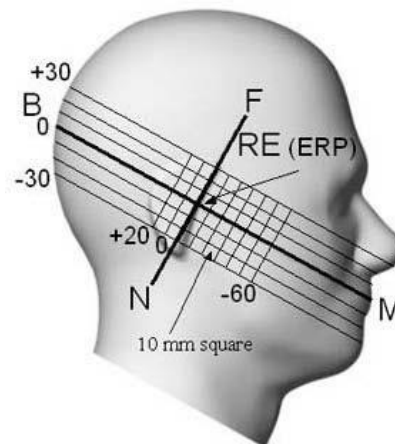

Fig 9.1.3 Side view of the phantom showing relevant markings and seven cross-sectional plane locations

11.2 Definition of the cheek position

1. Ready the handset for talk operation, if necessary. For example, for handsets with a cover piece (flip cover), open the cover. If the handset can transmit with the cover closed, both configurations must be tested.
2. Define two imaginary lines on the handset—the vertical centerline and the horizontal line. The vertical centerline passes through two points on the front side of the handset—the midpoint of the width w_t of the handset at the level of the acoustic output (point A in Figure 9.2.1 and Figure 9.2.2), and the midpoint of the width w_b of the bottom of the handset (point B). The horizontal line is perpendicular to the vertical centerline and passes through the center of the acoustic output (see Figure 9.2.1). The two lines intersect at point A. Note that for many handsets, point A coincides with the center of the acoustic output; however, the acoustic output may be located elsewhere on the horizontal line. Also note that the vertical centerline is not necessarily parallel to the front face of the handset (see Figure 9.2.2), especially for clamshell handsets, handsets with flip covers, and other irregularly-shaped handsets.
3. Position the handset close to the surface of the phantom such that point A is on the (virtual) extension of the line passing through points RE and LE on the phantom (see Figure 9.2.3), such that the plane defined by the vertical centerline and the horizontal line of the handset is approximately parallel to the sagittal plane of the phantom.
4. Translate the handset towards the phantom along the line passing through RE and LE until handset point A touches the pinna at the ERP.
5. While maintaining the handset in this plane, rotate it around the LE-RE line until the vertical centerline is in the plane normal to the plane containing B-M and N-F lines, i.e., the Reference Plane.
6. Rotate the handset around the vertical centerline until the handset (horizontal line) is parallel to the N-F line.
7. While maintaining the vertical centerline in the Reference Plane, keeping point A on the line passing through RE and LE, and maintaining the handset contact with the pinna, rotate the handset about the N-F line until any point on the handset is in contact with a phantom point below the pinna on the cheek. See Figure 9.2.3. The actual rotation angles should be documented in the test report.

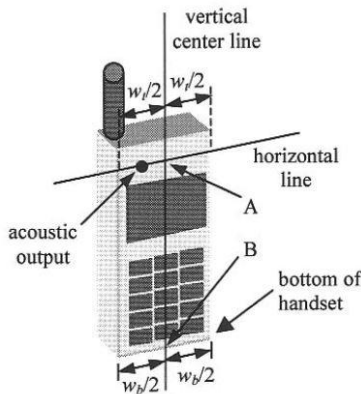

Fig 9.2.1 Handset vertical and horizontal reference lines—“fixed case”

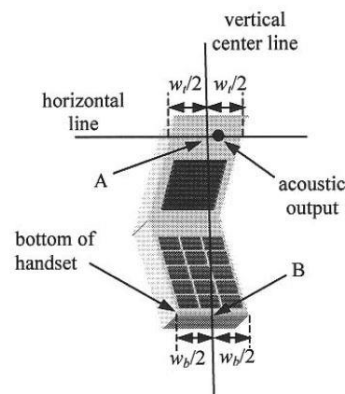

Fig 9.2.2 Handset vertical and horizontal reference lines—“clam-shell case”

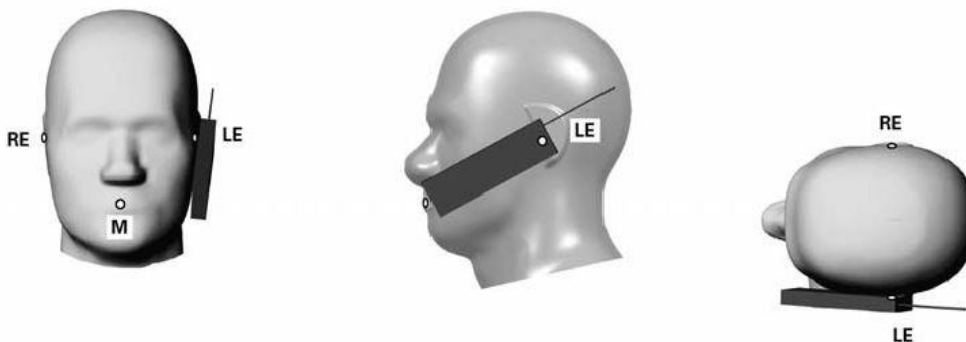

Fig 9.2.3 cheek or touch position. The reference points for the right ear (RE), left ear (LE), and mouth (M), which establish the Reference Plane for handset positioning, are indicated.

11.3 Definition of the tilt position

1. Ready the handset for talk operation, if necessary. For example, for handsets with a cover piece (flip cover), open the cover. If the handset can transmit with the cover closed, both configurations must be tested.
2. While maintaining the orientation of the handset, move the handset away from the pinna along the line passing through RE and LE far enough to allow a rotation of the handset away from the cheek by 15°.
3. Rotate the handset around the horizontal line by 15°.
4. While maintaining the orientation of the handset, move the handset towards the phantom on the line passing through RE and LE until any part of the handset touches the ear. The tilt position is obtained when the contact point is on the pinna. See Figure 9.3.1. If contact occurs at any location other than the pinna, e.g., the antenna at the back of the phantom head, the angle of the handset should be reduced. In this case, the tilt position is obtained if any point on the handset is in contact with the pinna and a second point

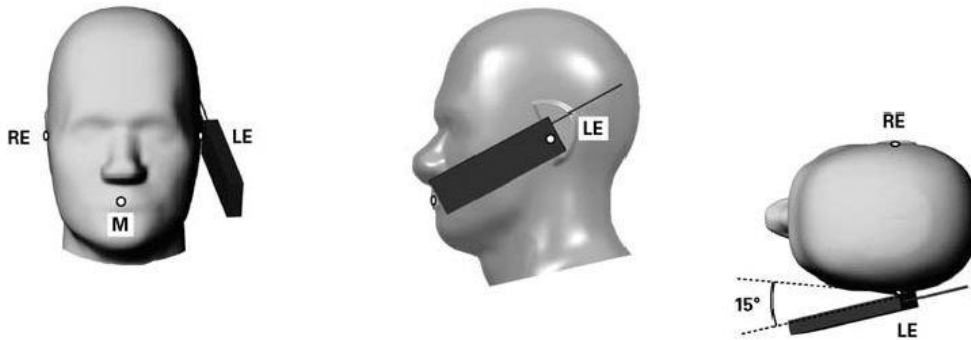

Fig 9.3.1 Tilt position. The reference points for the right ear (RE), left ear (LE), and mouth (M), which define the Reference Plane for handset positioning, are indicated.

11.4 Body Worn Accessory

Body-worn operating configurations are tested with the belt-clips and holsters attached to the device and positioned against a flat phantom in a normal use configuration (see Figure 9.4). Per KDB 648474 D04v01r02, body-worn accessory exposure is typically related to voice mode operations when handsets are carried in body-worn accessories. The body-worn accessory procedures in FCC KDB 447498 D01v05r02 should be used to test for body-worn accessory SAR compliance, without a headset connected to it. This enables the test results for such configuration to be compatible with that required for hotspot mode when the body-worn accessory test separation distance is greater than or equal to that required for hotspot mode, when applicable. When the reported SAR for body-worn accessory, measured without a headset connected to the handset is < 1.2 W/kg, the highest reported SAR configuration for that wireless mode and frequency band should be repeated for that body-worn accessory with a headset attached to the handset.

Accessories for body-worn operation configurations are divided into two categories: those that do not contain metallic components and those that do contain metallic components. When multiple accessories that do not contain metallic components are supplied with the device, the device is tested with only the accessory that dictates the closest spacing to the body. Then multiple accessories that contain metallic components are test with the device with each accessory. If multiple accessories share an identical metallic component (i.e. the same metallic belt-clip used with different holsters with no other metallic components) only the accessory that dictates the closest spacing to the body is tested.

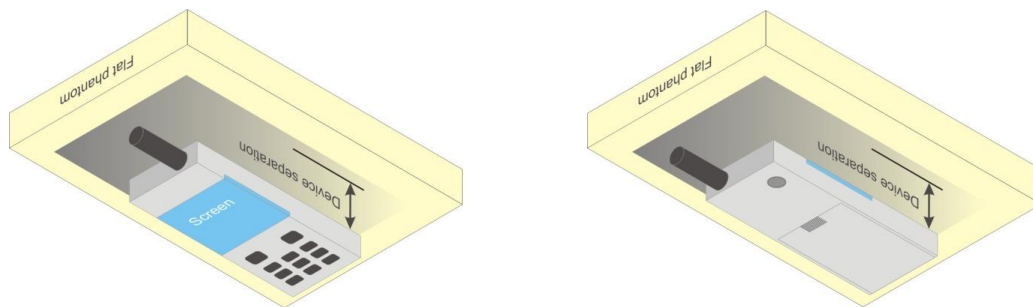

Fig 9.4 Body Worn Position

11.5 Wireless Router

Some battery-operated handsets have the capability to transmit and receive user through simultaneous transmission of WIFI simultaneously with a separate licensed transmitter. The FCC has provided guidance in FCC HDB Publication 941225 D06 v02 where SAR test considerations for handsets (L x W ≥ 9 cm x 5 cm) are based on a composite test separation distance of 10mm from the front, back and edges of the device containing transmitting antennas within 2.5cm of their edges, determined from general mixed use conditions for this type of devices. Since the hotspot SAR results may overlap with the body-worn accessory SAR requirements, the more conservative configurations can be considered, thus excluding some body-worn accessory SAR tests.

When the user enables the personal wireless router functions for the handset, actual operations include simultaneous transmission of both the WIFI transmitter and another licensed transmitter. Both transmitters often do not transmit at the same transmitting frequency and thus cannot be evaluated for SAR under actual use conditions due to the limitations of the SAR assessment probes. Therefore, SAR must be evaluated for each frequency transmission and mode separately and spatially summed with the WIFI transmitter according to FCC KDB Publication 447498 D01v05r02 publication procedures. The "Portable Hotspot" feature on the handset was NOT activated during SAR assessments, to ensure the SAR measurements were evaluated for a single transmission frequency RF signal at a time.



12. Conducted RF Output Power (Unit: dBm)

<CDMA2000 Conducted Power>

General Note:

1. Per KDB 941225 D01v03, SAR for head exposure is measured in RC3 with the handset configured to transmit at full rate in SO55.
2. Per KDB 941225 D01v03, in Hotspot mode EUT is treated as data device and SAR is tested with Ev-Do Rev 0 (RTAP 153.6kbps) as the primary mode.
3. Per KDB 941225 D01v03, for Body-worn accessory SAR is measured in RC3 with the handset configured in TDSO/SO32 to transmit at full rate on FCH only with all other code channels disabled. The body-worn accessory procedures in KDB Publication 447498 are applied. The 3G SAR test reduction procedure is applied to the multiple code channel configuration (FCH+SCH), with FCH only as the primary mode.

Band	CDMA2000 BC1			CDMA2000 BC0		
TX Channel	25	600	1175	1013	384	777
Frequency (MHz)	1851.25	1880	1908.75	824.7	836.52	848.31
1xRTT RC1 SO55	23.63	23.63	23.49	24.33	24.40	24.27
1xRTT RC3 SO55	23.67	23.64	23.59	24.13	24.26	24.25
1xRTT RC3 SO32(+ F-SCH)	23.70	23.68	23.59	24.25	24.23	24.21
1xRTT RC3 SO32(+SCH)	23.91	23.78	23.32	24.25	24.32	24.41
1xEVDO RTAP 153.6Kbps	23.79	23.72	23.72	24.34	24.18	24.40
1xEVDO RETAP 4096Bits	23.82	23.68	23.69	24.20	24.35	24.28



<LTE Conducted Power>

General Note:

1. Anritsu MT8820C base station simulator was used to setup the connection with EUT; the frequency band, channel bandwidth, RB allocation configuration, modulation type are set in the base station simulator to configure EUT transmitting at maximum power and at different configurations which are requested to be reported to FCC, for conducted power measurement and SAR testing.
2. Per KDB 941225 D05v02r03, when a properly configured base station simulator is used for the SAR and power measurements, spectrum plots for each RB allocation and offset configuration is not required.
3. Per KDB 941225 D05v02r03, start with the largest channel bandwidth and measure SAR for QPSK with 1 RB allocation, using the RB offset and required test channel combination with the highest maximum output power for RB offsets at the upper edge, middle and lower edge of each required test channel.
4. Per KDB 941225 D05v02r03, 50% RB allocation for QPSK SAR testing follows 1RB QPSK allocation procedure.
5. Per KDB 941225 D05v02r03, For QPSK with 100% RB allocation, SAR is not required when the highest maximum output power for 100 % RB allocation is less than the highest maximum output power in 50% and 1 RB allocations and the highest reported SAR for 1 RB and 50% RB allocation are ≤ 0.8 W/kg. Otherwise, SAR is measured for the highest output power channel; and if the reported SAR is > 1.45 W/kg, the remaining required test channels must also be tested.
6. Per KDB 941225 D05v02r03, 16QAM output power for each RB allocation configuration is $>$ not $\frac{1}{2}$ dB higher than the same configuration in QPSK and the reported SAR for the QPSK configuration is ≤ 1.45 W/kg; Per KDB 941225 D05v02r03, 16QAM SAR testing is not required.
7. Per KDB 941225 D05v02r03, Smaller bandwidth output power for each RB allocation configuration is $>$ not $\frac{1}{2}$ dB higher than the same configuration in the largest supported bandwidth, and the reported SAR for the largest supported bandwidth is ≤ 1.45 W/kg; Per KDB 941225 D05v02r03, smaller bandwidth SAR testing is not required.



<LTE Band 13>

BW [MHz]	Modulation	RB Size	RB Offset	Power Low Ch. / Freq.	Power Middle Ch. / Freq.	Power High Ch. / Freq.	Tune up Limit (dBm)	MPR (dB)
Channel					23230			
Frequency (MHz)					782			
10	QPSK	1	0		22.94		24	0
10	QPSK	1	24		22.80			
10	QPSK	1	49		22.45			
10	QPSK	25	0		21.78		23	0-1
10	QPSK	25	12		21.66			
10	QPSK	25	24		21.62			
10	QPSK	50	0		21.64			
10	16QAM	1	0		22.66		23	0-1
10	16QAM	1	24		22.34			
10	16QAM	1	49		22.29			
10	16QAM	25	0		20.84		22	0-2
10	16QAM	25	12		20.62			
10	16QAM	25	24		20.68			
10	16QAM	50	0		20.63			
Channel				23205	23230	23255	Tune up Limit (dBm)	MPR (dB)
Frequency (MHz)				779.5	782	784.5		
5	QPSK	1	0	22.61	22.60	22.34	24	0
5	QPSK	1	12	22.88	22.56	22.85		
5	QPSK	1	24	22.66	22.35	22.37		
5	QPSK	12	0	21.80	21.70	21.60	23	0-1
5	QPSK	12	6	21.85	21.63	21.73		
5	QPSK	12	11	21.70	21.55	21.75		
5	QPSK	25	0	21.71	21.58	21.61	23	0-1
5	16QAM	1	0	21.99	22.02	21.53		
5	16QAM	1	12	22.17	22.02	21.75		
5	16QAM	1	24	21.79	21.65	21.52		
5	16QAM	12	0	20.73	20.63	20.52	22	0-2
5	16QAM	12	6	20.66	20.51	20.41		
5	16QAM	12	11	20.67	20.49	20.54		
5	16QAM	12	11	20.67	20.49	20.54		
5	16QAM	25	0	20.66	20.54	20.72		

13. Antenna Location

<Mobile Phone>

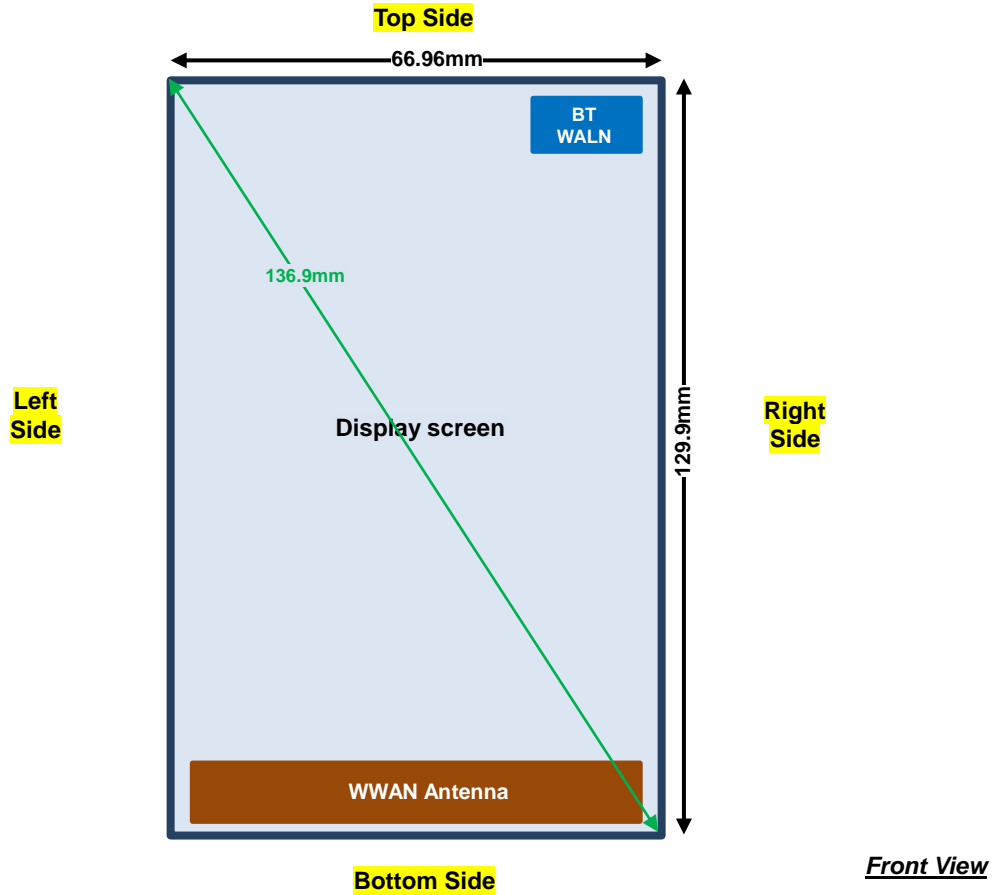

Distance of the Antenna to the EUT surface/edge						
Antennas	Back	Front	Top Side	Bottom Side	Right Side	Left Side
WWAN	≤ 25mm	≤ 25mm	> 25mm	≤ 25mm	≤ 25mm	≤ 25mm
Positions for SAR tests; Hotspot mode						
Antennas	Back	Front	Top Side	Bottom Side	Right Side	Left Side
WWAN	Yes	Yes	No	Yes	Yes	Yes

General Note:

- Referring to KDB 941225 D06 v02, when the overall device length and width are ≥ 9cm*5cm, the test distance is 10 mm. SAR must be measured for all sides and surfaces with a transmitting antenna located within 25mm from that surface or edge.



14. SAR Test Results

General Note:

1. Per KDB 447498 D01v05r02, the reported SAR is the measured SAR value adjusted for maximum tune-up tolerance.
 - a. Tune-up scaling Factor = tune-up limit power (mW) / EUT RF power (mW), where tune-up limit is the maximum rated power among all production units.
 - b. For WWAN: Reported SAR(W/kg)= Measured SAR(W/kg)*Tune-up Scaling Factor
2. Per KDB 447498 D01v05r02, for each exposure position, testing of other required channels within the operating mode of a frequency band is not required when the *reported* 1-g or 10-g SAR for the mid-band or highest output power channel is:
 - ≤ 0.8 W/kg or 2.0 W/kg, for 1-g or 10-g respectively, when the transmission band is ≤ 100 MHz
 - ≤ 0.6 W/kg or 1.5 W/kg, for 1-g or 10-g respectively, when the transmission band is between 100 MHz and 200 MHz
 - ≤ 0.4 W/kg or 1.0 W/kg, for 1-g or 10-g respectively, when the transmission band is ≥ 200 MHz
3. Per KDB 941225 D01v03, SAR for head exposure is measured in RC3 with the handset configured to transmit at full rate in SO55.
4. Per KDB 941225 D01v03, in Hotspot mode EUT is treated as data device and SAR is tested with Ev-Do Rev 0 (RTAP 153.6kbps) as the primary mode.
5. Per KDB 941225 D01v03, for Body-worn accessory SAR is measured in RC3 with the handset configured in TDSO/SO32 to transmit at full rate on FCH only with all other code channels disabled. The body-worn accessory procedures in KDB Publication 447498 are applied. The 3G SAR test reduction procedure is applied to the multiple code channel configuration (FCH+SCH), with FCH only as the primary mode.
6. Per KDB 941225 D05v02r03, start with the largest channel bandwidth and measure SAR for QPSK with 1 RB allocation, using the RB offset and required test channel combination with the highest maximum output power for RB offsets at the upper edge, middle and lower edge of each required test channel.
7. Per KDB 941225 D05v02r03, 50% RB allocation for QPSK SAR testing follows 1RB QPSK allocation procedure.
8. Per KDB 941225 D05v02r03, For QPSK with 100% RB allocation, SAR is not required when the highest maximum output power for 100 % RB allocation is less than the highest maximum output power in 50% and 1 RB allocations and the highest reported SAR for 1 RB and 50% RB allocation are ≤ 0.8 W/kg. Otherwise, SAR is measured for the highest output power channel; and if the reported SAR is > 1.45 W/kg, the remaining required test channels must also be tested.
9. Per KDB 941225 D05v02r03, 16QAM output power for each RB allocation configuration is > not ½ dB higher than the same configuration in QPSK and the reported SAR for the QPSK configuration is ≤ 1.45 W/kg; Per KDB 941225 D05v02r03, 16QAM SAR testing is not required.
10. Per KDB 941225 D05v02r03, Smaller bandwidth output power for each RB allocation configuration is > not ½ dB higher than the same configuration in the largest supported bandwidth, and the reported SAR for the largest supported bandwidth is ≤ 1.45 W/kg; Per KDB 941225 D05v02r03, smaller bandwidth SAR testing is not required.
11. Per KDB 648474 D04v01r02, when the reported SAR for a body-worn accessory measured without a headset connected to the handset is < 1.2 W/kg, SAR testing with a headset connected to the handset is not required.

14.1 Head SAR

<CDMA SAR>

Plot No.	Band	Mode	Test Position	Ch.	Freq. (MHz)	Average Power (dBm)	Tune-Up Limit (dBm)	Tune-up Scaling Factor	Power Drift (dB)	Measured 1g SAR (W/kg)	Reported 1g SAR (W/kg)
	CDMA BC0	1xRTT RC3 SO55	Right Cheek	384	836.52	24.26	25.00	1.186	-0.04	0.367	0.435
	CDMA BC0	1xRTT RC3 SO55	Right Tilted	384	836.52	24.26	25.00	1.186	-0.04	0.253	0.300
1	CDMA BC0	1xRTT RC3 SO55	Left Cheek	384	836.52	24.26	25.00	1.186	0.06	0.414	0.491
	CDMA BC0	1xRTT RC3 SO55	Left Tilted	384	836.52	24.26	25.00	1.186	-0.02	0.238	0.282
	CDMA BC1	1xRTT RC3 SO55	Right Cheek	25	1851.25	23.67	25.00	1.358	0.06	0.540	0.733
	CDMA BC1	1xRTT RC3 SO55	Right Tilted	25	1851.25	23.67	25.00	1.358	-0.05	0.270	0.367
2	CDMA BC1	1xRTT RC3 SO55	Left Cheek	25	1851.25	23.67	25.00	1.358	-0.06	0.743	1.009
	CDMA BC1	1xRTT RC3 SO55	Left Cheek	600	1880	23.64	25.00	1.368	-0.12	0.528	0.722
	CDMA BC1	1xRTT RC3 SO55	Left Cheek	1175	1908.75	23.59	25.00	1.384	-0.14	0.461	0.638
	CDMA BC1	1xRTT RC3 SO55	Left Tilted	25	1851.25	23.67	25.00	1.358	0.01	0.219	0.297



<LTE SAR>

Plot No.	Band	BW (MHz)	Modulation	RB Size	RB offset	Test Position	Ch.	Freq. (MHz)	Average Power (dBm)	Tune-Up Limit (dBm)	Tune-up Scaling Factor	Power Drift (dB)	Measured 1g SAR (W/kg)	Reported 1g SAR (W/kg)
3	LTE Band 13	10M	QPSK	1RB	0offset	Right Cheek	23230	782	22.94	24.00	1.276	-0.12	0.367	0.468
	LTE Band 13	10M	QPSK	25RB	0offset	Right Cheek	23230	782	21.78	23.00	1.324	-0.06	0.238	0.315
	LTE Band 13	10M	QPSK	1RB	0offset	Right Tilted	23230	782	22.94	24.00	1.276	0.04	0.158	0.202
	LTE Band 13	10M	QPSK	25RB	0offset	Right Tilted	23230	782	21.78	23.00	1.324	-0.16	0.099	0.131
	LTE Band 13	10M	QPSK	1RB	0offset	Left Cheek	23230	782	22.94	24.00	1.276	0.11	0.218	0.278
	LTE Band 13	10M	QPSK	25RB	0offset	Left Cheek	23230	782	21.78	23.00	1.324	-0.06	0.127	0.168
	LTE Band 13	10M	QPSK	1RB	0offset	Left Tilted	23230	782	22.94	24.00	1.276	-0.18	0.132	0.168
	LTE Band 13	10M	QPSK	25RB	0offset	Left Tilted	23230	782	21.78	23.00	1.324	-0.11	0.083	0.110

14.2 Hotspot SAR

<CDMA SAR>

Plot No.	Band	Mode	Test Position	Gap (cm)	Power Reduction	Ch.	Freq. (MHz)	Average Power (dBm)	Tune-Up Limit (dBm)	Tune-up Scaling Factor	Power Drift (dB)	Measured 1g SAR (W/kg)	Reported 1g SAR (W/kg)
	CDMA BC0	RTAP 153.6Kbps	Front	1cm	-	777	848.31	24.40	25.00	1.148	-0.02	0.598	0.687
	CDMA BC0	RTAP 153.6Kbps	Back	1cm	-	777	848.31	24.40	25.00	1.148	0	0.713	0.819
	CDMA BC0	RTAP 153.6Kbps	Back	1cm	-	1013	824.7	24.34	25.00	1.164	0.05	0.557	0.648
4	CDMA BC0	RTAP 153.6Kbps	Back	1cm	-	384	836.52	24.18	25.00	1.208	-0.1	0.765	0.924
	CDMA BC0	RTAP 153.6Kbps	Left Side	1cm	-	777	848.31	24.40	25.00	1.148	-0.03	0.564	0.648
	CDMA BC0	RTAP 153.6Kbps	Right Side	1cm	-	777	848.31	24.40	25.00	1.148	-0.06	0.300	0.344
	CDMA BC0	RTAP 153.6Kbps	Bottom Side	1cm	-	777	848.31	24.40	25.00	1.148	0.11	0.158	0.181
	CDMA BC1	RTAP 153.6Kbps	Front	1cm	ON	25	1851.25		22.00	1.000	0.04	0.771	0.771
	CDMA BC1	RTAP 153.6Kbps	Back	1cm	ON	25	1851.25		22.00	1.000	0.03	0.633	0.633
	CDMA BC1	RTAP 153.6Kbps	Left Side	1cm	ON	25	1851.25		22.00	1.000	0.1	0.302	0.302
	CDMA BC1	RTAP 153.6Kbps	Right Side	1cm	ON	25	1851.25		22.00	1.000	-0.1	0.100	0.100
	CDMA BC1	RTAP 153.6Kbps	Bottom Side	1cm	ON	25	1851.25		22.00	1.000	0.08	0.831	0.831
	CDMA BC1	RTAP 153.6Kbps	Bottom Side	1cm	ON	600	1880		22.00	1.000	0.14	0.825	0.825
5	CDMA BC1	RTAP 153.6Kbps	Bottom Side	1cm	ON	1175	1908.75		22.00	1.000	0.16	0.859	0.859

<LTE SAR>

Plot No.	Band	BW (MHz)	Modulation	RB Size	RB offset	Test Position	Gap (cm)	Ch.	Freq. (MHz)	Average Power (dBm)	Tune-Up Limit (dBm)	Tune-up Scaling Factor	Power Drift (dB)	Measured 1g SAR (W/kg)	Reported 1g SAR (W/kg)
	LTE Band 13	10M	QPSK	1RB	0offset	Front	1cm	23230	782	22.94	24.00	1.276	-0.03	0.310	0.396
	LTE Band 13	10M	QPSK	25RB	0offset	Front	1cm	23230	782	21.78	23.00	1.324	-0.02	0.192	0.254
6	LTE Band 13	10M	QPSK	1RB	0offset	Back	1cm	23230	782	22.94	24.00	1.276	-0.01	0.324	0.414
	LTE Band 13	10M	QPSK	25RB	0offset	Back	1cm	23230	782	21.78	23.00	1.324	-0.05	0.212	0.281
	LTE Band 13	10M	QPSK	1RB	0offset	Left Side	1cm	23230	782	22.94	24.00	1.276	0.05	0.075	0.096
	LTE Band 13	10M	QPSK	25RB	0offset	Left Side	1cm	23230	782	21.78	23.00	1.324	-0.02	0.049	0.065
	LTE Band 13	10M	QPSK	1RB	0offset	Right Side	1cm	23230	782	22.94	24.00	1.276	-0.03	0.272	0.347
	LTE Band 13	10M	QPSK	25RB	0offset	Right Side	1cm	23230	782	21.78	23.00	1.324	-0.03	0.177	0.234
	LTE Band 13	10M	QPSK	1RB	0offset	Bottom Side	1cm	23230	782	22.94	24.00	1.276	-0.01	0.165	0.211
	LTE Band 13	10M	QPSK	25RB	0offset	Bottom Side	1cm	23230	782	21.78	23.00	1.324	-0.07	0.097	0.128



14.3 Body Worn Accessory SAR

<CDMA SAR>

Plot No.	Band	Mode	Test Position	Gap (cm)	Ch.	Freq. (MHz)	Average Power (dBm)	Tune-Up Limit (dBm)	Tune-up Scaling Factor	Power Drift (dB)	Measured 1g SAR (W/kg)	Reported 1g SAR (W/kg)
	CDMA BC0	1xRTT RC3 SO32	Front	1.5cm	1013	824.7	24.25	25.00	1.189	0	0.532	0.632
7	CDMA BC0	1xRTT RC3 SO32	Back	1.5cm	1013	824.7	24.25	25.00	1.189	-0.02	0.575	0.683
8	CDMA BC1	1xRTT RC3 SO32	Front	1.5cm	25	1851.25	23.70	25.00	1.349	0.02	0.608	0.820
	CDMA BC1	1xRTT RC3 SO32	Front	1.5cm	600	1880	23.68	25.00	1.355	-0.06	0.569	0.771
	CDMA BC1	1xRTT RC3 SO32	Front	1.5cm	1175	1908.75	23.59	25.00	1.384	-0.06	0.581	0.804
	CDMA BC1	1xRTT RC3 SO32	Back	1.5cm	25	1851.25	23.70	25.00	1.349	-0.06	0.537	0.724

<LTE SAR>

Plot No.	Band	BW (MHz)	Modulation	RB Size	RB offset	Test Position	Gap (cm)	Ch.	Freq. (MHz)	Average Power (dBm)	Tune-Up Limit (dBm)	Tune-up Scaling Factor	Power Drift (dB)	Measured 1g SAR (W/kg)	Reported 1g SAR (W/kg)
	LTE Band 13	10M	QPSK	1RB	Offset	Front	1.5cm	23230	782	22.94	24.00	1.276	-0.11	0.214	0.273
	LTE Band 13	10M	QPSK	25RB	Offset	Front	1.5cm	23230	782	21.78	23.00	1.324	-0.07	0.132	0.175
9	LTE Band 13	10M	QPSK	1RB	Offset	Back	1.5cm	23230	782	22.94	24.00	1.276	0.14	0.223	0.285
	LTE Band 13	10M	QPSK	25RB	Offset	Back	1.5cm	23230	782	21.78	23.00	1.324	-0.04	0.139	0.184

14.4 Repeated SAR Measurement

No.	Band	Mode	Test Position	Gap (cm)	Power Reduction	Ch.	Freq. (MHz)	Average Power (dBm)	Tune-Up Limit (dBm)	Tune-up Scaling Factor	Power Drift (dB)	Measured 1g SAR (W/kg)	Ratio	Reported 1g SAR (W/kg)
1st	CDMA BC1	RTAP 153.6Kbps	Bottom Side	1cm	ON	1175	1908.75		22.00	1.000	0.16	0.859	-	0.859
2nd	CDMA BC1	RTAP 153.6Kbps	Bottom Side	1cm	ON	1175	1908.75		22.00	1.000	-0.07	0.855	1.01	0.855

General Note:

- Per KDB 865664 D01v01r03, for each frequency band, repeated SAR measurement is required only when the measured SAR is $\geq 0.8W/kg$
- Per KDB 865664 D01v01r03, if the ratio among the repeated measurement is ≤ 1.2 and the measured SAR $< 1.45W/kg$, only one repeated measurement is required.
- The ratio is the difference in percentage between original and repeated *measured* SAR.
- All measurement SAR result is scaled-up to account for tune-up tolerance and is compliant.

15. Simultaneous Transmission Analysis

NO.	Simultaneous Transmission Configurations	Portable Handset			Note
		Head	Body-worn	Hotspot	
1.	GSM(Voice) + WLAN2.4GHz(data)	Yes	Yes		
2.	WCDMA(Voice) + WLAN2.4GHz(data)	Yes	Yes		
3.	CDMA(Voice) + WLAN2.4GHz(data)	Yes	Yes		
4.	GSM(Voice) + Bluetooth(data)	Yes	Yes		
5.	WCDMA((Voice) + Bluetooth(data)	Yes	Yes		
6.	CDMA((Voice) + Bluetooth(data)	Yes	Yes		
7.	GPRS/EDGE(Data) + WLAN2.4GHz(data)	Yes	Yes	Yes	2.4GHz Hotspot
8.	WCDMA(Data) + WLAN2.4GHz(data)	Yes	Yes	Yes	2.4GHz Hotspot
9.	CDMA(Data) + WLAN2.4GHz(data)	Yes	Yes	Yes	2.4GHz Hotspot
10.	LTE(Data) + WLAN2.4GHz(data)	Yes	Yes	Yes	2.4GHz Hotspot
11.	GPRS/EDGE(Data) + Bluetooth(data)	Yes	Yes	Yes	Bluetooth Tethering
12.	WCDMA(Data) + Bluetooth(data)	Yes	Yes	Yes	Bluetooth Tethering
13.	CDMA(Data) + Bluetooth(data)	Yes	Yes	Yes	Bluetooth Tethering
14.	LTE(Data) + Bluetooth(data)	Yes	Yes	Yes	Bluetooth Tethering

General Note:

1. The 2.4GHz WLAN and Bluetooth conducted power and SAR testing results were referred to Sporton FCC SAR Test Report, Brand Name: Motorola, Model Name: 4060, FCC ID: IHDT56QC4, Report No: FA4N1482-01 or Appendix D and also used perform transmission simultaneous analysis.
2. This device supported VoIP in EGPRS, CDMA, WCDMA, LTE (e.g. 3rd party VoIP).
3. The Scaled SAR summation is calculated based on the same configuration and test position.
4. Per KDB 447498 D01v05r02, simultaneous transmission SAR is compliant if,
 - i) Scalar SAR summation < 1.6W/kg.
 - ii) $SPLSR = (SAR1 + SAR2)^{1.5} / (\text{min. separation distance, mm})$, and the peak separation distance is determined from the square root of $[(x1-x2)^2 + (y1-y2)^2 + (z1-z2)^2]$, where (x1, y1, z1) and (x2, y2, z2) are the coordinates of the extrapolated peak SAR locations in the zoom scan.
 - iii) If $SPLSR \leq 0.04$, simultaneously transmission SAR measurement is not necessary.
 - iv) Simultaneously transmission SAR measurement, and the reported multi-band SAR < 1.6W/kg.
 - v) The SPLSR calculated results please refer to section 15.4.

15.1 Head Exposure Conditions

WWAN Band	Exposure Position	1	2	3	1+2 Summed 1g SAR (W/kg)	1+3 Summed 1g SAR (W/kg)	SPLSR	Case No	
		WWAN	2.4GHz WLAN	2.4GHz Bluetooth					
		1g SAR (W/kg)	1g SAR (W/kg)	1g SAR (W/kg)					
CDMA	BC0	Right Cheek	0.435	0.535	0.086	0.97	0.52		
		Right Tilted	0.300	0.504	0.081	0.80	0.38		
		Left Cheek	0.491	0.891	0.153	1.38	0.64		
		Left Tilted	0.282	0.589	0.101	0.87	0.38		
	BC1	Right Cheek	0.733	0.535	0.086	1.27	0.82		
		Right Tilted	0.367	0.504	0.081	0.87	0.45		
		Left Cheek	1.009	0.891	0.153	1.90	1.16	0.04	Case 1
		Left Tilted	0.297	0.589	0.101	0.89	0.40		
LTE	Band 13	Right Cheek	0.468	0.535	0.086	1.00	0.55		
		Right Tilted	0.202	0.504	0.081	0.71	0.28		
		Left Cheek	0.278	0.891	0.153	1.17	0.43		
		Left Tilted	0.168	0.589	0.101	0.76	0.27		

15.2 Hotspot Exposure Conditions

WWAN Band	Exposure Position	1	2	3	1+2 Summed 1g SAR (W/kg)	1+3 Summed 1g SAR (W/kg)	SPLSR	Case No	
		WWAN	2.4GHz WLAN	2.4GHz Bluetooth					
		1g SAR (W/kg)	1g SAR (W/kg)	1g SAR (W/kg)					
CDMA	BC0	Front	0.687	0.150	0.022	0.84	0.71		
		Back	0.924	0.110	0.017	1.03	0.94		
		Left side	0.648			0.65	0.65		
		Right side	0.344	0.064	0.010	0.41	0.35		
		Top side		0.113	0.014	0.11	0.01		
		Bottom side	0.181			0.18	0.18		
	BC1	Front	0.771	0.150	0.022	0.92	0.79		
		Back	0.633	0.110	0.017	0.74	0.65		
		Left side	0.302			0.30	0.30		
		Right side	0.100	0.064	0.010	0.16	0.11		
		Top side		0.113	0.014	0.11	0.01		
		Bottom side	0.859			0.86	0.86		
LTE	Band 13	Front	0.396	0.150	0.022	0.55	0.42		
		Back	0.414	0.110	0.017	0.52	0.43		
		Left side	0.096			0.10	0.10		
		Right side	0.347	0.064	0.010	0.41	0.36		
		Top side		0.113	0.014	0.11	0.01		
		Bottom side	0.211			0.21	0.21		

15.3 Body-Worn Accessory Exposure Conditions

WWAN Band	Exposure Position	1	2	3	1+2 Summed 1g SAR (W/kg)	1+3 Summed 1g SAR (W/kg)	SPLSR	Case No	
		WWAN	2.4GHz WLAN	2.4GHz Bluetooth					
		1g SAR (W/kg)	1g SAR (W/kg)	1g SAR (W/kg)					
CDMA	BC0	Front	0.632	0.087	0.011	0.72	0.64		
		Back	0.683	0.060	0.007	0.74	0.69		
	BC1	Front	0.820	0.087	0.011	0.91	0.83		
		Back	0.724	0.060	0.007	0.78	0.73		
LTE	Band 13	Front	0.273	0.087	0.011	0.36	0.28		
		Back	0.285	0.060	0.007	0.35	0.29		

15.4 SPLSR Evaluation and Analysis

General Note:

- SPLSR = $(SAR_1 + SAR_2)^{1.5} / (min. \text{ separation distance, mm})$. If SPLSR ≤ 0.04 , simultaneously transmission SAR measurement is not necessary

Case 1	Band	Position	SAR (W/kg)	Gap (cm)	SAR peak location (m)			3D distance (mm)	Summed SAR (W/kg)	SPLSR Results	Simultaneous SAR
					X	Y	Z				
Case 1	CDMA BC1	Left Cheek	1.009	-	0.0592	0.259	-0.173	71.8	1.90	0.04	Not required
	WLAN2.4		0.891	-	0.0267	0.323	-0.172				

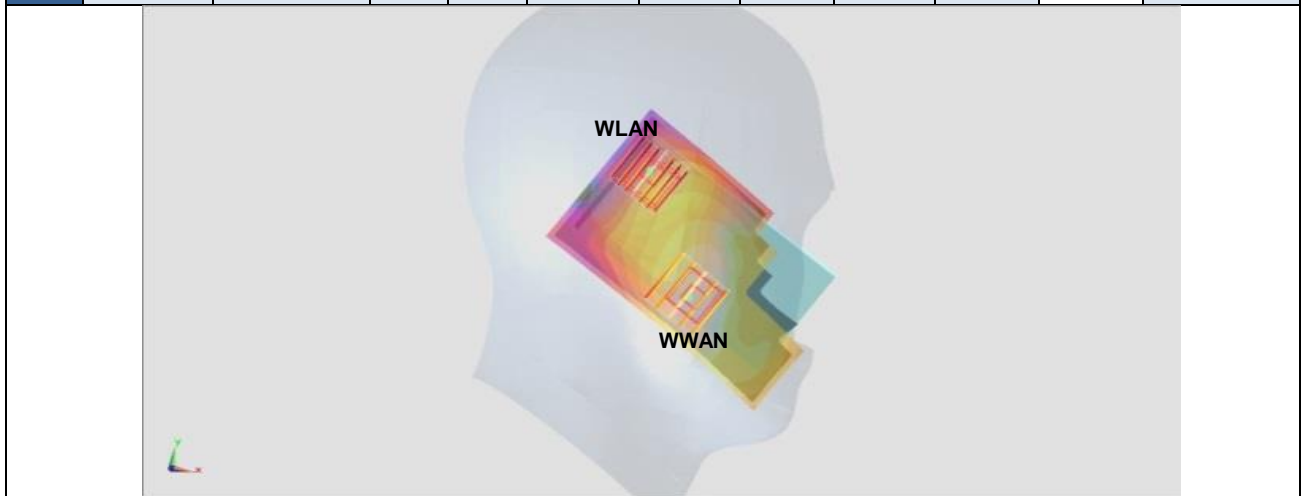

Test Engineer : Vic Yang, Thomas Wang, Lawrence Chen, and Nick Yu

16. Uncertainty Assessment

The component of uncertainty may generally be categorized according to the methods used to evaluate them. The evaluation of uncertainty by the statistical analysis of a series of observations is termed a Type A evaluation of uncertainty. The evaluation of uncertainty by means other than the statistical analysis of a series of observation is termed a Type B evaluation of uncertainty. Each component of uncertainty, however evaluated, is represented by an estimated standard deviation, termed standard uncertainty, which is determined by the positive square root of the estimated variance.

A Type A evaluation of standard uncertainty may be based on any valid statistical method for treating data. This includes calculating the standard deviation of the mean of a series of independent observations; using the method of least squares to fit a curve to the data in order to estimate the parameter of the curve and their standard deviations; or carrying out an analysis of variance in order to identify and quantify random effects in certain kinds of measurement.

A type B evaluation of standard uncertainty is typically based on scientific judgment using all of the relevant information available. These may include previous measurement data, experience, and knowledge of the behavior and properties of relevant materials and instruments, manufacture’s specification, data provided in calibration reports and uncertainties assigned to reference data taken from handbooks. Broadly speaking, the uncertainty is either obtained from an outdoor source or obtained from an assumed distribution, such as the normal distribution, rectangular or triangular distributions indicated in table below.

Uncertainty Distributions	Normal	Rectangular	Triangular	U-Shape
Multi-plying Factor ^(a)	1/k ^(b)	1/√3	1/√6	1/√2

(a) standard uncertainty is determined as the product of the multiplying factor and the estimated range of variations in the measured quantity

(b) κ is the coverage factor

Table 16.1. Standard Uncertainty for Assumed Distribution

The combined standard uncertainty of the measurement result represents the estimated standard deviation of the result. It is obtained by combining the individual standard uncertainties of both Type A and Type B evaluation using the usual “root-sum-squares” (RSS) methods of combining standard deviations by taking the positive square root of the estimated variances.

Expanded uncertainty is a measure of uncertainty that defines an interval about the measurement result within which the measured value is confidently believed to lie. It is obtained by multiplying the combined standard uncertainty by a coverage factor. Typically, the coverage factor ranges from 2 to 3. Using a coverage factor allows the true value of a measured quantity to be specified with a defined probability within the specified uncertainty range. For purpose of this document, a coverage factor two is used, which corresponds to confidence interval of about 95 %. The DASY uncertainty Budget is shown in the following tables.

Error Description	Uncertainty Value (±%)	Probability Distribution	Divisor	Ci (1g)	Ci (10g)	Standard Uncertainty (1g)	Standard Uncertainty (10g)
Measurement System							
Probe Calibration	6.0	Normal	1	1	1	± 6.0 %	± 6.0 %
Axial Isotropy	4.7	Rectangular	√3	0.7	0.7	± 1.9 %	± 1.9 %
Hemispherical Isotropy	9.6	Rectangular	√3	0.7	0.7	± 3.9 %	± 3.9 %
Boundary Effects	1.0	Rectangular	√3	1	1	± 0.6 %	± 0.6 %
Linearity	4.7	Rectangular	√3	1	1	± 2.7 %	± 2.7 %
System Detection Limits	1.0	Rectangular	√3	1	1	± 0.6 %	± 0.6 %
Readout Electronics	0.3	Normal	1	1	1	± 0.3 %	± 0.3 %
Response Time	0.8	Rectangular	√3	1	1	± 0.5 %	± 0.5 %
Integration Time	2.6	Rectangular	√3	1	1	± 1.5 %	± 1.5 %
RF Ambient Noise	3.0	Rectangular	√3	1	1	± 1.7 %	± 1.7 %
RF Ambient Reflections	3.0	Rectangular	√3	1	1	± 1.7 %	± 1.7 %
Probe Positioner	0.4	Rectangular	√3	1	1	± 0.2 %	± 0.2 %
Probe Positioning	2.9	Rectangular	√3	1	1	± 1.7 %	± 1.7 %
Max. SAR Eval.	1.0	Rectangular	√3	1	1	± 0.6 %	± 0.6 %
Test Sample Related							
Device Positioning	2.9	Normal	1	1	1	± 2.9 %	± 2.9 %
Device Holder	3.6	Normal	1	1	1	± 3.6 %	± 3.6 %
Power Drift	5.0	Rectangular	√3	1	1	± 2.9 %	± 2.9 %
Phantom and Setup							
Phantom Uncertainty	4.0	Rectangular	√3	1	1	± 2.3 %	± 2.3 %
Liquid Conductivity (Target)	5.0	Rectangular	√3	0.64	0.43	± 1.8 %	± 1.2 %
Liquid Conductivity (Meas.)	2.5	Normal	1	0.64	0.43	± 1.6 %	± 1.1 %
Liquid Permittivity (Target)	5.0	Rectangular	√3	0.6	0.49	± 1.7 %	± 1.4 %
Liquid Permittivity (Meas.)	2.5	Normal	1	0.6	0.49	± 1.5 %	± 1.2 %
Combined Standard Uncertainty						± 11.0 %	± 10.8 %
Coverage Factor for 95 %						K=2	
Expanded Uncertainty						± 22.0 %	± 21.5 %

Table 16.2. Uncertainty Budget for frequency range 300 MHz to 3 GHz



17. References

- [1] FCC 47 CFR Part 2 "Frequency Allocations and Radio Treaty Matters; General Rules and Regulations"
- [2] ANSI/IEEE Std. C95.1-1992, "IEEE Standard for Safety Levels with Respect to Human Exposure to Radio Frequency Electromagnetic Fields, 3 kHz to 300 GHz", September 1992
- [3] IEEE Std. 1528-2003, "Recommended Practice for Determining the Peak Spatial-Average Specific Absorption Rate (SAR) in the Human Head from Wireless Communications Devices: Measurement Techniques", December 2003
- [4] SPEAG DASY System Handbook
- [5] FCC KDB 248227 D01 v01r02, "SAR Measurement Procedures for 802.11 a/b/g Transmitters", May 2007
- [6] FCC KDB 447498 D01 v05r02, "Mobile and Portable Device RF Exposure Procedures and Equipment Authorization Policies", Feb 2014
- [7] FCC KDB 648474 D04 v01r02, "SAR Evaluation Considerations for Wireless Handsets", Dec 2013.
- [8] FCC KDB 941225 D01 v03, "3G SAR MEAUREMENT PROCEDURES", Oct 2014
- [9] FCC KDB 941225 D05 v02r03, "SAR Evaluation Considerations for LTE Devices", Dec 2013
- [10] FCC KDB 941225 D06 v02, "SAR Evaluation Procedures for Portable Devices with Wireless Router Capabilities", Oct 2014.
- [11] FCC KDB 865664 D01 v01r03, "SAR Measurement Requirements for 100 MHz to 6 GHz", Feb 2014.
- [12] FCC KDB 865664 D02 v01r01, "RF Exposure Compliance Reporting and Documentation Considerations" May 2013.