



FCC RF Test Report

APPLICANT : Motorola Mobility, LLC
EQUIPMENT : Mobile Cellular Phone
BRAND NAME : Motorola
MODEL NAME : 4241
FCC ID : IHDT56QC8
STANDARD : 47 CFR Part 2, 22(H), 24(E), 27
CLASSIFICATION : PCS Licensed Transmitter Held to Ear (PCE)

The product was received on Nov. 15, 2014 and completely tested on Dec. 24, 2014. We, SPORTON INTERNATIONAL INC., would like to declare that the tested sample has been evaluated in accordance with the test procedures given in ANSI / TIA / EIA-603-C-2004 and the testing has shown the tested sample to be in compliance with the applicable technical standards.

The test results in this report apply exclusively to the tested model / sample. Without written approval of SPORTON INTERNATIONAL INC., the test report shall not be reproduced except in full.

Reviewed by: Joseph Lin / Supervisor

Approved by: Jones Tsai / Manager



Testing Laboratory
1190

SPORTON INTERNATIONAL INC.

No. 52, Hwa Ya 1st Rd., Hwa Ya Technology Park, Kwei-Shan Hsiang, Tao Yuan Hsien, Taiwan, R.O.C.

SPORTON INTERNATIONAL INC.

TEL : 886-3-327-3456

FAX : 886-3-328-4978

FCC ID : IHDT56QC8

Page Number : 1 of 22

Report Issued Date : Jan. 14, 2015

Report Version : Rev. 01

Report Template No.: BU5-FGLTE Version 1.3



TABLE OF CONTENTS

REVISION HISTORY..... 3
SUMMARY OF TEST RESULT 4
1 GENERAL DESCRIPTION 6
1.1 Applicant 6
1.2 Manufacturer 6
1.3 Product Feature of Equipment Under Test..... 6
1.4 Product Specification subjective to this standard 7
1.5 Modification of EUT 7
1.6 Emission Designator 7
1.7 Testing Location 8
1.8 Applicable Standards..... 8
2 TEST CONFIGURATION OF EQUIPMENT UNDER TEST 9
2.1 Test Mode 9
2.2 Connection Diagram of Test System 10
2.3 Support Unit used in test configuration and system 10
2.4 Measurement Results Explanation Example 10
3 CONDUCTED TEST ITEMS 11
3.1 Measuring Instruments 11
3.2 Test Setup 11
3.3 Test Result of Conducted Test 12
3.4 Conducted Output Power 12
3.5 Peak-to-Average Ratio 13
3.6 Occupied Bandwidth 14
3.7 Conducted Band Edge 15
3.8 Conducted Spurious Emission 16
3.9 Frequency Stability 17
4 RADIATED TEST ITEMS 18
4.1 Measuring Instruments 18
4.2 Test Setup 18
4.3 Test Result of Radiated Test 19
4.4 Effective Radiated Power and Effective Isotropic Radiated Power 19
4.5 Radiated Spurious Emission 20
5 LIST OF MEASURING EQUIPMENT 21
6 UNCERTAINTY OF EVALUATION 22
APPENDIX A. TEST RESULTS OF CONDUCTED TEST
APPENDIX B. TEST RESULTS OF RADIATED TEST
APPENDIX C. ORIGINAL REPORT



SUMMARY OF TEST RESULT

Report Section	FCC Rule	Description	Limit	Result	Remark
3.4	§2.1046	Conducted Output Power	Reporting Only	PASS	-
3.5	§24.232(d)	Peak-to-Average Ratio	<13 dB	PASS	-
3.6	§2.1049 §22.917(b) §24.238(b) §27.53(h)(3)	Occupied Bandwidth	Reporting Only	PASS	-
3.7	§2.1051 §22.917(a) §24.238(a) §27.53(c)(2) §27.53(c)(4) §27.53(f) §27.53(g)	Conducted Band Edge Measurement (Band 2) (Band 4) (Band 5) (Band 13)	< 43+10log10(P[Watts])	PASS	-
3.8	§2.1053 §22.917(a) §24.238(a) §27.53(c)(2) §27.53(f) §27.53(g)	Conducted Spurious Emission (Band 2) (Band 4) (Band 5) (Band 13)	< 43+10log10(P[Watts])	PASS	-
3.9	§2.1055 §22.355 §24.235 §27.54	Frequency Stability Temperature & Voltage	< 2.5 ppm	PASS	-



Report Section	FCC Rule	Description	Limit	Result	Remark
4.4	§2.1053 §22.917(a) §24.238(a) §27.53(c)(2) §27.53(f) §27.53(h)	Radiated Spurious Emission (Band 2) (Band 4) (Band 5) (Band 13)	$< 43+10\log_{10}(P[\text{Watts}])$	PASS	Under limit 18.11 dB at 1560.000 MHz
4.5	§22.913(a)(2)	Effective Radiated Power (Band 5)	ERP < 7 Watt	PASS	-
	§27.50(b)(10)	Effective Radiated Power (Band 13)	ERP < 3 Watt		
	N/A	Equivalent Isotropic Radiated Power (Band 13)	EIRP < 5 Watt		
	§24.232(c)	Equivalent Isotropic Radiated Power (Band 2)	EIRP < 2Watt		
	§27.50(d)(4)	Equivalent Isotropic Radiated Power (Band 4)	EIRP < 1Watt		



1 General Description

1.1 Applicant

Motorola Mobility, LLC
222 W. Merchandise Mart Plaza, Chicago IL 60654 USA

1.2 Manufacturer

Motorola Mobility, LLC
222 W. Merchandise Mart Plaza, Chicago IL 60654 USA

1.3 Product Feature of Equipment Under Test

Product Feature	
Equipment	Mobile Cellular Phone
Brand Name	Motorola
Model Name	4241
FCC ID	IHDT56QC8
IMEI Code	990005450012555
EUT supports Radios application	CDMA/EV-DO/GSM/EGPRS/WCDMA/HSPA/LTE WLAN 11b/g/n (HT20) Bluetooth v2.1 EDR Bluetooth v4.0 - LE
HW Version	P2B
EUT Stage	Identical Prototype

Accessory List	
AC Adapter	Brand Name : Motorola
	Model Name : SPN5810A



1.4 Product Specification subjective to this standard

Product Specification subjective to this standard	
Tx Frequency	LTE Band 2 : 1850.7 MHz ~ 1909.3 MHz LTE Band 4 : 1710.7 MHz ~ 1754.3 MHz LTE Band 5 : 824.7 MHz ~ 848.3 MHz LTE Band 13 : 779.5 MHz ~ 784.5 MHz
Rx Frequency	LTE Band 2 : 1930.7 MHz ~ 1989.3 MHz LTE Band 4 : 2110.7 MHz ~ 2154.3 MHz LTE Band 5 : 869.7 MHz ~ 893.3 MHz LTE Band 13 : 748.5 MHz ~ 753.5 MHz
Bandwidth	LTE Band 2 : 1.4MHz / 3MHz / 5MHz / 10MHz / 15MHz / 20MHz LTE Band 4 : 1.4MHz / 3MHz / 5MHz / 10MHz / 15MHz / 20MHz LTE Band 5 : 1.4MHz / 3MHz / 5MHz / 10MHz LTE Band 13 : 5MHz / 10MHz
Maximum Output Power to Antenna	LTE Band 13 : 22.98 dBm
Type of Modulation	QPSK / 16QAM

Remark: The LTE Band2, Band4 and Band5 test results refer to appendix C.

1.5 Modification of EUT

No modifications are made to the EUT during all test items.

1.6 Emission Designator

LTE Band 13	QPSK			16QAM		
	Emission Designator (99%OBW)	Frequency Tolerance (ppm)	Maximum ERP(W)	Emission Designator (99%OBW)	Frequency Tolerance (ppm)	Maximum ERP(W)
5	4M52G7D	-	0.0509	4M52W7D	-	0.0319
10	9M01G7D	0.0065	0.0410	9M04W7D	-	0.0318



1.7 Testing Location

Sporton Lab is accredited to ISO 17025 by Taiwan Accreditation Foundation (TAF code : 1190) and the FCC designation No. TW1022 under the FCC 2.948(e) by Mutual Recognition Agreement (MRA) in FCC Test.

Test Site	SPORTON INTERNATIONAL INC.	
Test Site Location	No. 52, Hwa Ya 1 st Rd., Hwa Ya Technology Park, Kwei-Shan Hsiang, Tao Yuan Hsien, Taiwan, R.O.C. TEL: +886-3-327-3456 FAX: +886-3-328-4978	
Test Site No.	Sporton Site No.	
	TH02-HY	03CH07-HY

1.8 Applicable Standards

According to the specifications of the manufacturer, the EUT must comply with the requirements of the following standards:

- ♦ 47 CFR Part 2, 22(H), 24(E), 27
- ♦ ANSI / TIA / EIA-603-C-2004
- ♦ FCC KDB 971168 D01 Power Meas. License Digital Systems v02r02

Remark:

1. All test items were verified and recorded according to the standards and without any deviation during the test.
2. This EUT has also been tested and complied with the requirements of FCC Part 15, Subpart B, recorded in a separate test report.



2 Test Configuration of Equipment Under Test

2.1 Test Mode

Antenna port conducted and radiated test items listed below are performed according to KDB 971168 D01 Power Meas. License Digital Systems v02r02 with maximum output power.

Radiated measurements are performed by rotating the EUT in three different orthogonal test planes to find the maximum emission.

Test Items	Band	Bandwidth (MHz)						Modulation		RB #			Test Channel		
		1.4	3	5	10	15	20	QPSK	16QAM	1	Half	Full	L	M	H
Max. Output Power	13	-	-	√	√	-	-	√	√	√	√	√	√	√	√
Peak-to-Average Ratio	13	-	-		√	-	-	√	√	√		√	√	√	√
26dB and 99% Bandwidth	13	-	-	√	√	-	-	√	√			√	√	√	√
Conducted Band Edge	13	-	-	√	√	-	-	√	√	√		√	√		√
Conducted Spurious Emission	13	-	-	√	√	-	-	√	√	√			√	√	√
Frequency Stability	13	-	-	√	√	-	-	√				√		√	
E.R.P./ E.I.R.P.	13	-	-	√			√	√	√	√			√	√	√
Radiated Spurious Emission	13	-	-	√	√	-	-	√		√			√	√	√
Note	<ol style="list-style-type: none"> The mark "√" means that this configuration is chosen for testing The mark "-" means that this bandwidth is not supported. For E.R.P./E.I.R.P. measurement, the widest bandwidth of each band is chosen for testing due to highest conducted power. Besides, the lowest bandwidth of each band is also measured for reporting only. The device is investigated from 30MHz to 10 times of fundamental signal for radiated spurious emission test under different RB size/offset and modulations in exploratory test. Subsequently, only the worst case emissions are reported. 														

2.2 Connection Diagram of Test System

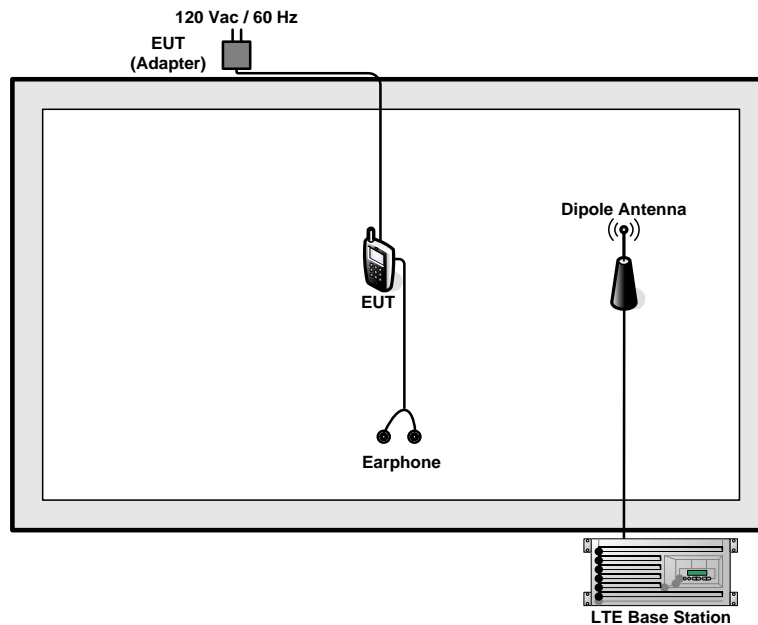

2.3 Support Unit used in test configuration and system

Item	Equipment	Trade Name	Model No.	FCC ID	Data Cable	Power Cord
1.	LTE Base Station	Anritsu	MT8820C	N/A	N/A	Unshielded, 1.8 m
2.	Earphone	MOTOROLA	SJYN1181B	N/A	Unshielded, 1 m	N/A

2.4 Measurement Results Explanation Example

For all conducted test items:

The offset level is set in the spectrum analyzer to compensate the RF cable loss and attenuator factor between EUT conducted output port and spectrum analyzer. With the offset compensation, the spectrum analyzer reading level is exactly the EUT RF output level.

The spectrum analyzer offset is derived from RF cable loss and attenuator factor.

Offset = RF cable loss + attenuator factor.

Following shows an offset computation example with cable loss 4.2 dB and 10dB attenuator.

Example :

$$\begin{aligned} \text{Offset(dB)} &= \text{RF cable loss(dB)} + \text{attenuator factor(dB)}. \\ &= 4.2 + 10 = 14.2 \text{ (dB)} \end{aligned}$$

3 Conducted Test Items

3.1 Measuring Instruments

See list of measuring instruments of this test report.

3.2 Test Setup

3.2.1 Conducted Output Power

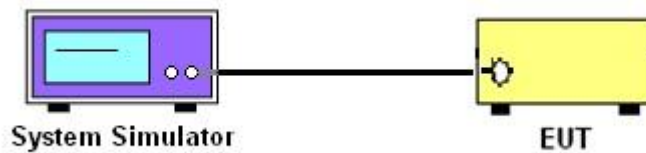

3.2.2 Peak-to-Average Ratio, Occupied Bandwidth ,Conducted Band-Edge and Conducted Spurious Emission

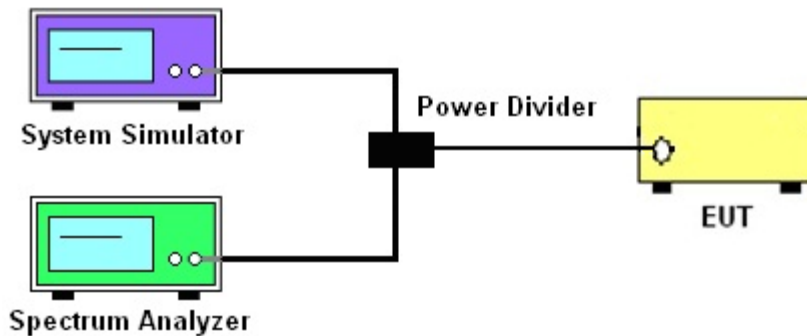

3.2.3 Frequency Stability

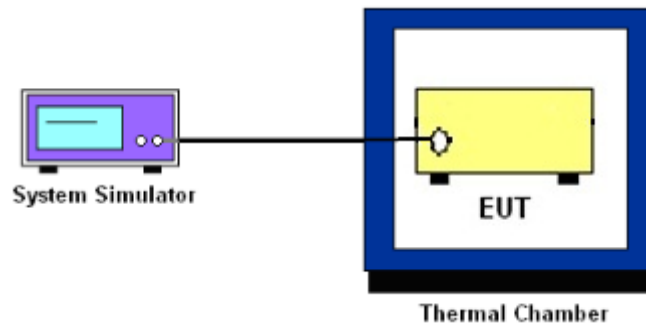



3.3 Test Result of Conducted Test

Please refer to Appendix A.

3.4 Conducted Output Power

3.4.1 Description of the Conducted Output Power Measurement

A system simulator was used to establish communication with the EUT. Its parameters were set to force the EUT transmitting at maximum output power. The measured power in the radio frequency on the transmitter output terminals shall be reported.

3.4.2 Test Procedures

1. The transmitter output port was connected to the system simulator.
2. Set EUT at maximum power through the system simulator.
3. Select lowest, middle, and highest channels for each band and different modulation.
4. Measure and record the power level from the system simulator.



3.5 Peak-to-Average Ratio

3.5.1 Description of the PAR Measurement

Power Complementary Cumulative Distribution Function (CCDF) curves provide a means for characterizing the power peaks of a digitally modulated signal on a statistical basis. A CCDF curve depicts the probability of the peak signal amplitude exceeding the average power level. Most contemporary measurement instrumentation include the capability to produce CCDF curves for an input signal provided that the instrument's resolution bandwidth can be set wide enough to accommodate the entire input signal bandwidth. In measuring transmissions in this band using an average power technique, the peak-to-average ratio (PAR) of the transmission may not exceed 13 dB.

3.5.2 Test Procedures

1. The testing follows FCC KDB 971168 v02r02 Section 5.7.1.
2. The EUT was connected to spectrum and system simulator via a power divider.
3. Set the CCDF (Complementary Cumulative Distribution Function) option in spectrum analyzer.
4. The highest RF powers were measured and recorded the maximum PAPR level associated with a probability of 0.1 %.
5. Record the deviation as Peak to Average Ratio.



3.6 Occupied Bandwidth

3.6.1 Description of Occupied Bandwidth Measurement

The occupied bandwidth is the width of a frequency band such that, below the lower and above the upper frequency limits, the mean powers emitted are each equal to a specified percentage 0.5% of the total mean transmitted power.

The 26 dB emission bandwidth is defined as the frequency range between two points, one above and one below the carrier frequency, at which the spectral density of the emission is attenuated 26 dB below the maximum in-band spectral density of the modulated signal. Spectral density (power per unit bandwidth) is to be measured with a detector of resolution bandwidth equal to approximately 1.0% of the emission bandwidth.

3.6.2 Test Procedures

1. The testing follows FCC KDB 971168 v02r02 Section 4.2.
2. The EUT was connected to spectrum analyzer and system simulator via a power divider.



3.7 Conducted Band Edge

3.7.1 Description of Conducted Band Edge Measurement

27.53 (c) and RSS – 130 for Band 13

For operations in the 776-788 MHz band, the FCC limit is $43 + 10\log_{10}(P[\text{Watts}])$ dB below the transmitter power $P(\text{Watts})$ in a 100 kHz bandwidth. However, in the 100 kHz bands immediately outside and adjacent to the frequency block, a resolution bandwidth of at least 30 kHz may be employed. In addition, the power of any unwanted emissions in any 6.25 kHz bandwidth for all frequencies between 763-775 MHz and 793-806 MHz shall be attenuated below the transmitter power, P (dBW), by at least $65 + 10 \log_{10} p(\text{watts})$, dB, for mobile and portable equipment.

3.7.2 Test Procedures

1. The testing follows FCC KDB 971168 v02r02 Section 6.0.
2. The EUT was connected to spectrum analyzer and system simulator via a power divider.
3. The band edges of low and high channels for the highest RF powers were measured. Set RBW $\geq 1\%$ EBW in the 1MHz band immediately outside and adjacent to the band edge.
4. Set spectrum analyzer with RMS detector.
5. The RF fundamental frequency should be excluded against the limit line in the operating frequency band.
6. The limit line is derived from $43 + 10\log(P)\text{dB}$ below the transmitter power $P(\text{Watts})$
 $= P(\text{W}) - [43 + 10\log(P)] \text{ (dB)}$
 $= [30 + 10\log(P)] \text{ (dBm)} - [43 + 10\log(P)] \text{ (dB)}$
 $= -13\text{dBm}.$



3.8 Conducted Spurious Emission

3.8.1 Description of Conducted Spurious Emission Measurement

The power of any emission outside of the authorized operating frequency ranges must be lower than the transmitter power (P) by a factor of at least $43 + 10 \log (P)$ dB.

It is measured by means of a calibrated spectrum analyzer and scanned from 30 MHz up to a frequency including its 10th harmonic.

3.8.2 Test Procedures

1. The testing follows FCC KDB 971168 v02r02 Section 6.0.
2. The EUT was connected to spectrum analyzer and system simulator via a power divider.
3. The RF output of EUT was connected to the spectrum analyzer by RF cable and attenuator. The path loss was compensated to the results for each measurement.
4. The middle channel for the highest RF power within the transmitting frequency was measured.
5. The conducted spurious emission for the whole frequency range was taken.
6. Make the measurement with the spectrum analyzer's RBW = 1MHz, VBW = 3MHz, taking the record of maximum spurious emission.
7. The RF fundamental frequency should be excluded against the limit line in the operating frequency band.
8. The limit line is derived from $43 + 10\log(P)$ dB below the transmitter power P(Watts)
= P(W)- [43 + 10log(P)] (dB)
= [30 + 10log(P)] (dBm) - [43 + 10log(P)] (dB)
= -13dBm.



3.9 Frequency Stability

3.9.1 Description of Frequency Stability Measurement

The frequency stability shall be measured by variation of ambient temperature and variation of primary supply voltage to ensure that the fundamental emission stays within the authorized frequency block. The frequency stability of the transmitter shall be maintained within $\pm 0.00025\%$ ($\pm 2.5\text{ppm}$) of the center frequency.

3.9.2 Test Procedures for Temperature Variation

1. The EUT was set up in the thermal chamber and connected with the system simulator.
2. With power OFF, the temperature was decreased to -30°C and the EUT was stabilized before testing. Power was applied and the maximum change in frequency was recorded within one minute.
3. With power OFF, the temperature was raised in 10°C step up to 50°C . The EUT was stabilized at each step for at least half an hour. Power was applied and the maximum frequency change was recorded within one minute.

3.9.3 Test Procedures for Voltage Variation

1. The testing follows FCC KDB 971168 v02r02 Section 9.0.
2. The EUT was placed in a temperature chamber at $25\pm 5^{\circ}\text{C}$ and connected with the system simulator.
3. The power supply voltage to the EUT was varied from 85% to 115% of the nominal value measured at the input to the EUT.
4. The variation in frequency was measured for the worst case.

4 Radiated Test Items

4.1 Measuring Instruments

See list of measuring instruments of this test report.

4.2 Test Setup

4.2.1 For radiated test from 30MHz to 1GHz

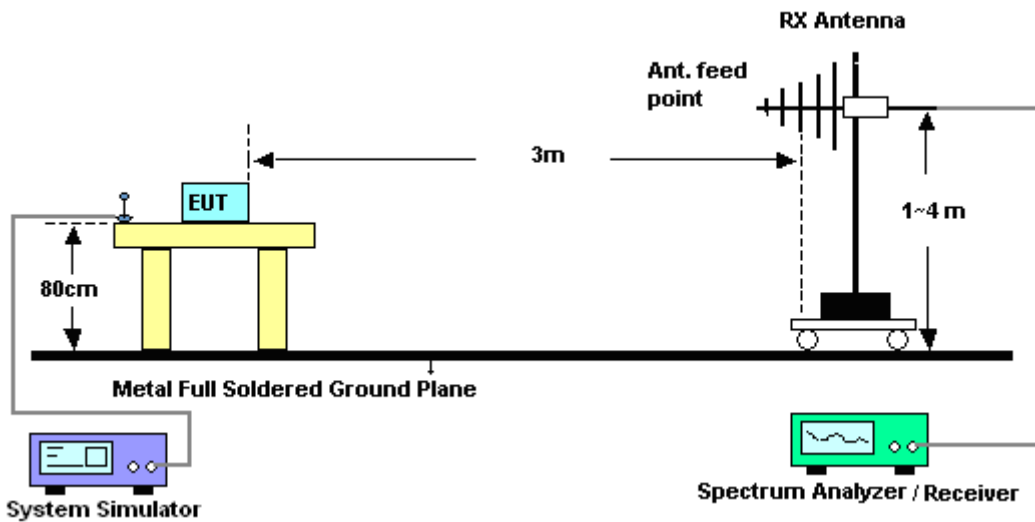

4.2.2 For radiated test above 1GHz

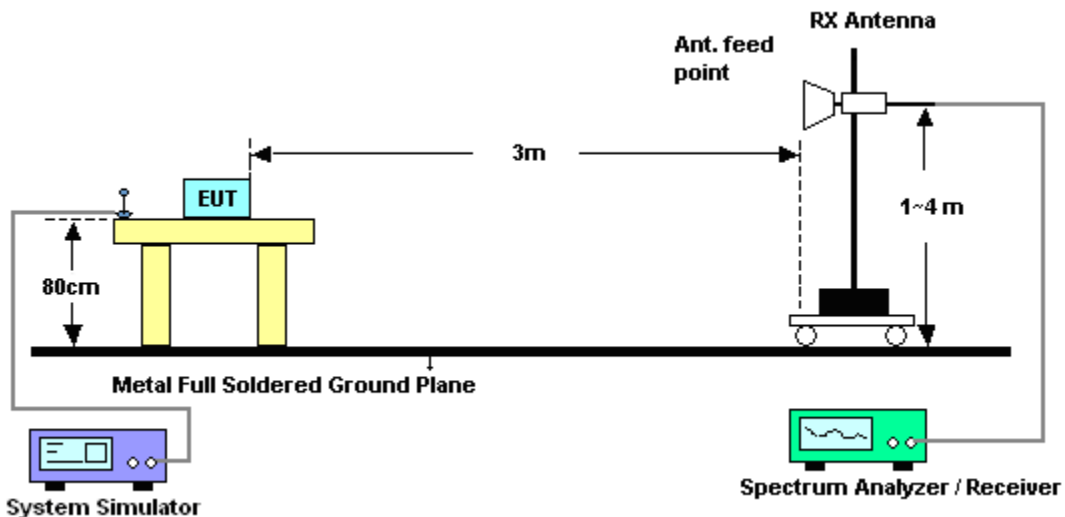



4.3 Test Result of Radiated Test

Please refer to Appendix B.

4.4 Effective Radiated Power and Effective Isotropic Radiated Power

4.4.1 Description of the ERP/EIRP Measurement

Effective radiated power output measurements by substitution method according to ANSI / TIA / EIA-603-C-2004, and the spectrum analyzer configuration follows KDB 971168 D01 Power Meas. License Digital Systems v01r02. Mobile and portable (hand-held) stations operating are limited to average ERP 3 watts with LTE band 13.

4.4.2 Test Procedures

1. The testing follows FCC KDB 971168 v02r02 Section 5.2.1. (for CDMA/WCDMA), Section 5.2.2.2 (for GSM/GPRS/EDGE) and ANSI / TIA-603-C-2004 Section 2.2.17.
2. The EUT was placed on a non-conductive rotating platform 0.8 meters high in a semi-anechoic chamber. The radiated emission at the fundamental frequency was measured at 3 m with a test antenna and a spectrum analyzer with RMS detector.
3. During the measurement, the system simulator parameters were set to force the EUT transmitting at maximum output power. The maximum emission was recorded from analyzer power level (LVL) from the 360 degrees rotation of the turntable and the test antenna raised and lowered over a range from 1 to 4 meters in both horizontally and vertically polarized orientations.
4. Effective Isotropic Radiated Power (EIRP) was measured by substitution method according to TIA/EIA-603-C. The EUT was replaced by dipole antenna (substitution antenna) at same location, and then a known power from S.G. was applied into the dipole antenna through a Tx cable, and then recorded the maximum Analyzer reading through raised and lowered the test antenna. The correction factor (in dB) = S.G. - Tx Cable loss + Substitution antenna gain - Analyzer reading. Then the EUT's EIRP was calculated with the correction factor, $EIRP = LVL + \text{Correction factor}$ and $ERP = EIRP - 2.15$.



4.5 Radiated Spurious Emission

4.5.1 Description of Radiated Spurious Emission

The radiated spurious emission was measured by substitution method according to ANSI / TIA / EIA-603-C-2004. The power of any emission outside of the authorized operating frequency ranges must be attenuated below the transmitter power (P) by a factor of at least $43 + 10 \log (P)$ dB.

For LTE Band 13

For operations in the 746-758 MHz, 775-788 MHz, and 805-806 MHz bands, emissions in the band 1559-1610 MHz shall be limited to -70 dBW/MHz equivalent isotropically radiated power (EIRP) for wideband signals, and -80 dBW EIRP for discrete emissions of less than 700 Hz bandwidth.

The spectrum is scanned from 30 MHz up to a frequency including its 10th harmonic.

4.5.2 Test Procedures

1. The testing follows FCC KDB 971168 v02r02 Section 5.8 and ANSI / TIA-603-C-2004 Section 2.2.12.
2. The EUT was placed on a rotatable wooden table with 0.8 meter above ground.
3. The EUT was set 3 meters from the receiving antenna, which was mounted on the antenna tower.
4. The table was rotated 360 degrees to determine the position of the highest spurious emission.
5. The height of the receiving antenna is varied between one meter and four meters to search the maximum spurious emission for both horizontal and vertical polarizations.
6. Make the measurement with the spectrum analyzer's RBW = 1MHz, VBW = 3MHz, taking the record of maximum spurious emission.
7. A horn antenna was substituted in place of the EUT and was driven by a signal generator.
8. Tune the output power of signal generator to the same emission level with EUT maximum spurious emission.
9. Taking the record of output power at antenna port.
10. Repeat step 7 to step 8 for another polarization.
11. The RF fundamental frequency should be excluded against the limit line in the operating frequency band.

The limit line is derived from $43 + 10\log(P)$ dB below the transmitter power P(Watts)

$$= P(W) - [43 + 10\log(P)] \text{ (dB)}$$

$$= [30 + 10\log(P)] \text{ (dBm)} - [43 + 10\log(P)] \text{ (dB)}$$

$$= -13\text{dBm.}$$

12. $\text{EIRP (dBm)} = \text{S.G. Power} - \text{Tx Cable Loss} + \text{Tx Antenna Gain}$
13. $\text{ERP (dBm)} = \text{EIRP} - 2.15$



5 List of Measuring Equipment

Instrument	Manufacturer	Model No.	Serial No.	Characteristics	Calibration Date	Test Date	Due Date	Remark
Spectrum Analyzer	Rohde & Schwarz	FSP40	100055	9kHz~40GHz	Jun. 09, 2014	Dec. 23, 2014~ Dec. 24, 2014	Jun. 08, 2015	Conducted (TH02-HY)
Thermal Chamber	Ten Billion	TTH-D3SP	TBN-930701	N/A	Jul. 17, 2014	Dec. 23, 2014~ Dec. 24, 2014	Jul. 16, 2015	Conducted (TH02-HY)
LTE Base Station	Anritsu	MT8820C	6201026480	30MHz~2.7GHz SISO	Jan. 07, 2014	Dec. 23, 2014~ Dec. 24, 2014	Jan. 06, 2015	Conducted (TH02-HY)
Spectrum Analyzer	Rohde & Schwarz	FSV30	101749	10Hz ~ 30GHz	Feb. 10, 2014	Dec. 22, 2014~ Dec. 23, 2014	Feb. 09, 2015	Radiation (03CH07-HY)
Bilog Antenna	Schaffner	CBL6111C	2726	30MHz ~ 1GHz	Sep. 27, 2014	Dec. 22, 2014~ Dec. 23, 2014	Sep. 26, 2015	Radiation (03CH07-HY)
Double Ridge Horn Antenna	ESCO	3117	75962	1GHz~18GHz	Aug. 19, 2014	Dec. 22, 2014~ Dec. 23, 2014	Aug. 18, 2015	Radiation (03CH07-HY)
Preamplifier	COM-POWER	PA-103A	161241	10 MHz ~ 1000MHz	Mar. 17, 2014	Dec. 22, 2014~ Dec. 23, 2014	Mar. 16, 2015	Radiation (03CH07-HY)
Preamplifier	Agilent	8449B	3008A02362	1 GHz~26.5 GHz	Oct. 21, 2014	Dec. 22, 2014~ Dec. 23, 2014	Oct. 20, 2015	Radiation (03CH07-HY)
Turn Table	ChainTek	ChainTek 3000	N/A	0 ~ 360 degree	N/A	Dec. 22, 2014~ Dec. 23, 2014	N/A	Radiation (03CH07-HY)
Antenna Mast	ChainTek	M-400-0	114/8000604/L	N/A	N/A	Dec. 22, 2014~ Dec. 23, 2014	N/A	Radiation (03CH07-HY)
SHF-EHF Horn Antenna	SCHWARZBECK	BBHA 9170	BBHA9170251	18GHz~40GHz	Oct. 02, 2014	Dec. 22, 2014~ Dec. 23, 2014	Oct. 01, 2015	Radiation (03CH07-HY)
Signal Generator	Rohde & Schwarz	SMF100A	101107	100kHz~40GHz	May 23, 2014	Dec. 22, 2014~ Dec. 23, 2014	May 22, 2015	Radiation (03CH07-HY)
Double Ridge Horn Antenna	ESCO	3117	00066583	1GHz~18GHz	Jul. 24, 2014	Dec. 22, 2014~ Dec. 23, 2014	Jul. 23, 2015	Radiation (03CH07-HY)



6 Uncertainty of Evaluation

Uncertainty of Radiated Emission Measurement (30 MHz ~ 1000 MHz)

Measuring Uncertainty for a Level of Confidence of 95% ($U = 2Uc(y)$)	2.54
---	------

Uncertainty of Radiated Emission Measurement (1 GHz ~ 40 GHz)

Measuring Uncertainty for a Level of Confidence of 95% ($U = 2Uc(y)$)	4.72
---	------



Appendix A. Test Results of Conducted Test

Conducted Output Power(Average power)

LTE Band 13 Maximum Average Power [dBm]						
BW [MHz]	RB Size	RB Offset	Mod	Lowest	Middle	Highest
5	1	0	QPSK	22.93	22.75	22.73
5	1	12		22.94	22.96	22.80
5	1	24		22.66	22.95	22.91
5	12	0		21.92	21.89	21.86
5	12	6		21.95	21.98	21.92
5	12	11		21.95	21.85	21.94
5	25	0		21.92	21.88	21.87
5	1	0	16-QAM	22.17	22.26	21.90
5	1	12		22.15	22.21	22.02
5	1	24		22.22	22.15	22.15
5	12	0		20.88	20.78	20.72
5	12	6		20.85	20.78	20.71
5	12	11		20.83	20.74	20.80
5	25	0		20.91	20.80	20.91
10	1	0	QPSK		22.98	
10	1	24			22.90	
10	1	49			22.89	
10	25	0			21.88	
10	25	12			21.78	
10	25	24			21.74	
10	50	0			21.86	
10	1	0	16-QAM		21.89	
10	1	24			21.99	
10	1	49			22.01	
10	25	0			21.01	
10	25	12			21.10	
10	25	24			20.89	
10	50	0			20.92	



Peak-to-Average Ratio

Mode	LTE Band 13 / 10MHz				Limit: 13dB
Mod.	QPSK		16QAM		
RB Size	1RB	Full RB	1RB	RB Size	Result
Lowest CH	-	-	-	-	PASS
Middle CH	3.40	5.32	4.33	5.77	
Highest CH	-	-	-	-	

LTE Band 13 / 10MHz / QPSK

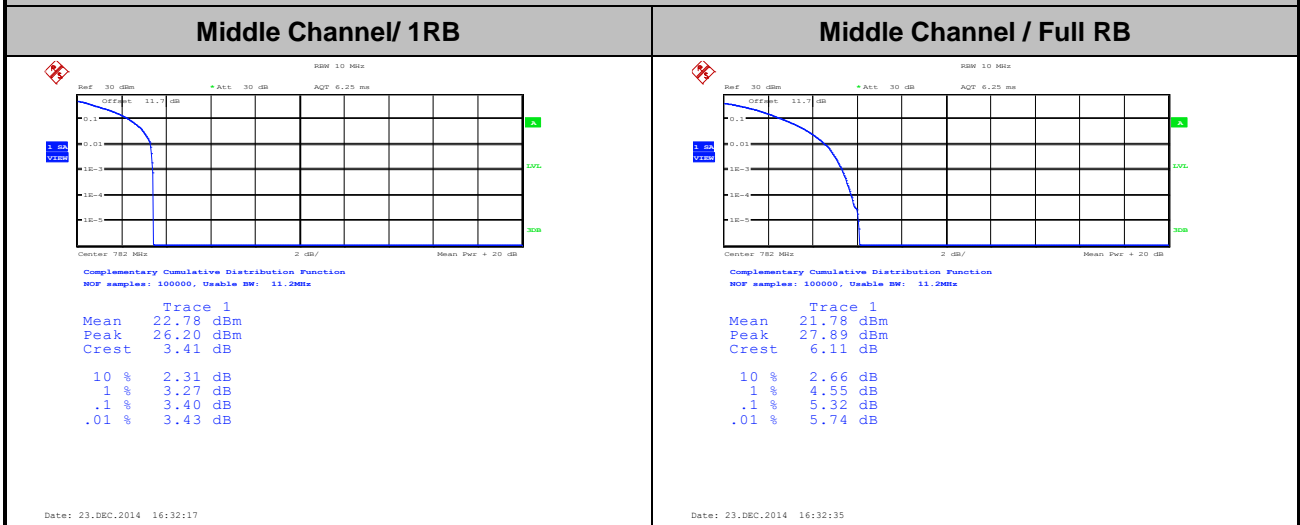

LTE Band 13 / 10MHz / 16QAM

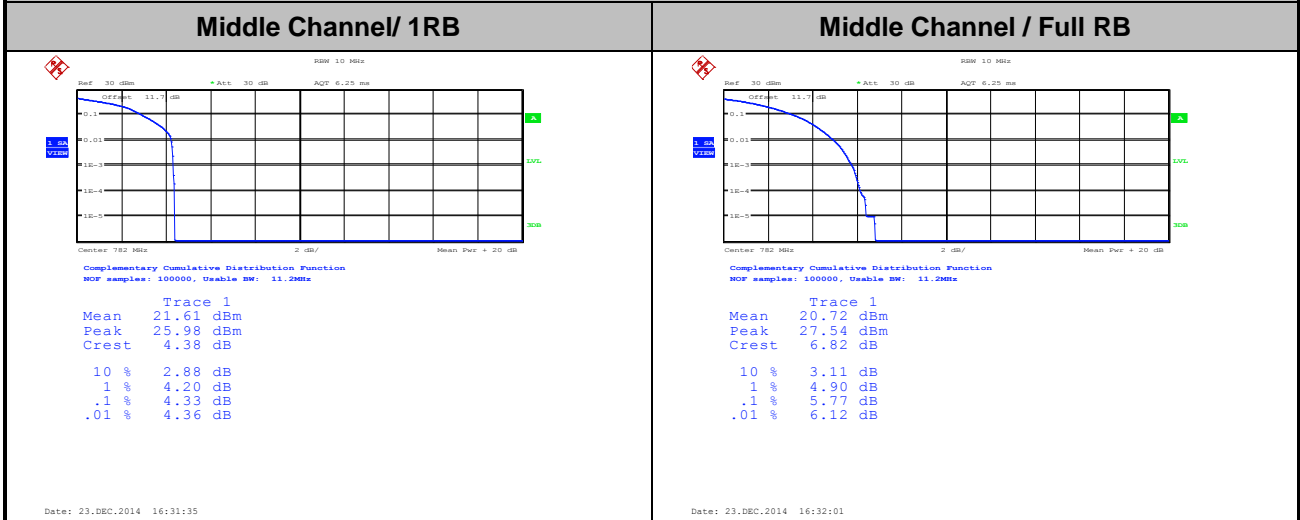



26dB Bandwidth

Mode	LTE Band 13 : 26dB BW(MHz)											
	1.4MHz		3MHz		5MHz		10MHz		15MHz		20MHz	
BW												
Mod.	QPSK	16QAM	QPSK	16QAM	QPSK	16QAM	QPSK	16QAM	QPSK	16QAM	QPSK	16QAM
Lowest CH	-	-	-	-	4.98	4.92	-	-	-	-	-	-
Middle CH	-	-	-	-	4.98	4.97	10.00	10.04	-	-	-	-
Highest CH	-	-	-	-	4.92	4.92	-	-	-	-	-	-



LTE Band 13

Lowest Channel / 5MHz / QPSK

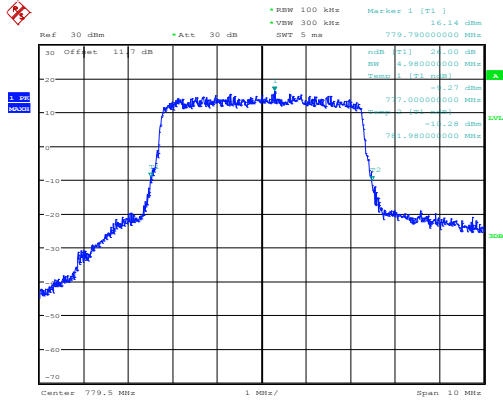

Date: 23.DEC.2014 16:15:55

Lowest Channel / 5MHz / 16QAM

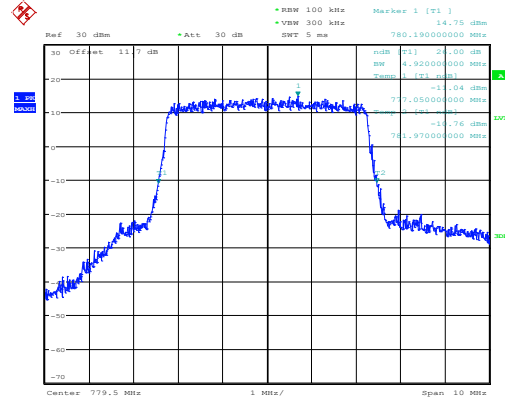

Date: 23.DEC.2014 16:15:41

Middle Channel / 5MHz / QPSK

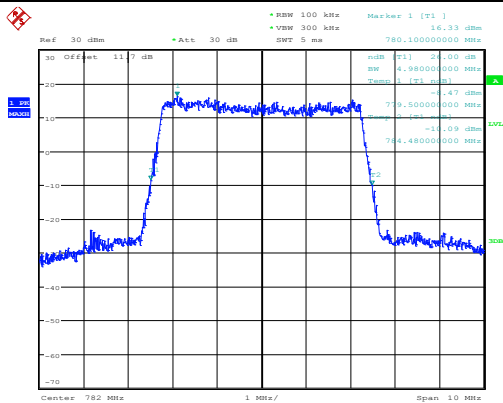

Date: 23.DEC.2014 16:20:47

Middle Channel / 5MHz / 16QAM

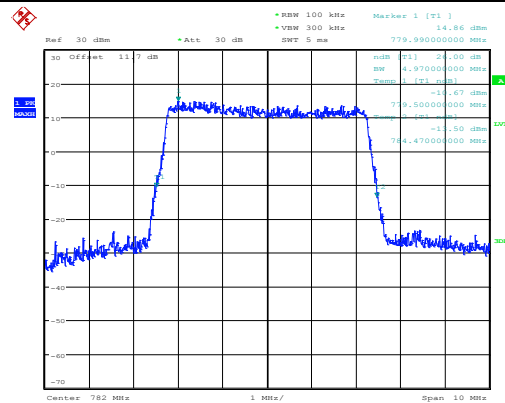

Date: 23.DEC.2014 16:21:00

Highest Channel / 5MHz / QPSK

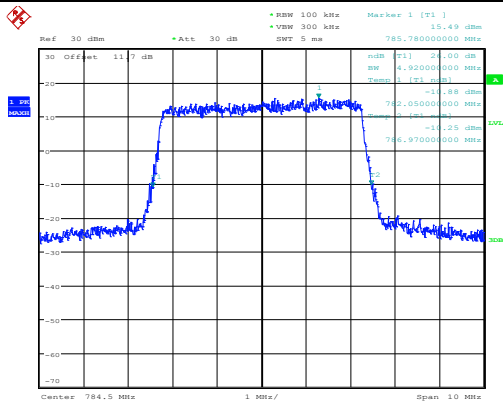

Date: 23.DEC.2014 16:22:13

Highest Channel / 5MHz / 16QAM

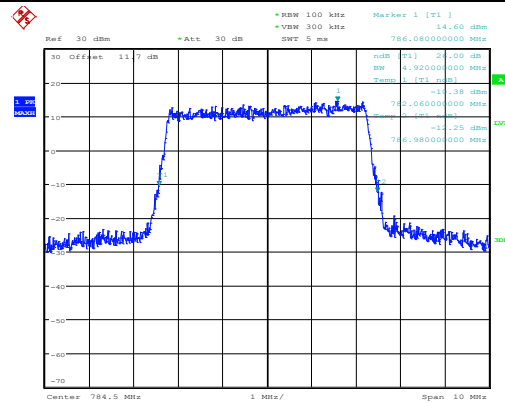

Date: 23.DEC.2014 16:22:00



LTE Band 13

Middle Channel / 10MHz / QPSK

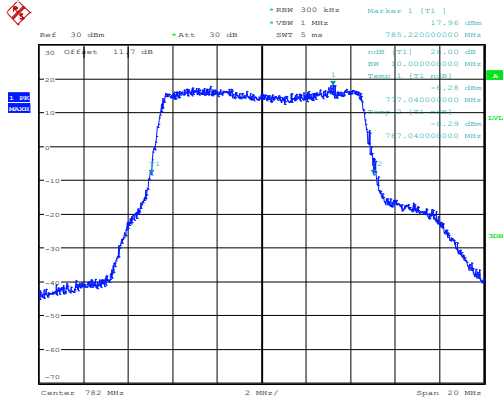

Date: 23.DEC.2014 16:25:24

Middle Channel / 10MHz / 16QAM

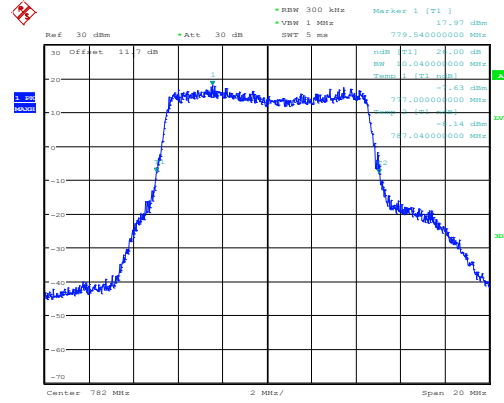

Date: 23.DEC.2014 16:25:11



Occupied Bandwidth

Mode	LTE Band 13 : 99%OBW(MHz)											
	1.4MHz		3MHz		5MHz		10MHz		15MHz		20MHz	
BW	QPSK	16QAM	QPSK	16QAM	QPSK	16QAM	QPSK	16QAM	QPSK	16QAM	QPSK	16QAM
Mod.	QPSK	16QAM	QPSK	16QAM	QPSK	16QAM	QPSK	16QAM	QPSK	16QAM	QPSK	16QAM
Lowest CH	-	-	-	-	4.48	4.47	-	-	-	-	-	-
Middle CH	-	-	-	-	4.52	4.52	9.10	9.04	-	-	-	-
Highest CH	-	-	-	-	4.50	4.51	-	-	-	-	-	-



LTE Band 13

Lowest Channel / 5MHz / QPSK

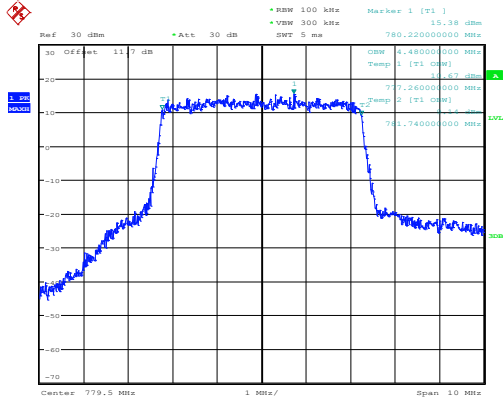

Date: 23.DEC.2014 16:15:17

Lowest Channel / 5MHz / 16QAM

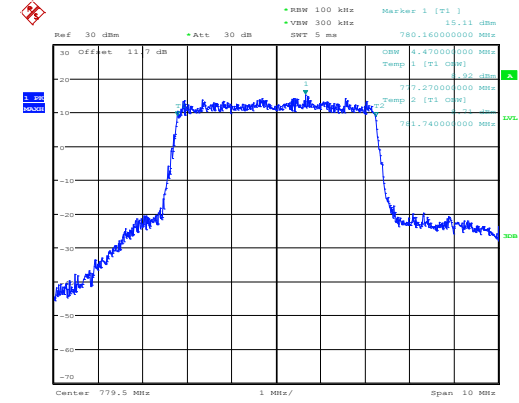

Date: 23.DEC.2014 16:15:28

Middle Channel / 5MHz / QPSK

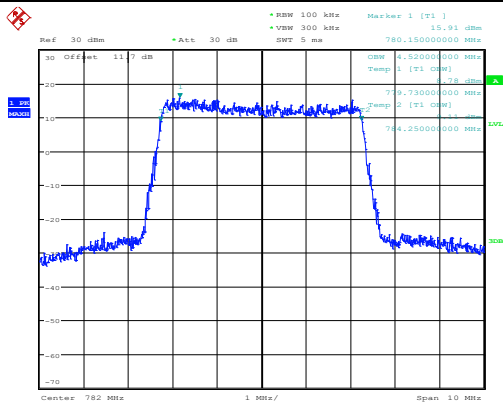

Date: 23.DEC.2014 16:21:22

Middle Channel / 5MHz / 16QAM

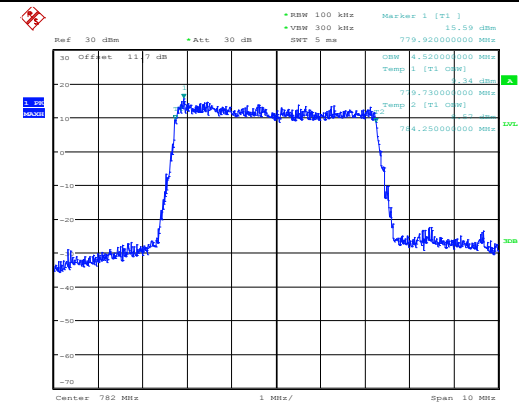

Date: 23.DEC.2014 16:21:11

Highest Channel / 5MHz / QPSK

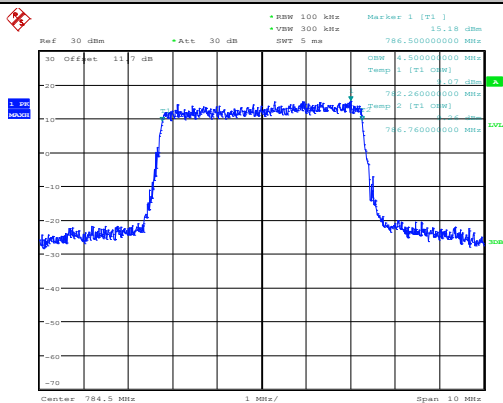

Date: 23.DEC.2014 16:21:32

Highest Channel / 5MHz / 16QAM

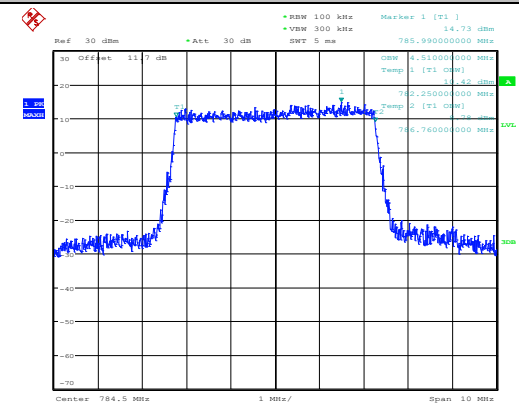

Date: 23.DEC.2014 16:21:46



LTE Band 13

Middle Channel / 10MHz / QPSK

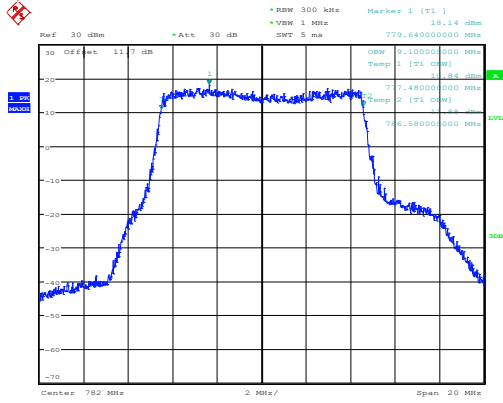

Date: 23.DEC.2014 16:24:48

Middle Channel / 10MHz / 16QAM

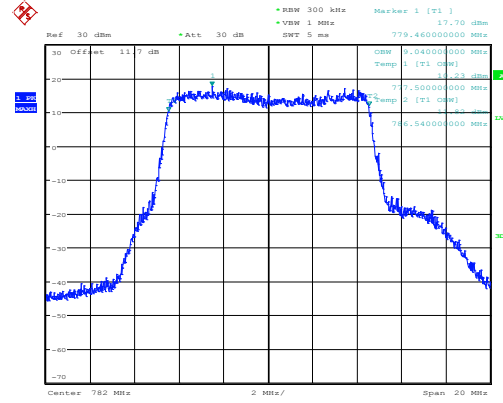

Date: 23.DEC.2014 16:24:59



Conducted Band Edge

LTE Band 13 / 5MHz / QPSK

Lowest Band Edge / 1 RB

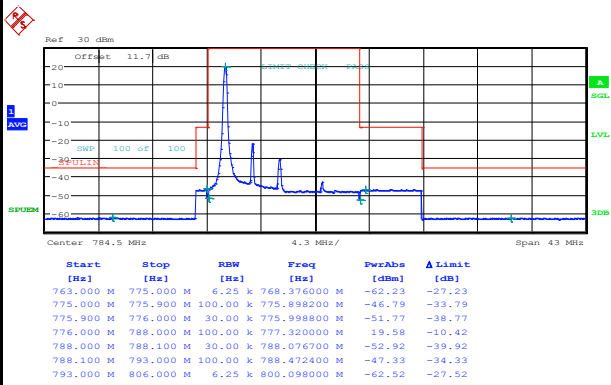

Date: 23.DEC.2014 16:38:11

Highest Band Edge / 1 RB

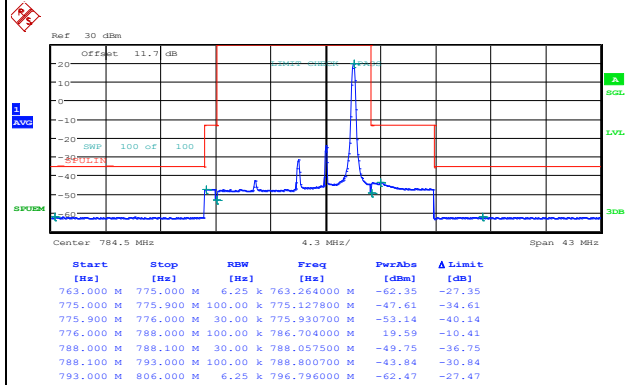

Date: 23.DEC.2014 16:55:46

Lowest Band Edge / Full RB

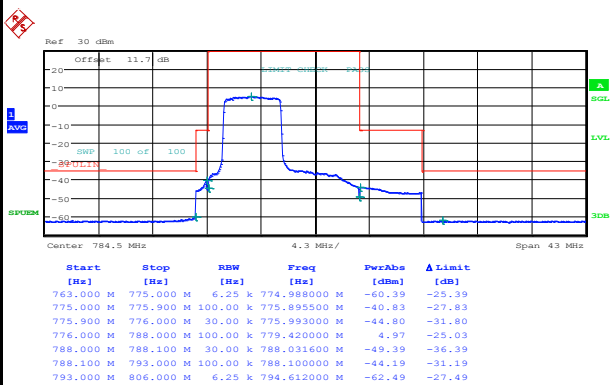

Date: 23.DEC.2014 16:45:51

Highest Band Edge / Full RB

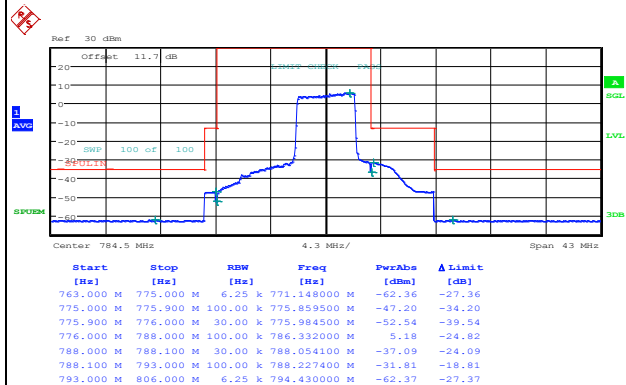

Date: 23.DEC.2014 16:47:52



LTE Band 13 / 5MHz / 16QAM

Lowest Band Edge / 1 RB

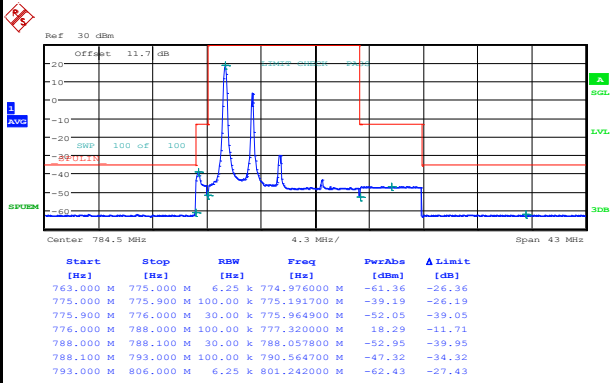

Date: 23.DEC.2014 16:41:19

Highest Band Edge / 1 RB

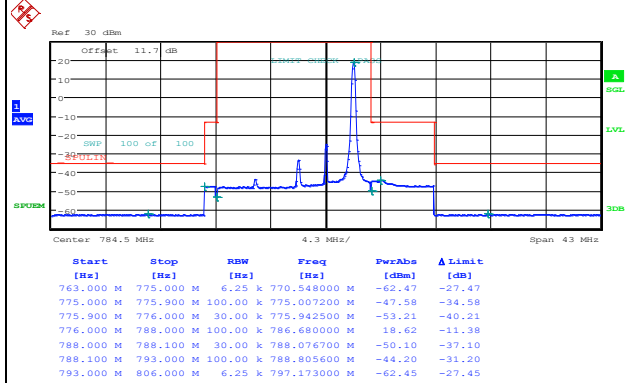

Date: 23.DEC.2014 16:53:41

Lowest Band Edge / Full RB

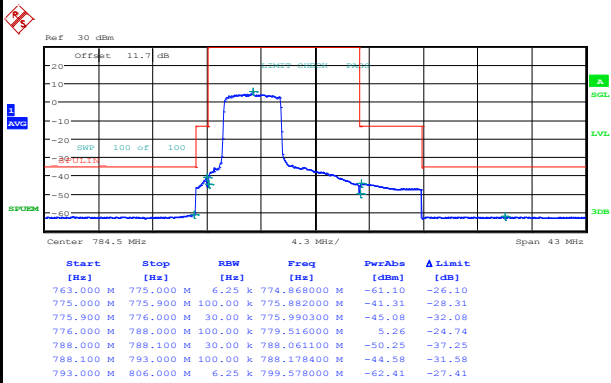

Date: 23.DEC.2014 16:43:47

Highest Band Edge / Full RB

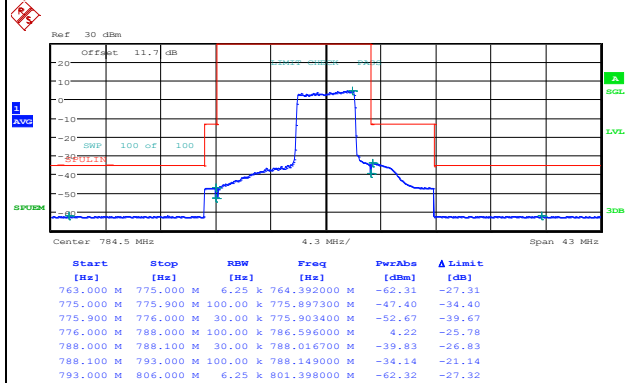

Date: 23.DEC.2014 16:50:40



LTE Band 13 / 10MHz / QPSK

Lowest Band Edge / 1 RB

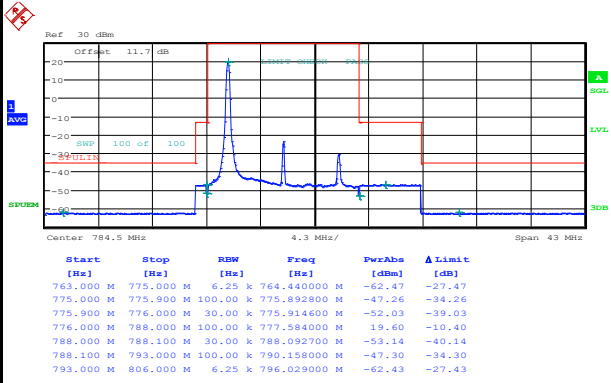

Date: 23.DEC.2014 16:58:08

Highest Band Edge / 1 RB

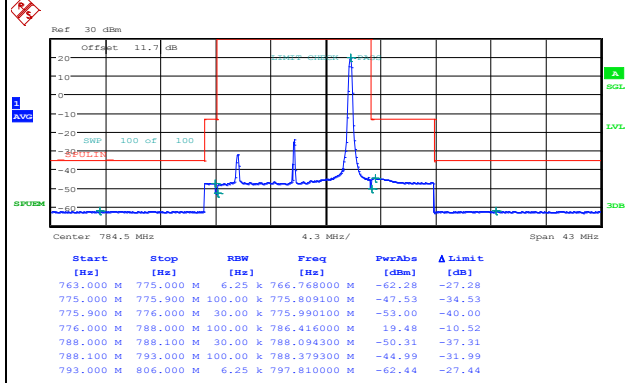

Date: 23.DEC.2014 17:04:19

Band Edge / Full RB

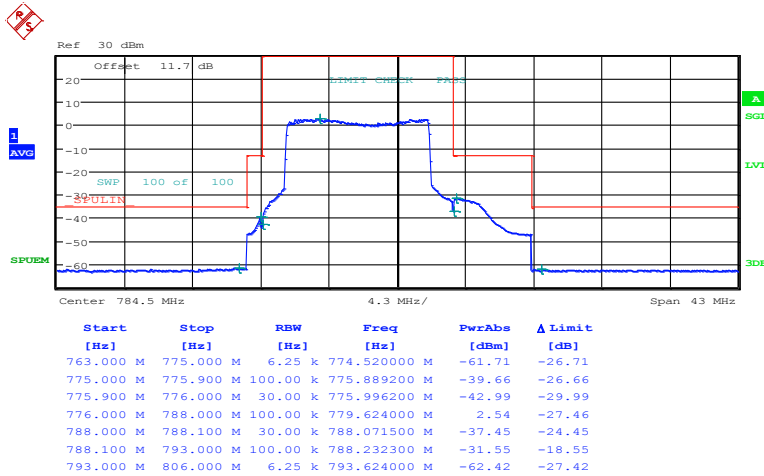

Date: 23.DEC.2014 17:09:15



LTE Band 13 / 10MHz / 16QAM

Lowest Band Edge / 1 RB

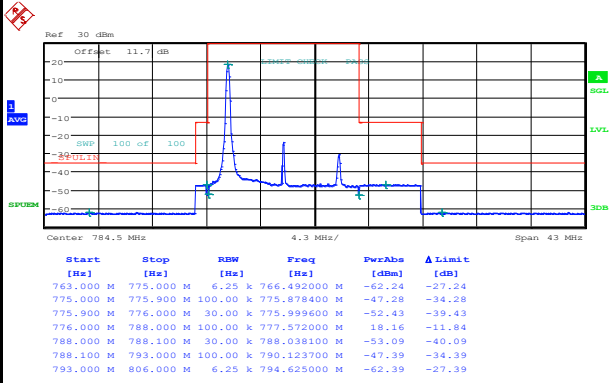

Date: 23.DEC.2014 17:00:16

Highest Band Edge / 1 RB

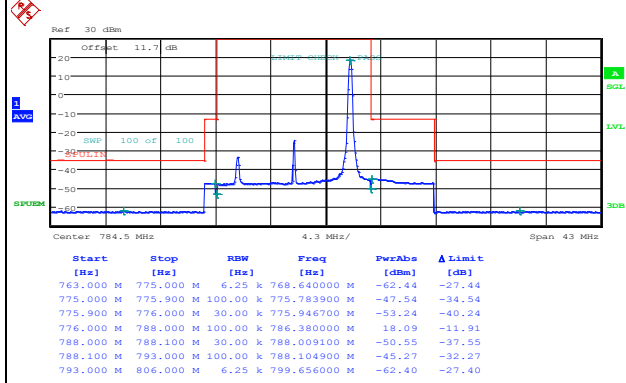

Date: 23.DEC.2014 17:02:22

Band Edge / Full RB

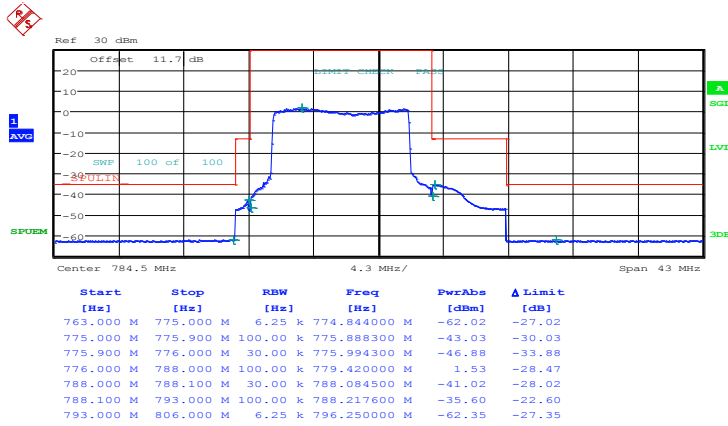

Date: 23.DEC.2014 17:11:06



Conducted Spurious Emission

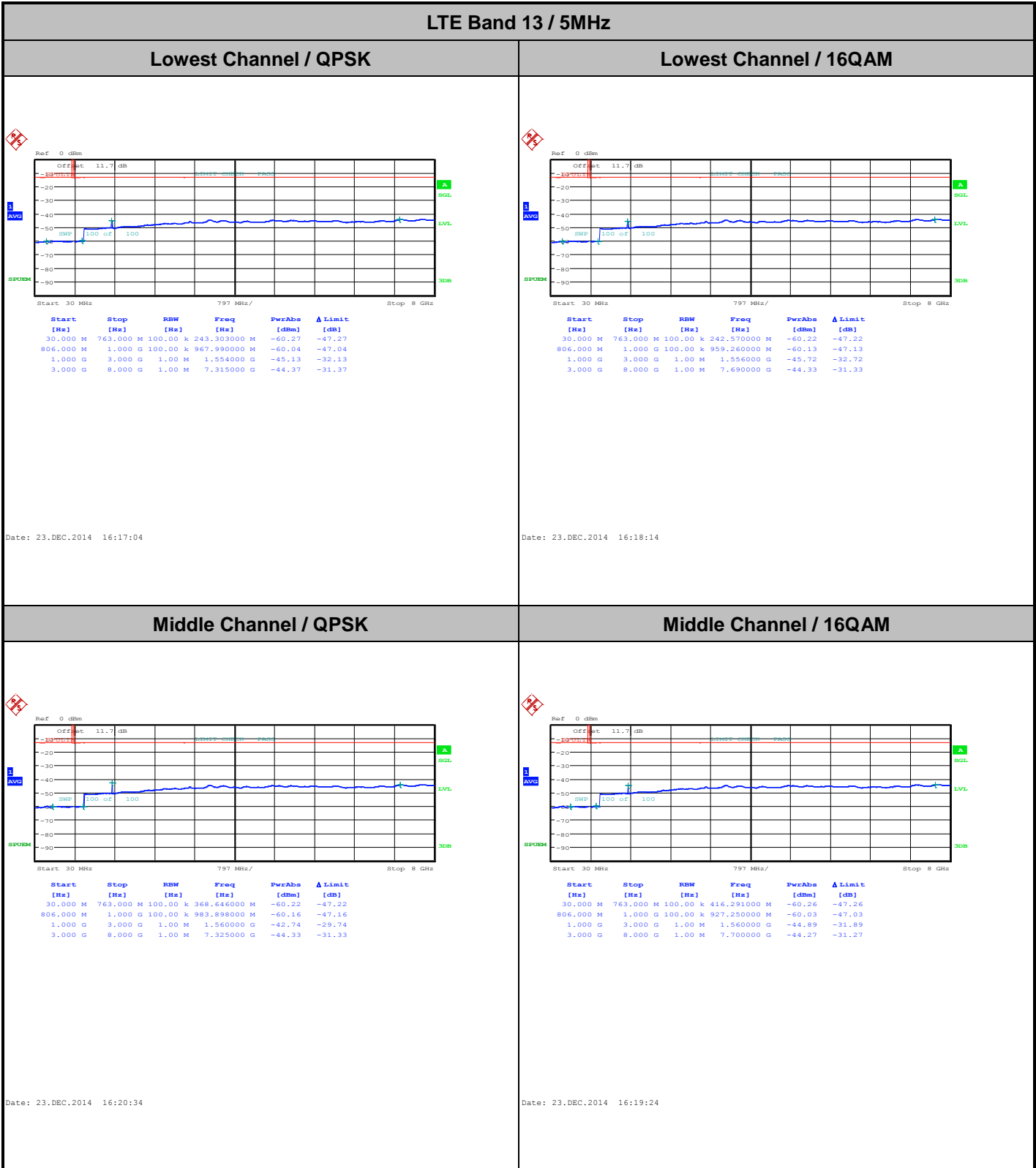



LTE Band 13 / 5MHz

Highest Channel / QPSK

Highest Channel / 16QAM

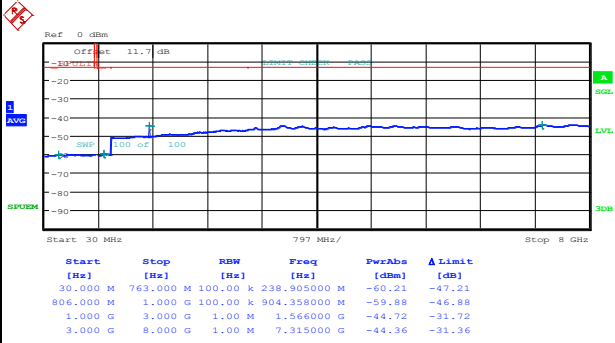

Date: 23.DEC.2014 16:23:23

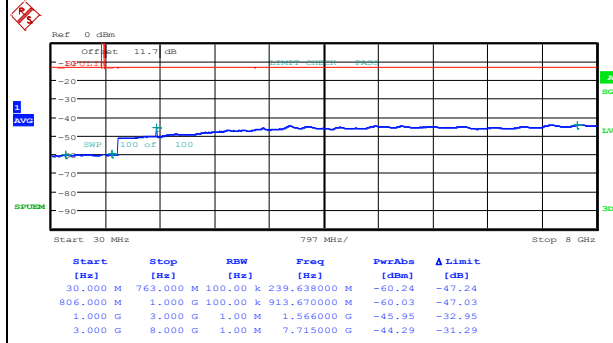

Date: 23.DEC.2014 16:24:33

LTE Band 13 / 10MHz

Middle Channel / QPSK

Middle Channel / 16QAM

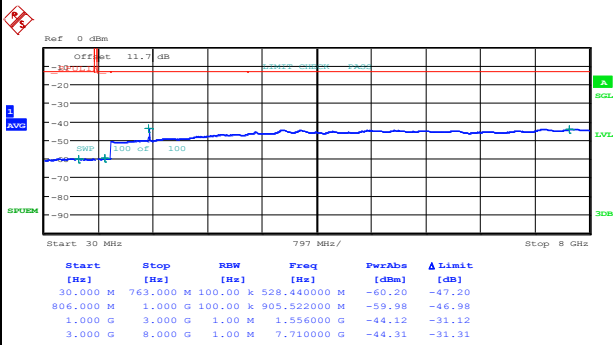

Date: 23.DEC.2014 16:27:44

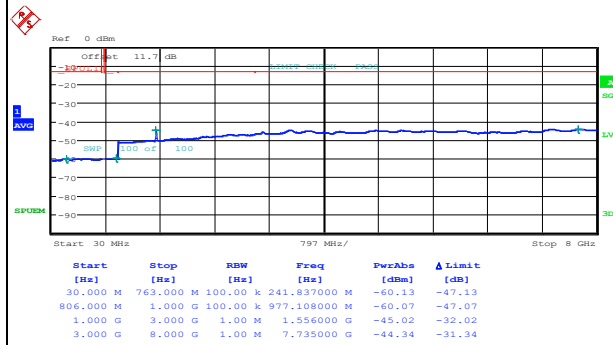

Date: 23.DEC.2014 16:26:34



Frequency Stability

Test Conditions		LTE Band 13 (QPSK) / Middle Channel	Limit
Temperature (°C)	Voltage (Volt)	BW 10MHz	Note 2.
		Deviation (ppm)	Result
50	Normal Voltage	0.0022	PASS
40	Normal Voltage	0.0018	
30	Normal Voltage	0.0014	
20(Ref.)	Normal Voltage	0.0000	
10	Normal Voltage	0.0018	
0	Normal Voltage	0.0064	
-10	Normal Voltage	0.0003	
-20	Normal Voltage	0.0031	
-30	Normal Voltage	0.0065	
20	Maximum Voltage	0.0008	
20	Normal Voltage	0.0000	
20	Battery End Point	0.0023	

Note:

1. Normal Voltage = 3.8V. ; Battery End Point (BEP) = 3.4 V. ; Maximum Voltage =4.2 V
2. Note: The frequency fundamental emissions stay within the authorized frequency block based on the frequency deviation measured is small.



Appendix B. Test Results of Radiated Test

ERP/EIRP

LTE Band 13 / 5MHz							
Channel	Modulation	RB		Horizontal		Vertical	
		Size	Offset	ERP(dBm)	ERP(W)	ERP(dBm)	ERP(W)
Lowest	QPSK	1	0	9.29	0.0085	16.19	0.0416
Middle		1	0	10.06	0.0101	16.92	0.0492
Highest		1	0	9.70	0.0093	17.07	0.0509
Lowest	16QAM	1	0	8.05	0.0064	13.50	0.0224
Middle		1	0	7.01	0.0050	14.12	0.0258
Highest		1	0	7.97	0.0063	15.04	0.0319
Limit	ERP < 3W			Result		PASS	

LTE Band 13 / 10MHz							
Channel	Modulation	RB		Horizontal		Vertical	
		Size	Offset	ERP(dBm)	ERP(W)	ERP(dBm)	ERP(W)
Lowest	QPSK	1	0	-	-	-	-
Middle		1	0	9.26	0.0084	16.13	0.0410
Highest		1	0	-	-	-	-
Lowest	16QAM	1	0	-	-	-	-
Middle		1	0	6.89	0.0049	15.02	0.0318
Highest		1	0	-	-	-	-
Limit	ERP < 3W			Result		PASS	



Radiated Spurious Emission

Table with 10 columns: Channel, Frequency (MHz), ERP (dBm), Limit (dBm), Over Limit (dB), SPA Reading (dBm), S.G. Power (dBm), TX Cable loss (dB), TX Antenna Gain (dBi), Polarization (H/V). Rows are categorized by Channel: Lowest, Middle, Highest.

Remark: Spurious emissions within 30-1000MHz were found more than 20dB below limit line.

Table with 10 columns: Channel, Frequency (MHz), ERP (dBm), Limit (dBm), Over Limit (dB), SPA Reading (dBm), S.G. Power (dBm), TX Cable loss (dB), TX Antenna Gain (dBi), Polarization (H/V). Rows are categorized by Channel: Middle.

Remark: Spurious emissions within 30-1000MHz were found more than 20dB below limit line.



Appendix A. Original Report

Please refer to Sporton report number FG4N1482B as below.