



FCC RF Test Report

APPLICANT : Motorola Mobility, LLC
EQUIPMENT : Mobile Cellular Phone
BRAND NAME : Motorola
MODEL NAME : 4241
FCC ID : IHDT56QC8
STANDARD : FCC 47 CFR Part 2, 22(H), 24(E), 27(L)
CLASSIFICATION : PCS Licensed Transmitter Held to Ear (PCE)

The product was received on Nov. 15, 2014 and testing was completed on Dec. 24, 2014. We, SPORTON INTERNATIONAL INC., would like to declare that the tested sample has been evaluated in accordance with the test procedures given in ANSI / TIA / EIA-603-C-2004 and has been in compliance with the applicable technical standards.

The test results in this report apply exclusively to the tested model / sample. Without written approval of SPORTON INTERNATIONAL INC., the test report shall not be reproduced except in full.

Reviewed by: Joseph Lin / Supervisor

Approved by: Jones Tsai / Manager



SPORTON INTERNATIONAL INC.

No. 52, Hwa Ya 1st Rd., Hwa Ya Technology Park, Kwei-Shan Hsiang, Tao Yuan Hsien, Taiwan, R.O.C.



TABLE OF CONTENTS

REVISION HISTORY.....3

SUMMARY OF TEST RESULT4

1 GENERAL DESCRIPTION.....5

 1.1 Applicant.....5

 1.2 Manufacturer5

 1.3 Product Feature of Equipment Under Test5

 1.4 Product Specification subjective to this standard.....6

 1.5 Modification of EUT6

 1.6 Maximum ERP/EIRP Power, Frequency Tolerance, and Emission Designator6

 1.7 Testing Location7

 1.8 Applicable Standards7

2 TEST CONFIGURATION OF EQUIPMENT UNDER TEST.....8

 2.1 Test Mode.....8

 2.2 Connection Diagram of Test System9

 2.3 Support Unit used in test configuration9

 2.4 Measurement Results Explanation Example9

3 TEST RESULT.....10

 3.1 Conducted Output Power Measurement.....10

 3.2 Peak-to-Average Ratio12

 3.3 Effective Radiated Power and Effective Isotropic Radiated Power Measurement18

 3.4 99% Occupied Bandwidth and 26dB Bandwidth Measurement.....22

 3.5 Band Edge Measurement.....30

 3.6 Conducted Spurious Emission Measurement.....33

 3.7 Field Strength of Spurious Radiation Measurement40

 3.8 Frequency Stability Measurement.....48

4 LIST OF MEASURING EQUIPMENT.....51

5 UNCERTAINTY OF EVALUATION.....52

APPENDIX A. ORIGINAL REPORT



SUMMARY OF TEST RESULT

Report Section	FCC Rule	Description	Limit	Result	Remark
3.1	§2.1046	Conducted Output Power	N/A	PASS	-
3.2	§24.232(d)	Peak-to-Average Ratio	<13 dB	PASS	-
3.3	§22.913(a)(2)	Effective Radiated Power	< 7 Watts	PASS	-
	§24.232(c)	Equivalent Isotropic Radiated Power	< 2 Watts	PASS	-
	§27.50(d)(4)	Equivalent Isotropic Radiated Power	< 1 Watts	PASS	-
3.4	§2.1049 §22.917(b) §24.238(b) §27.53(g)	Occupied Bandwidth	N/A	PASS	-
3.5	§2.1051 §22.917(a) §24.238(a) §27.53(h)	Band Edge Measurement	< 43+10log ₁₀ (P[Watts])	PASS	-
3.6	§2.1051 §22.917(a) §24.238(a) §27.53(h)	Conducted Spurious Emission	< 43+10log ₁₀ (P[Watts])	PASS	-
3.7	§2.1053 §22.917(a) §24.238(a) §27.53(h)	Field Strength of Spurious Radiation	< 43+10log ₁₀ (P[Watts])	PASS	Under limit 38.30 dB at 7635.000 MHz
3.8	§2.1055 §22.355	Frequency Stability for Temperature & Voltage	< 2.5 ppm for Part 22 Within Authorized Band	PASS	-
	§2.1055 §24.235 §27.54				



1 General Description

1.1 Applicant

Motorola Mobility, LLC
222 W. Merchandise Mart Plaza, Chicago IL 60654 USA

1.2 Manufacturer

Motorola Mobility, LLC
222 W. Merchandise Mart Plaza, Chicago IL 60654 USA

1.3 Product Feature of Equipment Under Test

Product Feature	
Equipment	Mobile Cellular Phone
Brand Name	Motorola
Model Name	4241
FCC ID	IHDT56QC8
IMEI Code	990005450012555
EUT supports Radios application	CDMA/EV-DO/GSM/EGPRS/WCDMA/HSPA/LTE WLAN 11b/g/n (HT20) Bluetooth v2.1 EDR Bluetooth v4.0 - LE
HW Version	P2B
EUT Stage	Identical Prototype

Remark: The above EUT's information was declared by manufacturer. Please refer to the specifications or user's manual for more detailed description.

Accessory List	
AC Adapter	Brand Name : Motorola
	Model Name : SPN5810A

1.4 Product Specification subjective to this standard

Product Specification subjective to this standard	
Tx Frequency	GSM850: 824.2 MHz ~ 848.8 MHz GSM1900: 1850.2 MHz ~ 1909.8MHz WCDMA Band V: 826.4 MHz ~ 846.6 MHz WCDMA Band IV : 1712.4 MHz ~ 1752.6 MHz WCDMA Band II: 1852.4 MHz ~ 1907.6 MHz CDMA2000 BC0: 824.70 MHz ~ 848.31 MHz CDMA2000 BC1: 1851.25 MHz ~ 1908.75 MHz
Rx Frequency	GSM850: 869.2 MHz ~ 893.8 MHz GSM1900: 1930.2 MHz ~ 1989.8 MHz WCDMA Band V: 871.4 MHz ~ 891.6 MHz WCDMA Band IV : 2112.4 MHz ~ 2152.6 MHz WCDMA Band II: 1932.4 MHz ~ 1987.6 MHz CDMA2000 BC0: 869.70 MHz ~ 893.31 MHz CDMA2000 BC1: 1931.25 MHz ~ 1988.75 MHz
Maximum Output Power to Antenna	CDMA2000 BC0 : 24.48 dBm CDMA2000 BC1 : 23.94 dBm
Antenna Type	Fixed Internal Antenna
Type of Modulation	GSM: GMSK GPRS: GMSK EDGE: GMSK / 8PSK WCDMA: QPSK (Uplink) HSDPA: 64QAM (Downlink) HSUPA: QPSK (Uplink) CDMA2000 : QPSK CDMA2000 1xEV-DO : QPSK/8PSK

Remark: The GSM/EDGE 850, GSM/EDGE 1900, WCDMA Band V and WCDMA Band II test results refer to appendix A.

1.5 Modification of EUT

No modifications are made to the EUT during all test items.

1.6 Maximum ERP/EIRP Power, Frequency Tolerance, and Emission Designator

FCC Rule	System	Type of Modulation	Maximum ERP/EIRP (W)	Frequency Tolerance (ppm)	Emission Designator
Part 22	CDMA2000 BC0 1xRTT	QPSK	0.1268	0.0299 ppm	1M28F9W
Part 24	CDMA2000 BC1 1xRTT	QPSK	0.2679	0.0261 ppm	1M28F9W



1.7 Testing Location

Sporton Lab is accredited to ISO 17025 by Taiwan Accreditation Foundation (TAF code : 1190) and the FCC designation No. TW1022 under the FCC 2.948(e) by Mutual Recognition Agreement (MRA) in FCC Test.

Test Site	SPORTON INTERNATIONAL INC.	
Test Site Location	No. 52, Hwa Ya 1 st Rd., Hwa Ya Technology Park, Kwei-Shan Hsiang, Tao Yuan Hsien, Taiwan, R.O.C. TEL: +886-3-327-3456 FAX: +886-3-328-4978	
Test Site No.	Sporton Site No.	
	TH02-HY	03CH07-HY

1.8 Applicable Standards

According to the specifications of the manufacturer, the EUT must comply with the requirements of the following standards:

- ♦ FCC 47 CFR Part 2, 22(H), 24(E), 27(L)
- ♦ ANSI / TIA / EIA-603-C-2004
- ♦ FCC KDB 971168 D01 Power Meas. License Digital Systems v02r02

Remark:

1. All test items were verified and recorded according to the standards and without any deviation during the test.
2. This EUT has also been tested and complied with the requirements of FCC Part 15, Subpart B, recorded in a separate test report.



2 Test Configuration of Equipment Under Test

2.1 Test Mode

Antenna port conducted and radiated test items were performed according to KDB 971168 D01 Power Meas. License Digital Systems v02r02 with maximum output power.

Radiated measurements were performed with rotating EUT in different three orthogonal test planes to find the maximum emission.

Radiated emissions were investigated as following frequency range:

1. 30 MHz to 9000 MHz for CDMA2000 BC0.
2. 30 MHz to 19000 MHz for CDMA2000 BC1.

All modes and data rates and positions were investigated.

Test modes are chosen to be reported as the worst case configuration below:

Test Modes		
Band	Radiated TCs	Conducted TCs
CDMA2000 BC0	■ 1xRTT Link Mode	■ 1xRTT Link Mode
CDMA2000 BC1	■ 1xRTT Link Mode	■ 1xRTT Link Mode

Note:

The maximum power levels are chosen from the Conducted Power Measurement Results table for testing as the worst case configuration as follows

1xRTT mode for CDMA2000 BC0 and .CDMA BC1, only these modes were used for all tests.

Conducted Power Measurement Results:

Conducted Power (*Unit: dBm)						
Band	CDMA2000 BC0			CDMA2000 BC1		
Channel	1013	384	777	25	600	1175
Frequency	824.7	836.52	848.31	1851.25	1880	1908.75
1xRTT RC1 SO55	24.36	24.38	24.45	23.94	23.70	23.58
1xRTT RC3 SO55	24.30	24.43	24.42	23.74	23.74	23.65
1xRTT RC3 SO32(+ F-SCH)	24.35	24.40	24.40	23.70	23.70	23.60
1xRTT RC3 SO32(+SCH)	24.46	24.48	24.43	23.86	23.85	23.35
1xEV-DO RTAP 153.6kbps	24.34	24.34	24.43	23.90	23.77	23.75
1xEV-DO RETAP 4096Bits	24.37	24.40	24.46	23.84	23.73	23.70

2.2 Connection Diagram of Test System

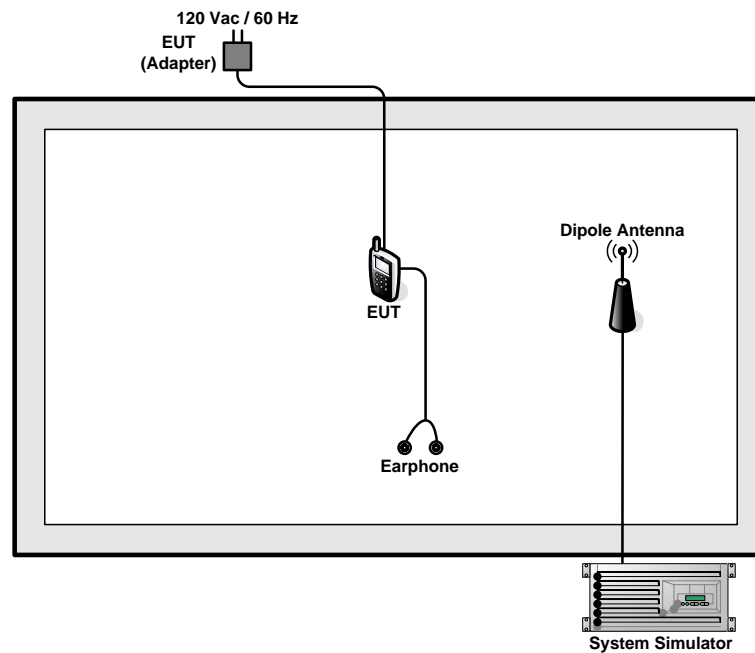

2.3 Support Unit used in test configuration

Item	Equipment	Trade Name	Model No.	FCC ID	Data Cable	Power Cord
1.	System Simulator	R&S	CMU 200	N/A	N/A	Unshielded, 1.8 m
2.	Earphone	MOTOROLA	SJYN1181B	N/A	Unshielded, 1 m	N/A

2.4 Measurement Results Explanation Example

For all conducted test items:

The offset level is set in the spectrum analyzer to compensate the RF cable loss and attenuator factor between RF conducted output port and spectrum analyzer. With the offset compensation, the spectrum analyzer reading level will be exactly the RF output level.

The spectrum analyzer offset is derived from RF cable loss and attenuator factor.

Offset = RF cable loss + attenuator factor.

The following shows an offset computation example with RF cable loss 4.2 dB and a 10dB attenuator.

Example :

$$\begin{aligned} \text{Offset(dB)} &= \text{RF cable loss(dB)} + \text{attenuator factor(dB)} \\ &= 4.2 + 10 = 14.2 \text{ (dB)} \end{aligned}$$

3 Test Result

3.1 Conducted Output Power Measurement

3.1.1 Description of the Conducted Output Power Measurement

A system simulator was used to establish communication with the EUT. Its parameters were set to enforce EUT transmitting at the maximum power. The measured power in the radio frequency on the transmitter output terminals shall be reported.

3.1.2 Measuring Instruments

The measuring equipment is listed in the section 4 of this test report.

3.1.3 Test Procedures

1. The transmitter output port was connected to the system simulator.
2. Set EUT at maximum power through system simulator.
3. Select lowest, middle, and highest channels for each band and different modulation.
4. Measure the maximum burst average power for GSM and maximum average power for other modulation signal.

3.1.4 Test Setup

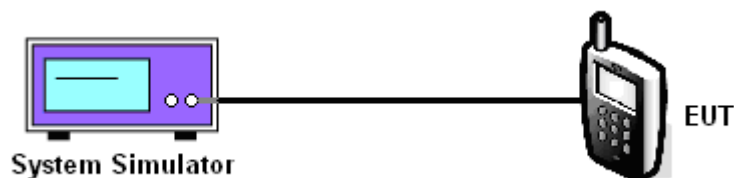



3.1.5 Test Result of Conducted Output Power

CDMA2000 BC0			
Test Mode	CDMA 2000 1xRTT		
Test Status	RC3+SO32		
Channel	1013 (Low)	384 (Mid)	777 (High)
Frequency (MHz)	824.70	836.52	848.31
Conducted Power (dBm)	24.46	24.48	24.43

CDMA2000 BC1			
Test Mode	CDMA 2000 1xRTT		
Test Status	RC1+SO55		
Channel	25 (Low)	600 (Mid)	1175 (High)
Frequency (MHz)	1851.25	1880.00	1908.75
Conducted Power (dBm)	23.94	23.70	23.58

Note: maximum average power for CDMA2000.

3.2 Peak-to-Average Ratio

3.2.1 Description of the PAR Measurement

The peak-to-average ratio (PAR) of the transmission may not exceed 13 dB.

3.2.2 Measuring Instruments

The measuring equipment is listed in the section 4 of this test report.

3.2.3 Test Procedures

1. The EUT was connected to spectrum analyzer and system simulator via a power divider.
2. Set EUT to transmit at maximum output power.
3. Set the CCDF (Complementary Cumulative Distribution Function) option of the spectrum analyzer.
Record the maximum PAPR level associated with a probability of 0.1%.

3.2.4 Test Setup

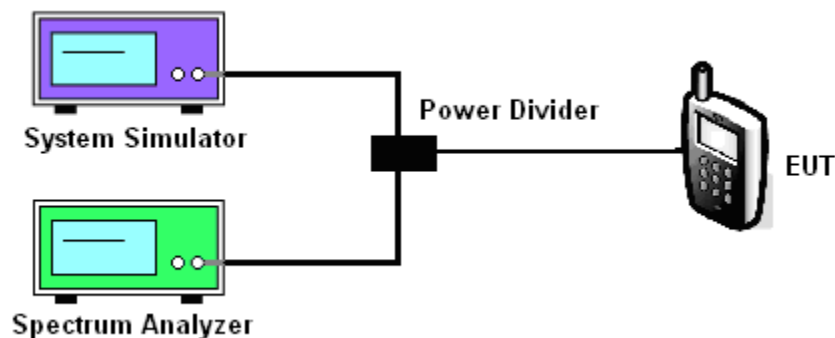



3.2.5 Test Result of Peak-to-Average Ratio

CDMA2000 BC0			
Modes	CDMA 2000 1xRTT		
Channel	1013 (Low)	384 (Mid)	777 (High)
Frequency (MHz)	824.70	836.52	848.31
Peak-to-Average Ratio (dB)	4.12	4.00	3.76

CDMA2000 BC1			
Modes	CDMA 2000 1xRTT		
Channel	25 (Low)	600 (Mid)	1175 (High)
Frequency (MHz)	1851.25	1880	1908.75
Peak-to-Average Ratio (dB)	4.24	4.44	4.24



3.2.6 Test Result (Plots) of Peak-to-Average Ratio

Band :	CDMA2000 BC0	Test Mode :	1xRTT Link (QPSK)
--------	--------------	-------------	-------------------

Peak-to-Average Ratio on Channel 1013 (824.70 MHz)

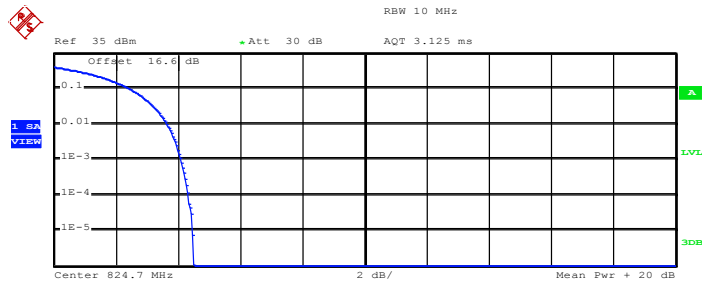

Complementary Cumulative Distribution Function (100000 samples)
 Trace 1
 Mean 23.99 dBm
 Peak 28.48 dBm
 Crest 4.49 dB

10 %	2.48 dB
1 %	3.64 dB
.1 %	4.12 dB
.01 %	4.32 dB

Date: 23.DEC.2014 11:13:59

Peak-to-Average Ratio on Channel 384 (836.52 MHz)

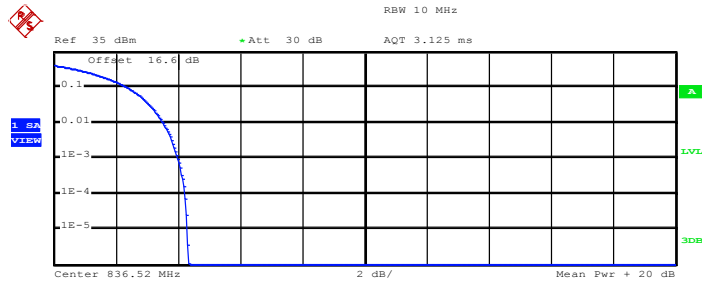

Complementary Cumulative Distribution Function (100000 samples)
 Trace 1
 Mean 24.16 dBm
 Peak 28.48 dBm
 Crest 4.32 dB

10 %	2.40 dB
1 %	3.52 dB
.1 %	4.00 dB
.01 %	4.24 dB

Date: 23.DEC.2014 11:14:31



Peak-to-Average Ratio on Channel 777 (848.31 MHz)

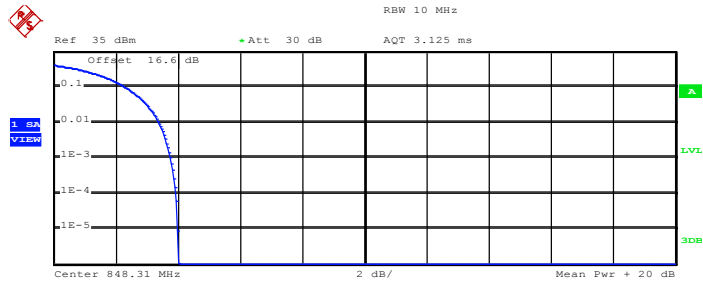

Complementary Cumulative Distribution Function (100000 samples)

Trace 1
 Mean 24.13 dBm
 Peak 28.13 dBm
 Crest 4.00 dB

10 %	2.32 dB
1 %	3.40 dB
.1 %	3.76 dB
.01 %	3.96 dB

Date: 23.DEC.2014 11:15:00



Band :	CDMA2000 BC1	Test Mode :	1xRTT Link (QPSK)
---------------	--------------	--------------------	-------------------

Peak-to-Average Ratio on Channel 25 (1851.25 MHz)

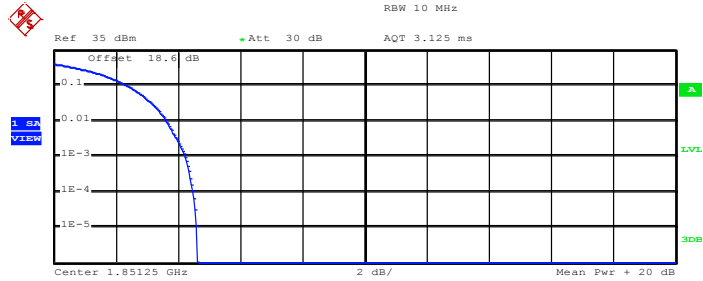

Complementary Cumulative Distribution Function (100000 samples)

Trace 1

Mean	22.88 dBm
Peak	27.49 dBm
Crest	4.61 dB
10 %	2.40 dB
1 %	3.64 dB
.1 %	4.24 dB
.01 %	4.48 dB

Date: 24.DEC.2014 10:22:55

Peak-to-Average Ratio on Channel 600 (1880 MHz)

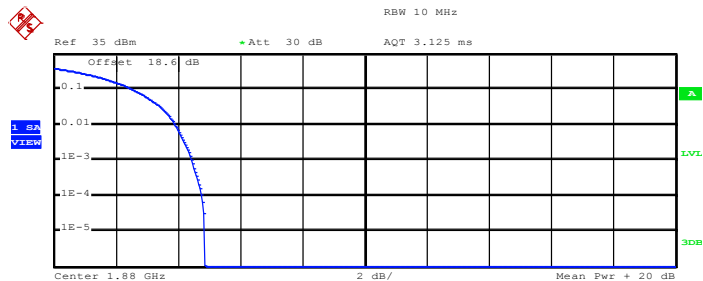

Complementary Cumulative Distribution Function (100000 samples)

Trace 1

Mean	22.48 dBm
Peak	27.35 dBm
Crest	4.87 dB
10 %	2.60 dB
1 %	3.92 dB
.1 %	4.44 dB
.01 %	4.76 dB

Date: 24.DEC.2014 10:23:25



Peak-to-Average Ratio on Channel 1175 (1908.75 MHz)

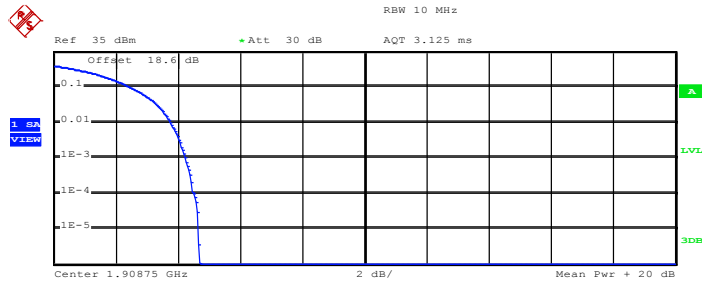

Complementary Cumulative Distribution Function (100000 samples)

Trace 1
 Mean 22.46 dBm
 Peak 27.14 dBm
 Crest 4.68 dB

10 % 2.52 dB
 1 % 3.76 dB
 .1 % 4.24 dB
 .01 % 4.52 dB

Date: 24.DEC.2014 10:23:50



3.3 Effective Radiated Power and Effective Isotropic Radiated Power Measurement

3.3.1 Description of the ERP/EIRP Measurement

The substitution method, in ANSI / TIA / EIA-603-C-2004, was used for ERP/EIRP measurement, and the spectrum analyzer configuration follows KDB 971168 D01 Power Meas. License Digital Systems v02r02. The ERP of mobile transmitters must not exceed 7 Watts (Cellular Band) and the EIRP of mobile transmitters are limited to 2 Watts (PCS Band) and 1 Watts (AWS Band).

3.3.2 Measuring Instruments

The measuring equipment is listed in the section 4 of this test report.

3.3.3 Test Procedures

1. The testing follows FCC KDB 971168 v02r02 Section 5.2.1. (for CDMA/WCDMA), Section 5.2.2.2 (for GSM/GPRS/EDGE) and ANSI / TIA-603-C-2004 Section 2.2.17.
2. The EUT was placed on a non-conductive rotating platform 0.8 meters high in a semi-anechoic chamber. The radiated emission at the fundamental frequency was measured at 3 m with a test antenna and a spectrum analyzer with RMS detector per section 5. of KDB 971168 D01.
3. During the measurement, the system simulator parameters were set to force the EUT transmitting at maximum output power. The maximum emission was recorded from analyzer power level (LVL) from the 360 degrees rotation of the turntable and the test antenna raised and lowered over a range from 1 to 4 meters in both horizontally and vertically polarized orientations.
4. Effective Isotropic Radiated Power (EIRP) was measured by substitution method according to TIA/EIA-603-C. The EUT was replaced by dipole antenna (substitution antenna) at the same location, and then a known power from S.G. was applied into the dipole antenna through a Tx cable, and then recorded the maximum Analyzer reading through raised and lowered the test antenna. The correction factor (in dB) = S.G. - Tx Cable loss + Substitution antenna gain - Analyzer reading. Then the EUT's EIRP was calculated with the correction factor, $EIRP = LVL + \text{Correction factor}$ and $ERP = EIRP - 2.15$.

	CDMA2000/EV-DO
SPAN	3MHz
RBW	30kHz
VBW	100kHz
Detector	RMS
Trace	Average
Average Type	Power
Sweep Count	100

3.3.4 Test Setup

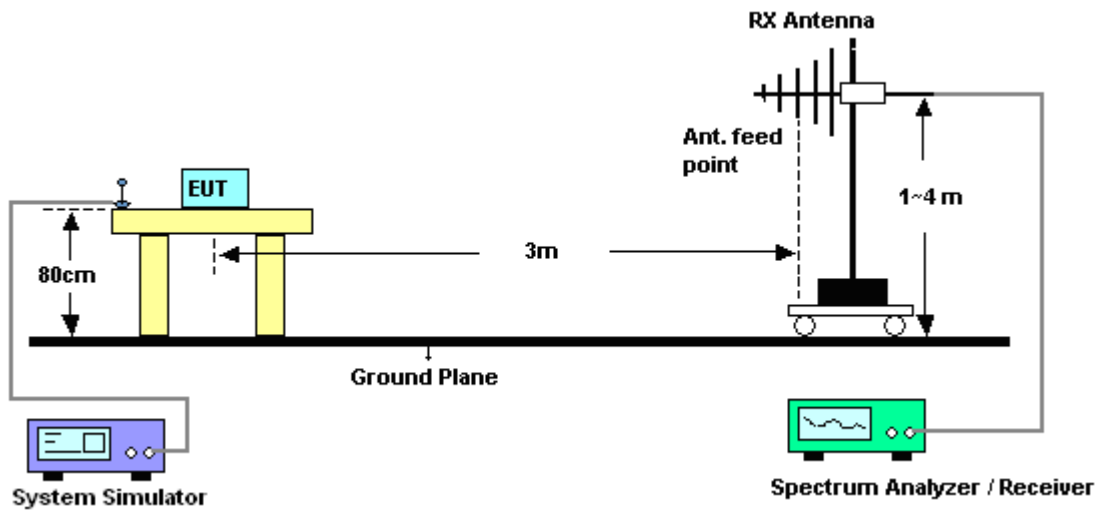



3.3.5 Test Result of ERP

CDMA2000 BC0 1xRTT_RC3+SO32 Radiated Power ERP				
Horizontal Polarization				
Frequency (MHz)	LVL (dBm)	Correction Factor (dB)	ERP (dBm)	ERP (W)
824.70	-20.00	31.35	9.20	0.0083
836.52	-21.73	32.13	8.25	0.0067
848.31	-19.89	32.64	10.60	0.0115
Vertical Polarization				
Frequency (MHz)	LVL (dBm)	Correction Factor (dB)	ERP (dBm)	ERP (W)
824.70	-11.25	32.83	19.43	0.0877
836.52	-11.80	32.81	18.86	0.0769
848.31	-10.34	33.52	21.03	0.1268

* ERP = LVL (dBm) + Correction Factor (dB) – 2.15

CDMA2000 BC0 1xEV-DO Rev. A_RETAP 4096K Radiated Power ERP				
Horizontal Polarization				
Frequency (MHz)	LVL (dBm)	Correction Factor (dB)	ERP (dBm)	ERP (W)
824.70	-21.24	31.35	7.96	0.0063
836.52	-21.72	32.13	8.26	0.0067
848.31	-21.69	32.64	8.80	0.0076
Vertical Polarization				
Frequency (MHz)	LVL (dBm)	Correction Factor (dB)	ERP (dBm)	ERP (W)
824.70	-12.18	32.83	18.50	0.0708
836.52	-11.16	32.81	19.50	0.0891
848.31	-11.68	33.52	19.69	0.0931

* ERP = LVL (dBm) + Correction Factor (dB) – 2.15



3.3.6 Test Result of EIRP

CDMA2000 BC1 1xRTT_RC1+SO55 Radiated Power EIRP				
Horizontal Polarization				
Frequency (MHz)	LVL (dBm)	Correction Factor (dB)	EIRP (dBm)	EIRP (W)
1851.25	-20.69	43.92	23.23	0.2104
1880.00	-22.09	44.79	22.70	0.1862
1908.75	-21.65	43.75	22.10	0.1622
Vertical Polarization				
Frequency (MHz)	LVL (dBm)	Correction Factor (dB)	EIRP (dBm)	EIRP (W)
1851.25	-21.94	45.35	23.41	0.2193
1880.00	-23.25	46.78	23.53	0.2254
1908.75	-22.46	46.74	24.28	0.2679

* EIRP = LVL (dBm) + Correction Factor (dB)

CDMA2000 BC1 1xEV-DO Rev. 0_RTAP 153.6K Radiated Power EIRP				
Horizontal Polarization				
Frequency (MHz)	LVL (dBm)	Correction Factor (dB)	EIRP (dBm)	EIRP (W)
1851.25	-21.69	43.92	22.23	0.1671
1880.00	-22.93	44.79	21.86	0.1535
1908.75	-22.37	43.75	21.38	0.1374
Vertical Polarization				
Frequency (MHz)	LVL (dBm)	Correction Factor (dB)	EIRP (dBm)	EIRP (W)
1851.25	-23.03	45.35	22.32	0.1706
1880.00	-24.07	46.78	22.71	0.1866
1908.75	-23.33	46.74	23.41	0.2193

* EIRP = LVL (dBm) + Correction Factor (dB)

3.4 99% Occupied Bandwidth and 26dB Bandwidth Measurement

3.4.1 Description of 99% Occupied Bandwidth and 26dB Bandwidth Measurement

The 99% occupied bandwidth is the width of a frequency band such that, below the lower and above the upper frequency limits, the mean powers emitted are each equal to a specified percentage 0.5% of the total mean transmitted power.

The emission bandwidth is defined as the width of the signal between two points, located at the 2 sides of the carrier frequency, outside of which all emissions are attenuated at least 26 dB below the transmitter power.

3.4.2 Measuring Instruments

The measuring equipment is listed in the section 4 of this test report.

3.4.3 Test Procedures

1. The testing follows FCC KDB 971168 v02r02 Section 4.2.
2. The EUT was connected to the spectrum analyzer and system simulator via a power divider.
3. The RF output of the EUT was connected to the spectrum analyzer by RF cable and attenuator. The path loss was compensated to the results for each measurement.
4. The 99% occupied bandwidth were measured, set RBW= 1% of span, VBW= 3*RBW, sample detector, trace maximum hold.
5. The 26dB bandwidth were measured, set RBW= 1% of EBW, VBW= 3*RBW, peak detector, trace maximum hold.

3.4.4 Test Setup

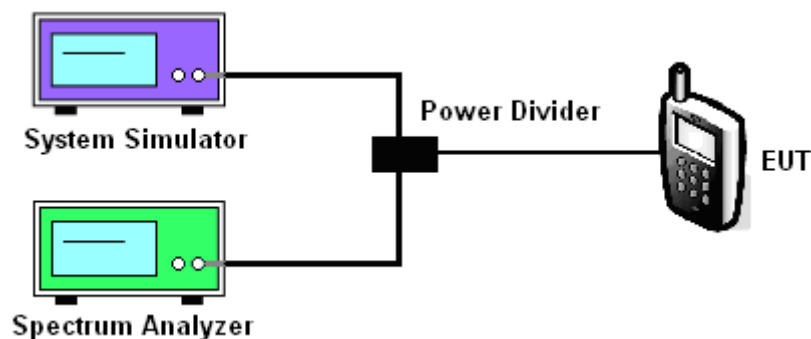



3.4.5 Test Result of Occupied Bandwidth and 26dB Bandwidth

CDMA2000 BC0			
Test Mode	CDMA 2000 1xRTT		
Test Status	RC3+SO32		
Channel	1013 (Low)	384 (Mid)	777 (High)
Frequency (MHz)	824.70	836.52	848.31
99% OBW (MHz)	1.27	1.28	1.28
26dB BW (MHz)	1.41	1.41	1.42

CDMA2000 BC1			
Test Mode	CDMA 2000 1xRTT		
Test Status	RC1+SO55		
Channel	25 (Low)	600 (Mid)	1175 (High)
Frequency (MHz)	1851.25	1880.00	1908.75
99% OBW (MHz)	1.28	1.27	1.28
26dB BW (MHz)	1.42	1.41	1.41



3.4.6 Test Result (Plots) of Occupied Bandwidth and 26dB Bandwidth

Band :	CDMA2000 BC0	Test Mode :	1xRTT_RC3+SO32 (QPSK)
--------	--------------	-------------	-----------------------

99% Occupied Bandwidth Plot on Channel 1013 (824.7 MHz)

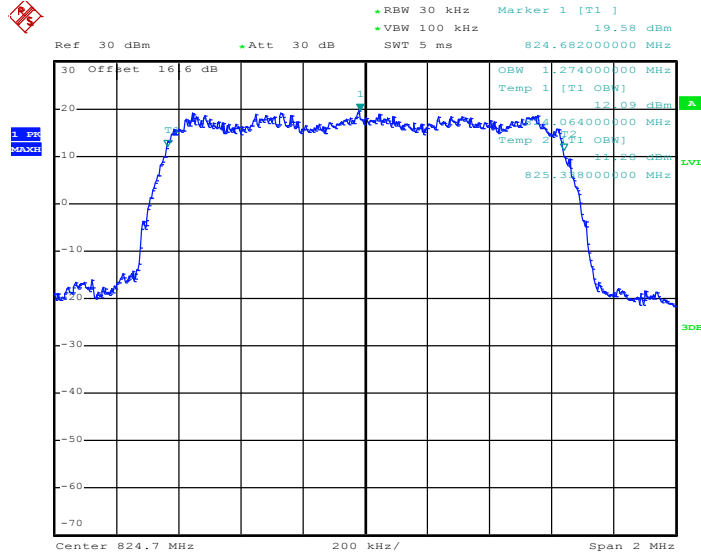

Date: 23.DEC.2014 11:05:18

26dB Bandwidth Plot on Channel 1013 (824.7 MHz)

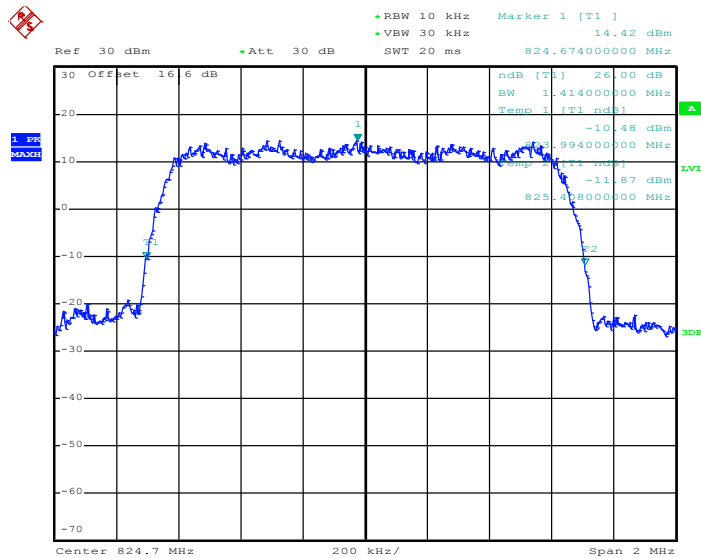

Date: 23.DEC.2014 11:03:14



99% Occupied Bandwidth Plot on Channel 384 (836.52 MHz)

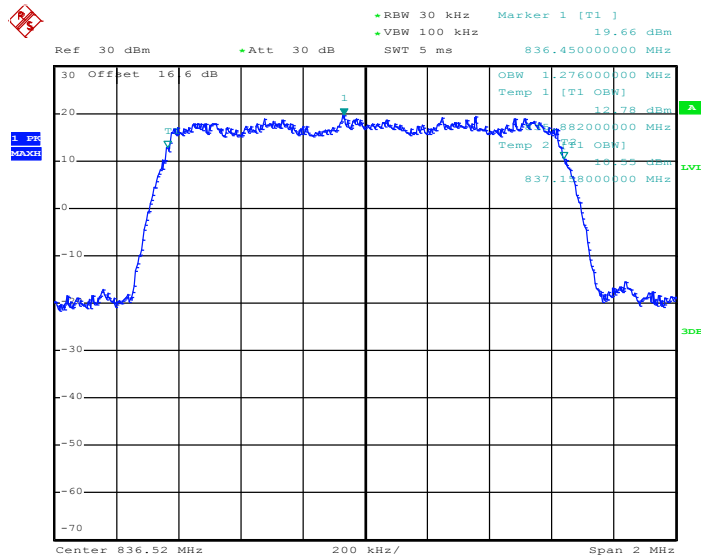

Date: 23.DEC.2014 11:05:54

26dB Bandwidth Plot on Channel 384 (836.52 MHz)

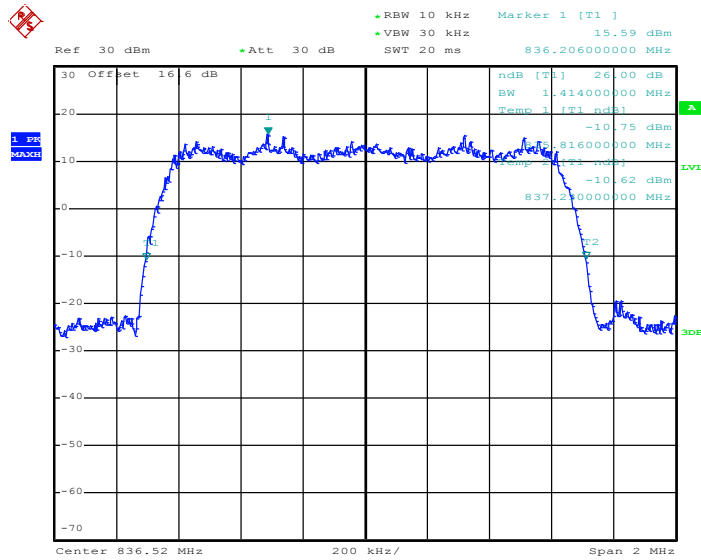

Date: 23.DEC.2014 11:03:42



99% Occupied Bandwidth Plot on Channel 777 (848.31 MHz)

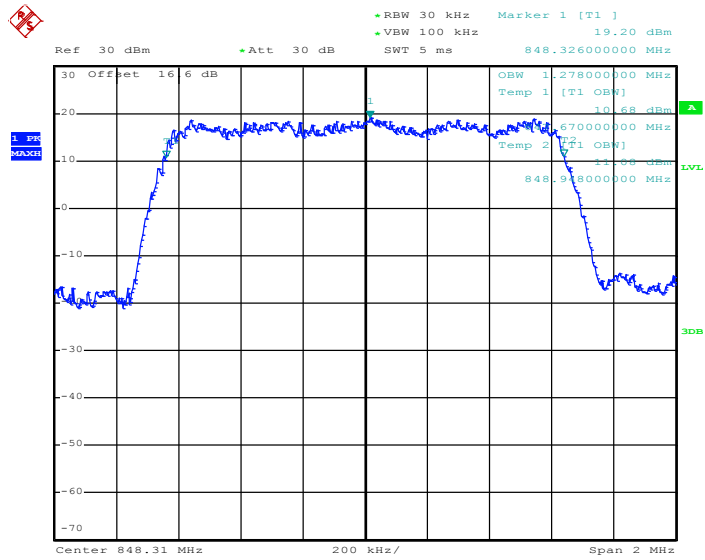

Date: 23.DEC.2014 11:06:28

26dB Bandwidth Plot on Channel 777 (848.31 MHz)

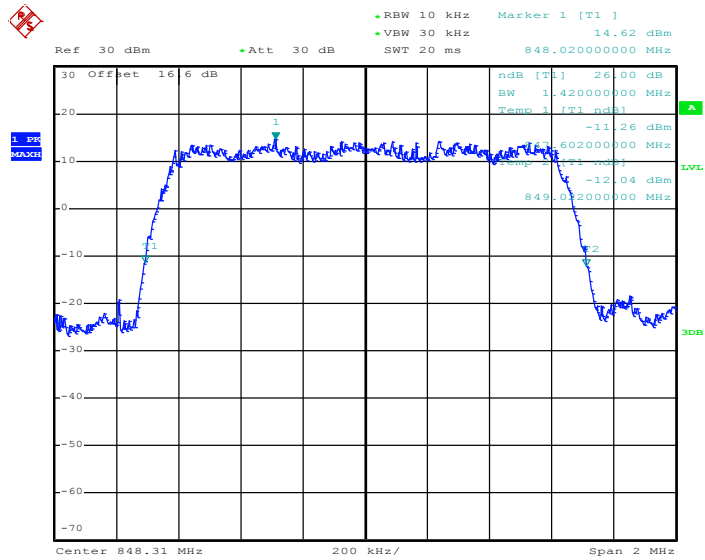

Date: 23.DEC.2014 11:04:10



Band :	CDMA2000 BC1	Test Mode :	1xRTT_RC1+SO55 (QPSK)
---------------	--------------	--------------------	-----------------------

99% Occupied Bandwidth Plot on Channel 25 (1851.25 MHz)

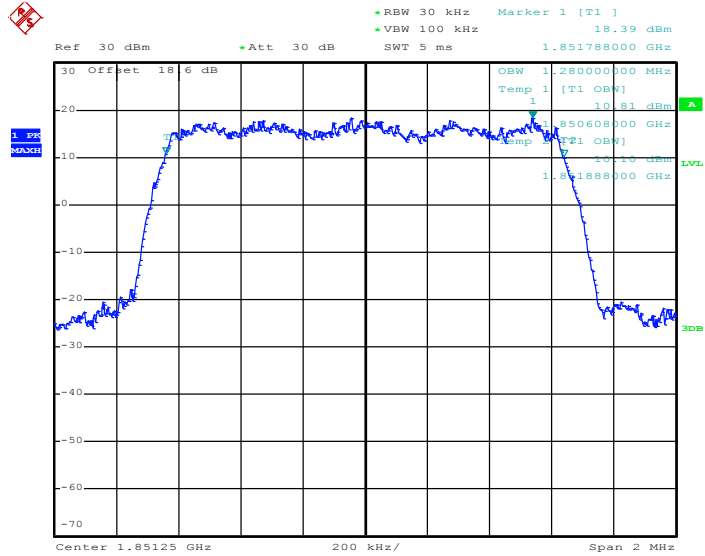

Date: 24.DEC.2014 10:17:17

26dB Bandwidth Plot on Channel 25 (1851.25 MHz)

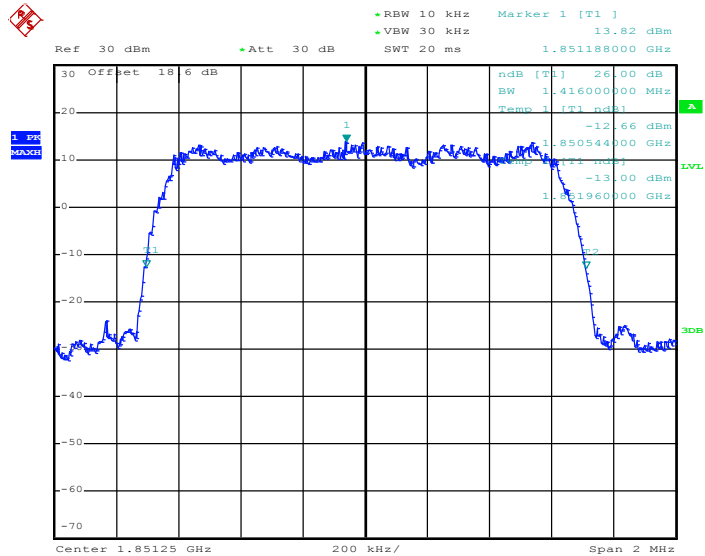

Date: 24.DEC.2014 10:13:48



99% Occupied Bandwidth Plot on Channel 600 (1880.0 MHz)

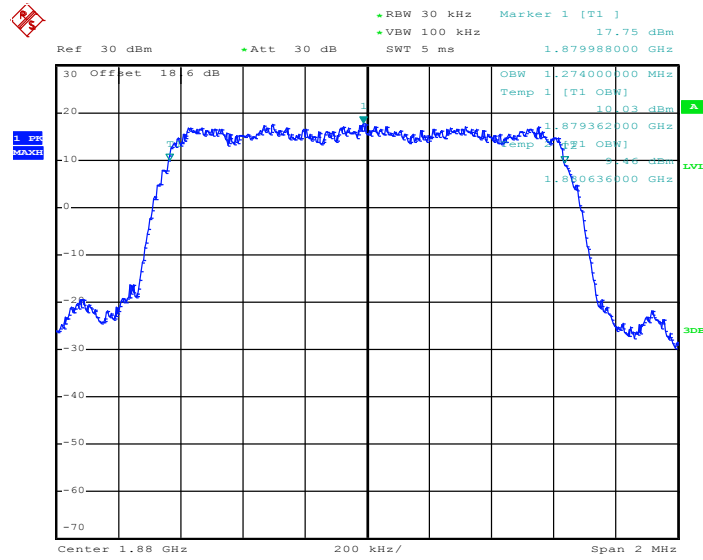

Date: 24.DEC.2014 10:17:59

26dB Bandwidth Plot on Channel 600 (1880.0 MHz)

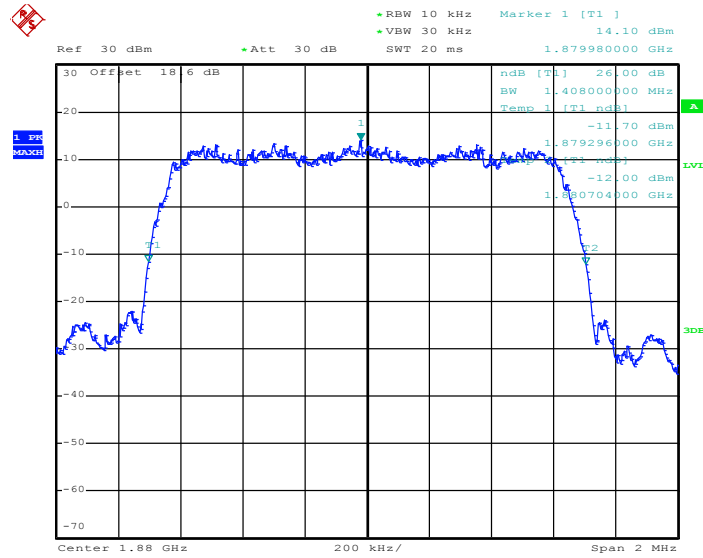

Date: 24.DEC.2014 10:14:34



99% Occupied Bandwidth Plot on Channel 1175 (1908.75 MHz)

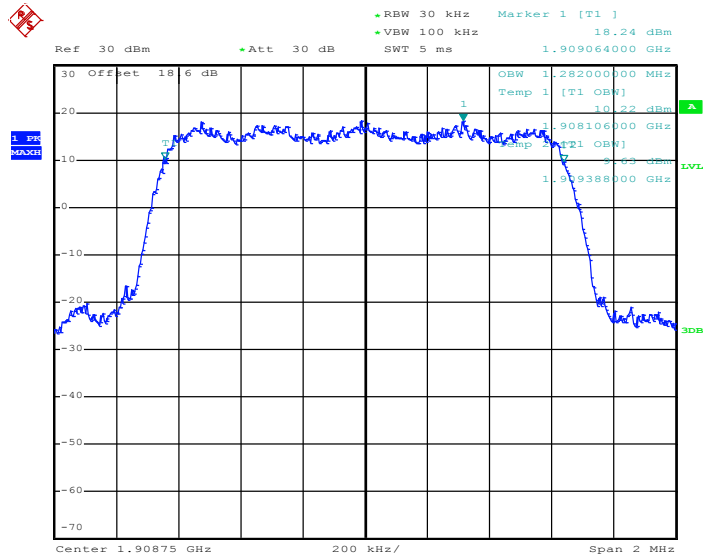

Date: 24.DEC.2014 10:18:43

26dB Bandwidth Plot on Channel 1175 (1908.75 MHz)

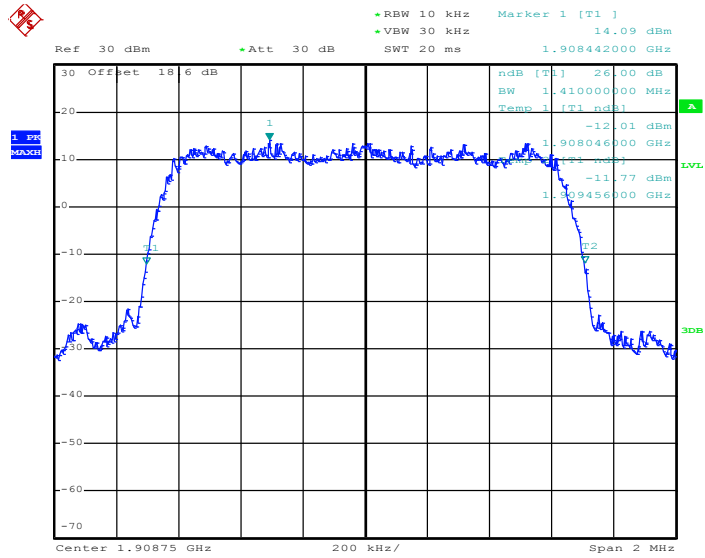

Date: 24.DEC.2014 10:15:24

3.5 Band Edge Measurement

3.5.1 Description of Band Edge Measurement

The power of any emission outside of the authorized operating frequency ranges must be lower than the transmitter power (P) by a factor of at least $43 + 10 \log (P)$ dB.

3.5.2 Measuring Instruments

The measuring equipment is listed in the section 4 of this test report.

3.5.3 Test Procedures

1. The testing follows FCC KDB 971168 v02r02 Section 6.0.
2. The EUT was connected to the spectrum analyzer and system simulator via a power divider.
3. The RF output of EUT was connected to the spectrum analyzer by an RF cable and attenuator. The path loss was compensated to the results for each measurement.
4. The band edges of low and high channels for the highest RF powers were measured.
5. The RF fundamental frequency should be excluded against the limit line in the operating frequency band.
6. The limit line is derived from $43 + 10\log(P)$ dB below the transmitter power P(Watts)
 $= P(W) - [43 + 10\log(P)]$ (dB)
 $= [30 + 10\log(P)]$ (dBm) - $[43 + 10\log(P)]$ (dB)
 $= -13\text{dBm}$.

3.5.4 Test Setup

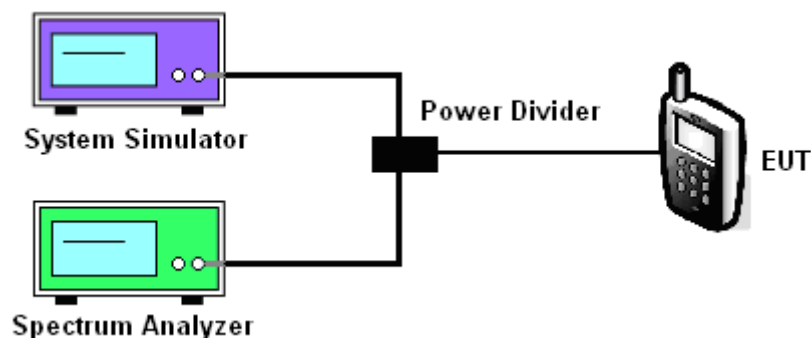



3.5.5 Test Result (Plots) of Conducted Band Edge

Band :	CDMA2000 BC0	Test Mode :	1xRTT_RC3+SO32 (QPSK)
--------	--------------	-------------	-----------------------

Lower Band Edge Plot on Channel 1013 (824.7 MHz)

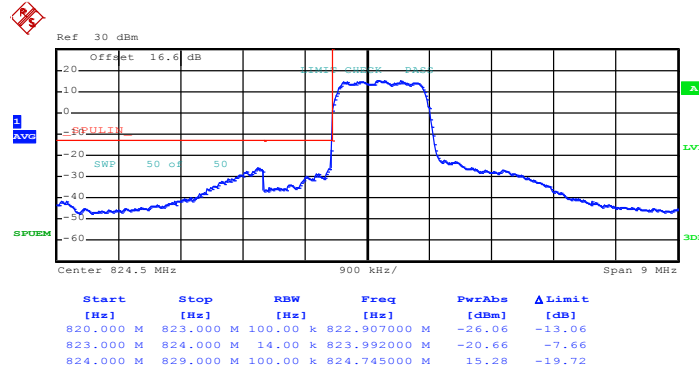

Date: 23.DEC.2014 11:54:50

Higher Band Edge Plot on Channel 777 (848.31 MHz)

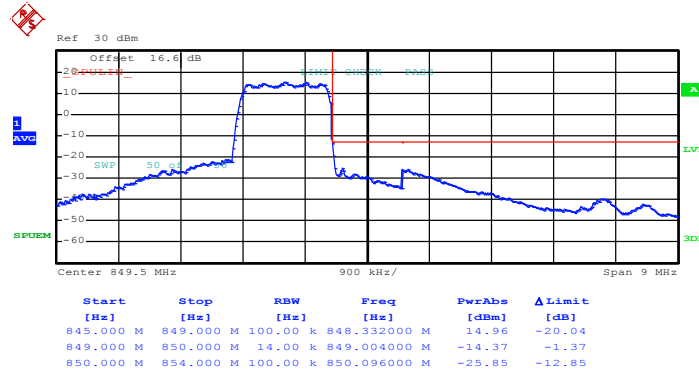

Date: 23.DEC.2014 11:47:04



Band :	CDMA2000 BC1	Test Mode :	1xRTT_RC1+SO55 (QPSK)
---------------	--------------	--------------------	-----------------------

Lower Band Edge Plot on Channel 25 (1851.25 MHz)

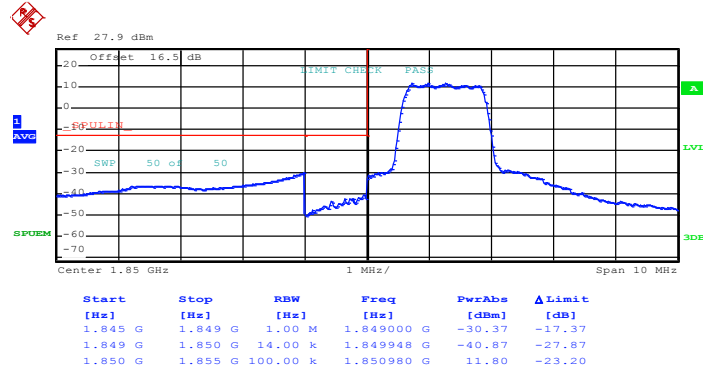

Date: 24.DEC.2014 10:28:48

Higher Band Edge Plot on Channel 1175 (1908.75 MHz)

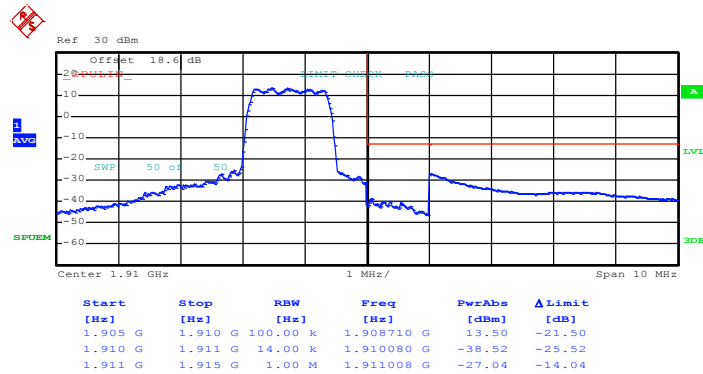

Date: 24.DEC.2014 10:26:55

3.6 Conducted Spurious Emission Measurement

3.6.1 Description of Conducted Spurious Emission Measurement

The power of any emission outside of the authorized operating frequency ranges must be lower than the transmitter power (P) by a factor of at least $43 + 10 \log (P)$ dB.

It is measured by means of a calibrated spectrum analyzer and scanned from 30 MHz up to a frequency including its 10th harmonic.

3.6.2 Measuring Instruments

The measuring equipment is listed in the section 4 of this test report.

3.6.3 Test Procedures

1. The testing follows FCC KDB 971168 v02r02 Section 6.0.
2. The EUT was connected to the spectrum analyzer and system simulator via a power divider.
3. The RF output of EUT was connected to the spectrum analyzer by an RF cable and attenuator. The path loss was compensated to the results for each measurement.
4. The middle channel for the highest RF power within the transmitting frequency was measured.
5. The conducted spurious emission for the whole frequency range was taken.
6. The RF fundamental frequency should be excluded against the limit line in the operating frequency band.
7. The limit line is derived from $43 + 10\log(P)$ dB below the transmitter power P(Watts)

$$= P(W) - [43 + 10\log(P)] \text{ (dB)}$$

$$= [30 + 10\log(P)] \text{ (dBm)} - [43 + 10\log(P)] \text{ (dB)}$$

$$= -13\text{dBm}.$$

3.6.4 Test Setup

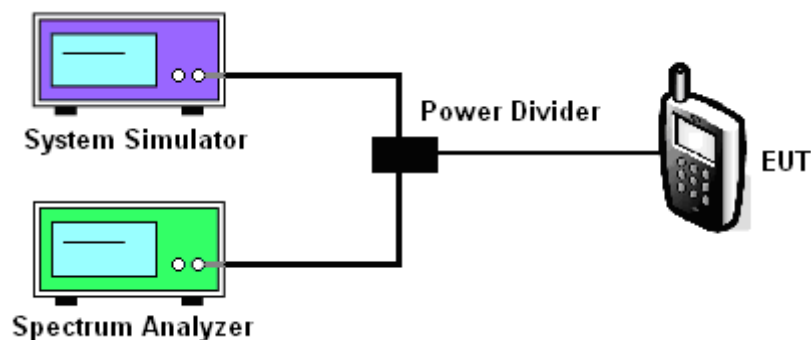



3.6.5 Test Result (Plots) of Conducted Spurious Emission

Band :	CDMA2000 BC0	Channel :	CH1013
Test Mode :	1xRTT_RC3+SO32 (QPSK)	Frequency :	824.7 MHz

Conducted Spurious Emission Plot between 30MHz ~ 9GHz

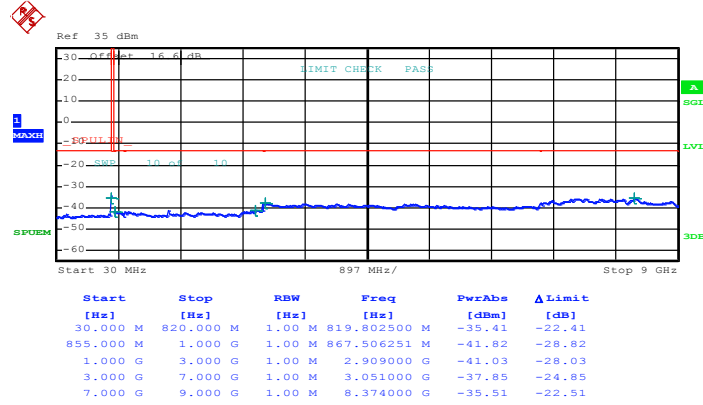

Date: 23.DEC.2014 11:11:08



Band :	CDMA2000 BC0	Channel :	CH384
Test Mode :	1xRTT_RC3+SO32 (QPSK)	Frequency :	836.52 MHz

Conducted Spurious Emission Plot between 30MHz ~ 9GHz

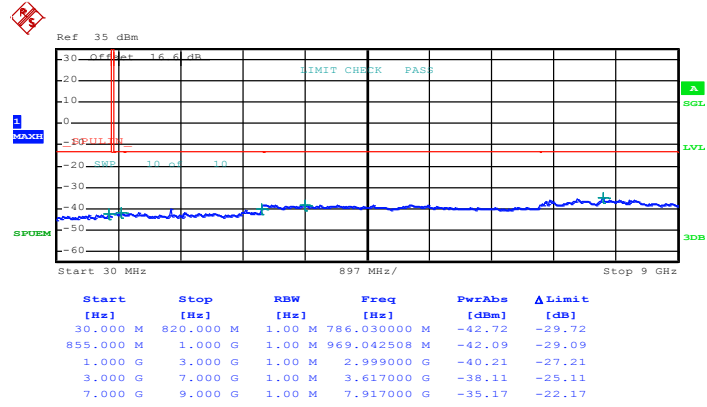

Date: 23.DEC.2014 11:11:50



Band :	CDMA2000 BC0	Channel :	CH777
Test Mode :	1xRTT_RC3+SO32 (QPSK)	Frequency :	848.31 MHz

Conducted Spurious Emission Plot between 30MHz ~ 9GHz

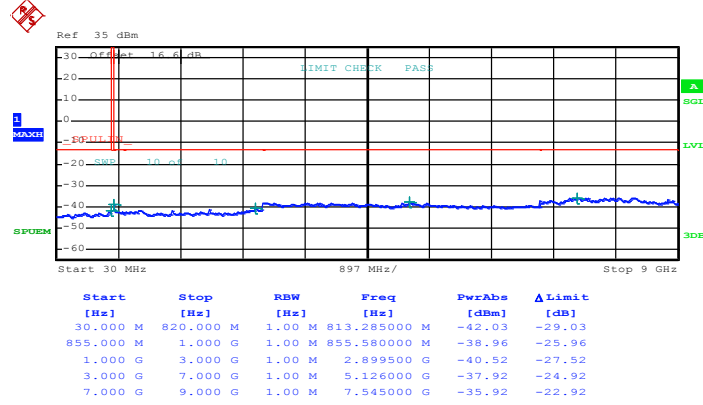

Date: 23.DEC.2014 11:12:34



Band :	CDMA2000 BC1	Channel :	CH25
Test Mode :	1xRTT_RC1+SO55 (QPSK)	Frequency :	1851.25 MHz

Conducted Spurious Emission Plot between 30MHz ~ 19.1GHz

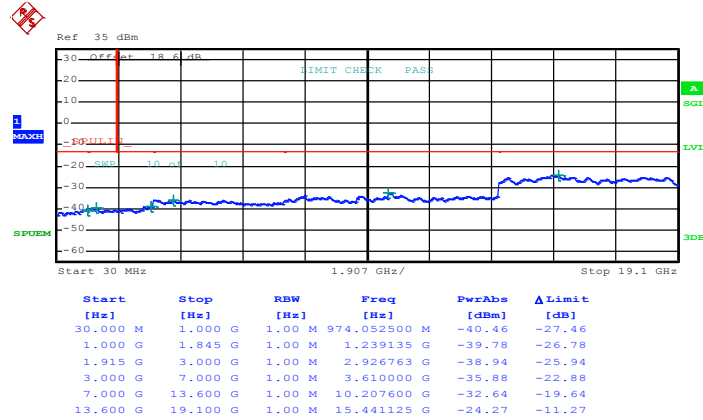

Date: 24.DEC.2014 10:20:59



Band :	CDMA2000 BC1	Channel :	CH600
Test Mode :	1xRTT_RC1+SO55 (QPSK)	Frequency :	1880.0 MHz

Conducted Spurious Emission Plot between 30MHz ~ 19.1GHz

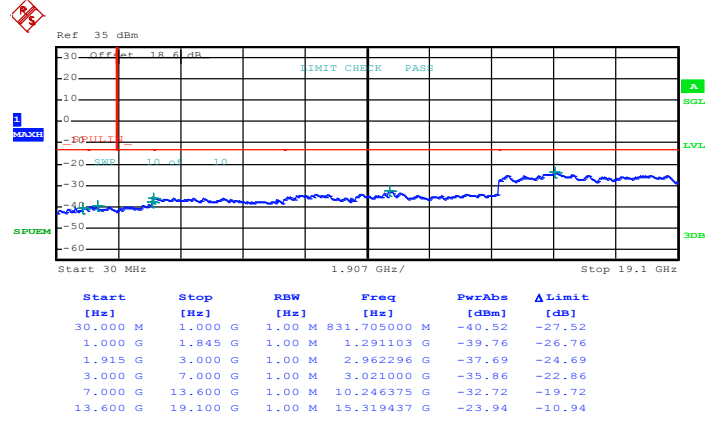

Date: 24.DEC.2014 10:21:36



Band :	CDMA2000 BC1	Channel :	CH1175
Test Mode :	1xRTT_RC1+SO55 (QPSK)	Frequency :	1908.75 MHz

Conducted Spurious Emission Plot between 30MHz ~ 19.1GHz

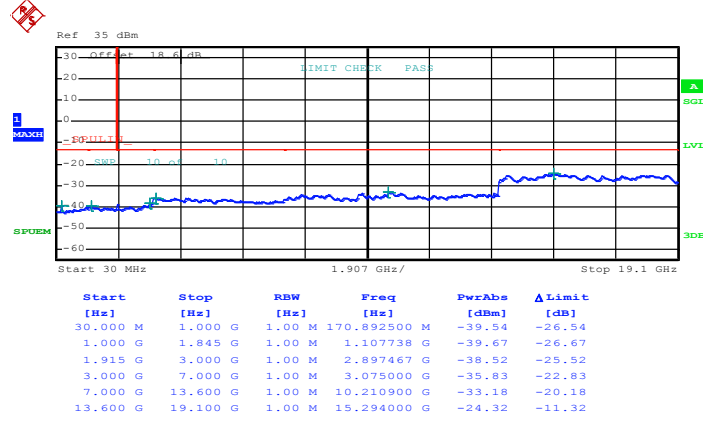

Date: 24.DEC.2014 10:22:17



3.7 Field Strength of Spurious Radiation Measurement

3.7.1 Description of Field Strength of Spurious Radiated Measurement

The power of any emission outside of the authorized operating frequency ranges must be attenuated below the transmitter power (P) by a factor of at least $43 + 10 \log (P)$ dB. The spectrum is scanned from 30 MHz up to a frequency including its 10th harmonic.

3.7.2 Measuring Instruments

The measuring equipment is listed in the section 4 of this test report.

3.7.3 Test Procedures

1. The testing follows FCC KDB 971168 v02r02 Section 5.8 and ANSI / TIA-603-C-2004 Section 2.2.12.
2. The EUT was placed on a rotatable wooden table 0.8 meters above the ground.
3. The EUT was set 3 meters from the receiving antenna, which was mounted on the antenna tower.
4. The table was rotated 360 degrees to determine the position of the highest spurious emission.
5. The height of the receiving antenna is varied between one meter and four meters to search for the maximum spurious emission for both horizontal and vertical polarizations.
6. Make the measurement with the spectrum analyzer's RBW = 1MHz, VBW = 3MHz, taking record of maximum spurious emission.
7. A horn antenna was substituted in place of the EUT and was driven by a signal generator.
8. Tune the output power of signal generator to the same emission level with EUT maximum spurious emission.
9. Taking the record of output power at antenna port.
10. Repeat step 7 to step 8 for another polarization.
11. $EIRP \text{ (dBm)} = S.G. \text{ Power} - Tx \text{ Cable Loss} + Tx \text{ Antenna Gain}$
12. $ERP \text{ (dBm)} = EIRP - 2.15$
13. The RF fundamental frequency should be excluded against the limit line in the operating frequency band.
14. The limit line is derived from $43 + 10\log(P)$ dB below the transmitter power P(Watts)
 $= P(W) - [43 + 10\log(P)] \text{ (dB)}$
 $= [30 + 10\log(P)] \text{ (dBm)} - [43 + 10\log(P)] \text{ (dB)}$
 $= -13dBm.$

3.7.4 Test Setup

For radiated emissions from 30MHz to 1GHz

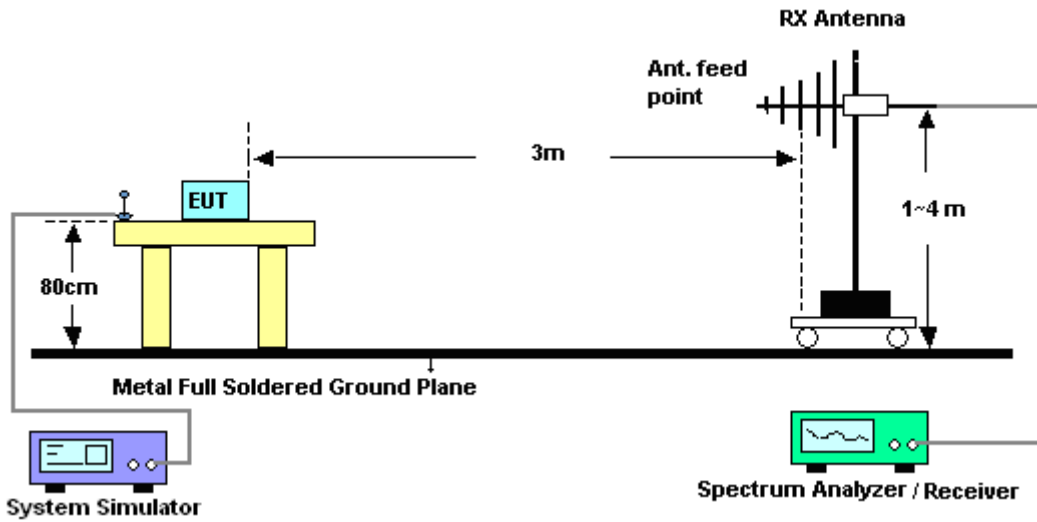

For radiated emissions above 1GHz

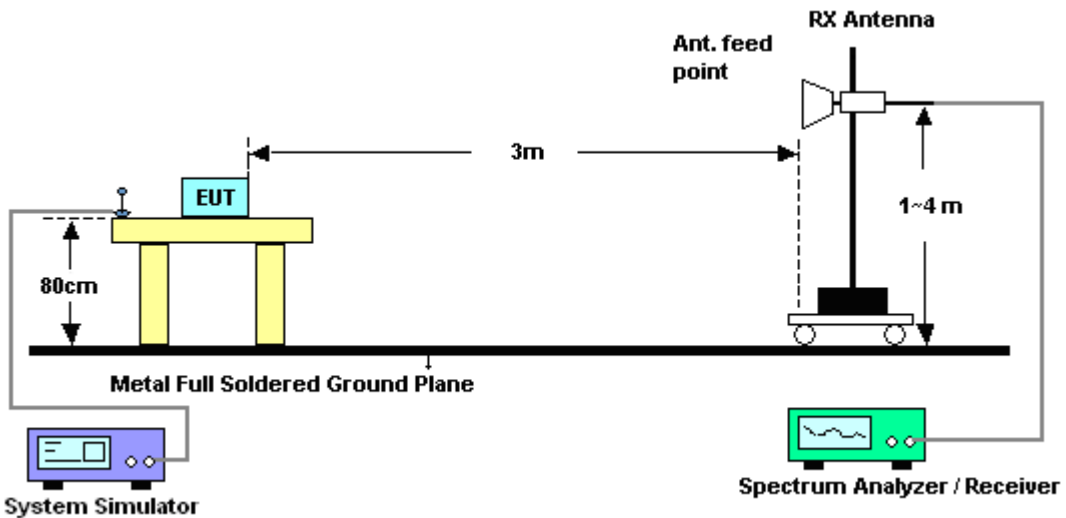



3.7.5 Test Result of Field Strength of Spurious Radiated

<Low Channel>

Band :	CDMA2000 BC0						Temperature :	23~24°C	
Test Mode :	1xRTT_RC3+SO32 (QPSK)						Relative Humidity :	46~48%	
Test Engineer :	Ken Wu						Polarization :	Horizontal	
Remark :	Spurious emissions within 30-1000MHz were found more than 20dB below limit line.								
Frequency (MHz)	ERP (dBm)	Limit (dBm)	Over Limit (dB)	SPA Reading (dBm)	S.G. Power (dBm)	TX Cable loss (dB)	TX Antenna Gain (dBi)	Polarization (H/V)	Result
1649	-65.35	-13	-52.35	-74.75	-67.1	0.98	4.88	H	Pass
2472	-56.42	-13	-43.42	-74.42	-58.3	1.28	5.32	H	Pass
3296	-56.19	-13	-43.19	-75.44	-59.6	1.54	7.10	H	Pass

Band :	CDMA2000 BC0						Temperature :	23~24°C	
Test Mode :	1xRTT_RC3+SO32 (QPSK)						Relative Humidity :	46~48%	
Test Engineer :	Ken Wu						Polarization :	Vertical	
Remark :	Spurious emissions within 30-1000MHz were found more than 20dB below limit line.								
Frequency (MHz)	ERP (dBm)	Limit (dBm)	Over Limit (dB)	SPA Reading (dBm)	S.G. Power (dBm)	TX Cable loss (dB)	TX Antenna Gain (dBi)	Polarization (H/V)	Result
1649	-63.55	-13	-50.55	-75.57	-65.3	0.98	4.88	V	Pass
2472	-58.62	-13	-45.62	-74.56	-60.5	1.28	5.32	V	Pass
3296	-57.39	-13	-44.39	-75.5	-60.8	1.54	7.10	V	Pass



<Middle Channel>

Band :	CDMA2000 BC0						Temperature :	23~24°C	
Test Mode :	1xRTT_RC3+SO32 (QPSK)						Relative Humidity :	46~48%	
Test Engineer :	Ken Wu						Polarization :	Horizontal	
Remark :	Spurious emissions within 30-1000MHz were found more than 20dB below limit line.								
Frequency (MHz)	ERP (dBm)	Limit (dBm)	Over Limit (dB)	SPA Reading (dBm)	S.G. Power (dBm)	TX Cable loss (dB)	TX Antenna Gain (dBi)	Polarization (H/V)	Result
1672	-62.42	-13	-49.42	-75.38	-64.1	0.99	4.82	H	Pass
2512	-54.63	-13	-41.63	-72.6	-56.6	1.29	5.41	H	Pass
3344	-54.29	-13	-41.29	-73.96	-57.9	1.56	7.31	H	Pass

Band :	CDMA2000 BC0						Temperature :	23~24°C	
Test Mode :	1xRTT_RC3+SO32 (QPSK)						Relative Humidity :	46~48%	
Test Engineer :	Ken Wu						Polarization :	Vertical	
Remark :	Spurious emissions within 30-1000MHz were found more than 20dB below limit line.								
Frequency (MHz)	ERP (dBm)	Limit (dBm)	Over Limit (dB)	SPA Reading (dBm)	S.G. Power (dBm)	TX Cable loss (dB)	TX Antenna Gain (dBi)	Polarization (H/V)	Result
1672	-63.22	-13	-50.22	-75.29	-64.9	0.99	4.82	V	Pass
2512	-57.83	-13	-44.83	-73.98	-59.8	1.29	5.41	V	Pass
3344	-57.89	-13	-44.89	-75.82	-61.5	1.56	7.31	V	Pass



<High Channel>

Band :	CDMA2000 BC0						Temperature :	23~24°C	
Test Mode :	1xRTT_RC3+SO32 (QPSK)						Relative Humidity :	46~48%	
Test Engineer :	Ken Wu						Polarization :	Horizontal	
Remark :	Spurious emissions within 30-1000MHz were found more than 20dB below limit line.								
Frequency (MHz)	ERP (dBm)	Limit (dBm)	Over Limit (dB)	SPA Reading (dBm)	S.G. Power (dBm)	TX Cable loss (dB)	TX Antenna Gain (dB)	Polarization (H/V)	Result
1696	-59.30	-13	-46.30	-72.87	-60.9	1.00	4.75	H	Pass
2544	-55.52	-13	-42.52	-73.78	-57.5	1.30	5.44	H	Pass
3392	-55.40	-13	-42.40	-74.74	-59.2	1.57	7.52	H	Pass

Band :	CDMA2000 BC0						Temperature :	23~24°C	
Test Mode :	1xRTT_RC3+SO32 (QPSK)						Relative Humidity :	46~48%	
Test Engineer :	Ken Wu						Polarization :	Vertical	
Remark :	Spurious emissions within 30-1000MHz were found more than 20dB below limit line.								
Frequency (MHz)	ERP (dBm)	Limit (dBm)	Over Limit (dB)	SPA Reading (dBm)	S.G. Power (dBm)	TX Cable loss (dB)	TX Antenna Gain (dB)	Polarization (H/V)	Result
1696	-60.30	-13	-47.30	-72.59	-61.9	1.00	4.75	V	Pass
2544	-57.62	-13	-44.62	-73.85	-59.6	1.30	5.44	V	Pass
3392	-57.10	-13	-44.10	-75.5	-60.9	1.57	7.52	V	Pass



<Low Channel>

Band :	CDMA2000 BC1	Temperature :	23~24°C						
Test Mode :	1xRTT_RC1+SO55 (QPSK)	Relative Humidity :	46~48%						
Test Engineer :	Ken Wu	Polarization :	Horizontal						
Remark :	Spurious emissions within 30-1000MHz were found more than 20dB below limit line.								
Frequency (MHz)	EIRP (dBm)	Limit (dBm)	Over Limit (dB)	SPA Reading (dBm)	S.G. Power (dBm)	TX Cable loss (dB)	TX Antenna Gain (dBi)	Polarization (H/V)	Result
3700	-51.63	-13	-38.63	-71.89	-58.2	1.67	8.24	H	Pass
5555	-53.23	-13	-40.23	-77.8	-60.3	2.66	9.72	H	Pass
7405	-51.75	-13	-38.75	-79.75	-60.9	2.46	11.61	H	Pass

Band :	CDMA2000 BC1	Temperature :	23~24°C						
Test Mode :	1xRTT_RC1+SO55 (QPSK)	Relative Humidity :	46~48%						
Test Engineer :	Ken Wu	Polarization :	Vertical						
Remark :	Spurious emissions within 30-1000MHz were found more than 20dB below limit line.								
Frequency (MHz)	EIRP (dBm)	Limit (dBm)	Over Limit (dB)	SPA Reading (dBm)	S.G. Power (dBm)	TX Cable loss (dB)	TX Antenna Gain (dBi)	Polarization (H/V)	Result
3700	-53.23	-13	-40.23	-72.85	-59.8	1.67	8.24	V	Pass
5555	-55.13	-13	-42.13	-78.46	-62.2	2.66	9.72	V	Pass
7405	-54.05	-13	-41.05	-79.92	-63.2	2.46	11.61	V	Pass



<Middle Channel>

Band :	CDMA2000 BC1						Temperature :	23~24°C	
Test Mode :	1xRTT_RC1+SO55 (QPSK)						Relative Humidity :	46~48%	
Test Engineer :	Ken Wu						Polarization :	Horizontal	
Remark :	Spurious emissions within 30-1000MHz were found more than 20dB below limit line.								
Frequency (MHz)	EIRP (dBm)	Limit (dBm)	Over Limit (dB)	SPA Reading (dBm)	S.G. Power (dBm)	TX Cable loss (dB)	TX Antenna Gain (dB)	Polarization (H/V)	Result
3760	-55.07	-13	-42.07	-75.61	-61.7	1.69	8.31	H	Pass
5640	-53.45	-13	-40.45	-77.77	-60.5	2.71	9.76	H	Pass
7520	-51.31	-13	-38.31	-79.23	-60.7	2.42	11.81	H	Pass

Band :	CDMA2000 BC1						Temperature :	23~24°C	
Test Mode :	1xRTT_RC1+SO55 (QPSK)						Relative Humidity :	46~48%	
Test Engineer :	Ken Wu						Polarization :	Vertical	
Remark :	Spurious emissions within 30-1000MHz were found more than 20dB below limit line.								
Frequency (MHz)	EIRP (dBm)	Limit (dBm)	Over Limit (dB)	SPA Reading (dBm)	S.G. Power (dBm)	TX Cable loss (dB)	TX Antenna Gain (dB)	Polarization (H/V)	Result
3763	-57.47	-13	-44.47	-76.94	-64.1	1.69	8.32	V	Pass
5640	-55.75	-13	-42.75	-79.13	-62.8	2.71	9.76	V	Pass
7520	-53.51	-13	-40.51	-79.43	-62.9	2.42	11.81	V	Pass



<High Channel>

Band :	CDMA2000 BC1						Temperature :	23~24°C		
Test Mode :	1xRTT_RC1+SO55 (QPSK)						Relative Humidity :	46~48%		
Test Engineer :	Ken Wu						Polarization :	Horizontal		
Remark :	Spurious emissions within 30-1000MHz were found more than 20dB below limit line.									
Frequency (MHz)	EIRP (dBm)	Limit (dBm)	Over Limit (dB)	SPA Reading (dBm)	S.G. Power (dBm)	TX Cable loss (dB)	TX Antenna Gain (dBi)	Polarization (H/V)	Result	
3819	-55.72	-13	-42.72	-76.35	-62.4	1.70	8.38	H	Pass	
5726	-53.66	-13	-40.66	-78	-60.7	2.76	9.79	H	Pass	
7635	-51.30	-13	-38.30	-79.38	-60.8	2.39	11.88	H	Pass	

Band :	CDMA2000 BC1						Temperature :	23~24°C		
Test Mode :	1xRTT_RC1+SO55 (QPSK)						Relative Humidity :	46~48%		
Test Engineer :	Ken Wu						Polarization :	Vertical		
Remark :	Spurious emissions within 30-1000MHz were found more than 20dB below limit line.									
Frequency (MHz)	EIRP (dBm)	Limit (dBm)	Over Limit (dB)	SPA Reading (dBm)	S.G. Power (dBm)	TX Cable loss (dB)	TX Antenna Gain (dBi)	Polarization (H/V)	Result	
3819	-57.42	-13	-44.42	-77.07	-64.1	1.70	8.38	V	Pass	
5726	-55.66	-13	-42.66	-78.87	-62.7	2.76	9.79	V	Pass	
7635	-52.80	-13	-39.80	-79.43	-62.3	2.39	11.88	V	Pass	



3.8 Frequency Stability Measurement

3.8.1 Description of Frequency Stability Measurement

The frequency stability shall be measured by variation of ambient temperature and variation of primary supply voltage to ensure that the fundamental emission stays within the authorized frequency block. The frequency stability of the transmitter shall be maintained within $\pm 0.00025\%$ ($\pm 2.5\text{ppm}$) of the center frequency.

3.8.2 Measuring Instruments

The measuring equipment is listed in the section 4 of this test report.

3.8.3 Test Procedures for Temperature Variation

1. The testing follows FCC KDB 971168 v02r02 Section 9.0.
2. The EUT was set up in the thermal chamber and connected with the system simulator.
3. With power OFF, the temperature was decreased to -30°C and the EUT was stabilized before testing. Power was applied and the maximum change in frequency was recorded within one minute.
4. With power OFF, the temperature was raised in 10°C steps up to 50°C . The EUT was stabilized at each step for at least half an hour. Power was applied and the maximum frequency change was recorded within one minute.

3.8.4 Test Procedures for Voltage Variation

1. The testing follows FCC KDB 971168 v02r02 Section 9.0.
2. The EUT was placed in a temperature chamber at $25\pm 5^{\circ}\text{C}$ and connected with the system simulator.
3. The power supply voltage to the EUT was varied from BEP to 115% of the nominal value measured at the input to the EUT.
4. The variation in frequency was measured for the worst case.

3.8.5 Test Setup

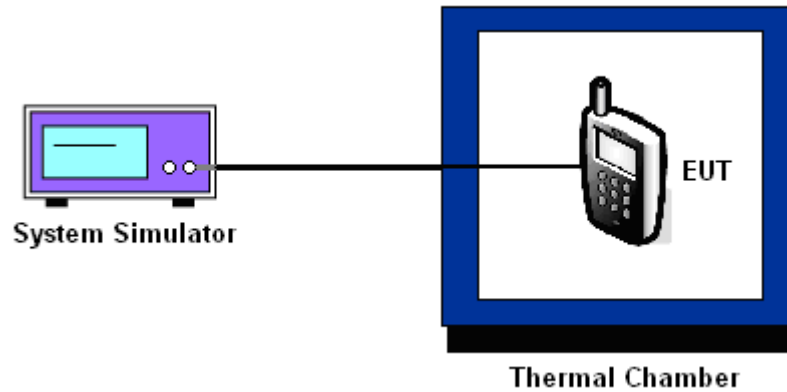

3.8.6 Test Result of Temperature Variation

Band :	CDMA2000 BC0 1xRTT_RC3+SO32	Channel :	384
Limit (ppm) :	2.5	Frequency :	836.52 MHz

Temperature (°C)	Deviation (ppm)	Result
50	0.0012	PASS
40	0.0263	
30	0.0239	
20(Ref.)	0.0000	
10	0.0299	
0	0.0251	
-10	0.0036	
-20	0.0012	
-30	0.0239	



Band :	CDMA2000 BC1 1xRTT_RC1+SO55	Channel :	600
Limit (ppm) :	within authorized band	Frequency :	1880.0 MHz

Temperature (°C)	Deviation (ppm)	Result
50	0.0005	PASS
40	0.0261	
30	0.0255	
20(Ref.)	0.0000	
10	0.0218	
0	0.0016	
-10	0.0005	
-20	0.0021	
-30	0.0239	

Note: The frequency fundamental emissions stay within the authorized frequency block based on the frequency deviation measured is small.

3.8.7 Test Result of Voltage Variation

Band & Channel	Mode	Voltage (Volt)	Deviation (ppm)	Limit (ppm)	Result
CDMA2000 BC0 CH384	1xRTT RC3+SO32	4.2	0.0227	2.5	Pass
		3.8	0.0012		
		BEP	0.0036		
CDMA2000 BC1 CH600	1xRTT RC1+SO55	4.2	0.0005	(Note 3.)	
		3.8	0.0011		
		BEP	0.0255		

Note:

1. Normal Voltage = 3.8V.
2. Battery End Point (BEP) = 3.4 V.
3. The frequency fundamental emissions stay within the authorized frequency block based on the frequency deviation measured is small.



4 List of Measuring Equipment

Instrument	Manufacturer	Model No.	Serial No.	Characteristics	Calibration Date	Test Date	Due Date	Remark
System Simulator	Rohde & Schwarz	CMU200	117995	N/A	Jul. 29, 2014	Dec. 23, 2014~ Dec. 24, 2014	Jul. 28, 2015	Conducted (TH02-HY)
Spectrum Analyzer	Rohde & Schwarz	FSP40	100055	9kHz~40GHz	Jun. 09, 2014	Dec. 23, 2014~ Dec. 24, 2014	Jun. 08, 2015	Conducted (TH02-HY)
Thermal Chamber	Ten Billion	TTH-D3SP	TBN-9307 01	N/A	Jul. 17, 2014	Dec. 23, 2014~ Dec. 24, 2014	Jul. 16, 2015	Conducted (TH02-HY)
Spectrum Analyzer	Rohde & Schwarz	FSV30	101749	10Hz ~ 30GHz	Feb. 10, 2014	Dec. 22, 2014~ Dec. 23, 2014	Feb. 09, 2015	Radiation (03CH07-HY)
Bilog Antenna	Schaffner	CBL6111C	2726	30MHz ~ 1GHz	Sep. 27, 2014	Dec. 22, 2014~ Dec. 23, 2014	Sep. 26, 2015	Radiation (03CH07-HY)
Double Ridge Horn Antenna	ESCO	3117	75962	1GHz~18GHz	Aug. 19, 2014	Dec. 22, 2014~ Dec. 23, 2014	Aug. 18, 2015	Radiation (03CH07-HY)
Preamplifier	COM-POWER	PA-103A	161241	10 MHz ~ 1000MHz	Mar. 17, 2014	Dec. 22, 2014~ Dec. 23, 2014	Mar. 16, 2015	Radiation (03CH07-HY)
Preamplifier	Agilent	8449B	3008A023 62	1 GHz~26.5 GHz	Oct. 21, 2014	Dec. 22, 2014~ Dec. 23, 2014	Oct. 20, 2015	Radiation (03CH07-HY)
Turn Table	ChainTek	ChainTek 3000	N/A	0 ~ 360 degree	N/A	Dec. 22, 2014~ Dec. 23, 2014	N/A	Radiation (03CH07-HY)
Antenna Mast	ChainTek	M-400-0	114/80006 04/L	N/A	N/A	Dec. 22, 2014~ Dec. 23, 2014	N/A	Radiation (03CH07-HY)
SHF-EHF Horn Antenna	SCHWARZBE CK	BBHA 9170	BBHA9170 251	18GHz~40GHz	Oct. 02, 2014	Dec. 22, 2014~ Dec. 23, 2014	Oct. 01, 2015	Radiation (03CH07-HY)
Signal Generator	Rohde & Schwarz	SMF100A	101107	100kHz~40GHz	May 23, 2014	Dec. 22, 2014~ Dec. 23, 2014	May 22, 2015	Radiation (03CH07-HY)
Double Ridge Horn Antenna	ESCO	3117	00066583	1GHz~18GHz	Jul. 24, 2014	Dec. 22, 2014~ Dec. 23, 2014	Jul. 23, 2015	Radiation (03CH07-HY)



5 Uncertainty of Evaluation

Uncertainty of Radiated Emission Measurement (30 MHz ~ 1000 MHz)

Measuring Uncertainty for a Level of Confidence of 95% ($U = 2Uc(y)$)	4.50
---	------



Appendix A. Original Report

Please refer to Sporton report number FG4N1482A as below.



FCC RF Test Report

APPLICANT : Motorola Mobility, LLC
EQUIPMENT : Mobile Cellular Phone
BRAND NAME : Motorola
MODEL NAME : 4059
FCC ID : IHDT56QC1
STANDARD : FCC 47 CFR Part 2, 22(H), 24(E), 27(L)
CLASSIFICATION : PCS Licensed Transmitter Held to Ear (PCE)

The product was received on Nov. 14, 2014 and testing was completed on Dec. 16, 2014. We, SPORTON INTERNATIONAL INC., would like to declare that the tested sample has been evaluated in accordance with the test procedures given in ANSI / TIA / EIA-603-C-2004 and has been in compliance with the applicable technical standards.

The test results in this report apply exclusively to the tested model / sample. Without written approval of SPORTON INTERNATIONAL INC., the test report shall not be reproduced except in full.

Reviewed by: Joseph Lin / Supervisor

Approved by: Jones Tsai / Manager



SPORTON INTERNATIONAL INC.

No. 52, Hwa Ya 1st Rd., Hwa Ya Technology Park, Kwei-Shan Hsiang, Tao Yuan Hsien, Taiwan, R.O.C.



TABLE OF CONTENTS

REVISION HISTORY..... 3

SUMMARY OF TEST RESULT 4

1 GENERAL DESCRIPTION 5

 1.1 Applicant..... 5

 1.2 Manufacturer 5

 1.3 Product Feature of Equipment Under Test 5

 1.4 Product Specification subjective to this standard 6

 1.5 Modification of EUT 6

 1.6 Maximum ERP/EIRP Power, Frequency Tolerance, and Emission Designator 7

 1.7 Testing Location 7

 1.8 Applicable Standards 8

2 TEST CONFIGURATION OF EQUIPMENT UNDER TEST 9

 2.1 Test Mode..... 9

 2.2 Connection Diagram of Test System 11

 2.3 Support Unit used in test configuration 11

 2.4 Measurement Results Explanation Example 11

3 TEST RESULT 13

 3.1 Conducted Output Power Measurement..... 13

 3.2 Peak-to-Average Ratio 15

 3.3 Effective Radiated Power and Effective Isotropic Radiated Power Measurement 31

 3.4 99% Occupied Bandwidth and 26dB Bandwidth Measurement..... 38

 3.5 Band Edge Measurement..... 62

 3.6 Conducted Spurious Emission Measurement 70

 3.7 Field Strength of Spurious Radiation Measurement 92

 3.8 Frequency Stability Measurement..... 115

4 LIST OF MEASURING EQUIPMENT 120

5 UNCERTAINTY OF EVALUATION 121



REVISION HISTORY

REPORT NO.	VERSION	DESCRIPTION	ISSUED DATE
FG4N1482A	Rev. 01	Initial issue of report	Jan. 06, 2015



SUMMARY OF TEST RESULT

Report Section	FCC Rule	Description	Limit	Result	Remark
3.1	§2.1046	Conducted Output Power	N/A	PASS	-
3.2	§24.232(d)	Peak-to-Average Ratio	<13 dB	PASS	-
3.3	§22.913(a)(2)	Effective Radiated Power	< 7 Watts	PASS	-
	§24.232(c)	Equivalent Isotropic Radiated Power	< 2 Watts	PASS	-
	§27.50(d)(4)	Equivalent Isotropic Radiated Power	< 1 Watts	PASS	-
3.4	§2.1049 §22.917(b) §24.238(b) §27.53(g)	Occupied Bandwidth	Reporting Only	PASS	-
3.5	§2.1051 §22.917(a) §24.238(a) §27.53(g)	Band Edge Measurement	$< 43+10\log_{10}(P[\text{Watts}])$	PASS	-
3.6	§2.1051 §22.917(a) §24.238(a) §27.53(g)	Conducted Spurious Emission	$< 43+10\log_{10}(P[\text{Watts}])$	PASS	-
3.7	§2.1053 §22.917(a) §24.238(a) §27.53(g)	Field Strength of Spurious Radiation	$< 43+10\log_{10}(P[\text{Watts}])$	PASS	Under limit 25.11 dB at 7400.000 MHz
3.8	§2.1055 §22.355 §24.235 §27.54	Frequency Stability for Temperature & Voltage	< 2.5 ppm for Part 22.355 Emission must remain In-band for 24.235 and 27.54	PASS	-



1 General Description

1.1 Applicant

Motorola Mobility, LLC
222 W. Merchandise Mart Plaza, Chicago IL 60654 USA

1.2 Manufacturer

Motorola Mobility, LLC
222 W. Merchandise Mart Plaza, Chicago IL 60654 USA

1.3 Product Feature of Equipment Under Test

Product Feature	
Equipment	Mobile Cellular Phone
Brand Name	Motorola
Model Name	4059
FCC ID	IHDT56QC1
IMEI Code	353333060012786
EUT supports Radios application	GSM/EGPRS/WCDMA/HSPA/LTE WLAN 11b/g/n HT20 Bluetooth v2.1 EDR Bluetooth v4.0 - LE
HW Version	P2B
EUT Stage	Identical Prototype

Remark: The above EUT's information was declared by manufacturer. Please refer to the specifications or user's manual for more detailed description.

Accessory List	
AC Adapter	Brand Name : Motorola
	Model Name : SPN5810A



1.4 Product Specification subjective to this standard

Product Specification subjective to this standard	
Tx Frequency	GSM850: 824.2 MHz ~ 848.8 MHz GSM1900: 1850.2 MHz ~ 1909.8MHz WCDMA Band V: 826.4 MHz ~ 846.6 MHz WCDMA Band IV : 1712.4 MHz ~ 1752.6 MHz WCDMA Band II: 1852.4 MHz ~ 1907.6 MHz
Rx Frequency	GSM850: 869.2 MHz ~ 893.8 MHz GSM1900: 1930.2 MHz ~ 1989.8 MHz WCDMA Band V: 871.4 MHz ~ 891.6 MHz WCDMA Band IV : 2112.4 MHz ~ 2152.6 MHz WCDMA Band II: 1932.4 MHz ~ 1987.6 MHz
Maximum Output Power to Antenna	GSM850 : 32.73 dBm GSM1900 : 29.66 dBm WCDMA Band V : 23.22 dBm WCDMA Band IV : 23.01 dBm WCDMA Band II : 23.21 dBm
Antenna Type	Fixed Internal Antenna
Type of Modulation	GSM: GMSK GPRS: GMSK EDGE: GMSK / 8PSK WCDMA: QPSK (Uplink) HSDPA: 64QAM (Downlink) HSUPA: QPSK (Uplink)

1.5 Modification of EUT

No modifications are made to the EUT during all test items.



1.6 Maximum ERP/EIRP Power, Frequency Tolerance, and Emission Designator

FCC Rule	System	Type of Modulation	Maximum ERP/EIRP (W)	Frequency Tolerance (ppm)	Emission Designator
Part 22	GSM850 GPRS class 8	GMSK	0.8279	0.0084 ppm	246KGXW
Part 22	GSM850 EDGE class 8	8PSK	0.1429	0.0084 ppm	244KG7W
Part 22	WCDMA Band V RMC 12.2Kbps	QPSK	0.0839	0.0108 ppm	4M17F9W
Part 24	GSM1900 GPRS class 8	GMSK	0.9419	0.0032 ppm	247KGXW
Part 24	GSM1900 EDGE class 8	8PSK	0.2735	0.0048 ppm	247KG7W
Part 24	WCDMA Band II RMC 12.2Kbps	QPSK	0.2858	0.0016 ppm	4M18F9W
Part 27	WCDMA Band IV RMC 12.2Kbps	QPSK	0.2564	0.0237 ppm	4M17F9W

1.7 Testing Location

Sporton Lab is accredited to ISO 17025 by Taiwan Accreditation Foundation (TAF code : 1190) and the FCC designation No. TW1022 under the FCC 2.948(e) by Mutual Recognition Agreement (MRA) in FCC Test.

Test Site	SPORTON INTERNATIONAL INC.	
Test Site Location	No. 52, Hwa Ya 1 st Rd., Hwa Ya Technology Park, Kwei-Shan Hsiang, Tao Yuan Hsien, Taiwan, R.O.C. TEL: +886-3-327-3456 FAX: +886-3-328-4978	
Test Site No.	Sporton Site No.	
	TH02-HY	03CH07-HY



1.8 Applicable Standards

According to the specifications of the manufacturer, the EUT must comply with the requirements of the following standards:

- FCC 47 CFR Part 2, 22(H), 24(E), 27(L)
- ANSI / TIA / EIA-603-C-2004
- FCC KDB 971168 D01 Power Meas. License Digital Systems v02r02

Remark:

1. All test items were verified and recorded according to the standards and without any deviation during the test.
2. This EUT has also been tested and complied with the requirements of FCC Part 15, Subpart B, recorded in a separate test report.



2 Test Configuration of Equipment Under Test

2.1 Test Mode

Antenna port conducted and radiated test items were performed according to KDB 971168 D01 Power Meas. License Digital Systems v02r02 with maximum output power.

Radiated measurements were performed with rotating EUT in different three orthogonal test planes to find the maximum emission.

Radiated emissions were investigated as following frequency range:

1. 30 MHz to 9000 MHz for GSM850 and WCDMA Band V.
2. 30 MHz to 19000 MHz for GSM1900 and WCDMA Band II.
3. 30 MHz to 18000 MHz for WCDMA Band IV.

All modes and data rates and positions were investigated.

Test modes are chosen to be reported as the worst case configuration below:

Test Modes		
Band	Radiated TCs	Conducted TCs
GSM 850	<ul style="list-style-type: none"> ■ GPRS class 8 Link ■ EDGE class 8 Link 	<ul style="list-style-type: none"> ■ GPRS class 8 Link ■ EDGE class 8 Link
GSM 1900	<ul style="list-style-type: none"> ■ GPRS class 8 Link ■ EDGE class 8 Link 	<ul style="list-style-type: none"> ■ GPRS class 8 Link ■ EDGE class 8 Link
WCDMA Band V	<ul style="list-style-type: none"> ■ RMC 12.2Kbps Link 	<ul style="list-style-type: none"> ■ RMC 12.2Kbps Link
WCDMA Band IV	<ul style="list-style-type: none"> ■ RMC 12.2Kbps Link 	<ul style="list-style-type: none"> ■ RMC 12.2Kbps Link
WCDMA Band II	<ul style="list-style-type: none"> ■ RMC 12.2Kbps Link 	<ul style="list-style-type: none"> ■ RMC 12.2Kbps Link

Note: The maximum power levels are chosen to test as the worst case configuration as follows:

GPRS multi-slot class 8 mode for GMSK modulation for GSM850,

GPRS multi-slot class 8 mode for GMSK modulation for GSM1900,

EDGE multi-slot class 8 mode for 8PSK modulation,

RMC 12.2Kbps mode for WCDMA band V, WCDMA band IV, and WCDMA band II,

only these modes were used for all tests. In addition to above worst-case test, below investigating on all data rates, and all modes are compliance with each FCC test case which has specific test limits. For spurious emissions at antenna port, the EUT was investigated the band edges on low and high channels, and the unwanted spurious emissions on middle channel for all modes, the results are pass, then only the worst-results were reported in the test report. The Radiated Spurious emissions for GSM/GPRS/EGPRS/HSDPA modes were investigated on the middle channel and the passed results were not worst than those data tested from the highest power channels.



Conducted Power Measurement Results:

Conducted Power (*Unit: dBm)						
Band	GSM850			GSM1900		
Channel	128	189	251	512	661	810
Frequency	824.2	836.4	848.8	1850.2	1880.0	1909.8
GSM	32.63	32.72	32.72	29.05	29.65	29.40
GPRS class 8	32.65	32.73	32.72	29.06	29.66	29.40
GPRS class 10	29.41	29.75	29.61	26.28	26.56	26.22
GPRS class 11	27.78	27.86	27.92	24.39	24.66	24.28
GPRS class 12	26.20	26.36	26.45	23.05	23.29	22.83
EGPRS class 8	26.76	26.91	26.98	25.43	25.73	25.47
EGPRS class 10	24.20	24.35	24.42	22.92	23.17	22.92
EGPRS class 11	22.82	23.00	23.20	21.10	21.35	21.11
EGPRS class 12	21.46	21.54	21.61	19.80	20.02	19.77

Conducted Power (*Unit: dBm)									
Band	WCDMA Band V			WCDMA Band II			WCDMA Band VI		
Channel	4132	4182	4233	9262	9400	9538	1312	1413	1513
Frequency	826.4	836.4	846.6	1852.4	1880.0	1907.6	1712.4	1732.6	1752.6
RMC 12.2K	23.20	23.22	23.01	22.96	23.01	23.00	23.21	22.84	22.78
HSDPA Subtest-1	21.71	21.62	21.55	21.52	21.53	21.55	21.63	21.45	21.39
HSDPA Subtest-2	21.73	21.65	21.60	21.46	21.48	21.50	21.61	21.38	21.32
HSDPA Subtest-3	21.75	21.65	21.55	21.51	21.50	21.55	21.66	21.48	21.45
HSDPA Subtest-4	21.72	21.64	21.59	21.51	21.44	21.51	21.61	21.38	21.37
HSUPA Subtest-1	21.63	21.46	21.34	21.69	21.38	21.68	21.80	21.82	21.57
HSUPA Subtest-2	20.99	21.03	20.70	20.91	20.86	20.82	21.03	20.56	20.87
HSUPA Subtest-3	21.24	21.25	20.39	20.99	21.09	20.97	21.14	20.26	20.22
HSUPA Subtest-4	21.33	21.29	21.03	21.16	21.06	21.54	21.70	21.50	21.34
HSUPA Subtest-5	22.34	22.19	22.22	22.08	22.11	22.04	22.13	21.97	21.90

2.2 Connection Diagram of Test System

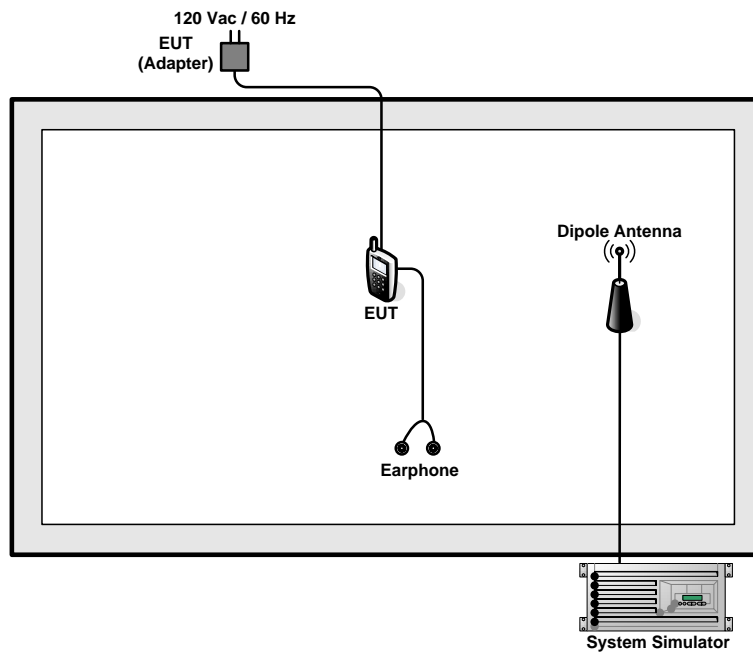

2.3 Support Unit used in test configuration

Item	Equipment	Trade Name	Model No.	FCC ID	Data Cable	Power Cord
1.	System Simulator	R&S	CMU 200	N/A	N/A	Unshielded, 1.8 m
2.	Earphone	MOTOROLA	SJYN1181B	N/A	Unshielded, 1 m	N/A

2.4 Measurement Results Explanation Example

For all conducted test items:

The offset level is set in the spectrum analyzer to compensate the RF cable loss and attenuator factor between RF conducted output port and spectrum analyzer. With the offset compensation, the spectrum analyzer reading level will be exactly the RF output level.

The spectrum analyzer offset is derived from RF cable loss and attenuator factor.

Offset = RF cable loss + attenuator factor.

The following shows an offset computation example with RF cable loss 4.2 dB and a 10dB attenuator.

Example :

Offset(dB) = RF cable loss(dB) + attenuator factor(dB).



= 4.2 + 10 = 14.2 (dB)

3 Test Result

3.1 Conducted Output Power Measurement

3.1.1 Description of the Conducted Output Power Measurement

A system simulator was used to establish communication with the EUT. Its parameters were set to enforce EUT transmitting at the maximum power. The measured power in the radio frequency on the transmitter output terminals shall be reported.

3.1.2 Measuring Instruments

The measuring equipment is listed in the section 4 of this test report.

3.1.3 Test Procedures

1. The transmitter output port was connected to the system simulator.
2. Set EUT at maximum power through system simulator.
3. Select lowest, middle, and highest channels for each band and different modulation.
4. Measure the maximum burst average power for GSM and maximum average power for other modulation signal.

3.1.4 Test Setup

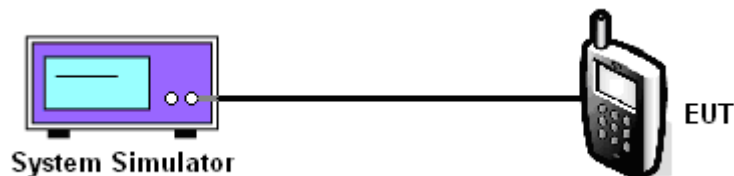



3.1.5 Test Result of Conducted Output Power

Cellular Band									
Modes	GSM850 (GPRS class 8)			GSM850 (EDGE class 8)			WCDMA Band V (RMC 12.2Kbps)		
Channel	128 (Low)	189 (Mid)	251 (High)	128 (Low)	189 (Mid)	251 (High)	4132 (Low)	4182 (Mid)	4233 (High)
Frequency (MHz)	824.2	836.4	848.8	824.2	836.4	848.8	826.4	836.4	846.6
Conducted Power (dBm)	32.65	32.73	32.72	26.76	26.91	26.98	23.20	23.22	23.01

PCS Band									
Modes	GSM1900 (GPRS class 8)			GSM1900 (EDGE class 8)			WCDMA Band II (RMC 12.2Kbps)		
Channel	512 (Low)	661 (Mid)	810 (High)	512 (Low)	661 (Mid)	810 (High)	9262 (Low)	9400 (Mid)	9538 (High)
Frequency (MHz)	1850.2	1880	1909.8	1850.2	1880	1909.8	1852.4	1880	1907.6
Conducted Power (dBm)	29.06	29.66	29.40	25.43	25.73	25.47	22.96	23.01	23.00

AWS Band			
Modes	WCDMA Band IV (RMC 12.2Kbps)		
Channel	1312(Low)	1413 (Mid)	1513 (High)
Frequency (MHz)	1712.4	1732.6	1752.6
Conducted Power (dBm)	23.21	22.84	22.78

Note: maximum burst average power for GSM/GPRS, and maximum average power for WCDMA.

3.2 Peak-to-Average Ratio

3.2.1 Description of the PAR Measurement

The peak-to-average ratio (PAR) of the transmission may not exceed 13 dB.

3.2.2 Measuring Instruments

The measuring equipment is listed in the section 4 of this test report.

3.2.3 Test Procedures

1. The testing follows FCC KDB 971168 v02r02 Section 5.7.1.
2. The EUT was connected to spectrum analyzer and system simulator via a power divider.
3. Set EUT to transmit at maximum output power.
4. For GSM/EGPRS operating modes, signal gating is implemented on the spectrum analyzer by triggering from the system simulator.
5. Set the CCDF (Complementary Cumulative Distribution Function) option of the spectrum analyzer.
Record the maximum PAPR level associated with a probability of 0.1%.

3.2.4 Test Setup

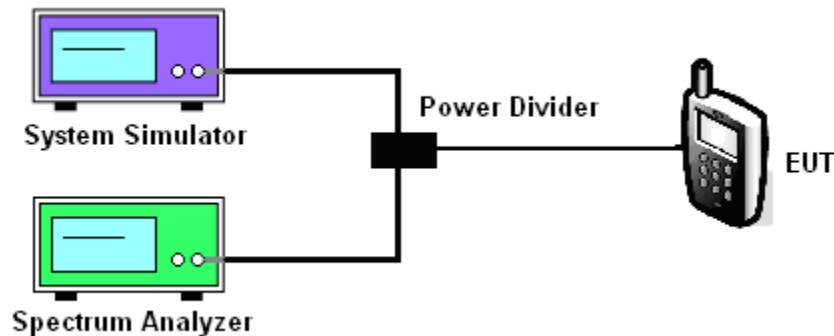



3.2.5 Test Result of Peak-to-Average Ratio

Cellular Band									
Modes	GSM850 (GPRS class 8)			GSM850 (EDGE class 8)			WCDMA Band V (RMC 12.2Kbps)		
Channel	128 (Low)	189 (Mid)	251 (High)	128 (Low)	189 (Mid)	251 (High)	4132 (Low)	4182 (Mid)	4233 (High)
Frequency (MHz)	824.2	836.4	848.8	824.2	836.4	848.8	826.4	836.4	846.6
Peak-to-Average Ratio (dB)	0.24	0.28	0.24	3.28	3.44	3.32	3.44	3.44	3.48

PCS Band									
Modes	GSM1900 (GPRS class 8)			GSM1900 (EDGE class 8)			WCDMA Band II (RMC 12.2Kbps)		
Channel	512 (Low)	661 (Mid)	810 (High)	512 (Low)	661 (Mid)	810 (High)	9262 (Low)	9400 (Mid)	9538 (High)
Frequency (MHz)	1850.2	1880	1909.8	1850.2	1880	1909.8	1852.4	1880	1907.6
Peak-to-Average Ratio (dB)	0.24	0.24	0.28	3.32	3.36	3.32	3.20	3.32	3.12

AWS Band			
Modes	WCDMA Band IV (RMC 12.2Kbps)		
Channel	1312(Low)	1413 (Mid)	1513 (High)
Frequency (MHz)	1712.4	1732.6	1752.6
Peak-to-Average Ratio (dB)	3.20	3.24	2.96



3.2.6 Test Result (Plots) of Peak-to-Average Ratio

Band :	GSM 850	Test Mode :	GPRS class 8 Link (GMSK)
--------	---------	-------------	--------------------------

Peak-to-Average Ratio on Channel 128 (824.2 MHz)

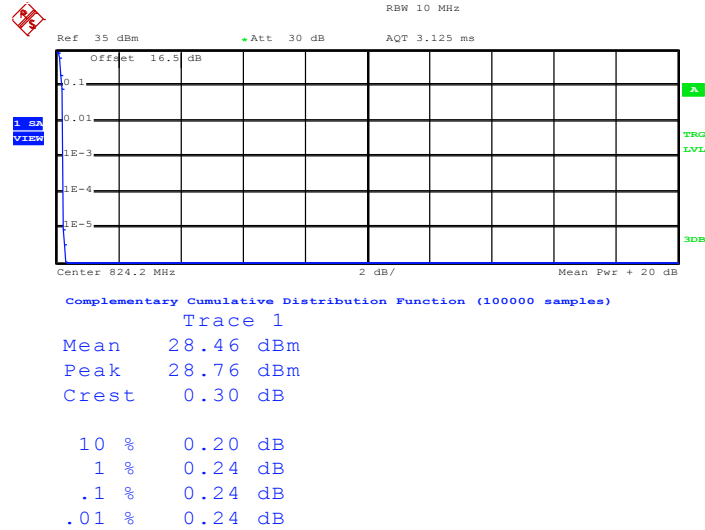

Date: 2.DEC.2014 19:39:22

Peak-to-Average Ratio on Channel 189 (836.4 MHz)

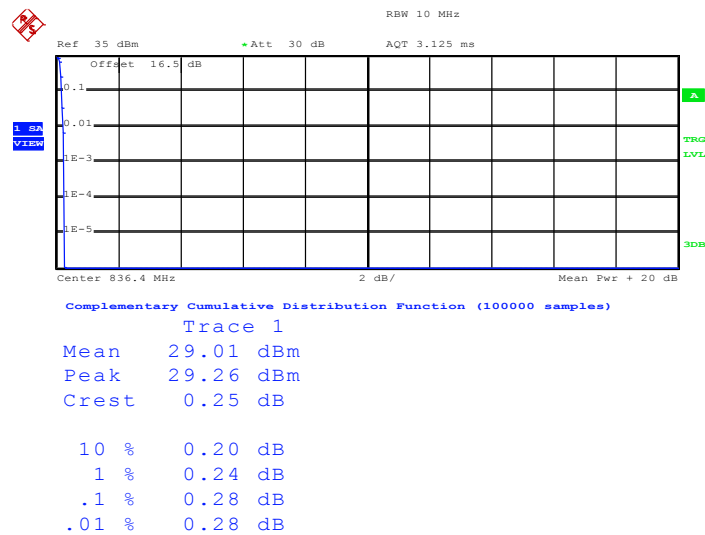

Date: 2.DEC.2014 19:40:40



Peak-to-Average Ratio on Channel 251 (848.8 MHz)

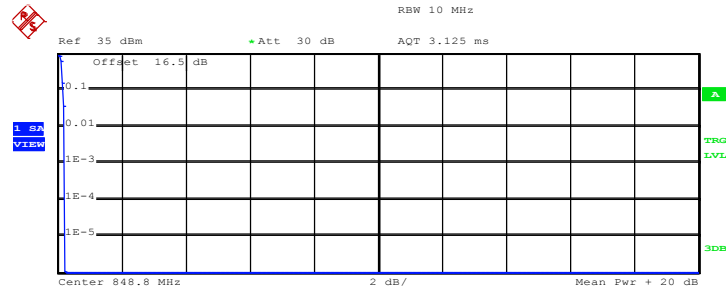

Complementary Cumulative Distribution Function (100000 samples)

Trace 1

Mean	29.44 dBm
Peak	29.68 dBm
Crest	0.24 dB
10 %	0.20 dB
1 %	0.24 dB
.1 %	0.24 dB
.01 %	0.24 dB

Date: 2.DEC.2014 19:41:20



Band :	GSM 850	Test Mode :	EDGE class 8 Link (8PSK)
---------------	---------	--------------------	--------------------------

Peak-to-Average Ratio on Channel 128 (824.2 MHz)

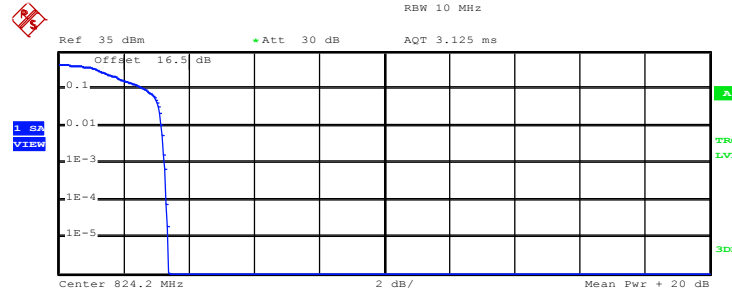

Complementary Cumulative Distribution Function (100000 samples)

Trace 1
 Mean 23.07 dBm
 Peak 26.43 dBm
 Crest 3.37 dB

10 %	2.68 dB
1 %	3.16 dB
.1 %	3.28 dB
.01 %	3.32 dB

Date: 2.DEC.2014 19:58:30

Peak-to-Average Ratio on Channel 189 (836.4 MHz)

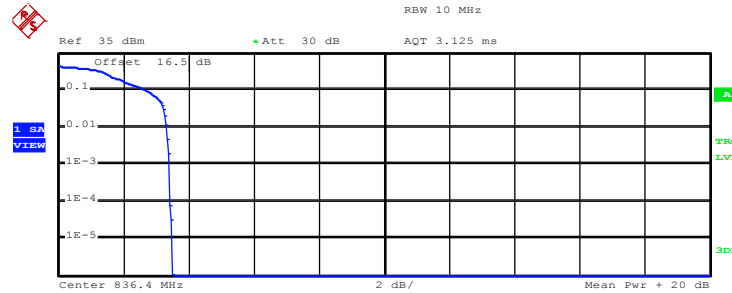

Complementary Cumulative Distribution Function (100000 samples)

Trace 1
 Mean 23.43 dBm
 Peak 26.93 dBm
 Crest 3.50 dB

10 %	2.72 dB
1 %	3.32 dB
.1 %	3.44 dB
.01 %	3.44 dB

Date: 2.DEC.2014 19:59:03



Peak-to-Average Ratio on Channel 251 (848.8 MHz)

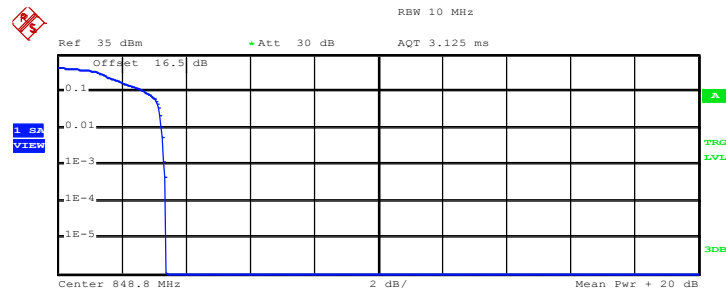

Complementary Cumulative Distribution Function (100000 samples)

Trace 1

Mean 24.12 dBm
 Peak 27.49 dBm
 Crest 3.38 dB

10 % 2.76 dB
 1 % 3.24 dB
 .1 % 3.32 dB
 .01 % 3.40 dB

Date: 2.DEC.2014 19:59:37



Band :	GSM 1900	Test Mode :	GPRS class 8 Link (GMSK)
---------------	----------	--------------------	--------------------------

Peak-to-Average Ratio on Channel 512 (1850.2 MHz)

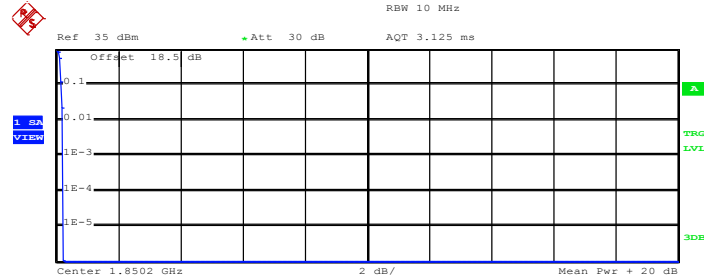

Complementary Cumulative Distribution Function (100000 samples)

Trace 1

Mean	26.27 dBm
Peak	26.50 dBm
Crest	0.24 dB

10 %	0.16 dB
1 %	0.24 dB
.1 %	0.24 dB
.01 %	0.24 dB

Date: 2.DEC.2014 20:34:08

Peak-to-Average Ratio on Channel 661 (1880.0 MHz)

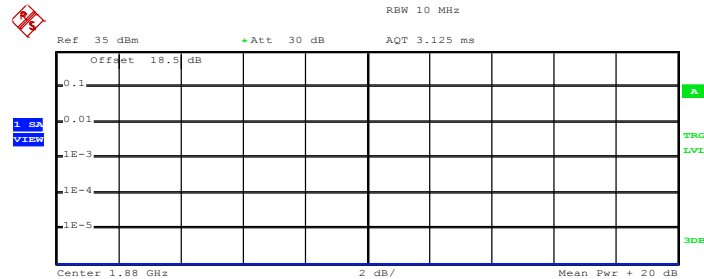

Complementary Cumulative Distribution Function (100000 samples)

Trace 1

Mean	26.27 dBm
Peak	26.50 dBm
Crest	0.24 dB

10 %	0.16 dB
1 %	0.24 dB
.1 %	0.24 dB
.01 %	0.24 dB

Date: 2.DEC.2014 20:34:21



Peak-to-Average Ratio on Channel 810 (1909.8 MHz)

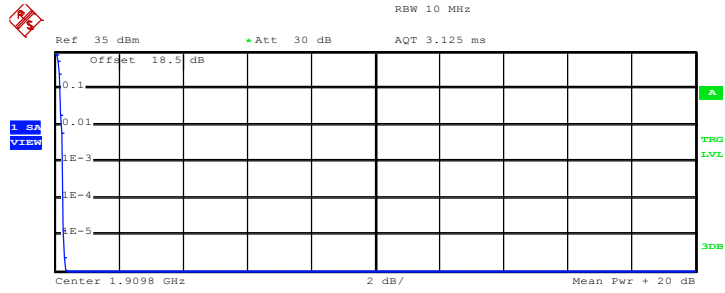

Complementary Cumulative Distribution Function (100000 samples)

Trace 1

Mean 25.75 dBm
 Peak 26.08 dBm
 Crest 0.33 dB

10 % 0.20 dB
 1 % 0.24 dB
 .1 % 0.28 dB
 .01 % 0.28 dB

Date: 2.DEC.2014 20:34:33



Band :	GSM 1900	Test Mode :	EDGE class 8 Link (8PSK)
---------------	----------	--------------------	--------------------------

Peak-to-Average Ratio on Channel 512 (1850.2 MHz)

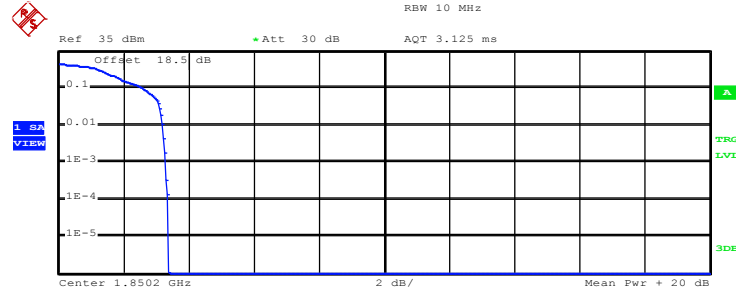

Complementary Cumulative Distribution Function (100000 samples)

Trace 1

Mean	23.05 dBm
Peak	26.43 dBm
Crest	3.38 dB
10 %	2.60 dB
1 %	3.20 dB
.1 %	3.32 dB
.01 %	3.36 dB

Date: 2.DEC.2014 20:44:31

Peak-to-Average Ratio on Channel 661 (1880.0 MHz)

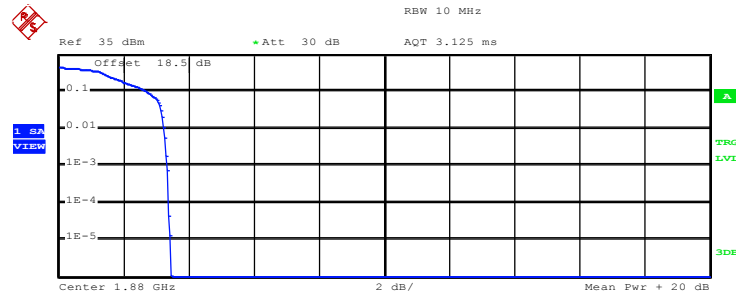

Complementary Cumulative Distribution Function (100000 samples)

Trace 1

Mean	22.77 dBm
Peak	26.22 dBm
Crest	3.45 dB
10 %	2.76 dB
1 %	3.24 dB
.1 %	3.36 dB
.01 %	3.40 dB

Date: 2.DEC.2014 20:45:05



Peak-to-Average Ratio on Channel 810 (1909.8 MHz)

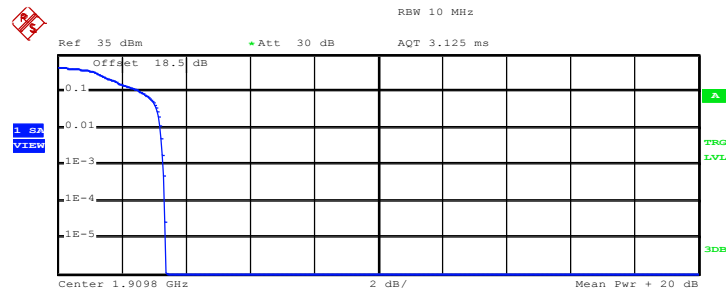

Complementary Cumulative Distribution Function (100000 samples)

Trace 1

Mean 22.51 dBm
Peak 25.87 dBm
Crest 3.36 dB

10 % 2.64 dB
1 % 3.20 dB
.1 % 3.32 dB
.01 % 3.36 dB

Date: 2.DEC.2014 20:46:00



Band :	WCDMA Band V	Test Mode :	RMC 12.2Kbps Link (QPSK)
---------------	--------------	--------------------	--------------------------

Peak-to-Average Ratio on Channel 4132 (826.4 MHz)

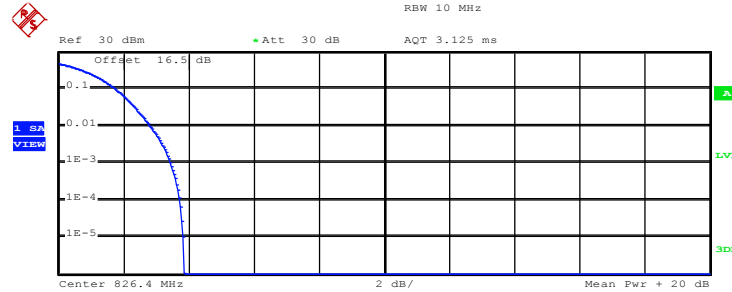

Complementary Cumulative Distribution Function (100000 samples)

Trace 1

Mean	19.62 dBm
Peak	23.48 dBm
Crest	3.86 dB
10 %	1.76 dB
1 %	2.84 dB
.1 %	3.44 dB
.01 %	3.72 dB

Date: 3.DEC.2014 11:22:30

Peak-to-Average Ratio on Channel 4182 (836.4 MHz)

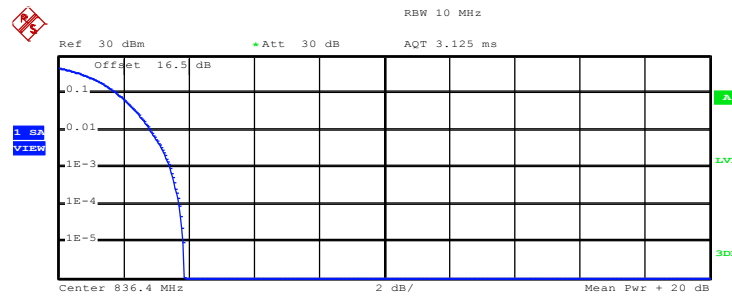

Complementary Cumulative Distribution Function (100000 samples)

Trace 1

Mean	19.12 dBm
Peak	22.99 dBm
Crest	3.87 dB
10 %	1.80 dB
1 %	2.84 dB
.1 %	3.44 dB
.01 %	3.72 dB

Date: 3.DEC.2014 11:22:48



Peak-to-Average Ratio on Channel 4233 (846.6 MHz)

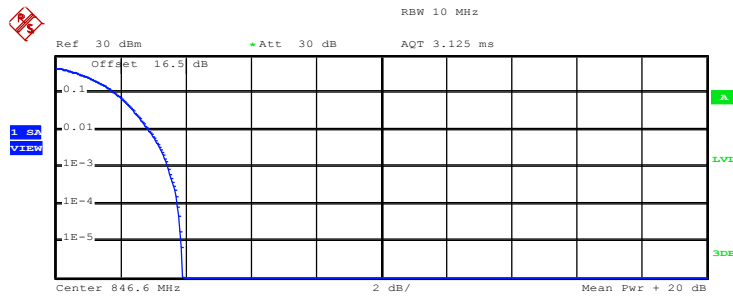

Complementary Cumulative Distribution Function (100000 samples)

Trace 1
 Mean 19.37 dBm
 Peak 23.27 dBm
 Crest 3.90 dB

10 %	1.84 dB
1 %	2.88 dB
.1 %	3.48 dB
.01 %	3.76 dB

Date: 3.DEC.2014 11:22:59



Band :	WCDMA Band IV	Test Mode :	RMC 12.2Kbps Link (QPSK)
---------------	---------------	--------------------	--------------------------

Peak-to-Average Ratio on Channel 1312 (1712.4 MHz)

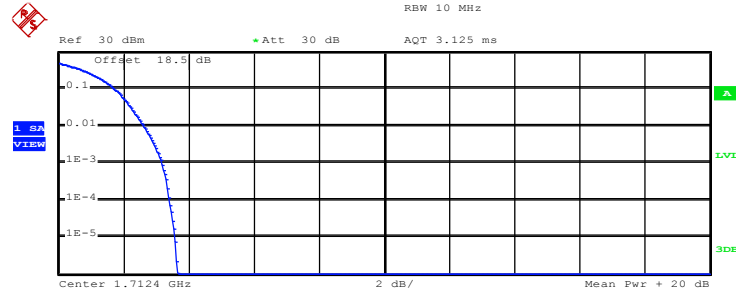

Complementary Cumulative Distribution Function (100000 samples)

Trace 1
 Mean 19.83 dBm
 Peak 23.48 dBm
 Crest 3.65 dB

10 %	1.72 dB
1 %	2.64 dB
.1 %	3.20 dB
.01 %	3.44 dB

Date: 3.DEC.2014 15:57:54

Peak-to-Average Ratio on Channel 1413 (1732.6 MHz)

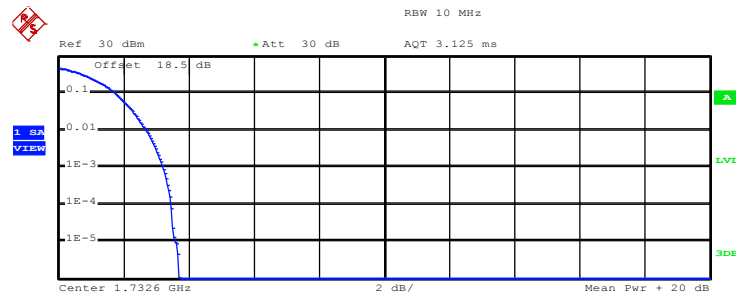

Complementary Cumulative Distribution Function (100000 samples)

Trace 1
 Mean 20.48 dBm
 Peak 24.19 dBm
 Crest 3.71 dB

10 %	1.76 dB
1 %	2.72 dB
.1 %	3.24 dB
.01 %	3.48 dB

Date: 3.DEC.2014 15:58:03



Peak-to-Average Ratio on Channel 1513 (1752.6 MHz)

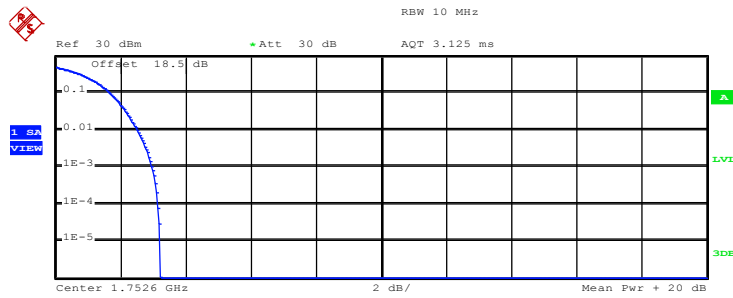

Complementary Cumulative Distribution Function (100000 samples)

Trace 1
 Mean 20.18 dBm
 Peak 23.41 dBm
 Crest 3.23 dB

10 %	1.68 dB
1 %	2.52 dB
.1 %	2.96 dB
.01 %	3.16 dB

Date: 3.DEC.2014 15:58:15



Band :	WCDMA Band II	Test Mode :	RMC 12.2Kbps Link (QPSK)
---------------	---------------	--------------------	--------------------------

Peak-to-Average Ratio on Channel 9262 (1852.4 MHz)

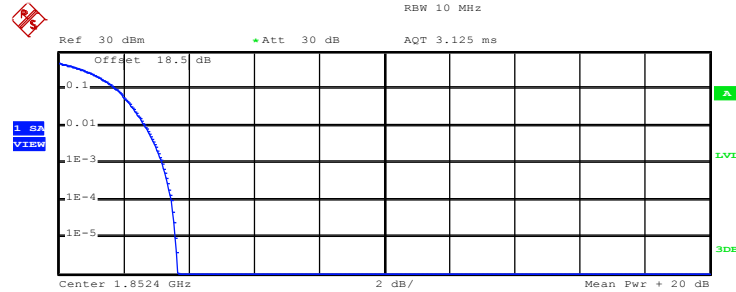

Complementary Cumulative Distribution Function (100000 samples)

Trace 1

Mean	20.67 dBm
Peak	24.33 dBm
Crest	3.66 dB
10 %	1.80 dB
1 %	2.68 dB
.1 %	3.20 dB
.01 %	3.48 dB

Date: 3.DEC.2014 11:35:07

Peak-to-Average Ratio on Channel 9400 (1880.0 MHz)

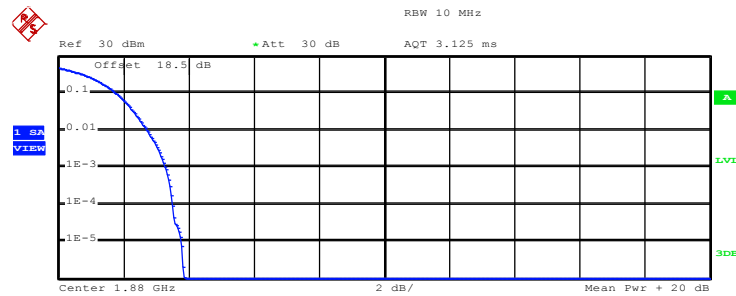

Complementary Cumulative Distribution Function (100000 samples)

Trace 1

Mean	21.26 dBm
Peak	25.10 dBm
Crest	3.85 dB
10 %	1.80 dB
1 %	2.72 dB
.1 %	3.32 dB
.01 %	3.52 dB

Date: 3.DEC.2014 11:35:17



Peak-to-Average Ratio on Channel 9538 (1907.6 MHz)

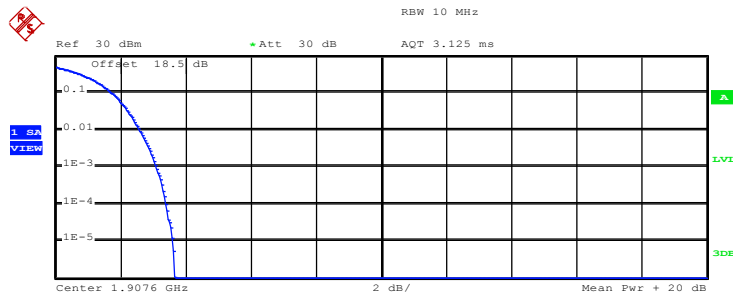

Complementary Cumulative Distribution Function (100000 samples)

Trace 1
 Mean 20.30 dBm
 Peak 23.97 dBm
 Crest 3.67 dB

10 % 1.76 dB
 1 % 2.60 dB
 .1 % 3.12 dB
 .01 % 3.40 dB

Date: 3.DEC.2014 11:35:26



3.3 Effective Radiated Power and Effective Isotropic Radiated Power Measurement

3.3.1 Description of the ERP/EIRP Measurement

The substitution method, in ANSI / TIA / EIA-603-C-2004, was used for ERP/EIRP measurement, and the spectrum analyzer configuration follows KDB 971168 D01 Power Meas. License Digital Systems v02r02. The ERP of mobile transmitters must not exceed 7 Watts (Cellular Band) and the EIRP of mobile transmitters are limited to 2 Watts (PCS Band) and 1 Watts (AWS Band).

3.3.2 Measuring Instruments

The measuring equipment is listed in the section 4 of this test report.

3.3.3 Test Procedures

1. The EUT was placed on a non-conductive rotating platform 0.8 meters high in a semi-anechoic chamber. The radiated emission at the fundamental frequency was measured at 3 m with a test antenna and a spectrum analyzer with RMS detector per section 5. of KDB 971168 D01.
2. During the measurement, the system simulator parameters were set to force the EUT transmitting at maximum output power. The maximum emission was recorded from analyzer power level (LVL) from the 360 degrees rotation of the turntable and the test antenna raised and lowered over a range from 1 to 4 meters in both horizontally and vertically polarized orientations.
3. Effective Isotropic Radiated Power (EIRP) was measured by substitution method according to TIA/EIA-603-C. The EUT was replaced by dipole antenna (substitution antenna) at the same location, and then a known power from S.G. was applied into the dipole antenna through a Tx cable, and then recorded the maximum Analyzer reading through raised and lowered the test antenna. The correction factor (in dB) = S.G. - Tx Cable loss + Substitution antenna gain - Analyzer reading. Then the EUT's EIRP was calculated with the correction factor, $EIRP = LVL + \text{Correction factor}$ and $ERP = EIRP - 2.15$.

	GSM/GPRS/EDGE	WCDMA/HSPA
SPAN	500kHz	10MHz
RBW	10kHz	100kHz
VBW	30kHz	300kHz
Detector	RMS	RMS
Trace	Average	Average
Average Type	Power	Power
Sweep Count	100	100

3.3.4 Test Setup

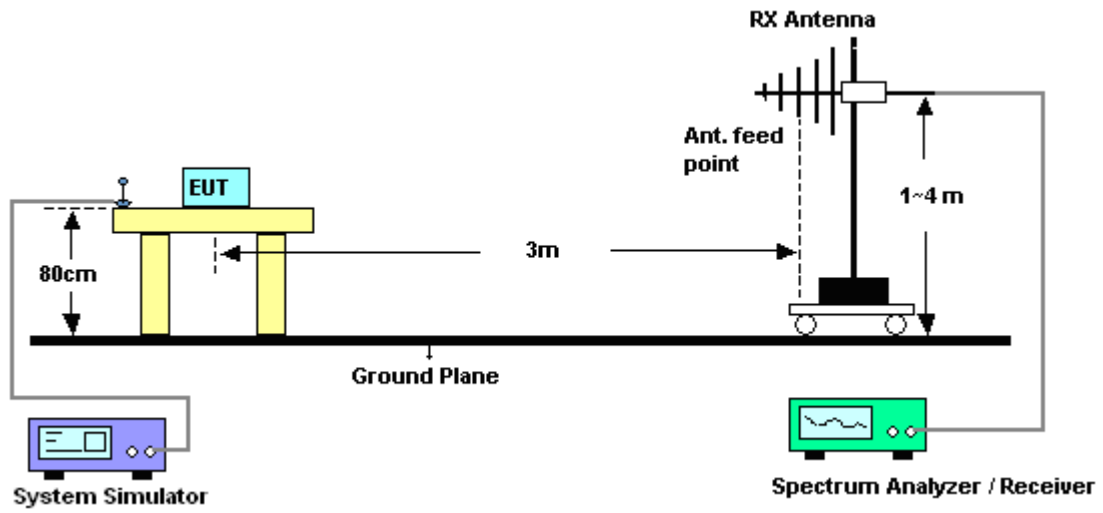



3.3.5 Test Result of ERP

GSM850 (GPRS class 8) Radiated Power ERP				
Horizontal Polarization				
Frequency (MHz)	LVL (dBm)	Correction Factor (dB)	ERP (dBm)	ERP (W)
824.2	-12.36	31.54	17.03	0.0505
836.4	-12.73	32.04	17.16	0.0520
848.8	-12.74	32.59	17.70	0.0589
Vertical Polarization				
Frequency (MHz)	LVL (dBm)	Correction Factor (dB)	ERP (dBm)	ERP (W)
824.2	-2.85	32.93	27.93	0.6209
836.4	-2.17	32.82	28.50	0.7079
848.8	-2.29	33.62	29.18	0.8279

* ERP = LVL (dBm) + Correction Factor (dB) – 2.15

GSM850 (EDGE class 8) Radiated Power ERP				
Horizontal Polarization				
Frequency (MHz)	LVL (dBm)	Correction Factor (dB)	ERP (dBm)	ERP (W)
824.2	-19.91	31.54	9.48	0.0089
836.4	-20.29	32.04	9.60	0.0091
848.8	-20.21	32.59	10.23	0.0105
Vertical Polarization				
Frequency (MHz)	LVL (dBm)	Correction Factor (dB)	ERP (dBm)	ERP (W)
824.2	-10.69	32.93	20.09	0.1021
836.4	-9.94	32.82	20.73	0.1183
848.8	-9.92	33.62	21.55	0.1429

* ERP = LVL (dBm) + Correction Factor (dB) – 2.15



WCDMA Band V (RMC 12.2Kbps) Radiated Power ERP				
Horizontal Polarization				
Frequency (MHz)	LVL (dBm)	Correction Factor (dB)	ERP (dBm)	ERP (W)
826.4	-19.51	31.44	9.78	0.0095
836.4	-19.75	32.04	10.14	0.0103
846.6	-20.32	32.63	10.16	0.0104
Vertical Polarization				
Frequency (MHz)	LVL (dBm)	Correction Factor (dB)	ERP (dBm)	ERP (W)
826.4	-13.09	32.78	17.54	0.0568
836.4	-12.42	32.82	18.25	0.0668
846.6	-12.01	33.4	19.24	0.0839

* ERP = LVL (dBm) + Correction Factor (dB) – 2.15



3.3.6 Test Result of EIRP

GSM1900 (GPRS class 8) Radiated Power EIRP				
Horizontal Polarization				
Frequency (MHz)	LVL (dBm)	Correction Factor (dB)	EIRP (dBm)	EIRP (W)
1850.2	-18.74	45.34	26.60	0.4571
1880.0	-19.29	46.01	26.72	0.4699
1909.8	-18.35	45.81	27.46	0.5572
Vertical Polarization				
Frequency (MHz)	LVL (dBm)	Correction Factor (dB)	EIRP (dBm)	EIRP (W)
1850.2	-21.81	49.22	27.41	0.5508
1880.0	-21.81	50.42	28.61	0.7261
1909.8	-19.26	49.00	29.74	0.9419

* EIRP = LVL (dBm) + Correction Factor (dB)

GSM1900 (EDGE class 8) Radiated Power EIRP				
Horizontal Polarization				
Frequency (MHz)	LVL (dBm)	Correction Factor (dB)	EIRP (dBm)	EIRP (W)
1850.2	-22.66	45.34	22.68	0.1854
1880.0	-23.80	46.01	22.21	0.1663
1909.8	-23.31	45.81	22.50	0.1778
Vertical Polarization				
Frequency (MHz)	LVL (dBm)	Correction Factor (dB)	EIRP (dBm)	EIRP (W)
1850.2	-25.64	49.22	23.58	0.2280
1880.0	-26.05	50.42	24.37	0.2735
1909.8	-24.78	49.00	24.22	0.2642

* EIRP = LVL (dBm) + Correction Factor (dB)



WCDMA Band IV (RMC 12.2Kbps) Radiated Power EIRP				
Horizontal Polarization				
Frequency (MHz)	LVL (dBm)	Correction Factor (dB)	EIRP (dBm)	EIRP (W)
1712.4	-22.10	44.56	22.46	0.1762
1732.6	-21.31	44.48	23.17	0.2075
1752.6	-21.32	44.64	23.32	0.2148
Vertical Polarization				
Frequency (MHz)	LVL (dBm)	Correction Factor (dB)	EIRP (dBm)	EIRP (W)
1712.4	-23.60	46.69	23.09	0.2037
1732.6	-21.60	45.69	24.09	0.2564
1752.6	-21.69	45.64	23.95	0.2483

* EIRP = LVL (dBm) + Correction Factor (dB)

WCDMA Band II (RMC 12.2Kbps) Radiated Power EIRP				
Horizontal Polarization				
Frequency (MHz)	LVL (dBm)	Correction Factor (dB)	EIRP (dBm)	EIRP (W)
1852.4	-22.93	45.37	22.44	0.1754
1880.0	-23.59	46.01	22.42	0.1746
1907.6	-23.32	45.87	22.55	0.1799
Vertical Polarization				
Frequency (MHz)	LVL (dBm)	Correction Factor (dB)	EIRP (dBm)	EIRP (W)
1852.4	-26.03	49.23	23.20	0.2089
1880.0	-26.21	50.42	24.21	0.2636
1907.6	-24.48	49.04	24.56	0.2858

* EIRP = LVL (dBm) + Correction Factor (dB)

3.4 99% Occupied Bandwidth and 26dB Bandwidth Measurement

3.4.1 Description of 99% Occupied Bandwidth and 26dB Bandwidth Measurement

The 99% occupied bandwidth is the width of a frequency band such that, below the lower and above the upper frequency limits, the mean powers emitted are each equal to a specified percentage 0.5% of the total mean transmitted power.

The emission bandwidth is defined as the width of the signal between two points, located at the 2 sides of the carrier frequency, outside of which all emissions are attenuated at least 26 dB below the transmitter power.

3.4.2 Measuring Instruments

The measuring equipment is listed in the section 4 of this test report.

3.4.3 Test Procedures

4. The testing follows FCC KDB 971168 v02r02 Section 4.2.
5. The EUT was connected to the spectrum analyzer and system simulator via a power divider.
6. The RF output of the EUT was connected to the spectrum analyzer by RF cable and attenuator. The path loss was compensated to the results for each measurement.
7. The 99% occupied bandwidth were measured, set RBW= 1% of span, VBW= 3*RBW, sample detector, trace maximum hold.
8. The 26dB bandwidth were measured, set RBW= 1% of EBW, VBW= 3*RBW, peak detector, trace maximum hold.

3.4.4 Test Setup

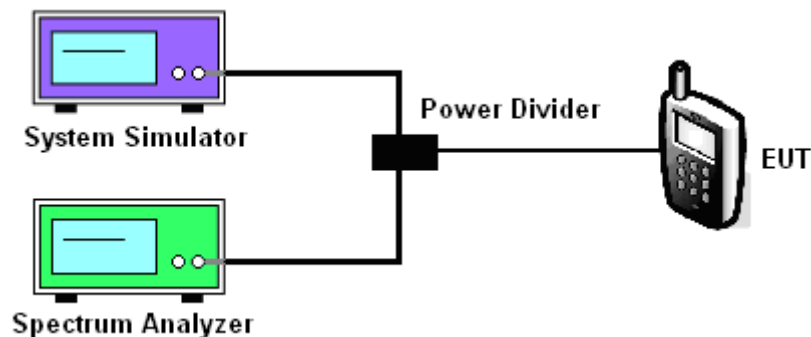



3.4.5 Test Result of Occupied Bandwidth and 26dB Bandwidth

Cellular Band						
Modes	GSM850 (GPRS class 8)			GSM850 (EDGE class 8)		
Channel	128 (Low)	189 (Mid)	251 (High)	128 (Low)	189 (Mid)	251 (High)
Frequency (MHz)	824.2	836.4	848.8	824.2	836.4	848.8
99% OBW (kHz)	245.00	243.00	246.00	244.00	236.00	242.00
26dB BW (kHz)	313.00	314.00	318.00	304.00	283.00	295.00

PCS Band						
Modes	GSM1900 (GPRS class 8)			GSM1900 (EDGE class 8)		
Channel	512 (Low)	661 (Mid)	810 (High)	512 (Low)	661 (Mid)	810 (High)
Frequency (MHz)	1850.2	1880	1909.8	1850.2	1880	1909.8
99% OBW (kHz)	247.00	245.00	247.00	247.00	241.00	244.00
26dB BW (kHz)	313.00	314.00	313.00	309.00	301.00	287.00

Cellular Band			
Modes	WCDMA Band V (RMC 12.2Kbps)		
Channel	4132 (Low)	4182 (Mid)	4233 (High)
Frequency (MHz)	826.4	836.4	846.6
99% OBW (MHz)	4.15	4.17	4.17
26dB BW (MHz)	4.65	4.66	4.66

AWS Band			
Modes	WCDMA Band IV (RMC 12.2Kbps)		
Channel	1312(Low)	1413 (Mid)	1513 (High)
Frequency (MHz)	1712.4	1732.6	1752.6
99% OBW (MHz)	4.16	4.17	4.17
26dB BW (MHz)	4.68	4.66	4.66



PCS Band			
Modes	WCDMA Band II (RMC 12.2Kbps)		
Channel	9262 (Low)	9400 (Mid)	9538 (High)
Frequency (MHz)	1852.4	1880	1907.6
99% OBW (MHz)	4.18	4.18	4.17
26dB BW (MHz)	4.66	4.68	4.67



3.4.6 Test Result (Plots) of Occupied Bandwidth and 26dB Bandwidth

Band :	GSM 850	Test Mode :	GPRS class 8 Link (GMSK)
--------	---------	-------------	--------------------------

99% Occupied Bandwidth Plot on Channel 128 (824.2 MHz)

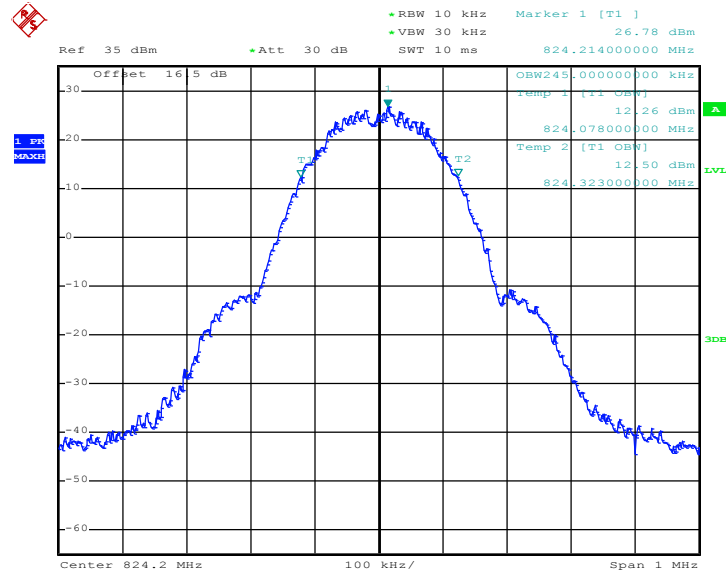

Date: 2.DEC.2014 19:26:44

26dB Bandwidth Plot on Channel 128 (824.2 MHz)

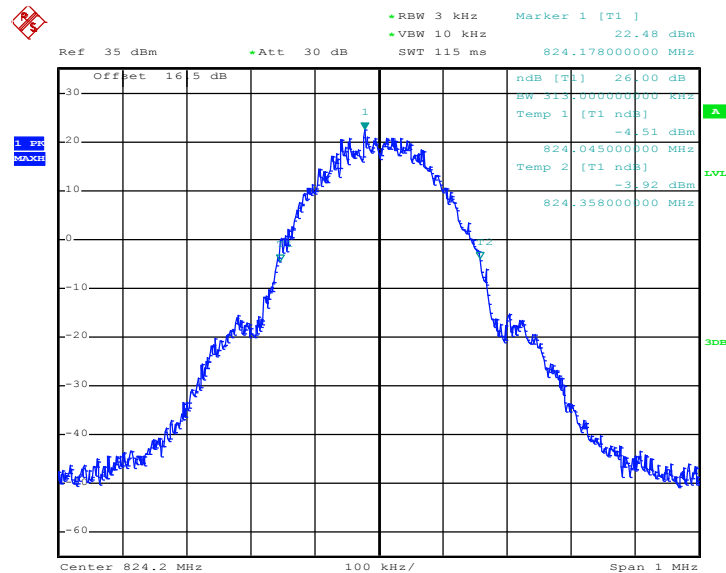

Date: 2.DEC.2014 19:24:28



99% Occupied Bandwidth Plot on Channel 189 (836.4 MHz)

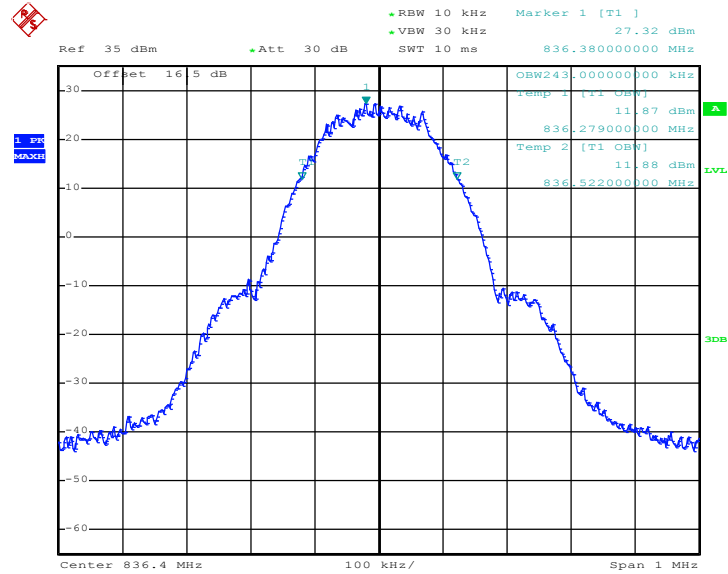

Date: 2.DEC.2014 19:27:13

26dB Bandwidth Plot on Channel 189 (836.4 MHz)

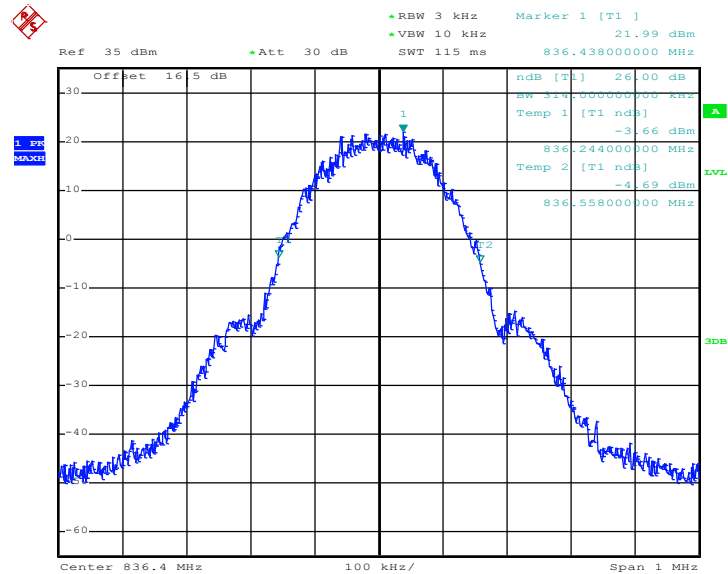

Date: 2.DEC.2014 19:24:56



Band :	GSM 850	Test Mode :	EDGE class 8 Link (8PSK)
---------------	---------	--------------------	--------------------------

99% Occupied Bandwidth Plot on Channel 128 (824.2 MHz)

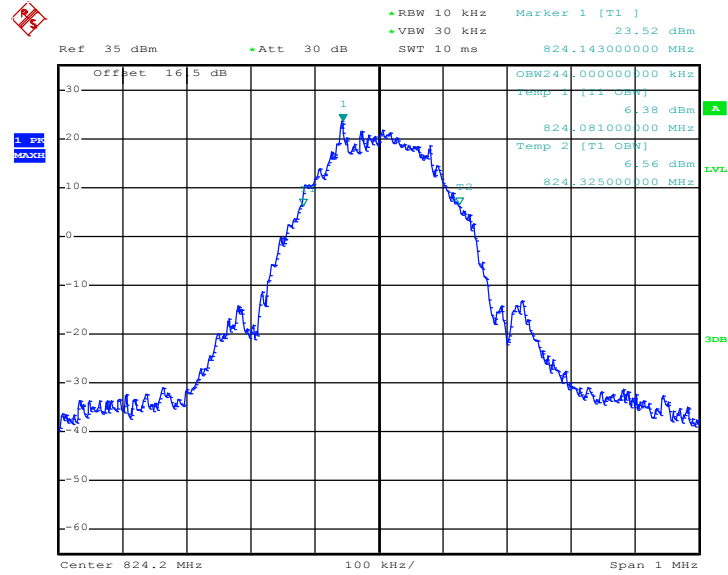

Date: 2.DEC.2014 19:48:19

26dB Bandwidth Plot on Channel 128 (824.2 MHz)

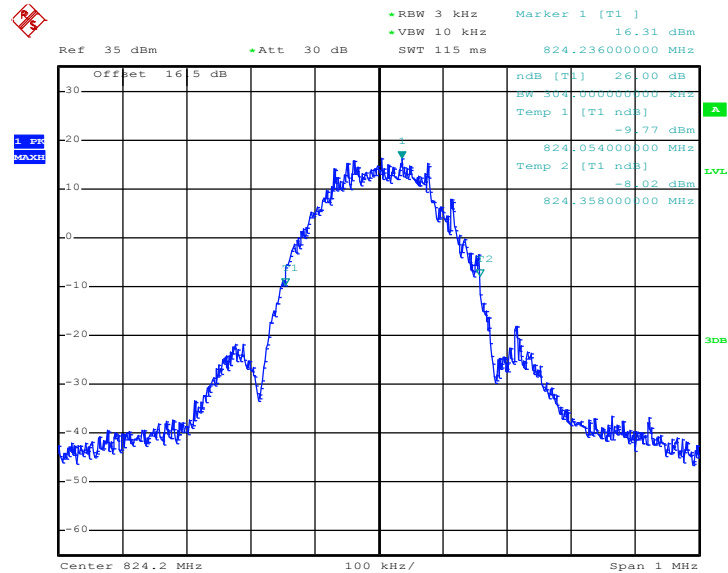

Date: 2.DEC.2014 19:46:25



99% Occupied Bandwidth Plot on Channel 189 (836.4 MHz)

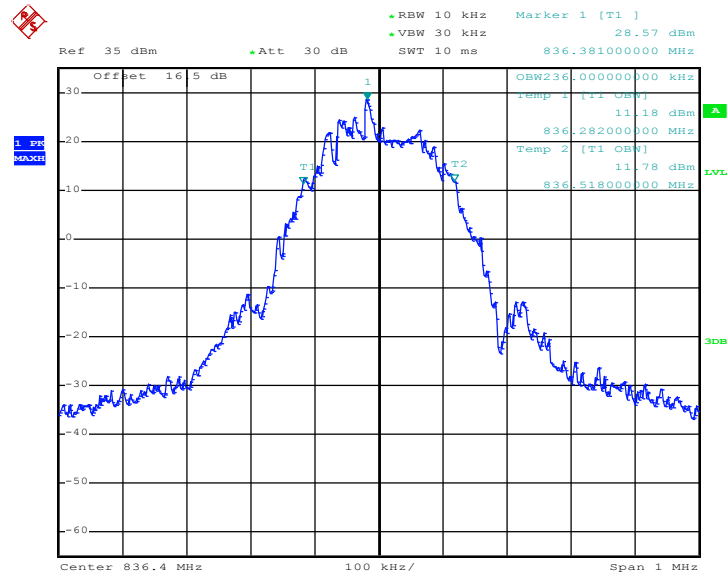

Date: 2.DEC.2014 19:48:47

26dB Bandwidth Plot on Channel 189 (836.4 MHz)

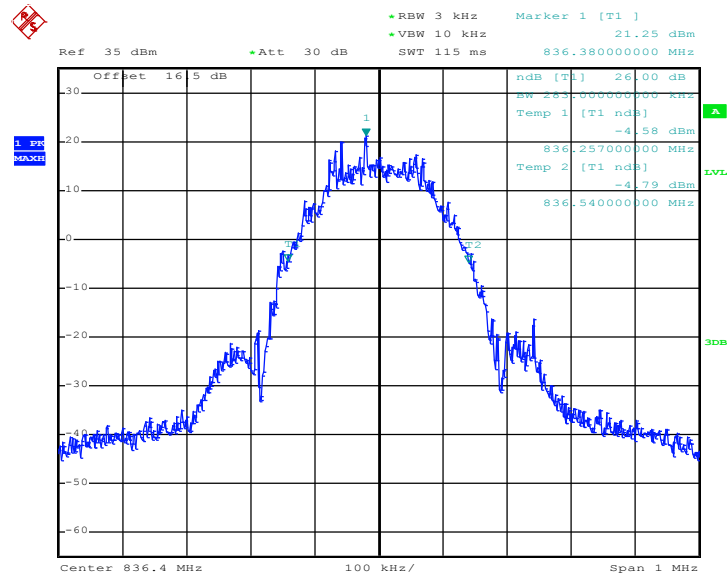

Date: 2.DEC.2014 19:46:53



99% Occupied Bandwidth Plot on Channel 251 (848.8 MHz)

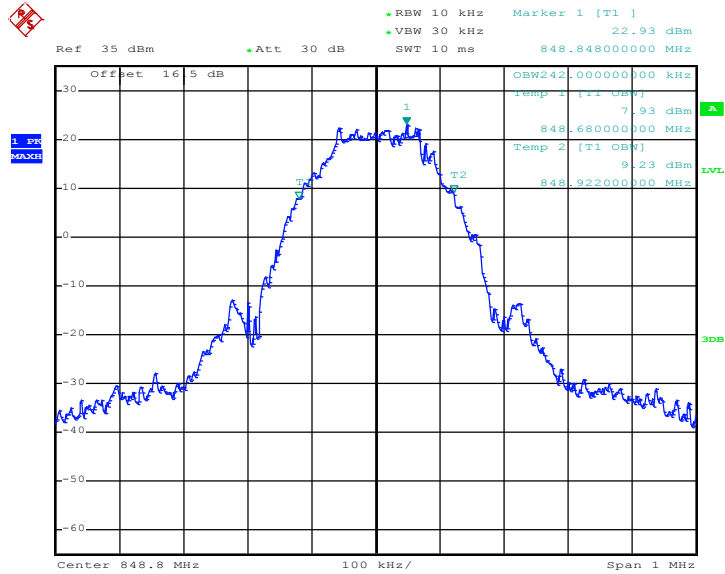

Date: 2.DEC.2014 19:49:15

26dB Bandwidth Plot on Channel 251 (848.8 MHz)

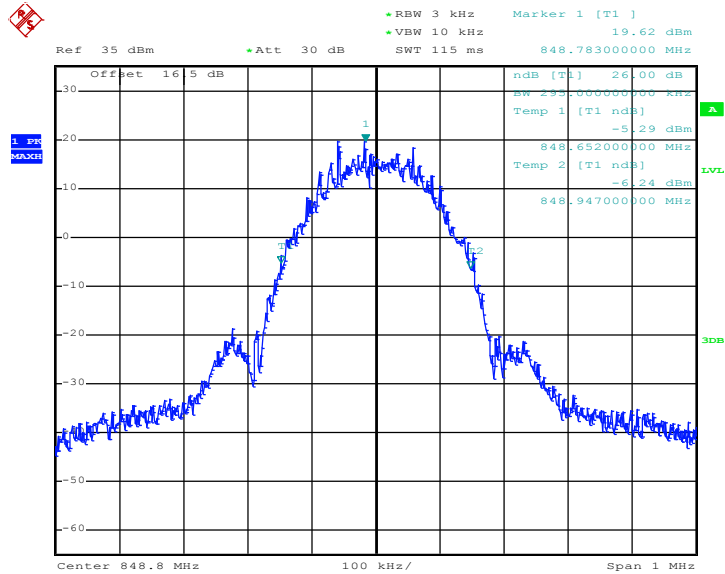

Date: 2.DEC.2014 19:47:21



Band :	GSM 1900	Test Mode :	GPRS class 8 Link (GMSK)
---------------	----------	--------------------	--------------------------

99% Occupied Bandwidth Plot on Channel 512 (1850.2 MHz)

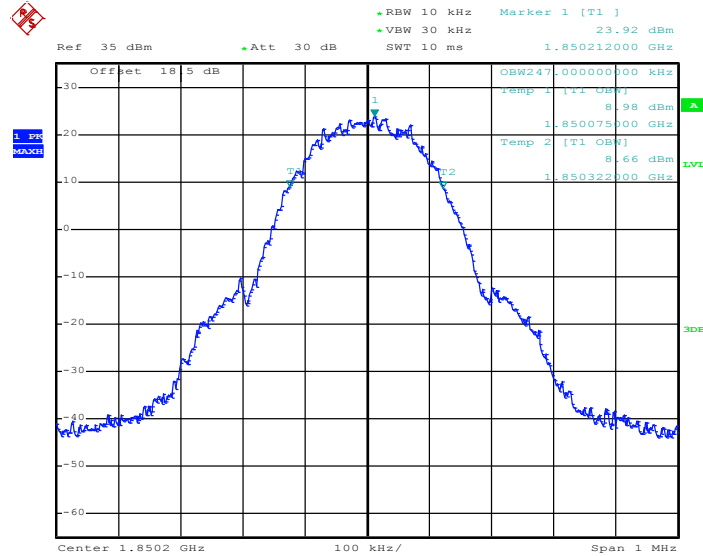

Date: 2.DEC.2014 20:32:13

26dB Bandwidth Plot on Channel 512 (1850.2 MHz)

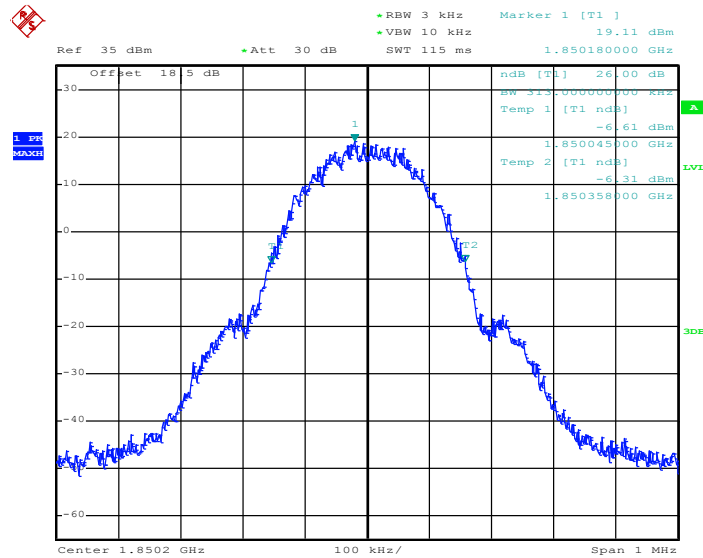

Date: 2.DEC.2014 20:30:37



99% Occupied Bandwidth Plot on Channel 661 (1880.0 MHz)

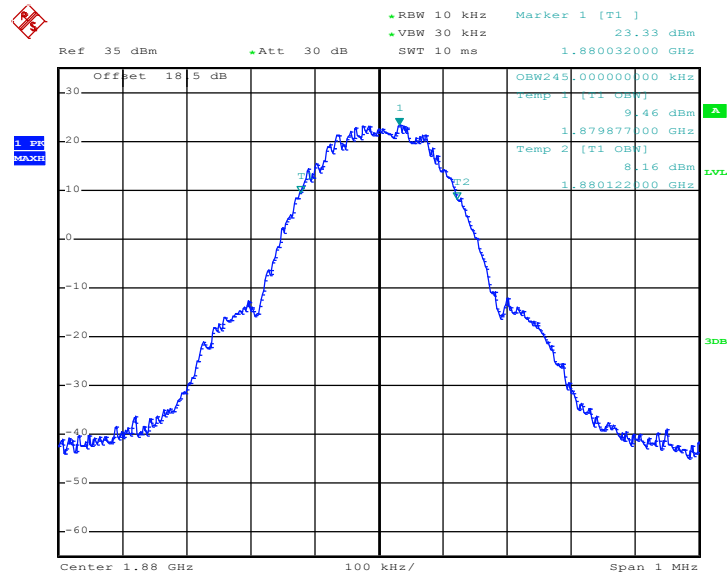

Date: 2.DEC.2014 20:32:42

26dB Bandwidth Plot on Channel 661 (1880.0 MHz)

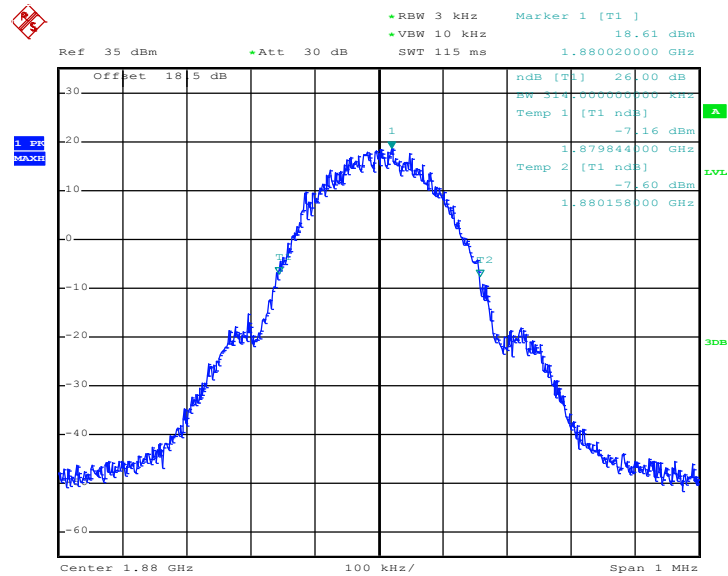

Date: 2.DEC.2014 20:31:05



99% Occupied Bandwidth Plot on Channel 810 (1909.8 MHz)

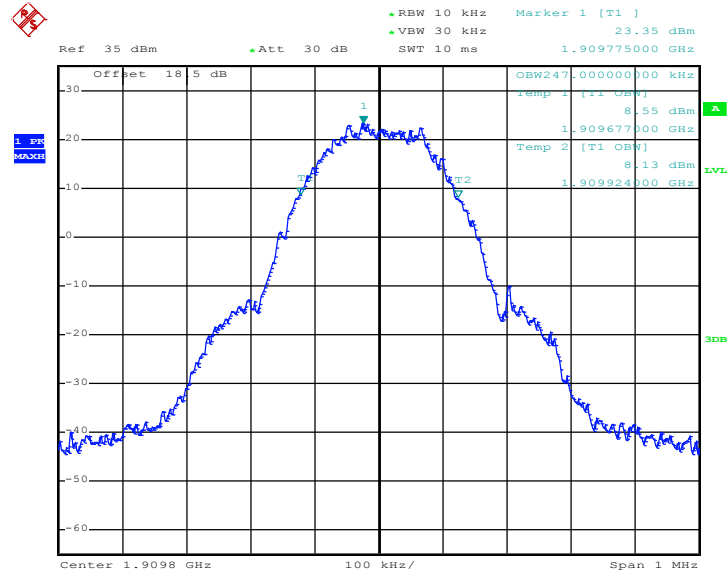

Date: 2.DEC.2014 20:33:10

26dB Bandwidth Plot on Channel 810 (1909.8 MHz)

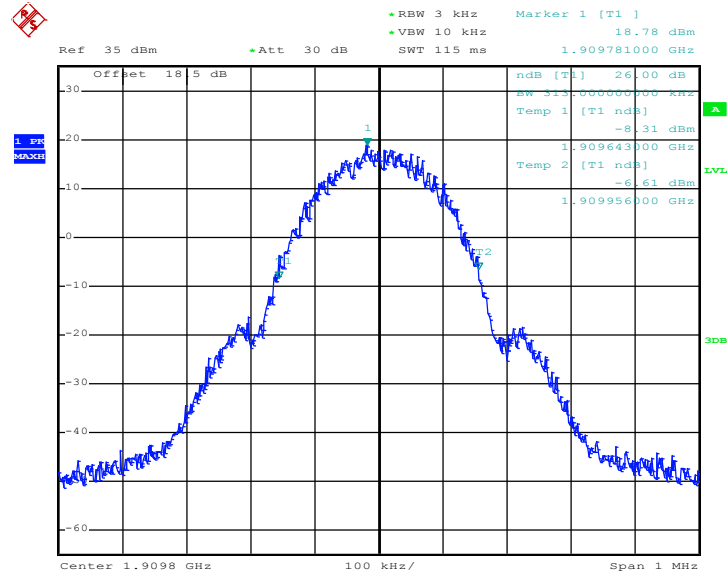

Date: 2.DEC.2014 20:31:33



Band :	GSM 1900	Test Mode :	EDGE class 8 Link (8PSK)
---------------	----------	--------------------	--------------------------

99% Occupied Bandwidth Plot on Channel 512 (1850.2 MHz)

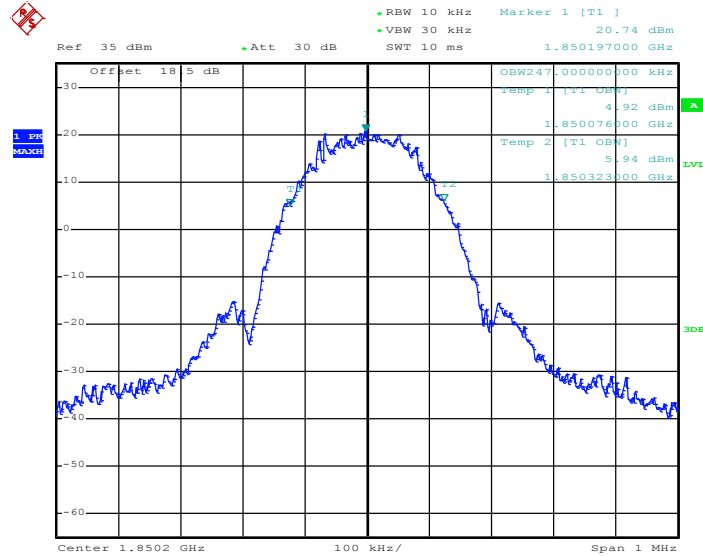

Date: 2.DEC.2014 20:41:40

26dB Bandwidth Plot on Channel 512 (1850.2 MHz)

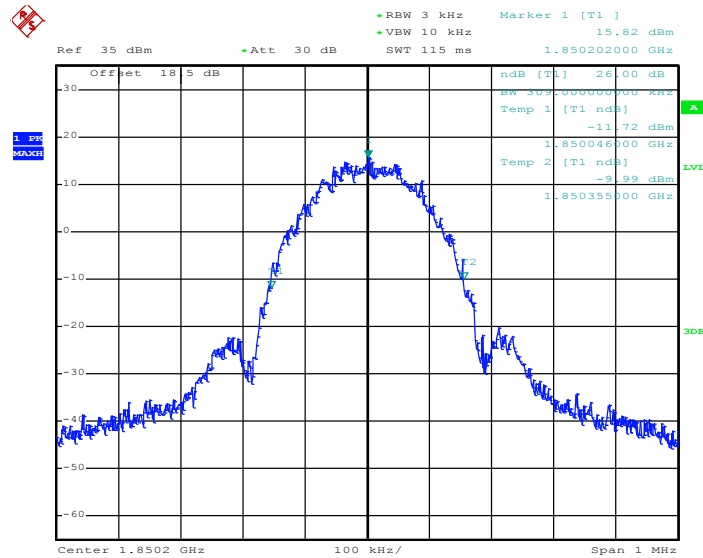

Date: 2.DEC.2014 20:38:49



99% Occupied Bandwidth Plot on Channel 661 (1880.0 MHz)

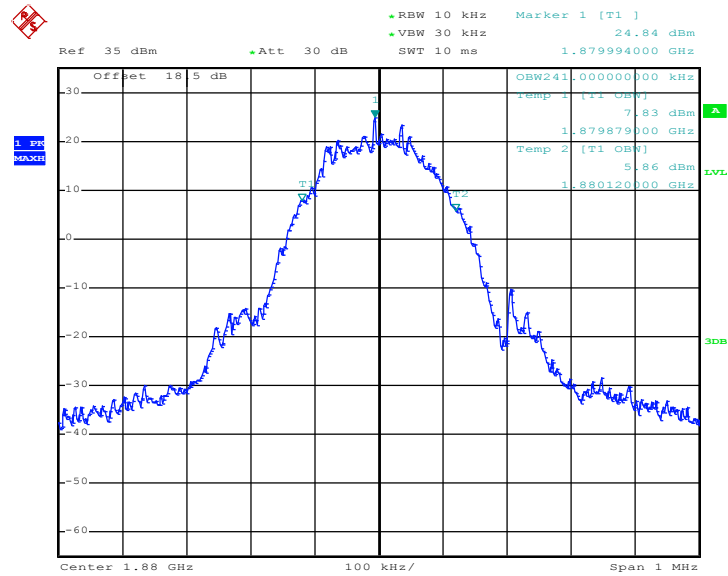

Date: 2.DEC.2014 20:42:09

26dB Bandwidth Plot on Channel 661 (1880.0 MHz)

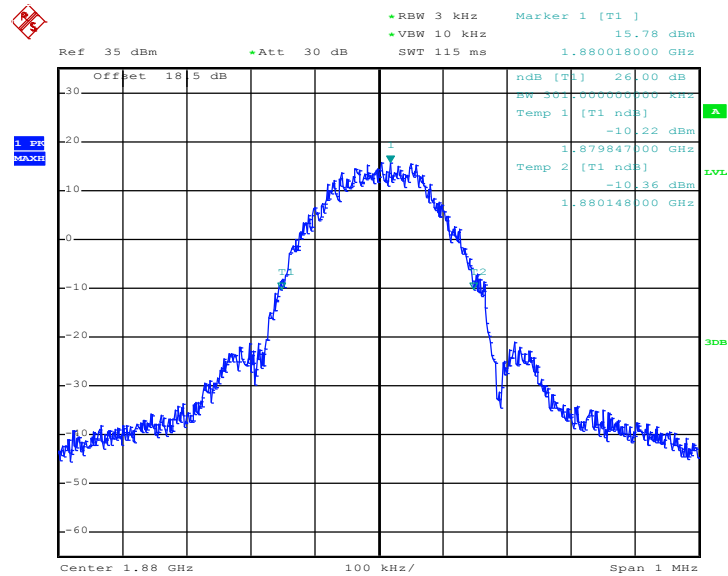

Date: 2.DEC.2014 20:39:17



99% Occupied Bandwidth Plot on Channel 810 (1909.8 MHz)

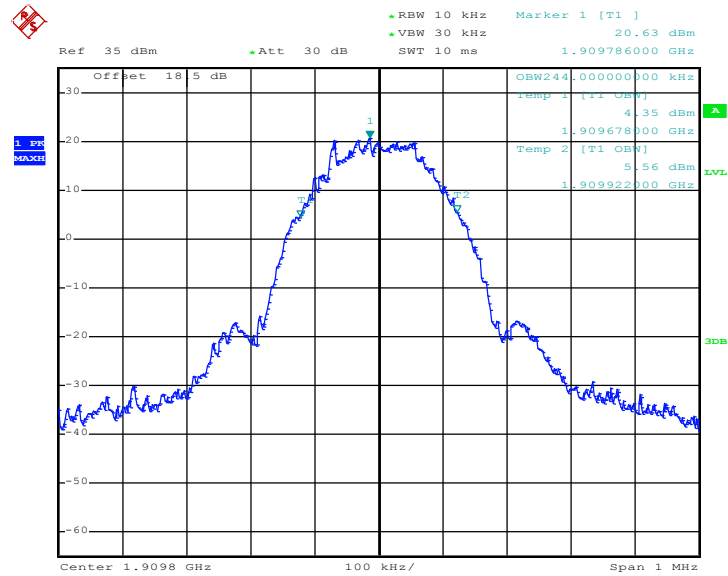

Date: 2.DEC.2014 20:42:37

26dB Bandwidth Plot on Channel 810 (1909.8 MHz)

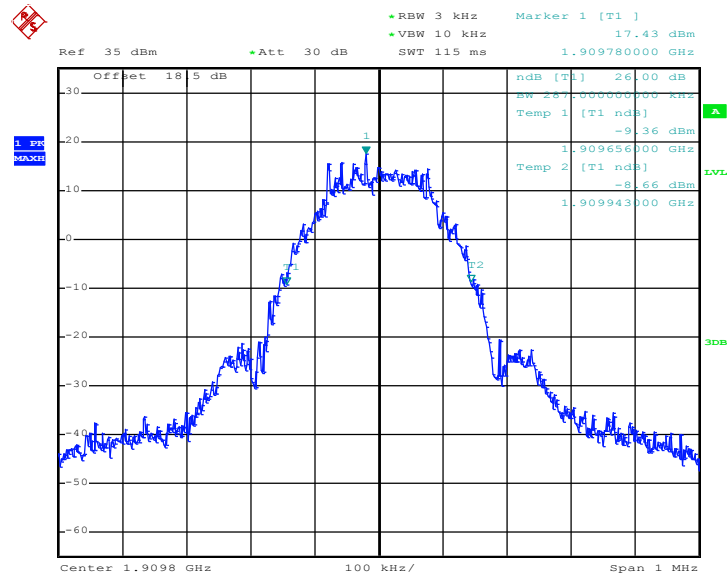

Date: 2.DEC.2014 20:39:45



Band :	WCDMA Band V	Test Mode :	RMC 12.2Kbps Link (QPSK)
---------------	--------------	--------------------	--------------------------

99% Occupied Bandwidth Plot on Channel 4132 (826.4 MHz)

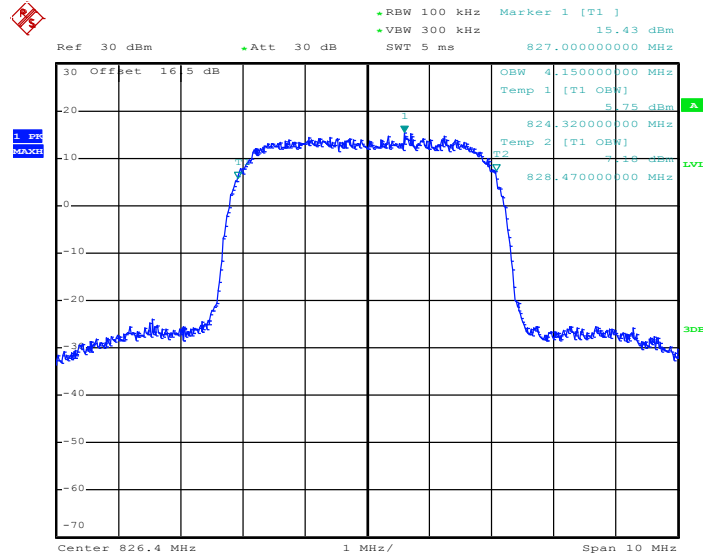

Date: 3.DEC.2014 11:14:25

26dB Bandwidth Plot on Channel 4132 (826.4 MHz)

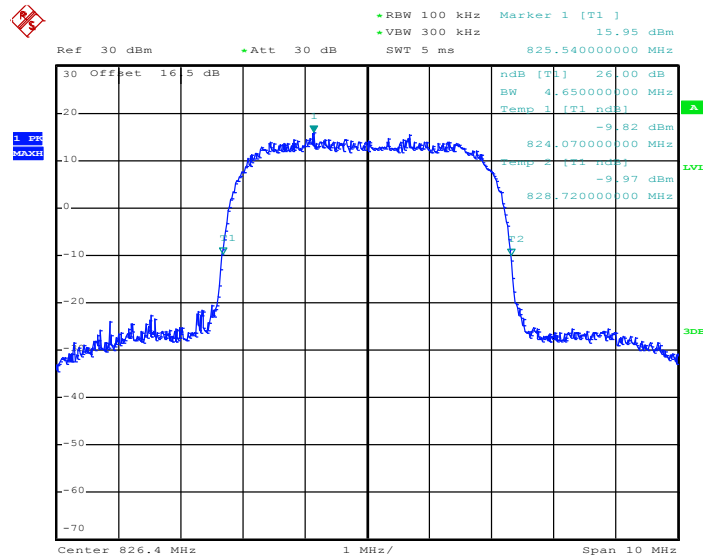

Date: 3.DEC.2014 11:11:33



99% Occupied Bandwidth Plot on Channel 4182 (836.4 MHz)

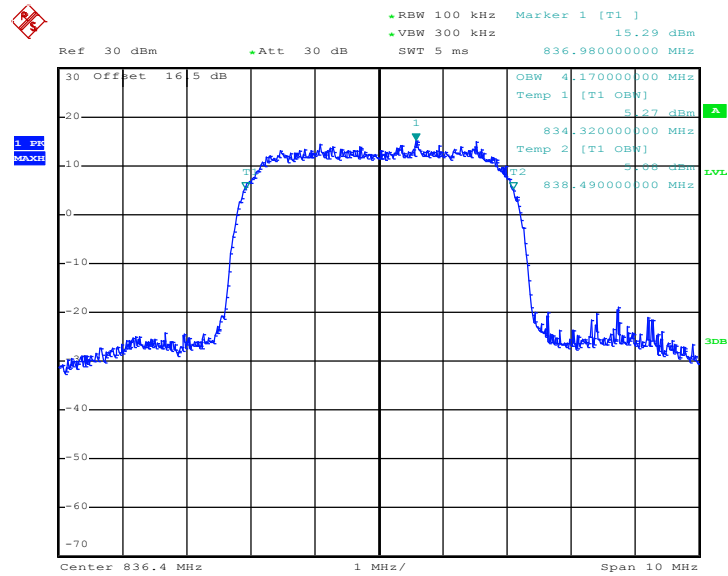

Date: 3.DEC.2014 11:14:53

26dB Bandwidth Plot on Channel 4182 (836.4 MHz)

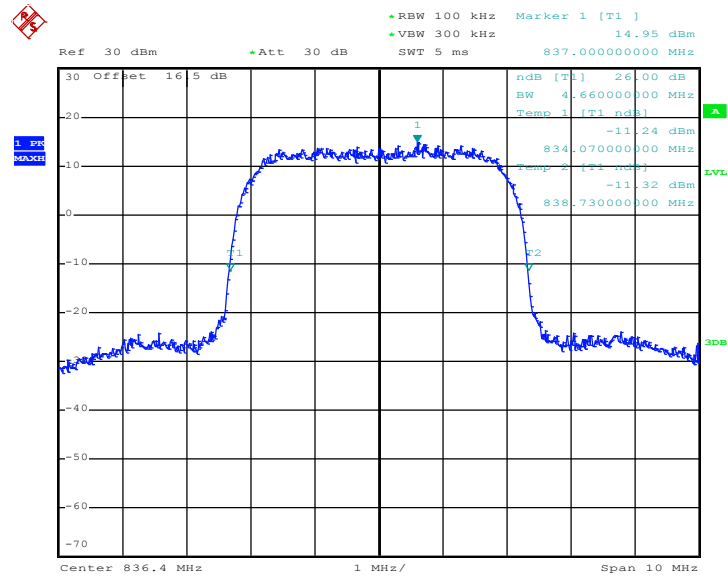

Date: 3.DEC.2014 11:12:01



99% Occupied Bandwidth Plot on Channel 4233 (846.6 MHz)

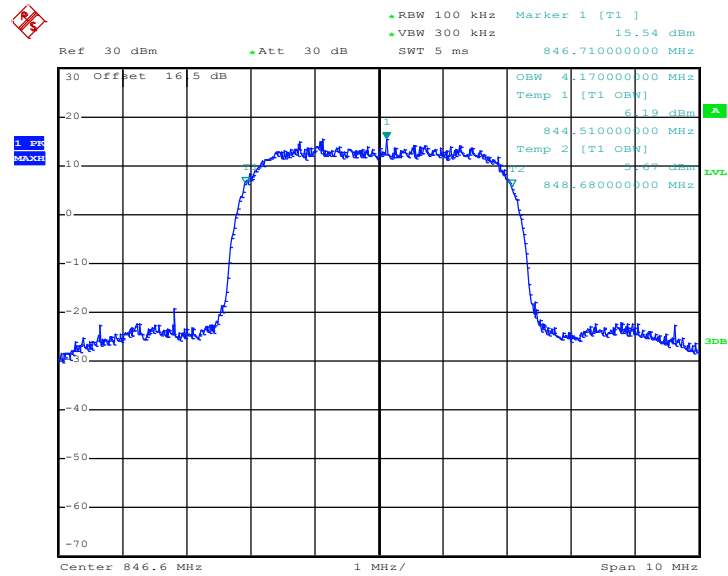

Date: 3.DEC.2014 11:15:21

26dB Bandwidth Plot on Channel 4233 (846.6 MHz)

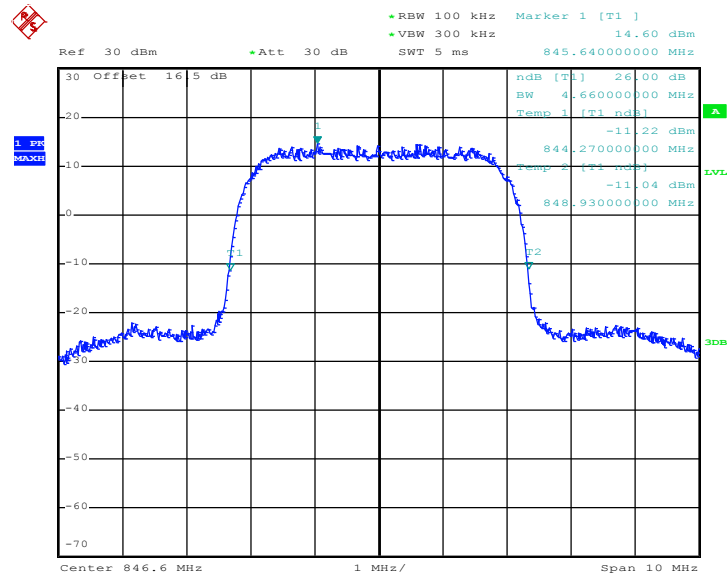

Date: 3.DEC.2014 11:12:29



Band :	WCDMA Band IV	Test Mode :	RMC 12.2Kbps Link (QPSK)
---------------	---------------	--------------------	--------------------------

99% Occupied Bandwidth Plot on Channel 1312 (1712.4 MHz)

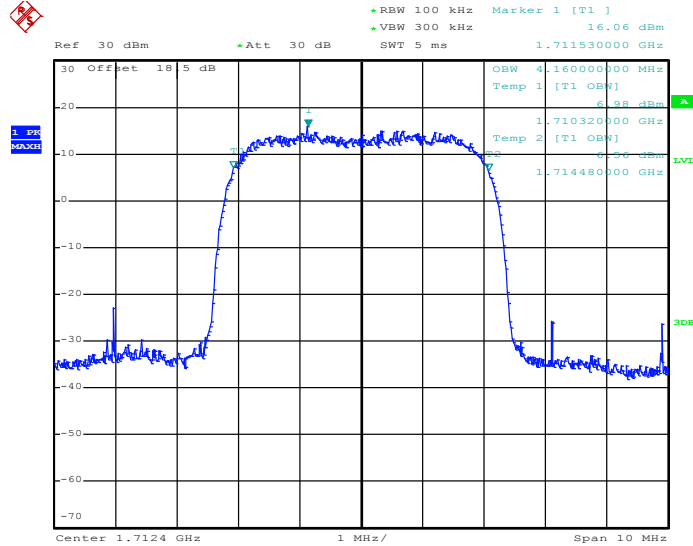

Date: 3.DEC.2014 15:50:07

26dB Bandwidth Plot on Channel 1312 (1712.4 MHz)

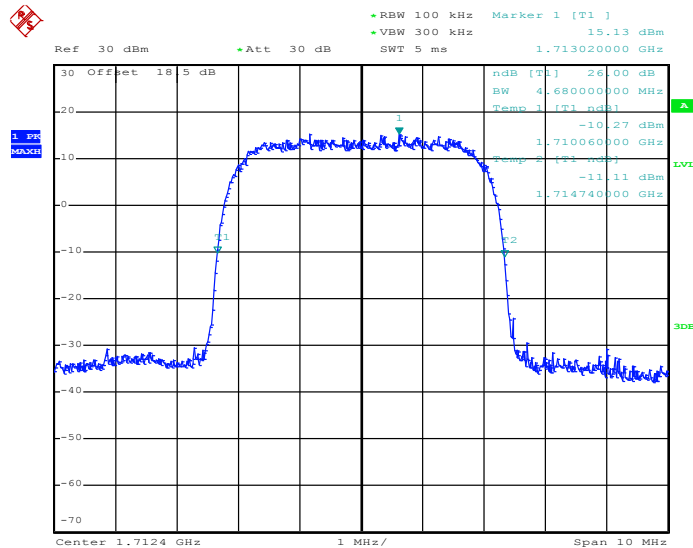

Date: 3.DEC.2014 15:48:34



99% Occupied Bandwidth Plot on Channel 1413 (1732.6 MHz)

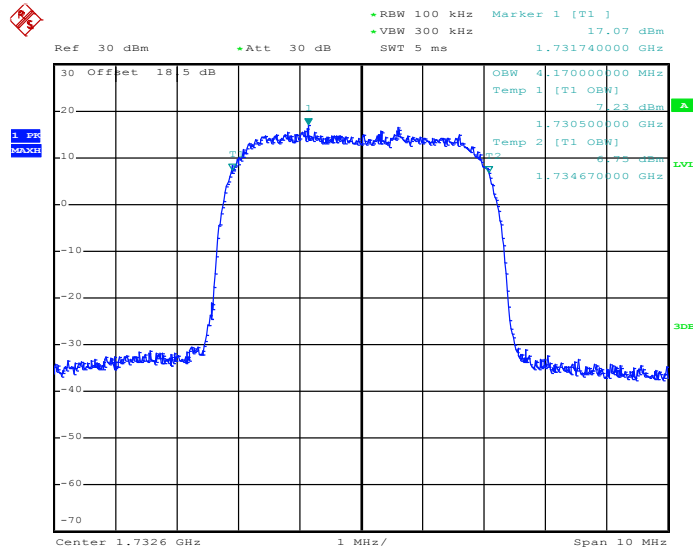

Date: 3.DEC.2014 15:50:35

26dB Bandwidth Plot on Channel 1413 (1732.6 MHz)

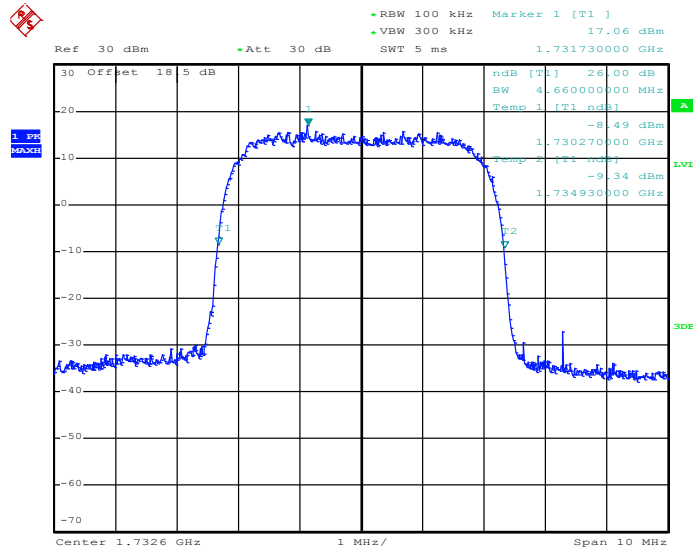

Date: 3.DEC.2014 15:49:02



99% Occupied Bandwidth Plot on Channel 1513 (1752.6 MHz)

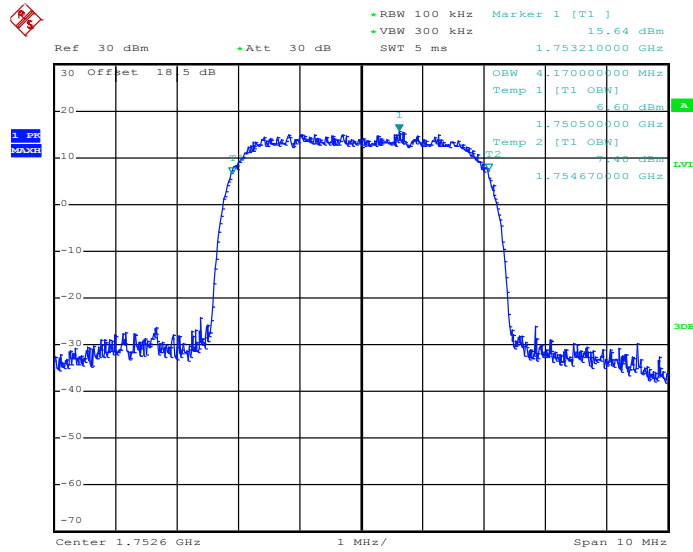

Date: 3.DEC.2014 15:51:03

26dB Bandwidth Plot on Channel 1513 (1752.6 MHz)

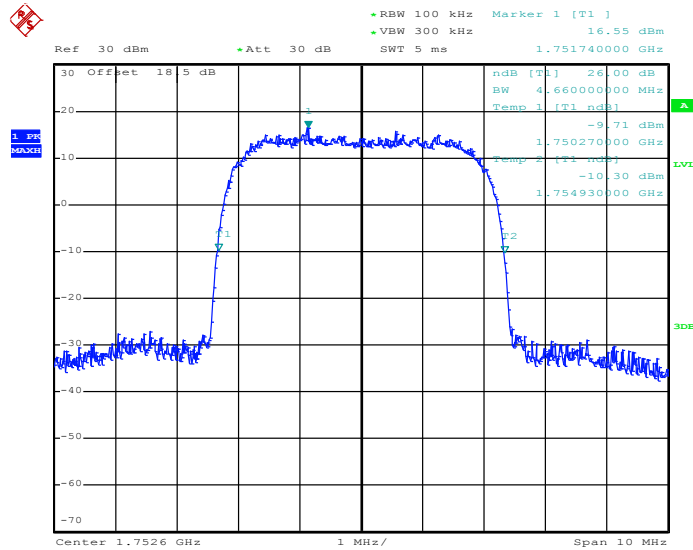

Date: 3.DEC.2014 15:49:30



Band :	WCDMA Band II	Test Mode :	RMC 12.2Kbps Link (QPSK)
---------------	---------------	--------------------	--------------------------

99% Occupied Bandwidth Plot on Channel 9262 (1852.4 MHz)

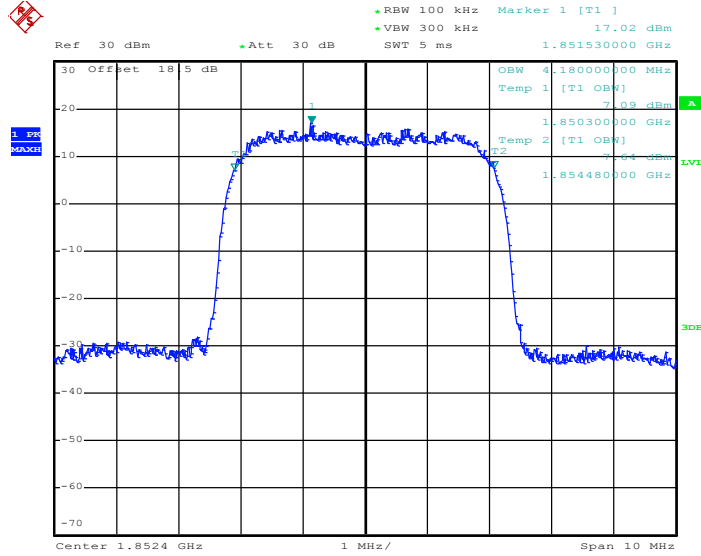

Date: 3.DEC.2014 11:26:44

26dB Bandwidth Plot on Channel 9262 (1852.4 MHz)

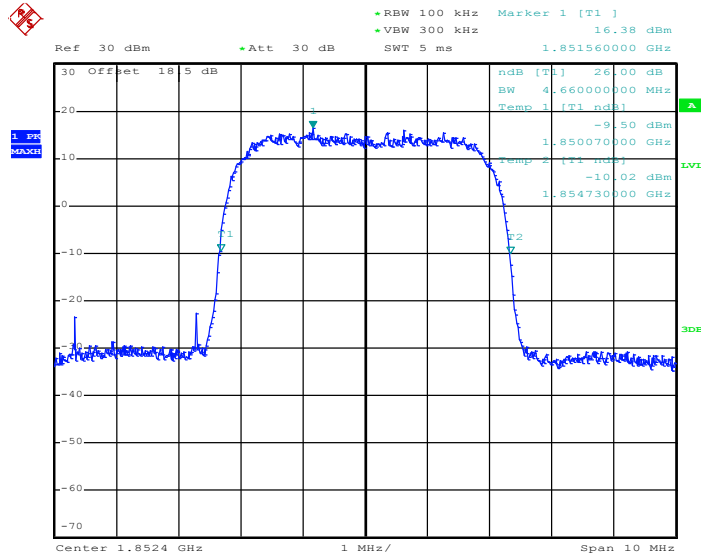

Date: 3.DEC.2014 11:25:03



99% Occupied Bandwidth Plot on Channel 9400 (1880.0 MHz)

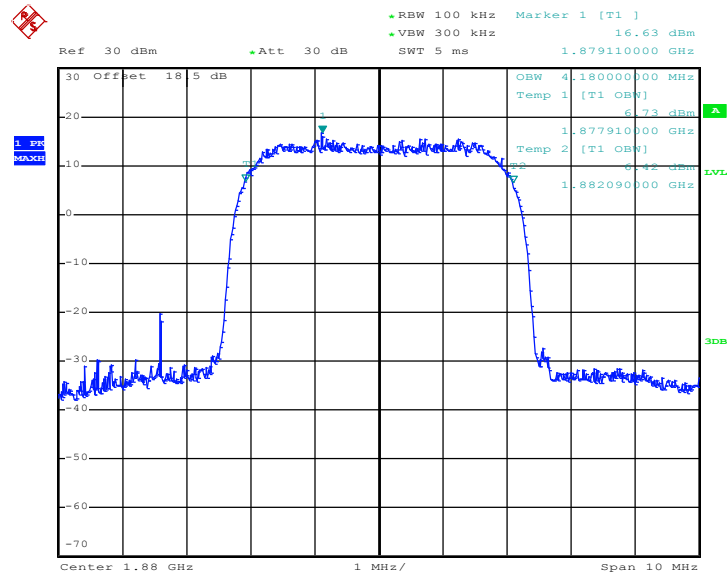

Date: 3.DEC.2014 11:27:12

26dB Bandwidth Plot on Channel 9400 (1880.0 MHz)

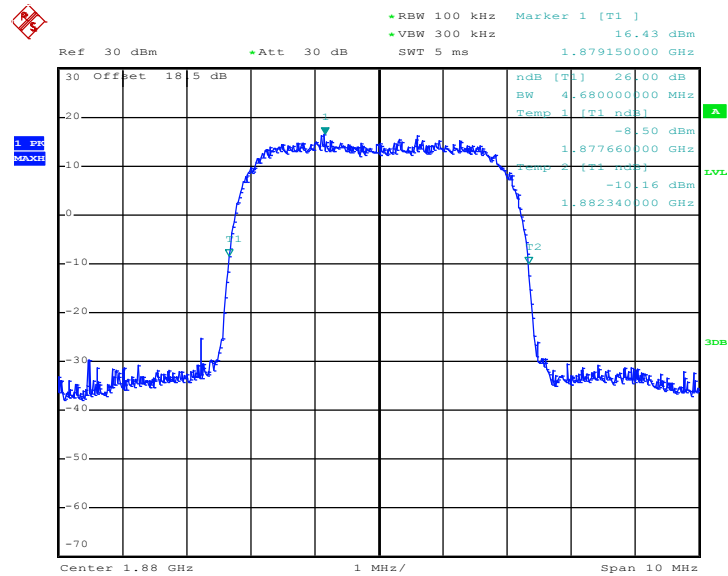

Date: 3.DEC.2014 11:25:31



99% Occupied Bandwidth Plot on Channel 9538 (1907.6 MHz)

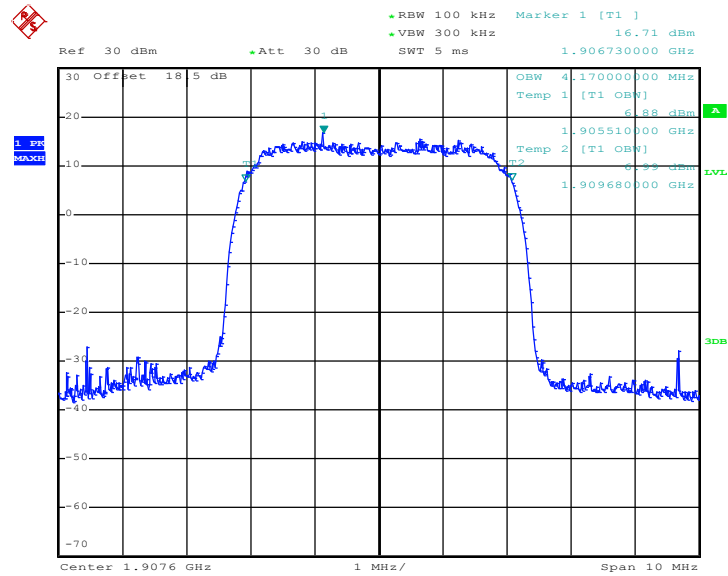

Date: 3.DEC.2014 11:27:40

26dB Bandwidth Plot on Channel 9538 (1907.6 MHz)

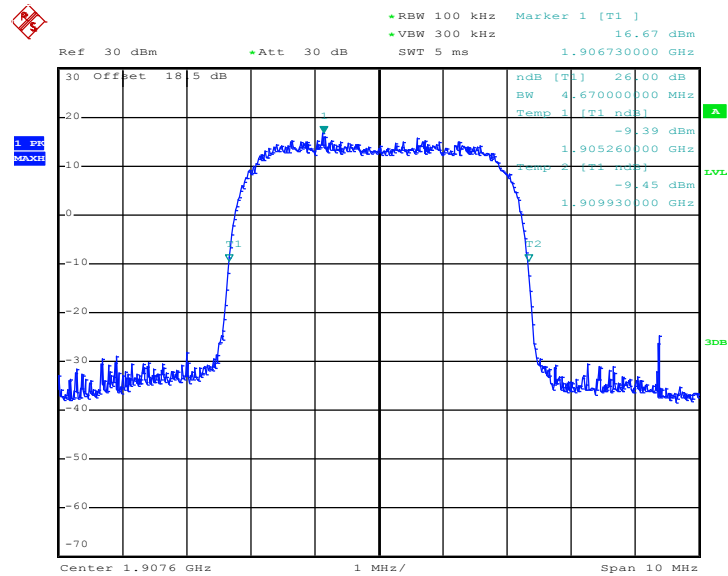

Date: 3.DEC.2014 11:25:59

3.5 Band Edge Measurement

3.5.1 Description of Band Edge Measurement

The power of any emission outside of the authorized operating frequency ranges must be lower than the transmitter power (P) by a factor of at least $43 + 10 \log (P)$ dB.

3.5.2 Measuring Instruments

The measuring equipment is listed in the section 4 of this test report.

3.5.3 Test Procedures

1. The testing follows FCC KDB 971168 v02r02 Section 6.0.
2. The EUT was connected to the spectrum analyzer and system simulator via a power divider.
3. The RF output of EUT was connected to the spectrum analyzer by an RF cable and attenuator. The path loss was compensated to the results for each measurement.
4. The band edges of low and high channels for the highest RF powers were measured.
5. The RF fundamental frequency should be excluded against the limit line in the operating frequency band.
6. The limit line is derived from $43 + 10\log(P)$ dB below the transmitter power P(Watts)
 $= P(W) - [43 + 10\log(P)]$ (dB)
 $= [30 + 10\log(P)]$ (dBm) - $[43 + 10\log(P)]$ (dB)
 $= -13\text{dBm}$.

3.5.4 Test Setup

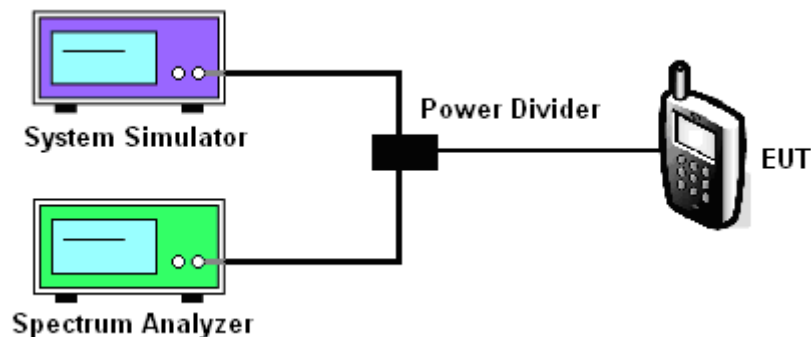



3.5.5 Test Result (Plots) of Conducted Band Edge

Band :	GSM850	Test Mode :	GPRS class 8 Link (GMSK)
--------	--------	-------------	--------------------------

Lower Band Edge Plot on Channel 128 (824.2 MHz)

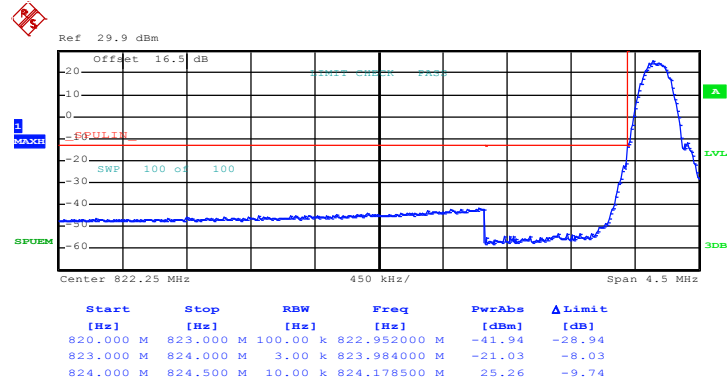

Date: 4.DEC.2014 11:51:56

Higher Band Edge Plot on Channel 251 (848.8 MHz)

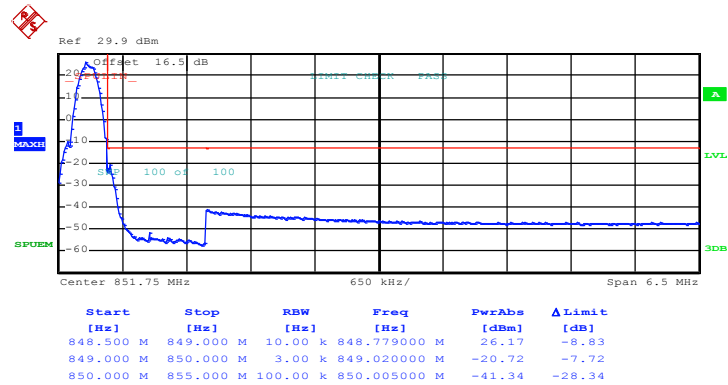

Date: 4.DEC.2014 11:49:00



Band :	GSM850	Test Mode :	EDGE class 8 Link (8PSK)
--------	--------	-------------	--------------------------

Lower Band Edge Plot on Channel 128 (824.2 MHz)

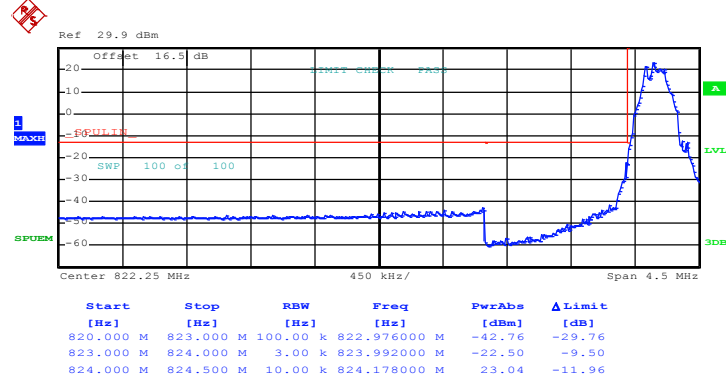

Date: 4.DEC.2014 11:45:03

Higher Band Edge Plot on Channel 251 (848.8 MHz)

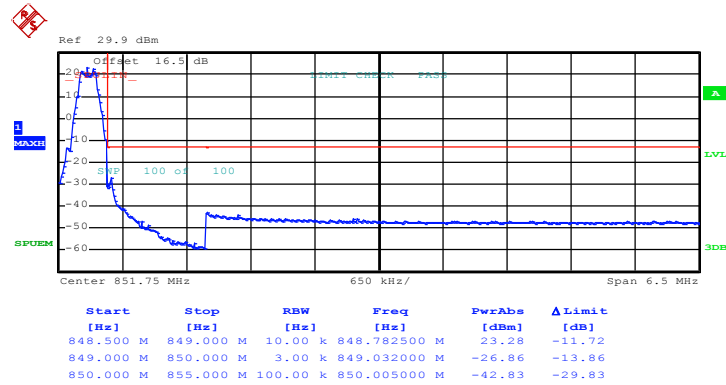

Date: 4.DEC.2014 11:41:06



Band : GSM1900	Test Mode : GPRS class 8 Link (GMSK)
----------------	--------------------------------------

Lower Band Edge Plot on Channel 512 (1850.2 MHz)

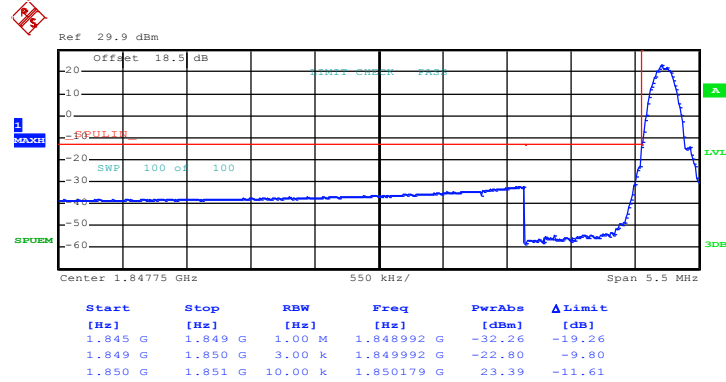

Date: 4.DEC.2014 12:00:54

Higher Band Edge Plot on Channel 810 (1909.8 MHz)

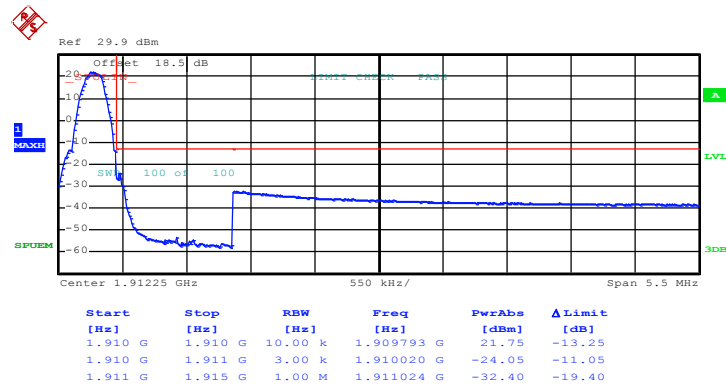

Date: 4.DEC.2014 11:57:25



Band : GSM1900	Test Mode : EDGE class 8 Link (8PSK)
----------------	--------------------------------------

Lower Band Edge Plot on Channel 512 (1850.2 MHz)

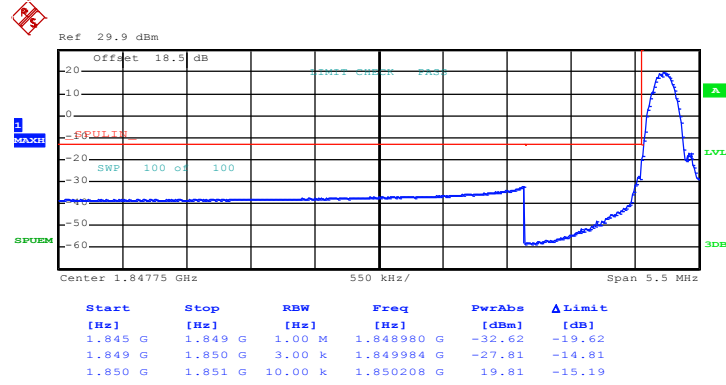

Date: 4.DEC.2014 12:28:39

Higher Band Edge Plot on Channel 810 (1909.8 MHz)

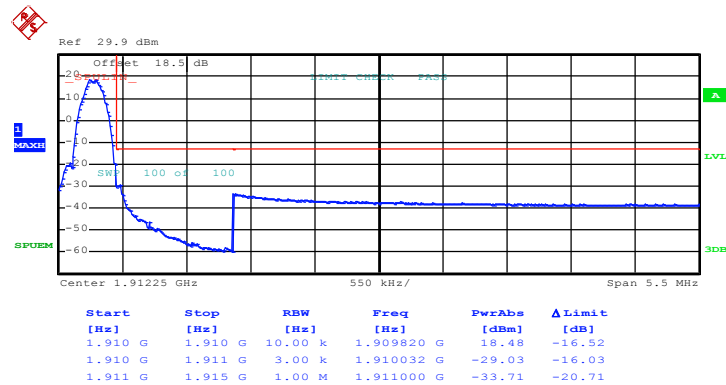

Date: 4.DEC.2014 12:05:52



Band : WCDMA Band V	Test Mode : RMC 12.2Kbps Link (QPSK)
---------------------	--------------------------------------

Lower Band Edge Plot on Channel 4132 (826.4 MHz)

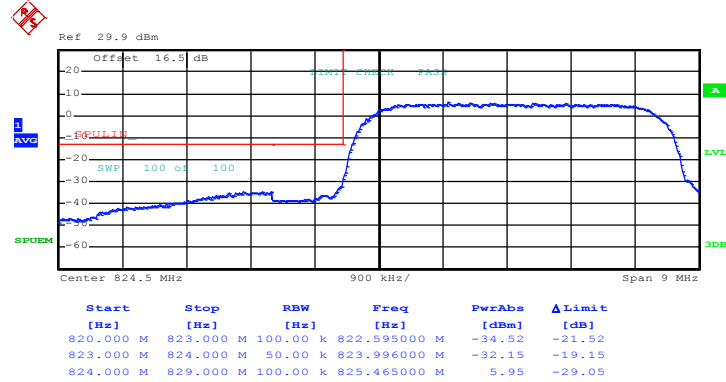

Date: 3.DEC.2014 11:18:22

Higher Band Edge Plot on Channel 4233 (846.6 MHz)

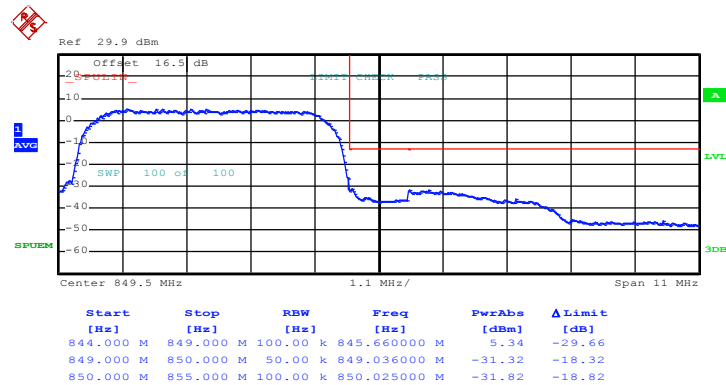

Date: 3.DEC.2014 11:20:42



Band : WCDMA Band IV	Test Mode : RMC 12.2Kbps Link (QPSK)
-----------------------------	---

Lower Band Edge Plot on Channel 1312 (1712.4 MHz)

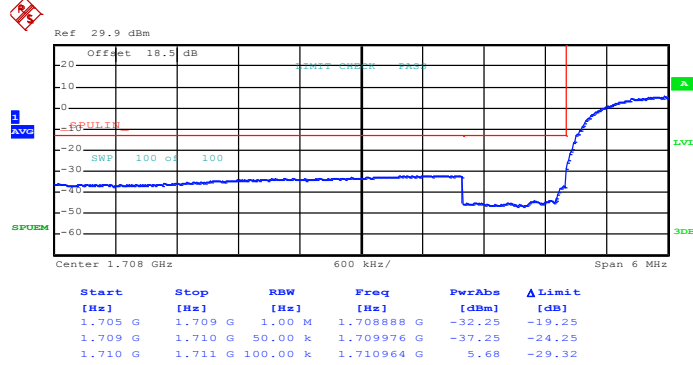

Date: 3.DEC.2014 15:53:42

Higher Band Edge Plot on Channel 1513 (1752.6 MHz)

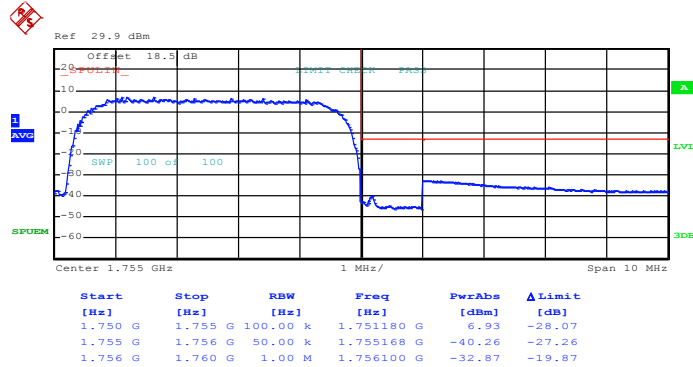

Date: 3.DEC.2014 15:56:01



Band :	WCDMA Band II	Test Mode :	RMC 12.2Kbps Link (QPSK)
--------	---------------	-------------	--------------------------

Lower Band Edge Plot on Channel 9262 (1852.4 MHz)

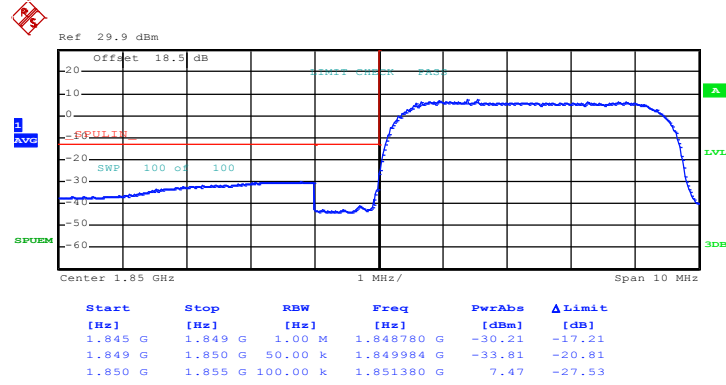

Date: 3.DEC.2014 11:30:14

Higher Band Edge Plot on Channel 9538 (1907.6 MHz)

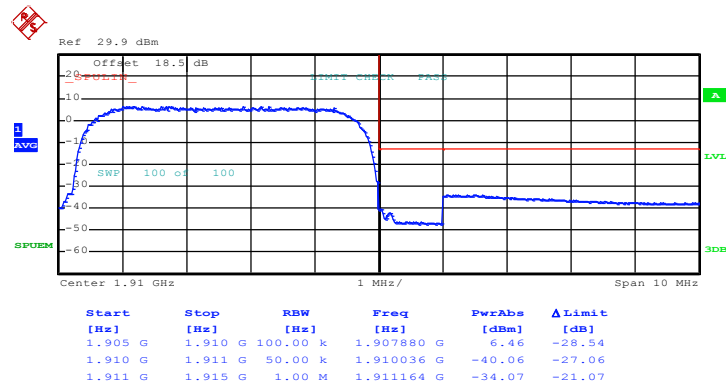

Date: 3.DEC.2014 11:32:36

3.6 Conducted Spurious Emission Measurement

3.6.1 Description of Conducted Spurious Emission Measurement

The power of any emission outside of the authorized operating frequency ranges must be lower than the transmitter power (P) by a factor of at least $43 + 10 \log (P)$ dB.

It is measured by means of a calibrated spectrum analyzer and scanned from 30 MHz up to a frequency including its 10th harmonic.

3.6.2 Measuring Instruments

The measuring equipment is listed in the section 4 of this test report.

3.6.3 Test Procedures

1. The testing follows FCC KDB 971168 v02r02 Section 6.0.
2. The EUT was connected to the spectrum analyzer and system simulator via a power divider.
3. The RF output of EUT was connected to the spectrum analyzer by an RF cable and attenuator. The path loss was compensated to the results for each measurement.
4. The middle channel for the highest RF power within the transmitting frequency was measured.
5. The conducted spurious emission for the whole frequency range was taken.
6. The RF fundamental frequency should be excluded against the limit line in the operating frequency band.
7. The limit line is derived from $43 + 10\log(P)$ dB below the transmitter power P(Watts)
 $= P(W) - [43 + 10\log(P)]$ (dB)
 $= [30 + 10\log(P)]$ (dBm) - $[43 + 10\log(P)]$ (dB)
 $= -13\text{dBm}$.

3.6.4 Test Setup

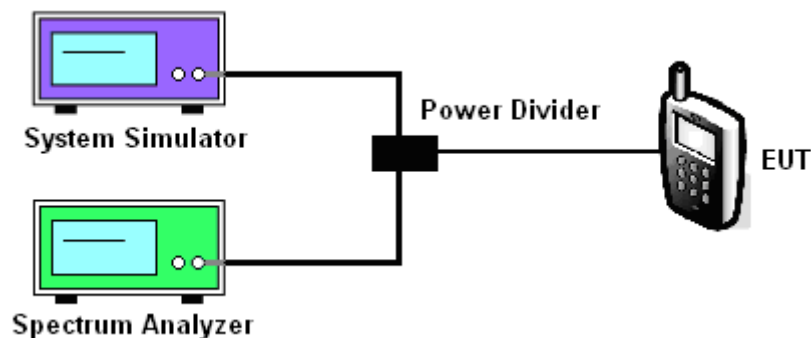



3.6.5 Test Result (Plots) of Conducted Spurious Emission

Band :	GSM850	Channel :	CH128
Test Mode :	GPRS class 8 Link (GMSK)	Frequency :	824.2 MHz

Conducted Spurious Emission Plot between 30MHz ~ 9GHz

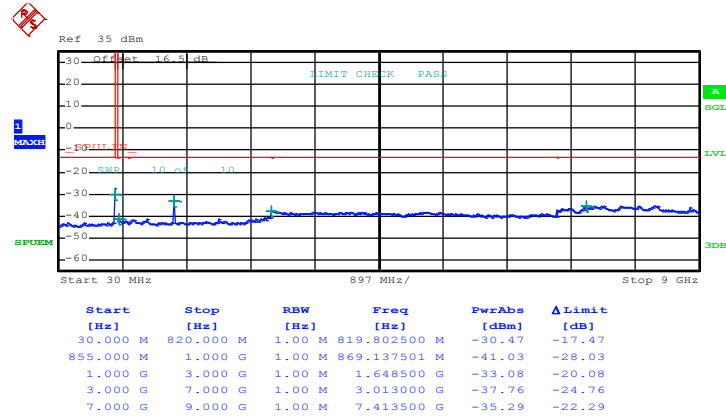

Date: 2.DEC.2014 19:35:08



Band :	GSM850	Channel :	CH189
Test Mode :	GPRS class 8 Link (GMSK)	Frequency :	836.4 MHz

Conducted Spurious Emission Plot between 30MHz ~ 9GHz

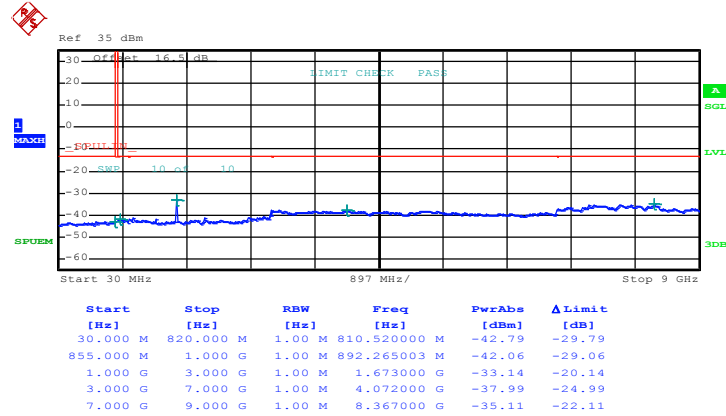

Date: 2.DEC.2014 19:36:23



Band :	GSM850	Channel :	CH251
Test Mode :	GPRS class 8 Link (GMSK)	Frequency :	848.8 MHz

Conducted Spurious Emission Plot between 30MHz ~ 9GHz

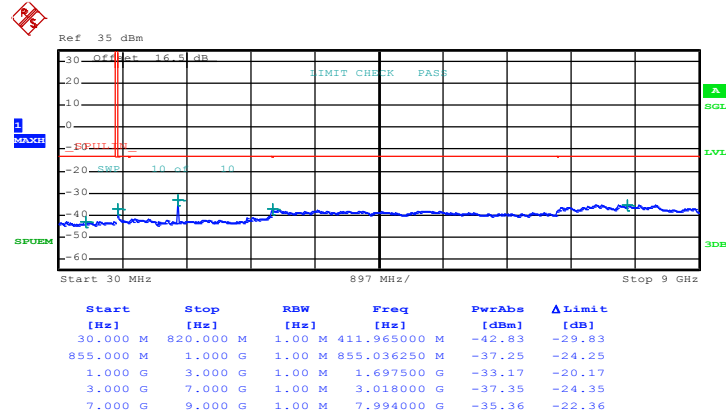

Date: 2.DEC.2014 19:37:01



Band :	GSM850	Channel :	CH128
Test Mode :	EDGE class 8 Link (8PSK)	Frequency :	824.2 MHz

Conducted Spurious Emission Plot between 30MHz ~ 9GHz

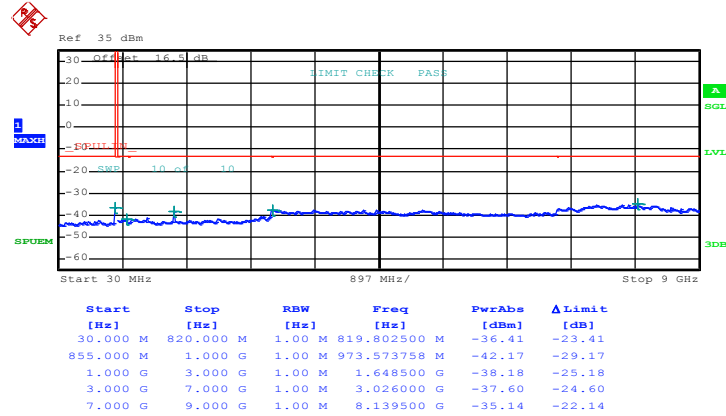

Date: 2.DEC.2014 19:56:18



Band :	GSM850	Channel :	CH189
Test Mode :	EDGE class 8 Link (8PSK)	Frequency :	836.4 MHz

Conducted Spurious Emission Plot between 30MHz ~ 9GHz

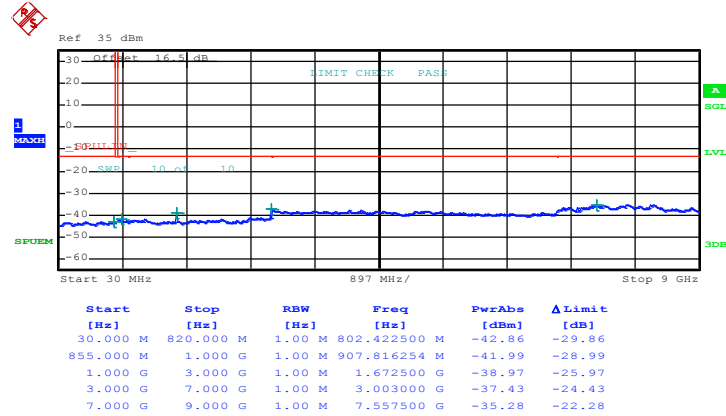

Date: 2.DEC.2014 19:56:50



Band :	GSM850	Channel :	CH251
Test Mode :	EDGE class 8 Link (8PSK)	Frequency :	848.8 MHz

Conducted Spurious Emission Plot between 30MHz ~ 9GHz

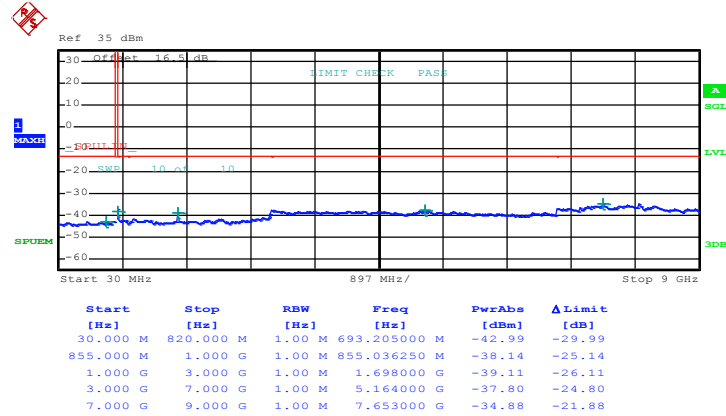

Date: 2.DEC.2014 19:57:32



Band :	GSM1900	Channel :	CH512
Test Mode :	GPRS class 8 Link (GMSK)	Frequency :	1850.2 MHz

Conducted Spurious Emission Plot between 30MHz ~ 19.1GHz

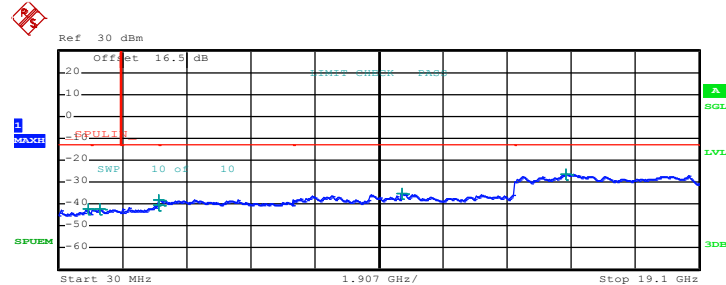

Date: 3.DEC.2014 15:17:11



Band :	GSM1900	Channel :	CH661
Test Mode :	GPRS class 8 Link (GMSK)	Frequency :	1880.0 MHz

Conducted Spurious Emission Plot between 30MHz ~ 19.1GHz

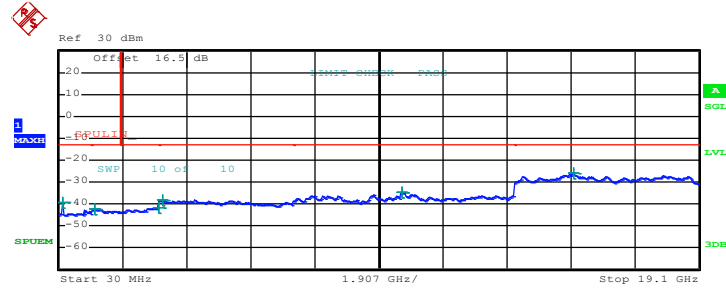

Date: 3.DEC.2014 15:18:21



Band :	GSM1900	Channel :	CH810
Test Mode :	GPRS class 8 Link (GMSK)	Frequency :	1909.8 MHz

Conducted Spurious Emission Plot between 30MHz ~ 19.1GHz

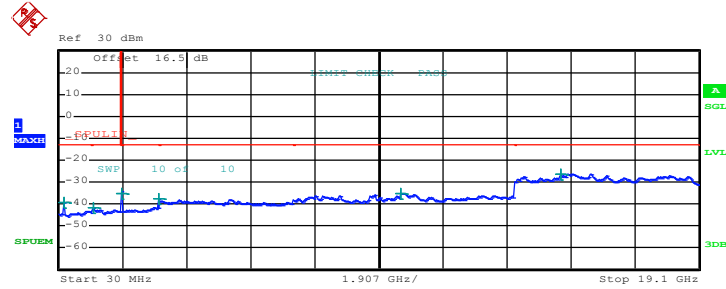

Start [Hz]	Stop [Hz]	RBW [Hz]	Freq [Hz]	PwrAbs [dBm]	Δ Limit [dB]
30.000 M	1.000 G	1.00 M	171.620000 M	-39.59	-26.59
1.000 G	1.845 G	1.00 M	1.047743 G	-41.64	-28.64
1.915 G	3.000 G	1.00 M	1.915271 G	-35.13	-22.13
3.000 G	7.000 G	1.00 M	3.003000 G	-37.60	-24.60
7.000 G	13.600 G	1.00 M	10.224925 G	-35.17	-22.17
13.600 G	19.100 G	1.00 M	14.986000 G	-26.26	-13.26

Date: 3.DEC.2014 15:20:49



Band :	GSM1900	Channel :	CH512
Test Mode :	EDGE class 8 Link (8PSK)	Frequency :	1850.2 MHz

Conducted Spurious Emission Plot between 30MHz ~ 19.1GHz

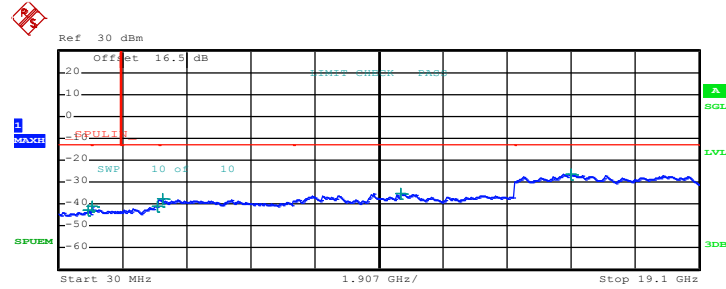

Start [Hz]	Stop [Hz]	RBW [Hz]	Freq [Hz]	PwrAbs [dBm]	Δ Limit [dB]
30.000 M	1.000 G	1.00 M	891.117500 M	-43.09	-30.09
1.000 G	1.845 G	1.00 M	1.025773 G	-41.30	-28.30
1.915 G	3.000 G	1.00 M	2.951989 G	-40.86	-27.86
3.000 G	7.000 G	1.00 M	3.112000 G	-37.75	-24.75
7.000 G	13.600 G	1.00 M	10.219150 G	-35.23	-22.23
13.600 G	19.100 G	1.00 M	15.274750 G	-26.23	-13.23

Date: 3.DEC.2014 15:28:31



Band :	GSM1900	Channel :	CH661
Test Mode :	EDGE class 8 Link (8PSK)	Frequency :	1880.0 MHz

Conducted Spurious Emission Plot between 30MHz ~ 19.1GHz

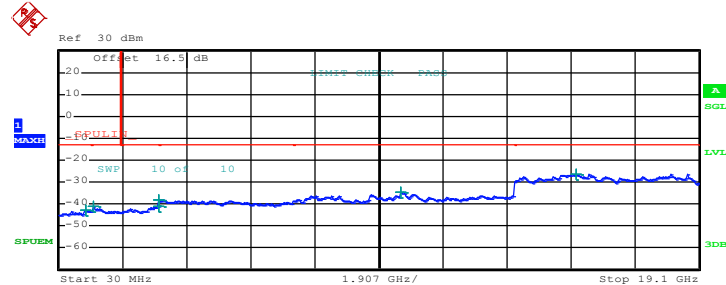

Date: 3.DEC.2014 15:29:03



Band :	GSM1900	Channel :	CH810
Test Mode :	EDGE class 8 Link (8PSK)	Frequency :	1909.8 MHz

Conducted Spurious Emission Plot between 30MHz ~ 19.1GHz

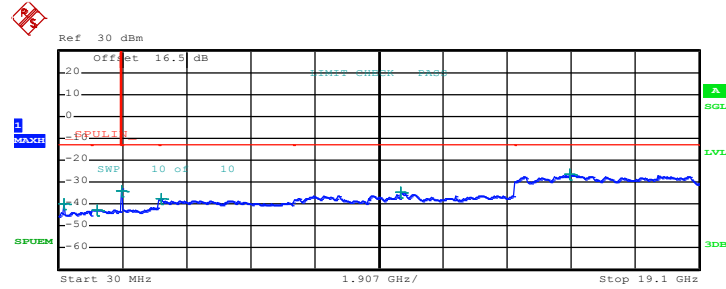

Date: 3.DEC.2014 15:29:30



Band :	WCDMA Band V	Channel :	CH4132
Test Mode :	RMC 12.2Kbps Link (QPSK)	Frequency :	826.4 MHz

Conducted Spurious Emission Plot between 30MHz ~ 9GHz

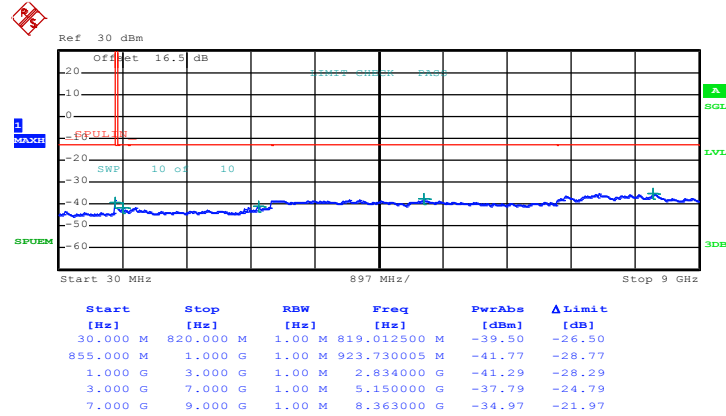

Date: 3.DEC.2014 11:21:17



Band :	WCDMA Band V	Channel :	CH4182
Test Mode :	RMC 12.2Kbps Link (QPSK)	Frequency :	836.4 MHz

Conducted Spurious Emission Plot between 30MHz ~ 9GHz

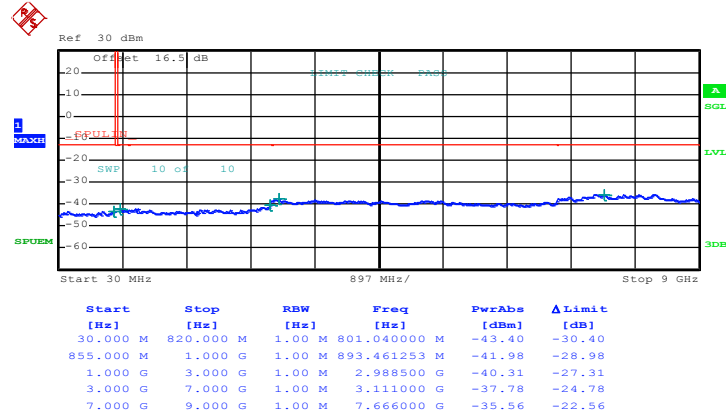

Date: 3.DEC.2014 11:21:36



Band :	WCDMA Band V	Channel :	CH4233
Test Mode :	RMC 12.2Kbps Link (QPSK)	Frequency :	846.6 MHz

Conducted Spurious Emission Plot between 30MHz ~ 9GHz

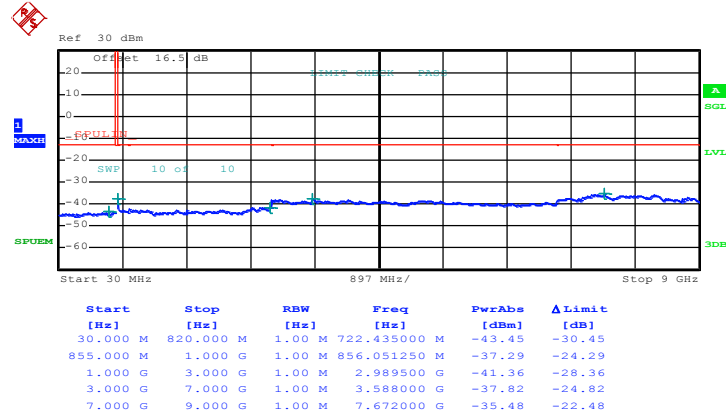

Date: 3.DEC.2014 11:21:56



Band :	WCDMA Band IV	Channel :	CH1312
Test Mode :	RMC 12.2Kbps Link (QPSK)	Frequency :	1712.4 MHz

Conducted Spurious Emission Plot between 30MHz ~ 18GHz

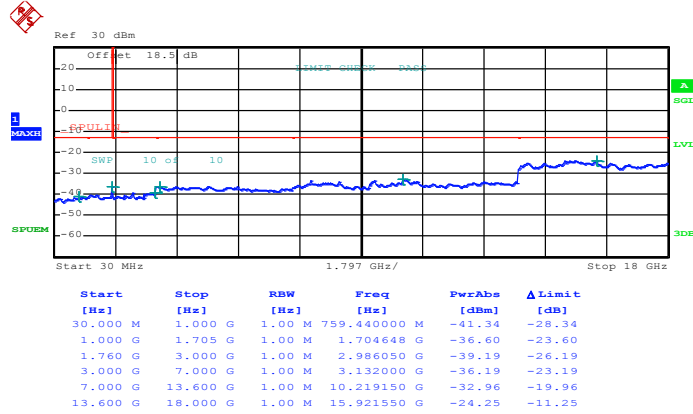

Date: 3.DEC.2014 15:56:32



Band :	WCDMA Band IV	Channel :	CH1413
Test Mode :	RMC 12.2Kbps Link (QPSK)	Frequency :	1732.6 MHz

Conducted Spurious Emission Plot between 30MHz ~ 18GHz

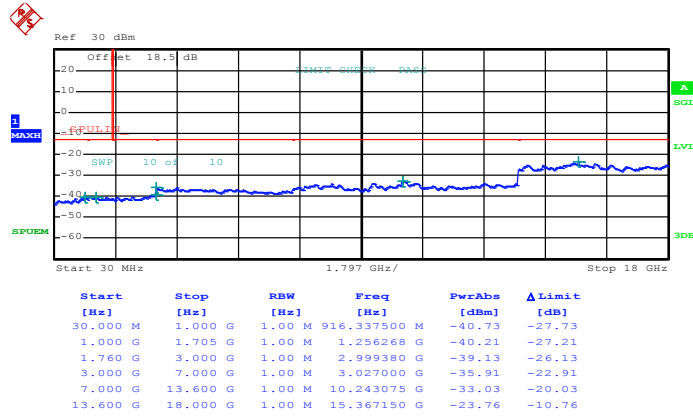

Date: 3.DEC.2014 15:57:04



Band :	WCDMA Band IV	Channel :	CH1513
Test Mode :	RMC 12.2Kbps Link (QPSK)	Frequency :	1752.6 MHz

Conducted Spurious Emission Plot between 30MHz ~ 18GHz

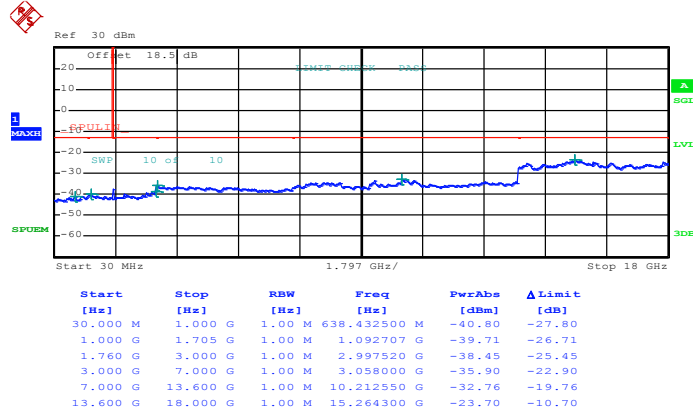

Date: 3.DEC.2014 15:57:29



Band :	WCDMA Band II	Channel :	CH9262
Test Mode :	RMC 12.2Kbps Link (QPSK)	Frequency :	1852.4 MHz

Conducted Spurious Emission Plot between 30MHz ~ 19.1GHz

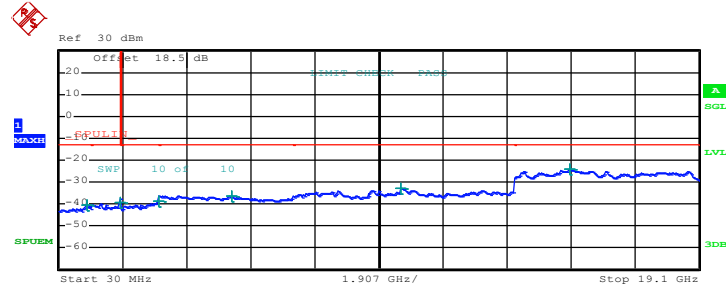

Date: 3.DEC.2014 11:33:17



Band :	WCDMA Band II	Channel :	CH9400
Test Mode :	RMC 12.2Kbps Link (QPSK)	Frequency :	1880.0 MHz

Conducted Spurious Emission Plot between 30MHz ~ 19.1GHz

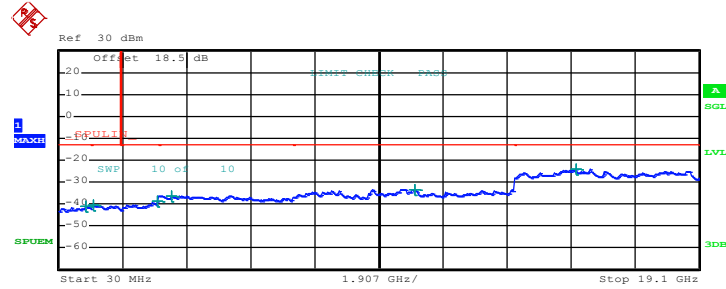

Start [Hz]	Stop [Hz]	RBW [Hz]	Freq [Hz]	PwrAbs [dBm]	Δ Limit [dB]
30.000 M	1.000 G	1.00 M	832.917500 M	-40.81	-27.81
1.000 G	1.845 G	1.00 M	1.073515 G	-40.51	-27.51
1.915 G	3.000 G	1.00 M	2.970434 G	-38.58	-25.58
3.000 G	7.000 G	1.00 M	3.375000 G	-36.11	-23.11
7.000 G	13.600 G	1.00 M	10.644850 G	-33.18	-20.18
13.600 G	19.100 G	1.00 M	15.435625 G	-24.28	-11.28

Date: 3.DEC.2014 11:33:44



Band :	WCDMA Band II	Channel :	CH9538
Test Mode :	RMC 12.2Kbps Link (QPSK)	Frequency :	1907.6 MHz

Conducted Spurious Emission Plot between 30MHz ~ 19.1GHz

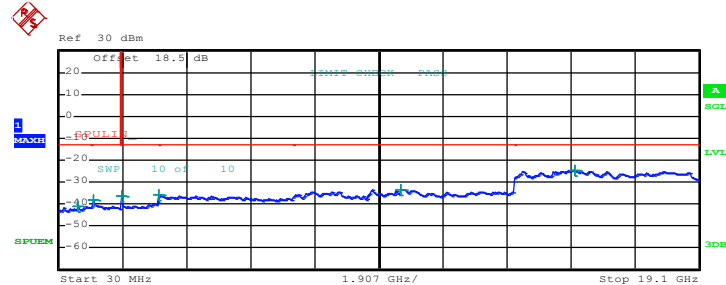

Start [Hz]	Stop [Hz]	RBW [Hz]	Freq [Hz]	PwrAbs [dBm]	Δ Limit [dB]
30.000 M	1.000 G	1.00 M	593.570000 M	-41.29	-28.29
1.000 G	1.845 G	1.00 M	1.068023 G	-38.35	-25.35
1.915 G	3.000 G	1.00 M	1.915271 G	-36.65	-23.65
3.000 G	7.000 G	1.00 M	3.009000 G	-35.94	-22.94
7.000 G	13.600 G	1.00 M	10.217500 G	-33.21	-20.21
13.600 G	19.100 G	1.00 M	15.390938 G	-24.58	-11.58

Date: 3.DEC.2014 11:34:26



3.7 Field Strength of Spurious Radiation Measurement

3.7.1 Description of Field Strength of Spurious Radiated Measurement

The power of any emission outside of the authorized operating frequency ranges must be attenuated below the transmitter power (P) by a factor of at least $43 + 10 \log (P)$ dB. The spectrum is scanned from 30 MHz up to a frequency including its 10th harmonic.

3.7.2 Measuring Instruments

The measuring equipment is listed in the section 4 of this test report.

3.7.3 Test Procedures

1. The testing follows FCC KDB 971168 v02r02 Section 5.8 and ANSI / TIA-603-C-2004 Section 2.2.12.
2. The EUT was placed on a rotatable wooden table 0.8 meters above the ground.
3. The EUT was set 3 meters from the receiving antenna, which was mounted on the antenna tower.
4. The table was rotated 360 degrees to determine the position of the highest spurious emission.
5. The height of the receiving antenna is varied between one meter and four meters to search for the maximum spurious emission for both horizontal and vertical polarizations.
6. Make the measurement with the spectrum analyzer's RBW = 1MHz, VBW = 3MHz, taking record of maximum spurious emission.
7. A horn antenna was substituted in place of the EUT and was driven by a signal generator.
8. Tune the output power of signal generator to the same emission level with EUT maximum spurious emission.
9. Taking the record of output power at antenna port.
10. Repeat step 7 to step 8 for another polarization.
11. EIRP (dBm) = S.G. Power – Tx Cable Loss + Tx Antenna Gain
12. ERP (dBm) = EIRP - 2.15
13. The RF fundamental frequency should be excluded against the limit line in the operating frequency band.
14. The limit line is derived from $43 + 10\log(P)$ dB below the transmitter power P(Watts)
= $P(W) - [43 + 10\log(P)]$ (dB)
= $[30 + 10\log(P)]$ (dBm) - $[43 + 10\log(P)]$ (dB)
= -13dBm.

3.7.4 Test Setup

For radiated emissions from 30MHz to 1GHz

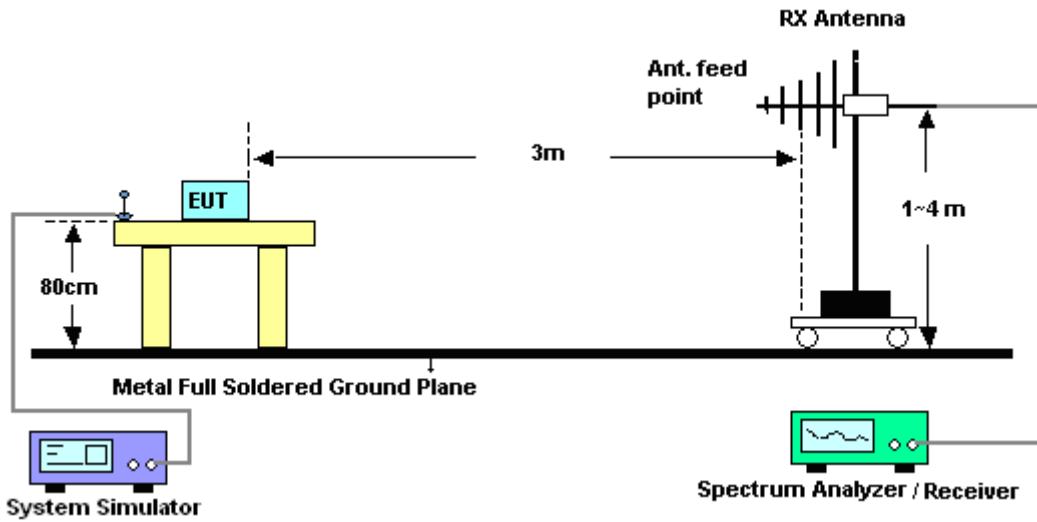

For radiated emissions above 1GHz

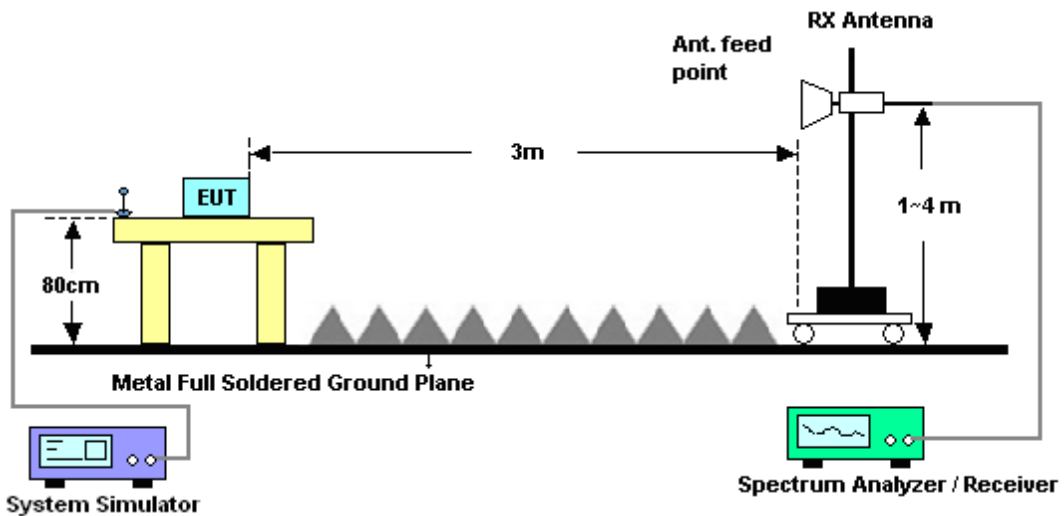



3.7.5 Test Result of Field Strength of Spurious Radiated

<Low Channel>

Band :	GSM850		Temperature :	23~24°C					
Test Mode :	GPRS class 8 Link (GMSK)		Relative Humidity :	46~48%					
Test Engineer :	Nick Yu, Dereck Chen, and Ken Wu		Polarization :	Horizontal					
Remark :	Spurious emissions within 30-1000MHz were found more than 20dB below limit line.								
Frequency (MHz)	ERP (dBm)	Limit (dBm)	Over Limit (dB)	SPA Reading (dBm)	S.G. Power (dBm)	TX Cable loss (dB)	TX Antenna Gain (dBi)	Polarization (H/V)	Result
1648	-48.22	-13	-35.22	-58.7	-49.98	0.98	4.89	H	Pass
2472	-45.31	-13	-32.31	-60.42	-47.19	1.28	5.32	H	Pass
3296	-49.85	-13	-36.85	-65.74	-53.26	1.54	7.10	H	Pass

Band :	GSM850		Temperature :	23~24°C					
Test Mode :	GPRS class 8 Link (GMSK)		Relative Humidity :	46~48%					
Test Engineer :	Nick Yu, Dereck Chen, and Ken Wu		Polarization :	Vertical					
Remark :	Spurious emissions within 30-1000MHz were found more than 20dB below limit line.								
Frequency (MHz)	ERP (dBm)	Limit (dBm)	Over Limit (dB)	SPA Reading (dBm)	S.G. Power (dBm)	TX Cable loss (dB)	TX Antenna Gain (dBi)	Polarization (H/V)	Result
1648	-49.73	-13	-36.73	-62.65	-51.49	0.98	4.89	V	Pass
2472	-46.99	-13	-33.99	-63.01	-48.87	1.28	5.32	V	Pass
3296	-49.06	-13	-36.06	-66.43	-52.47	1.54	7.10	V	Pass



<Middle Channel>

Band :	GSM850		Temperature :	23~24°C					
Test Mode :	GPRS class 8 Link (GMSK)		Relative Humidity :	46~48%					
Test Engineer :	Nick Yu, Dereck Chen, and Ken Wu		Polarization :	Horizontal					
Remark :	Spurious emissions within 30-1000MHz were found more than 20dB below limit line.								
Frequency (MHz)	ERP (dBm)	Limit (dBm)	Over Limit (dB)	SPA Reading (dBm)	S.G. Power (dBm)	TX Cable loss (dB)	TX Antenna Gain (dBi)	Polarization (H/V)	Result
1672	-48.60	-13	-35.60	-59.71	-50.28	0.99	4.82	H	Pass
2512	-42.70	-13	-29.70	-58.12	-44.67	1.29	5.41	H	Pass
3344	-49.88	-13	-36.88	-65.94	-53.49	1.56	7.31	H	Pass

Band :	GSM850		Temperature :	23~24°C					
Test Mode :	GPRS class 8 Link (GMSK)		Relative Humidity :	46~48%					
Test Engineer :	Nick Yu, Dereck Chen, and Ken Wu		Polarization :	Vertical					
Remark :	Spurious emissions within 30-1000MHz were found more than 20dB below limit line.								
Frequency (MHz)	ERP (dBm)	Limit (dBm)	Over Limit (dB)	SPA Reading (dBm)	S.G. Power (dBm)	TX Cable loss (dB)	TX Antenna Gain (dBi)	Polarization (H/V)	Result
1672	-48.10	-13	-35.10	-61.44	-49.78	0.99	4.82	V	Pass
2512	-38.34	-13	-25.34	-54.42	-40.31	1.29	5.41	V	Pass
3344	-47.88	-13	-34.88	-65.46	-51.49	1.56	7.31	V	Pass



<High Channel>

Band :	GSM850		Temperature :	23~24°C					
Test Mode :	GPRS class 8 Link (GMSK)		Relative Humidity :	46~48%					
Test Engineer :	Nick Yu, Dereck Chen, and Ken Wu		Polarization :	Horizontal					
Remark :	Spurious emissions within 30-1000MHz were found more than 20dB below limit line.								
Frequency (MHz)	ERP (dBm)	Limit (dBm)	Over Limit (dB)	SPA Reading (dBm)	S.G. Power (dBm)	TX Cable loss (dB)	TX Antenna Gain (dBi)	Polarization (H/V)	Result
1696	-50.89	-13	-37.89	-62.01	-52.49	1.00	4.75	H	Pass
2544	-48.19	-13	-35.19	-63.39	-50.17	1.30	5.44	H	Pass
3392	-49.74	-13	-36.74	-65.77	-53.54	1.57	7.52	H	Pass

Band :	GSM850		Temperature :	23~24°C					
Test Mode :	GPRS class 8 Link (GMSK)		Relative Humidity :	46~48%					
Test Engineer :	Nick Yu, Dereck Chen, and Ken Wu		Polarization :	Vertical					
Remark :	Spurious emissions within 30-1000MHz were found more than 20dB below limit line.								
Frequency (MHz)	ERP (dBm)	Limit (dBm)	Over Limit (dB)	SPA Reading (dBm)	S.G. Power (dBm)	TX Cable loss (dB)	TX Antenna Gain (dBi)	Polarization (H/V)	Result
1696	-50.29	-13	-37.29	-63.54	-51.89	1.00	4.75	V	Pass
2544	-41.59	-13	-28.59	-57.47	-43.57	1.30	5.44	V	Pass
3392	-48.91	-13	-35.91	-66.08	-52.71	1.57	7.52	V	Pass



<Low Channel>

Band :	GSM850		Temperature :	23~24°C					
Test Mode :	EDGE class 8 Link (8PSK)		Relative Humidity :	46~48%					
Test Engineer :	Nick Yu, Dereck Chen, and Ken Wu		Polarization :	Horizontal					
Remark :	Spurious emissions within 30-1000MHz were found more than 20dB below limit line.								
Frequency (MHz)	ERP (dBm)	Limit (dBm)	Over Limit (dB)	SPA Reading (dBm)	S.G. Power (dBm)	TX Cable loss (dB)	TX Antenna Gain (dBi)	Polarization (H/V)	Result
1648	-49.73	-13	-36.73	-60.37	-51.49	0.98	4.89	H	Pass
2472	-49.97	-13	-36.97	-65.25	-51.85	1.28	5.32	H	Pass
3296	-50.21	-13	-37.21	-66.17	-53.62	1.54	7.10	H	Pass

Band :	GSM850		Temperature :	23~24°C					
Test Mode :	EDGE class 8 Link (8PSK)		Relative Humidity :	46~48%					
Test Engineer :	Nick Yu, Dereck Chen, and Ken Wu		Polarization :	Vertical					
Remark :	Spurious emissions within 30-1000MHz were found more than 20dB below limit line.								
Frequency (MHz)	ERP (dBm)	Limit (dBm)	Over Limit (dB)	SPA Reading (dBm)	S.G. Power (dBm)	TX Cable loss (dB)	TX Antenna Gain (dBi)	Polarization (H/V)	Result
1648	-51.10	-13	-38.10	-63.91	-52.86	0.98	4.89	V	Pass
2472	-49.89	-13	-36.89	-65.39	-51.77	1.28	5.32	V	Pass
3296	-48.08	-13	-35.08	-65.8	-51.49	1.54	7.10	V	Pass



<Middle Channel>

Band :	GSM850		Temperature :	23~24°C					
Test Mode :	EDGE class 8 Link (8PSK)		Relative Humidity :	46~48%					
Test Engineer :	Nick Yu, Dereck Chen, and Ken Wu		Polarization :	Horizontal					
Remark :	Spurious emissions within 30-1000MHz were found more than 20dB below limit line.								
Frequency (MHz)	ERP (dBm)	Limit (dBm)	Over Limit (dB)	SPA Reading (dBm)	S.G. Power (dBm)	TX Cable loss (dB)	TX Antenna Gain (dBi)	Polarization (H/V)	Result
1672	-50.20	-13	-37.20	-61.09	-51.88	0.99	4.82	H	Pass
2512	-49.78	-13	-36.78	-65.09	-51.75	1.29	5.41	H	Pass
3344	-50.18	-13	-37.18	-66.11	-53.79	1.56	7.31	H	Pass

Band :	GSM850		Temperature :	23~24°C					
Test Mode :	EDGE class 8 Link (8PSK)		Relative Humidity :	46~48%					
Test Engineer :	Nick Yu, Dereck Chen, and Ken Wu		Polarization :	Vertical					
Remark :	Spurious emissions within 30-1000MHz were found more than 20dB below limit line.								
Frequency (MHz)	ERP (dBm)	Limit (dBm)	Over Limit (dB)	SPA Reading (dBm)	S.G. Power (dBm)	TX Cable loss (dB)	TX Antenna Gain (dBi)	Polarization (H/V)	Result
1672	-50.81	-13	-37.81	-64	-52.49	0.99	4.82	V	Pass
2512	-48.57	-13	-35.57	-64.85	-50.54	1.29	5.41	V	Pass
3344	-48.78	-13	-35.78	-66.13	-52.39	1.56	7.31	V	Pass



<High Channel>

Band :	GSM850		Temperature :	23~24°C					
Test Mode :	EDGE class 8 Link (8PSK)		Relative Humidity :	46~48%					
Test Engineer :	Nick Yu, Dereck Chen, and Ken Wu		Polarization :	Horizontal					
Remark :	Spurious emissions within 30-1000MHz were found more than 20dB below limit line.								
Frequency (MHz)	ERP (dBm)	Limit (dBm)	Over Limit (dB)	SPA Reading (dBm)	S.G. Power (dBm)	TX Cable loss (dB)	TX Antenna Gain (dBi)	Polarization (H/V)	Result
1696	-53.36	-13	-40.36	-64.47	-54.96	1.00	4.75	H	Pass
2544	-50.21	-13	-37.21	-65.33	-52.19	1.30	5.44	H	Pass
3392	-50.09	-13	-37.09	-66.32	-53.89	1.57	7.52	H	Pass

Band :	GSM850		Temperature :	23~24°C					
Test Mode :	EDGE class 8 Link (8PSK)		Relative Humidity :	46~48%					
Test Engineer :	Nick Yu, Dereck Chen, and Ken Wu		Polarization :	Vertical					
Remark :	Spurious emissions within 30-1000MHz were found more than 20dB below limit line.								
Frequency (MHz)	ERP (dBm)	Limit (dBm)	Over Limit (dB)	SPA Reading (dBm)	S.G. Power (dBm)	TX Cable loss (dB)	TX Antenna Gain (dBi)	Polarization (H/V)	Result
1696	-51.24	-13	-38.24	-64.4	-52.84	1.00	4.75	V	Pass
2544	-50.69	-13	-37.69	-66.2	-54.82	1.30	5.44	V	Pass
3392	-47.96	-13	-34.96	-65.81	-53.91	1.57	7.52	V	Pass



<Low Channel>

Band :	GSM1900		Temperature :	23~24°C					
Test Mode :	GPRS class 8 Link (GMSK)		Relative Humidity :	46~48%					
Test Engineer :	Nick Yu, Dereck Chen, and Ken Wu		Polarization :	Horizontal					
Remark :	Spurious emissions within 30-1000MHz were found more than 20dB below limit line.								
Frequency (MHz)	EIRP (dBm)	Limit (dBm)	Over Limit (dB)	SPA Reading (dBm)	S.G. Power (dBm)	TX Cable loss (dB)	TX Antenna Gain (dBi)	Polarization (H/V)	Result
3700	-50.79	-13	-37.79	-68.41	-57.36	1.67	8.24	H	Pass
5550	-45.94	-13	-32.94	-68.07	-53.01	2.65	9.72	H	Pass
7400	-38.11	-13	-25.11	-67.2	-47.25	2.46	11.60	H	Pass

Band :	GSM1900		Temperature :	23~24°C					
Test Mode :	GPRS class 8 Link (GMSK)		Relative Humidity :	46~48%					
Test Engineer :	Nick Yu, Dereck Chen, and Ken Wu		Polarization :	Vertical					
Remark :	Spurious emissions within 30-1000MHz were found more than 20dB below limit line.								
Frequency (MHz)	EIRP (dBm)	Limit (dBm)	Over Limit (dB)	SPA Reading (dBm)	S.G. Power (dBm)	TX Cable loss (dB)	TX Antenna Gain (dBi)	Polarization (H/V)	Result
3700	-49.68	-13	-36.68	-67.65	-56.25	1.67	8.24	V	Pass
5550	-46.16	-13	-33.16	-68.49	-53.23	2.65	9.72	V	Pass
7400	-39.71	-13	-26.71	-68.78	-48.85	2.46	11.60	V	Pass



<Middle Channel>

Band :	GSM1900		Temperature :	23~24°C					
Test Mode :	GPRS class 8 Link (GMSK)		Relative Humidity :	46~48%					
Test Engineer :	Nick Yu, Dereck Chen, and Ken Wu		Polarization :	Horizontal					
Remark :	Spurious emissions within 30-1000MHz were found more than 20dB below limit line.								
Frequency (MHz)	EIRP (dBm)	Limit (dBm)	Over Limit (dB)	SPA Reading (dBm)	S.G. Power (dBm)	TX Cable loss (dB)	TX Antenna Gain (dBi)	Polarization (H/V)	Result
3763	-49.39	-13	-36.39	-67.08	-56.02	1.69	8.32	H	Pass
5640	-44.80	-13	-31.80	-67.36	-51.85	2.71	9.76	H	Pass
7520	-38.92	-13	-25.92	-68.16	-48.31	2.42	11.81	H	Pass

Band :	GSM1900		Temperature :	23~24°C					
Test Mode :	GPRS class 8 Link (GMSK)		Relative Humidity :	46~48%					
Test Engineer :	Nick Yu, Dereck Chen, and Ken Wu		Polarization :	Vertical					
Remark :	Spurious emissions within 30-1000MHz were found more than 20dB below limit line.								
Frequency (MHz)	EIRP (dBm)	Limit (dBm)	Over Limit (dB)	SPA Reading (dBm)	S.G. Power (dBm)	TX Cable loss (dB)	TX Antenna Gain (dBi)	Polarization (H/V)	Result
3763	-49.06	-13	-36.06	-67.77	-55.69	1.69	8.32	V	Pass
5640	-43.20	-13	-30.20	-65.84	-50.25	2.71	9.76	V	Pass
7520	-38.74	-13	-25.74	-67.97	-48.13	2.42	11.81	V	Pass



<High Channel>

Band :	GSM1900		Temperature :	23~24°C					
Test Mode :	GPRS class 8 Link (GMSK)		Relative Humidity :	46~48%					
Test Engineer :	Nick Yu, Dereck Chen, and Ken Wu		Polarization :	Horizontal					
Remark :	Spurious emissions within 30-1000MHz were found more than 20dB below limit line.								
Frequency (MHz)	EIRP (dBm)	Limit (dBm)	Over Limit (dB)	SPA Reading (dBm)	S.G. Power (dBm)	TX Cable loss (dB)	TX Antenna Gain (dBi)	Polarization (H/V)	Result
3819	-49.42	-13	-36.42	-67.63	-56.1	1.70	8.38	H	Pass
5729	-42.97	-13	-29.97	-69.21	-50	2.76	9.79	H	Pass
7639	-39.60	-13	-26.60	-68.78	-49.1	2.38	11.88	H	Pass

Band :	GSM1900		Temperature :	23~24°C					
Test Mode :	GPRS class 8 Link (GMSK)		Relative Humidity :	46~48%					
Test Engineer :	Nick Yu, Dereck Chen, and Ken Wu		Polarization :	Vertical					
Remark :	Spurious emissions within 30-1000MHz were found more than 20dB below limit line.								
Frequency (MHz)	EIRP (dBm)	Limit (dBm)	Over Limit (dB)	SPA Reading (dBm)	S.G. Power (dBm)	TX Cable loss (dB)	TX Antenna Gain (dBi)	Polarization (H/V)	Result
3819	-49.22	-13	-36.22	-68.57	-55.9	1.70	8.38	V	Pass
5729	-45.47	-13	-32.47	-68.85	-52.5	2.76	9.79	V	Pass
7639	-40.70	-13	-27.70	-69.19	-50.2	2.38	11.88	V	Pass



<Low Channel>

Band :	GSM1900		Temperature :	23~24°C					
Test Mode :	EDGE class 8 Link (8PSK)		Relative Humidity :	46~48%					
Test Engineer :	Nick Yu, Dereck Chen, and Ken Wu		Polarization :	Horizontal					
Remark :	Spurious emissions within 30-1000MHz were found more than 20dB below limit line.								
Frequency (MHz)	EIRP (dBm)	Limit (dBm)	Over Limit (dB)	SPA Reading (dBm)	S.G. Power (dBm)	TX Cable loss (dB)	TX Antenna Gain (dBi)	Polarization (H/V)	Result
3700	-51.33	-13	-38.33	-69.31	-57.9	1.67	8.24	H	Pass
5551	-45.43	-13	-32.43	-68.42	-52.5	2.65	9.72	H	Pass
7401	-39.16	-13	-26.16	-68.87	-48.3	2.46	11.60	H	Pass

Band :	GSM1900		Temperature :	23~24°C					
Test Mode :	EDGE class 8 Link (8PSK)		Relative Humidity :	46~48%					
Test Engineer :	Nick Yu, Dereck Chen, and Ken Wu		Polarization :	Vertical					
Remark :	Spurious emissions within 30-1000MHz were found more than 20dB below limit line.								
Frequency (MHz)	EIRP (dBm)	Limit (dBm)	Over Limit (dB)	SPA Reading (dBm)	S.G. Power (dBm)	TX Cable loss (dB)	TX Antenna Gain (dBi)	Polarization (H/V)	Result
3700	-50.03	-13	-37.03	-68.93	-56.6	1.67	8.24	V	Pass
5551	-46.03	-13	-33.03	-68.62	-53.1	2.65	9.72	V	Pass
7401	-39.46	-13	-26.46	-68.58	-48.6	2.46	11.60	V	Pass



<Middle Channel>

Band :	GSM1900		Temperature :	23~24°C					
Test Mode :	EDGE class 8 Link (8PSK)		Relative Humidity :	46~48%					
Test Engineer :	Nick Yu, Dereck Chen, and Ken Wu		Polarization :	Horizontal					
Remark :	Spurious emissions within 30-1000MHz were found more than 20dB below limit line.								
Frequency (MHz)	EIRP (dBm)	Limit (dBm)	Over Limit (dB)	SPA Reading (dBm)	S.G. Power (dBm)	TX Cable loss (dB)	TX Antenna Gain (dBi)	Polarization (H/V)	Result
3760	-50.57	-13	-37.57	-68.49	-57.2	1.69	8.31	H	Pass
5639	-41.15	-13	-28.15	-64.82	-48.2	2.71	9.76	H	Pass
7520	-38.21	-13	-25.21	-68.34	-47.6	2.42	11.81	H	Pass

Band :	GSM1900		Temperature :	23~24°C					
Test Mode :	EDGE class 8 Link (8PSK)		Relative Humidity :	46~48%					
Test Engineer :	Nick Yu, Dereck Chen, and Ken Wu		Polarization :	Vertical					
Remark :	Spurious emissions within 30-1000MHz were found more than 20dB below limit line.								
Frequency (MHz)	EIRP (dBm)	Limit (dBm)	Over Limit (dB)	SPA Reading (dBm)	S.G. Power (dBm)	TX Cable loss (dB)	TX Antenna Gain (dBi)	Polarization (H/V)	Result
3760	-50.27	-13	-37.27	-69.26	-56.9	1.69	8.31	V	Pass
5639	-44.45	-13	-31.45	-67.76	-51.5	2.71	9.76	V	Pass
7520	-39.71	-13	-26.71	-69.42	-49.1	2.42	11.81	V	Pass



<High Channel>

Band :	GSM1900		Temperature :	23~24°C					
Test Mode :	EDGE class 8 Link (8PSK)		Relative Humidity :	46~48%					
Test Engineer :	Nick Yu, Dereck Chen, and Ken Wu		Polarization :	Horizontal					
Remark :	Spurious emissions within 30-1000MHz were found more than 20dB below limit line.								
Frequency (MHz)	EIRP (dBm)	Limit (dBm)	Over Limit (dB)	SPA Reading (dBm)	S.G. Power (dBm)	TX Cable loss (dB)	TX Antenna Gain (dBi)	Polarization (H/V)	Result
3819	-50.12	-13	-37.12	-68.42	-56.8	1.70	8.38	H	Pass
5729	-45.47	-13	-32.47	-68.7	-52.5	2.76	9.79	H	Pass
7639	-39.00	-13	-26.00	-67.99	-48.5	2.38	11.88	H	Pass

Band :	GSM1900		Temperature :	23~24°C					
Test Mode :	EDGE class 8 Link (8PSK)		Relative Humidity :	46~48%					
Test Engineer :	Nick Yu, Dereck Chen, and Ken Wu		Polarization :	Vertical					
Remark :	Spurious emissions within 30-1000MHz were found more than 20dB below limit line.								
Frequency (MHz)	EIRP (dBm)	Limit (dBm)	Over Limit (dB)	SPA Reading (dBm)	S.G. Power (dBm)	TX Cable loss (dB)	TX Antenna Gain (dBi)	Polarization (H/V)	Result
3819	-48.42	-13	-35.42	-67.44	-55.1	1.70	8.38	V	Pass
5729	-46.57	-13	-33.57	-69.49	-53.6	2.76	9.79	V	Pass
7639	-39.00	-13	-26.00	-67.66	-48.5	2.38	11.88	V	Pass



<Low Channel>

Band :	WCDMA Band V	Temperature :	23~24°C						
Test Mode :	RMC 12.2Kbps Link (QPSK)	Relative Humidity :	46~48%						
Test Engineer :	Nick Yu, Dereck Chen, and Ken Wu	Polarization :	Horizontal						
Remark :	Spurious emissions within 30-1000MHz were found more than 20dB below limit line.								
Frequency (MHz)	ERP (dBm)	Limit (dBm)	Over Limit (dB)	SPA Reading (dBm)	S.G. Power (dBm)	TX Cable loss (dB)	TX Antenna Gain (dBi)	Polarization (H/V)	Result
1656	-54.02	-13	-41.02	-64.67	-55.75	0.98	4.86	H	Pass
2480	-49.01	-13	-36.01	-64.52	-50.92	1.28	5.34	H	Pass
3304	-47.35	-13	-34.35	-63.32	-50.79	1.54	7.14	H	Pass

Band :	WCDMA Band V	Temperature :	23~24°C						
Test Mode :	RMC 12.2Kbps Link (QPSK)	Relative Humidity :	46~48%						
Test Engineer :	Nick Yu, Dereck Chen, and Ken Wu	Polarization :	Vertical						
Remark :	Spurious emissions within 30-1000MHz were found more than 20dB below limit line.								
Frequency (MHz)	ERP (dBm)	Limit (dBm)	Over Limit (dB)	SPA Reading (dBm)	S.G. Power (dBm)	TX Cable loss (dB)	TX Antenna Gain (dBi)	Polarization (H/V)	Result
1656	-51.04	-13	-38.04	-64.32	-52.77	0.98	4.86	V	Pass
2480	-49.67	-13	-36.67	-65.29	-51.58	1.28	5.34	V	Pass
3304	-48.35	-13	-35.35	-65.62	-51.79	1.54	7.14	V	Pass



<Middle Channel>

Band :	WCDMA Band V	Temperature :	23~24°C						
Test Mode :	RMC 12.2Kbps Link (QPSK)	Relative Humidity :	46~48%						
Test Engineer :	Nick Yu, Dereck Chen, and Ken Wu	Polarization :	Horizontal						
Remark :	Spurious emissions within 30-1000MHz were found more than 20dB below limit line.								
Frequency (MHz)	ERP (dBm)	Limit (dBm)	Over Limit (dB)	SPA Reading (dBm)	S.G. Power (dBm)	TX Cable loss (dB)	TX Antenna Gain (dBi)	Polarization (H/V)	Result
1672	-52.91	-13	-39.91	-63.66	-54.59	0.99	4.82	H	Pass
2512	-49.51	-13	-36.51	-64.89	-51.48	1.29	5.41	H	Pass
3344	-44.92	-13	-31.92	-61.13	-48.53	1.56	7.31	H	Pass

Band :	WCDMA Band V	Temperature :	23~24°C						
Test Mode :	RMC 12.2Kbps Link (QPSK)	Relative Humidity :	46~48%						
Test Engineer :	Nick Yu, Dereck Chen, and Ken Wu	Polarization :	Vertical						
Remark :	Spurious emissions within 30-1000MHz were found more than 20dB below limit line.								
Frequency (MHz)	ERP (dBm)	Limit (dBm)	Over Limit (dB)	SPA Reading (dBm)	S.G. Power (dBm)	TX Cable loss (dB)	TX Antenna Gain (dBi)	Polarization (H/V)	Result
1672	-51.80	-13	-38.80	-64.92	-53.48	0.99	4.82	V	Pass
2512	-49.54	-13	-36.54	-65.09	-51.51	1.29	5.41	V	Pass
3344	-47.24	-13	-34.24	-64.85	-50.85	1.56	7.31	V	Pass



<High Channel>

Band :	WCDMA Band V	Temperature :	23~24°C						
Test Mode :	RMC 12.2Kbps Link (QPSK)	Relative Humidity :	46~48%						
Test Engineer :	Nick Yu, Dereck Chen, and Ken Wu	Polarization :	Horizontal						
Remark :	Spurious emissions within 30-1000MHz were found more than 20dB below limit line.								
Frequency (MHz)	ERP (dBm)	Limit (dBm)	Over Limit (dB)	SPA Reading (dBm)	S.G. Power (dBm)	TX Cable loss (dB)	TX Antenna Gain (dBi)	Polarization (H/V)	Result
1696	-46.94	-13	-33.94	-57.72	-48.54	1.00	4.75	H	Pass
2512	-49.82	-13	-36.82	-65.16	-51.79	1.29	5.41	H	Pass
3344	-50.20	-13	-37.20	-66.3	-53.81	1.56	7.31	H	Pass

Band :	WCDMA Band V	Temperature :	23~24°C						
Test Mode :	RMC 12.2Kbps Link (QPSK)	Relative Humidity :	46~48%						
Test Engineer :	Nick Yu, Dereck Chen, and Ken Wu	Polarization :	Vertical						
Remark :	Spurious emissions within 30-1000MHz were found more than 20dB below limit line.								
Frequency (MHz)	ERP (dBm)	Limit (dBm)	Over Limit (dB)	SPA Reading (dBm)	S.G. Power (dBm)	TX Cable loss (dB)	TX Antenna Gain (dBi)	Polarization (H/V)	Result
1696	-51.19	-13	-38.19	-64.27	-52.79	1.00	4.75	V	Pass
2512	-49.46	-13	-36.46	-65.2	-51.43	1.29	5.41	V	Pass
3344	-48.90	-13	-35.90	-66.62	-52.51	1.56	7.31	V	Pass



<Low Channel>

Band :	WCDMA Band IV		Temperature :	23~24°C					
Test Mode :	RMC 12.2Kbps Link (QPSK)		Relative Humidity :	46~48%					
Test Engineer :	Nick Yu, Dereck Chen, and Ken Wu		Polarization :	Horizontal					
Remark :	Spurious emissions within 30-1000MHz were found more than 20dB below limit line.								
Frequency (MHz)	EIRP (dBm)	Limit (dBm)	Over Limit (dB)	SPA Reading (dBm)	S.G. Power (dBm)	TX Cable loss (dB)	TX Antenna Gain (dBi)	Polarization (H/V)	Result
3427	-50.49	-13	-37.49	-66.76	-56.59	1.58	7.68	H	Pass
5137	-46.41	-13	-33.41	-66.83	-53.69	2.42	9.70	H	Pass
6849	-39.00	-13	-26.00	-67.03	-46.98	2.64	10.62	H	Pass

Band :	WCDMA Band IV		Temperature :	23~24°C					
Test Mode :	RMC 12.2Kbps Link (QPSK)		Relative Humidity :	46~48%					
Test Engineer :	Nick Yu, Dereck Chen, and Ken Wu		Polarization :	Vertical					
Remark :	Spurious emissions within 30-1000MHz were found more than 20dB below limit line.								
Frequency (MHz)	EIRP (dBm)	Limit (dBm)	Over Limit (dB)	SPA Reading (dBm)	S.G. Power (dBm)	TX Cable loss (dB)	TX Antenna Gain (dBi)	Polarization (H/V)	Result
3427	-48.92	-13	-35.92	-66.96	-55.02	1.58	7.68	V	Pass
5137	-47.41	-13	-34.41	-67.72	-54.69	2.42	9.70	V	Pass
6849	-38.86	-13	-25.86	-66.33	-46.84	2.64	10.62	V	Pass



<Middle Channel>

Band :	WCDMA Band IV	Temperature :	23~24°C						
Test Mode :	RMC 12.2Kbps Link (QPSK)	Relative Humidity :	46~48%						
Test Engineer :	Nick Yu, Dereck Chen, and Ken Wu	Polarization :	Horizontal						
Remark :	Spurious emissions within 30-1000MHz were found more than 20dB below limit line.								
Frequency (MHz)	EIRP (dBm)	Limit (dBm)	Over Limit (dB)	SPA Reading (dBm)	S.G. Power (dBm)	TX Cable loss (dB)	TX Antenna Gain (dBi)	Polarization (H/V)	Result
3462	-50.98	-13	-37.98	-66.83	-57.22	1.59	7.83	H	Pass
5197	-46.00	-13	-33.00	-66.61	-53.25	2.45	9.70	H	Pass
6930	-39.14	-13	-26.14	-66.9	-47.24	2.61	10.72	H	Pass

Band :	WCDMA Band IV	Temperature :	23~24°C						
Test Mode :	RMC 12.2Kbps Link (QPSK)	Relative Humidity :	46~48%						
Test Engineer :	Nick Yu, Dereck Chen, and Ken Wu	Polarization :	Vertical						
Remark :	Spurious emissions within 30-1000MHz were found more than 20dB below limit line.								
Frequency (MHz)	EIRP (dBm)	Limit (dBm)	Over Limit (dB)	SPA Reading (dBm)	S.G. Power (dBm)	TX Cable loss (dB)	TX Antenna Gain (dBi)	Polarization (H/V)	Result
3462	-49.77	-13	-36.77	-67.04	-56.01	1.59	7.83	V	Pass
5197	-45.71	-13	-32.71	-67.02	-52.96	2.45	9.70	V	Pass
6930	-40.88	-13	-27.88	-67.87	-48.98	2.61	10.72	V	Pass



<High Channel>

Band :	WCDMA Band IV		Temperature :	23~24°C					
Test Mode :	RMC 12.2Kbps Link (QPSK)		Relative Humidity :	46~48%					
Test Engineer :	Nick Yu, Dereck Chen, and Ken Wu		Polarization :	Horizontal					
Remark :	Spurious emissions within 30-1000MHz were found more than 20dB below limit line.								
Frequency (MHz)	EIRP (dBm)	Limit (dBm)	Over Limit (dB)	SPA Reading (dBm)	S.G. Power (dBm)	TX Cable loss (dB)	TX Antenna Gain (dBi)	Polarization (H/V)	Result
3504	-50.81	-13	-37.81	-67.04	-57.21	1.61	8.00	H	Pass
5257	-46.60	-13	-33.60	-67.39	-53.81	2.49	9.70	H	Pass
7010	-39.16	-13	-26.16	-67.99	-47.39	2.59	10.82	H	Pass

Band :	WCDMA Band IV		Temperature :	23~24°C					
Test Mode :	RMC 12.2Kbps Link (QPSK)		Relative Humidity :	46~48%					
Test Engineer :	Nick Yu, Dereck Chen, and Ken Wu		Polarization :	Vertical					
Remark :	Spurious emissions within 30-1000MHz were found more than 20dB below limit line.								
Frequency (MHz)	EIRP (dBm)	Limit (dBm)	Over Limit (dB)	SPA Reading (dBm)	S.G. Power (dBm)	TX Cable loss (dB)	TX Antenna Gain (dBi)	Polarization (H/V)	Result
3504	-48.82	-13	-35.82	-66.43	-55.22	1.61	8.00	V	Pass
5257	-46.40	-13	-33.40	-67.31	-53.61	2.49	9.70	V	Pass
7010	-39.58	-13	-26.58	-66.96	-47.81	2.59	10.82	V	Pass



<Low Channel>

Band :	WCDMA Band II	Temperature :	23~24°C						
Test Mode :	RMC 12.2Kbps Link (QPSK)	Relative Humidity :	46~48%						
Test Engineer :	Nick Yu, Dereck Chen, and Ken Wu	Polarization :	Horizontal						
Remark :	Spurious emissions within 30-1000MHz were found more than 20dB below limit line.								
Frequency (MHz)	EIRP (dBm)	Limit (dBm)	Over Limit (dB)	SPA Reading (dBm)	S.G. Power (dBm)	TX Cable loss (dB)	TX Antenna Gain (dB)	Polarization (H/V)	Result
3707	-47.22	-13	-34.22	-65.06	-53.8	1.67	8.25	H	Pass
5557	-45.04	-13	-32.04	-67.75	-52.1	2.66	9.72	H	Pass
7410	-38.64	-13	-25.64	-68.41	-47.8	2.46	11.62	H	Pass

Band :	WCDMA Band II	Temperature :	23~24°C						
Test Mode :	RMC 12.2Kbps Link (QPSK)	Relative Humidity :	46~48%						
Test Engineer :	Nick Yu, Dereck Chen, and Ken Wu	Polarization :	Vertical						
Remark :	Spurious emissions within 30-1000MHz were found more than 20dB below limit line.								
Frequency (MHz)	EIRP (dBm)	Limit (dBm)	Over Limit (dB)	SPA Reading (dBm)	S.G. Power (dBm)	TX Cable loss (dB)	TX Antenna Gain (dB)	Polarization (H/V)	Result
3707	-47.32	-13	-34.32	-66.18	-53.9	1.67	8.25	V	Pass
5557	-44.74	-13	-31.74	-67.38	-51.8	2.66	9.72	V	Pass
7410	-39.14	-13	-26.14	-68.41	-48.3	2.46	11.62	V	Pass



<Middle Channel>

Band :	WCDMA Band II	Temperature :	23~24°C						
Test Mode :	RMC 12.2Kbps Link (QPSK)	Relative Humidity :	46~48%						
Test Engineer :	Nick Yu, Dereck Chen, and Ken Wu	Polarization :	Horizontal						
Remark :	Spurious emissions within 30-1000MHz were found more than 20dB below limit line.								
Frequency (MHz)	EIRP (dBm)	Limit (dBm)	Over Limit (dB)	SPA Reading (dBm)	S.G. Power (dBm)	TX Cable loss (dB)	TX Antenna Gain (dBi)	Polarization (H/V)	Result
3756	-47.48	-13	-34.48	-65.43	-54.1	1.68	8.31	H	Pass
5640	-44.25	-13	-31.25	-67.28	-51.3	2.71	9.76	H	Pass
7520	-39.21	-13	-26.21	-68.85	-48.6	2.42	11.81	H	Pass

Band :	WCDMA Band II	Temperature :	23~24°C						
Test Mode :	RMC 12.2Kbps Link (QPSK)	Relative Humidity :	46~48%						
Test Engineer :	Nick Yu, Dereck Chen, and Ken Wu	Polarization :	Vertical						
Remark :	Spurious emissions within 30-1000MHz were found more than 20dB below limit line.								
Frequency (MHz)	EIRP (dBm)	Limit (dBm)	Over Limit (dB)	SPA Reading (dBm)	S.G. Power (dBm)	TX Cable loss (dB)	TX Antenna Gain (dBi)	Polarization (H/V)	Result
3756	-46.78	-13	-33.78	-65.51	-53.4	1.68	8.31	V	Pass
5639	-43.55	-13	-30.55	-66.66	-50.6	2.71	9.76	V	Pass
7520	-39.71	-13	-26.71	-69.14	-49.1	2.42	11.81	V	Pass



<High Channel>

Band :	WCDMA Band II	Temperature :	23~24°C						
Test Mode :	RMC 12.2Kbps Link (QPSK)	Relative Humidity :	46~48%						
Test Engineer :	Nick Yu, Dereck Chen, and Ken Wu	Polarization :	Horizontal						
Remark :	Spurious emissions within 30-1000MHz were found more than 20dB below limit line.								
Frequency (MHz)	EIRP (dBm)	Limit (dBm)	Over Limit (dB)	SPA Reading (dBm)	S.G. Power (dBm)	TX Cable loss (dB)	TX Antenna Gain (dB)	Polarization (H/V)	Result
3812	-47.53	-13	-34.53	-65.78	-54.2	1.70	8.37	H	Pass
5723	-45.16	-13	-32.16	-68.68	-52.2	2.75	9.79	H	Pass
7630	-39.11	-13	-26.11	-68.05	-48.6	2.39	11.88	H	Pass

Band :	WCDMA Band II	Temperature :	23~24°C						
Test Mode :	RMC 12.2Kbps Link (QPSK)	Relative Humidity :	46~48%						
Test Engineer :	Nick Yu, Dereck Chen, and Ken Wu	Polarization :	Vertical						
Remark :	Spurious emissions within 30-1000MHz were found more than 20dB below limit line.								
Frequency (MHz)	EIRP (dBm)	Limit (dBm)	Over Limit (dB)	SPA Reading (dBm)	S.G. Power (dBm)	TX Cable loss (dB)	TX Antenna Gain (dB)	Polarization (H/V)	Result
3812	-47.53	-13	-34.53	-66.31	-54.2	1.70	8.37	V	Pass
5723	-44.06	-13	-31.06	-67.3	-51.1	2.75	9.79	V	Pass
7630	-40.61	-13	-27.61	-69.27	-50.1	2.39	11.88	V	Pass



3.8 Frequency Stability Measurement

3.8.1 Description of Frequency Stability Measurement

The frequency stability shall be measured by variation of ambient temperature and variation of primary supply voltage to ensure that the fundamental emission stays within the authorized frequency block. The frequency stability of the transmitter shall be maintained within $\pm 0.00025\%$ ($\pm 2.5\text{ppm}$) of the center frequency.

3.8.2 Measuring Instruments

The measuring equipment is listed in the section 4 of this test report.

3.8.3 Test Procedures for Temperature Variation

1. The testing follows FCC KDB 971168 v02r02 Section 9.0.
2. The EUT was set up in the thermal chamber and connected with the system simulator.
3. With power OFF, the temperature was decreased to -30°C and the EUT was stabilized before testing. Power was applied and the maximum change in frequency was recorded within one minute.
4. With power OFF, the temperature was raised in 10°C steps up to 50°C . The EUT was stabilized at each step for at least half an hour. Power was applied and the maximum frequency change was recorded within one minute.

3.8.4 Test Procedures for Voltage Variation

1. The testing follows FCC KDB 971168 v02r02 Section 9.0.
2. The EUT was placed in a temperature chamber at $25\pm 5^{\circ}\text{C}$ and connected with the system simulator.
3. The power supply voltage to the EUT was varied from BEP to 115% of the nominal value measured at the input to the EUT.
4. The variation in frequency was measured for the worst case.

3.8.5 Test Setup

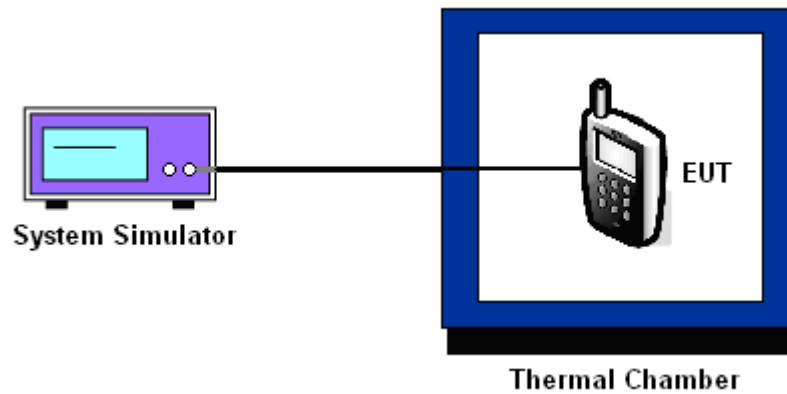

3.8.6 Test Result of Temperature Variation

Band :	GSM 850	Channel :	189
Limit (ppm) :	2.5	Frequency :	836.4 MHz

Temperature (°C)	GPRS class 8	EDGE class 8	Result
	Deviation (ppm)	Deviation (ppm)	
50	0.0024	0.0012	PASS
40	0.0012	0.0012	
30	0.0012	0.0012	
20(Ref.)	0.0000	0.0000	
10	0.0060	0.0036	
0	0.0048	0.0048	
-10	0.0036	0.0060	
-20	0.0072	0.0072	
-30	0.0024	0.0048	



Band :	GSM 1900	Channel :	661
Limit (ppm) :	within authorized band	Frequency :	1880.0 MHz

Temperature (°C)	GPRS class 8	EDGE class 8	Result
	Deviation (ppm)	Deviation (ppm)	
50	0.0005	0.0005	PASS
40	0.0027	0.0011	
30	0.0011	0.0005	
20(Ref.)	0.0000	0.0000	
10	0.0005	0.0021	
0	0.0016	0.0037	
-10	0.0032	0.0048	
-20	0.0011	0.0027	
-30	0.0021	0.0043	

Note: The frequency fundamental emissions stay within the authorized frequency block based on the frequency deviation measured is small.

Band :	WCDMA Band V	Channel :	4182
Limit (ppm) :	2.5	Frequency :	836.4 MHz

Temperature (°C)	RMC 12.2Kbps	Result
	Deviation (ppm)	
50	0.0036	PASS
40	0.0012	
30	0.0060	
20(Ref.)	0.0000	
10	0.0024	
0	0.0024	
-10	0.0012	
-20	0.0084	
-30	0.0036	



Band :	WCDMA Band IV	Channel :	1413
Limit (ppm) :	within authorized band	Frequency :	1732.6 MHz

Temperature (°C)	RMC 12.2Kbps	Result
	Deviation (ppm)	
50	0.0012	PASS
40	0.0006	
30	0.0017	
20(Ref.)	0.0000	
10	0.0202	
0	0.0219	
-10	0.0231	
-20	0.0237	
-30	0.0225	

Note: The frequency fundamental emissions stay within the authorized frequency block based on the frequency deviation measured is small.

Band :	WCDMA Band II	Channel :	9400
Limit (ppm) :	within authorized band	Frequency :	1880.0 MHz

Temperature (°C)	RMC 12.2Kbps	Result
	Deviation (ppm)	
50	0.0000	PASS
40	0.0016	
30	0.0005	
20(Ref.)	0.0000	
10	0.0016	
0	0.0005	
-10	0.0016	
-20	0.0000	
-30	0.0011	

Note: The frequency fundamental emissions stay within the authorized frequency block based on the frequency deviation measured is small.



3.8.7 Test Result of Voltage Variation

Band & Channel	Mode	Voltage (Volt)	Freq. Dev. (Hz)	Deviation (ppm)	Limit (ppm)	Result
GSM 850 CH189	GPRS class 8	4.20	0.0084	4.20	2.5	PASS
		3.80	0.0060	3.80		
		BEP	0.0048	BEP		
	EDGE class 8	4.20	0.0048	4.20		
		3.80	0.0084	3.80		
		BEP	0.0060	BEP		
GSM 1900 CH661	GPRS class 8	4.20	0.0005	4.20	(Note 3.)	
		3.80	0.0005	3.80		
		BEP	0.0000	BEP		
	EDGE class 8	4.20	0.0027	4.20		
		3.80	0.0027	3.80		
		BEP	0.0016	BEP		
WCDMA Band V CH4182	RMC 12.2Kbps	4.20	0.0012	4.20	2.5	
		3.80	0.0108	3.80		
		BEP	0.0096	BEP		
WCDMA Band IV CH1413	RMC 12.2Kbps	4.20	0.0237	4.20	(Note 3.)	
		3.80	0.0214	3.80		
		BEP	0.0231	BEP		
WCDMA Band II CH9400	RMC 12.2Kbps	4.20	0.0005	4.20	(Note 3.)	
		3.80	0.0011	3.80		
		BEP	0.0005	BEP		

Note:

1. Normal Voltage = 3.80V.
2. Battery End Point (BEP) = 3.40 V.
3. The frequency fundamental emissions stay within the authorized frequency block based on the frequency deviation measured is small.



4 List of Measuring Equipment

Instrument	Manufacturer	Model No.	Serial No.	Characteristics	Calibration Date	Test Date	Due Date	Remark
System Simulator	Rohde & Schwarz	CMU200	117995	N/A	Jul. 29, 2014	Dec. 02, 2014 ~ Dec. 04, 2014	Jul. 28, 2015	Conducted (TH02-HY)
Spectrum Analyzer	Rohde & Schwarz	FSP40	100055	9kHz~40GHz	Jun. 09, 2014	Dec. 02, 2014 ~ Dec. 04, 2014	Jun. 08, 2015	Conducted (TH02-HY)
Thermal Chamber	Ten Billion	TTH-D3SP	TBN-930701	N/A	Jul. 17, 2014	Dec. 02, 2014 ~ Dec. 04, 2014	Jul. 16, 2015	Conducted (TH02-HY)
Spectrum Analyzer	Rohde & Schwarz	FSV30	101749	10Hz ~ 30GHz	Feb. 10, 2014	Nov. 21, 2014 ~ Dec. 16, 2014	Feb. 09, 2015	Radiation (03CH07-HY)
Bilog Antenna	Schaffner	CBL6111C	2726	30MHz ~ 1GHz	Sep. 27, 2014	Nov. 21, 2014 ~ Dec. 16, 2014	Sep. 26, 2015	Radiation (03CH07-HY)
Double Ridge Horn Antenna	ESCO	3117	75962	1GHz~18GHz	Aug. 19, 2014	Nov. 21, 2014 ~ Dec. 16, 2014	Aug. 18, 2015	Radiation (03CH07-HY)
Preamplifier	COM-POWER	PA-103A	161241	10 MHz ~ 1000MHz	Mar. 17, 2014	Nov. 21, 2014 ~ Dec. 16, 2014	Mar. 16, 2015	Radiation (03CH07-HY)
Preamplifier	Agilent	8449B	3008A02362	1 GHz~26.5 GHz	Oct. 21, 2014	Nov. 21, 2014 ~ Dec. 16, 2014	Oct. 20, 2015	Radiation (03CH07-HY)
Turn Table	ChainTek	ChainTek 3000	N/A	0 ~ 360 degree	N/A	Nov. 21, 2014 ~ Dec. 16, 2014	N/A	Radiation (03CH07-HY)
Antenna Mast	ChainTek	M-400-0	114/8000604/L	N/A	N/A	Nov. 21, 2014 ~ Dec. 16, 2014	N/A	Radiation (03CH07-HY)
SHF-EHF Horn Antenna	SCHWARZBECK	BBHA 9170	BBHA9170251	18GHz~40GHz	Oct. 02, 2014	Nov. 21, 2014 ~ Dec. 16, 2014	Oct. 01, 2015	Radiation (03CH07-HY)
Signal Generator	Rohde & Schwarz	SMF100A	101107	100kHz~40GHz	May 23, 2014	Nov. 21, 2014 ~ Dec. 16, 2014	May 22, 2015	Radiation (03CH07-HY)
Double Ridge Horn Antenna	ESCO	3117	00066583	1GHz~18GHz	Jul. 24, 2014	Nov. 21, 2014 ~ Dec. 16, 2014	Jul. 23, 2015	Radiation (03CH07-HY)



5 Uncertainty of Evaluation

Uncertainty of Radiated Emission Measurement (30 MHz ~ 1000 MHz)

Measuring Uncertainty for a Level of Confidence of 95% ($U = 2Uc(y)$)	4.50
---	------