



FCC RF Test Report

APPLICANT : Motorola Mobility, LLC
EQUIPMENT : Mobile Cellular Phone
BRAND NAME : Motorola
MODEL NAME : 4242
FCC ID : IHDT56QC7
STANDARD : FCC Part 15 Subpart C §15.247
CLASSIFICATION : (DTS) Digital Transmission System

The product was received on Nov. 15, 2014. We, SPORTON INTERNATIONAL INC., would like to declare that the tested sample has been evaluated in accordance with the test procedures and has been in compliance with the applicable technical standards.

The test results in this report apply exclusively to the tested model / sample. Without written approval of SPORTON INTERNATIONAL INC., the test report shall not be reproduced except in full.

Reviewed by: Joseph Lin / Supervisor

Approved by: Jones Tsai / Manager



SPORTON INTERNATIONAL INC.

No. 52, Hwa Ya 1st Rd., Hwa Ya Technology Park, Kwei-Shan Hsiang, Tao Yuan Hsien, Taiwan, R.O.C.

SPORTON INTERNATIONAL INC.
TEL : 886-3-327-3456
FAX : 886-3-328-4978
FCC ID : IHDT56QC7

Page Number : 1 of 4
Report Issued Date : Jan. 08, 2015
Report Version : Rev. 01



TABLE OF CONTENTS

REVISION HISTORY..... 3

1 GENERAL DESCRIPTION 4

 1.1 Applicant 4

 1.2 Manufacturer..... 4

 1.3 Product Feature of Equipment Under Test..... 4

 1.4 Product Specification subjective to this standard 4

 1.5 Modification of EUT 4

APPENDIX A. ORIGINAL REPORT



1 General Description

1.1 Applicant

Motorola Mobility, LLC
222 W. Merchandise Mart Plaza, Chicago IL 60654 USA

1.2 Manufacturer

Motorola Mobility, LLC
222 W. Merchandise Mart Plaza, Chicago IL 60654 USA

1.3 Product Feature of Equipment Under Test

Product Feature	
Equipment	Mobile Cellular Phone
Brand Name	Motorola
Model Name	4242
FCC ID	IHDT56QC7
EUT supports Radios application	CDMA/EV-DO/GSM/EGPRS/WCDMA/HSPA/LTE WLAN 11b/g/n HT20 Bluetooth v2.1 EDR Bluetooth v4.0 LE
HW Version	P2B
EUT Stage	Identical Prototype

Remark: The above EUT's information was declared by manufacturer. Please refer to the specifications or user's manual for more detailed description.

1.4 Product Specification subjective to this standard

Product Specification subjective to this standard	
Tx/Rx Channel Frequency Range	802.11b/g/n : 2412 MHz ~ 2462 MHz
Antenna Type	802.11b/g/n : Fixed Internal Antenna type (The antenna peak gain of EUT is less than 6 dBi)
Type of Modulation	802.11b : DSSS (DBPSK / DQPSK / CCK) 802.11g/n : OFDM (BPSK / QPSK / 16QAM / 64QAM)

1.5 Modification of EUT

No modifications are made to the EUT during all test items.



Appendix A. Original Report

Please refer to Sporton report number FR4N1482-01C as below.



FCC RF Test Report

APPLICANT : Motorola Mobility, LLC
EQUIPMENT : Mobile Cellular Phone
BRAND NAME : Motorola
MODEL NAME : 4060
FCC ID : IHDT56QC4
STANDARD : FCC Part 15 Subpart C §15.247
CLASSIFICATION : (DTS) Digital Transmission System

The product was received on Nov. 14, 2014 and testing was completed on Dec. 01, 2014. We, SPORTON INTERNATIONAL INC., would like to declare that the tested sample has been evaluated in accordance with the test procedures and has been in compliance with the applicable technical standards.

The test results in this report apply exclusively to the tested model / sample. Without written approval of SPORTON INTERNATIONAL INC., the test report shall not be reproduced except in full.

Reviewed by: Joseph Lin / Supervisor

Approved by: Jones Tsai / Manager



SPORTON INTERNATIONAL INC.

No. 52, Hwa Ya 1st Rd., Hwa Ya Technology Park, Kwei-Shan Hsiang, Tao Yuan Hsien, Taiwan, R.O.C.

SPORTON INTERNATIONAL INC.

TEL : 886-3-327-3456

FAX : 886-3-328-4978

FCC ID : IHDT56QC4

Page Number : 1 of 40

Report Issued Date : Jan. 06, 2015

Report Version : Rev. 01

Report Template No.: BU5-FR15CWL Version 1.0



TABLE OF CONTENTS

REVISION HISTORY..... 3

SUMMARY OF TEST RESULT 4

1 GENERAL DESCRIPTION 5

 1.1 Applicant 5

 1.2 Manufacturer 5

 1.3 Product Feature of Equipment Under Test 5

 1.4 Product Specification subjective to this standard 6

 1.5 Modification of EUT 6

 1.6 Testing Location 6

 1.7 Applicable Standards 7

2 TEST CONFIGURATION OF EQUIPMENT UNDER TEST 8

 2.1 Carrier Frequency Channel 8

 2.2 Pre-Scanned RF Power 9

 2.3 Test Mode 11

 2.4 Connection Diagram of Test System 12

 2.5 Support Unit used in test configuration and system 13

 2.6 EUT Operation Test Setup 13

 2.7 Measurement Results Explanation Example 13

3 TEST RESULT 14

 3.1 6dB and 99% Bandwidth Measurement 14

 3.2 Output Power Measurement 16

 3.3 Power Spectral Density Measurement 18

 3.4 Conducted Band Edges and Spurious Emission Measurement 20

 3.5 Radiated Band Edges and Spurious Emission Measurement 30

 3.6 AC Conducted Emission Measurement 34

 3.7 Antenna Requirements 38

4 LIST OF MEASURING EQUIPMENT 39

5 UNCERTAINTY OF EVALUATION 40

APPENDIX A. TEST RESULT OF RADIATED EMISSION



SUMMARY OF TEST RESULT

Report Section	FCC Rule	Description	Limit	Result	Remark
3.1	15.247(a)(2)	6dB Bandwidth	≥ 0.5MHz	Pass	-
3.1	-	99% Bandwidth	-	Pass	-
3.2	15.247(b)	Power Output Measurement	≤ 30dBm	Pass	-
3.3	15.247(e)	Power Spectral Density	≤ 8dBm/3kHz	Pass	-
3.4	15.247(d)	Conducted Band Edges	≤ 20dBc	Pass	-
		Conducted Spurious Emission		Pass	-
3.5	15.247(d)	Radiated Band Edges and Radiated Spurious Emission	15.209(a) & 15.247(d)	Pass	Under limit 1.55 dB at 2389.380 MHz
3.6	15.207	AC Conducted Emission	15.207(a)	Pass	Under limit 16.60 dB at 0.638 MHz
3.7	15.203 & 15.247(b)	Antenna Requirement	N/A	Pass	-



1 General Description

1.1 Applicant

Motorola Mobility, LLC
222 W. Merchandise Mart Plaza, Chicago IL 60654 USA

1.2 Manufacturer

Motorola Mobility, LLC
222 W. Merchandise Mart Plaza, Chicago IL 60654 USA

1.3 Product Feature of Equipment Under Test

Product Feature	
Equipment	Mobile Cellular Phone
Brand Name	Motorola
Model Name	4060
FCC ID	IHDT56QC4
IMEI Code	Conduction: 353339060008021
	Radiation: 353339060007973
EUT supports Radios application	GSM/EGPRS/WCDMA/HSPA WLAN 11b/g/n HT20 Bluetooth v3.0 + EDR Bluetooth v4.0 - LE
HW Version	P2B
EUT Stage	Identical Prototype

Remark: The above EUT's information was declared by manufacturer. Please refer to the specifications or user's manual for more detailed description.

Accessory List	
AC Adapter	Brand Name : Motorola
	Model Name : SPN5816A
Earphone	Brand Name : Motorola
	Model Name : SJYN1181B



1.4 Product Specification subjective to this standard

Product Specification subjective to this standard	
Tx/Rx Channel Frequency Range	2412 MHz ~ 2462 MHz
Maximum Output Power to Antenna	802.11b : 20.77 dBm (0.1194 W) 802.11g : 23.48 dBm (0.2228 W) 802.11n HT20 : 23.60 dBm (0.2291 W)
99% Occupied Bandwidth	802.11b : 13.80MHz 802.11g : 18.75MHz 802.11n HT20 : 19.45MHz
Antenna Type	Fixed Internal Antenna type (The antenna peak gain of EUT is less than 6 dBi)
Type of Modulation	802.11b : DSSS (DBPSK / DQPSK / CCK) 802.11g/n : OFDM (BPSK / QPSK / 16QAM / 64QAM)

1.5 Modification of EUT

No modifications are made to the EUT during all test items.

1.6 Testing Location

Sporton Lab is accredited to ISO 17025 by Taiwan Accreditation Foundation (TAF code : 1190) and the FCC designation No. TW1022 under the FCC 2.948(e) by Mutual Recognition Agreement (MRA) in FCC Test.

Test Site	SPORTON INTERNATIONAL INC.		
Test Site Location	No. 52, Hwa Ya 1 st Rd., Hwa Ya Technology Park, Kwei-Shan Hsiang, Tao Yuan Hsien, Taiwan, R.O.C. TEL: +886-3-327-3456 FAX: +886-3-328-4978		
Test Site No.	Sporton Site No.		
	TH02-HY	CO05-HY	03CH05-HY

Note: The test site complies with ANSI C63.4 2009 requirement.



1.7 Applicable Standards

According to the specifications of the manufacturer, the EUT must comply with the requirements of the following standards:

- ♦ FCC Part 15 Subpart C §15.247
- ♦ FCC KDB Publication No. 558074 D01 DTS Meas. Guidance v03r02
- ♦ ANSI C63.10-2013

Remark:

1. All test items were verified and recorded according to the standards and without any deviation during the test.
2. This EUT has also been tested and complied with the requirements of FCC Part 15, Subpart B, recorded in a separate test report.
3. ANSI C63.10-2013 test method for radiated spurious emission with 1.5m EUT height for frequency above 1GHz is applied.



2 Test Configuration of Equipment Under Test

The EUT has been associated with peripherals and configuration operated in a manner tended to maximize its emission characteristics in a typical application. Frequency range investigated: conducted emission (150 kHz to 30 MHz) and radiated emission (9 kHz to the 10th harmonic of the highest fundamental frequency or to 40 GHz, whichever is lower). For radiated measurement, pre-scanned in three orthogonal panels, X, Y, Z. The worst cases (Y plane) were recorded in this report.

The final configuration from all the combinations and the worst-case data rates were investigated by measuring the maximum power across all the data rates and modulation modes under section 2.2.

Based on the worst configuration found above, the RF power setting is set individually to meet FCC compliance limit for the final conducted and radiated tests shown in section 2.3.

2.1 Carrier Frequency Channel

Frequency Band	Channel	Freq. (MHz)	Channel	Freq. (MHz)
2400-2483.5 MHz	1	2412	7	2442
	2	2417	8	2447
	3	2422	9	2452
	4	2427	10	2457
	5	2432	11	2462
	6	2437	-	-



2.2 Pre-Scanned RF Power

Preliminary tests were performed in different data rate and data rate associated with the highest power were chosen for full test shown in the following tables.

Channel	Frequency	2.4GHz 802.11b RF Power (dBm)			
		DSSS Data Rate			
		1 Mbps	2 Mbps	5.5 Mbps	11 Mbps
CH 01	2412MHz	20.00	19.99	19.98	19.99
CH 06	2437MHz	20.77	20.59	20.36	20.35
CH 11	2462MHz	20.29	20.05	20.07	20.16

Channel	Frequency	2.4GHz 802.11b Average Power (dBm)			
		DSSS Data Rate			
		1 Mbps	2 Mbps	5.5 Mbps	11 Mbps
CH 01	2412MHz	17.73	17.71	17.72	17.66
CH 06	2437MHz	17.98	17.92	17.75	17.67
CH 11	2462MHz	17.60	17.38	17.39	17.42

Channel	Frequency	2.4GHz 802.11g RF Power (dBm)							
		OFDM Data Rate							
		6 Mbps	9 Mbps	12 Mbps	18 Mbps	24 Mbps	36 Mbps	48 Mbps	54 Mbps
CH 01	2412MHz	23.15	23.14	23.13	23.06	22.88	22.89	22.81	22.57
CH 06	2437MHz	23.48	23.39	23.47	23.37	23.26	23.10	23.08	22.58
CH 11	2462MHz	21.51	21.50	21.50	21.49	21.48	21.48	21.49	21.49

Channel	Frequency	2.4GHz 802.11g Average Power (dBm)							
		OFDM Data Rate							
		6 Mbps	9 Mbps	12 Mbps	18 Mbps	24 Mbps	36 Mbps	48 Mbps	54 Mbps
CH 01	2412MHz	15.89	15.67	15.69	15.66	14.68	14.69	14.67	13.69
CH 06	2437MHz	15.97	15.93	15.94	15.95	14.96	14.98	14.94	13.91
CH 11	2462MHz	12.85	12.84	12.84	12.29	12.23	12.25	12.24	12.22



Channel	Frequency	2.4GHz 802.11n HT20 RF Power (dBm)							
		OFDM Data Rate							
		MCS0	MCS1	MCS2	MCS3	MCS4	MCS5	MCS6	MCS7
CH 01	2412MHz	22.32	22.31	22.12	22.13	22.15	22.20	22.24	22.25
CH 06	2437MHz	23.60	23.57	23.22	23.18	23.12	22.81	22.40	21.64
CH 11	2462MHz	21.27	21.26	21.26	20.97	20.99	21.11	21.21	21.23

Channel	Frequency	2.4GHz 802.11n HT20 Average Power (dBm)							
		OFDM Data Rate							
		MCS0	MCS1	MCS2	MCS3	MCS4	MCS5	MCS6	MCS7
CH 01	2412MHz	14.43	14.42	13.78	13.76	13.73	13.72	13.73	13.74
CH 06	2437MHz	16.00	15.99	15.15	15.00	14.99	13.96	12.94	11.86
CH 11	2462MHz	11.89	11.87	11.87	11.32	11.34	11.33	11.32	11.35



2.3 Test Mode

Final results of test modes, data rates and test channels are shown as following table.

Test Cases				
Conducted TCs	Test Items	Mode	Data Rate	Test Channel
	Conducted TCs	6dB and 99% BW Power Spectral Density	802.11b	1 Mbps
802.11g			6 Mbps	1/6/11
802.11n HT20			MCS0	1/6/11
Output Power		802.11b	1 Mbps	1/6/11
		802.11g	6 Mbps	1/6/11
		802.11n HT20	MCS0	1/6/11
Conducted Band Edge		802.11b	1 Mbps	1/11
		802.11g	6 Mbps	1/11
		802.11n HT20	MCS0	1/11
Conducted Spurious Emission	802.11b	1 Mbps	1/6/11	
	802.11g	6 Mbps	1/6/11	
	802.11n HT20	MCS0	1/6/11	
Radiated TCs	Radiated Band Edge	802.11b	1 Mbps	1/6/11
		802.11g	6 Mbps	1/6/11
		802.11n HT20	MCS0	1/6/11
	Radiated Spurious Emission	802.11b	1 Mbps	1/6/11
		802.11g	6 Mbps	1/6/11
		802.11n HT20	MCS0	1/6/11

Test Cases	
AC Conducted Emission	Mode 1 : GSM850 Idle + Bluetooth Link + WLAN Link + MP3 + Earphone + Adapter

2.4 Connection Diagram of Test System

<WLAN Tx Mode>

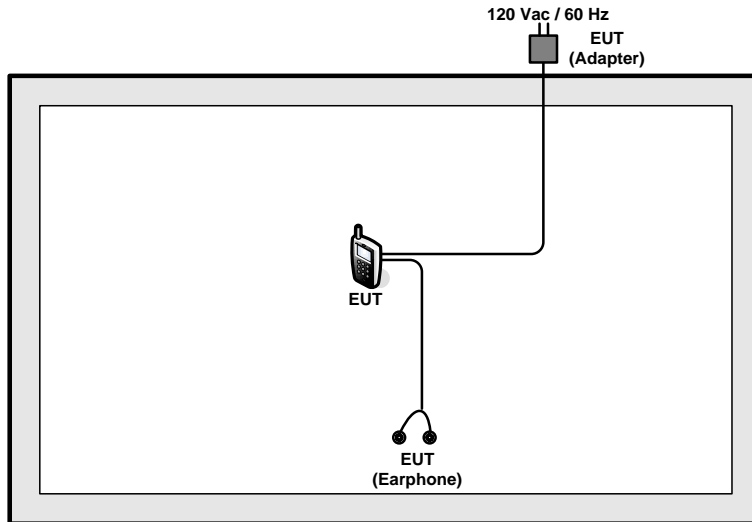

<AC Conducted Emission Mode>

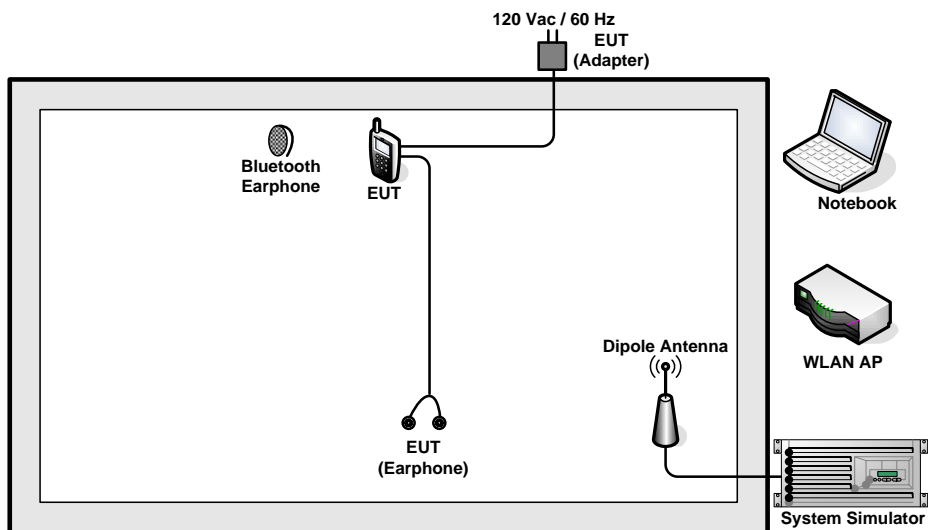



2.5 Support Unit used in test configuration and system

Item	Equipment	Trade Name	Model Name	FCC ID	Data Cable	Power Cord
1.	System Simulator	Anritsu	MT8820C	N/A	N/A	Unshielded, 1.8 m
2.	Bluetooth Earphone	Sony Ericsson	MW600	PY7DDA-2029	N/A	N/A
3.	WLAN AP	D-Link	DIR-865L	KA2IR865LA1	N/A	Unshielded, 1.8 m
4.	Notebook	DELL	Latitude E6320	FCC DoC/ Contains FCC ID: QDS-BRCM1054	N/A	AC I/P: Unshielded, 1.2 m DC O/P: Shielded, 1.8 m
5.	SD Card	SanDisk	MicroSD HC	FCC DoC	N/A	N/A

2.6 EUT Operation Test Setup

For WLAN function, programmed RF utility, "wlan_test_commands.exe" installed in the EUT make the EUT provide functions like channel selection and power level for continuous transmitting and receiving signals.

2.7 Measurement Results Explanation Example

For all conducted test items:

The offset level is set in the spectrum analyzer to compensate the RF cable loss and attenuator factor between EUT conducted output port and spectrum analyzer. With the offset compensation, the spectrum analyzer reading level is exactly the EUT RF output level.

Example :

The spectrum analyzer offset is derived from RF cable loss and attenuator factor.

Offset = RF cable loss + attenuator factor.

Following shows an offset computation example with cable loss 4.2 dB and 10dB attenuator.

$$\begin{aligned} \text{Offset(dB)} &= \text{RF cable loss(dB)} + \text{attenuator factor(dB)}. \\ &= 4.2 + 10 = 14.2 \text{ (dB)} \end{aligned}$$

3 Test Result

3.1 6dB and 99% Bandwidth Measurement

3.1.1 Limit of 6dB and 99% Bandwidth

The minimum 6 dB bandwidth shall be at least 500 kHz.

3.1.2 Measuring Instruments

The measuring equipment is listed in the section 4 of this test report.

3.1.3 Test Procedures

1. The testing follows FCC KDB Publication No. 558074 DTS D01 Meas. Guidance v03r02.
2. The RF output of EUT was connected to the spectrum analyzer by RF cable and attenuator. The path loss was compensated to the results for each measurement.
3. Set to the maximum power setting and enable the EUT transmit continuously.
4. Make the measurement with the spectrum analyzer's resolution bandwidth (RBW) = 100 kHz. Set the Video bandwidth (VBW) = 300 kHz. In order to make an accurate measurement. The 6 dB bandwidth must be greater than 500 kHz.
5. For 99% Bandwidth Measurement, the spectrum analyzer's resolution bandwidth (RBW) = 1MHz and set the Video bandwidth (VBW) = 3MHz.
6. Measure and record the results in the test report.

3.1.4 Test Setup

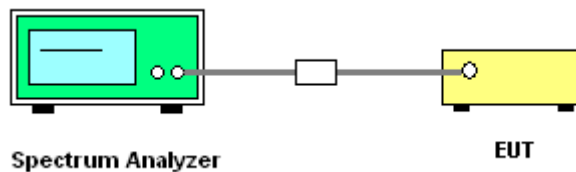



3.1.5 Test Result of 6dB Occupied Bandwidth

Test Band :	2.4GHz	Temperature :	21~26°C
Test Engineer :	Alen Tsui, AC Chang, and Derek Hsu	Relative Humidity :	45~54%

Mod.	Data Rate	N _{TX}	Channel	Freq. (MHz)	99% Bandwidth (MHz)	6dB Bandwidth (MHz)	6dB Bandwidth Min. Limit (MHz)	Pass/Fail
11b	1Mbps	1	1	2412	13.80	8.52	0.5	Pass
11b	1Mbps	1	6	2437	13.60	8.56	0.5	Pass
11b	1Mbps	1	11	2462	13.65	8.52	0.5	Pass
11g	6Mbps	1	1	2412	18.60	16.32	0.5	Pass
11g	6Mbps	1	6	2437	18.75	16.36	0.5	Pass
11g	6Mbps	1	11	2462	18.60	16.40	0.5	Pass
HT20	MCS0	1	1	2412	19.30	17.60	0.5	Pass
HT20	MCS0	1	6	2437	19.45	17.60	0.5	Pass
HT20	MCS0	1	11	2462	19.35	17.60	0.5	Pass

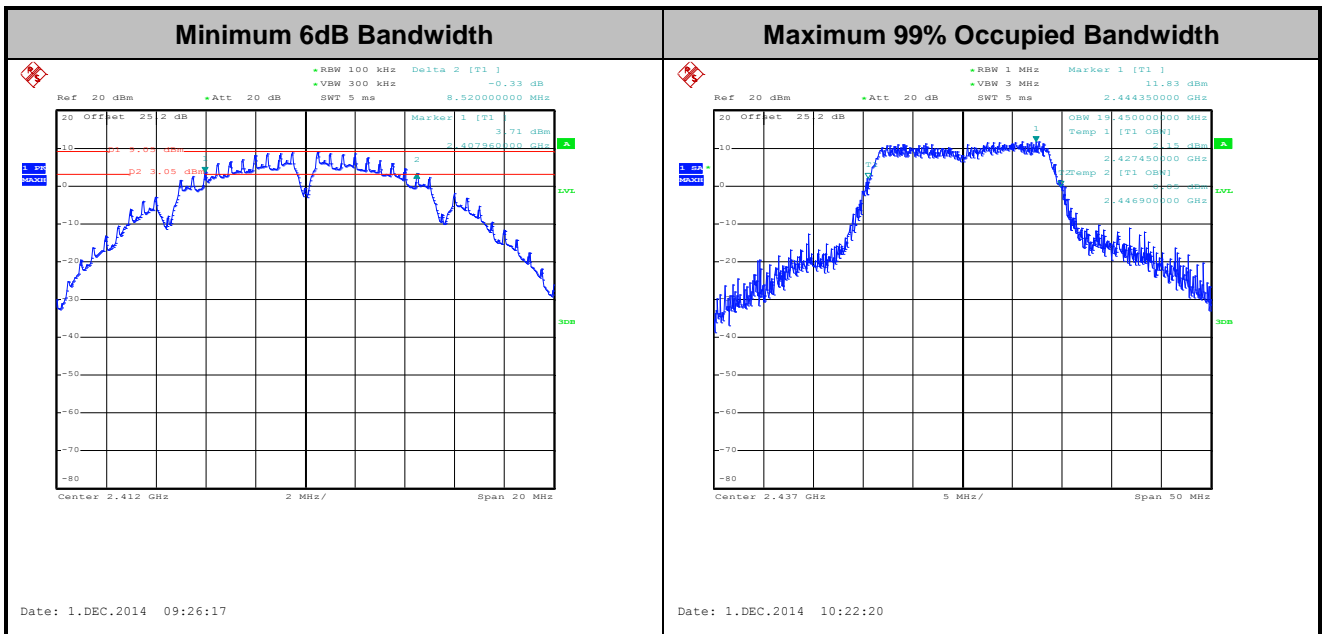

Note: The occupied channel bandwidth is maintained within the band of operation for all of the modulations.

3.2 Output Power Measurement

3.2.1 Limit of Output Power

For systems using digital modulation in the 2400-2483.5MHz, the limit for peak output power is 30dBm. If transmitting Antenna of directional gain greater than 6dBi are used the peak output power from the intentional radiator shall be reduced below the above stated value by the amount in dB that the directional gain of the Antenna exceeds 6 dBi. In case of point-to-point operation, the limit has to be reduced by 1dB for every 3dB that the directional gain of the Antenna exceeds 6dBi.

3.2.2 Measuring Instruments

The measuring equipment is listed in the section 4 of this test report.

3.2.3 Test Procedures

1. The testing follows the Measurement Procedure of FCC KDB No. 558074 DTS D01 Meas. Guidance v03r02.
2. The RF output of EUT was connected to the power meter by RF cable and attenuator. The path loss was compensated to the results for each measurement.
3. Set to the maximum power setting and enable the EUT transmit continuously.
4. Measure the conducted output power and record the results in the test report.

3.2.4 Test Setup

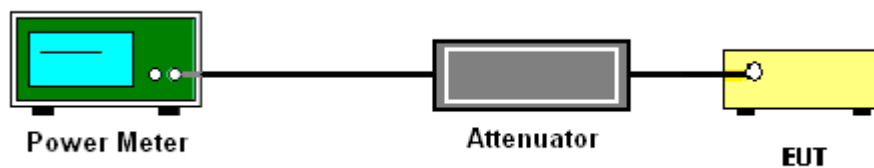



3.2.5 Test Result of Peak Output Power

Test Mode :	2.4GHz	Temperature :	21~26°C
Test Engineer :	Alen Tsui, AC Chang, and Derek Hsu	Relative Humidity :	45~54%

Mod.	Data Rate	N _{TX}	Channel	Freq. (MHz)	RF Output Power (dBm)	Power Limit (dBm)	DG (dBi)	Pass/Fail
11b	1Mbps	1	1	2412	20.00	30	-2.10	Pass
11b	1Mbps	1	6	2437	20.77	30	-2.10	Pass
11b	1Mbps	1	11	2462	20.29	30	-2.10	Pass
11g	6Mbps	1	1	2412	23.15	30	-2.10	Pass
11g	6Mbps	1	6	2437	23.48	30	-2.10	Pass
11g	6Mbps	1	11	2462	21.51	30	-2.10	Pass
HT20	MCS0	1	1	2412	22.32	30	-2.10	Pass
HT20	MCS0	1	6	2437	23.60	30	-2.10	Pass
HT20	MCS0	1	11	2462	21.27	30	-2.10	Pass

Note: Measured power (dBm) has offset with cable loss.

3.2.6 Test Result of Average output Power (Reporting Only)

Test Mode :	2.4GHz	Temperature :	21~26°C
Test Engineer :	Alen Tsui, AC Chang, and Derek Hsu	Relative Humidity :	45~54%

Mod.	Data Rate	N _{TX}	Channel	Freq. (MHz)	Duty Factor (dB)	Average Output Power (dBm)	Power Limit (dBm)	DG (dBi)	Pass/Fail
11b	1Mbps	1	1	2412	0.05	17.73	30	-2.10	Pass
11b	1Mbps	1	6	2437	0.05	17.98	30	-2.10	Pass
11b	1Mbps	1	11	2462	0.05	17.60	30	-2.10	Pass
11g	6Mbps	1	1	2412	0.05	15.89	30	-2.10	Pass
11g	6Mbps	1	6	2437	0.05	15.97	30	-2.10	Pass
11g	6Mbps	1	11	2462	0.05	12.85	30	-2.10	Pass
HT20	MCS0	1	1	2412	0.05	14.43	30	-2.10	Pass
HT20	MCS0	1	6	2437	0.05	16.00	30	-2.10	Pass
HT20	MCS0	1	11	2462	0.05	11.89	30	-2.10	Pass

Note: Measured power (dBm) has offset with cable loss and duty factor.

3.3 Power Spectral Density Measurement

3.3.1 Limit of Power Spectral Density

The peak power spectral density shall not be greater than 8dBm in any 3kHz band at any time interval of continuous transmission.

3.3.2 Measuring Instruments

The measuring equipment is listed in the section 4 of this test report.

3.3.3 Test Procedures

1. The testing follows Measurement Procedure 10.2 Method PKPSD of FCC KDB Publication No. 558074 D01 DTS Meas. Guidance v03r02
2. The RF output of EUT was connected to the spectrum analyzer by RF cable and attenuator. The path loss was compensated to the results for each measurement.
3. Set to the maximum power setting and enable the EUT transmit continuously.
4. Make the measurement with the spectrum analyzer's resolution bandwidth (RBW) = 3 kHz. Video bandwidth VBW = 10 kHz In order to make an accurate measurement, set the span to 1.5 times DTS Channel Bandwidth. (6dB BW)
5. Detector = peak, Sweep time = auto couple, Trace mode = max hold, Allow trace to fully stabilize. Use the peak marker function to determine the maximum power level.
6. Measure and record the results in the test report.

3.3.4 Test Setup

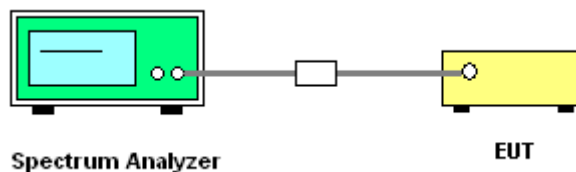



3.3.5 Test Result of Power Spectral Density

Test Mode :	2.4GHz	Temperature :	21~26°C
Test Engineer :	Alen Tsui, AC Chang, and Derek Hsu	Relative Humidity :	45~54%

Mod.	Data Rate	N _{TX}	Channel	Freq. (MHz)	Peak Power Density (dBm/3kHz)	Max. Limits (dBm/3kHz)	DG (dBi)	Pass/Fail
11b	1Mbps	1	1	2412	-5.29	8	-2.10	Pass
11b	1Mbps	1	6	2437	-5.46	8	-2.10	Pass
11b	1Mbps	1	11	2462	-6.06	8	-2.10	Pass
11g	6Mbps	1	1	2412	-9.26	8	-2.10	Pass
11g	6Mbps	1	6	2437	-9.80	8	-2.10	Pass
11g	6Mbps	1	11	2462	-11.23	8	-2.10	Pass
HT20	MCS0	1	1	2412	-10.63	8	-2.10	Pass
HT20	MCS0	1	6	2437	-9.77	8	-2.10	Pass
HT20	MCS0	1	11	2462	-13.12	8	-2.10	Pass

Note: Measured power density (dBm) has offset with cable loss.

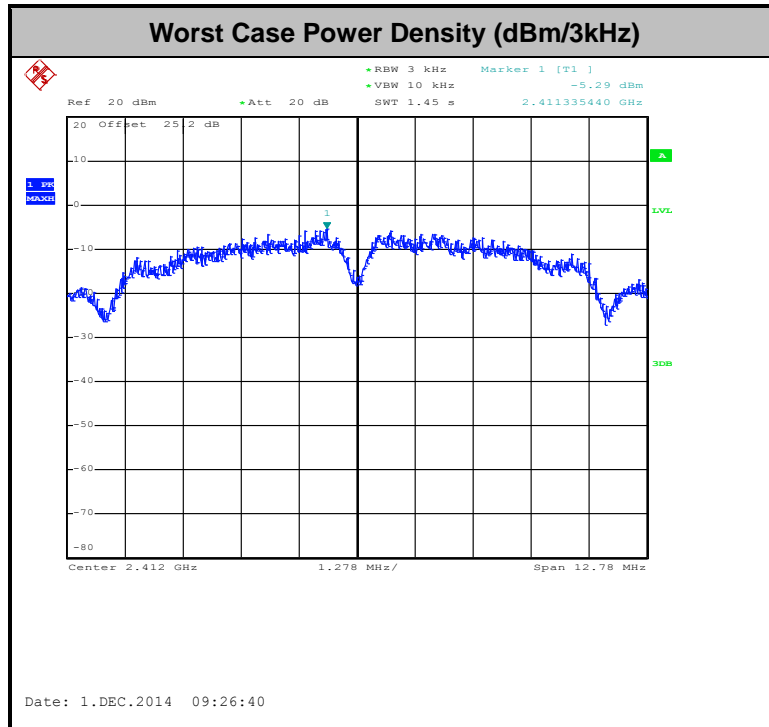

3.4 Conducted Band Edges and Spurious Emission Measurement

3.4.1 Limit of Conducted Band Edges and Spurious Emission Measurement

In any 100 kHz bandwidth outside of the authorized frequency band, the emissions which fall in the non-restricted bands shall be attenuated at least 20 dB / 30dB relative to the maximum PSD level in 100 kHz by RF conducted measurement and radiated emissions which fall in the restricted bands, as defined in Section 15.205(a), must also comply with the radiated emission limits specified in Section 15.209(a).

3.4.2 Measuring Instruments

The measuring equipment is listed in the section 4 of this test report.

3.4.3 Test Procedures

1. The testing follows FCC KDB Publication No. 558074 D01 DTS Meas. Guidance v03r02.
2. The RF output of EUT was connected to the spectrum analyzer by RF cable and attenuator. The path loss was compensated to the results for each measurement.
3. Set to the maximum power setting and enable the EUT transmit continuously.
4. Set RBW = 100 kHz, VBW=300 kHz, Peak Detector. Unwanted Emissions measured in any 100 kHz bandwidth outside of the authorized frequency band shall be attenuated by at least 20 dB relative to the maximum in-band peak PSD level in 100 kHz when maximum peak conducted output power procedure is used. If the transmitter complies with the conducted power limits based on the use of RMS averaging over a time interval, the attenuation required under this paragraph shall be 30 dB instead of 20 dB per 15.247(d).
5. Measure and record the results in the test report.
6. The RF fundamental frequency should be excluded against the limit line in the operating frequency band.

3.4.4 Test Setup

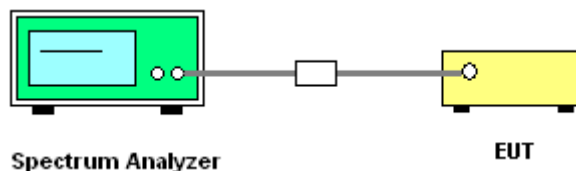



3.4.5 Test Result of Conducted Band Edges and Spurious Emission

Test Mode :	802.11b	Temperature :	21~26°C
Test Band :	2.4GHz Low	Relative Humidity :	45~54%
Test Channel :	01	Test Engineer :	Alen Tsui, AC Chang, and Derek Hsu

WLAN 802.11b Channel 01

100kHz PSD reference Level	Low Channel Plot
-----------------------------------	-------------------------

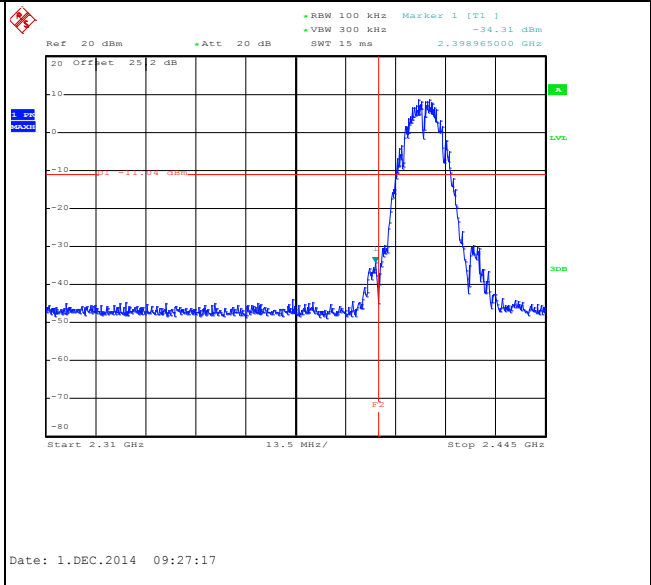
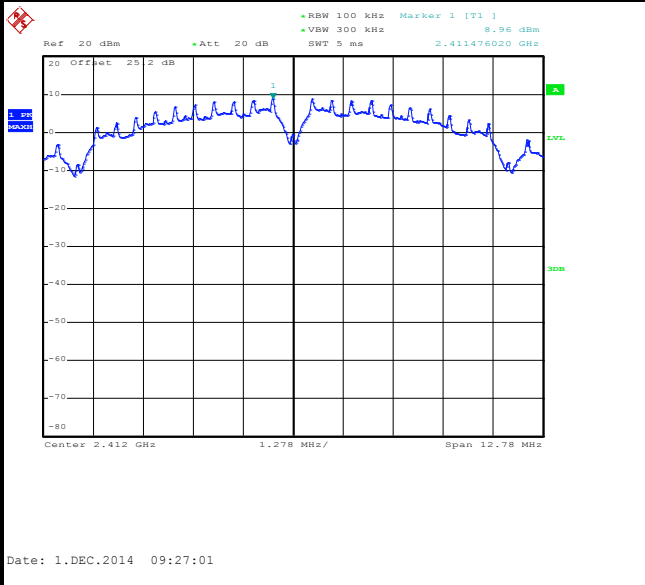

Spurious Emission 30MHz~3GHz	Spurious Emission 2GHz~25GHz
-------------------------------------	-------------------------------------

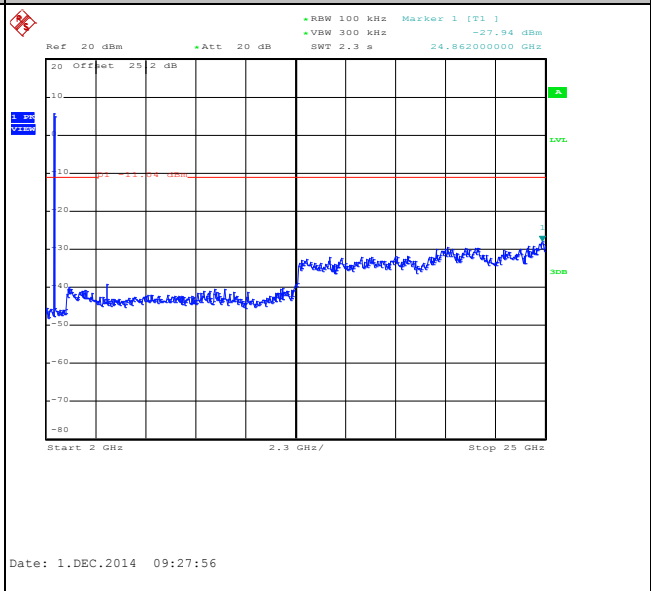
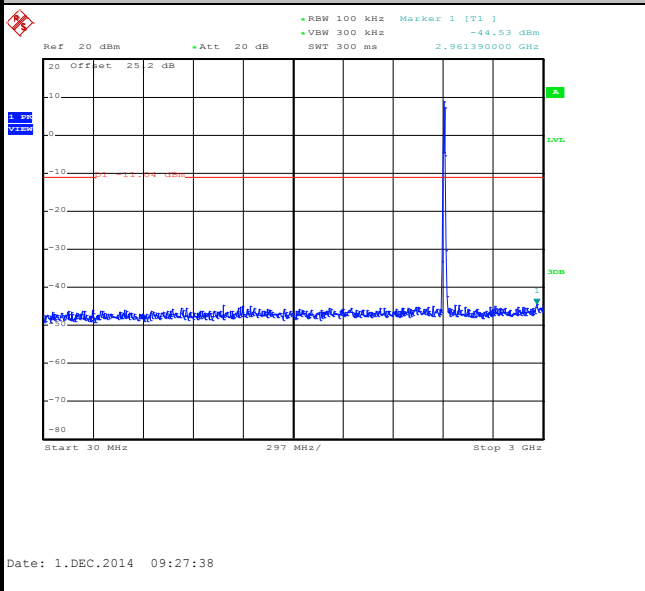



Test Mode :	802.11b	Temperature :	21~26°C
Test Band :	2.4GHz Mid.	Relative Humidity :	45~54%
Test Channel :	06	Test Engineer :	Alen Tsui, AC Chang, and Derek Hsu

WLAN 802.11b Channel 06

100kHz PSD reference Level

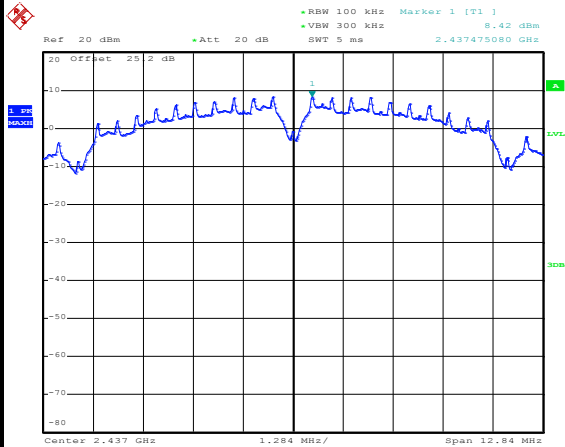

Date: 1.DEC.2014 09:30:18

Spurious Emission 30MHz~3GHz

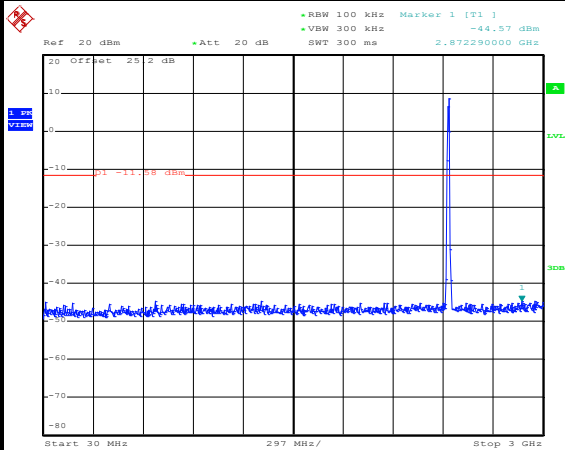

Date: 1.DEC.2014 09:30:38

Spurious Emission 2GHz~25GHz

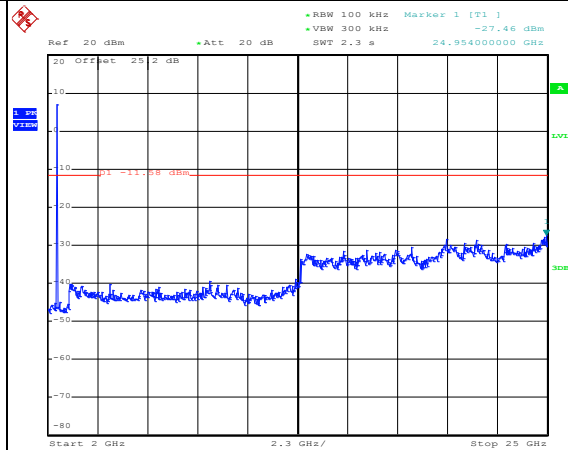

Date: 1.DEC.2014 09:30:56



Test Mode :	802.11b	Temperature :	21~26°C
Test Band :	2.4GHz High	Relative Humidity :	45~54%
Test Channel :	11	Test Engineer :	Alen Tsui, AC Chang, and Derek Hsu

WLAN 802.11b Channel 11

100kHz PSD reference Level

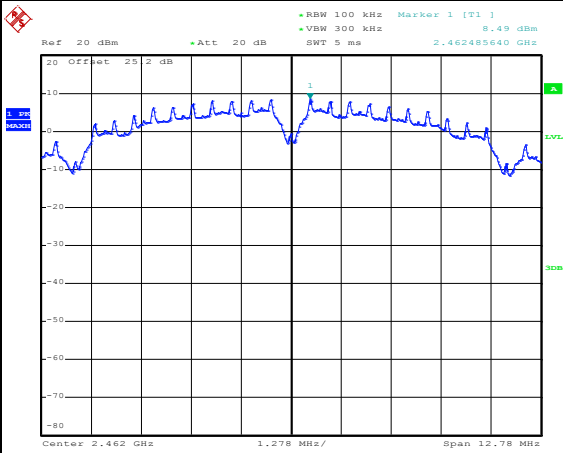

Date: 1.DEC.2014 09:34:19

High Channel Plot

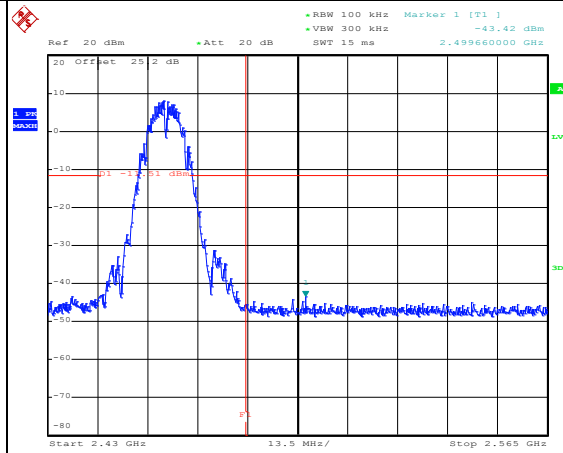

Date: 1.DEC.2014 09:34:34

Spurious Emission 30MHz~3GHz

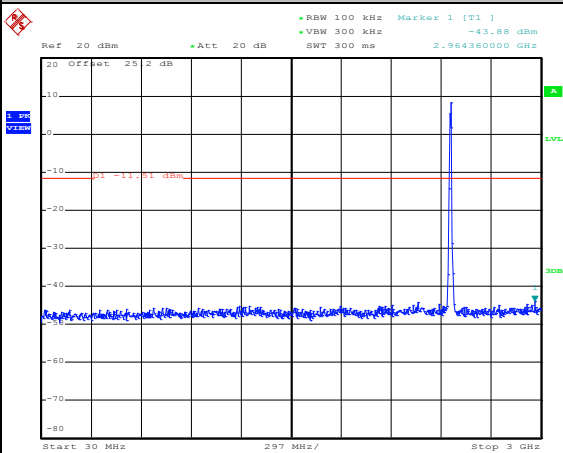

Date: 1.DEC.2014 09:34:55

Spurious Emission 2GHz~25GHz

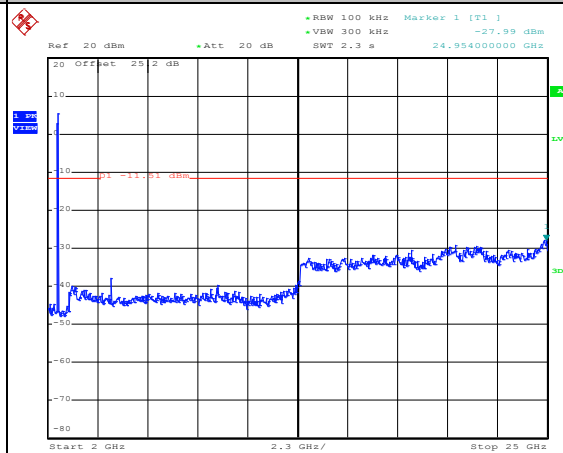

Date: 1.DEC.2014 09:35:13



Test Mode :	802.11g	Temperature :	21~26°C
Test Band :	2.4GHz Low	Relative Humidity :	45~54%
Test Channel :	01	Test Engineer :	Alen Tsui, AC Chang, and Derek Hsu

WLAN 802.11g Channel 01

100kHz PSD reference Level

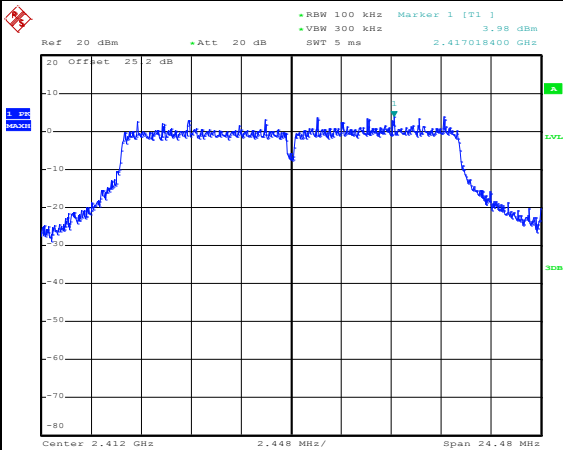

Date: 1.DEC.2014 10:04:53

Low Channel Plot

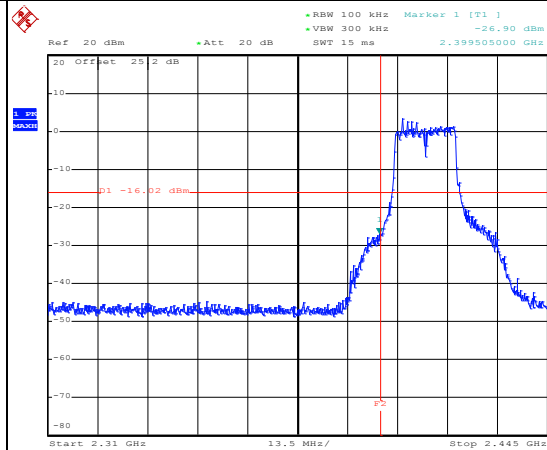

Date: 1.DEC.2014 10:05:14

Spurious Emission 30MHz~3GHz

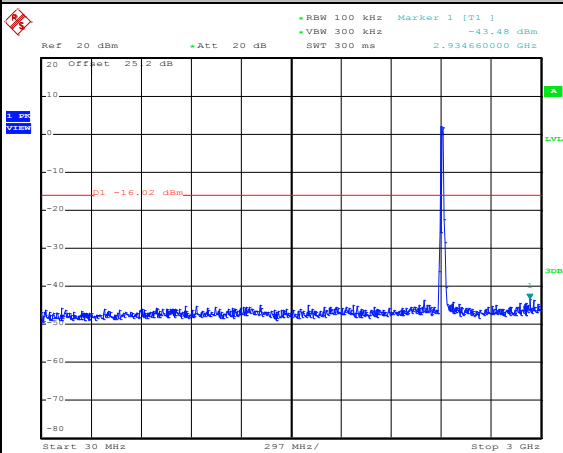

Date: 1.DEC.2014 10:05:40

Spurious Emission 2GHz~25GHz

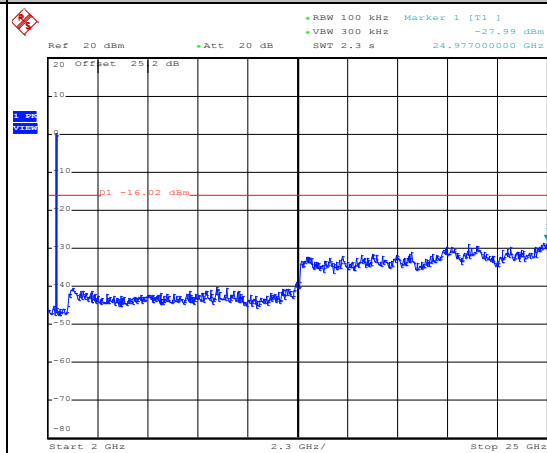

Date: 1.DEC.2014 10:05:58



Test Mode :	802.11g	Temperature :	21~26°C
Test Band :	2.4GHz Mid.	Relative Humidity :	45~54%
Test Channel :	06	Test Engineer :	Alen Tsui, AC Chang, and Derek Hsu

WLAN 802.11g Channel 06

100kHz PSD reference Level

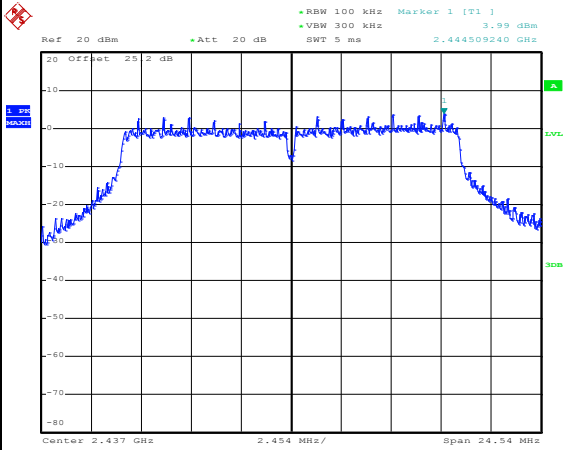

Date: 1.DEC.2014 09:55:14

Spurious Emission 30MHz~3GHz

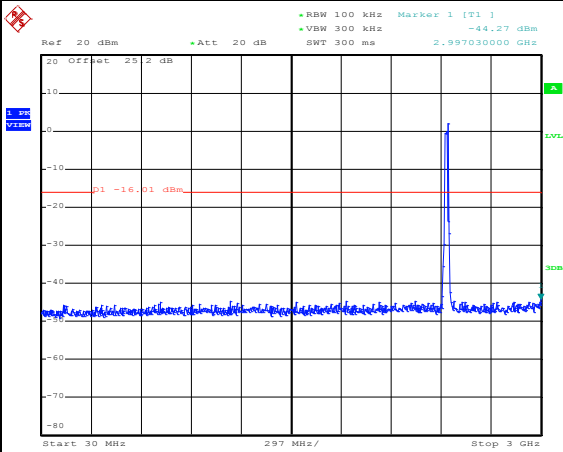

Date: 1.DEC.2014 09:55:36

Spurious Emission 2GHz~25GHz

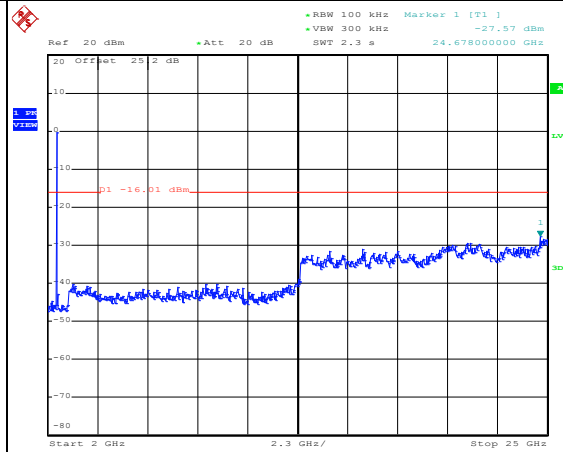

Date: 1.DEC.2014 09:55:54



Test Mode :	802.11g	Temperature :	21~26°C
Test Band :	2.4GHz High	Relative Humidity :	45~54%
Test Channel :	11	Test Engineer :	Alen Tsui, AC Chang, and Derek Hsu

WLAN 802.11g Channel 11

100kHz PSD reference Level

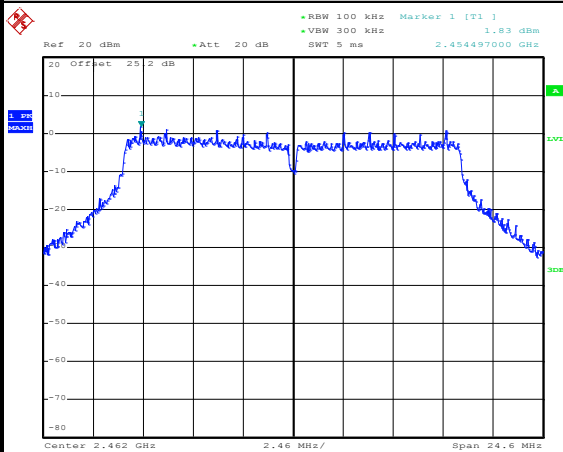

Date: 1.DEC.2014 09:58:15

High Channel Plot

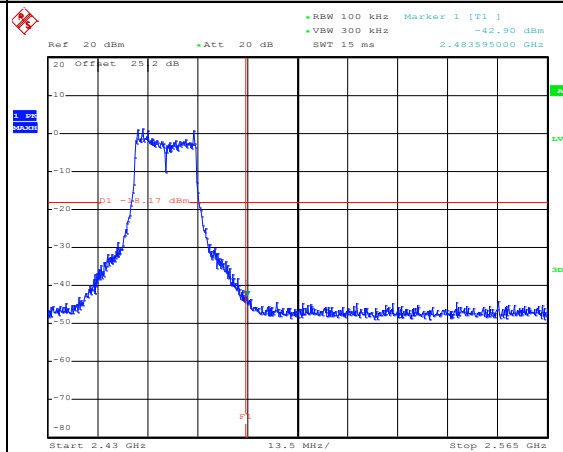

Date: 1.DEC.2014 09:59:50

Spurious Emission 30MHz~3GHz

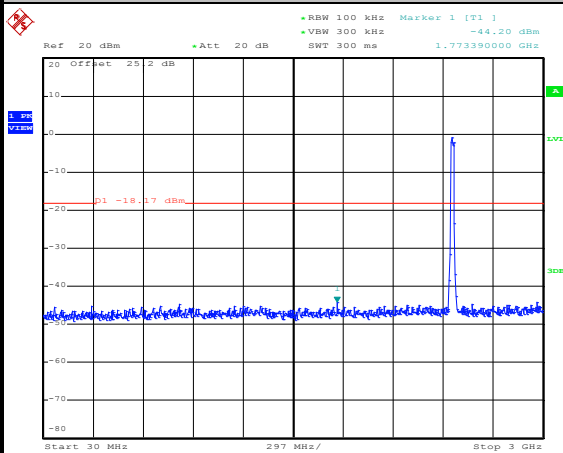

Date: 1.DEC.2014 10:00:12

Spurious Emission 2GHz~25GHz

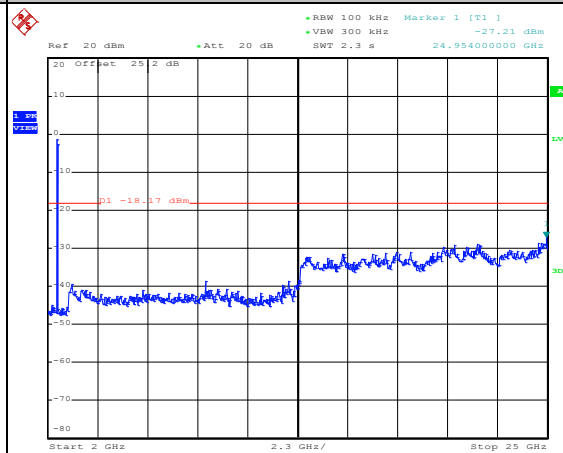

Date: 1.DEC.2014 10:00:30



Test Mode :	802.11n HT20	Temperature :	21~26°C
Test Band :	2.4GHz Low	Relative Humidity :	45~54%
Test Channel :	01	Test Engineer :	Alen Tsui, AC Chang, and Derek Hsu

WLAN 802.11n HT20 Channel 01

100kHz PSD reference Level

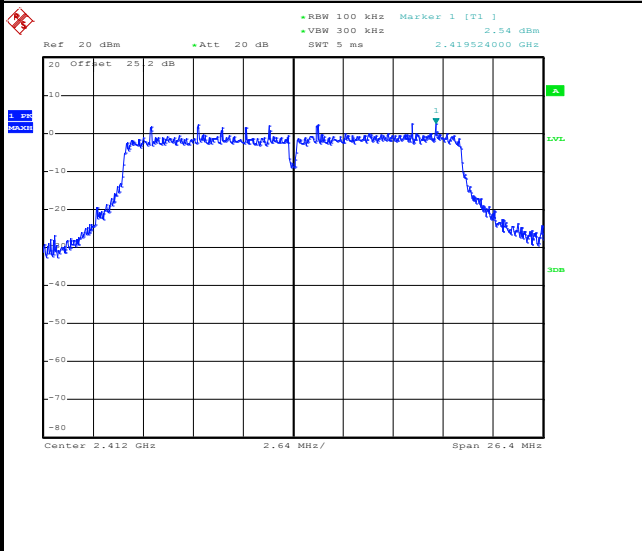

Low Channel Plot

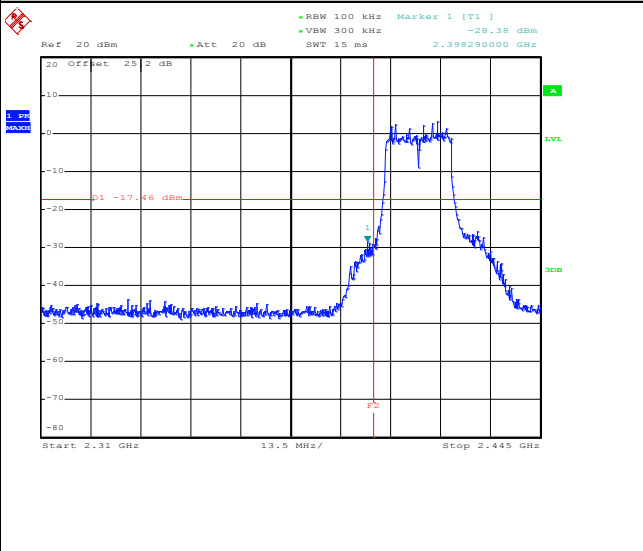

Spurious Emission 30MHz~3GHz

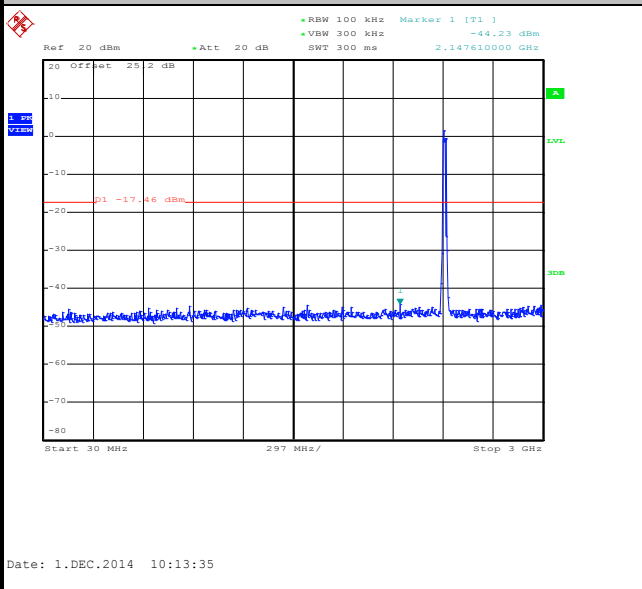

Spurious Emission 2GHz~25GHz

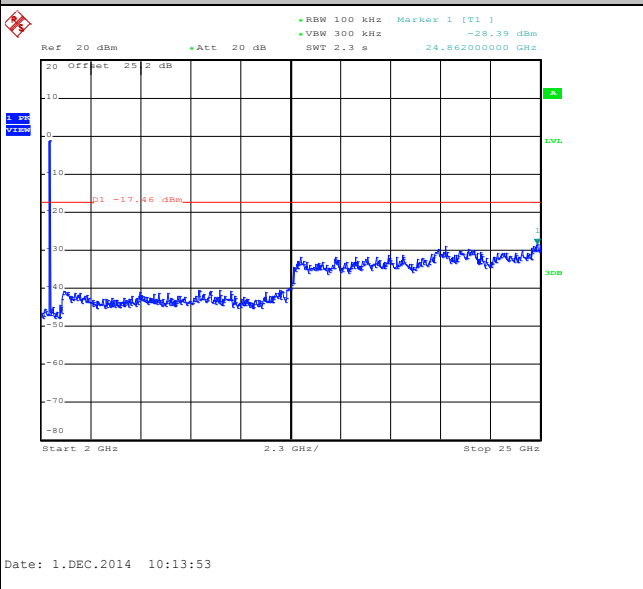



Test Mode :	802.11n HT20	Temperature :	21~26°C
Test Band :	2.4GHz Mid.	Relative Humidity :	45~54%
Test Channel :	06	Test Engineer :	Alen Tsui, AC Chang, and Derek Hsu

WLAN 802.11n HT20 Channel 06

100kHz PSD reference Level

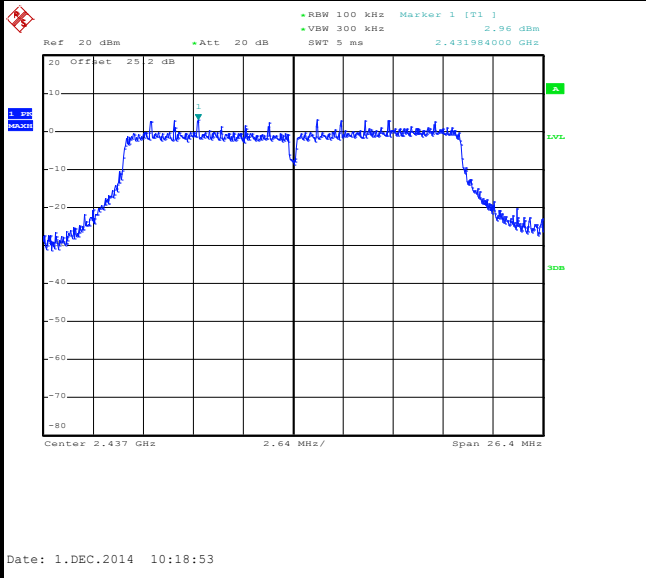

Spurious Emission 30MHz~3GHz

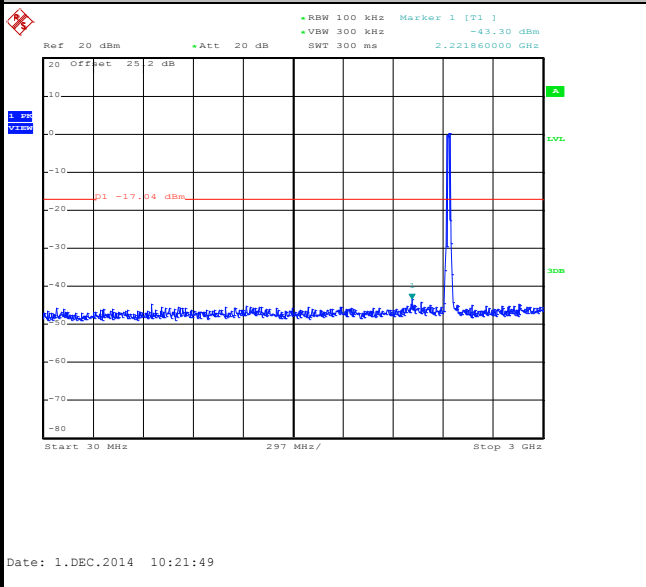

Spurious Emission 2GHz~25GHz

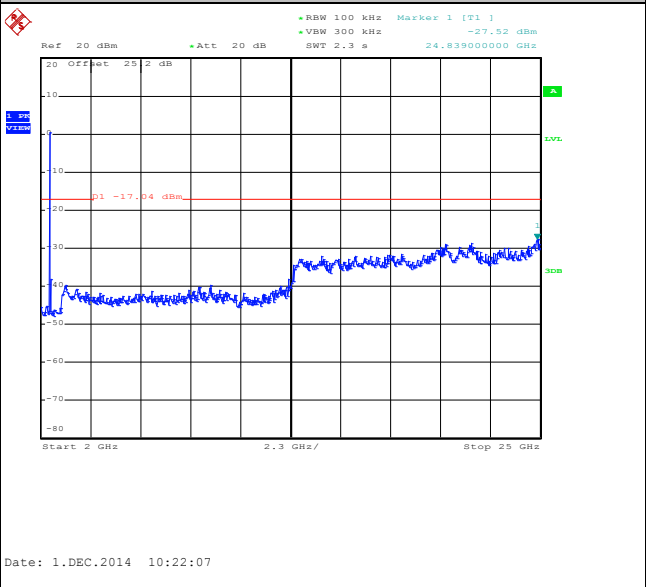



Test Mode :	802.11n HT20	Temperature :	21~26°C
Test Band :	2.4GHz High	Relative Humidity :	45~54%
Test Channel :	11	Test Engineer :	Alen Tsui, AC Chang, and Derek Hsu

WLAN 802.11n HT20 Channel 11

100kHz PSD reference Level

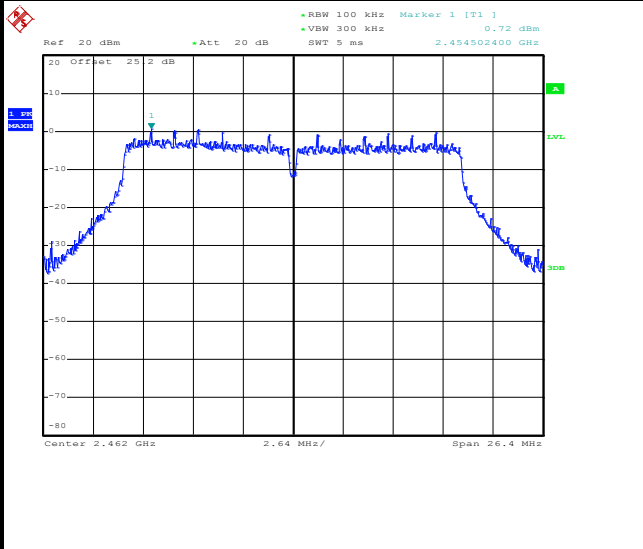

High Channel Plot

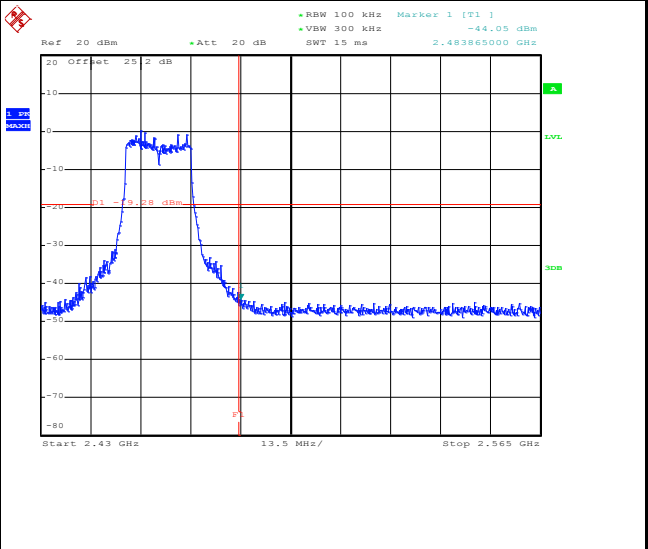

Spurious Emission 30MHz~3GHz

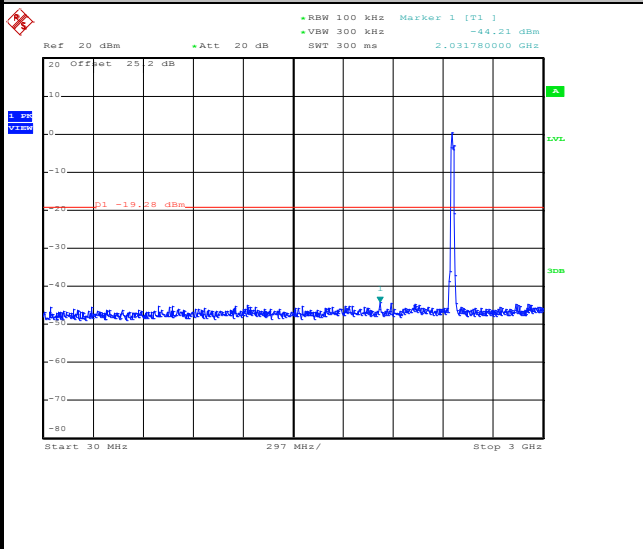

Spurious Emission 2GHz~25GHz

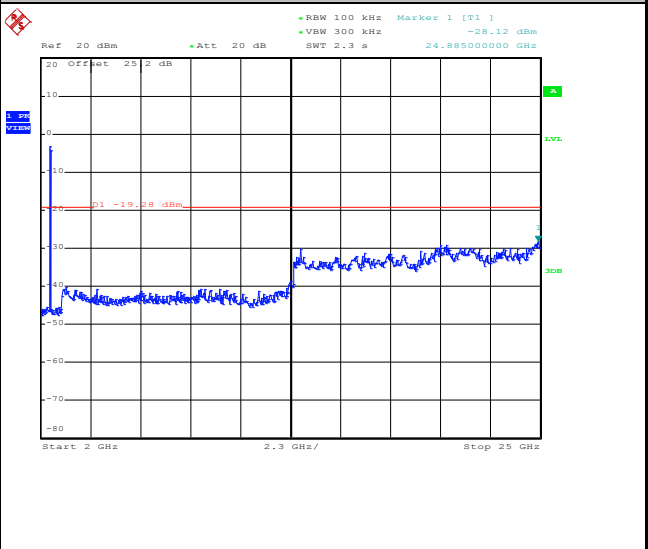



3.5 Radiated Band Edges and Spurious Emission Measurement

3.5.1 Limit of Radiated band edge and Spurious Emission Measurement

In any 100 kHz bandwidth outside the intentional radiator frequency band, all harmonics/spurious must be at least 20 dB below the highest emission level within the authorized band. If the output power of this device was measured by spectrum analyzer, the attenuation under this paragraph shall be 30 dB instead of 20 dB. In addition, radiated emissions which fall in the restricted bands must also comply with the FCC section 15.209 limits as below.

Note: Wireless Charger Configuration was evaluated.

Frequency (MHz)	Field Strength (microvolts/meter)	Measurement Distance (meters)
0.009 – 0.490	2400/F(kHz)	300
0.490 – 1.705	24000/F(kHz)	30
1.705 – 30.0	30	30
30 – 88	100	3
88 – 216	150	3
216 - 960	200	3
Above 960	500	3

3.5.2 Measuring Instruments

The measuring equipment is listed in the section 4 of this test report.



3.5.3 Test Procedures

1. The testing follows FCC KDB Publication No. 558074 D01 DTS Meas. Guidance v03r02.
2. The EUT was arranged to its worst case and then tune the antenna tower (from 1 m to 4 m) and turntable (from 0 degree to 360 degrees) to find the maximum reading. A pre-amp and a high pass filter are used for the test in order to get better signal level.
3. The EUT was placed on a turntable with 0.8 meter for frequency < 1GHz and 1.5 meter for frequency > 1GHz above ground.
4. The EUT was set 3 meters from the interference receiving antenna, which was mounted on the top of a variable height antenna tower.
5. Corrected Reading: Antenna Factor + Cable Loss + Read Level - Preamp Factor = Level
6. For measurement below 1GHz, If the emission level of the EUT measured by the peak detector is 3 dB lower than the applicable limit, the peak emission level will be reported. Otherwise, the emission measurement will be repeated using the quasi-peak detector and reported.
7. Use the following spectrum analyzer settings:
 - (1) Span shall wide enough to fully capture the emission being measured;
 - (2) Set RBW=100 kHz for f < 1 GHz; VBW ≥ RBW; Sweep = auto; Detector function = peak; Trace = max hold;
 - (3) Set RBW = 1 MHz, VBW= 3MHz for f ≥ 1 GHz for peak measurement.

For average measurement:

 - VBW = 10 Hz, when duty cycle is no less than 98 percent.
 - VBW ≥ 1/T, when duty cycle is less than 98 percent where T is the minimum transmission duration over which the transmitter is on and is transmitting at its maximum power control level for the tested mode of operation.

Band	Duty Cycle(%)	T(μs)	1/T(kHz)	VBW Setting
802.11b	98.84	-	-	10Hz
802.11g	98.90	-	-	10Hz
802.11n HT20	98.80	-	-	10Hz

3.5.4 Test Setup

For radiated emissions below 30MHz

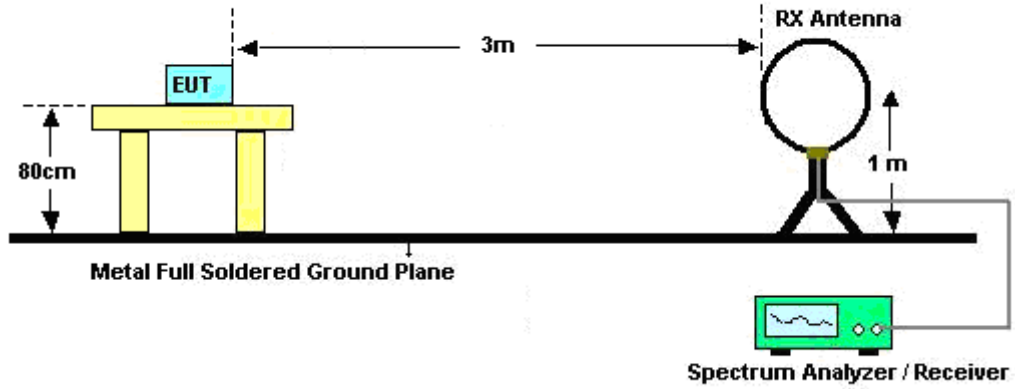

For radiated emissions from 30MHz to 1GHz

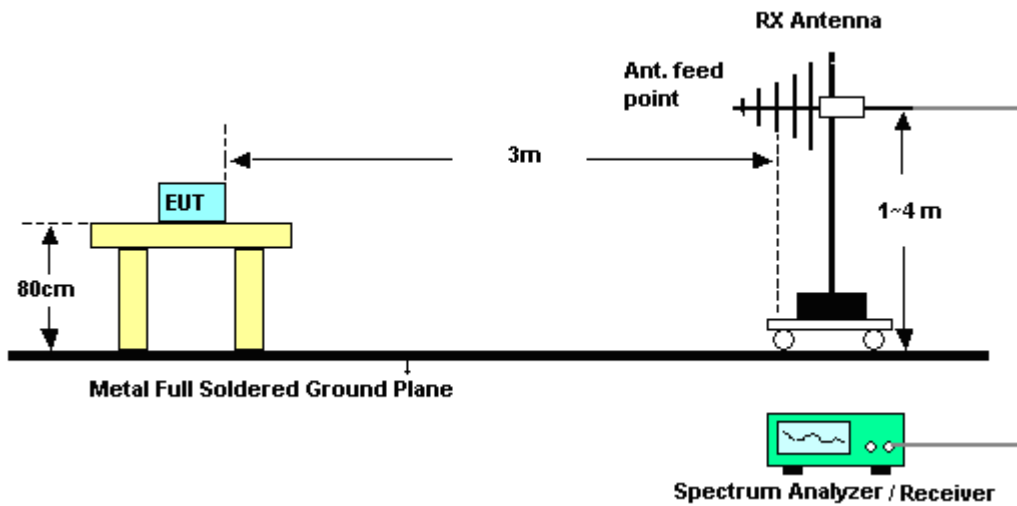

For radiated emissions above 1GHz

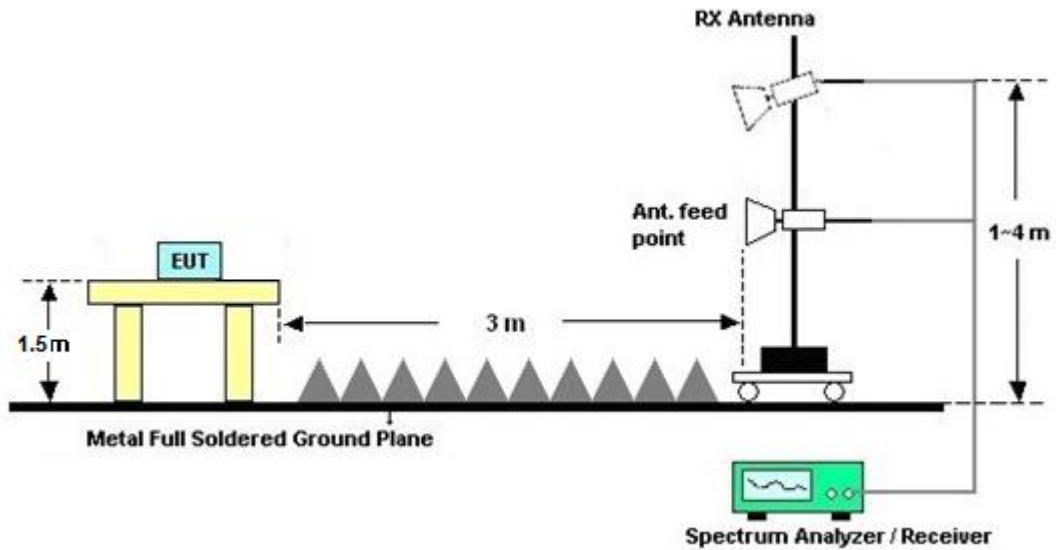

3.5.5 Test Results of Radiated Spurious Emissions (9kHz ~ 30MHz)

The low frequency, which started from 9 kHz to 30MHz, was pre-scanned and the result which was 20dB lower than the limit line per 15.31(o) was not reported.

3.5.6 Test Result

Please refer to appendix A as below.



3.6 AC Conducted Emission Measurement

3.6.1 Limit of AC Conducted Emission

For equipment that is designed to be connected to the public utility (AC) power line, the radio frequency voltage that is conducted back onto the AC power line on any frequency or frequencies within the band 150 kHz to 30 MHz shall not exceed the limits in the following table.

Frequency of Emission (MHz)	Conducted Limit (dB μ V)	
	Quasi-Peak	Average
0.15-0.5	66 to 56*	56 to 46*
0.5-5	56	46
5-30	60	50

*Decreases with the logarithm of the frequency.

3.6.2 Measuring Instruments

The measuring equipment is listed in the section 4 of this test report.

3.6.3 Test Procedures

1. The EUT was placed 0.4 meter from the conducting wall of the shielding room, and it was kept at least 80 centimeters from any other grounded conducting surface.
2. Connect EUT to the power mains through a line impedance stabilization network (LISN).
3. All the support units are connecting to the other LISN.
4. The LISN provides 50 ohm coupling impedance for the measuring instrument.
5. The FCC states that a 50 ohm, 50 microhenry LISN should be used.
6. Both sides of AC line were checked for maximum conducted interference.
7. The frequency range from 150 kHz to 30 MHz was searched.
8. Set the test-receiver system to Peak Detect Function and specified bandwidth (IF Bandwidth=9KHz) with Maximum Hold Mode.

3.6.4 Test Setup

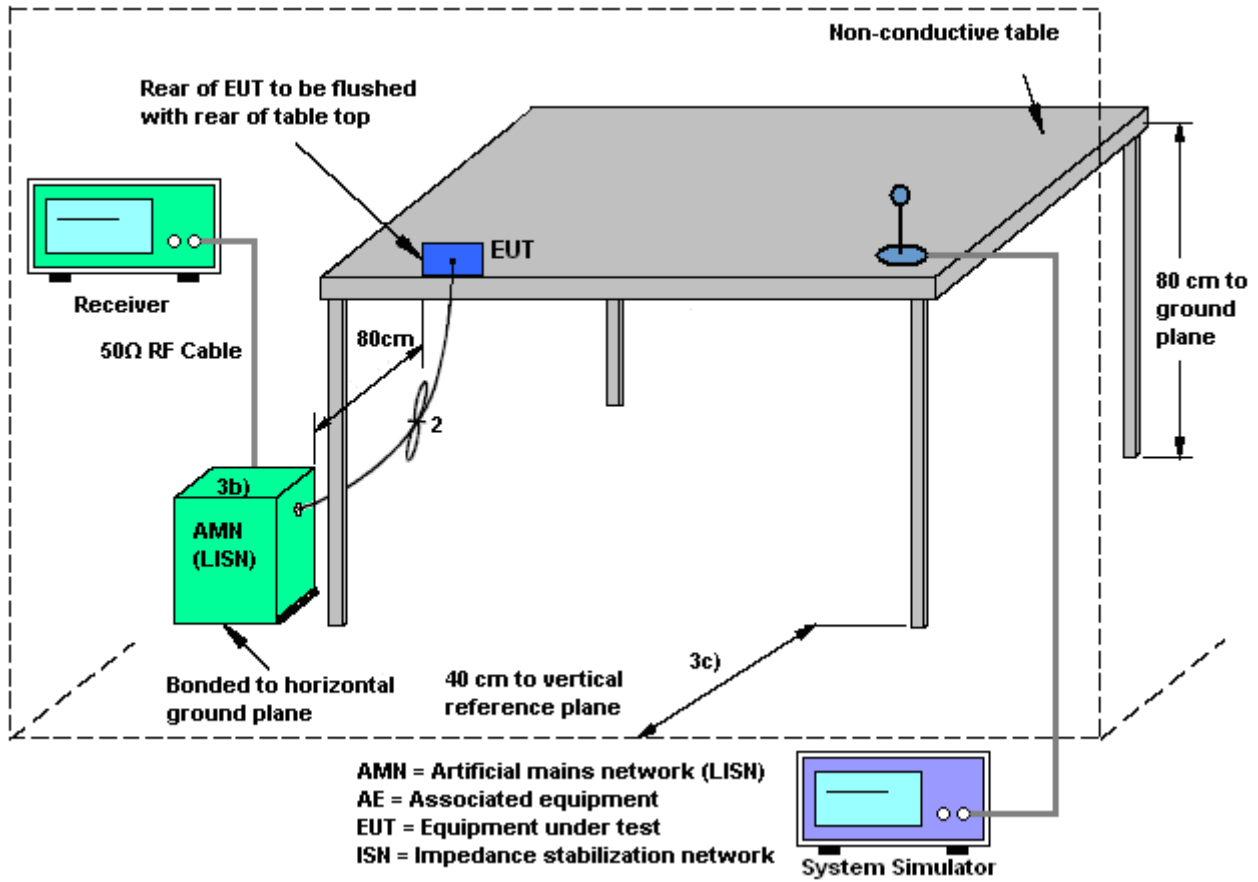



3.6.5 Test Result of AC Conducted Emission

Test Mode :	Mode 1	Temperature :	20~22°C
Test Engineer :	Kai-Chun Chu	Relative Humidity :	46~48%
Test Voltage :	120Vac / 60Hz	Phase :	Line
Function Type :	GSM850 Idle + Bluetooth Link + WLAN Link + MP3 + Earphone + Adapter		

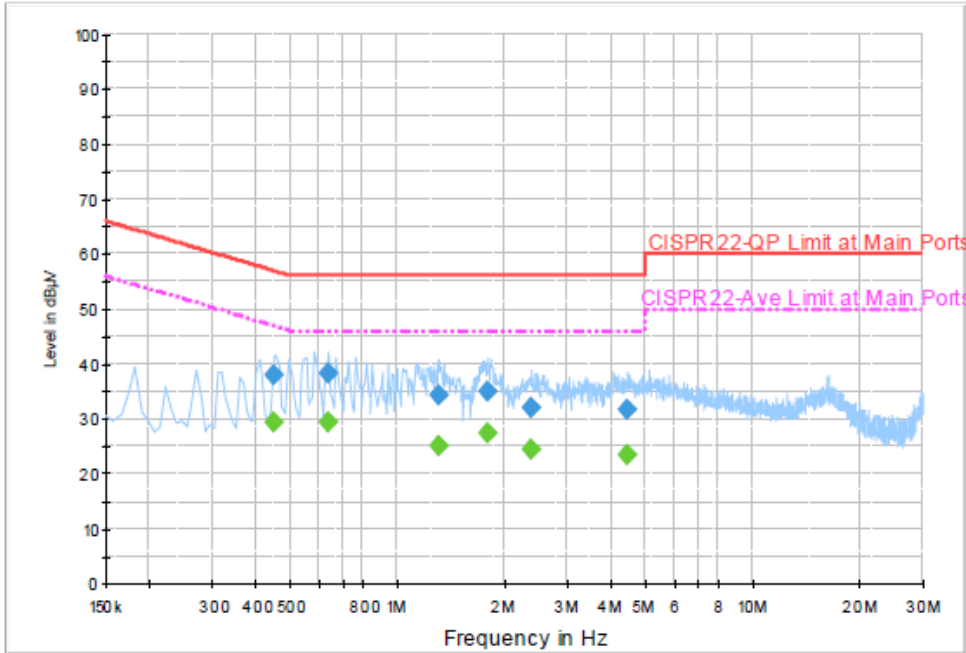

Final Result : Quasi-Peak

Frequency (MHz)	Quasi-Peak (dBµV)	Filter	Line	Corr. (dB)	Margin (dB)	Limit (dBµV)
0.446000	37.9	Off	L1	19.5	19.0	56.9
0.638000	38.2	Off	L1	19.5	17.8	56.0
1.302000	34.2	Off	L1	19.5	21.8	56.0
1.798000	34.8	Off	L1	19.5	21.2	56.0
2.382000	31.9	Off	L1	19.4	24.1	56.0
4.446000	31.8	Off	L1	19.6	24.2	56.0

Final Result : Average

Frequency (MHz)	Average (dBµV)	Filter	Line	Corr. (dB)	Margin (dB)	Limit (dBµV)
0.446000	29.2	Off	L1	19.5	17.7	46.9
0.638000	29.4	Off	L1	19.5	16.6	46.0
1.302000	25.1	Off	L1	19.5	20.9	46.0
1.798000	27.4	Off	L1	19.5	18.6	46.0
2.382000	24.4	Off	L1	19.4	21.6	46.0
4.446000	23.3	Off	L1	19.6	22.7	46.0



Test Mode :	Mode 1	Temperature :	20~22°C
Test Engineer :	Kai-Chun Chu	Relative Humidity :	46~48%
Test Voltage :	120Vac / 60Hz	Phase :	Neutral
Function Type :	GSM850 Idle + Bluetooth Link + WLAN Link + MP3 + Earphone + Adapter		

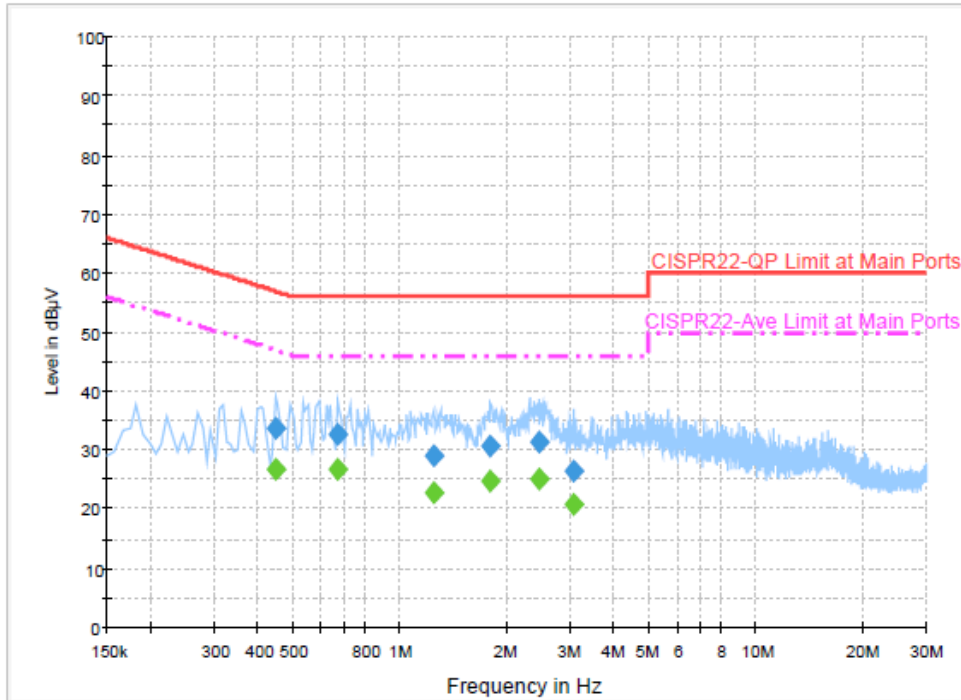

Final Result : Quasi-Peak

Frequency (MHz)	Quasi-Peak (dBµV)	Filter	Line	Corr. (dB)	Margin (dB)	Limit (dBµV)
0.446000	33.5	Off	N	19.5	23.4	56.9
0.670000	32.6	Off	N	19.5	23.4	56.0
1.238000	29.0	Off	N	19.5	27.0	56.0
1.798000	30.6	Off	N	19.5	25.4	56.0
2.462000	31.2	Off	N	19.5	24.8	56.0
3.062000	26.5	Off	N	19.6	29.5	56.0

Final Result : Average

Frequency (MHz)	Average (dBµV)	Filter	Line	Corr. (dB)	Margin (dB)	Limit (dBµV)
0.446000	26.9	Off	N	19.5	20.0	46.9
0.670000	26.7	Off	N	19.5	19.3	46.0
1.238000	22.6	Off	N	19.5	23.4	46.0
1.798000	24.8	Off	N	19.5	21.2	46.0
2.462000	25.0	Off	N	19.5	21.0	46.0
3.062000	20.7	Off	N	19.6	25.3	46.0



3.7 Antenna Requirements

3.7.1 Standard Applicable

If directional gain of transmitting antennas is greater than 6dBi, the power shall be reduced by the same level in dB comparing to gain minus 6dBi. For the fixed point-to-point operation, the power shall be reduced by one dB for every 3 dB that the directional gain of the antenna exceeds 6 dBi. The use of a permanently attached antenna or of an antenna that uses a unique coupling to the intentional radiator shall be considered sufficient to comply with the FCC rule.

3.7.2 Antenna Anti-Replacement Construction

An embedded-in antenna design is used.

3.7.3 Antenna Gain

The antenna peak gain of EUT is less than 6 dBi. Therefore, it is not necessary to reduce maximum peak output power limit.



4 List of Measuring Equipment

Instrument	Manufacturer	Model No.	Serial No.	Characteristics	Calibration Date	Test Date	Due Date	Remark
Spectrum Analyzer	Rohde & Schwarz	FSP40	100055	9kHz~40GHz	Jun. 09, 2014	Nov. 20, 2014 ~ Dec. 01, 2014	Jun. 08, 2015	Conducted (TH02-HY)
Power Meter	Anritsu	ML2495A	1036004	300MHz~40GHz	Aug. 09, 2014	Nov. 20, 2014 ~ Dec. 01, 2014	Aug. 08, 2015	Conducted (TH02-HY)
Power Sensor	Anritsu	MA2411B	1027253	300MHz~40GHz	Aug. 09, 2014	Nov. 20, 2014 ~ Dec. 01, 2014	Aug. 08, 2015	Conducted (TH02-HY)
Spectrum Analyzer	Rohde & Schwarz	FSP40	100055	9kHz~40GHz	Jun. 09, 2014	Nov. 22, 2014 ~ Nov. 23, 2014	Jun. 08, 2015	Radiation (03CH05-HY)
Bilog Antenna	Schaffner	CBL6111C	2725	30MHz~1GHz	Sep. 27, 2014	Nov. 22, 2014 ~ Nov. 23, 2014	Sep. 26, 2015	Radiation (03CH05-HY)
Double Ridged Guide Horn Antenna	SCHWARZBECK	BBHA 9120 D	9120D-1241	1GHz~18GHz	Apr. 16, 2014	Nov. 22, 2014 ~ Nov. 23, 2014	Apr. 15, 2015	Radiation (03CH05-HY)
SHF-EHF Horn Antenna	SCHWARZBECK	BBHA 9170	BBHA9170251	18GHz~40GHz	Oct. 02, 2014	Nov. 22, 2014 ~ Nov. 23, 2014	Oct. 01, 2015	Radiation (03CH05-HY)
Preamplifier	MITEQ	AMF-7D-0010 1800-30-10P	1590074	100kHz~18GHz	Jul. 07, 2014	Nov. 22, 2014 ~ Nov. 23, 2014	Jul. 06, 2015	Radiation (03CH05-HY)
Preamplifier	EMCI	EMC011830	980148	DC~18GHz	Jun. 23, 2014	Nov. 22, 2014 ~ Nov. 23, 2014	Jun. 22, 2015	Radiation (03CH05-HY)
Preamplifier	COM-POWER	PA-103	161075	9kHz~30MHz	Apr. 15, 2014	Nov. 22, 2014 ~ Nov. 23, 2014	Apr. 14, 2015	Radiation (03CH05-HY)
Preamplifier	Miteq	TTA0204	1872107	18GHz~40GHz	May 23, 2014	Nov. 22, 2014 ~ Nov. 23, 2014	May 22, 2015	Radiation (03CH05-HY)
Turn Table	HD	HD100	420/611	0 - 360 degree	N/A	Nov. 22, 2014 ~ Nov. 23, 2014	N/A	Radiation (03CH05-HY)
Antenna Mast	HD	HD100	240/666	1 m - 4 m	N/A	Nov. 22, 2014 ~ Nov. 23, 2014	N/A	Radiation (03CH05-HY)
Loop Antenna	R&S	HFH2-Z2	100315	9 kHz~30 MHz	Jul. 28, 2014	Nov. 22, 2014 ~ Nov. 23, 2014	Jul. 27, 2015	Radiation (03CH05-HY)
EMI Test Receiver	Rohde & Schwarz	ESCS 30	100356	9kHz ~ 2.75GHz	Nov. 12, 2014	Nov. 21, 2014	Nov. 11, 2015	Conduction (CO05-HY)
LISN (for auxiliary equipment)	Rohde & Schwarz	ENV216	100081	9kHz ~ 30MHz	Dec. 12, 2013	Nov. 21, 2014	Dec. 11, 2014	Conduction (CO05-HY)
LISN	Rohde & Schwarz	ENV216	100080	9kHz ~ 30MHz	Dec. 04, 2013	Nov. 21, 2014	Dec. 03, 2014	Conduction (CO05-HY)
AC Power Source	ChainTek	APC-1000W	N/A	N/A	N/A	Nov. 21, 2014	N/A	Conduction (CO05-HY)



5 Uncertainty of Evaluation

Uncertainty of Conducted Emission Measurement (150kHz ~ 30MHz)

Measuring Uncertainty for a Level of Confidence of 95% ($U = 2Uc(y)$)	2.26
---	------

Uncertainty of Radiated Emission Measurement (30 MHz ~ 1000 MHz)

Measuring Uncertainty for a Level of Confidence of 95% ($U = 2Uc(y)$)	5.1
---	-----



Appendix A. Radiated Spurious Emission

Test Engineer :	Citta Ke and Kyle Jhuang	Temperature :	23~24°C
		Relative Humidity :	49~51%

15C 2.4GHz 2400~2483.5MHz

WIFI 802.11b (Band Edge @ 3m)

WIFI	Note	Frequency	Level	Over	Limit	Read	Antenna	Cable	Preamp	Ant	Table	Peak	Pol.	
Ant.				Limit	Line	Level	Factor	Loss	Factor	Pos	Pos	Avg.		
1		(MHz)	(dBμV/m)	(dB)	(dBμV/m)	(dBμV)	(dB/m)	(dB)	(dB)	(cm)	(deg)	(P/A)	(H/V)	
802.11b CH 01 2412MHz		2389.11	54.44	-19.56	74	50.7	32.77	4.62	33.65	102	151	P	H	
		2390	43.1	-10.9	54	39.36	32.77	4.62	33.65	102	151	A	H	
	*	2411	109.26	-	-	105.43	32.81	4.65	33.63	102	151	P	H	
	*	2411	104.33	-	-	100.5	32.81	4.65	33.63	102	151	A	H	
													H	
														H
			2377.86	55.11	-18.89	74	51.44	32.73	4.6	33.66	102	307	P	V
			2390	41.76	-12.24	54	38.02	32.77	4.62	33.65	102	307	A	V
	*		2411	101.58	-	-	97.75	32.81	4.65	33.63	102	307	P	V
	*		2411	96.72	-	-	92.89	32.81	4.65	33.63	102	307	A	V
														V
														V
Remark	1. No other spurious found. 2. All results are PASS against Peak and Average limit line.													



WIFI	Note	Frequency	Level	Over	Limit	Read	Antenna	Cable	Preamp	Ant	Table	Peak	Pol.
Ant.				Limit	Line	Level	Factor	Loss	Factor	Pos	Pos	Avg.	
1		(MHz)	(dBμV/m)	(dB)	(dBμV/m)	(dBμV)	(dB/m)	(dB)	(dB)	(cm)	(deg)	(P/A)	(H/V)
802.11b CH 06 2437MHz		2376.6	55.32	-18.68	74	51.65	32.73	4.6	33.66	100	154	P	H
		2389.74	41.83	-12.17	54	38.09	32.77	4.62	33.65	100	154	A	H
	*	2438	110.41	-	-	106.44	32.89	4.68	33.6	100	154	P	H
	*	2438	105.27	-	-	101.3	32.89	4.68	33.6	100	154	A	H
		2484.56	55.61	-18.39	74	51.49	32.96	4.73	33.57	100	154	P	H
		2483.76	42.36	-11.64	54	38.24	32.96	4.73	33.57	100	154	A	H
		2382.36	55.34	-18.66	74	51.65	32.73	4.62	33.66	100	306	P	V
		2388.66	41.78	-12.22	54	38.04	32.77	4.62	33.65	100	306	A	V
	*	2436	100.48	-	-	96.57	32.85	4.68	33.62	100	306	P	V
	*	2436	95.81	-	-	91.9	32.85	4.68	33.62	100	306	A	V
		2486.36	55.53	-18.47	74	51.41	32.96	4.73	33.57	100	306	P	V
		2485.44	42.18	-11.82	54	38.06	32.96	4.73	33.57	100	306	A	V
	802.11b CH 11 2462MHz	*	2463	108.48	-	-	104.45	32.92	4.7	33.59	100	154	P
*		2463	103.35	-	-	99.32	32.92	4.7	33.59	100	154	A	H
		2484.32	56.59	-17.41	74	52.47	32.96	4.73	33.57	100	154	P	H
		2483.52	43.55	-10.45	54	39.43	32.96	4.73	33.57	100	154	A	H
													H
													H
*		2463	100.8	-	-	96.77	32.92	4.7	33.59	100	298	P	V
*		2463	95.18	-	-	91.15	32.92	4.7	33.59	100	298	A	V
		2489.68	55.67	-18.33	74	51.5	33	4.73	33.56	100	298	P	V
		2483.52	42.29	-11.71	54	38.17	32.96	4.73	33.57	100	298	A	V

Remark
 1. No other spurious found.
 2. All results are PASS against Peak and Average limit line.



15C 2.4GHz 2400~2483.5MHz

WIFI 802.11b (Harmonic @ 3m)

WIFI	Note	Frequency	Level	Over	Limit	Read	Antenna	Cable	Preamp	Ant	Table	Peak	Pol.
Ant.				Limit	Line	Level	Factor	Loss	Factor	Pos	Pos	Avg.	
1		(MHz)	(dBμV/m)	(dB)	(dBμV/m)	(dBμV)	(dB/m)	(dB)	(dB)	(cm)	(deg)	(P/A)	(H/V)
802.11b CH 01 2412MHz		4824	48.59	-25.41	74	65.63	35.03	6.54	58.61	100	0	P	H
													H
													H
													H
		4824	52.21	-21.79	74	69.25	35.03	6.54	58.61	100	0	P	V
													V
													V
													V
802.11b CH 06 2437MHz		4874	50.87	-23.13	74	67.81	35.02	6.56	58.52	100	0	P	H
		7311	41.93	-32.07	74	55.46	36.39	8.24	58.16	100	0	P	H
													H
													H
		4874	53.65	-20.35	74	70.59	35.02	6.56	58.52	100	0	P	V
		7311	41.56	-32.44	74	55.09	36.39	8.24	58.16	100	0	P	V
													V
													V
802.11b CH 11 2462MHz		4924	50.05	-23.95	74	66.86	35.01	6.6	58.42	100	0	P	H
		7386	41.64	-32.36	74	55.2	36.44	8.31	58.31	100	0	P	H
													H
													H
		4924	51.16	-22.84	74	67.97	35.01	6.6	58.42	100	0	P	V
		7386	41.68	-32.32	74	55.24	36.44	8.31	58.31	100	0	P	V
													V
													V
Remark	1. No other spurious found. 2. All results are PASS against Peak and Average limit line.												



15C 2.4GHz 2400~2483.5MHz
WIFI 802.11g (Band Edge @ 3m)

WIFI	Note	Frequency	Level	Over	Limit	Read	Antenna	Cable	Preamp	Ant	Table	Peak	Pol.	
Ant.				Limit	Line	Level	Factor	Loss	Factor	Pos	Pos	Avg.		
1		(MHz)	(dBμV/m)	(dB)	(dBμV/m)	(dBμV)	(dB/m)	(dB)	(dB)	(cm)	(deg)	(P/A)	(H/V)	
802.11g CH 01 2412MHz		2390	70	-4	74	66.26	32.77	4.62	33.65	102	150	P	H	
		2390	50.38	-3.62	54	46.64	32.77	4.62	33.65	102	150	A	H	
	*	2410	110.17	-	-	106.34	32.81	4.65	33.63	102	150	P	H	
	*	2410	99.15	-	-	95.32	32.81	4.65	33.63	102	150	A	H	
													H	
													H	
			2390	58.04	-15.96	74	54.3	32.77	4.62	33.65	100	307	P	V
			2390	43.25	-10.75	54	39.51	32.77	4.62	33.65	100	307	A	V
	*		2410	100	-	-	96.17	32.81	4.65	33.63	100	307	P	V
	*		2410	88.64	-	-	84.81	32.81	4.65	33.63	100	307	A	V
													V	
													V	
	802.11g CH 06 2437MHz		2349.87	54.9	-19.1	74	51.36	32.66	4.57	33.69	100	150	P	H
			2390	41.9	-12.1	54	38.16	32.77	4.62	33.65	100	150	A	H
*		2439	111.82	-	-	107.85	32.89	4.68	33.6	100	150	P	H	
*		2439	100.97	-	-	97	32.89	4.68	33.6	100	150	A	H	
		2484.56	58.38	-15.62	74	54.26	32.96	4.73	33.57	100	150	P	H	
		2483.52	43.32	-10.68	54	39.2	32.96	4.73	33.57	100	150	A	H	
		2318.01	55.1	-18.9	74	51.63	32.62	4.55	33.7	100	309	P	V	
		2389.92	41.74	-12.26	54	38	32.77	4.62	33.65	100	309	A	V	
*		2439	99.37	-	-	95.4	32.89	4.68	33.6	100	309	P	V	
*		2439	88.24	-	-	84.27	32.89	4.68	33.6	100	309	A	V	
		2488.24	54.98	-19.02	74	50.81	33	4.73	33.56	100	309	P	V	
		2483.56	42.2	-11.8	54	38.08	32.96	4.73	33.57	100	309	A	V	
Remark	1. No other spurious found. 2. All results are PASS against Peak and Average limit line.													



WIFI	Note	Frequency	Level	Over	Limit	Read	Antenna	Cable	Preamp	Ant	Table	Peak	Pol.	
Ant.				Limit	Line	Level	Factor	Loss	Factor	Pos	Pos	Avg.		
1		(MHz)	(dBμV/m)	(dB)	(dBμV/m)	(dBμV)	(dB/m)	(dB)	(dB)	(cm)	(deg)	(P/A)	(H/V)	
802.11g CH 11 2462MHz	*	2464	108.39	-	-	104.36	32.92	4.7	33.59	100	150	P	H	
	*	2464	97.05	-	-	93.02	32.92	4.7	33.59	100	150	A	H	
		2483.68	72.27	-1.73	74	68.15	32.96	4.73	33.57	100	150	P	H	
		2483.52	50.88	-3.12	54	46.76	32.96	4.73	33.57	100	150	A	H	
													H	
														H
	*	2464	99.07	-	-	95.04	32.92	4.7	33.59	100	308	P	V	
	*	2464	87.93	-	-	83.9	32.92	4.7	33.59	100	308	A	V	
		2483.52	59.91	-14.09	74	55.79	32.96	4.73	33.57	100	308	P	V	
		2483.52	43.9	-10.1	54	39.78	32.96	4.73	33.57	100	308	A	V	
														V
														V
Remark	1. No other spurious found. 2. All results are PASS against Peak and Average limit line.													



15C 2.4GHz 2400~2483.5MHz

WIFI 802.11g (Harmonic @ 3m)

WIFI	Note	Frequency	Level	Over	Limit	Read	Antenna	Cable	Preamp	Ant	Table	Peak	Pol.	
Ant.				Limit	Line	Level	Factor	Loss	Factor	Pos	Pos	Avg.		
1		(MHz)	(dBμV/m)	(dB)	(dBμV/m)	(dBμV)	(dB/m)	(dB)	(dB)	(cm)	(deg)	(P/A)	(H/V)	
802.11g CH 01 2412MHz		4824	43.89	-30.11	74	60.93	35.03	6.54	58.61	100	0	P	H	
													H	
													H	
													H	
		4824	48.35	-25.65	74	65.39	35.03	6.54	58.61	100	0	P	V	
														V
														V
														V
802.11g CH 06 2437MHz		4874	47.44	-26.56	74	64.38	35.02	6.56	58.52	100	0	P	H	
		7311	41.67	-32.33	74	55.2	36.39	8.24	58.16	100	0	P	H	
													H	
													H	
		4874	48.85	-25.15	74	65.79	35.02	6.56	58.52	100	0	P	V	
		7311	41.32	-32.68	74	54.85	36.39	8.24	58.16	100	0	P	V	
														V
														V
802.11g CH 11 2462MHz		4924	44.34	-29.66	74	61.15	35.01	6.6	58.42	100	0	P	H	
		7386	41.34	-32.66	74	54.9	36.44	8.31	58.31	100	0	P	H	
													H	
													H	
		4924	44.79	-29.21	74	61.6	35.01	6.6	58.42	100	0	P	V	
		7386	41.58	-32.42	74	55.14	36.44	8.31	58.31	100	0	P	V	
														V
														V
Remark	1. No other spurious found. 2. All results are PASS against Peak and Average limit line.													



15C 2.4GHz 2400~2483.5MHz
WIFI 802.11n HT20 (Band Edge @ 3m)

WIFI	Note	Frequency	Level	Over	Limit	Read	Antenna	Cable	Preamp	Ant	Table	Peak	Pol.	
Ant.				Limit	Line	Level	Factor	Loss	Factor	Pos	Pos	Avg.		
1		(MHz)	(dBμV/m)	(dB)	(dBμV/m)	(dBμV)	(dB/m)	(dB)	(dB)	(cm)	(deg)	(P/A)	(H/V)	
802.11n HT20 CH 01 2412MHz		2389.38	72.45	-1.55	74	68.71	32.77	4.62	33.65	102	157	P	H	
		2390	49.96	-4.04	54	46.22	32.77	4.62	33.65	102	157	A	H	
	*	2410	109.23	-	-	105.4	32.81	4.65	33.63	102	157	P	H	
	*	2410	97.57	-	-	93.74	32.81	4.65	33.63	102	157	A	H	
													H	
														H
			2389.83	61.98	-12.02	74	58.24	32.77	4.62	33.65	102	303	P	V
			2390	43.94	-10.06	54	40.2	32.77	4.62	33.65	102	303	A	V
	*		2410	99.13	-	-	95.3	32.81	4.65	33.63	102	303	P	V
	*		2410	87.68	-	-	83.85	32.81	4.65	33.63	102	303	A	V
													V	
													V	
802.11n HT20 CH 06 2437MHz		2342.85	54.75	-19.25	74	51.21	32.66	4.57	33.69	100	150	P	H	
		2385.51	41.86	-12.14	54	38.12	32.77	4.62	33.65	100	150	A	H	
	*	2439	111.01	-	-	107.04	32.89	4.68	33.6	100	150	P	H	
	*	2439	100	-	-	96.03	32.89	4.68	33.6	100	150	A	H	
		2484.08	59.62	-14.38	74	55.5	32.96	4.73	33.57	100	150	P	H	
		2483.52	43.52	-10.48	54	39.4	32.96	4.73	33.57	100	150	A	H	
		2333.22	54.89	-19.11	74	51.4	32.62	4.57	33.7	102	293	P	V	
		2389.83	41.56	-12.44	54	37.82	32.77	4.62	33.65	102	293	A	V	
	*		2439	98.65	-	-	94.68	32.89	4.68	33.6	102	293	P	V
	*		2439	87.83	-	-	83.86	32.89	4.68	33.6	102	293	A	V
		2486.2	54.93	-19.07	74	50.81	32.96	4.73	33.57	102	293	P	V	
		2483.56	42.18	-11.82	54	38.06	32.96	4.73	33.57	102	293	A	V	
Remark	1. No other spurious found. 2. All results are PASS against Peak and Average limit line.													



WIFI	Note	Frequency	Level	Over	Limit	Read	Antenna	Cable	Preamp	Ant	Table	Peak	Pol.
Ant.				Limit	Line	Level	Factor	Loss	Factor	Pos	Pos	Avg.	
1		(MHz)	(dBμV/m)	(dB)	(dBμV/m)	(dBμV)	(dB/m)	(dB)	(dB)	(cm)	(deg)	(P/A)	(H/V)
802.11n HT20 CH 11 2462MHz	*	2464	107.29	-	-	103.26	32.92	4.7	33.59	100	152	P	H
	*	2464	95.53	-	-	91.5	32.92	4.7	33.59	100	152	A	H
		2483.8	71.59	-2.41	74	67.47	32.96	4.73	33.57	100	152	P	H
		2483.52	50.84	-3.16	54	46.72	32.96	4.73	33.57	100	152	A	H
													H
													H
	*	2464	98.28	-	-	94.25	32.92	4.7	33.59	100	295	P	V
	*	2464	87.35	-	-	83.32	32.92	4.7	33.59	100	295	A	V
		2483.56	62	-12	74	57.88	32.96	4.73	33.57	100	295	P	V
		2483.52	43.91	-10.09	54	39.79	32.96	4.73	33.57	100	295	A	V
												V	
												V	
Remark	1. No other spurious found. 2. All results are PASS against Peak and Average limit line.												



15C 2.4GHz 2400~2483.5MHz

WIFI 802.11n HT20 (Harmonic @ 3m)

WIFI	Note	Frequency	Level	Over	Limit	Read	Antenna	Cable	Preamp	Ant	Table	Peak	Pol.	
Ant.				Limit	Line	Level	Factor	Loss	Factor	Pos	Pos	Avg.		
1		(MHz)	(dBμV/m)	(dB)	(dBμV/m)	(dBμV)	(dB/m)	(dB)	(dB)	(cm)	(deg)	(P/A)	(H/V)	
802.11n HT20 CH 01 2412MHz		4824	42.07	-31.93	74	59.11	35.03	6.54	58.61	100	0	P	H	
													H	
													H	
													H	
		4824	45.88	-28.12	74	62.92	35.03	6.54	58.61	100	0	P	V	
														V
														V
802.11n HT20 CH 06 2437MHz		4874	48.03	-25.97	74	64.97	35.02	6.56	58.52	100	0	P	H	
		7311	41.49	-32.51	74	55.02	36.39	8.24	58.16	100	0	P	H	
													H	
													H	
		4874	49.38	-24.62	74	66.32	35.02	6.56	58.52	100	0	P	V	
		7311	41.72	-32.28	74	55.25	36.39	8.24	58.16	100	0	P	V	
														V
802.11n HT20 CH 11 2462MHz		4924	42.86	-31.14	74	59.67	35.01	6.6	58.42	100	0	P	H	
		7386	41.44	-32.56	74	55	36.44	8.31	58.31	100	0	P	H	
													H	
													H	
		4924	44.82	-29.18	74	61.63	35.01	6.6	58.42	100	0	P	V	
		7386	42.62	-31.38	74	56.18	36.44	8.31	58.31	100	0	P	V	
														V
Remark	1. No other spurious found.													
	2. All results are PASS against Peak and Average limit line.													



15C Emission below 1GHz

2.4GHz WIFI 802.11b (LF)

WIFI	Note	Frequency	Level	Over	Limit	Read	Antenna	Cable	Preamp	Ant	Table	Peak	Pol.	
Ant.				Limit	Line	Level	Factor	Loss	Factor	Pos	Pos	Avg.		
1		(MHz)	(dBμV/m)	(dB)	(dBμV/m)	(dBμV)	(dB/m)	(dB)	(dB)	(cm)	(deg)	(P/A)	(H/V)	
2.4GHz 802.11b LF		55.92	23.67	-16.33	40	48.32	6.3	0.85	31.8	100	155	P	H	
		166.35	24.33	-19.17	43.5	45	9.76	1.35	31.78	-	-	P	H	
		232.77	29.02	-16.98	46	48.74	10.46	1.59	31.77	-	-	P	H	
		500.2	26.79	-19.21	46	38.45	18	2.23	31.89	-	-	P	H	
		752.9	27.75	-18.25	46	34.78	22.2	2.75	31.98	-	-	P	H	
		960.8	26.84	-27.16	54	29.79	24.89	3.11	30.95	-	-	P	H	
														H
														H
														H
														H
														H
														H
														H
			60.51	27.25	-12.75	40	52.28	5.9	0.87	31.8	-	-	P	V
			124.5	26.56	-16.94	43.5	45.56	11.58	1.2	31.78	-	-	P	V
			170.94	28.78	-14.72	43.5	49.57	9.62	1.37	31.78	-	-	P	V
			526.8	24.29	-21.71	46	35.77	18.17	2.28	31.93	-	-	P	V
			798.4	27.17	-18.83	46	34.26	22	2.83	31.92	-	-	P	V
			895	33.95	-12.05	46	39.2	23.2	3	31.45	100	96	P	V
														V
													V	
													V	
													V	
													V	
													V	
Remark	1. No other spurious found. 2. All results are PASS against limit line.													



15C Emission below 1GHz

2.4GHz WIFI 802.11g (LF)

WIFI	Note	Frequency	Level	Over	Limit	Read	Antenna	Cable	Preamp	Ant	Table	Peak	Pol.	
Ant.				Limit	Line	Level	Factor	Loss	Factor	Pos	Pos	Avg.		
1		(MHz)	(dBμV/m)	(dB)	(dBμV/m)	(dBμV)	(dB/m)	(dB)	(dB)	(cm)	(deg)	(P/A)	(H/V)	
2.4GHz 802.11g LF		166.35	24.29	-19.21	43.5	44.96	9.76	1.35	31.78	-	-	P	H	
		232.5	29.54	-16.46	46	49.26	10.46	1.59	31.77	-	-	P	H	
		266.25	22.66	-23.34	46	39.53	13.2	1.7	31.77	-	-	P	H	
		753.6	28.73	-17.27	46	35.76	22.2	2.75	31.98	-	-	P	H	
		841.8	30.37	-15.63	46	35.97	23.2	2.91	31.71	100	46	P	H	
		992.3	26.78	-27.22	54	29.48	24.78	3.22	30.7	-	-	P	H	
														H
														H
														H
														H
														H
														H
														H
			124.23	26.93	-16.57	43.5	45.93	11.58	1.2	31.78	-	-	P	V
			173.91	28.65	-14.85	43.5	49.67	9.38	1.38	31.78	100	189	P	V
			232.5	24.73	-21.27	46	44.45	10.46	1.59	31.77	-	-	P	V
			525.4	23.96	-22.04	46	35.45	18.16	2.28	31.93	-	-	P	V
			797	27.13	-18.87	46	34.22	22	2.83	31.92	-	-	P	V
			860.7	30.92	-15.08	46	36.5	23.1	2.94	31.62	-	-	P	V
														V
													V	
													V	
													V	
													V	
													V	
Remark	1. No other spurious found. 2. All results are PASS against limit line.													



15C Emission below 1GHz

2.4GHz WIFI 802.11n HT20 (LF)

WIFI	Note	Frequency	Level	Over	Limit	Read	Antenna	Cable	Preamp	Ant	Table	Peak	Pol.	
Ant.				Limit	Line	Level	Factor	Loss	Factor	Pos	Pos	Avg.		
1		(MHz)	(dBμV/m)	(dB)	(dBμV/m)	(dBμV)	(dB/m)	(dB)	(dB)	(cm)	(deg)	(P/A)	(H/V)	
2.4GHz 802.11n HT20 LF		131.79	19.48	-24.02	43.5	38.17	11.86	1.23	31.78	-	-	P	H	
		166.08	24.13	-19.37	43.5	44.78	9.78	1.35	31.78	-	-	P	H	
		232.5	28.93	-17.07	46	48.65	10.46	1.59	31.77	-	-	P	H	
		499.5	20.94	-25.06	46	32.61	17.99	2.23	31.89	-	-	P	H	
		732.6	25.82	-20.18	46	33.15	21.96	2.71	32	-	-	P	H	
		842.5	31.07	-14.93	46	36.67	23.2	2.91	31.71	100	128	P	H	
														H
														H
														H
														H
														H
														H
														H
														H
														H
			60.78	27.64	-12.36	40	52.64	5.92	0.88	31.8	100	133	P	V
			174.72	28.82	-14.68	43.5	49.92	9.3	1.38	31.78	-	-	P	V
			232.5	24.06	-21.94	46	43.78	10.46	1.59	31.77	-	-	P	V
			531.7	23.53	-22.47	46	34.93	18.25	2.29	31.94	-	-	P	V
			743.1	29.63	-16.37	46	36.69	22.2	2.73	31.99	-	-	P	V
		841.1	30.31	-15.69	46	35.93	23.2	2.9	31.72	-	-	P	V	
													V	
													V	
													V	
													V	
													V	
													V	
													V	
Remark	1. No other spurious found. 2. All results are PASS against limit line.													



Note symbol

*	Fundamental Frequency which can be ignored. However, the level of any unwanted emissions shall not exceed the level of the fundamental frequency per 15.209(c).
!	Test result is over limit line.
P/A	Peak or Average
H/V	Horizontal or Vertical



A calculation example for radiated spurious emission is shown as below:

WIFI	Note	Frequency	Level	Over	Limit	Read	Antenna	Cable	Preamp	Ant	Table	Peak	Pol.
Ant.				Limit	Line	Level	Factor	Loss	Factor	Pos	Pos	Avg.	
1+2		(MHz)	(dBμV/m)	(dB)	(dBμV/m)	(dBμV)	(dB/m)	(dB)	(dB)	(cm)	(deg)	(P/A)	(H/V)
802.11b		2390	55.45	-18.55	74	54.51	32.22	4.58	35.86	103	308	P	H
CH 01													
2412MHz		2390	43.54	-10.46	54	42.6	32.22	4.58	35.86	103	308	A	H

- 1. Level(dBμV/m) =
Antenna Factor(dB/m) + Cable Loss(dB) + Read Level(dBμV) - Preamp Factor(dB)
- 2. Over Limit(dB) = Level(dBμV/m) – Limit Line(dBμV/m)

For Peak Limit @ 2390MHz:

- 1. Level(dBμV/m)
= Antenna Factor(dB/m) + Cable Loss(dB) + Read Level(dBμV) - Preamp Factor(dB)
= 32.22(dB/m) + 4.58(dB) + 54.51(dBμV) – 35.86 (dB)
= 55.45 (dBμV/m)
- 2. Over Limit(dB)
= Level(dBμV/m) – Limit Line(dBμV/m)
= 55.45(dBμV/m) – 74(dBμV/m)
= -18.55(dB)

For Average Limit @ 2390MHz:

- 1. Level(dBμV/m)
= Antenna Factor(dB/m) + Cable Loss(dB) + Read Level(dBμV) - Preamp Factor(dB)
= 32.22(dB/m) + 4.58(dB) + 42.6(dBμV) – 35.86 (dB)
= 43.54 (dBμV/m)
- 2. Over Limit(dB)
= Level(dBμV/m) – Limit Line(dBμV/m)
= 43.54(dBμV/m) – 54(dBμV/m)
= -10.46(dB)

Both peak and average measured complies with the limit line, so test result is “PASS”.