



FCC RF Test Report

APPLICANT : Motorola Mobility, LLC
EQUIPMENT : Mobile Cellular Phone
BRAND NAME : Motorola
MODEL NAME : 4242
FCC ID : IHDT56QC7
STANDARD : 47 CFR Part 2, 22(H), 24(E), 27
CLASSIFICATION : PCS Licensed Transmitter Held to Ear (PCE)

The product was received on Nov. 15, 2014 and completely tested on Dec. 14, 2014. We, SPORTON INTERNATIONAL INC., would like to declare that the tested sample has been evaluated in accordance with the test procedures given in ANSI / TIA / EIA-603-C-2004 and the testing has shown the tested sample to be in compliance with the applicable technical standards.

The test results in this report apply exclusively to the tested model / sample. Without written approval of SPORTON INTERNATIONAL INC., the test report shall not be reproduced except in full.

Reviewed by: Joseph Lin / Supervisor

Approved by: Jones Tsai / Manager



SPORTON INTERNATIONAL INC.

No. 52, Hwa Ya 1st Rd., Hwa Ya Technology Park, Kwei-Shan Hsiang, Tao Yuan Hsien, Taiwan, R.O.C.

SPORTON INTERNATIONAL INC.

TEL : 886-3-327-3456

FAX : 886-3-328-4978

FCC ID : IHDT56QC7

Page Number : 1 of 29

Report Issued Date : Jan. 08, 2015

Report Version : Rev. 01

Report Template No.: BU5-FGLTE Version 1.3



TABLE OF CONTENTS

REVISION HISTORY 4

SUMMARY OF TEST RESULT 5

1 GENERAL DESCRIPTION 7

 1.1 Applicant 7

 1.2 Manufacturer 7

 1.3 Product Feature of Equipment Under Test 7

 1.4 Product Specification subjective to this standard 8

 1.5 Modification of EUT 8

 1.6 Emission Designator 9

 1.7 Testing Location 11

 1.8 Applicable Standards 11

2 TEST CONFIGURATION OF EQUIPMENT UNDER TEST 12

 2.1 Test Mode 12

 2.2 Connection Diagram of Test System 15

 2.3 Support Unit used in test configuration and system 15

 2.4 Measurement Results Explanation Example 15

3 CONDUCTED TEST ITEMS 16

 3.1 Measuring Instruments 16

 3.2 Test Setup 16

 3.3 Test Result of Conducted Test 16

 3.4 Conducted Output Power 17

 3.5 Peak-to-Average Ratio 18

 3.6 Occupied Bandwidth 19

 3.7 Conducted Band Edge 20

 3.8 Conducted Spurious Emission 22

 3.9 Frequency Stability 23

4 RADIATED TEST ITEMS 24

 4.1 Measuring Instruments 24

 4.2 Test Setup 24

 4.3 Test Result of Radiated Test 24

 4.4 Effective Radiated Power and Effective Isotropic Radiated Power 25

 4.5 Radiated Spurious Emission 27

5 LIST OF MEASURING EQUIPMENT 28

6 UNCERTAINTY OF EVALUATION 29

APPENDIX A. TEST RESULTS OF CONDUCTED TEST



APPENDIX B. TEST RESULTS OF RADIATED TEST



SUMMARY OF TEST RESULT

Report Section	FCC Rule	Description	Limit	Result	Remark
3.4	§2.1046	Conducted Output Power	Reporting Only	PASS	-
3.5	§24.232(d)	Peak-to-Average Ratio	<13 dB	PASS	-
3.6	§2.1049 §22.917(b) §24.238(b) §27.53(h)(3) §27.53(m)(6)	Occupied Bandwidth	Reporting Only	PASS	-
3.7	§2.1051 §22.917(a) §24.238(a) §27.53(g)	Conducted Band Edge Measurement (Band 2) (Band 4) (Band 5) (Band 12) (Band 17) (Band 25) (Band 26) (Band 41)	< 43+10log ₁₀ (P[Watts])	PASS	-
	§2.1051 §27.53(m)(4)	Conducted Band Edge Measurement (Band 41)	< 55+10log ₁₀ (P[Watts])		
3.8	§2.1051 §22.917(a) §24.238(a) §27.53(g)	Conducted Spurious Emission (Band 2) (Band 4) (Band 5) (Band 12) (Band 17) (Band 25) (Band 26)	< 43+10log ₁₀ (P[Watts])	PASS	-
	§2.1051 §27.53(m)(4)	Conducted Spurious Emission (Band 41)	< 55+10log ₁₀ (P[Watts])		



Report Section	FCC Rule	Description	Limit	Result	Remark
3.9	§2.1055 §22.355 §24.235 §27.54	Frequency Stability Temperature & Voltage	< 2.5 ppm for Part 22 Within Authorized Band	PASS	-
4.4	§22.913(a)(2)	Effective Radiated Power (Band 5) (Band 26)	ERP < 7 Watt	PASS	-
	§27.50(c)(10)	Effective Radiated Power (Band 12) (Band 17)	ERP < 3 Watt		
	§24.232(c) §27.50(h)(2)	Equivalent Isotropic Radiated Power (Band 2)(Band 25) (Band 41)	EIRP < 2Watt		
	§27.50(d)(4)	Equivalent Isotropic Radiated Power (Band 4)	EIRP < 1Watt		
4.5	§2.1053 §22.917(a) §24.238(a) §27.53(g) §27.53(h)	Radiated Spurious Emission (Band 2) (Band 4) (Band 5) (Band 12) (Band 17) (Band 25) (Band 26)	< 43+10log ₁₀ (P[Watts])	PASS	Under limit 12.76 dB at 10740.000 MHz
	§2.1053 §27.53(m)(4)	Radiated Spurious Emission (Band 41)	< 55+10log ₁₀ (P[Watts])		



1 General Description

1.1 Applicant

Motorola Mobility, LLC
222 W. Merchandise Mart Plaza, Chicago IL 60654 USA

1.2 Manufacturer

Motorola Mobility, LLC
222 W. Merchandise Mart Plaza, Chicago IL 60654 USA

1.3 Product Feature of Equipment Under Test

Product Feature	
Equipment	Mobile Cellular Phone
Brand Name	Motorola
Model Name	4242
FCC ID	IHDT56QC7
IMEI Code	990005460018022
EUT supports Radios application	GSM/EGPRS/CDMA/EV-DO/WCDMA/HSPA/LTE WLAN 11b/g/n HT20 Bluetooth v2.1 + EDR Bluetooth v4.0 - LE
HW Version	P2B
EUT Stage	Identical Prototype

Accessory List	
AC Adapter	Brand Name : Motorola
	Model Name : SPN5810A



1.4 Product Specification subjective to this standard

Product Specification subjective to this standard	
Tx Frequency	LTE Band 2 : 1850.7 MHz ~ 1909.3 MHz LTE Band 4 : 1710.7 MHz ~ 1754.3 MHz LTE Band 5 : 824.7 MHz ~ 848.3 MHz LTE Band 12 : 699 MHz ~ 716 MHz LTE Band 17 : 706.5 MHz ~ 713.5 MHz LTE Band 25 : 1850.7MHz ~ 1914.3 MHz LTE Band 26 : 824.7MHz ~ 848.3 MHz LTE Band 41 : 2498.5MHz ~ 2687.5 MHz
Rx Frequency	LTE Band 2 : 1930.7 MHz ~ 1989.3 MHz LTE Band 4 : 2110.7 MHz ~ 2154.3 MHz LTE Band 5 : 869.7 MHz ~ 893.3 MHz LTE Band 12 : 729 MHz ~ 746 MHz LTE Band 17 : 736.5 MHz ~ 743.5 MHz LTE Band 25 : 1930.7MHz ~ 1994.3 MHz LTE Band 26 : 869.7MHz ~ 893.3 MHz LTE Band 41 : 2498.5MHz ~ 2687.5 MHz
Bandwidth	LTE Band 2 : 1.4MHz / 3MHz / 5MHz / 10MHz / 15MHz / 20MHz LTE Band 4 : 1.4MHz / 3MHz / 5MHz / 10MHz / 15MHz / 20MHz LTE Band 5 : 1.4MHz / 3MHz / 5MHz / 10MHz LTE Band 12 : 1.4MHz / 3MHz / 5MHz / 10MHz LTE Band 17 : 5MHz / 10MHz LTE Band 25 : 1.4MHz / 3MHz / 5MHz / 10MHz / 15MHz / 20MHz LTE Band 26 : 1.4MHz / 3MHz / 5MHz / 10MHz / 15MHz LTE Band 41 : 5MHz / 10MHz / 15MHz / 20MHz
Maximum Output Power to Antenna	LTE Band 2 : 23.24 dBm LTE Band 4 : 23.61 dBm LTE Band 5 : 23.69 dBm LTE Band 12 : 23.95 dBm LTE Band 17 : 23.87 dBm LTE Band 25 : 23.40 dBm LTE Band 26 : 23.36 dBm LTE Band 41 : 22.81 dBm
Type of Modulation	QPSK / 16QAM

1.5 Modification of EUT

No modifications are made to the EUT during all test items.



1.6 Emission Designator

LTE Band 2		QPSK			16QAM		
BW(MHz)	Emission Designator (99%OBW)	Frequency Tolerance (ppm)	Maximum EIRP(W)	Emission Designator (99%OBW)	Frequency Tolerance (ppm)	Maximum EIRP(W)	
1.4	1.10	-	0.1791	1.11	-	0.0993	
3	2.72	-	0.1687	2.74	-	0.1057	
5	4.50	-	0.1641	4.51	-	0.1202	
10	9.12	0.0011	0.1671	9.06	-	0.1175	
15	13.50	-	0.1592	13.50	-	0.1014	
20	18.56	-	0.1589	18.56	-	0.1109	
LTE Band 25		QPSK			16QAM		
BW(MHz)	Emission Designator (99%OBW)	Frequency Tolerance (ppm)	Maximum EIRP(W)	Emission Designator (99%OBW)	Frequency Tolerance (ppm)	Maximum EIRP(W)	
1.4	1.10	-	0.1803	1.10	-	0.1164	
3	2.72	-	0.1845	2.73	-	0.1033	
5	4.50	-	0.1832	4.51	-	0.1285	
10	9.12	0.0011	0.1845	9.06	-	0.1268	
15	13.50	-	0.1734	13.50	-	0.1233	
20	18.52	-	0.1592	18.52	-	0.1349	
LTE Band 4		QPSK			16QAM		
BW(MHz)	Emission Designator (99%OBW)	Frequency Tolerance (ppm)	Maximum EIRP(W)	Emission Designator (99%OBW)	Frequency Tolerance (ppm)	Maximum EIRP(W)	
1.4	1.10	-	0.2323	1.10	-	0.1742	
3	2.74	-	0.2472	2.73	-	0.1683	
5	4.51	-	0.2377	4.51	-	0.1633	
10	9.12	0.0019	0.2307	9.06	-	0.1578	
15	13.47	-	0.2133	13.47	-	0.1622	
20	18.48	-	0.2168	18.52	-	0.1535	



LTE Band 5		QPSK			16QAM		
BW(MHz)	Emission Designator (99%OBW)	Frequency Tolerance (ppm)	Maximum ERP(W)	Emission Designator (99%OBW)	Frequency Tolerance (ppm)	Maximum ERP(W)	
1.4	1.10	-	0.1205	1.10	-	0.0853	
3	2.74	-	0.1276	2.72	-	0.0828	
5	4.51	-	0.1199	4.51	-	0.0796	
10	9.08	0.0029	0.1009	9.06	-	0.0824	
LTE Band 12		QPSK			16QAM		
BW(MHz)	Emission Designator (99%OBW)	Frequency Tolerance (ppm)	Maximum ERP(W)	Emission Designator (99%OBW)	Frequency Tolerance (ppm)	Maximum ERP(W)	
1.4	1.10	-	0.0536	1.10	-	0.0431	
3	2.72	-	0.0518	2.73	-	0.0399	
5	4.52	-	0.0463	4.51	-	0.0349	
10	9.14	0.0016	0.0471	9.08	-	0.0345	
LTE Band 17		QPSK			16QAM		
BW(MHz)	Emission Designator (99%OBW)	Frequency Tolerance (ppm)	Maximum ERP(W)	Emission Designator (99%OBW)	Frequency Tolerance (ppm)	Maximum ERP(W)	
5	4.51	-	0.0501	4.51	-	0.0381	
10	9.08	0.0015	0.0509	9.06	-	0.0385	
LTE Band 41		QPSK			16QAM		
BW(MHz)	Emission Designator (99%OBW)	Frequency Tolerance (ppm)	Maximum EIRP(W)	Emission Designator (99%OBW)	Frequency Tolerance (ppm)	Maximum EIRP(W)	
5	4.53	-	0.2944	4.51	-	0.2661	
10	9.08	0.0018	0.3214	9.06	-	0.2786	
15	13.47	-	0.4009	13.50	-	0.3184	
20	18.52	-	0.3221	18.40	-	0.2570	
LTE Band 26		QPSK			16QAM		
BW(MHz)	Emission Designator (99%OBW)	Frequency Tolerance (ppm)	Maximum ERP(W)	Emission Designator (99%OBW)	Frequency Tolerance (ppm)	Maximum ERP(W)	
1.4	1.10	-	0.1191	1.10	-	0.0774	
3	2.74	-	0.1146	2.72	-	0.0733	
5	4.51	-	0.1178	4.51	-	0.0818	
10	9.08	0.0029	0.1219	9.10	-	0.0752	
15	13.53	-	0.1042	13.53	-	0.0718	



1.7 Testing Location

Sporton Lab is accredited to ISO 17025 by Taiwan Accreditation Foundation (TAF code : 1190) and the FCC designation No. TW1022 under the FCC 2.948(e) by Mutual Recognition Agreement (MRA) in FCC Test.

Test Site	SPORTON INTERNATIONAL INC.	
Test Site Location	No. 52, Hwa Ya 1 st Rd., Hwa Ya Technology Park, Kwei-Shan Hsiang, Tao Yuan Hsien, Taiwan, R.O.C. TEL: +886-3-327-3456 FAX: +886-3-328-4978	
Test Site No.	Sporton Site No.	
	TH02-HY	03CH07-HY

1.8 Applicable Standards

According to the specifications of the manufacturer, the EUT must comply with the requirements of the following standards:

- ♦ 47 CFR Part 2, 22(H), 24(E), 27
- ♦ ANSI / TIA / EIA-603-C-2004
- ♦ FCC KDB 971168 D01 Power Meas. License Digital Systems v02r02

Remark:

1. All test items were verified and recorded according to the standards and without any deviation during the test.
2. This EUT has also been tested and complied with the requirements of FCC Part 15, Subpart B, recorded in a separate test report.



2 Test Configuration of Equipment Under Test

2.1 Test Mode

Antenna port conducted and radiated test items listed below are performed according to KDB 971168 D01 Power Meas. License Digital Systems v02r02 with maximum output power.

Radiated measurements are performed by rotating the EUT in three different orthogonal test planes to find the maximum emission.

Test Items	Band	Bandwidth (MHz)						Modulation		RB #			Test Channel		
		1.4	3	5	10	15	20	QPSK	16QAM	1	Half	Full	L	M	H
Max. Output Power	2	✓	✓	✓	✓	✓	✓	✓	✓	✓	✓	✓	✓	✓	✓
	4	✓	✓	✓	✓	✓	✓	✓	✓	✓	✓	✓	✓	✓	✓
	5	✓	✓	✓	✓	-	-	✓	✓	✓	✓	✓	✓	✓	✓
	26	✓	✓	✓	✓	✓	-	✓	✓	✓	✓	✓	✓	✓	✓
	12	✓	✓	✓	✓	-	-	✓	✓	✓	✓	✓	✓	✓	✓
	17	-	-	✓	✓	-	-	✓	✓	✓	✓	✓	✓	✓	✓
	25	✓	✓	✓	✓	✓	✓	✓	✓	✓	✓	✓	✓	✓	✓
	41			✓	✓	✓	✓	✓	✓	✓	✓	✓	✓	✓	✓
Peak-to-Average Ratio	2						✓	✓	✓	✓		✓	✓	✓	✓
	4						✓	✓	✓	✓		✓	✓	✓	✓
	5				✓	-	-	✓	✓	✓		✓	✓	✓	✓
	26					✓	-	✓	✓	✓		✓	✓	✓	✓
	12				✓	-	-	✓	✓	✓		✓	✓	✓	✓
	17	-	-		✓	-	-	✓	✓	✓		✓	✓	✓	✓
	25						✓	✓	✓	✓		✓	✓	✓	✓
	41	-	-				✓	✓	✓	✓		✓	✓	✓	✓



Test Items	Band	Bandwidth (MHz)						Modulation		RB #			Test Channel		
		1.4	3	5	10	15	20	QPSK	16QAM	1	Half	Full	L	M	H
26dB and 99% Bandwidth	2	v	v	v	v	v	v	v	v			v	v	v	v
	4	v	v	v	v	v	v	v	v			v	v	v	v
	5	v	v	v	v	-	-	v	v			v	v	v	v
	26	v	v	v	v	v	-	v	v			v	v	v	v
	12	v	v	v	v	-	-	v	v			v	v	v	v
	17	-	-	v	v	-	-	v	v			v	v	v	v
	25	v	v	v	v	v	v	v	v			v	v	v	v
	41	-	-	v	v	v	v	v	v			v	v	v	v
Conducted Band Edge	2	v	v	v	v	v	v	v	v	v		v	v		v
	4	v	v	v	v	v	v	v	v	v		v	v		v
	5	v	v	v	v	-	-	v	v	v		v	v		v
	26	v	v	v	v	v	-	v	v	v		v	v		v
	12	v	v	v	v	-	-	v	v	v		v	v		v
	17	-	-	v	v	-	-	v	v	v		v	v		v
	25	v	v	v	v	v	v	v	v	v		v	v		v
	41	-	-	v	v	v	v	v	v	v		v	v		v

Test Items	Band	Bandwidth (MHz)						Modulation		RB #			Test Channel		
		1.4	3	5	10	15	20	QPSK	16QAM	1	Half	Full	L	M	H
Conducted Spurious Emission	2	v	v	v	v	v	v	v	v	v			v	v	v
	4	v	v	v	v	v	v	v	v	v			v	v	v
	5	v	v	v	v	-	-	v	v	v			v	v	v
	26	v	v	v	v	v	-	v	v	v			v	v	v
	12	v	v	v	v	-	-	v	v	v			v	v	v
	17	-	-	v	v	-	-	v	v	v			v	v	v
	25	v	v	v	v	v	v	v	v	v			v	v	v
	41	-	-	v	v	v	v	v	v	v			v	v	v



Test Items	Band	Bandwidth (MHz)						Modulation		RB #			Test Channel		
		1.4	3	5	10	15	20	QPSK	16QAM	1	Half	Full	L	M	H
Frequency Stability	2				√			√				√		√	
	4				√			√				√		√	
	5				√	-	-	√				√		√	
	26				√		-	√				√		√	
	12				√	-	-	√				√		√	
	17	-	-		√	-	-	√				√		√	
	25				√			√				√		√	
	41	-	-		√			√				√		√	
E.R.P./E.I.R.P.	2	√	√	√	√	√	√	√	√	√			√	√	√
	4	√	√	√	√	√	√	√	√	√			√	√	√
	5	√	√	√	√	-	-	√	√	√			√	√	√
	26	√	√	√	√	√	-	√	√	√			√	√	√
	12	√	√	√	√	-	-	√	√	√			√	√	√
	17	-	-	√	√	-	-	√	√	√			√	√	√
	25	√	√	√	√	√	√	√	√	√			√	√	√
	41	-	-	√	√	√	√	√	√	√			√	√	√
Radiated Spurious Emission	2	√	√	√	√	√	√	√		√			√	√	√
	4	√	√	√	√	√	√	√		√			√	√	√
	5	√	√	√	√	-	-	√		√			√	√	√
	26	√	√	√	√	√	-	√		√			√	√	√
	12	√	√	√	√	-	-	√		√			√	√	√
	17	-	-	√	√	-	-	√		√			√	√	√
	25	√	√	√	√	√	√	√		√			√	√	√
	41	-	-	√	√	√	√	√		√			√	√	√
Note	<p>1. The mark "√" means that this configuration is chosen for testing</p> <p>2. The mark "-" means that this bandwidth is not supported.</p> <p>3. The device is investigated from 30MHz to 10 times of fundamental signal for radiated spurious emission test under different RB size/offset and modulations in exploratory test. Subsequently, only the worst case emissions are reported.</p>														

2.2 Connection Diagram of Test System

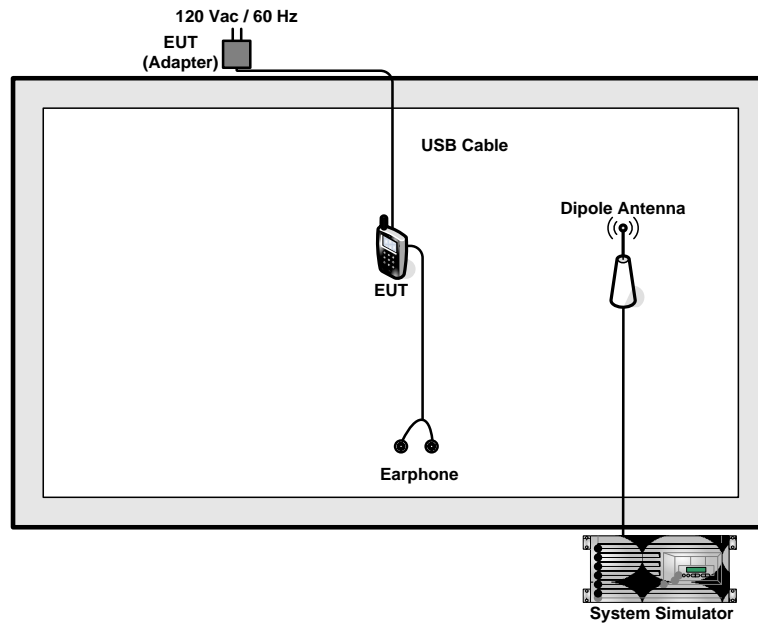

2.3 Support Unit used in test configuration and system

Item	Equipment	Trade Name	Model No.	FCC ID	Data Cable	Power Cord
1.	LTE Base Station	Anritsu	MT8820C	N/A	N/A	Unshielded, 1.8 m

2.4 Measurement Results Explanation Example

For all conducted test items:

The offset level is set in the spectrum analyzer to compensate the RF cable loss and attenuator factor between EUT conducted output port and spectrum analyzer. With the offset compensation, the spectrum analyzer reading level is exactly the EUT RF output level.

The spectrum analyzer offset is derived from RF cable loss and attenuator factor.

Offset = RF cable loss + attenuator factor.

Following shows an offset computation example with cable loss 4.2 dB and 10dB attenuator.

Example :

$$\begin{aligned} \text{Offset(dB)} &= \text{RF cable loss(dB)} + \text{attenuator factor(dB)} \\ &= 4.2 + 10 = 14.2 \text{ (dB)} \end{aligned}$$

3 Conducted Test Items

3.1 Measuring Instruments

See list of measuring instruments of this test report.

3.2 Test Setup

3.2.1 Conducted Output Power

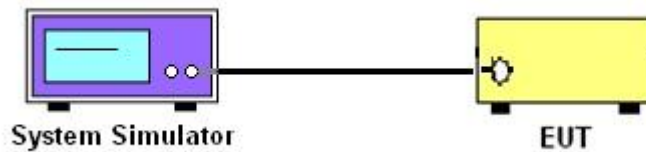

3.2.2 Peak-to-Average Ratio, Occupied Bandwidth ,Conducted Band-Edge and Conducted Spurious Emission

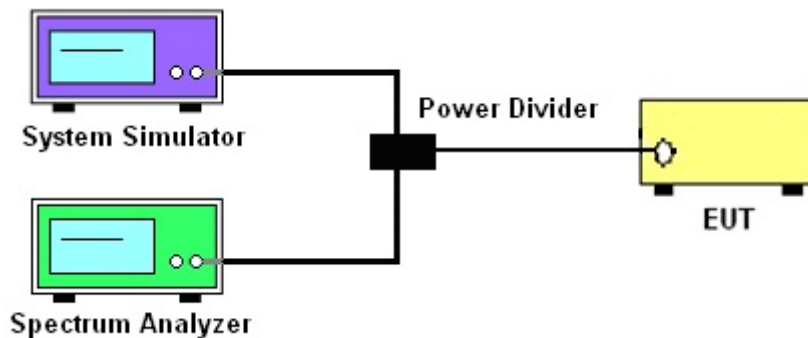

3.2.3 Frequency Stability

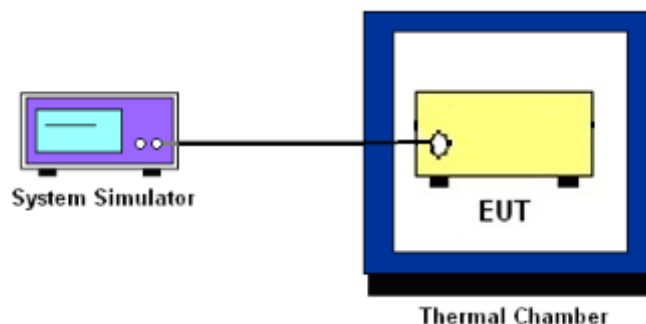

3.3 Test Result of Conducted Test

Please refer to Appendix A.



3.4 Conducted Output Power

3.4.1 Description of the Conducted Output Power Measurement

A system simulator was used to establish communication with the EUT. Its parameters were set to force the EUT transmitting at maximum output power. The measured power in the radio frequency on the transmitter output terminals shall be reported.

3.4.2 Test Procedures

1. The transmitter output port was connected to the system simulator.
2. Set EUT at maximum power through the system simulator.
3. Select lowest, middle, and highest channels for each band and different modulation.
4. Measure and record the power level from the system simulator.



3.5 Peak-to-Average Ratio

3.5.1 Description of the PAR Measurement

Power Complementary Cumulative Distribution Function (CCDF) curves provide a means for characterizing the power peaks of a digitally modulated signal on a statistical basis. A CCDF curve depicts the probability of the peak signal amplitude exceeding the average power level. Most contemporary measurement instrumentation include the capability to produce CCDF curves for an input signal provided that the instrument's resolution bandwidth can be set wide enough to accommodate the entire input signal bandwidth. In measuring transmissions in this band using an average power technique, the peak-to-average ratio (PAR) of the transmission may not exceed 13 dB.

3.5.2 Test Procedures

1. The testing follows FCC KDB 971168 v02r02 Section 5.7.1.
2. The EUT was connected to spectrum and system simulator via a power divider.
3. Set the CCDF (Complementary Cumulative Distribution Function) option in spectrum analyzer.
4. The highest RF powers were measured and recorded the maximum PAPR level associated with a probability of 0.1 %.
5. Record the deviation as Peak to Average Ratio.



3.6 Occupied Bandwidth

3.6.1 Description of Occupied Bandwidth Measurement

The occupied bandwidth is the width of a frequency band such that, below the lower and above the upper frequency limits, the mean powers emitted are each equal to a specified percentage 0.5% of the total mean transmitted power.

The 26 dB emission bandwidth is defined as the frequency range between two points, one above and one below the carrier frequency, at which the spectral density of the emission is attenuated 26 dB below the maximum in-band spectral density of the modulated signal. Spectral density (power per unit bandwidth) is to be measured with a detector of resolution bandwidth equal to approximately 1.0% of the emission bandwidth.

3.6.2 Test Procedures

1. The testing follows FCC KDB 971168 v02r02 Section 4.2.
2. The EUT was connected to spectrum analyzer and system simulator via a power divider.



3.7 Conducted Band Edge

3.7.1 Description of Conducted Band Edge Measurement

22.917(a)

For operations in the 824 – 849 MHz band, the FCC limit is $43 + 10\log_{10}(P[\text{Watts}])$ dB below the transmitter power P(Watts) in a 100kHz bandwidth. However, in the 1MHz bands immediately outside and adjacent to the licensee's frequency block, a resolution bandwidth of at least one percent of the emission bandwidth of the fundamental emission of the transmitter may be employed.

24.238 (a)

For operations in the 1850-1910 and 1930-1990 MHz band, the FCC limit is $43 + 10\log_{10}(P[\text{Watts}])$ dB below the transmitter power P(Watts) in a 1MHz bandwidth. However, in the 1 MHz bands immediately outside and adjacent to the frequency block a resolution bandwidth of at least one percent of the emission bandwidth of the fundamental emission of the transmitter may be employed.

27.53 (g)

For operations in the 698 -746 MHz band, the FCC limit is $43 + 10\log_{10}(P[\text{Watts}])$ dB below the transmitter power P(Watts) in a 100 kHz bandwidth. However, in the 100 kilohertz bands immediately outside and adjacent to a licensee's frequency block, a resolution bandwidth of at least 30 kHz may be employed.

27.53 (h)

For operations in the 1710 – 1755 MHz band, the FCC limit is $43 + 10\log_{10}(P[\text{Watts}])$ dB below the transmitter power P(Watts) in a 1 MHz bandwidth. However, in the 1MHz bands immediately outside and adjacent to the licensee's frequency block, a resolution bandwidth of at least one percent of the emission bandwidth of the fundamental emission of the transmitter may be employed.



27.53(m)(4)

For mobile digital stations, the attenuation factor shall be not less than $40 + 10 \log (P)$ dB on all frequencies between the channel edge and 5 megahertz from the channel edge, $43 + 10 \log (P)$ dB on all frequencies between 5 megahertz and X megahertz from the channel edge, and $55 + 10 \log (P)$ dB on all frequencies more than X megahertz from the channel edge, where X is the greater of 6 megahertz or the actual emission bandwidth as defined in paragraph (m)(6) of this section. In addition, the attenuation factor shall not be less that $43 + 10 \log (P)$ dB on all frequencies between 2490.5 MHz and 2496 MHz and $55 + 10 \log (P)$ dB at or below 2490.5 MHz. Mobile Satellite Service licensees operating on frequencies below 2495 MHz may also submit a documented interference complaint against BRS licensees operating on channel BRS Channel 1 on the same terms and conditions as adjacent channel BRS or EBS licensees.

3.7.2 Test Procedures

1. The testing follows FCC KDB 971168 v02r02 Section 6.0.
2. The EUT was connected to spectrum analyzer and system simulator via a power divider.
3. The band edges of low and high channels for the highest RF powers were measured. Set RBW $\geq 1\%$ EBW in the 1MHz band immediately outside and adjacent to the band edge.
4. Set spectrum analyzer with RMS detector.
5. The RF fundamental frequency should be excluded against the limit line in the operating frequency band.
6. The limit line is derived from $43 + 10\log(P)$ dB below the transmitter power P(Watts)
 $= P(W) - [43 + 10\log(P)]$ (dB)
 $= [30 + 10\log(P)]$ (dBm) - $[43 + 10\log(P)]$ (dB)
 $= -13$ dBm.



3.8 Conducted Spurious Emission

3.8.1 Description of Conducted Spurious Emission Measurement

The power of any emission outside of the authorized operating frequency ranges must be lower than the transmitter power (P) by a factor of at least $43 + 10 \log (P)$ dB.

For Band 41

The power of any emission outside of the authorized operating frequency ranges must be lower than the transmitter power (P) by a factor of at least $55 + 10 \log (P)$ dB.

It is measured by means of a calibrated spectrum analyzer and scanned from 30 MHz up to a frequency including its 10th harmonic.

3.8.2 Test Procedures

1. The testing follows FCC KDB 971168 v02r02 Section 6.0.
2. The EUT was connected to spectrum analyzer and system simulator via a power divider.
3. The RF output of EUT was connected to the spectrum analyzer by RF cable and attenuator. The path loss was compensated to the results for each measurement.
4. The middle channel for the highest RF power within the transmitting frequency was measured.
5. The conducted spurious emission for the whole frequency range was taken.
6. Make the measurement with the spectrum analyzer's RBW = 1MHz, VBW = 3MHz, taking the record of maximum spurious emission.
7. The RF fundamental frequency should be excluded against the limit line in the operating frequency band.
8. The limit line is derived from $43 + 10\log(P)$ dB below the transmitter power P(Watts)
= $P(W) - [43 + 10\log(P)]$ (dB)
= $[30 + 10\log(P)]$ (dBm) - $[43 + 10\log(P)]$ (dB)
= -13dBm.
9. For Band 41
The limit line is derived from $55 + 10\log(P)$ dB below the transmitter power P(Watts)



3.9 Frequency Stability

3.9.1 Description of Frequency Stability Measurement

The frequency stability shall be measured by variation of ambient temperature and variation of primary supply voltage to ensure that the fundamental emission stays within the authorized frequency block. The frequency stability of the transmitter shall be maintained within $\pm 0.00025\%$ ($\pm 2.5\text{ppm}$) of the center frequency.

3.9.2 Test Procedures for Temperature Variation

1. The EUT was set up in the thermal chamber and connected with the system simulator.
2. With power OFF, the temperature was decreased to -30°C and the EUT was stabilized before testing. Power was applied and the maximum change in frequency was recorded within one minute.
3. With power OFF, the temperature was raised in 10°C step up to 50°C . The EUT was stabilized at each step for at least half an hour. Power was applied and the maximum frequency change was recorded within one minute.

3.9.3 Test Procedures for Voltage Variation

1. The testing follows FCC KDB 971168 v02r02 Section 9.0.
2. The EUT was placed in a temperature chamber at $25\pm 5^{\circ}\text{C}$ and connected with the system simulator.
3. The power supply voltage to the EUT was varied from 85% to 115% of the nominal value measured at the input to the EUT.
4. The variation in frequency was measured for the worst case.

4 Radiated Test Items

4.1 Measuring Instruments

See list of measuring instruments of this test report.

4.2 Test Setup

4.2.1 For radiated test from 30MHz to 1GHz

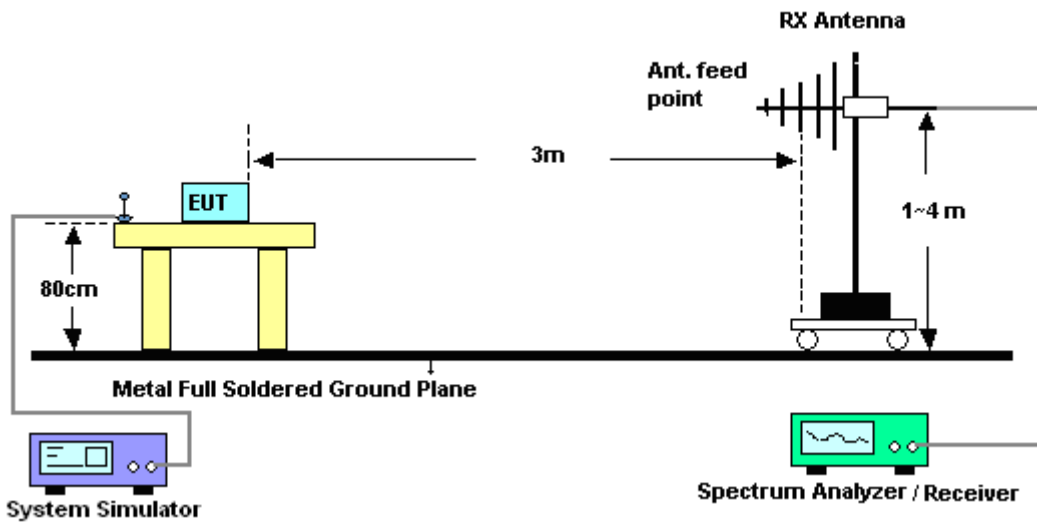

4.2.2 For radiated test above 1GHz

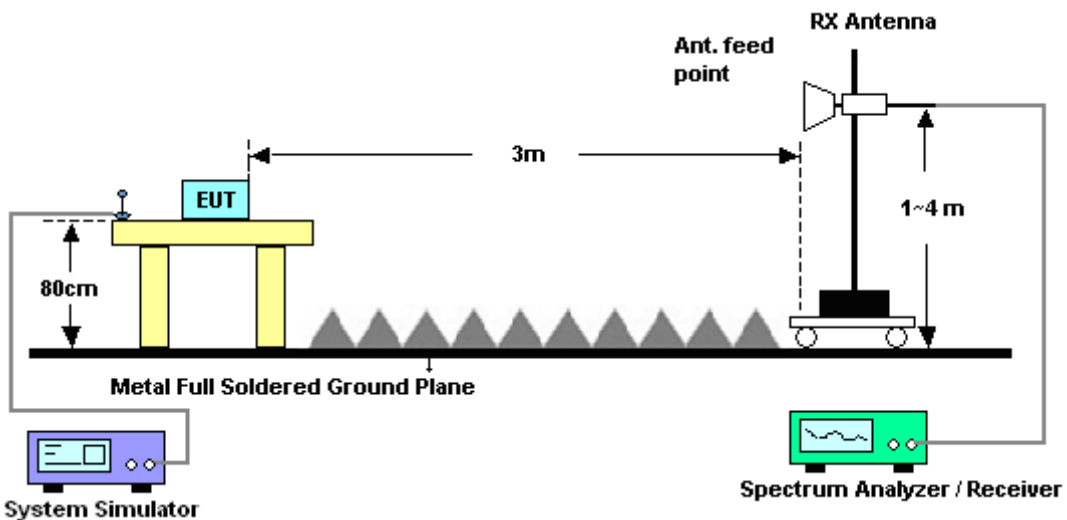

4.3 Test Result of Radiated Test

Please refer to Appendix B.



4.4 Effective Radiated Power and Effective Isotropic Radiated Power

4.4.1 Description of the ERP/EIRP Measurement

Effective radiated power output measurements by substitution method according to ANSI / TIA / EIA-603-C-2004, and the spectrum analyzer configuration follows KDB 971168 D01 Power Meas. License Digital Systems v02r02. Mobile and portable (hand-held) stations operating are limited to average ERP of 7 watts with LTE band 5 / 26 and 3 watts with LTE band 12 / 17.

Equivalent isotropic radiated power output measurements by substitution method according to ANSI / TIA / EIA-603-C-2004, and the spectrum analyzer configuration follows KDB 971168 D01 Power Meas. License Digital Systems v02r02. Mobile and portable (hand-held) stations operating are limited to average EIRP of 2 watts with LTE band 2 / 25 / 41 and 1 watt with LTE band 4..

4.4.2 Test Procedures

1. The testing follows FCC KDB 971168 v02r02 Section 5.2.1. (for CDMA/WCDMA), Section 5.2.2.2 (for GSM/GPRS/EDGE) and ANSI / TIA-603-C-2004 Section 2.2.17.
2. The EUT was placed on a non-conductive rotating platform 0.8 meters high in a semi-anechoic chamber. The radiated emission at the fundamental frequency was measured at 3 m with a test antenna and a spectrum analyzer with RMS detector.
3. During the measurement, the system simulator parameters were set to force the EUT transmitting at maximum output power. The maximum emission was recorded from analyzer power level (LVL) from the 360 degrees rotation of the turntable and the test antenna raised and lowered over a range from 1 to 4 meters in both horizontally and vertically polarized orientations.
4. Effective Isotropic Radiated Power (EIRP) was measured by substitution method according to TIA/EIA-603-C. The EUT was replaced by dipole antenna (substitution antenna) at same location, and then a known power from S.G. was applied into the dipole antenna through a Tx cable, and then recorded the maximum Analyzer reading through raised and lowered the test antenna. The correction factor (in dB) = S.G. - Tx Cable loss + Substitution antenna gain - Analyzer reading. Then the EUT's EIRP was calculated with the correction factor, $EIRP = LVL + \text{Correction factor}$ and $ERP = EIRP - 2.15$.



	LTE					
LTE BW	1.4M	3M	5M	10M	15M	20M
Span	3MHz	6MHz	10MHz	20MHz	30MHz	40MHz
RBW	30kHz	100kHz	100kHz	300kHz	300kHz	300kHz
VBW	100kHz	300kHz	300kHz	1MHz	1MHz	1MHz
Detector	RMS	RMS	RMS	RMS	RMS	RMS
Trace	Average	Average	Average	Average	Average	Average
Average Type	Power	Power	Power	Power	Power	Power
Sweep Count	100	100	100	100	100	100



4.5 Radiated Spurious Emission

4.5.1 Description of Radiated Spurious Emission

The radiated spurious emission was measured by substitution method according to ANSI / TIA / EIA-603-C-2004. The power of any emission outside of the authorized operating frequency ranges must be attenuated below the transmitter power (P) by a factor of at least $43 + 10 \log (P)$ dB.

For Band 7, 41

The power of any emission outside of the authorized operating frequency ranges must be attenuated below the transmitter power (P) by a factor of at least $55 + 10 \log (P)$ dB.

For LTE Band 12,17

For operations in the 746-758 MHz, 775-788 MHz, and 805-806 MHz bands, emissions in the band 1559-1610 MHz shall be limited to -70 dBW/MHz equivalent isotropically radiated power (EIRP) for wideband signals, and -80 dBW EIRP for discrete emissions of less than 700 Hz bandwidth.

The spectrum is scanned from 30 MHz up to a frequency including its 10th harmonic.

4.5.2 Test Procedures

1. The testing follows FCC KDB 971168 v02r02 Section 5.8 and ANSI / TIA-603-C-2004 Section 2.2.12.
2. The EUT was placed on a rotatable wooden table with 0.8 meter above ground.
3. The EUT was set 3 meters from the receiving antenna, which was mounted on the antenna tower.
4. The table was rotated 360 degrees to determine the position of the highest spurious emission.
5. The height of the receiving antenna is varied between one meter and four meters to search the maximum spurious emission for both horizontal and vertical polarizations.
6. Make the measurement with the spectrum analyzer's RBW = 1MHz, VBW = 3MHz, taking the record of maximum spurious emission.
7. A horn antenna was substituted in place of the EUT and was driven by a signal generator.
8. Tune the output power of signal generator to the same emission level with EUT maximum spurious emission.
9. Taking the record of output power at antenna port.
10. Repeat step 7 to step 8 for another polarization.
11. The RF fundamental frequency should be excluded against the limit line in the operating frequency band.

The limit line is derived from $43 + 10\log(P)$ dB below the transmitter power P(Watts)
 $= P(W) - [43 + 10\log(P)]$ (dB)
 $= [30 + 10\log(P)]$ (dBm) - $[43 + 10\log(P)]$ (dB)
 $= -13$ dBm.

For Band 41:

The limit line is derived from $55 + 10\log(P)$ dB below the transmitter power P(Watts)

12. EIRP (dBm) = S.G. Power – Tx Cable Loss + Tx Antenna Gain
13. ERP (dBm) = EIRP - 2.15



5 List of Measuring Equipment

Instrument	Manufacturer	Model No.	Serial No.	Characteristics	Calibration Date	Test Date	Due Date	Remark
LTE Base Station	Anritsu	MT8820C	6201026480	30MHz~2.7GHz SISO	Jan. 07, 2014	Dec. 04, 2014 ~ Dec. 14, 2014	Jan. 06, 2015	Conducted (TH02-HY)
Spectrum Analyzer	Rohde & Schwarz	FSP40	100055	9kHz~40GHz	Jun. 09, 2014	Dec. 04, 2014 ~ Dec. 14, 2014	Jun. 08, 2015	Conducted (TH02-HY)
Thermal Chamber	Ten Billion	TTH-D3SP	TBN-930701	N/A	Jul. 17, 2014	Dec. 04, 2014 ~ Dec. 14, 2014	Jul. 16, 2015	Conducted (TH02-HY)
Spectrum Analyzer	Rohde & Schwarz	FSV30	101749	10Hz ~ 30GHz	Feb. 10, 2014	Dec. 04, 2014 ~ Dec. 09, 2014	Feb. 09, 2015	Radiation (03CH07-HY)
Bilog Antenna	Schaffner	CBL6111C	2726	30MHz ~ 1GHz	Sep. 27, 2014	Dec. 04, 2014 ~ Dec. 09, 2014	Sep. 26, 2015	Radiation (03CH07-HY)
Double Ridge Horn Antenna	ESCO	3117	75962	1GHz~18GHz	Aug. 19, 2014	Dec. 04, 2014 ~ Dec. 09, 2014	Aug. 18, 2015	Radiation (03CH07-HY)
Preamplifier	COM-POWER	PA-103A	161241	10 MHz ~ 1000MHz	Mar. 17, 2014	Dec. 04, 2014 ~ Dec. 09, 2014	Mar. 16, 2015	Radiation (03CH07-HY)
Preamplifier	Agilent	8449B	3008A02362	1 GHz~26.5 GHz	Oct. 21, 2014	Dec. 04, 2014 ~ Dec. 09, 2014	Oct. 20, 2015	Radiation (03CH07-HY)
Turn Table	ChainTek	ChainTek 3000	N/A	0 ~ 360 degree	N/A	Dec. 04, 2014 ~ Dec. 09, 2014	N/A	Radiation (03CH07-HY)
Antenna Mast	ChainTek	M-400-0	114/8000604/L	N/A	N/A	Dec. 04, 2014 ~ Dec. 09, 2014	N/A	Radiation (03CH07-HY)
SHF-EHF Horn Antenna	SCHWARZBECK	BBHA 9170	BBHA9170251	18GHz~40GHz	Oct. 02, 2014	Dec. 04, 2014 ~ Dec. 09, 2014	Oct. 01, 2015	Radiation (03CH07-HY)
Signal Generator	Rohde & Schwarz	SMF100A	101107	100kHz~40GHz	May 23, 2014	Dec. 04, 2014 ~ Dec. 09, 2014	May 22, 2015	Radiation (03CH07-HY)
Double Ridge Horn Antenna	ESCO	3117	00066583	1GHz~18GHz	Jul. 24, 2014	Dec. 04, 2014 ~ Dec. 09, 2014	Jul. 23, 2015	Radiation (03CH07-HY)



6 Uncertainty of Evaluation

Uncertainty of Radiated Emission Measurement (30 MHz ~ 1000 MHz)

Measuring Uncertainty for a Level of Confidence of 95% ($U = 2Uc(y)$)	2.54
---	------

Uncertainty of Radiated Emission Measurement (1 GHz ~ 40 GHz)

Measuring Uncertainty for a Level of Confidence of 95% ($U = 2Uc(y)$)	4.72
---	------



Appendix A. Test Results of Conducted Test

Conducted Output Power(Average power)



LTE Band 2 Maximum Average Power [dBm]						
BW [MHz]	RB Size	RB Offset	Mod	Lowest	Middle	Highest
1.4	1	0	QPSK	22.96	22.65	22.87
1.4	1	2		23.08	22.69	23.15
1.4	1	5		23.03	22.68	22.83
1.4	3	0		23.04	22.81	23.10
1.4	3	1		23.14	22.99	23.04
1.4	3	2		23.03	22.86	23.06
1.4	6	0		22.01	21.99	22.12
1.4	1	0	16-QAM	22.68	22.55	22.38
1.4	1	2		22.67	22.52	22.25
1.4	1	5		22.51	22.48	22.34
1.4	3	0		22.63	22.30	22.36
1.4	3	1		22.31	22.18	22.29
1.4	3	2		22.31	22.06	22.26
1.4	6	0		20.84	20.85	20.86
3	1	0	QPSK	22.81	22.92	22.84
3	1	7		23.04	23.14	23.11
3	1	14		23.08	22.71	23.18
3	8	0		22.05	21.94	22.16
3	8	4		22.05	21.94	22.10
3	8	7		22.10	21.95	22.17
3	15	0		22.07	21.91	22.13
3	1	0	16-QAM	22.34	21.98	22.38
3	1	7		22.42	22.15	22.18
3	1	14		21.63	21.98	21.90
3	8	0		21.24	20.98	21.33
3	8	4		21.21	20.96	21.17
3	8	7		21.05	21.03	21.19
3	15	0		21.17	20.91	21.27



LTE Band 2 Maximum Average Power [dBm]						
BW [MHz]	RB Size	RB Offset	Mod	Lowest	Middle	Highest
5	1	0	QPSK	23.05	22.84	22.65
5	1	12		23.13	22.71	22.94
5	1	24		22.66	22.66	22.77
5	12	0		21.98	21.91	22.05
5	12	6		22.00	21.86	22.10
5	12	11		22.01	21.86	22.10
5	25	0		22.01	21.86	22.11
5	1	0	16-QAM	22.20	22.22	21.88
5	1	12		22.05	21.64	21.92
5	1	24		22.03	21.85	21.98
5	12	0		20.96	20.85	21.03
5	12	6		21.23	20.81	21.03
5	12	11		21.10	20.84	21.04
5	25	0		20.89	20.77	21.03
10	1	0	QPSK	23.03	22.78	22.98
10	1	24		23.04	22.61	23.10
10	1	49		22.93	22.68	22.96
10	25	0		22.01	21.89	22.00
10	25	12		21.99	21.94	22.05
10	25	24		21.95	21.86	22.04
10	50	0		22.04	21.95	22.08
10	1	0	16-QAM	22.34	22.13	22.03
10	1	24		22.13	22.14	22.51
10	1	49		22.18	22.31	22.26
10	25	0		21.12	20.72	21.04
10	25	12		21.14	21.01	20.97
10	25	24		20.97	21.01	21.08
10	50	0		20.85	20.98	21.02



LTE Band 2 Maximum Average Power [dBm]						
BW [MHz]	RB Size	RB Offset	Mod	Lowest	Middle	Highest
15	1	0	QPSK	23.02	22.99	22.87
15	1	37		23.03	22.94	22.71
15	1	74		23.01	22.82	22.82
15	36	0		22.10	22.06	21.91
15	36	18		21.90	22.06	21.93
15	36	37		21.93	21.96	22.00
15	75	0		21.99	21.86	21.96
15	1	0	16-QAM	22.35	22.08	22.41
15	1	37		22.12	22.00	22.32
15	1	74		22.22	22.02	21.91
15	36	0		21.01	20.89	21.05
15	36	18		20.90	20.88	20.99
15	36	37		20.88	20.90	21.01
15	75	0		20.83	20.70	20.85
20	1	0	QPSK	22.85	22.75	23.24
20	1	49		23.21	22.94	23.16
20	1	99		22.80	22.79	22.85
20	50	0		21.97	21.82	21.91
20	50	24		21.89	21.73	21.87
20	50	49		21.86	21.70	21.95
20	100	0		21.93	21.76	21.93
20	1	0	16-QAM	22.74	22.26	22.66
20	1	49		22.56	22.14	22.60
20	1	99		22.43	22.17	22.59
20	50	0		21.07	20.74	21.03
20	50	24		20.98	20.66	20.93
20	50	49		20.88	20.72	20.94
20	100	0		21.02	20.89	21.04



LTE Band 25 Maximum Average Power [dBm]						
BW [MHz]	RB Size	RB Offset	Mod	Lowest	Middle	Highest
1.4	1	0	QPSK	22.99	22.78	23.07
1.4	1	2		23.03	22.93	23.17
1.4	1	5		23.01	22.78	23.15
1.4	3	0		23.24	22.88	23.30
1.4	3	1		23.34	22.96	23.30
1.4	3	2		23.19	22.84	23.18
1.4	6	0		22.18	22.15	22.18
1.4	1	0	16-QAM	22.55	22.49	22.33
1.4	1	2		22.35	22.04	22.14
1.4	1	5		22.43	22.05	21.93
1.4	3	0		22.11	21.84	22.04
1.4	3	1		22.28	22.14	22.24
1.4	3	2		22.36	22.22	22.28
1.4	6	0		20.94	20.85	20.98
3	1	0	QPSK	23.13	23.09	22.94
3	1	7		23.33	23.05	23.27
3	1	14		23.01	22.96	23.10
3	8	0		22.17	22.12	22.08
3	8	4		22.12	22.04	22.22
3	8	7		22.20	22.03	22.21
3	15	0		22.15	22.03	22.12
3	1	0	16-QAM	22.47	22.37	22.11
3	1	7		22.39	22.13	22.15
3	1	14		22.35	22.27	22.09
3	8	0		21.08	21.02	21.04
3	8	4		21.05	20.79	21.12
3	8	7		21.01	20.91	20.99
3	15	0		21.00	20.78	21.09



LTE Band 25 Maximum Average Power [dBm]						
BW [MHz]	RB Size	RB Offset	Mod	Lowest	Middle	Highest
5	1	0	QPSK	22.99	22.81	22.86
5	1	12		23.13	22.89	23.19
5	1	24		23.28	22.85	23.04
5	12	0		22.09	22.19	22.27
5	12	6		22.12	22.04	22.11
5	12	11		22.09	21.98	22.19
5	25	0		22.12	22.01	22.11
5	1	0	16-QAM	22.61	22.49	22.44
5	1	12		22.37	22.42	22.46
5	1	24		22.24	22.28	22.39
5	12	0		21.12	20.85	20.99
5	12	6		20.88	20.88	20.94
5	12	11		20.97	20.85	21.04
5	25	0		21.08	20.93	21.10
10	1	0	QPSK	23.25	23.11	23.21
10	1	24		23.35	23.32	23.26
10	1	49		22.94	22.95	23.23
10	25	0		22.06	22.05	22.04
10	25	12		22.14	22.04	22.08
10	25	24		22.17	22.03	22.09
10	50	0		22.12	22.12	22.07
10	1	0	16-QAM	22.61	22.29	22.26
10	1	24		22.32	22.44	22.20
10	1	49		22.65	22.26	22.31
10	25	0		21.14	20.88	20.95
10	25	12		21.02	20.97	21.01
10	25	24		21.11	21.01	21.06
10	50	0		21.13	20.96	20.90



LTE Band 25 Maximum Average Power [dBm]						
BW [MHz]	RB Size	RB Offset	Mod	Lowest	Middle	Highest
15	1	0	QPSK	23.31	23.03	23.03
15	1	37		23.07	22.86	23.04
15	1	74		23.04	22.84	23.05
15	36	0		22.19	22.10	22.15
15	36	18		22.11	22.01	22.05
15	36	37		22.09	21.97	22.03
15	75	0		22.18	22.07	22.08
15	1	0	16-QAM	22.52	22.41	22.45
15	1	37		22.26	22.31	22.31
15	1	74		22.38	22.38	22.30
15	36	0		20.81	20.99	20.86
15	36	18		20.79	20.92	20.83
15	36	37		20.71	20.91	20.75
15	75	0		21.11	21.03	21.02
20	1	0	QPSK	23.40	23.12	22.99
20	1	49		23.36	22.94	23.16
20	1	99		23.03	22.76	23.19
20	50	0		22.19	22.01	22.04
20	50	24		22.05	22.09	22.10
20	50	49		22.04	22.00	22.03
20	100	0		22.11	22.11	22.11
20	1	0	16-QAM	22.33	22.29	22.29
20	1	49		22.26	22.25	22.26
20	1	99		22.18	22.10	22.43
20	50	0		20.99	20.94	20.98
20	50	24		20.80	20.90	20.98
20	50	49		20.83	20.85	20.92
20	100	0		20.94	20.94	21.14



LTE Band 4 Maximum Average Power [dBm]						
BW [MHz]	RB Size	RB Offset	Mod	Lowest	Middle	Highest
1.4	1	0	QPSK	23.14	23.21	23.05
1.4	1	2		23.14	23.20	23.02
1.4	1	5		23.08	23.19	23.08
1.4	3	0		23.31	23.26	23.13
1.4	3	1		23.46	23.23	23.25
1.4	3	2		23.29	23.31	23.14
1.4	6	0		22.25	22.20	22.12
1.4	1	0	16-QAM	22.60	22.87	22.55
1.4	1	2		22.42	22.44	22.35
1.4	1	5		22.61	22.40	22.46
1.4	3	0		22.17	22.36	22.29
1.4	3	1		22.13	22.13	22.33
1.4	3	2		22.07	22.05	21.97
1.4	6	0		20.96	20.94	20.85
3	1	0	QPSK	23.18	23.03	23.07
3	1	7		23.50	23.23	23.40
3	1	14		23.27	23.13	23.09
3	8	0		22.37	22.26	22.25
3	8	4		22.28	22.36	22.28
3	8	7		22.37	22.22	22.20
3	15	0		22.26	22.20	22.17
3	1	0	16-QAM	22.28	22.26	22.10
3	1	7		22.20	22.25	21.95
3	1	14		22.21	22.05	22.04
3	8	0		21.46	21.44	21.36
3	8	4		21.34	21.41	21.45
3	8	7		21.43	21.03	21.40
3	15	0		21.52	21.30	21.07



LTE Band 4 Maximum Average Power [dBm]						
BW [MHz]	RB Size	RB Offset	Mod	Lowest	Middle	Highest
5	1	0	QPSK	23.17	23.16	22.97
5	1	12		23.46	23.11	23.29
5	1	24		23.08	22.87	22.78
5	12	0		22.36	22.22	22.14
5	12	6		22.31	22.29	22.19
5	12	11		22.28	22.25	22.11
5	25	0		22.30	22.29	22.13
5	1	0	16-QAM	22.58	22.42	22.36
5	1	12		22.55	22.49	22.39
5	1	24		22.55	22.42	22.29
5	12	0		21.74	21.54	21.29
5	12	6		21.62	21.53	21.23
5	12	11		21.63	21.42	21.14
5	25	0		21.29	21.12	21.09
10	1	0	QPSK	23.49	23.52	23.23
10	1	24		23.56	23.44	23.45
10	1	49		23.35	23.12	23.36
10	25	0		22.32	22.24	22.18
10	25	12		22.38	22.30	22.21
10	25	24		22.37	22.29	22.18
10	50	0		22.37	22.22	22.24
10	1	0	16-QAM	22.66	22.78	22.56
10	1	24		22.51	22.71	22.87
10	1	49		22.70	22.46	22.48
10	25	0		21.32	21.28	21.42
10	25	12		21.42	21.34	21.25
10	25	24		21.59	21.36	21.36
10	50	0		21.29	21.17	21.17



LTE Band 4 Maximum Average Power [dBm]						
BW [MHz]	RB Size	RB Offset	Mod	Lowest	Middle	Highest
15	1	0	QPSK	23.38	23.42	23.16
15	1	37		23.35	23.27	23.01
15	1	74		23.31	23.06	23.03
15	36	0		22.35	22.27	22.30
15	36	18		22.37	22.22	22.20
15	36	37		22.40	22.28	22.12
15	75	0		22.45	22.29	22.27
15	1	0	16-QAM	22.65	22.70	22.71
15	1	37		22.55	22.48	22.53
15	1	74		22.49	22.46	22.41
15	36	0		21.16	21.13	21.30
15	36	18		21.06	21.05	21.21
15	36	37		21.17	21.09	21.16
15	75	0		21.36	21.21	21.18
20	1	0	QPSK	23.50	23.61	23.50
20	1	49		23.50	23.58	23.31
20	1	99		23.34	23.29	23.13
20	50	0		22.40	22.44	22.34
20	50	24		22.40	22.26	22.21
20	50	49		22.30	22.34	22.21
20	100	0		22.39	22.32	22.24
20	1	0	16-QAM	22.70	22.76	22.47
20	1	49		22.65	22.70	22.32
20	1	99		22.52	22.40	22.37
20	50	0		21.30	21.27	21.21
20	50	24		21.20	21.20	21.12
20	50	49		21.11	21.26	21.05
20	100	0		21.37	21.27	21.15



LTE Band 5 Maximum Average Power [dBm]						
BW [MHz]	RB Size	RB Offset	Mod	Lowest	Middle	Highest
1.4	1	0	QPSK	23.21	22.91	23.11
1.4	1	2		23.43	22.99	23.21
1.4	1	5		23.05	23.03	23.19
1.4	3	0		23.30	23.14	23.28
1.4	3	1		23.49	23.15	23.25
1.4	3	2		23.36	23.22	23.21
1.4	6	0		22.35	22.16	22.23
1.4	1	0	16-QAM	22.43	22.56	22.63
1.4	1	2		22.61	22.51	22.62
1.4	1	5		22.40	22.33	22.60
1.4	3	0		22.32	22.18	22.40
1.4	3	1		22.20	22.26	22.38
1.4	3	2		22.48	22.41	22.28
1.4	6	0		20.95	21.03	20.98
3	1	0	QPSK	23.33	22.95	23.10
3	1	7		23.41	23.25	23.00
3	1	14		22.93	23.03	23.27
3	8	0		22.38	22.17	22.33
3	8	4		22.28	22.16	22.26
3	8	7		22.20	22.14	22.23
3	15	0		22.25	22.19	22.19
3	1	0	16-QAM	22.97	22.55	22.52
3	1	7		22.35	22.44	22.41
3	1	14		22.46	22.40	22.41
3	8	0		21.14	20.97	21.03
3	8	4		21.13	20.94	21.14
3	8	7		21.20	20.95	21.20
3	15	0		21.32	20.92	21.10



LTE Band 5 Maximum Average Power [dBm]						
BW [MHz]	RB Size	RB Offset	Mod	Lowest	Middle	Highest
5	1	0	QPSK	23.39	23.22	22.93
5	1	12		23.51	23.44	23.21
5	1	24		23.14	23.07	22.91
5	12	0		22.33	22.13	22.20
5	12	6		22.25	22.19	22.20
5	12	11		22.18	22.25	22.14
5	25	0		22.18	22.30	22.13
5	1	0	16-QAM	21.98	21.97	21.64
5	1	12		21.95	21.98	21.82
5	1	24		21.95	21.94	21.94
5	12	0		21.31	21.09	21.07
5	12	6		21.28	21.12	21.00
5	12	11		21.23	21.14	21.13
5	25	0		21.03	21.08	21.22
10	1	0	QPSK	23.30	23.69	23.36
10	1	24		23.40	23.42	23.14
10	1	49		23.28	23.33	23.34
10	25	0		22.22	22.28	22.36
10	25	12		22.20	22.24	22.31
10	25	24		22.28	22.32	22.25
10	50	0		22.28	22.34	22.29
10	1	0	16-QAM	22.67	22.74	22.64
10	1	24		22.66	22.54	22.68
10	1	49		22.16	22.44	22.52
10	25	0		21.13	21.23	21.40
10	25	12		21.05	21.29	21.37
10	25	24		21.13	21.34	21.36
10	50	0		21.22	21.06	21.04



LTE Band 12 Maximum Average Power [dBm]						
BW [MHz]	RB Size	RB Offset	Mod	Lowest	Middle	Highest
1.4	1	0	QPSK	23.60	23.39	23.36
1.4	1	2		23.69	23.45	23.45
1.4	1	5		23.44	23.40	23.38
1.4	3	0		23.87	23.57	23.44
1.4	3	1		23.89	23.56	23.47
1.4	3	2		23.70	23.58	23.38
1.4	6	0		22.87	22.62	22.52
1.4	1	0	16-QAM	22.83	22.79	22.47
1.4	1	2		22.84	22.65	22.46
1.4	1	5		22.69	22.67	22.32
1.4	3	0		22.66	22.57	22.33
1.4	3	1		22.50	22.47	22.30
1.4	3	2		22.46	22.46	22.34
1.4	6	0		21.75	21.49	21.45
3	1	0	QPSK	23.66	23.64	23.38
3	1	7		23.61	23.58	23.31
3	1	14		23.47	23.31	23.25
3	8	0		22.69	22.50	22.33
3	8	4		22.65	22.52	22.44
3	8	7		22.70	22.52	22.38
3	15	0		22.70	22.54	22.36
3	1	0	16-QAM	22.60	22.34	22.43
3	1	7		22.87	22.38	22.39
3	1	14		22.65	22.36	22.26
3	8	0		21.96	21.56	21.57
3	8	4		21.92	21.55	21.54
3	8	7		21.97	21.53	21.51
3	15	0		21.71	21.56	21.30



LTE Band 12 Maximum Average Power [dBm]						
BW [MHz]	RB Size	RB Offset	Mod	Lowest	Middle	Highest
5	1	0	QPSK	23.89	23.45	23.45
5	1	12		23.67	23.73	23.41
5	1	24		23.46	23.11	23.23
5	12	0		22.61	22.54	22.31
5	12	6		22.66	22.54	22.27
5	12	11		22.65	22.45	22.28
5	25	0		22.60	22.50	22.41
5	1	0	16-QAM	22.90	22.58	22.64
5	1	12		22.87	22.54	22.54
5	1	24		22.61	22.42	22.28
5	12	0		21.64	21.38	21.35
5	12	6		21.52	21.41	21.30
5	12	11		21.50	21.34	21.29
5	25	0		21.39	21.42	21.25
10	1	0	QPSK	23.95	23.60	23.63
10	1	24		23.84	23.73	23.38
10	1	49		23.50	23.20	23.22
10	25	0		22.70	22.57	22.48
10	25	12		22.67	22.49	22.24
10	25	24		22.64	22.31	22.16
10	50	0		22.72	22.49	22.24
10	1	0	16-QAM	22.35	22.47	22.37
10	1	24		22.36	22.19	22.33
10	1	49		22.46	22.23	22.54
10	25	0		21.65	21.62	21.26
10	25	12		21.61	21.33	21.14
10	25	24		21.48	21.09	21.16
10	50	0		21.60	21.42	21.23



LTE Band 17 Maximum Average Power [dBm]						
BW [MHz]	RB Size	RB Offset	Mod	Lowest	Middle	Highest
5	1	0	QPSK	23.45	23.76	23.55
5	1	12		23.52	23.55	23.61
5	1	24		23.38	23.40	23.46
5	12	0		22.42	22.52	22.42
5	12	6		22.42	22.27	22.48
5	12	11		22.40	22.20	22.17
5	25	0		22.40	22.36	22.12
5	1	0	16-QAM	22.43	22.54	22.38
5	1	12		22.42	22.48	22.23
5	1	24		22.34	22.46	22.15
5	12	0		21.40	21.43	21.33
5	12	6		21.40	21.31	21.28
5	12	11		21.37	21.34	21.18
5	25	0		21.33	21.46	21.22
10	1	0	QPSK	23.71	23.87	23.52
10	1	24		23.43	23.46	23.58
10	1	49		23.10	23.39	23.24
10	25	0		22.69	22.61	22.53
10	25	12		22.54	22.38	22.25
10	25	24		22.23	22.39	22.30
10	50	0		22.44	22.40	22.45
10	1	0	16-QAM	22.92	22.96	22.94
10	1	24		22.91	22.96	22.84
10	1	49		22.91	22.97	22.81
10	25	0		21.74	21.62	21.63
10	25	12		21.68	21.58	21.46
10	25	24		21.31	21.40	21.13
10	50	0		21.32	21.17	21.29



LTE Band 41 Maximum Average Power [dBm]						
BW [MHz]	RB Size	RB Offset	Mod	Lowest	Middle	Highest
5	1	0	QPSK	22.00	22.67	22.51
5	1	12		21.77	22.24	22.38
5	1	24		21.51	22.23	22.13
5	12	0		20.84	21.34	21.25
5	12	6		20.73	21.31	21.07
5	12	11		20.64	21.25	21.10
5	25	0		20.78	21.29	21.14
5	1	0	16-QAM	21.25	21.78	21.31
5	1	12		21.04	21.40	21.09
5	1	24		20.87	21.38	21.02
5	12	0		20.03	20.36	20.40
5	12	6		19.75	20.22	20.05
5	12	11		19.63	20.29	20.16
5	25	0		19.92	20.28	20.05
10	1	0	QPSK	22.04	22.71	22.61
10	1	24		21.83	22.31	22.41
10	1	49		21.56	22.27	22.23
10	25	0		20.88	21.39	21.28
10	25	12		20.78	21.35	21.09
10	25	24		20.67	21.25	21.18
10	50	0		20.85	21.38	21.19
10	1	0	16-QAM	21.25	21.85	21.35
10	1	24		21.09	21.48	21.09
10	1	49		20.97	21.42	21.09
10	25	0		20.06	20.36	20.40
10	25	12		19.83	20.31	20.12
10	25	24		19.70	20.33	20.20
10	50	0		19.97	20.32	20.13



LTE Band 41 Maximum Average Power [dBm]						
BW [MHz]	RB Size	RB Offset	Mod	Lowest	Middle	Highest
15	1	0	QPSK	22.10	22.75	22.64
15	1	37		21.87	22.33	22.44
15	1	74		21.66	22.28	22.26
15	36	0		20.91	21.44	21.36
15	36	18		20.85	21.41	21.19
15	36	37		20.69	21.34	21.23
15	75	0		20.85	21.43	21.20
15	1	0	16-QAM	21.34	21.91	21.40
15	1	37		21.09	21.57	21.16
15	1	74		21.03	21.50	21.13
15	36	0		20.07	20.36	20.41
15	36	18		19.90	20.38	20.22
15	36	37		19.79	20.37	20.21
15	75	0		20.00	20.32	20.21
20	1	0	QPSK	22.11	22.81	22.69
20	1	49		21.91	22.34	22.52
20	1	99		21.76	22.33	22.36
20	50	0		20.98	21.51	21.42
20	50	24		20.89	21.45	21.21
20	50	49		20.75	21.44	21.26
20	100	0		20.85	21.47	21.29
20	1	0	16-QAM	21.34	21.93	21.41
20	1	49		21.15	21.66	21.21
20	1	99		21.09	21.59	21.16
20	50	0		20.14	20.36	20.51
20	50	24		19.97	20.43	20.32
20	50	49		19.87	20.45	20.30
20	100	0		20.02	20.42	20.23



LTE Band 26 Maximum Average Power [dBm]						
BW [MHz]	RB Size	RB Offset	Mod	Lowest	Middle	Highest
1.4	1	0	QPSK	23.07	23.01	22.78
1.4	1	2		23.20	23.15	22.95
1.4	1	5		23.04	23.00	22.80
1.4	3	0		23.08	23.05	23.11
1.4	3	1		23.26	23.18	23.00
1.4	3	2		23.23	23.04	22.96
1.4	6	0		22.25	22.08	22.10
1.4	1	0	16-QAM	22.55	22.40	22.34
1.4	1	2		22.45	22.45	22.26
1.4	1	5		22.21	22.46	22.18
1.4	3	0		22.77	22.41	22.35
1.4	3	1		22.44	22.43	22.26
1.4	3	2		22.19	22.18	22.01
1.4	6	0		21.02	21.02	21.26
3	1	0	QPSK	23.09	23.09	23.09
3	1	7		23.25	23.20	23.21
3	1	14		23.19	23.14	23.14
3	8	0		22.07	22.10	22.15
3	8	4		22.03	22.08	22.05
3	8	7		22.08	22.09	22.07
3	15	0		22.13	22.04	22.12
3	1	0	16-QAM	22.30	22.22	22.24
3	1	7		22.20	22.17	22.17
3	1	14		22.23	22.21	22.15
3	8	0		21.09	21.05	21.13
3	8	4		21.13	21.16	21.11
3	8	7		21.15	21.11	21.08
3	15	0		21.02	21.03	21.03



LTE Band 26 Maximum Average Power [dBm]						
BW [MHz]	RB Size	RB Offset	Mod	Lowest	Middle	Highest
5	1	0	QPSK	23.30	23.32	23.29
5	1	12		23.23	23.21	23.24
5	1	24		23.07	23.14	23.09
5	12	0		22.11	22.17	22.08
5	12	6		22.01	22.10	22.05
5	12	11		22.10	22.06	22.10
5	25	0		22.07	22.04	22.04
5	1	0	16-QAM	22.67	22.66	22.68
5	1	12		22.71	22.67	22.62
5	1	24		22.68	22.68	22.64
5	12	0		21.14	21.17	21.24
5	12	6		21.16	21.17	21.12
5	12	11		21.03	21.08	21.07
5	25	0		21.01	21.08	21.03
10	1	0	QPSK	23.11	23.05	23.10
10	1	24		23.30	23.28	23.35
10	1	49		23.23	23.26	23.17
10	25	0		22.17	22.04	22.16
10	25	12		22.11	22.02	22.12
10	25	24		22.13	22.11	22.07
10	50	0		22.13	22.18	22.11
10	1	0	16-QAM	22.32	22.20	22.15
10	1	24		22.20	22.21	22.11
10	1	49		22.25	22.15	22.21
10	25	0		21.13	21.21	21.27
10	25	12		21.16	21.20	21.30
10	25	24		21.18	21.16	21.29
10	50	0		21.12	21.16	21.06



LTE Band 26 Maximum Average Power [dBm]						
BW [MHz]	RB Size	RB Offset	Mod	Lowest	Middle	Highest
15	1	0	QPSK	23.36	22.97	22.97
15	1	37		23.27	23.06	23.32
15	1	74		23.17	22.89	23.10
15	36	0		22.18	21.99	22.08
15	36	18		22.11	21.99	22.11
15	36	37		22.13	22.08	22.08
15	75	0		22.13	22.14	22.20
15	1	0	16-QAM	22.72	22.66	22.64
15	1	37		22.71	22.63	22.72
15	1	74		22.68	22.62	22.62
15	36	0		21.24	21.14	21.13
15	36	18		21.18	21.05	21.18
15	36	37		21.09	21.15	21.07
15	75	0		21.11	21.11	21.07



Peak-to-Average Ratio

Mode	LTE Band 2 / 20MHz				
Mod.	QPSK		16QAM		Limit: 13dB
RB Size	1RB	Full RB	1RB	Full RB	Result
Lowest CH	4.39	5.35	5.45	6.22	PASS
Middle CH	4.62	5.45	5.64	6.28	
Highest CH	4.52	5.48	5.8	6.31	

Mode	LTE Band 25 / 20MHz				
Mod.	QPSK		16QAM		Limit: 13dB
RB Size	1RB	Full RB	1RB	RB Size	Result
Lowest CH	4.39	5.35	5.45	6.22	PASS
Middle CH	4.62	5.45	5.64	6.28	
Highest CH	4.58	5.54	5.61	6.44	

Mode	LTE Band 4 / 20MHz				
Mod.	QPSK		16QAM		Limit: 13dB
RB Size	1RB	Full RB	1RB	RB Size	Result
Lowest CH	4.33	5.06	5.26	5.9	PASS
Middle CH	3.94	5.19	5.19	5.96	
Highest CH	4.29	5.13	5.32	5.99	

Mode	LTE Band 5 / 10MHz				
Mod.	QPSK		16QAM		Limit: 13dB
RB Size	1RB	Full RB	1RB	RB Size	Result
Lowest CH	4.58	5.61	5.61	6.44	PASS
Middle CH	4.52	5.64	5.35	6.47	
Highest CH	4.42	5.38	5.26	6.28	

Mode	LTE Band 26 / 15MHz				
Mod.	QPSK		16QAM		Limit: 13dB
RB Size	1RB	Full RB	1RB	RB Size	Result
Lowest CH	4.29	5.32	5.13	6.09	PASS
Middle CH	4.13	5.26	5.03	6.09	
Highest CH	4.17	5.06	4.94	5.93	



Mode	LTE Band 12 / 10MHz				
Mod.	QPSK		16QAM		Limit: 13dB
RB Size	1RB	Full RB	1RB	RB Size	Result
Lowest CH	4.17	5.48	5.1	6.22	PASS
Middle CH	4.2	5.22	5	6.09	
Highest CH	4.13	5.35	5.22	6.12	

Mode	LTE Band 17 / 10MHz				
Mod.	QPSK		16QAM		Limit: 13dB
RB Size	1RB	Full RB	1RB	RB Size	Result
Lowest CH	4.17	5.26	5	6.09	PASS
Middle CH	4.17	5.29	5.26	6.09	
Highest CH	4.17	5.45	4.84	6.15	

Mode	LTE Band 41 / 20MHz				
Mod.	QPSK		16QAM		Limit: 13dB
RB Size	1RB	Full RB	1RB	RB Size	Result
Lowest CH	6.03	7.15	7.02	7.92	PASS
Middle CH	6.09	7.15	7.12	7.92	
Highest CH	5.83	6.83	6.54	7.63	



LTE Band 2 and 25 / 20MHz / QPSK

Lowest Channel / 1RB

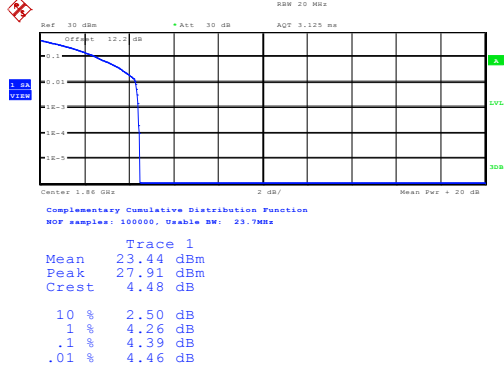

Date: 13.DEC.2014 17:17:26

Lowest Channel / Full RB

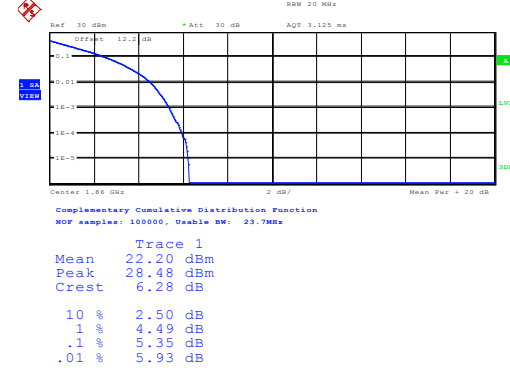

Date: 13.DEC.2014 17:17:54

Middle Channel / 1RB

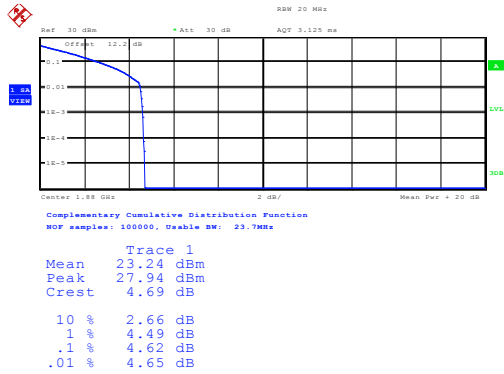

Date: 13.DEC.2014 17:18:12

Middle Channel / Full RB

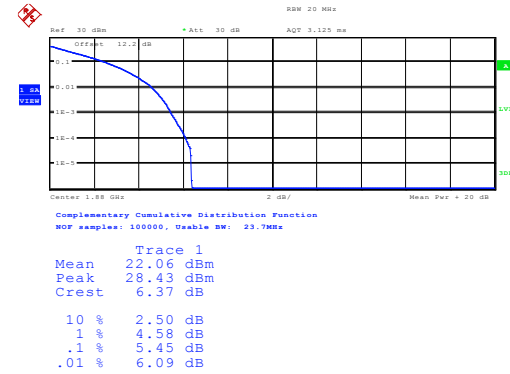

Date: 13.DEC.2014 17:18:56

LTE Band 2 / 20MHz / QPSK

Highest Channel / 1RB

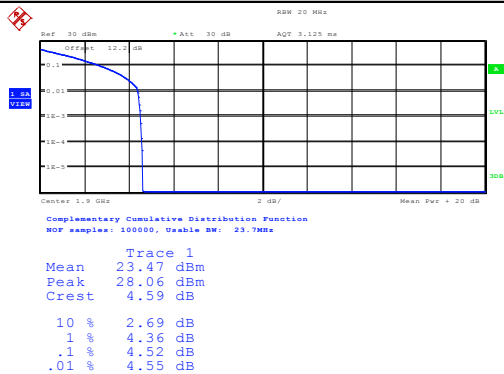

Date: 13.DEC.2014 17:19:18

Highest Channel / Full RB

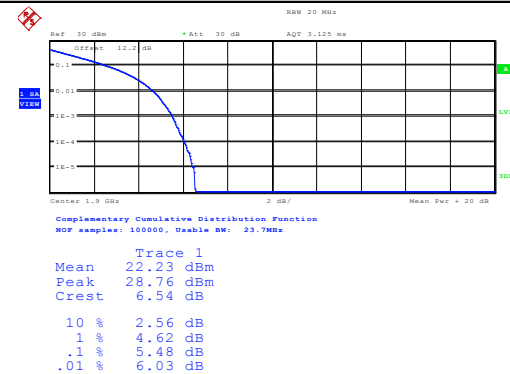

Date: 13.DEC.2014 17:19:51



LTE Band 2 and 25 / 20MHz / 16QAM

Lowest Channel / 1RB

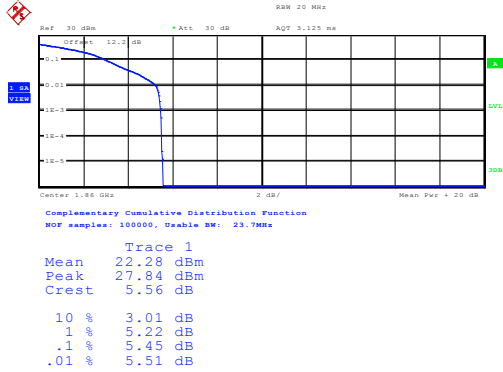

Lowest Channel / Full RB

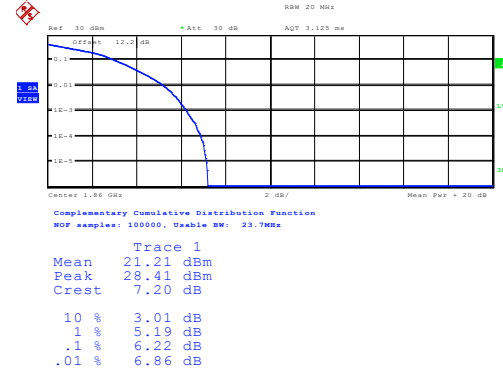

Middle Channel / 1RB

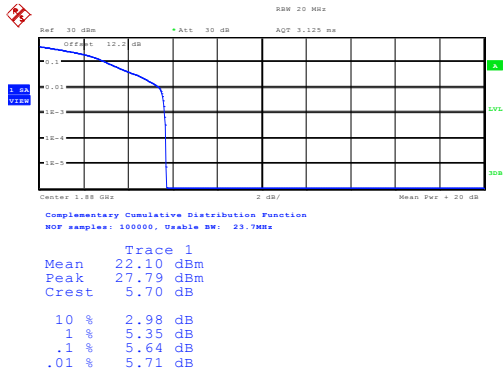

Middle Channel / Full RB

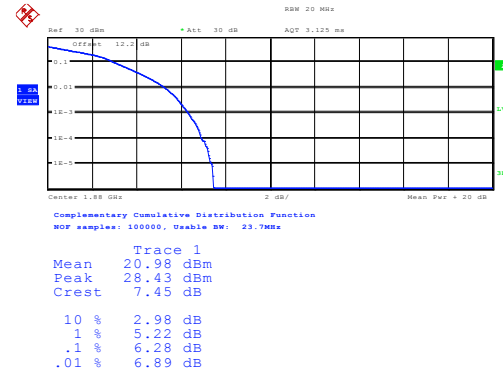

LTE Band 2 / 20MHz / 16QAM

Highest Channel / 1RB

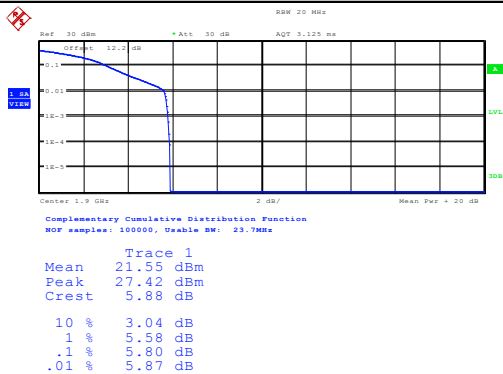

Highest Channel / Full RB

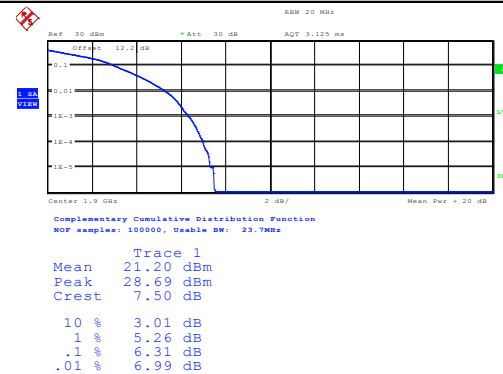



LTE Band 25 / 20MHz / QPSK

Highest Channel / 1RB

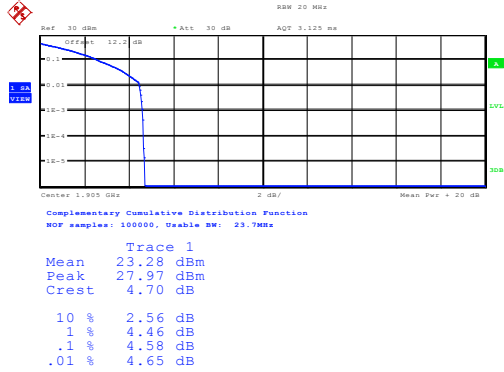

Date: 13.DEC.2014 17:03:43

Highest Channel / Full RB

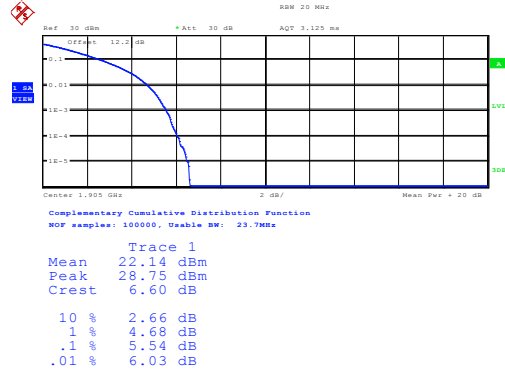

Date: 13.DEC.2014 17:04:04

LTE Band 25 / 20MHz / 16QAM

Highest Channel / 1RB

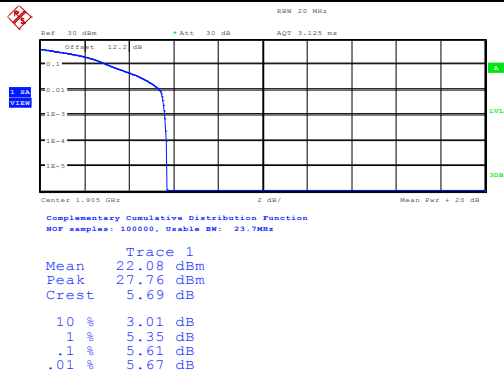

Date: 13.DEC.2014 17:02:44

Highest Channel / Full RB

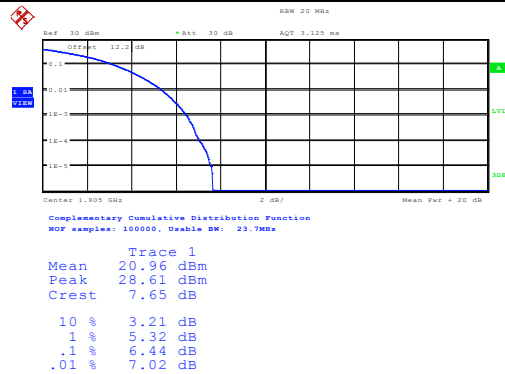

Date: 13.DEC.2014 17:03:20



LTE Band 4 / 20MHz / QPSK

Lowest Channel / 1RB

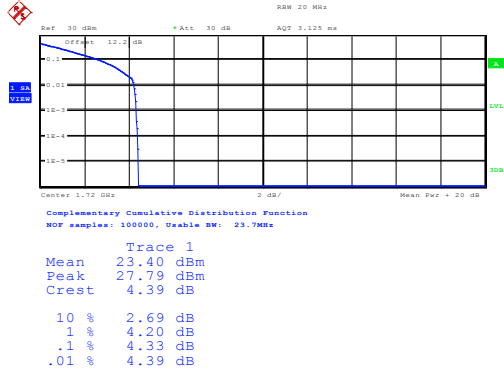

Date: 13.DEC.2014 17:08:03

Lowest Channel / Full RB

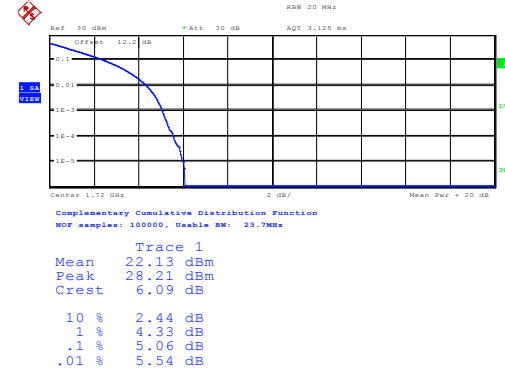

Date: 13.DEC.2014 17:08:33

Middle Channel / 1RB

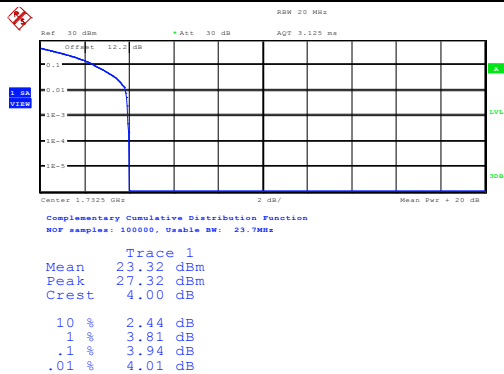

Date: 13.DEC.2014 17:09:00

Middle Channel / Full RB

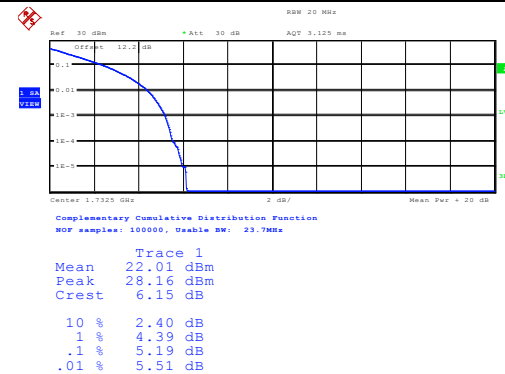

Date: 13.DEC.2014 17:09:29

Highest Channel / 1RB

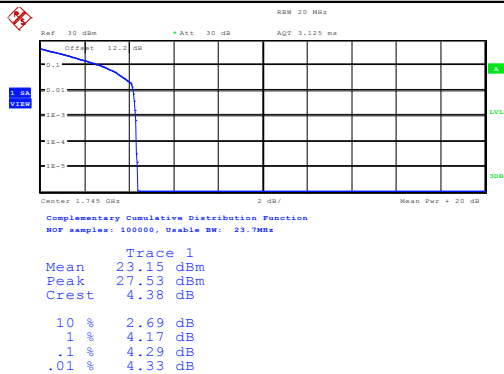

Date: 13.DEC.2014 17:09:57

Highest Channel / Full RB

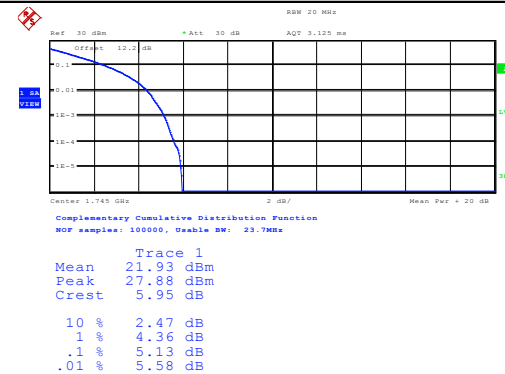

Date: 13.DEC.2014 17:10:28



LTE Band 4 / 20MHz / 16QAM

Lowest Channel / 1RB

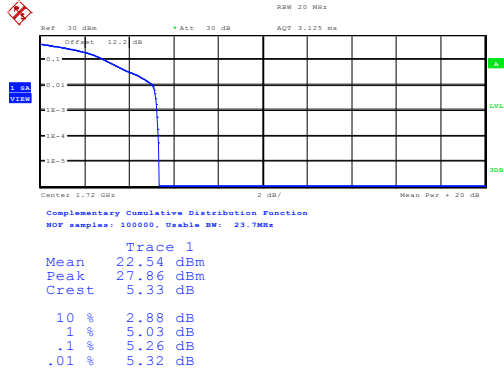

Date: 13.DEC.2014 17:04:23

Lowest Channel / Full RB

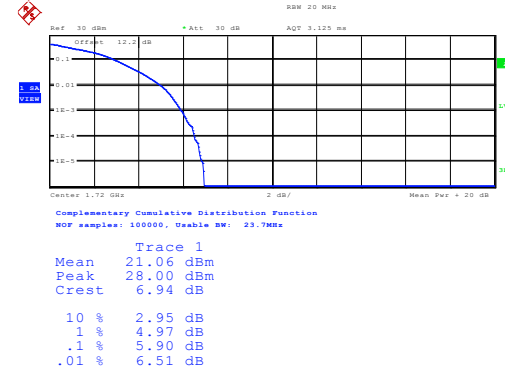

Date: 13.DEC.2014 17:04:39

Middle Channel / 1RB

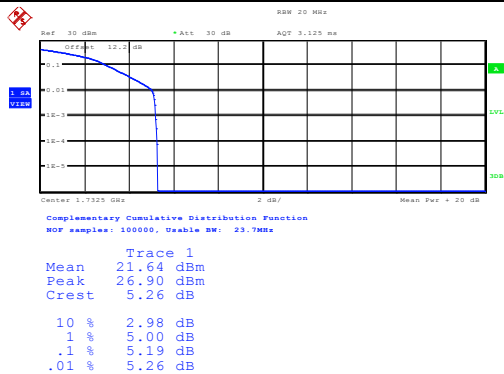

Date: 13.DEC.2014 17:05:56

Middle Channel / Full RB

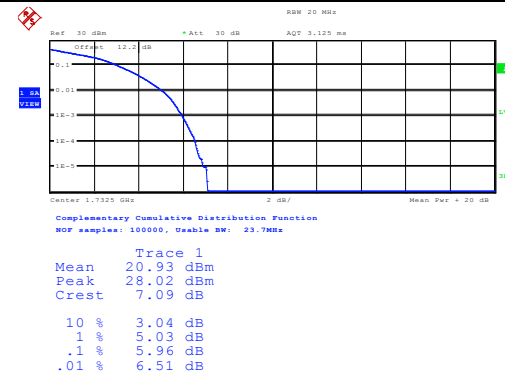

Date: 13.DEC.2014 17:06:20

Highest Channel / 1RB

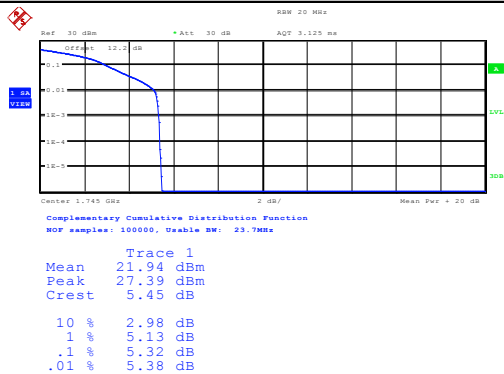

Date: 13.DEC.2014 17:06:50

Highest Channel / Full RB

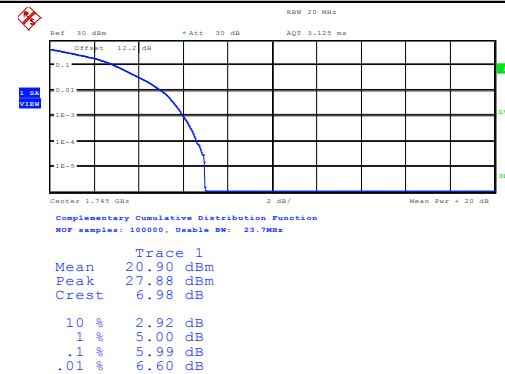

Date: 13.DEC.2014 17:07:17



LTE Band 5 / 10MHz / QPSK

Lowest Channel / 1RB

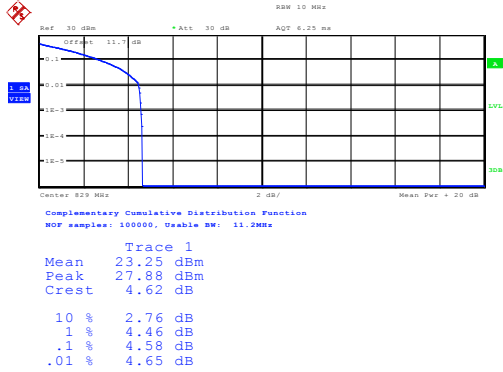

Lowest Channel / Full RB

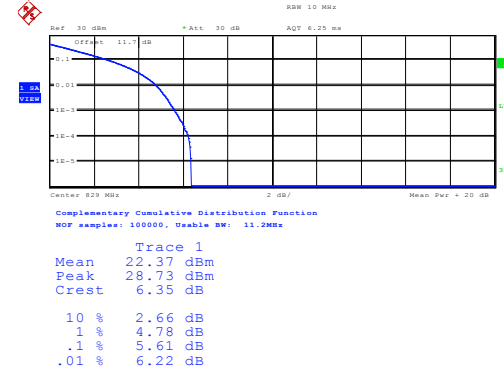

Middle Channel / 1RB

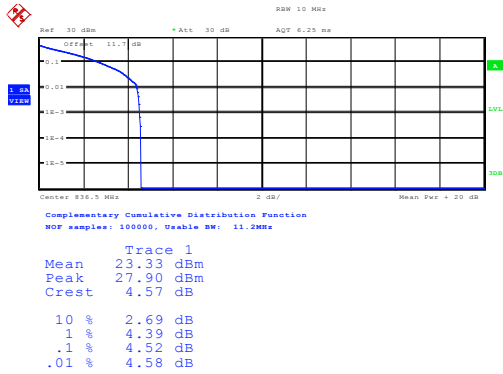

Middle Channel / Full RB

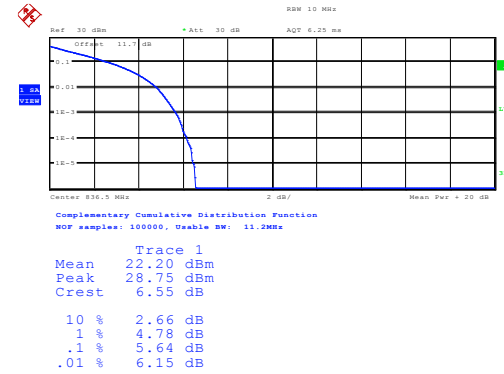

Highest Channel / 1RB

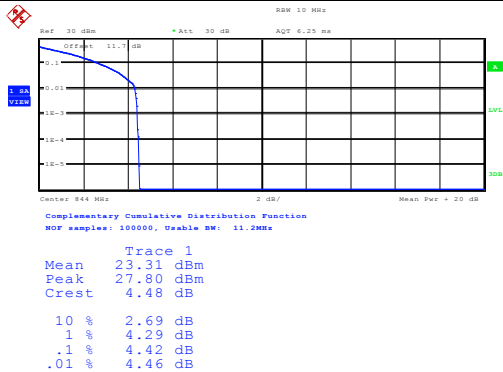

Highest Channel / Full RB

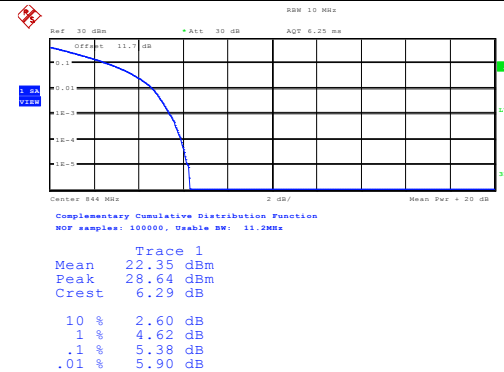



LTE Band 5 / 10MHz / 16QAM

Lowest Channel / 1RB

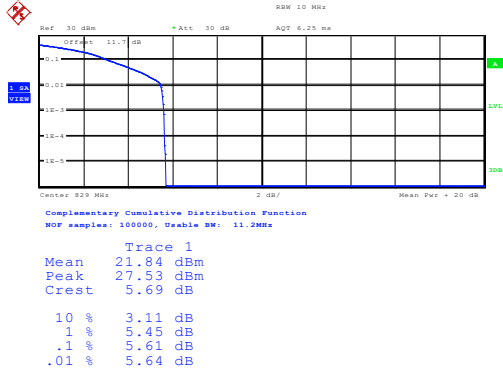

Date: 14.DEC.2014 11:01:46

Lowest Channel / Full RB

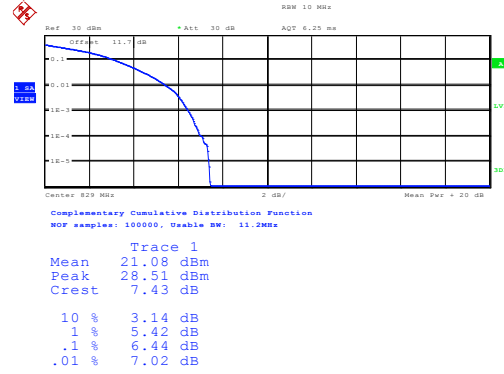

Date: 14.DEC.2014 11:02:32

Middle Channel / 1RB

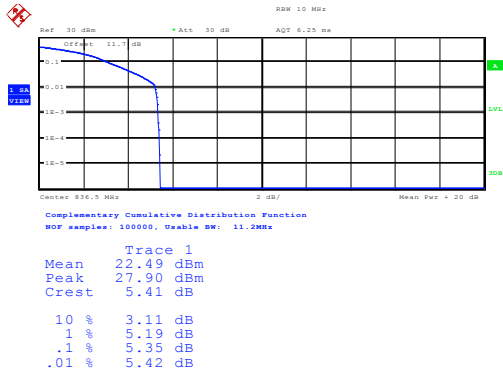

Date: 14.DEC.2014 11:03:01

Middle Channel / Full RB

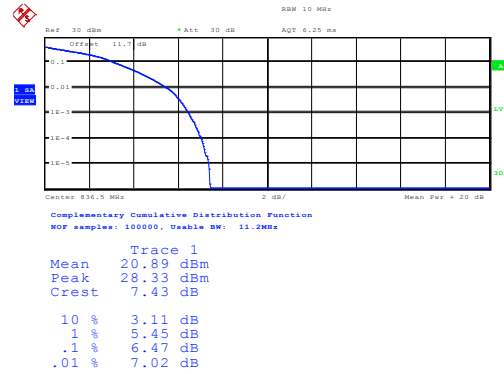

Date: 14.DEC.2014 11:04:45

Highest Channel / 1RB

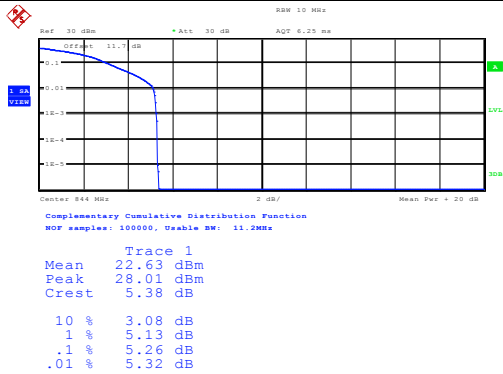

Date: 14.DEC.2014 11:05:07

Highest Channel / Full RB

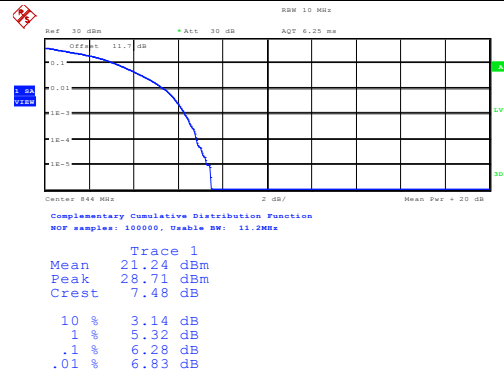

Date: 14.DEC.2014 11:05:58



LTE Band 12 / 10MHz / QPSK

Lowest Channel / 1RB

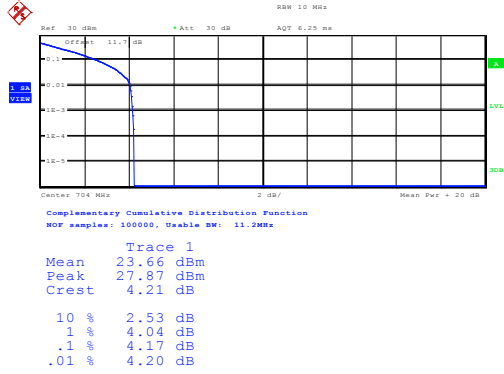

Date: 13.DEC.2014 11:44:29

Lowest Channel / Full RB

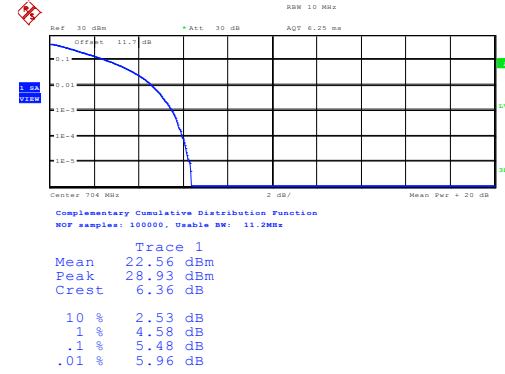

Date: 13.DEC.2014 11:41:07

Middle Channel / 1RB

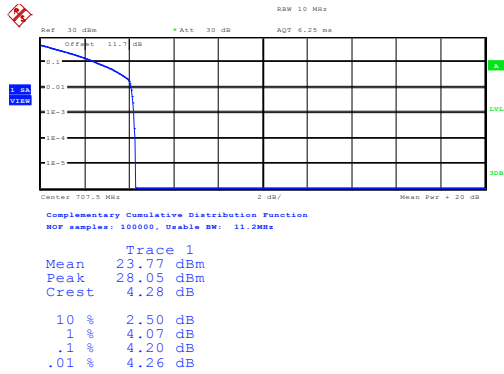

Date: 13.DEC.2014 11:41:36

Middle Channel / Full RB

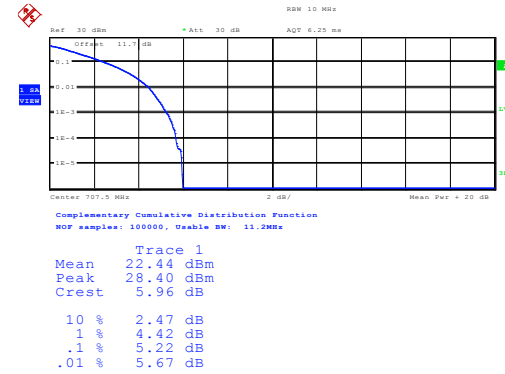

Date: 13.DEC.2014 11:41:53

Highest Channel / 1RB

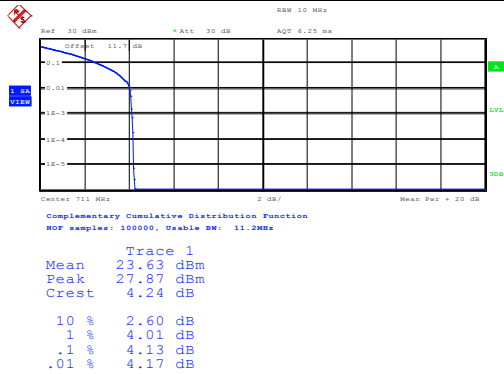

Date: 13.DEC.2014 11:42:33

Highest Channel / Full RB

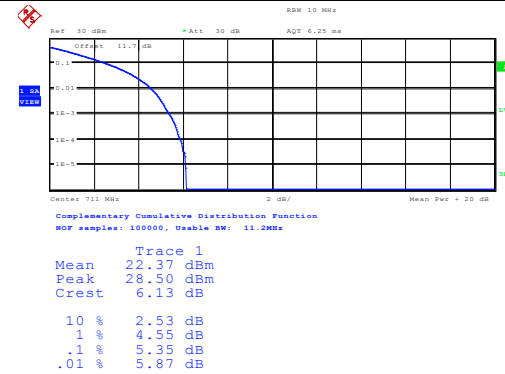

Date: 13.DEC.2014 11:42:07