



FCC RF Test Report

APPLICANT : Motorola Mobility, LLC
EQUIPMENT : Mobile Cellular Phone
BRAND NAME : Motorola
MODEL NAME : 4245
FCC ID : IHDT56QC2
STANDARD : FCC 47 CFR Part 2, 22(H), 24(E)
CLASSIFICATION : PCS Licensed Transmitter Held to Ear (PCE)

The product was received on Nov. 14, 2014 and testing was completed on Dec. 08, 2014. We, SPORTON INTERNATIONAL INC., would like to declare that the tested sample has been evaluated in accordance with the test procedures given in ANSI / TIA / EIA-603-C-2004 and has been in compliance with the applicable technical standards.

The test results in this report apply exclusively to the tested model / sample. Without written approval of SPORTON INTERNATIONAL INC., the test report shall not be reproduced except in full.

Reviewed by: Joseph Lin / Supervisor

Approved by: Jones Tsai / Manager



SPORTON INTERNATIONAL INC.

No. 52, Hwa Ya 1st Rd., Hwa Ya Technology Park, Kwei-Shan Hsiang, Tao Yuan Hsien, Taiwan, R.O.C.



TABLE OF CONTENTS

SUMMARY OF TEST RESULT 4

1 GENERAL DESCRIPTION 5

1.1 Applicant..... 5

1.1. Manufacturer 5

1.2 Product Feature of Equipment Under Test 5

1.3 Product Specification subjective to this standard 6

1.4 Modification of EUT 6

1.5 Maximum ERP/EIRP Power, Frequency Tolerance, and Emission Designator 7

1.6 Testing Location 7

1.7 Applicable Standards 8

2 TEST CONFIGURATION OF EQUIPMENT UNDER TEST 9

2.1 Test Mode..... 9

2.2 Connection Diagram of Test System 11

2.3 Support Unit used in test configuration 11

2.4 Measurement Results Explanation Example 11

3 TEST RESULT 12

3.1 Conducted Output Power Measurement..... 12

3.2 Peak-to-Average Ratio 14

3.3 Effective Radiated Power and Effective Isotropic Radiated Power Measurement 28

3.4 99% Occupied Bandwidth and 26dB Bandwidth Measurement..... 35

3.5 Band Edge Measurement..... 55

3.6 Conducted Spurious Emission Measurement 62

3.7 Field Strength of Spurious Radiation Measurement 81

3.8 Frequency Stability Measurement..... 101

4 LIST OF MEASURING EQUIPMENT 105

5 UNCERTAINTY OF EVALUATION 106



SUMMARY OF TEST RESULT

Report Section	FCC Rule	Description	Limit	Result	Remark
3.1	§2.1046	Conducted Output Power	N/A	PASS	-
3.2	§24.232(d)	Peak-to-Average Ratio	<13 dB	PASS	-
3.3	§22.913(a)(2)	Effective Radiated Power	< 7 Watts	PASS	-
	§24.232(c)	Equivalent Isotropic Radiated Power	< 2 Watts	PASS	-
3.4	§2.1049 §22.917(b) §24.238(b)	Occupied Bandwidth	N/A	PASS	-
3.5	§2.1051 §22.917(a) §24.238(a)	Band Edge Measurement	< 43+10log ₁₀ (P[Watts])	PASS	-
3.6	§2.1051 §22.917(a) §24.238(a)	Conducted Spurious Emission	< 43+10log ₁₀ (P[Watts])	PASS	-
3.7	§2.1053 §22.917(a) §24.238(a)	Field Strength of Spurious Radiation	< 43+10log ₁₀ (P[Watts])	PASS	Under limit 24.70 dB at 7520.000 MHz
3.8	§2.1055 §22.355	Frequency Stability for Temperature & Voltage	< 2.5 ppm for Part 22	PASS	-
	§2.1055 §24.235		Within Authorized Band		



1 General Description

1.1 Applicant

Motorola Mobility, LLC
222 W. Merchandise Mart Plaza, Chicago IL 60654 USA

1.1.1. Manufacturer

Motorola Mobility, LLC
222 W. Merchandise Mart Plaza, Chicago IL 60654 USA

1.2 Product Feature of Equipment Under Test

Product Feature	
Equipment	Mobile Cellular Phone
Brand Name	Motorola
Model Name	4245
FCC ID	IHDT56QC2
IMEI Code	IMEI 1 : 353336060018778 IMEI 2 : 353336060018786
EUT supports Radios application	GSM/EGPRS/WCDMA/HSPA/LTE WLAN 11b/g/n HT20 Bluetooth v4.0 - LE
HW Version	P2B
EUT Stage	Identical Prototype

Remark: The above EUT's information was declared by manufacturer. Please refer to the specifications or user's manual for more detailed description.

Accessory List	
AC Adapter	Brand Name : Motorola
	Model Name : SPN5862A
Earphone	Brand Name : Motorola
	Model Name : SJYN1181B

1.3 Product Specification subjective to this standard

Product Specification subjective to this standard	
Tx Frequency	GSM850: 824.2 MHz ~ 848.8 MHz GSM1900: 1850.2 MHz ~ 1909.8MHz WCDMA Band V: 826.4 MHz ~ 846.6 MHz WCDMA Band II: 1852.4 MHz ~ 1907.6 MHz
Rx Frequency	GSM850: 869.2 MHz ~ 893.8 MHz GSM1900: 1930.2 MHz ~ 1989.8 MHz WCDMA Band V: 871.4 MHz ~ 891.6 MHz WCDMA Band II: 1932.4 MHz ~ 1987.6 MHz
Maximum Output Power to Antenna	GSM850 : 32.39 dBm GSM1900 : 29.10 dBm WCDMA Band V : 23.20 dBm WCDMA Band II : 23.25 dBm
99% Occupied Bandwidth	GSM850: 0.247MHz GSM1900: 0.245MHz WCDMA Band V: 4.16MHz WCDMA Band II: 4.18MHz
Antenna Type	Fixed Internal Antenna
Type of Modulation	GSM: GMSK GPRS: GMSK EDGE: GMSK / 8PSK WCDMA: QPSK (Uplink) HSDPA: QPSK (Downlink) HSUPA: QPSK (Uplink)

1.4 Modification of EUT

No modifications are made to the EUT during all test items.



1.5 Maximum ERP/EIRP Power, Frequency Tolerance, and Emission Designator

FCC Rule	System	Type of Modulation	Maximum ERP/EIRP (W)	Frequency Tolerance (ppm)	Emission Designator
Part 22	GSM850 GSM	GMSK	0.9333	0.0275 ppm	246KGXW
Part 22	GSM850 EDGE class 8	8PSK	0.1503	0.0120 ppm	247KG7W
Part 22	WCDMA Band V RMC 12.2Kbps	QPSK	0.1038	0.0203 ppm	4M16F9W
Part 24	GSM1900 GSM	GMSK	0.6053	0.0160 ppm	245KGXW
Part 24	GSM1900 EDGE class 8	8PSK	0.1986	0.0048 ppm	244KG7W
Part 24	WCDMA Band II RMC 12.2Kbps	QPSK	0.1766	0.0117 ppm	4M18F9W

1.6 Testing Location

Sporton Lab is accredited to ISO 17025 by Taiwan Accreditation Foundation (TAF code : 1190) and the FCC designation No. TW1022 under the FCC 2.948(e) by Mutual Recognition Agreement (MRA) in FCC Test.

Test Site	SPORTON INTERNATIONAL INC.	
Test Site Location	No. 52, Hwa Ya 1 st Rd., Hwa Ya Technology Park, Kwei-Shan Hsiang, Tao Yuan Hsien, Taiwan, R.O.C. TEL: +886-3-327-3456 FAX: +886-3-328-4978	
Test Site No.	Sporton Site No.	
	TH02-HY	03CH07-HY



1.7 Applicable Standards

According to the specifications of the manufacturer, the EUT must comply with the requirements of the following standards:

- ♦ FCC 47 CFR Part 2, 22(H), 24(E)
- ♦ ANSI / TIA / EIA-603-C-2004
- ♦ FCC KDB 971168 D01 Power Meas. License Digital Systems v02r02

Remark:

1. All test items were verified and recorded according to the standards and without any deviation during the test.
2. This EUT has also been tested and complied with the requirements of FCC Part 15, Subpart B, recorded in a separate test report.



2 Test Configuration of Equipment Under Test

2.1 Test Mode

Antenna port conducted and radiated test items were performed according to KDB 971168 D01 Power Meas. License Digital Systems v02r02 with maximum output power.

Radiated measurements were performed with rotating EUT in different three orthogonal test planes to find the maximum emission.

Radiated emissions were investigated as following frequency range:

1. 30 MHz to 9000 MHz for GSM850 and WCDMA Band V.
2. 30 MHz to 19000 MHz for GSM1900 and WCDMA Band II.

All modes and data rates and positions were investigated.

Test modes are chosen to be reported as the worst case configuration below:

Test Modes		
Band	Radiated TCs	Conducted TCs
GSM 850	<ul style="list-style-type: none"> ■ GSM Link ■ EDGE class 8 Link 	<ul style="list-style-type: none"> ■ GSM Link ■ EDGE class 8 Link
GSM 1900	<ul style="list-style-type: none"> ■ GSM Link ■ EDGE class 8 Link 	<ul style="list-style-type: none"> ■ GSM Link ■ EDGE class 8 Link
WCDMA Band V	<ul style="list-style-type: none"> ■ RMC 12.2Kbps Link 	<ul style="list-style-type: none"> ■ RMC 12.2Kbps Link
WCDMA Band II	<ul style="list-style-type: none"> ■ RMC 12.2Kbps Link 	<ul style="list-style-type: none"> ■ RMC 12.2Kbps Link

Note: The maximum power levels are chosen to test as the worst case configuration as follows:

GSM multi-slot class 8 mode for GMSK modulation,

EDGE multi-slot class 8 mode for 8PSK modulation,

RMC 12.2Kbps mode for WCDMA band V and WCDMA band II,

only these modes were used for all tests. In addition to above worst-case test, below investigating on all data rates, and all modes are compliance with each FCC test case which has specific test limits. For spurious emissions at antenna port, the EUT was investigated the band edges on low and high channels, and the unwanted spurious emissions on middle channel for all modes, the results are pass, then only the worst-results were reported in the test report. The Radiated Spurious emissions for GSM/GPRS modes were investigated on the middle channel and the passed results were not worse than those data tested from the highest power channels.



Conducted Power Measurement Results:

Conducted Power (*Unit: dBm)						
Band	GSM850			GSM1900		
Channel	128	189	251	512	661	810
Frequency	824.2	836.4	848.8	1850.2	1880.0	1909.8
GSM	32.24	32.39	32.34	28.92	29.10	29.04
GPRS class 8	32.22	32.34	32.30	28.90	29.09	29.02
GPRS class 10	29.05	29.15	29.10	25.84	25.89	25.87
GPRS class 11	26.99	27.10	27.03	23.99	24.11	24.05
GPRS class 12	25.60	25.70	25.66	22.60	22.80	22.70
EGPRS class 8	26.20	26.36	26.29	25.01	25.11	25.08
EGPRS class 10	23.59	23.67	23.61	22.51	22.57	22.55
EGPRS class 11	22.08	22.20	22.10	20.52	20.75	20.60
EGPRS class 12	20.75	20.83	20.79	19.30	19.44	19.38

Conducted Power (*Unit: dBm)						
Band	WCDMA Band V			WCDMA Band II		
Channel	4132	4182	4233	9262	9400	9538
Frequency	826.4	836.4	846.6	1852.4	1880.0	1907.6
RMC 12.2K	23.20	23.00	23.10	23.25	23.15	23.12
HSDPA Subtest-1	22.25	22.10	22.20	22.38	22.35	22.27
HSDPA Subtest-2	22.24	22.09	22.19	22.35	22.33	22.25
HSDPA Subtest-3	21.74	21.59	21.71	21.91	21.87	21.79
HSDPA Subtest-4	21.70	21.55	21.67	21.89	21.84	21.75
HSUPA Subtest-1	22.20	22.03	22.14	22.50	22.45	22.41
HSUPA Subtest-2	21.25	21.15	21.20	21.35	21.29	21.22
HSUPA Subtest-3	21.65	21.58	21.63	21.71	21.60	21.53
HSUPA Subtest-4	21.26	21.17	21.22	21.48	21.42	21.31
HSUPA Subtest-5	22.30	22.25	22.27	22.40	22.39	22.32

2.2 Connection Diagram of Test System

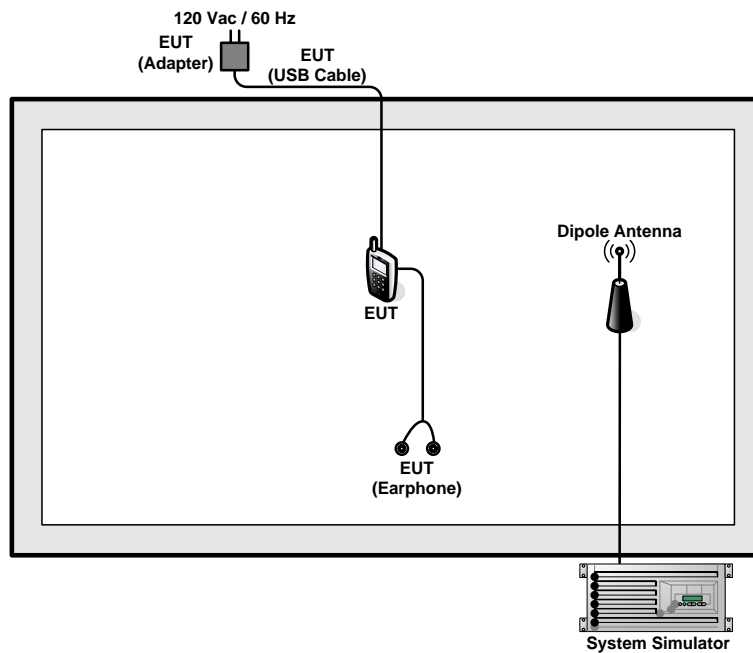

2.3 Support Unit used in test configuration

Item	Equipment	Trade Name	Model No.	FCC ID	Data Cable	Power Cord
1.	System Simulator	R&S	CMU 200	N/A	N/A	Unshielded, 1.8 m

2.4 Measurement Results Explanation Example

For all conducted test items:

The offset level is set in the spectrum analyzer to compensate the RF cable loss and attenuator factor between RF conducted output port and spectrum analyzer. With the offset compensation, the spectrum analyzer reading level will be exactly the RF output level.

The spectrum analyzer offset is derived from RF cable loss and attenuator factor.

Offset = RF cable loss + attenuator factor.

The following shows an offset computation example with RF cable loss 4.2 dB and a 10dB attenuator.

Example :

$$\begin{aligned} \text{Offset(dB)} &= \text{RF cable loss(dB)} + \text{attenuator factor(dB)} \\ &= 4.2 + 10 = 14.2 \text{ (dB)} \end{aligned}$$

3 Test Result

3.1 Conducted Output Power Measurement

3.1.1 Description of the Conducted Output Power Measurement

A system simulator was used to establish communication with the EUT. Its parameters were set to enforce EUT transmitting at the maximum power. The measured power in the radio frequency on the transmitter output terminals shall be reported.

3.1.2 Measuring Instruments

The measuring equipment is listed in the section 4 of this test report.

3.1.3 Test Procedures

1. The transmitter output port was connected to the system simulator.
2. Set EUT at maximum power through system simulator.
3. Select lowest, middle, and highest channels for each band and different modulation.
4. Measure the maximum burst average power for GSM and maximum average power for other modulation signal.

3.1.4 Test Setup

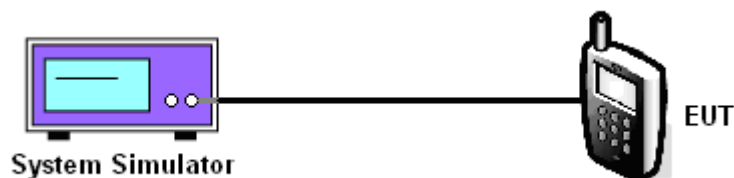



3.1.5 Test Result of Conducted Output Power

Cellular Band									
Modes	GSM850 (GSM)			GSM850 (EDGE class 8)			WCDMA Band V (RMC 12.2Kbps)		
Channel	128 (Low)	189 (Mid)	251 (High)	128 (Low)	189 (Mid)	251 (High)	4132 (Low)	4182 (Mid)	4233 (High)
Frequency (MHz)	824.2	836.4	848.8	824.2	836.4	848.8	826.4	836.4	846.6
Conducted Power (dBm)	32.24	32.39	32.34	26.20	26.36	26.29	23.20	23.00	23.10

PCS Band									
Modes	GSM1900 (GSM)			GSM1900 (EDGE class 8)			WCDMA Band II (RMC 12.2Kbps)		
Channel	512 (Low)	661 (Mid)	810 (High)	512 (Low)	661 (Mid)	810 (High)	9262 (Low)	9400 (Mid)	9538 (High)
Frequency (MHz)	1850.2	1880	1909.8	1850.2	1880	1909.8	1852.4	1880	1907.6
Conducted Power (dBm)	28.92	29.10	29.04	25.01	25.11	25.08	23.25	23.15	23.12

Note: maximum burst average power for GSM.

3.2 Peak-to-Average Ratio

3.2.1 Description of the PAR Measurement

The peak-to-average ratio (PAR) of the transmission may not exceed 13 dB.

3.2.2 Measuring Instruments

The measuring equipment is listed in the section 4 of this test report.

3.2.3 Test Procedures

1. The testing follows FCC KDB 971168 v02r02 Section 5.7.1.
2. The EUT was connected to spectrum analyzer and system simulator via a power divider.
3. Set EUT to transmit at maximum output power.
4. For GSM/EGPRS operating modes, signal gating is implemented on the spectrum analyzer by triggering from the system simulator.
5. Set the CCDF (Complementary Cumulative Distribution Function) option of the spectrum analyzer.
Record the maximum PAPR level associated with a probability of 0.1%.

3.2.4 Test Setup

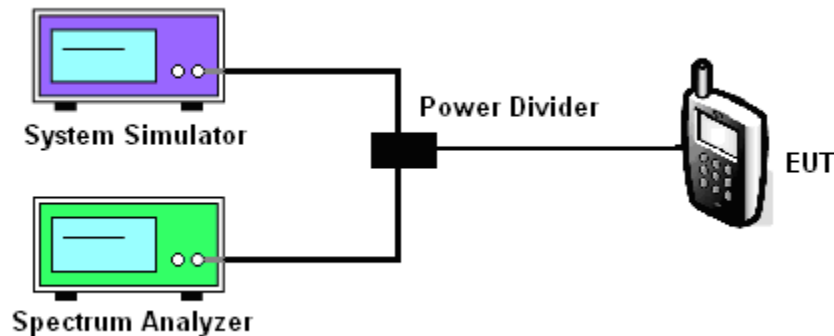



3.2.5 Test Result of Peak-to-Average Ratio

Cellular Band									
Modes	GSM850 (GSM)			GSM850 (EDGE class 8)			WCDMA Band V (RMC 12.2Kbps)		
Channel	128 (Low)	189 (Mid)	251 (High)	128 (Low)	189 (Mid)	251 (High)	4132 (Low)	4182 (Mid)	4233 (High)
Frequency (MHz)	824.2	836.4	848.8	824.2	836.4	848.8	826.4	836.4	846.6
Peak-to-Average Ratio (dB)	0.32	0.28	0.24	3.40	3.48	3.36	3.44	3.36	3.44

PCS Band									
Modes	GSM1900 (GSM)			GSM1900 (EDGE class 8)			WCDMA Band II (RMC 12.2Kbps)		
Channel	512 (Low)	661 (Mid)	810 (High)	512 (Low)	661 (Mid)	810 (High)	9262 (Low)	9400 (Mid)	9538 (High)
Frequency (MHz)	1850.2	1880	1909.8	1850.2	1880	1909.8	1852.4	1880	1907.6
Peak-to-Average Ratio (dB)	0.24	0.20	0.28	3.44	3.24	3.44	3.20	3.24	3.28



3.2.6 Test Result (Plots) of Peak-to-Average Ratio

Band :	GSM 850	Test Mode :	GSM Link (GMSK)
--------	---------	-------------	-----------------

Peak-to-Average Ratio on Channel 128 (824.2 MHz)

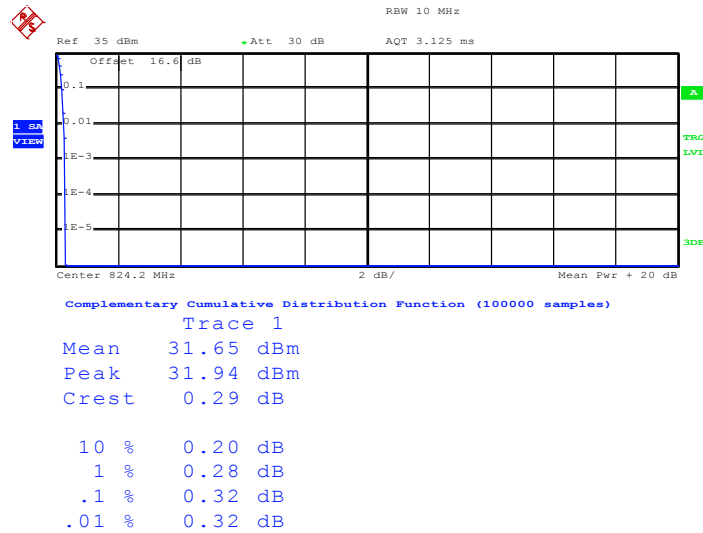

Date: 7.DEC.2014 16:37:22

Peak-to-Average Ratio on Channel 189 (836.4 MHz)

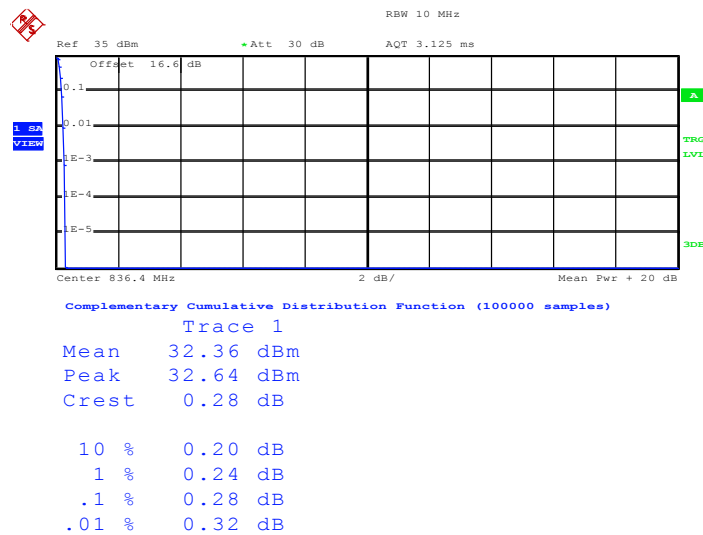

Date: 7.DEC.2014 16:37:54



Peak-to-Average Ratio on Channel 251 (848.8 MHz)

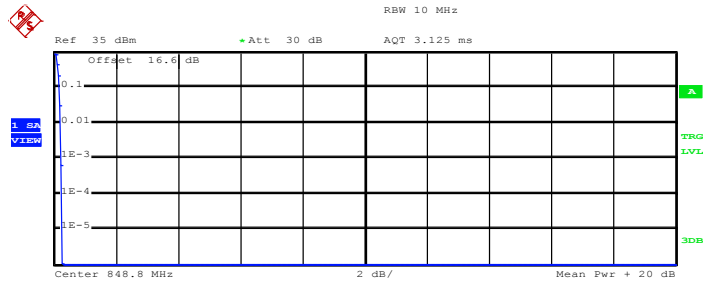

Complementary Cumulative Distribution Function (100000 samples)

Trace 1

Mean	32.36 dBm
Peak	32.64 dBm
Crest	0.28 dB
10 %	0.20 dB
1 %	0.24 dB
.1 %	0.24 dB
.01 %	0.28 dB

Date: 7.DEC.2014 16:38:19



Band :	GSM 850	Test Mode :	EDGE class 8 Link (8PSK)
---------------	---------	--------------------	--------------------------

Peak-to-Average Ratio on Channel 128 (824.2 MHz)

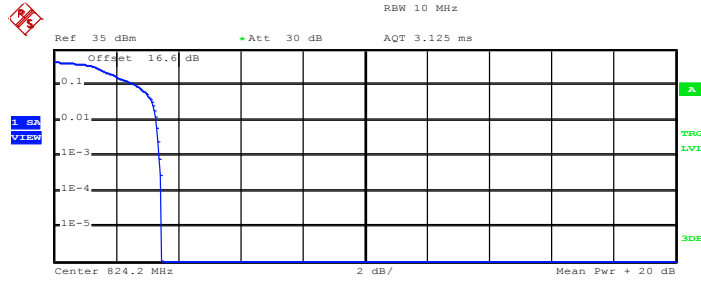

Complementary Cumulative Distribution Function (100000 samples)

Trace 1	
Mean	25.29 dBm
Peak	28.76 dBm
Crest	3.47 dB
10 %	2.68 dB
1 %	3.28 dB
.1 %	3.40 dB
.01 %	3.48 dB

Date: 7.DEC.2014 17:10:50

Peak-to-Average Ratio on Channel 189 (836.4 MHz)

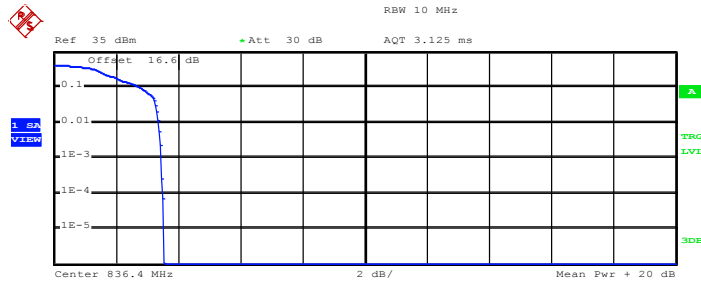

Complementary Cumulative Distribution Function (100000 samples)

Trace 1	
Mean	25.78 dBm
Peak	29.33 dBm
Crest	3.55 dB
10 %	2.80 dB
1 %	3.36 dB
.1 %	3.48 dB
.01 %	3.52 dB

Date: 7.DEC.2014 17:11:19



Peak-to-Average Ratio on Channel 251 (848.8 MHz)

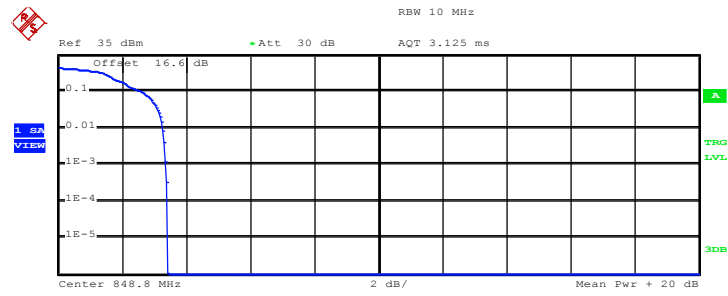

Complementary Cumulative Distribution Function (100000 samples)

Trace 1

Mean	26.25 dBm
Peak	29.68 dBm
Crest	3.43 dB
10 %	2.64 dB
1 %	3.28 dB
.1 %	3.36 dB
.01 %	3.44 dB

Date: 7.DEC.2014 17:11:45



Band :	GSM 1900	Test Mode :	GSM Link (GMSK)
---------------	----------	--------------------	-----------------

Peak-to-Average Ratio on Channel 512 (1850.2 MHz)

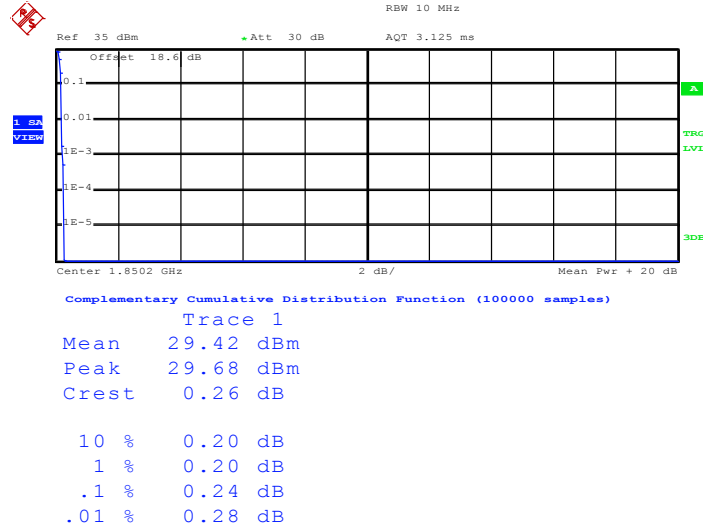

Date: 8.DEC.2014 10:20:50

Peak-to-Average Ratio on Channel 661 (1880.0 MHz)

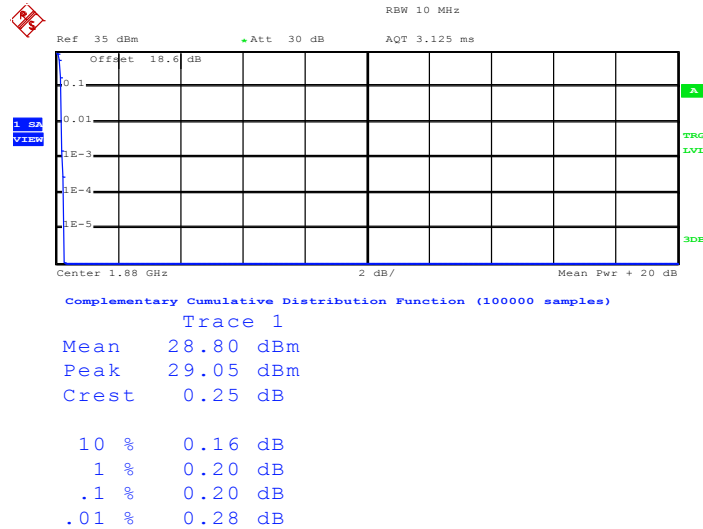

Date: 8.DEC.2014 10:21:25



Peak-to-Average Ratio on Channel 810 (1909.8 MHz)

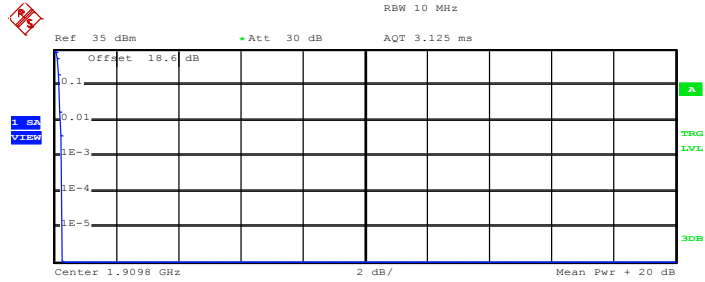

Complementary Cumulative Distribution Function (100000 samples)

Trace 1

Mean	28.94 dBm
Peak	29.19 dBm
Crest	0.25 dB
10 %	0.20 dB
1 %	0.24 dB
.1 %	0.28 dB
.01 %	0.28 dB

Date: 8.DEC.2014 10:22:02



Band :	GSM 1900	Test Mode :	EDGE class 8 Link (8PSK)
---------------	----------	--------------------	--------------------------

Peak-to-Average Ratio on Channel 512 (1850.2 MHz)

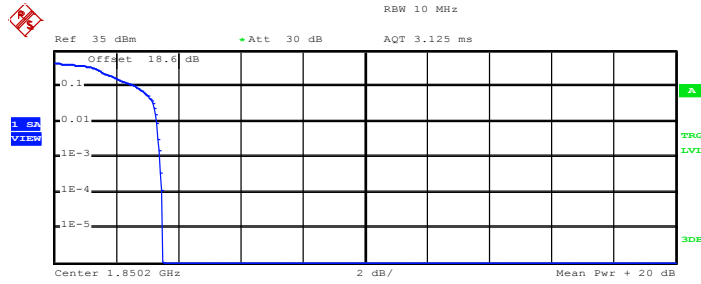

Complementary Cumulative Distribution Function (100000 samples)

Trace 1

Mean	22.59 dBm
Peak	26.08 dBm
Crest	3.49 dB
10 %	2.68 dB
1 %	3.32 dB
.1 %	3.44 dB
.01 %	3.48 dB

Date: 8.DEC.2014 10:33:05

Peak-to-Average Ratio on Channel 661 (1880.0 MHz)

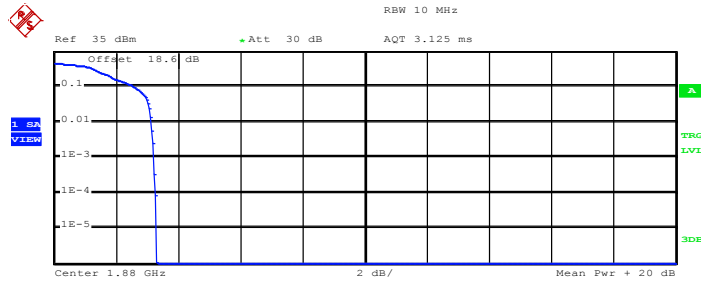

Complementary Cumulative Distribution Function (100000 samples)

Trace 1

Mean	22.58 dBm
Peak	25.87 dBm
Crest	3.29 dB
10 %	2.60 dB
1 %	3.16 dB
.1 %	3.24 dB
.01 %	3.28 dB

Date: 8.DEC.2014 10:33:37



Peak-to-Average Ratio on Channel 810 (1909.8 MHz)

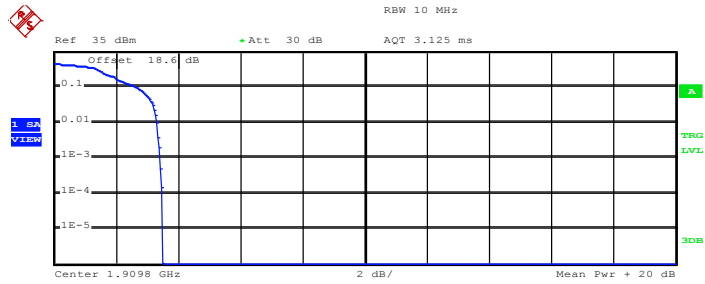

Complementary Cumulative Distribution Function (100000 samples)

Trace 1

Mean	21.89 dBm
Peak	25.38 dBm
Crest	3.49 dB
10 %	2.68 dB
1 %	3.32 dB
.1 %	3.44 dB
.01 %	3.48 dB

Date: 8.DEC.2014 10:34:06



Band :	WCDMA Band V	Test Mode :	RMC 12.2Kbps Link (QPSK)
---------------	--------------	--------------------	--------------------------

Peak-to-Average Ratio on Channel 4132 (826.4 MHz)

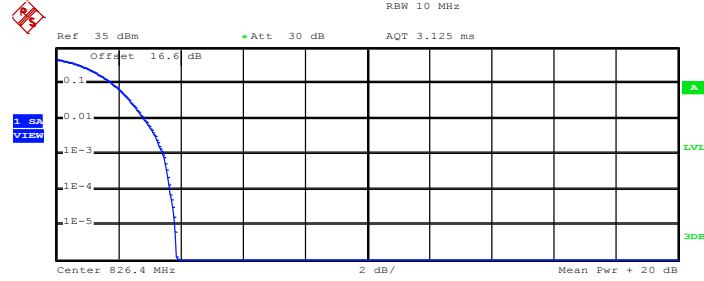

Complementary Cumulative Distribution Function (100000 samples)

Trace 1

Mean	19.80 dBm
Peak	23.68 dBm
Crest	3.88 dB
10 %	1.80 dB
1 %	2.84 dB
.1 %	3.44 dB
.01 %	3.68 dB

Date: 8.DEC.2014 10:09:06

Peak-to-Average Ratio on Channel 4182 (836.4 MHz)

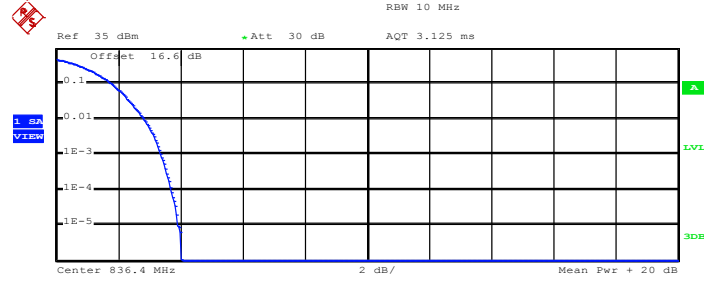

Complementary Cumulative Distribution Function (100000 samples)

Trace 1

Mean	19.86 dBm
Peak	23.89 dBm
Crest	4.04 dB
10 %	1.80 dB
1 %	2.84 dB
.1 %	3.36 dB
.01 %	3.72 dB

Date: 8.DEC.2014 10:09:16



Peak-to-Average Ratio on Channel 4233 (846.6 MHz)

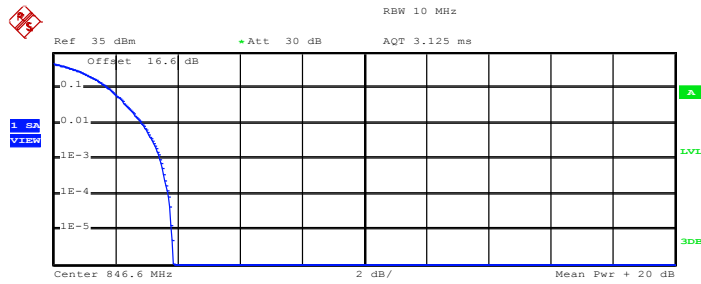

Complementary Cumulative Distribution Function (100000 samples)

Trace 1

Mean	19.82 dBm
Peak	23.68 dBm
Crest	3.87 dB
10 %	1.80 dB
1 %	2.88 dB
.1 %	3.44 dB
.01 %	3.72 dB

Date: 8.DEC.2014 10:09:31



Band :	WCDMA Band II	Test Mode :	RMC 12.2Kbps Link (QPSK)
---------------	---------------	--------------------	--------------------------

Peak-to-Average Ratio on Channel 9262 (1852.4 MHz)

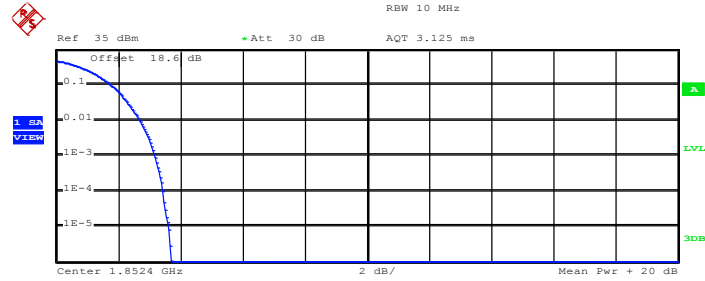

Complementary Cumulative Distribution Function (100000 samples)

Trace 1

Mean	20.06 dBm
Peak	23.75 dBm
Crest	3.69 dB
10 %	1.80 dB
1 %	2.72 dB
.1 %	3.20 dB
.01 %	3.44 dB

Date: 8.DEC.2014 10:49:53

Peak-to-Average Ratio on Channel 9400 (1880.0 MHz)

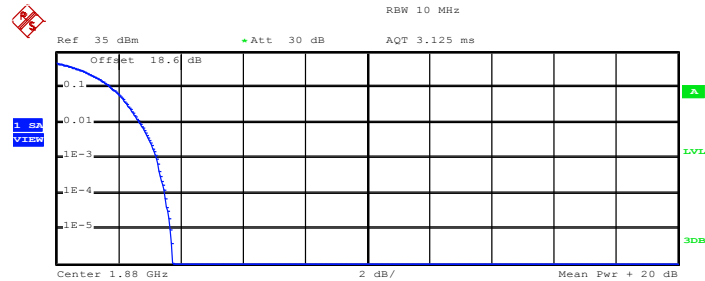

Complementary Cumulative Distribution Function (100000 samples)

Trace 1

Mean	20.08 dBm
Peak	23.82 dBm
Crest	3.74 dB
10 %	1.76 dB
1 %	2.72 dB
.1 %	3.24 dB
.01 %	3.52 dB

Date: 8.DEC.2014 10:50:02



Peak-to-Average Ratio on Channel 9538 (1907.6 MHz)

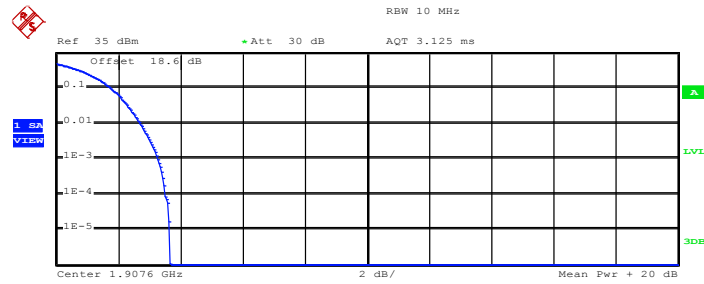

Complementary Cumulative Distribution Function (100000 samples)

Trace 1	
Mean	20.53 dBm
Peak	24.18 dBm
Crest	3.65 dB
10 %	1.76 dB
1 %	2.72 dB
.1 %	3.28 dB
.01 %	3.52 dB

Date: 8.DEC.2014 10:50:12



3.3 Effective Radiated Power and Effective Isotropic Radiated Power Measurement

3.3.1 Description of the ERP/EIRP Measurement

The substitution method, in ANSI / TIA / EIA-603-C-2004, was used for ERP/EIRP measurement, and the spectrum analyzer configuration follows KDB 971168 D01 Power Meas. License Digital Systems v02r02. The ERP of mobile transmitters must not exceed 7 Watts and the EIRP of mobile transmitters are limited to 2 Watts.

3.3.2 Measuring Instruments

The measuring equipment is listed in the section 4 of this test report.

3.3.3 Test Procedures

1. The testing follows FCC KDB 971168 v02r02 Section 5.2.1. (for CDMA/WCDMA), Section 5.2.2.2 (for GSM/GPRS/EDGE) and ANSI / TIA-603-C-2004 Section 2.2.17.
2. The EUT was placed on a non-conductive rotating platform 0.8 meters high in a semi-anechoic chamber. The radiated emission at the fundamental frequency was measured at 3 m with a test antenna and a spectrum analyzer with RMS detector per section 5. of KDB 971168 D01.
3. During the measurement, the system simulator parameters were set to force the EUT transmitting at maximum output power. The maximum emission was recorded from analyzer power level (LVL) from the 360 degrees rotation of the turntable and the test antenna raised and lowered over a range from 1 to 4 meters in both horizontally and vertically polarized orientations.
4. Effective Isotropic Radiated Power (EIRP) was measured by substitution method according to TIA/EIA-603-C. The EUT was replaced by dipole antenna (substitution antenna) at the same location, and then a known power from S.G. was applied into the dipole antenna through a Tx cable, and then recorded the maximum Analyzer reading through raised and lowered the test antenna. The correction factor (in dB) = S.G. - Tx Cable loss + Substitution antenna gain - Analyzer reading. Then the EUT's EIRP was calculated with the correction factor, $EIRP = LVL + \text{Correction factor}$ and $ERP = EIRP - 2.15$.



	GSM/GPRS/EDGE	WCDMA/HSPA
SPAN	500kHz	10MHz
RBW	10kHz	100kHz
VBW	30kHz	300kHz
Detector	RMS	RMS
Trace	Average	Average
Average Type	Power	Power
Sweep Count	100	100

3.3.4 Test Setup

For ERP

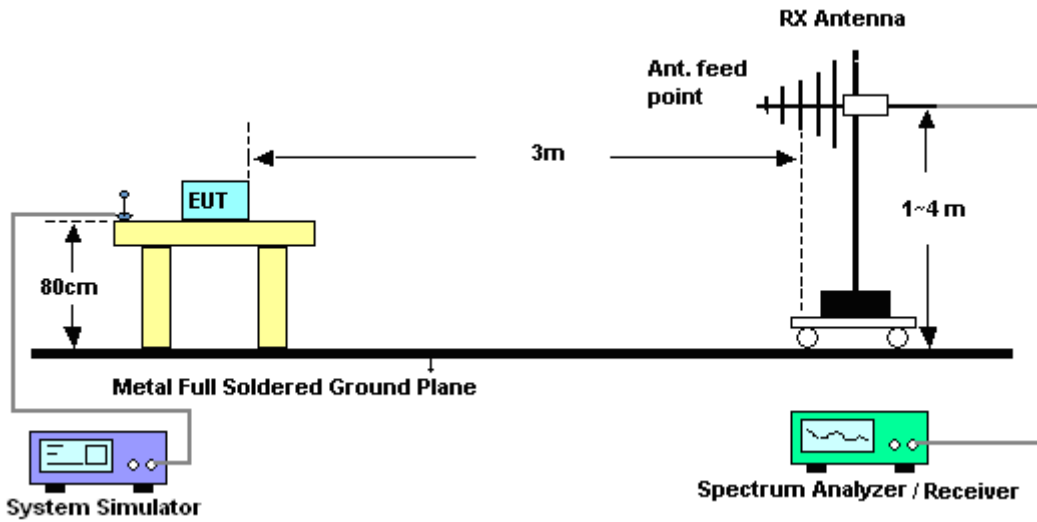

For EIRP

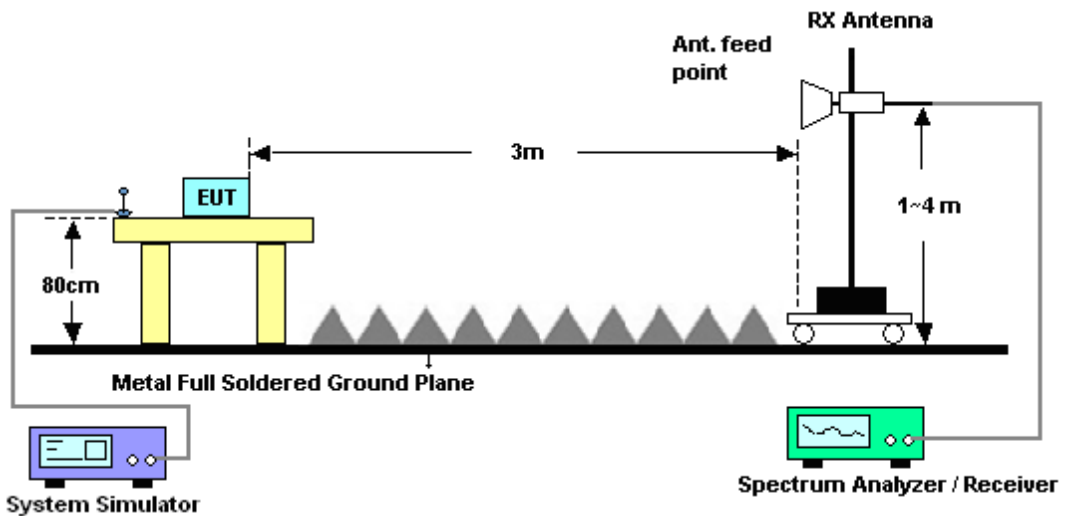



3.3.5 Test Result of ERP

GSM850 (GSM) Radiated Power ERP				
Horizontal Polarization				
Frequency (MHz)	LVL (dBm)	Correction Factor (dB)	ERP (dBm)	ERP (W)
824.2	-10.21	31.54	19.18	0.0828
836.4	-10.40	32.04	19.49	0.0889
848.8	-10.57	32.59	19.87	0.0971
Vertical Polarization				
Frequency (MHz)	LVL (dBm)	Correction Factor (dB)	ERP (dBm)	ERP (W)
824.2	-3.39	32.93	27.39	0.5483
836.4	-1.99	32.82	28.68	0.7379
848.8	-1.77	33.62	29.70	0.9333

* ERP = LVL (dBm) + Correction Factor (dB) – 2.15

GSM850 (EDGE class 8) Radiated Power ERP				
Horizontal Polarization				
Frequency (MHz)	LVL (dBm)	Correction Factor (dB)	ERP (dBm)	ERP (W)
824.2	-18.02	31.54	11.37	0.0137
836.4	-18.24	32.04	11.65	0.0146
848.8	-18.60	32.59	11.84	0.0153
Vertical Polarization				
Frequency (MHz)	LVL (dBm)	Correction Factor (dB)	ERP (dBm)	ERP (W)
824.2	-10.79	32.93	19.99	0.0998
836.4	-9.64	32.82	21.03	0.1268
848.8	-9.70	33.62	21.77	0.1503

* ERP = LVL (dBm) + Correction Factor (dB) – 2.15



WCDMA Band V (RMC 12.2Kbps) Radiated Power ERP				
Horizontal Polarization				
Frequency (MHz)	LVL (dBm)	Correction Factor (dB)	ERP (dBm)	ERP (W)
826.40	-20.26	31.44	9.03	0.0080
836.40	-20.46	32.04	9.43	0.0088
846.60	-20.42	32.63	10.06	0.0101
Vertical Polarization				
Frequency (MHz)	LVL (dBm)	Correction Factor (dB)	ERP (dBm)	ERP (W)
826.40	-12.89	32.78	17.74	0.0594
836.40	-11.75	32.82	18.92	0.0780
846.60	-11.09	33.4	20.16	0.1038

* ERP = LVL (dBm) + Correction Factor (dB) – 2.15



3.3.6 Test Result of EIRP

GSM1900 (GSM) Radiated Power EIRP				
Horizontal Polarization				
Frequency (MHz)	LVL (dBm)	Correction Factor (dB)	EIRP (dBm)	EIRP (W)
1850.2	-19.74	45.34	25.60	0.3631
1880.0	-19.58	46.01	26.43	0.4395
1909.8	-18.47	45.81	27.34	0.5420
Vertical Polarization				
Frequency (MHz)	LVL (dBm)	Correction Factor (dB)	EIRP (dBm)	EIRP (W)
1850.2	-22.32	49.22	26.90	0.4898
1880.0	-23.32	50.42	27.10	0.5129
1909.8	-21.18	49.00	27.82	0.6053

* EIRP = LVL (dBm) + Correction Factor (dB)

GSM1900 (EDGE class 8) Radiated Power EIRP				
Horizontal Polarization				
Frequency (MHz)	LVL (dBm)	Correction Factor (dB)	EIRP (dBm)	EIRP (W)
1850.2	-23.74	45.34	21.60	0.1445
1880.0	-23.65	46.01	22.36	0.1722
1909.8	-22.83	45.81	22.98	0.1986
Vertical Polarization				
Frequency (MHz)	LVL (dBm)	Correction Factor (dB)	EIRP (dBm)	EIRP (W)
1850.2	-26.33	49.22	22.89	0.1945
1880.0	-27.94	50.42	22.48	0.1770
1909.8	-26.14	49.00	22.86	0.1932

* EIRP = LVL (dBm) + Correction Factor (dB)



WCDMA Band II (RMC 12.2Kbps) Radiated Power EIRP				
Horizontal Polarization				
Frequency (MHz)	LVL (dBm)	Correction Factor (dB)	EIRP (dBm)	EIRP (W)
1852.40	-23.94	45.37	21.43	0.1390
1880.00	-24.21	46.01	21.80	0.1514
1907.60	-23.75	45.87	22.12	0.1629
Vertical Polarization				
Frequency (MHz)	LVL (dBm)	Correction Factor (dB)	EIRP (dBm)	EIRP (W)
1852.40	-26.88	49.23	22.35	0.1718
1880.00	-28.07	50.42	22.35	0.1718
1907.60	-26.57	49.04	22.47	0.1766

* EIRP = LVL (dBm) + Correction Factor (dB)

3.4 99% Occupied Bandwidth and 26dB Bandwidth Measurement

3.4.1 Description of 99% Occupied Bandwidth and 26dB Bandwidth Measurement

The 99% occupied bandwidth is the width of a frequency band such that, below the lower and above the upper frequency limits, the mean powers emitted are each equal to a specified percentage 0.5% of the total mean transmitted power.

The emission bandwidth is defined as the width of the signal between two points, located at the 2 sides of the carrier frequency, outside of which all emissions are attenuated at least 26 dB below the transmitter power.

3.4.2 Measuring Instruments

The measuring equipment is listed in the section 4 of this test report.

3.4.3 Test Procedures

5. The testing follows FCC KDB 971168 v02r02 Section 4.2.
6. The EUT was connected to the spectrum analyzer and system simulator via a power divider.
7. The RF output of the EUT was connected to the spectrum analyzer by RF cable and attenuator. The path loss was compensated to the results for each measurement.
8. The 99% occupied bandwidth were measured, set RBW= 1% of span, VBW= 3*RBW, sample detector, trace maximum hold.
9. The 26dB bandwidth were measured, set RBW= 1% of EBW, VBW= 3*RBW, peak detector, trace maximum hold.

3.4.4 Test Setup

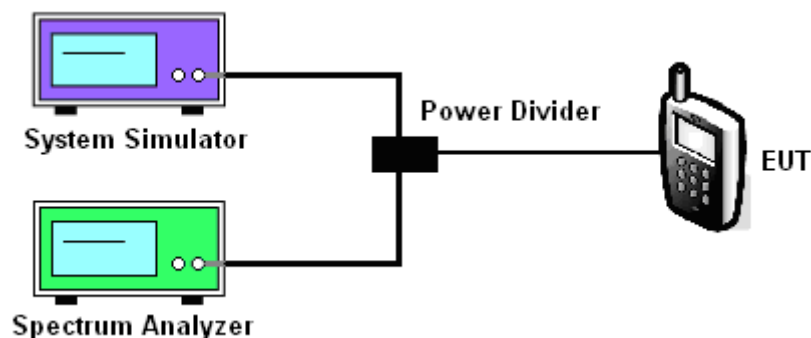



3.4.5 Test Result of Occupied Bandwidth and 26dB Bandwidth

Cellular Band						
Modes	GSM850 (GSM)			GSM850 (EDGE class 8)		
Channel	128 (Low)	189 (Mid)	251 (High)	128 (Low)	189 (Mid)	251 (High)
Frequency (MHz)	824.2	836.4	848.8	824.2	836.4	848.8
99% OBW (kHz)	246.00	244.00	245.00	245.00	246.00	247.00
26dB BW (kHz)	311.00	308.00	311.00	299.00	301.00	309.00

PCS Band						
Modes	GSM1900 (GSM)			GSM1900 (EDGE class 8)		
Channel	512 (Low)	661 (Mid)	810 (High)	512 (Low)	661 (Mid)	810 (High)
Frequency (MHz)	1850.2	1880	1909.8	1850.2	1880	1909.8
99% OBW (kHz)	245.00	243.00	244.00	243.00	244.00	241.00
26dB BW (kHz)	293.00	302.00	307.00	300.00	311.00	306.00

Cellular Band			
Modes	WCDMA Band V (RMC 12.2Kbps)		
Channel	4132 (Low)	4182 (Mid)	4233 (High)
Frequency (MHz)	826.4	836.4	846.6
99% OBW (MHz)	4.16	4.15	4.14
26dB BW (MHz)	4.66	4.64	4.66

PCS Band			
Modes	WCDMA Band II (RMC 12.2Kbps)		
Channel	9262 (Low)	9400 (Mid)	9538 (High)
Frequency (MHz)	1852.4	1880	1907.6
99% OBW (MHz)	4.18	4.17	4.17
26dB BW (MHz)	4.67	4.67	4.67



3.4.6 Test Result (Plots) of Occupied Bandwidth and 26dB Bandwidth

Band :	GSM 850	Test Mode :	GSM Link (GMSK)
--------	---------	-------------	-----------------

99% Occupied Bandwidth Plot on Channel 128 (824.2 MHz)

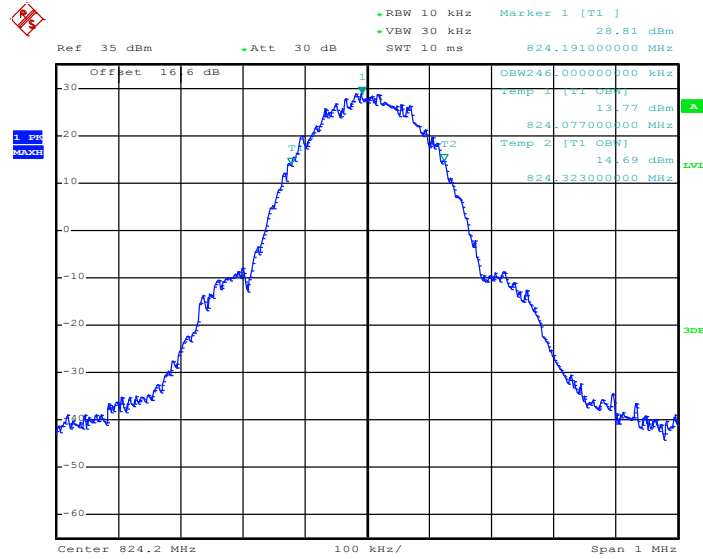

Date: 7.DEC.2014 16:21:32

26dB Bandwidth Plot on Channel 128 (824.2 MHz)

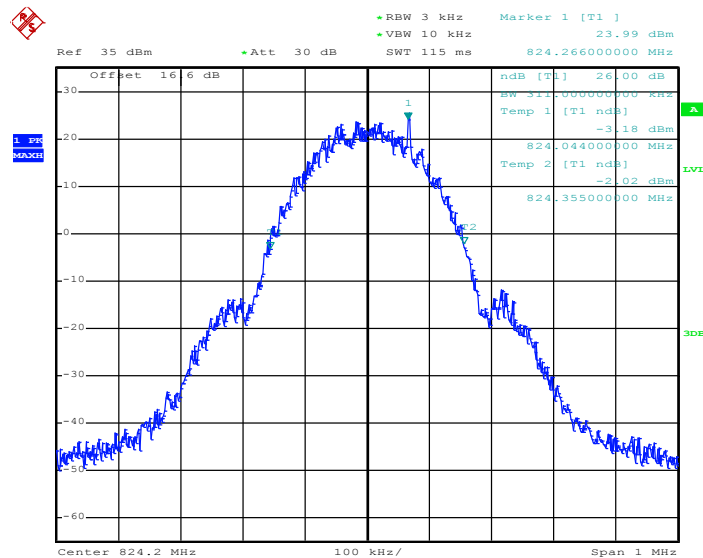

Date: 7.DEC.2014 16:19:26



99% Occupied Bandwidth Plot on Channel 189 (836.4 MHz)

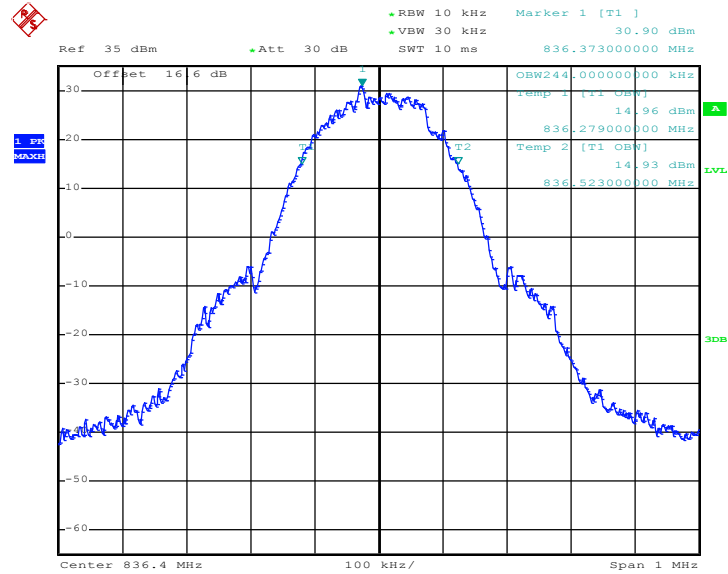

Date: 7.DEC.2014 16:22:00

26dB Bandwidth Plot on Channel 189 (836.4 MHz)

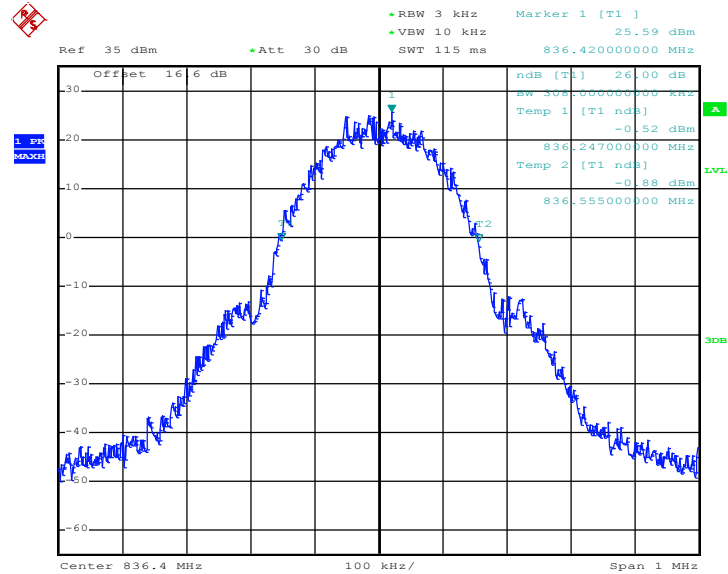

Date: 7.DEC.2014 16:19:54



99% Occupied Bandwidth Plot on Channel 251 (848.8 MHz)

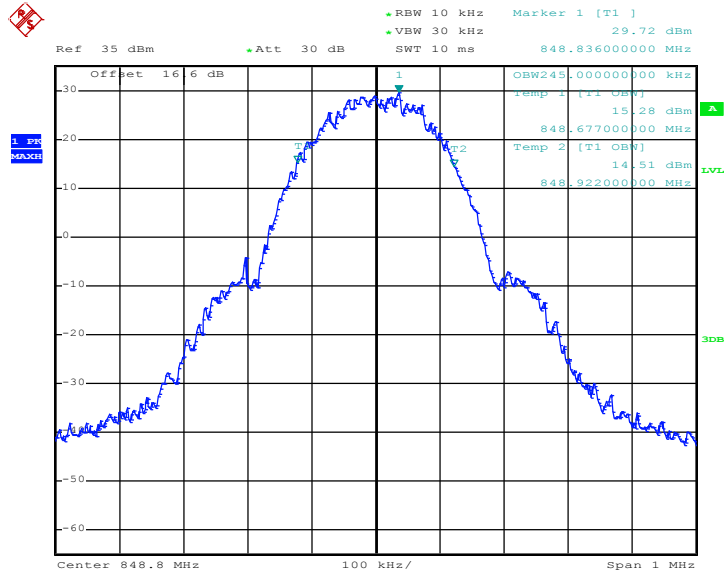

Date: 7.DEC.2014 16:22:29

26dB Bandwidth Plot on Channel 251 (848.8 MHz)

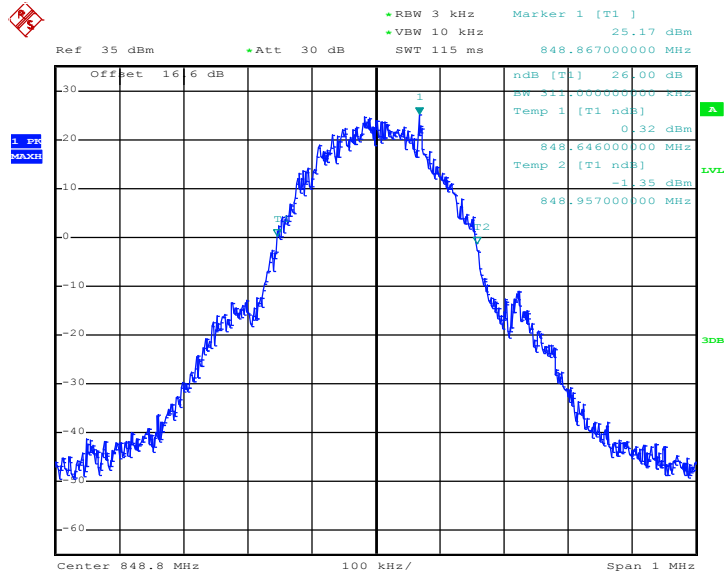

Date: 7.DEC.2014 16:20:22



Band :	GSM 850	Test Mode :	EDGE class 8 Link (8PSK)
---------------	---------	--------------------	--------------------------

99% Occupied Bandwidth Plot on Channel 128 (824.2 MHz)

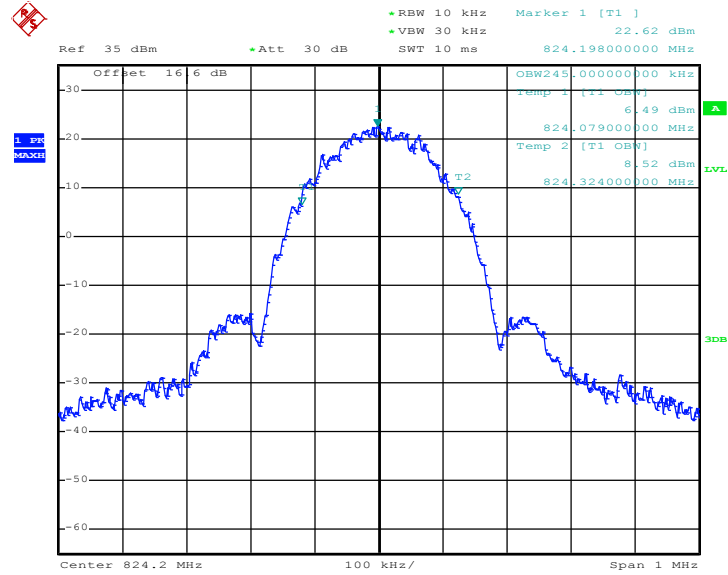

Date: 7.DEC.2014 16:51:01

26dB Bandwidth Plot on Channel 128 (824.2 MHz)

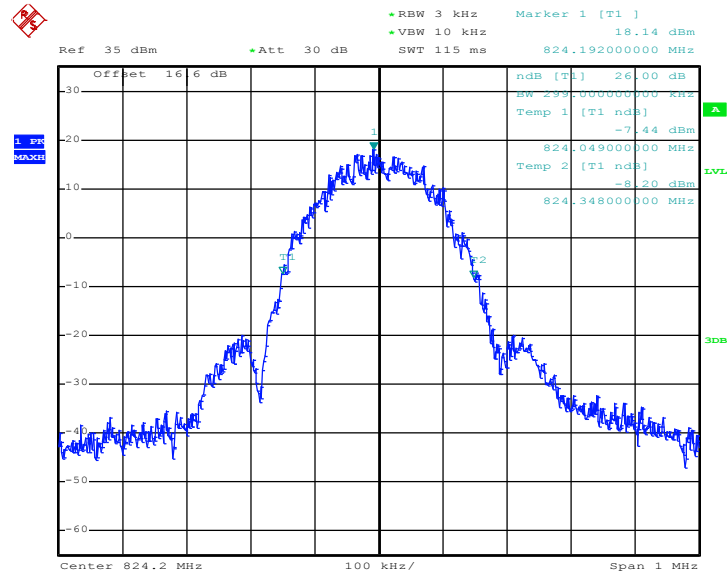

Date: 7.DEC.2014 16:42:37



99% Occupied Bandwidth Plot on Channel 189 (836.4 MHz)

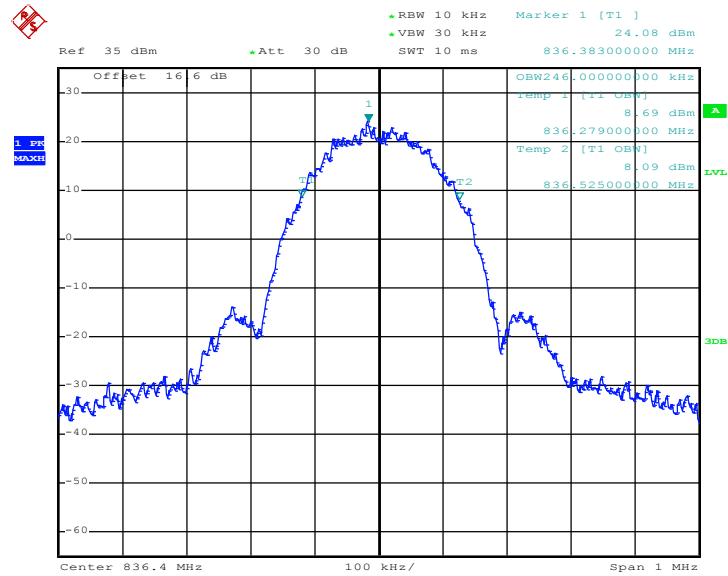

Date: 7.DEC.2014 16:51:39

26dB Bandwidth Plot on Channel 189 (836.4 MHz)

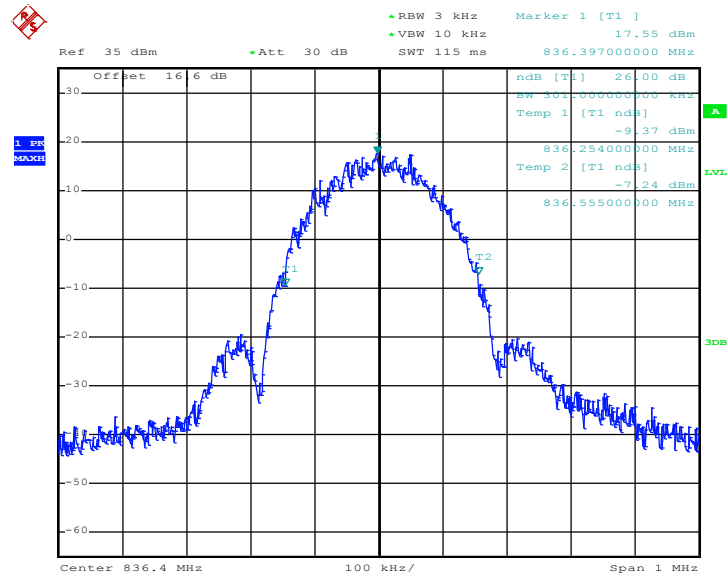

Date: 7.DEC.2014 16:43:12



99% Occupied Bandwidth Plot on Channel 251 (848.8 MHz)

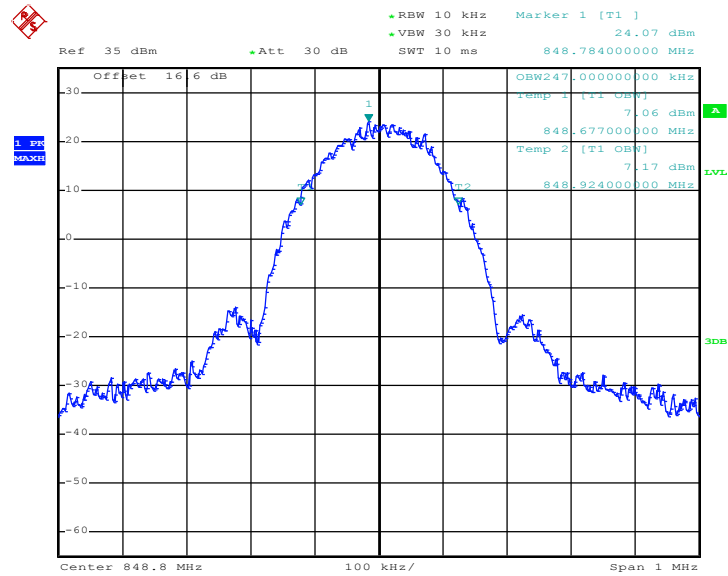

Date: 7.DEC.2014 16:52:12

26dB Bandwidth Plot on Channel 251 (848.8 MHz)

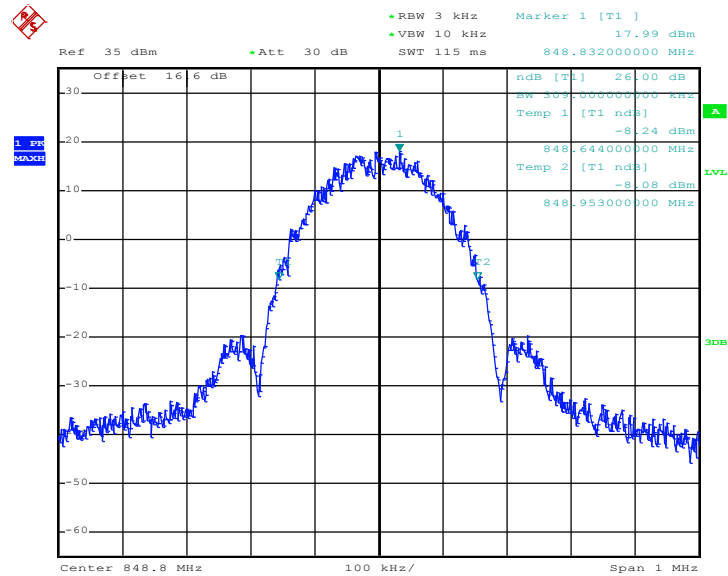

Date: 7.DEC.2014 16:44:29



Band :	GSM 1900	Test Mode :	GSM Link (GMSK)
---------------	----------	--------------------	-----------------

99% Occupied Bandwidth Plot on Channel 512 (1850.2 MHz)

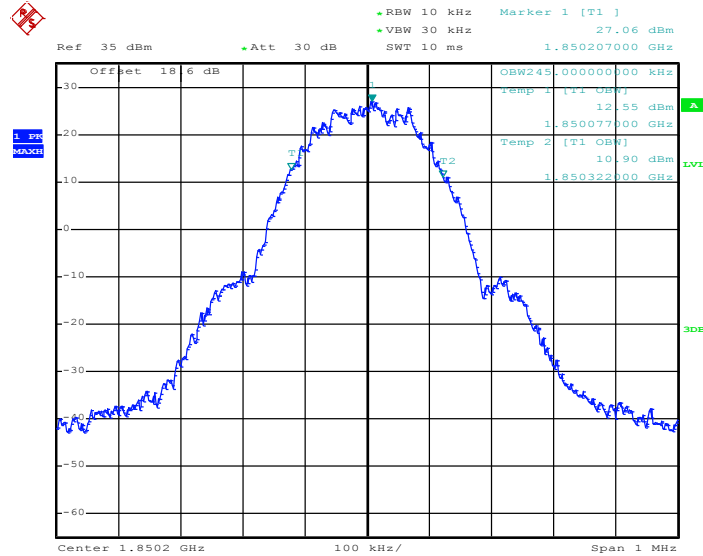

Date: 8.DEC.2014 10:14:43

26dB Bandwidth Plot on Channel 512 (1850.2 MHz)

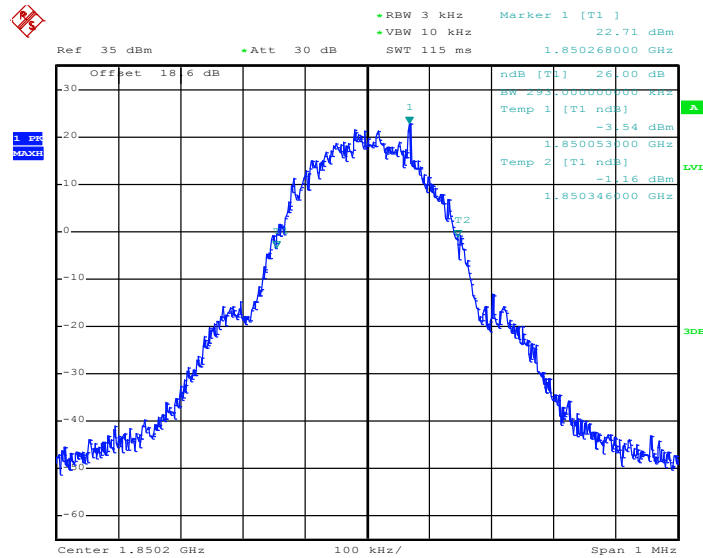

Date: 8.DEC.2014 10:12:38



99% Occupied Bandwidth Plot on Channel 661 (1880.0 MHz)

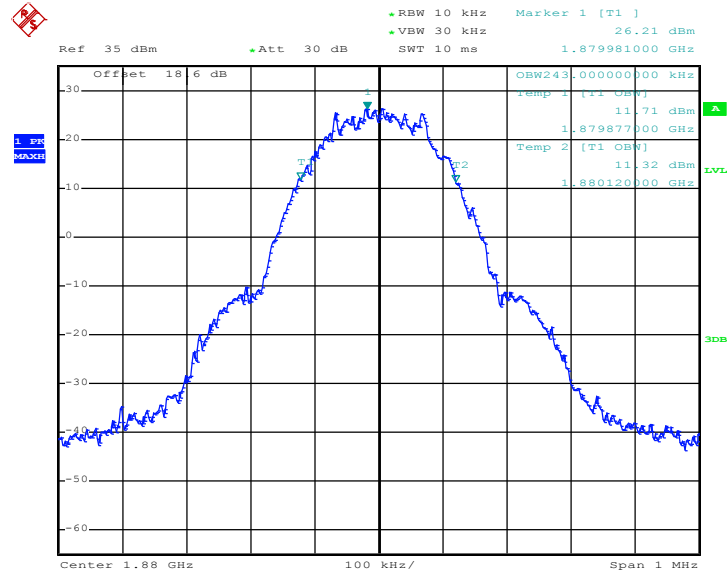

Date: 8.DEC.2014 10:15:11

26dB Bandwidth Plot on Channel 661 (1880.0 MHz)

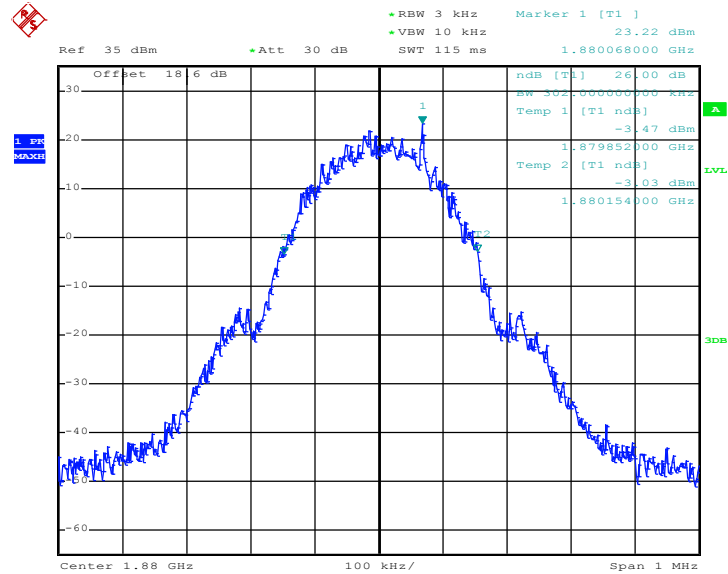

Date: 8.DEC.2014 10:13:06



99% Occupied Bandwidth Plot on Channel 810 (1909.8 MHz)

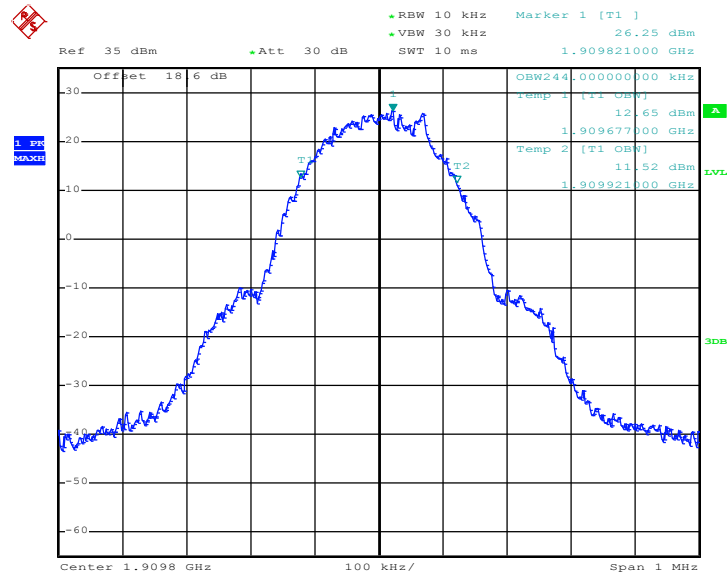

Date: 8.DEC.2014 10:15:39

26dB Bandwidth Plot on Channel 810 (1909.8 MHz)

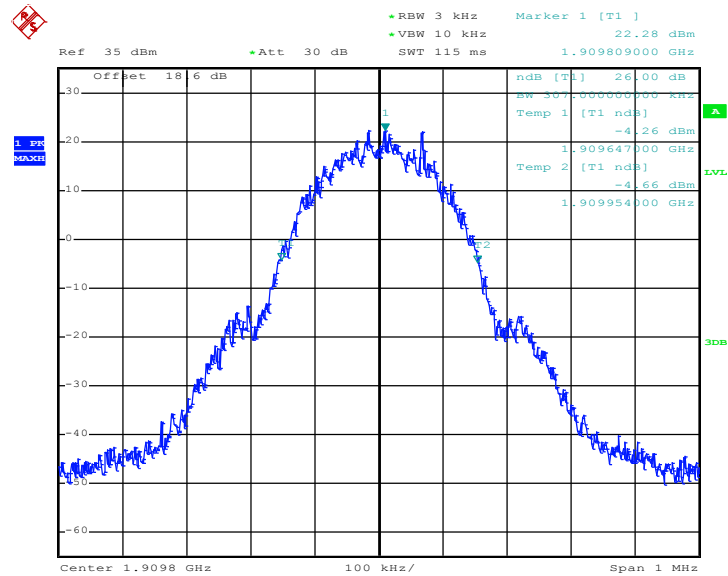

Date: 8.DEC.2014 10:13:34



Band :	GSM 1900	Test Mode :	EDGE class 8 Link (8PSK)
---------------	----------	--------------------	--------------------------

99% Occupied Bandwidth Plot on Channel 512 (1850.2 MHz)

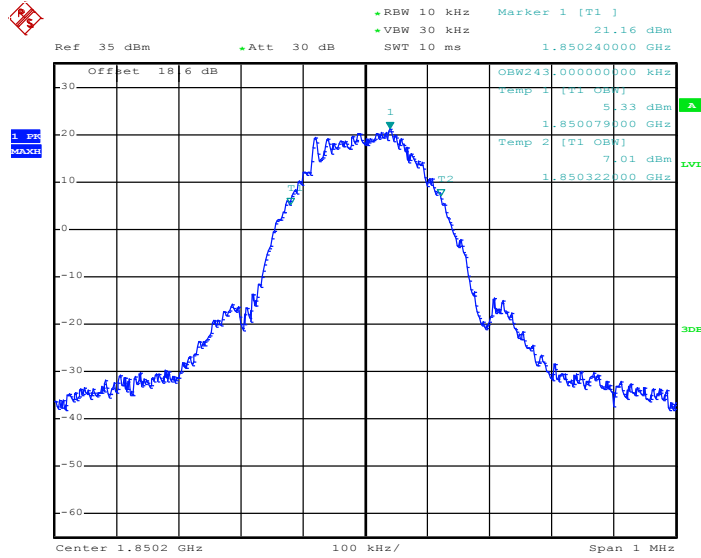

Date: 8.DEC.2014 10:26:52

26dB Bandwidth Plot on Channel 512 (1850.2 MHz)

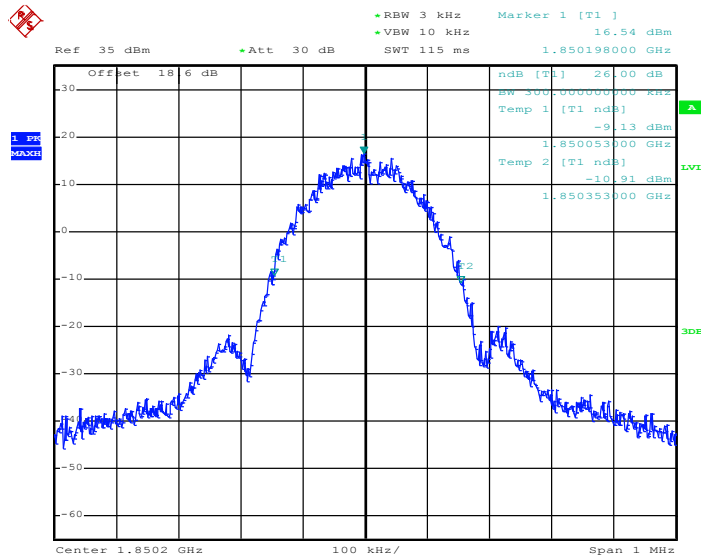

Date: 8.DEC.2014 10:24:58



99% Occupied Bandwidth Plot on Channel 661 (1880.0 MHz)

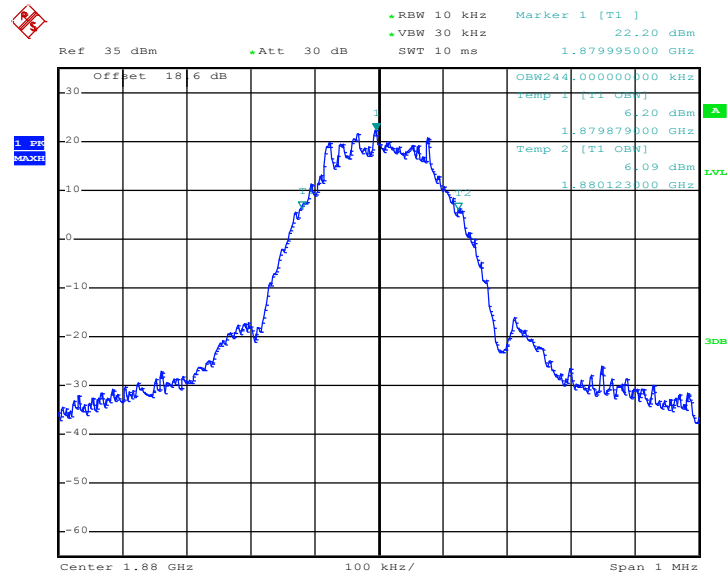

Date: 8.DEC.2014 10:27:20

26dB Bandwidth Plot on Channel 661 (1880.0 MHz)

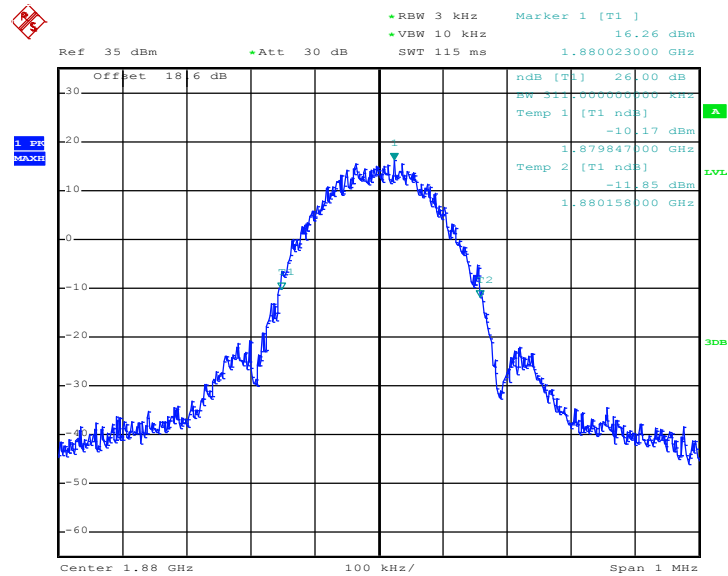

Date: 8.DEC.2014 10:25:27



99% Occupied Bandwidth Plot on Channel 810 (1909.8 MHz)

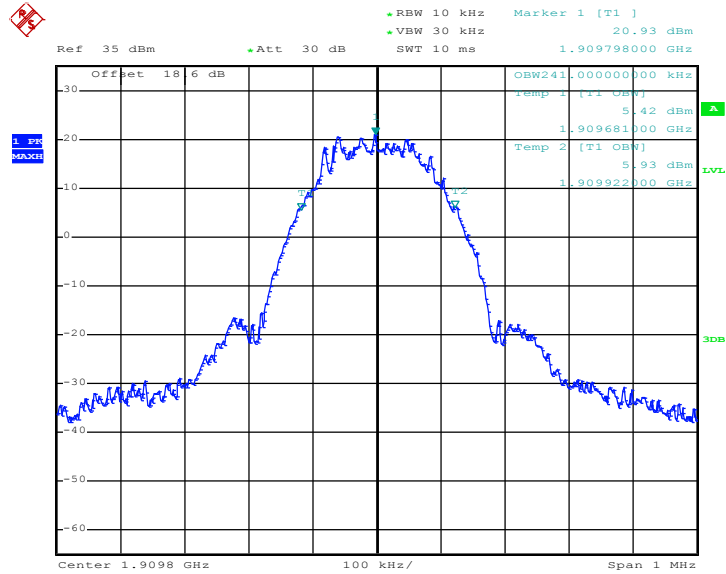

Date: 8.DEC.2014 10:27:49

26dB Bandwidth Plot on Channel 810 (1909.8 MHz)

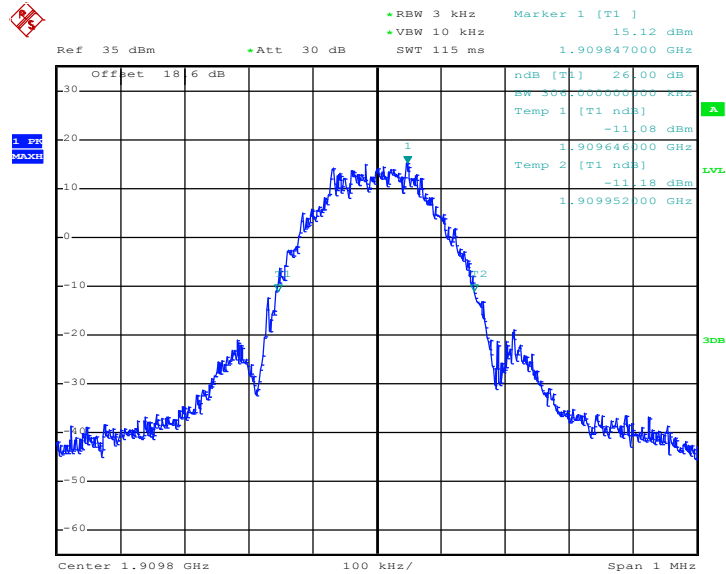

Date: 8.DEC.2014 10:25:55



Band :	WCDMA Band V	Test Mode :	RMC 12.2Kbps Link (QPSK)
---------------	--------------	--------------------	--------------------------

99% Occupied Bandwidth Plot on Channel 4132 (826.4 MHz)

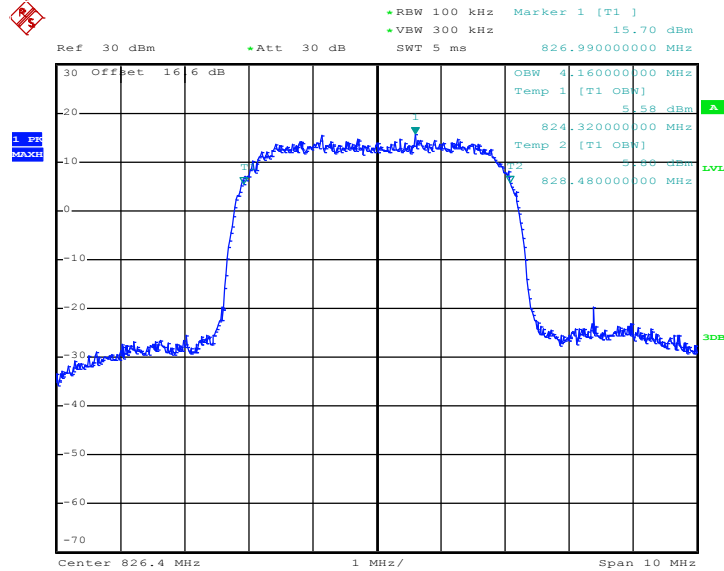

Date: 8.DEC.2014 10:03:07

26dB Bandwidth Plot on Channel 4132 (826.4 MHz)

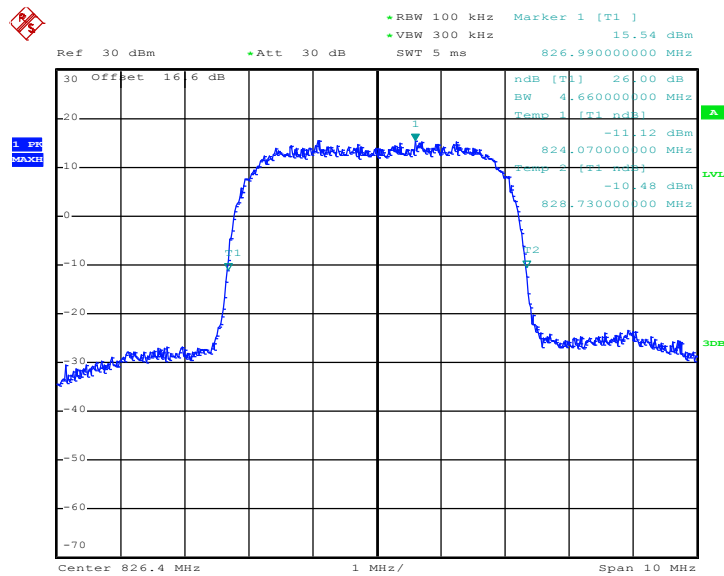

Date: 8.DEC.2014 10:01:08



99% Occupied Bandwidth Plot on Channel 4182 (836.4 MHz)

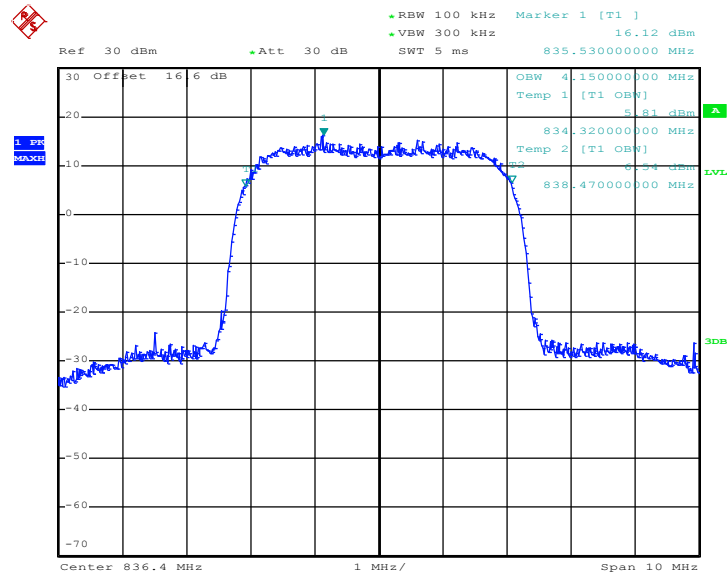

Date: 8.DEC.2014 10:03:35

26dB Bandwidth Plot on Channel 4182 (836.4 MHz)

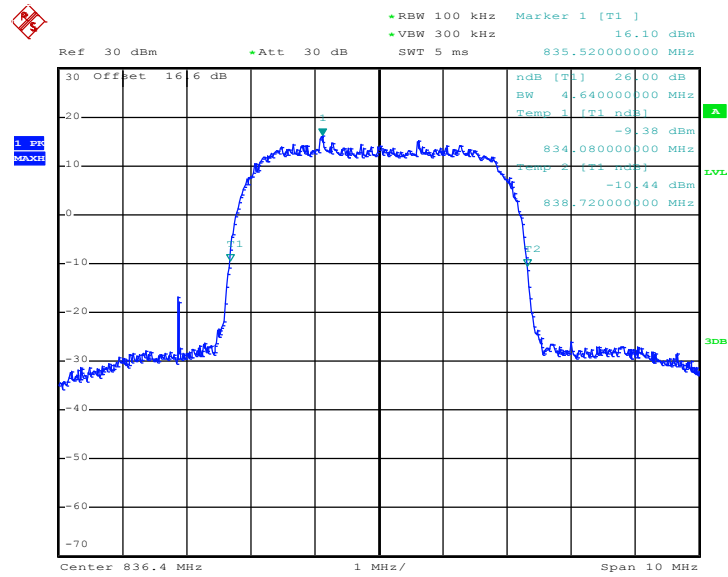

Date: 8.DEC.2014 10:01:36



99% Occupied Bandwidth Plot on Channel 4233 (846.6 MHz)

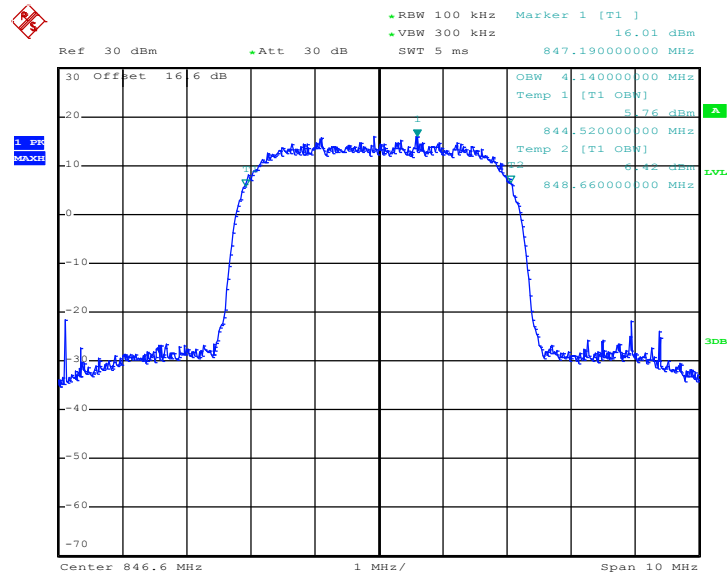

Date: 8.DEC.2014 10:04:03

26dB Bandwidth Plot on Channel 4233 (846.6 MHz)

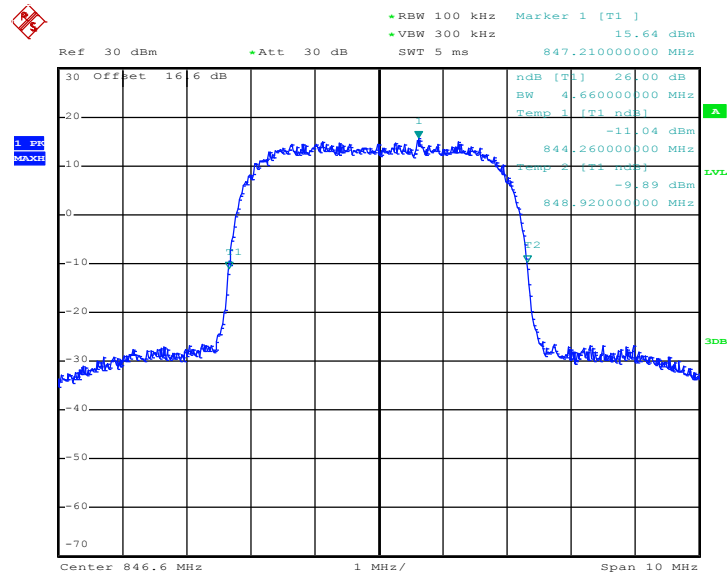

Date: 8.DEC.2014 10:02:06



Band :	WCDMA Band II	Test Mode :	RMC 12.2Kbps Link (QPSK)
---------------	---------------	--------------------	--------------------------

99% Occupied Bandwidth Plot on Channel 9262 (1852.4 MHz)

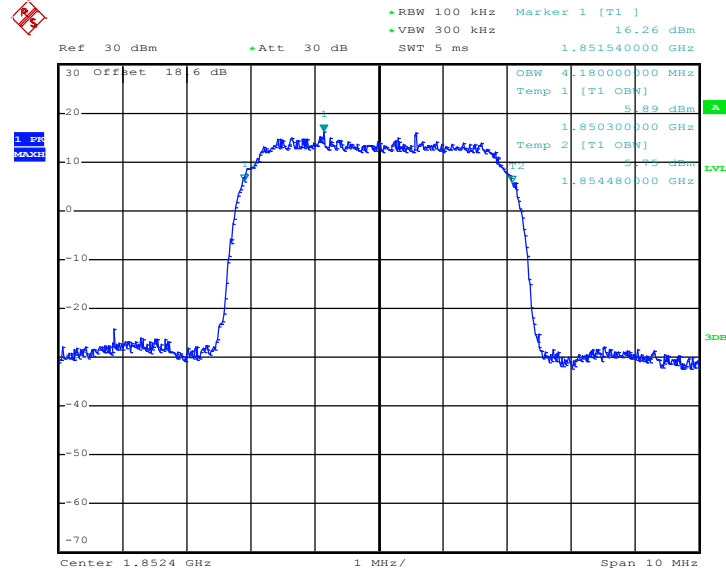

Date: 8.DEC.2014 10:44:41

26dB Bandwidth Plot on Channel 9262 (1852.4 MHz)

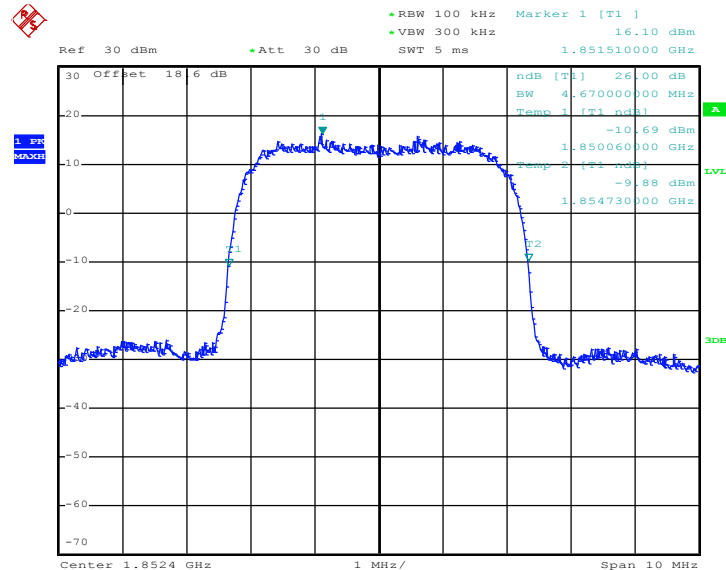

Date: 8.DEC.2014 10:41:46



99% Occupied Bandwidth Plot on Channel 9400 (1880.0 MHz)

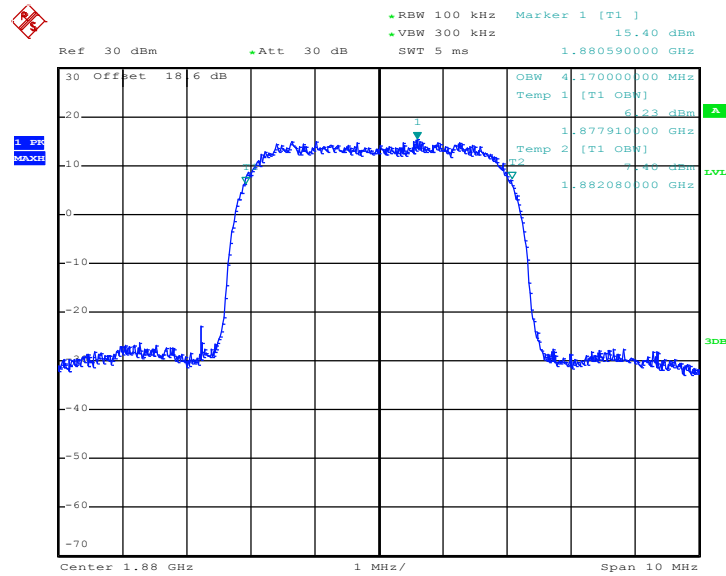

Date: 8.DEC.2014 10:45:09

26dB Bandwidth Plot on Channel 9400 (1880.0 MHz)

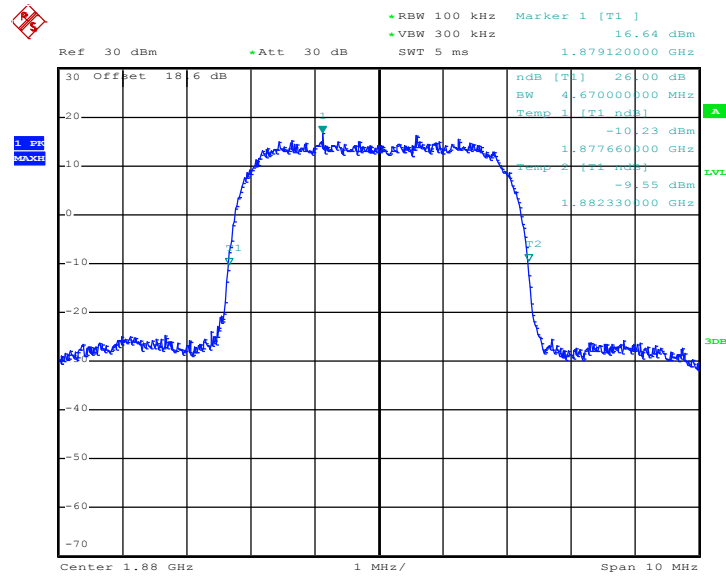

Date: 8.DEC.2014 10:42:14



99% Occupied Bandwidth Plot on Channel 9538 (1907.6 MHz)

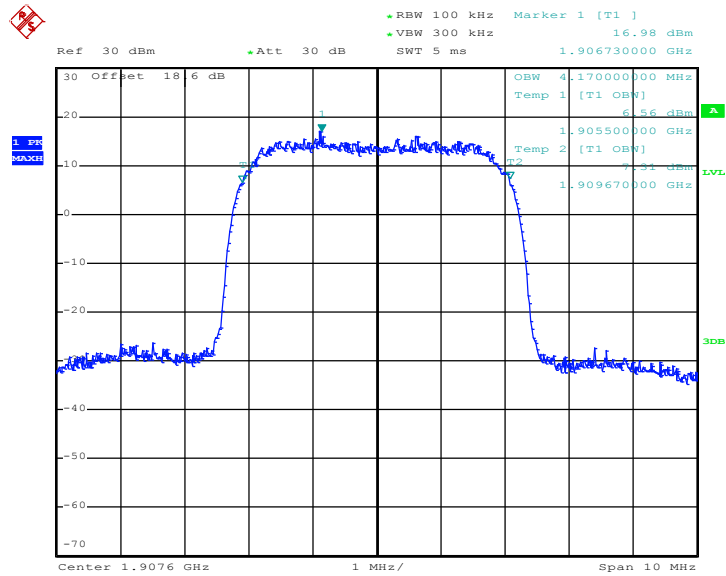

Date: 8.DEC.2014 10:45:37

26dB Bandwidth Plot on Channel 9538 (1907.6 MHz)

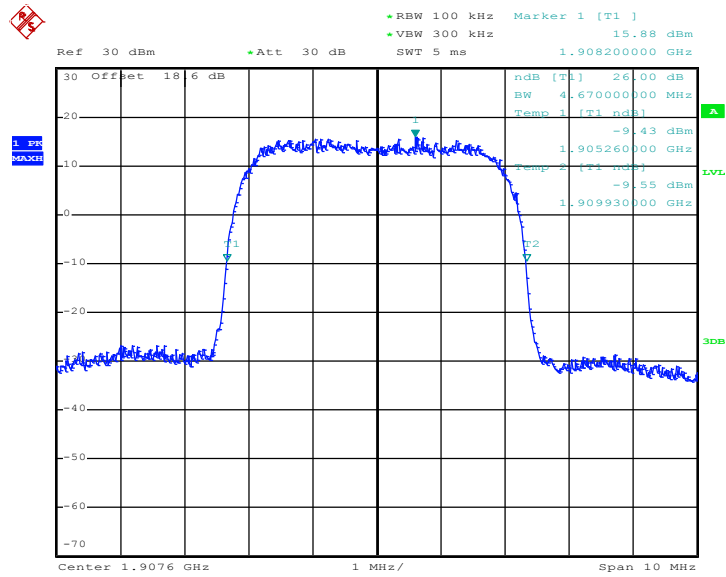

Date: 8.DEC.2014 10:42:42

3.5 Band Edge Measurement

3.5.1 Description of Band Edge Measurement

The power of any emission outside of the authorized operating frequency ranges must be lower than the transmitter power (P) by a factor of at least $43 + 10 \log (P)$ dB.

3.5.2 Measuring Instruments

The measuring equipment is listed in the section 4 of this test report.

3.5.3 Test Procedures

1. The testing follows FCC KDB 971168 v02r02 Section 6.0.
2. The EUT was connected to the spectrum analyzer and system simulator via a power divider.
3. The RF output of EUT was connected to the spectrum analyzer by an RF cable and attenuator. The path loss was compensated to the results for each measurement.
4. The band edges of low and high channels for the highest RF powers were measured.
5. The RF fundamental frequency should be excluded against the limit line in the operating frequency band.
6. The limit line is derived from $43 + 10\log(P)$ dB below the transmitter power P(Watts)
 $= P(W) - [43 + 10\log(P)] \text{ (dB)}$
 $= [30 + 10\log(P)] \text{ (dBm)} - [43 + 10\log(P)] \text{ (dB)}$
 $= -13\text{dBm}.$

3.5.4 Test Setup

<Conducted Band Edge >

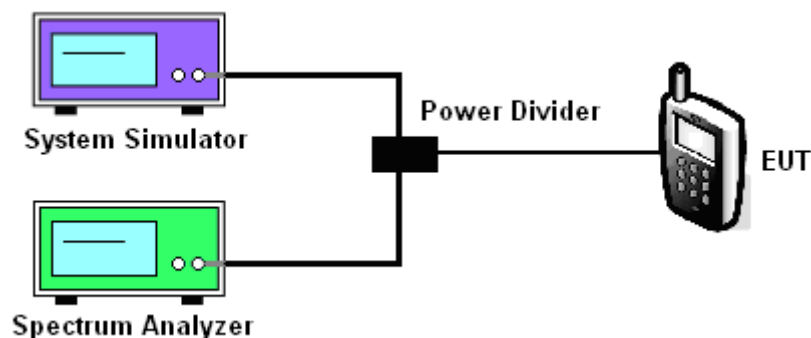



3.5.5 Test Result (Plots) of Conducted Band Edge

Band :	GSM850	Test Mode :	GSM Link (GMSK)
--------	--------	-------------	-----------------

Lower Band Edge Plot on Channel 128 (824.2 MHz)

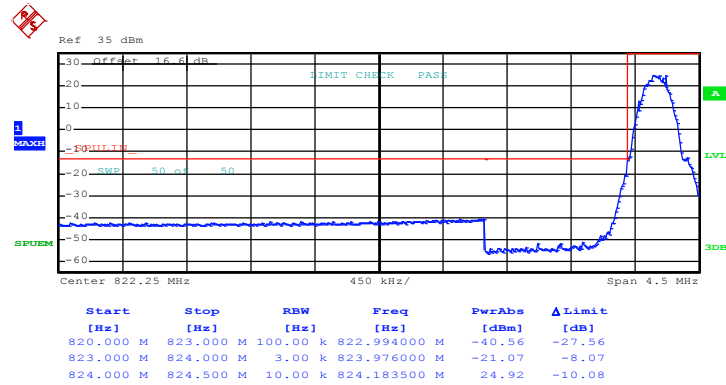

Date: 7.DEC.2014 17:16:58

Higher Band Edge Plot on Channel 251 (848.8 MHz)

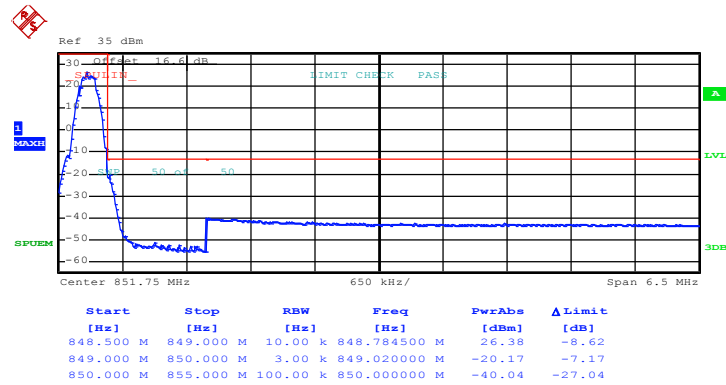

Date: 7.DEC.2014 17:15:21



Band :	GSM850	Test Mode :	EDGE class 8 Link (8PSK)
--------	--------	-------------	--------------------------

Lower Band Edge Plot on Channel 128 (824.2 MHz)

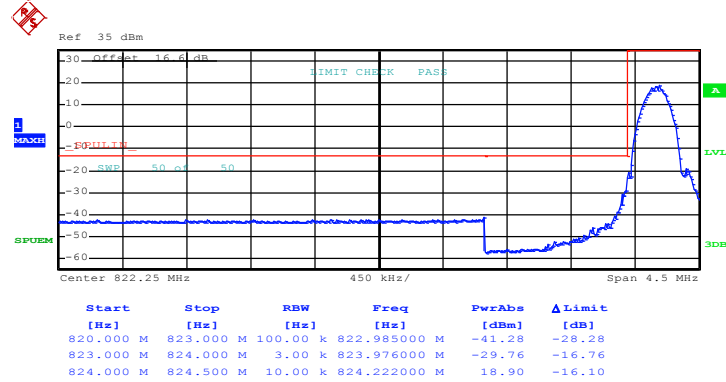

Date: 7.DEC.2014 17:05:54

Higher Band Edge Plot on Channel 251 (848.8 MHz)

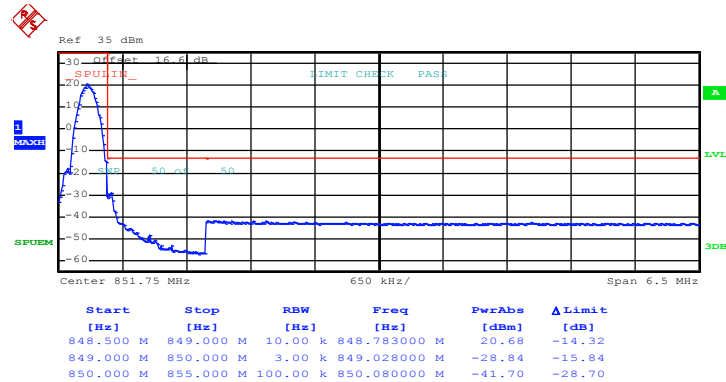

Date: 7.DEC.2014 17:04:10



Band :	GSM1900	Test Mode :	GSM Link (GMSK)
--------	---------	-------------	-----------------

Lower Band Edge Plot on Channel 512 (1850.2 MHz)

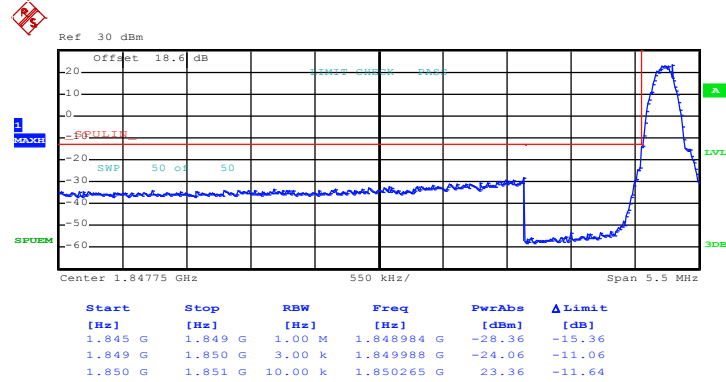

Date: 8.DEC.2014 10:16:58

Higher Band Edge Plot on Channel 810 (1909.8 MHz)

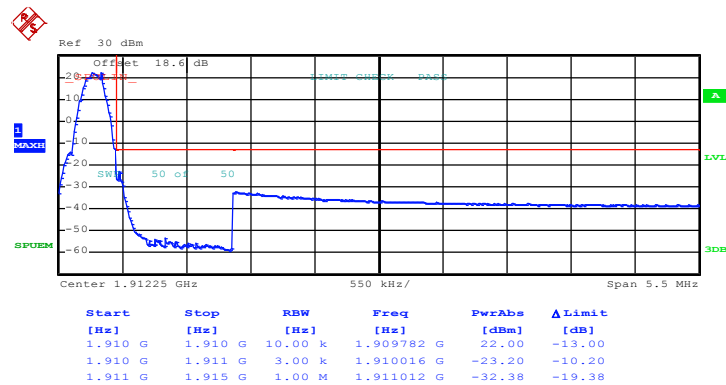

Date: 8.DEC.2014 10:18:10



Band :	GSM1900	Test Mode :	EDGE class 8 Link (8PSK)
---------------	---------	--------------------	--------------------------

Lower Band Edge Plot on Channel 512 (1850.2 MHz)

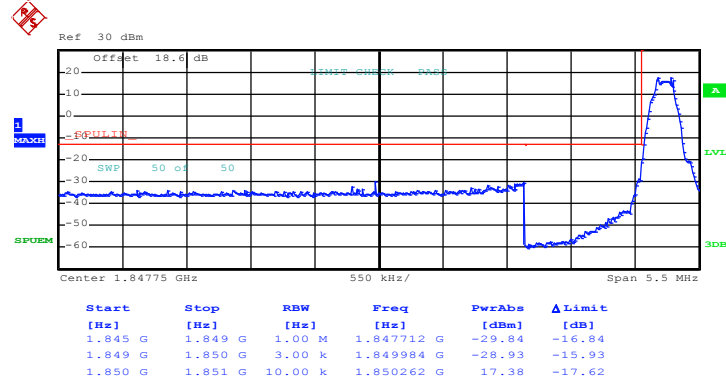

Date: 8.DEC.2014 10:29:20

Higher Band Edge Plot on Channel 810 (1909.8 MHz)

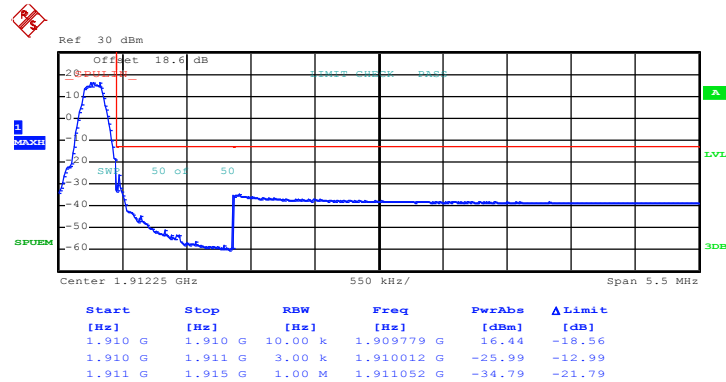

Date: 8.DEC.2014 10:30:32



Band :	WCDMA Band V	Test Mode :	RMC 12.2Kbps Link (QPSK)
--------	--------------	-------------	--------------------------

Lower Band Edge Plot on Channel 4132 (826.4 MHz)

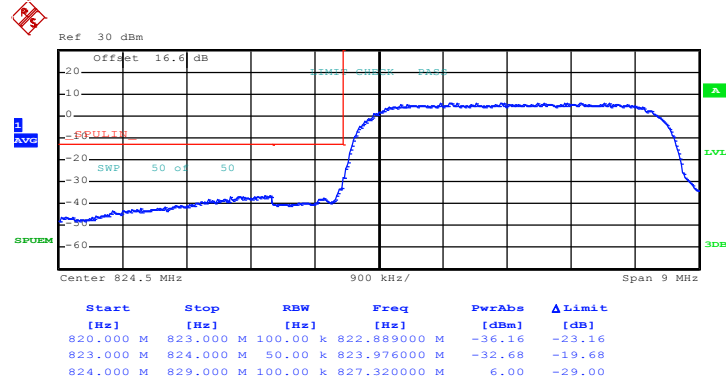

Date: 8.DEC.2014 10:05:26

Higher Band Edge Plot on Channel 4233 (846.6 MHz)

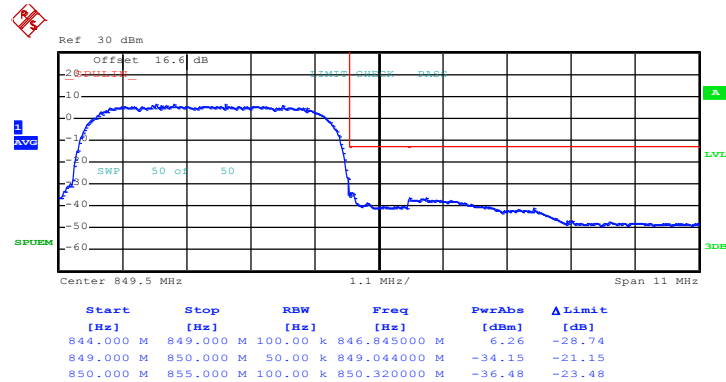

Date: 8.DEC.2014 10:06:38



Band :	WCDMA Band II	Test Mode :	RMC 12.2Kbps Link (QPSK)
--------	---------------	-------------	--------------------------

Lower Band Edge Plot on Channel 9262 (1852.4 MHz)

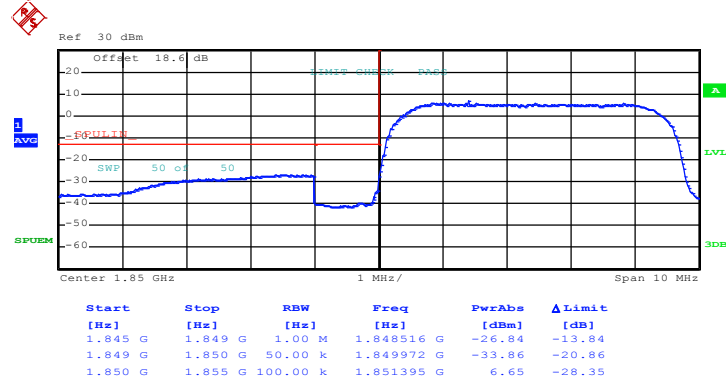

Date: 8.DEC.2014 10:47:00

Higher Band Edge Plot on Channel 9538 (1907.6 MHz)

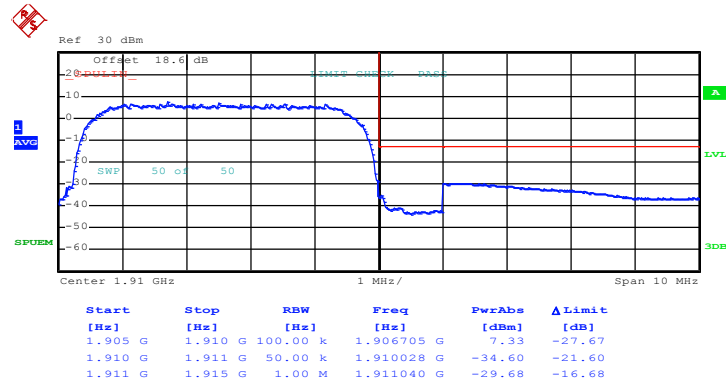

Date: 8.DEC.2014 10:48:12

3.6 Conducted Spurious Emission Measurement

3.6.1 Description of Conducted Spurious Emission Measurement

The power of any emission outside of the authorized operating frequency ranges must be lower than the transmitter power (P) by a factor of at least $43 + 10 \log (P)$ dB.

It is measured by means of a calibrated spectrum analyzer and scanned from 30 MHz up to a frequency including its 10th harmonic.

3.6.2 Measuring Instruments

The measuring equipment is listed in the section 4 of this test report.

3.6.3 Test Procedures

1. The testing follows FCC KDB 971168 v02r02 Section 6.0.
2. The EUT was connected to the spectrum analyzer and system simulator via a power divider.
3. The RF output of EUT was connected to the spectrum analyzer by an RF cable and attenuator. The path loss was compensated to the results for each measurement.
4. The middle channel for the highest RF power within the transmitting frequency was measured.
5. The conducted spurious emission for the whole frequency range was taken.
6. The RF fundamental frequency should be excluded against the limit line in the operating frequency band.
7. The limit line is derived from $43 + 10\log(P)$ dB below the transmitter power P(Watts)
 $= P(W) - [43 + 10\log(P)]$ (dB)
 $= [30 + 10\log(P)]$ (dBm) - $[43 + 10\log(P)]$ (dB)
 $= -13\text{dBm}$.

3.6.4 Test Setup

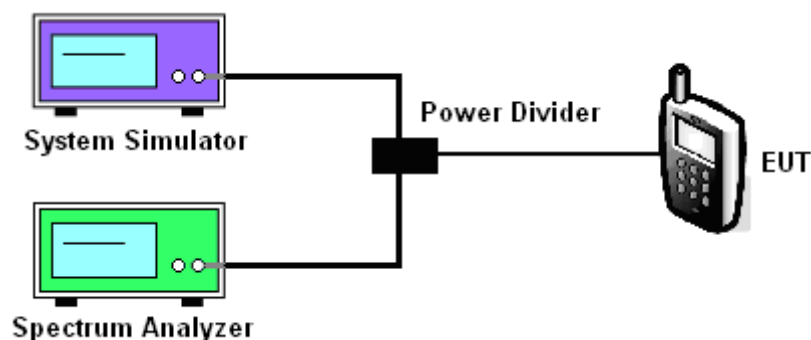



3.6.5 Test Result (Plots) of Conducted Spurious Emission

Band :	GSM850	Channel :	CH128
Test Mode :	GSM Link (GMSK)	Frequency :	824.2 MHz

Conducted Spurious Emission Plot between 30MHz ~ 9GHz

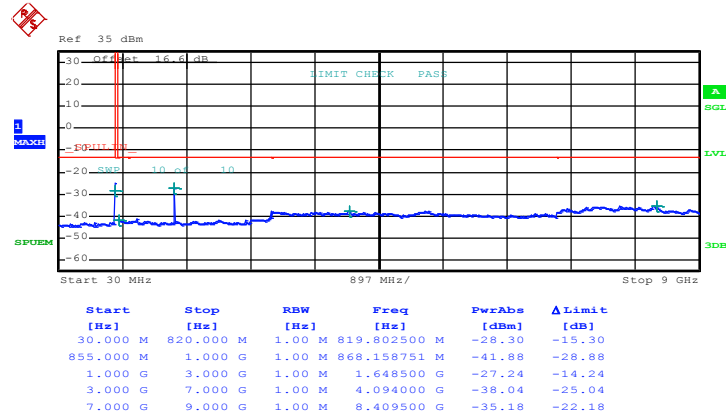

Date: 7.DEC.2014 16:35:34



Band :	GSM850	Channel :	CH189
Test Mode :	GSM Link (GMSK)	Frequency :	836.4 MHz

Conducted Spurious Emission Plot between 30MHz ~ 9GHz

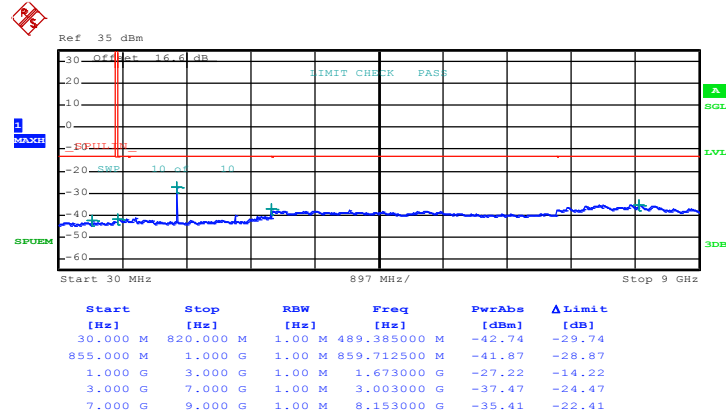

Date: 7.DEC.2014 16:35:53



Band :	GSM850	Channel :	CH251
Test Mode :	GSM Link (GMSK)	Frequency :	848.8 MHz

Conducted Spurious Emission Plot between 30MHz ~ 9GHz

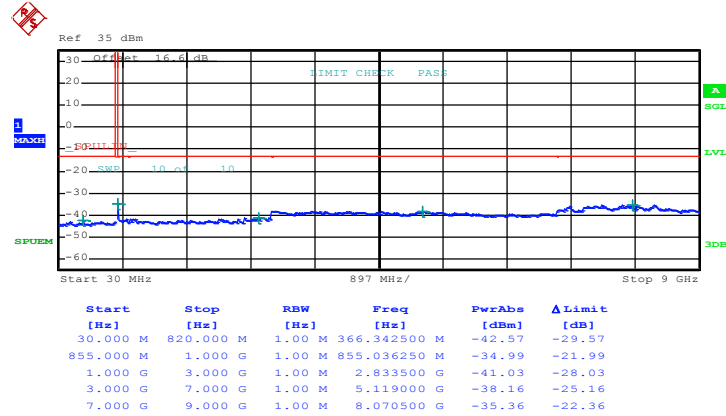

Date: 7.DEC.2014 16:36:11



Band :	GSM850	Channel :	CH128
Test Mode :	EDGE class 8 Link (8PSK)	Frequency :	824.2 MHz

Conducted Spurious Emission Plot between 30MHz ~ 9GHz

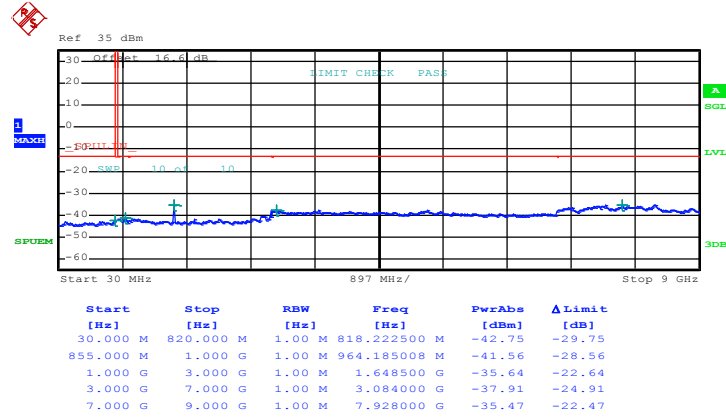

Date: 7.DEC.2014 17:08:38



Band :	GSM850	Channel :	CH189
Test Mode :	EDGE class 8 Link (8PSK)	Frequency :	836.4 MHz

Conducted Spurious Emission Plot between 30MHz ~ 9GHz

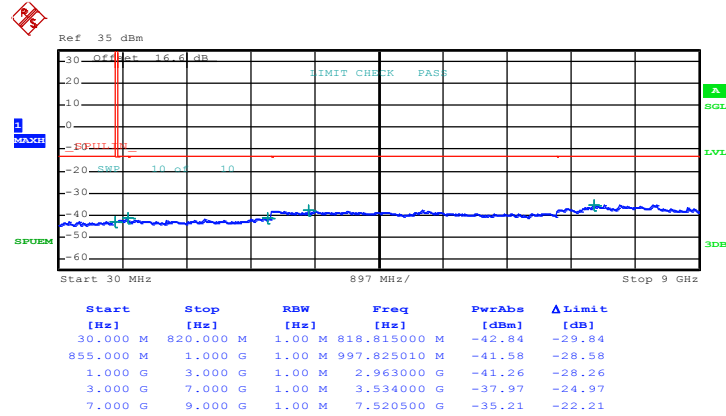

Date: 7.DEC.2014 17:09:02



Band :	GSM850	Channel :	CH251
Test Mode :	EDGE class 8 Link (8PSK)	Frequency :	848.8 MHz

Conducted Spurious Emission Plot between 30MHz ~ 9GHz

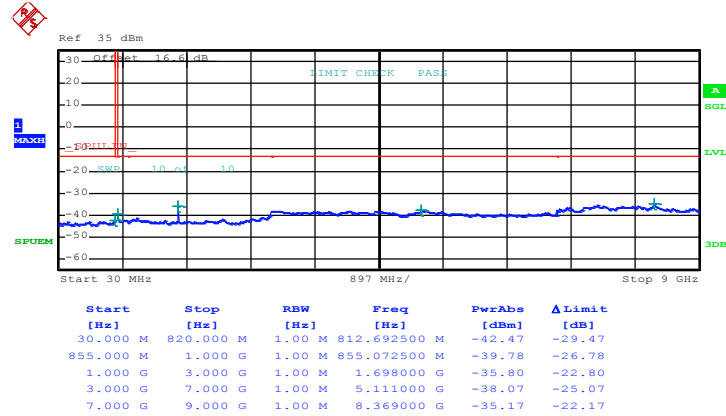

Date: 7.DEC.2014 17:09:29



Band :	GSM1900	Channel :	CH512
Test Mode :	GSM Link (GMSK)	Frequency :	1850.2 MHz

Conducted Spurious Emission Plot between 30MHz ~ 19.1GHz

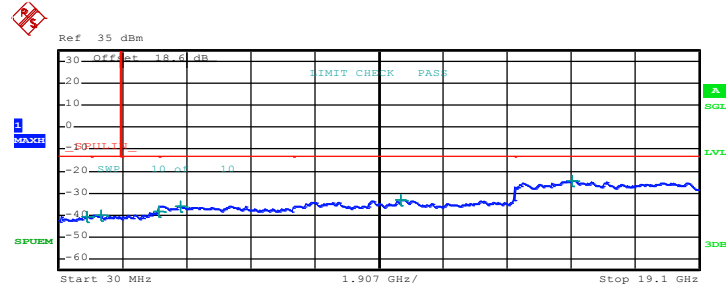

Start [Hz]	Stop [Hz]	RBW [Hz]	Freq [Hz]	PwrAbs [dBm]	Δ Limit [dB]
30.000 M	1.000 G	1.00 M	850.862500 M	-40.65	-27.65
1.000 G	1.845 G	1.00 M	1.303355 G	-40.00	-27.00
1.915 G	3.000 G	1.00 M	2.997830 G	-38.33	-25.33
3.000 G	7.000 G	1.00 M	3.640000 G	-35.88	-22.88
7.000 G	13.600 G	1.00 M	10.213375 G	-32.90	-19.90
13.600 G	19.100 G	1.00 M	15.342125 G	-24.09	-11.09

Date: 8.DEC.2014 10:19:07



Band :	GSM1900	Channel :	CH661
Test Mode :	GSM Link (GMSK)	Frequency :	1880.0 MHz

Conducted Spurious Emission Plot between 30MHz ~ 19.1GHz

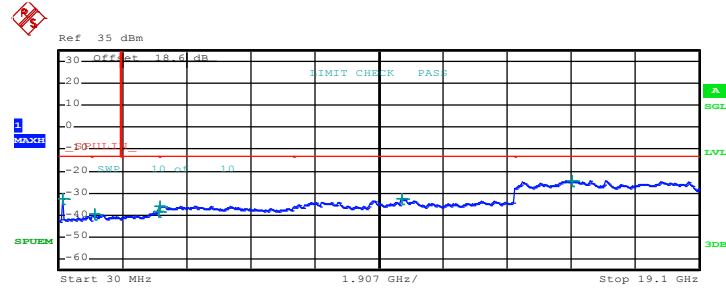

Start [Hz]	Stop [Hz]	RBW [Hz]	Freq [Hz]	PwrAbs [dBm]	Δ Limit [dB]
30.000 M	1.000 G	1.00 M	141.792500 M	-32.80	-19.80
1.000 G	1.845 G	1.00 M	1.105625 G	-39.53	-26.53
1.915 G	3.000 G	1.00 M	2.997016 G	-38.68	-25.68
3.000 G	7.000 G	1.00 M	3.031000 G	-35.93	-22.93
7.000 G	13.600 G	1.00 M	10.262875 G	-32.48	-19.48
13.600 G	19.100 G	1.00 M	15.331125 G	-24.45	-11.45

Date: 8.DEC.2014 10:19:33



Band :	GSM1900	Channel :	CH810
Test Mode :	GSM Link (GMSK)	Frequency :	1909.8 MHz

Conducted Spurious Emission Plot between 30MHz ~ 19.1GHz

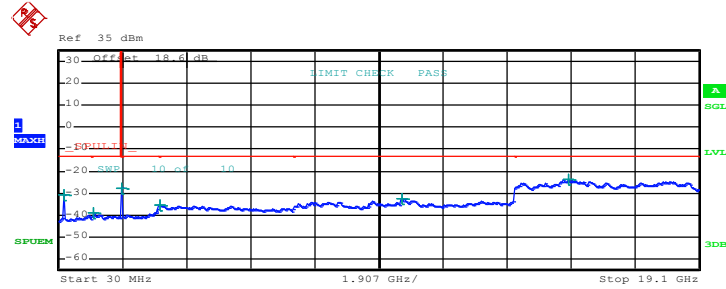

Start [Hz]	Stop [Hz]	RBW [Hz]	Freq [Hz]	PwrAbs [dBm]	Δ Limit [dB]
30.000 M	1.000 G	1.00 M	171.620000 M	-30.79	-17.79
1.000 G	1.845 G	1.00 M	1.078796 G	-39.21	-26.21
1.915 G	3.000 G	1.00 M	1.915271 G	-28.04	-15.04
3.000 G	7.000 G	1.00 M	3.032000 G	-35.51	-22.51
7.000 G	13.600 G	1.00 M	10.235650 G	-32.83	-19.83
13.600 G	19.100 G	1.00 M	15.225250 G	-23.77	-10.77

Date: 8.DEC.2014 10:19:58



Band :	GSM1900	Channel :	CH512
Test Mode :	EDGE class 8 Link (8PSK)	Frequency :	1850.2 MHz

Conducted Spurious Emission Plot between 30MHz ~ 19.1GHz

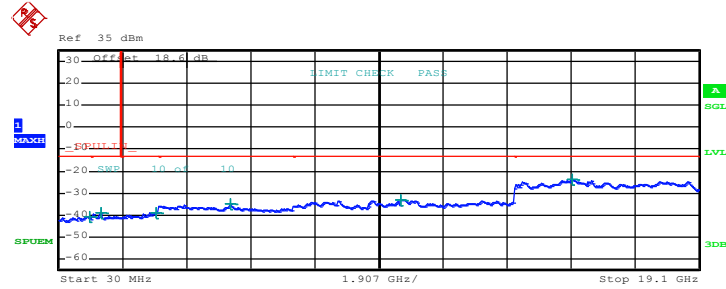

Start [Hz]	Stop [Hz]	RBW [Hz]	Freq [Hz]	PwrAbs [dBm]	Δ Limit [dB]
30.000 M	1.000 G	1.00 M	944.225000 M	-40.77	-27.77
1.000 G	1.845 G	1.00 M	1.269978 G	-39.09	-26.09
1.915 G	3.000 G	1.00 M	2.910759 G	-38.95	-25.95
3.000 G	7.000 G	1.00 M	5.123000 G	-35.11	-22.11
7.000 G	13.600 G	1.00 M	10.219975 G	-32.93	-19.93
13.600 G	19.100 G	1.00 M	15.317375 G	-23.83	-10.83

Date: 8.DEC.2014 10:31:07



Band :	GSM1900	Channel :	CH661
Test Mode :	EDGE class 8 Link (8PSK)	Frequency :	1880.0 MHz

Conducted Spurious Emission Plot between 30MHz ~ 19.1GHz

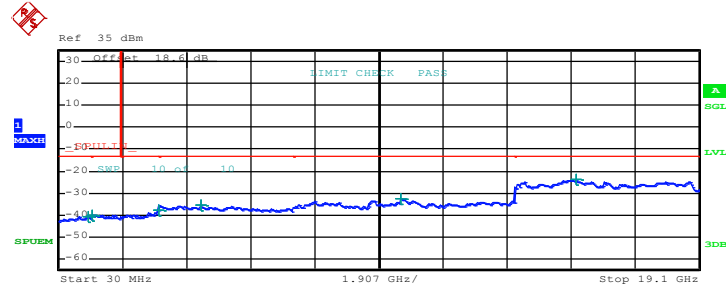

Date: 8.DEC.2014 10:31:33



Band :	GSM1900	Channel :	CH810
Test Mode :	EDGE class 8 Link (8PSK)	Frequency :	1909.8 MHz

Conducted Spurious Emission Plot between 30MHz ~ 19.1GHz

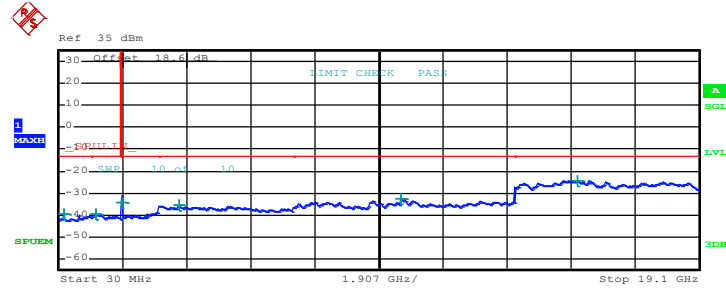

Start [Hz]	Stop [Hz]	RBW [Hz]	Freq [Hz]	PwrAbs [dBm]	Δ Limit [dB]
30.000 M	1.000 G	1.00 M	171.862500 M	-39.81	-26.81
1.000 G	1.845 G	1.00 M	1.151677 G	-39.76	-26.76
1.915 G	3.000 G	1.00 M	1.915271 G	-34.24	-21.24
3.000 G	7.000 G	1.00 M	3.608000 G	-35.71	-22.71
7.000 G	13.600 G	1.00 M	10.219975 G	-32.80	-19.80
13.600 G	19.100 G	1.00 M	15.474125 G	-24.23	-11.23

Date: 8.DEC.2014 10:31:59



Band :	WCDMA Band V	Channel :	CH4132
Test Mode :	RMC 12.2Kbps Link (QPSK)	Frequency :	836.4 MHz

Conducted Spurious Emission Plot between 30MHz ~ 9GHz

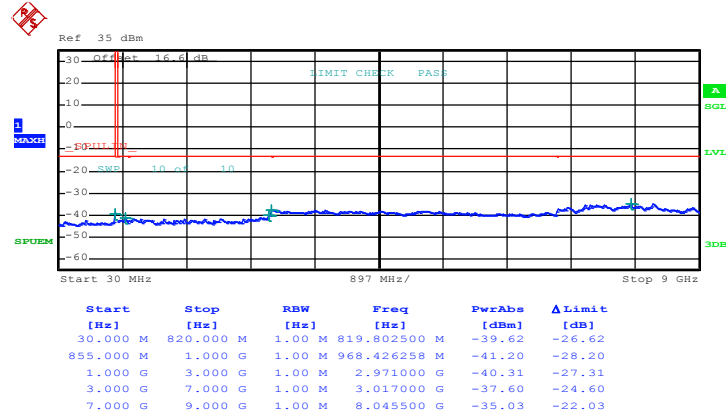

Date: 8.DEC.2014 10:07:51



Band :	WCDMA Band V	Channel :	CH4182
Test Mode :	RMC 12.2Kbps Link (QPSK)	Frequency :	836.4 MHz

Conducted Spurious Emission Plot between 30MHz ~ 9GHz

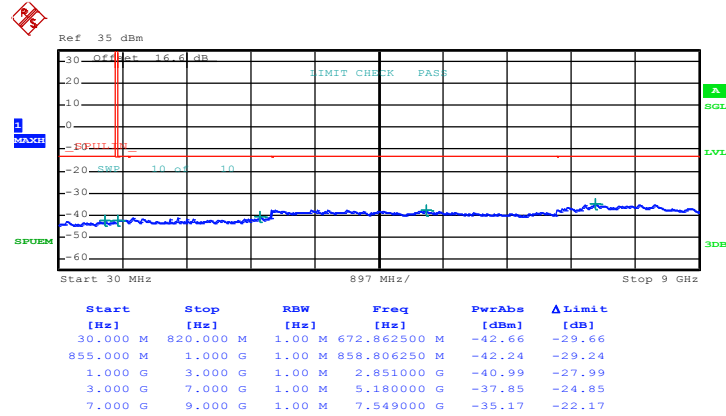

Date: 8.DEC.2014 10:08:16



Band :	WCDMA Band V	Channel :	CH4233
Test Mode :	RMC 12.2Kbps Link (QPSK)	Frequency :	836.4 MHz

Conducted Spurious Emission Plot between 30MHz ~ 9GHz

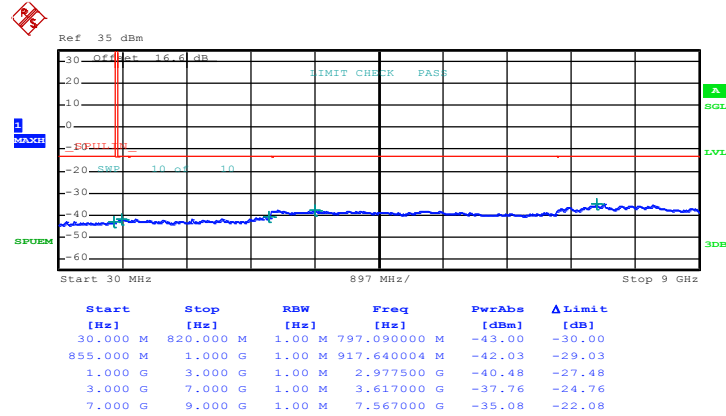

Date: 8.DEC.2014 10:08:41



Band :	WCDMA Band II	Channel :	CH9262
Test Mode :	RMC 12.2Kbps Link (QPSK)	Frequency :	1880.0 MHz

Conducted Spurious Emission Plot between 30MHz ~ 19.1GHz

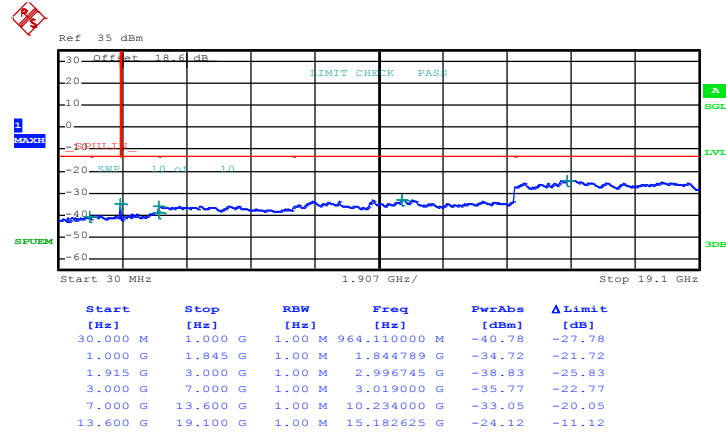

Date: 8.DEC.2014 10:48:48



Band :	WCDMA Band II	Channel :	CH9400
Test Mode :	RMC 12.2Kbps Link (QPSK)	Frequency :	1880.0 MHz

Conducted Spurious Emission Plot between 30MHz ~ 19.1GHz

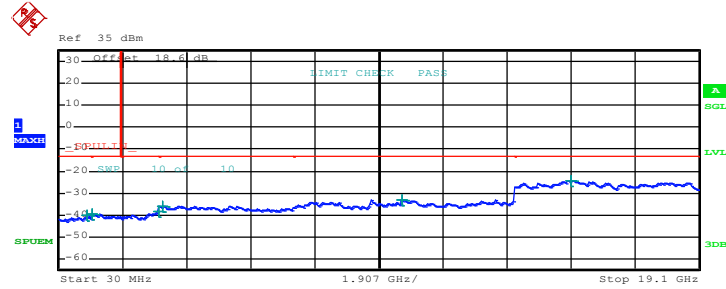

Start [Hz]	Stop [Hz]	RBW [Hz]	Freq [Hz]	PwrAbs [dBm]	Δ Limit [dB]
30.000 M	1.000 G	1.00 M	870.262500 M	-40.17	-27.17
1.000 G	1.845 G	1.00 M	1.013943 G	-39.57	-26.57
1.915 G	3.000 G	1.00 M	2.994032 G	-38.53	-25.53
3.000 G	7.000 G	1.00 M	3.102000 G	-35.92	-22.92
7.000 G	13.600 G	1.00 M	10.233175 G	-33.25	-20.25
13.600 G	19.100 G	1.00 M	15.288500 G	-24.17	-11.17

Date: 8.DEC.2014 10:49:14



Band :	WCDMA Band II	Channel :	CH9538
Test Mode :	RMC 12.2Kbps Link (QPSK)	Frequency :	1880.0 MHz

Conducted Spurious Emission Plot between 30MHz ~ 19.1GHz

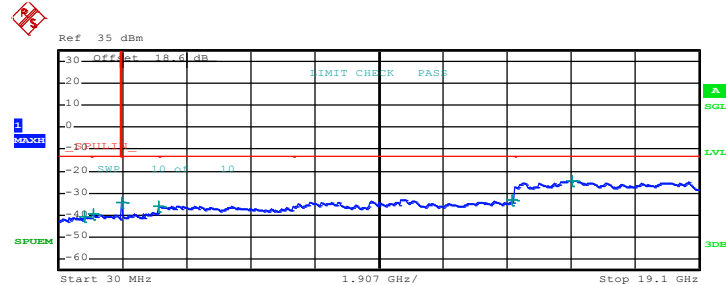

Start [Hz]	Stop [Hz]	RBW [Hz]	Freq [Hz]	PwrAbs [dBm]	Δ Limit [dB]
30.000 M	1.000 G	1.00 M	797.027500 M	-40.92	-27.92
1.000 G	1.845 G	1.00 M	1.074360 G	-39.32	-26.32
1.915 G	3.000 G	1.00 M	1.915271 G	-34.34	-21.34
3.000 G	7.000 G	1.00 M	3.005000 G	-35.84	-22.84
7.000 G	13.600 G	1.00 M	13.542250 G	-33.03	-20.03
13.600 G	19.100 G	1.00 M	15.312563 G	-24.41	-11.41

Date: 8.DEC.2014 10:49:39



3.7 Field Strength of Spurious Radiation Measurement

3.7.1 Description of Field Strength of Spurious Radiated Measurement

The power of any emission outside of the authorized operating frequency ranges must be attenuated below the transmitter power (P) by a factor of at least $43 + 10 \log (P)$ dB. The spectrum is scanned from 30 MHz up to a frequency including its 10th harmonic.

3.7.2 Measuring Instruments

The measuring equipment is listed in the section 4 of this test report.

3.7.3 Test Procedures

1. The testing follows FCC KDB 971168 v02r02 Section 5.8 and ANSI / TIA-603-C-2004 Section 2.2.12.
2. The EUT was placed on a rotatable wooden table 0.8 meters above the ground.
3. The EUT was set 3 meters from the receiving antenna, which was mounted on the antenna tower.
4. The table was rotated 360 degrees to determine the position of the highest spurious emission.
5. The height of the receiving antenna is varied between one meter and four meters to search for the maximum spurious emission for both horizontal and vertical polarizations.
6. Make the measurement with the spectrum analyzer's RBW = 1MHz, VBW = 3MHz, taking record of maximum spurious emission.
7. A horn antenna was substituted in place of the EUT and was driven by a signal generator.
8. Tune the output power of signal generator to the same emission level with EUT maximum spurious emission.
9. Taking the record of output power at antenna port.
10. Repeat step 7 to step 8 for another polarization.
11. $EIRP (dBm) = S.G. Power - Tx Cable Loss + Tx Antenna Gain$
12. $ERP (dBm) = EIRP - 2.15$
13. The RF fundamental frequency should be excluded against the limit line in the operating frequency band.
14. The limit line is derived from $43 + 10\log(P)$ dB below the transmitter power P(Watts)
= $P(W) - [43 + 10\log(P)] (dB)$
= $[30 + 10\log(P)] (dBm) - [43 + 10\log(P)] (dB)$
= -13dBm.

3.7.4 Test Setup

For radiated emissions from 30MHz to 1GHz

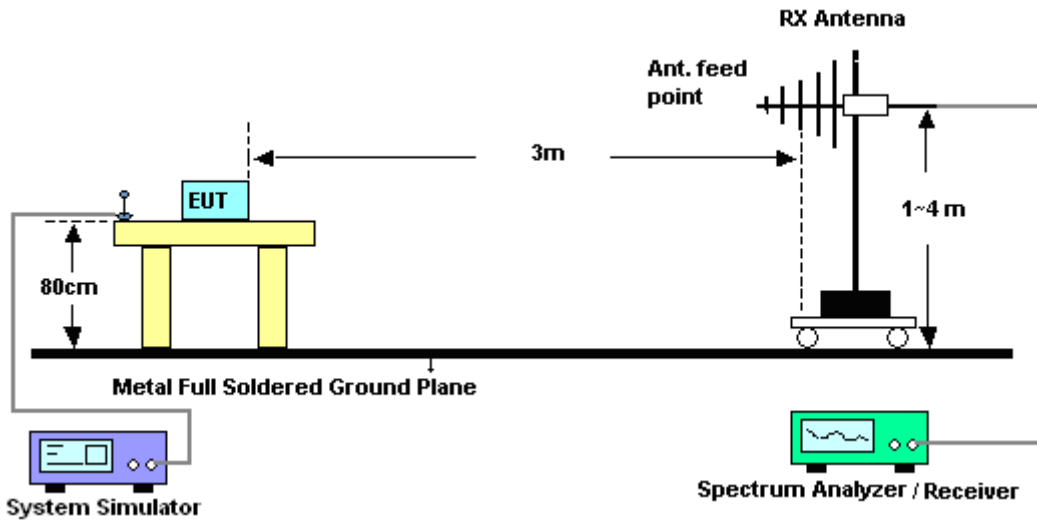

For radiated emissions above 1GHz

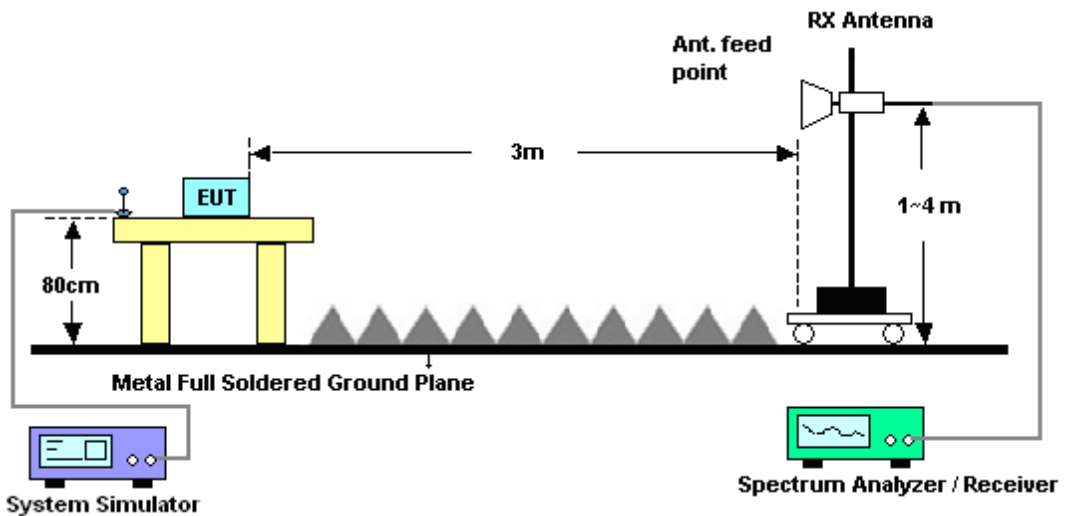



3.7.5 Test Result of Field Strength of Spurious Radiated

<Low Channel>

Band :	GSM850		Temperature :	23~24°C					
Test Mode :	GSM Link (GMSK)		Relative Humidity :	46~48%					
Test Engineer :	Derreck Chen and Ken Wu		Polarization :	Horizontal					
Remark :	Spurious emissions within 30-1000MHz were found more than 20dB below limit line.								
Frequency (MHz)	ERP (dBm)	Limit (dBm)	Over Limit (dB)	SPA Reading (dBm)	S.G. Power (dBm)	TX Cable loss (dB)	TX Antenna Gain (dBi)	Polarization (H/V)	Result
1648	-46.76	-13	-33.76	-58.22	-48.52	0.98	4.89	H	Pass
2472	-50.93	-13	-37.93	-65.73	-52.81	1.28	5.32	H	Pass
3296	-50.88	-13	-37.88	-67.43	-54.29	1.54	7.10	H	Pass

Band :	GSM850		Temperature :	23~24°C					
Test Mode :	GSM Link (GMSK)		Relative Humidity :	46~48%					
Test Engineer :	Derreck Chen and Ken Wu		Polarization :	Vertical					
Remark :	Spurious emissions within 30-1000MHz were found more than 20dB below limit line.								
Frequency (MHz)	ERP (dBm)	Limit (dBm)	Over Limit (dB)	SPA Reading (dBm)	S.G. Power (dBm)	TX Cable loss (dB)	TX Antenna Gain (dBi)	Polarization (H/V)	Result
1648	-46.27	-13	-33.27	-59.53	-48.03	0.98	4.89	V	Pass
2472	-50.53	-13	-37.53	-66.48	-52.41	1.28	5.32	V	Pass
3296	-50.10	-13	-37.10	-67.94	-53.51	1.54	7.10	V	Pass



<Middle Channel>

Band :	GSM850				Temperature :	23~24°C			
Test Mode :	GSM Link (GMSK)				Relative Humidity :	46~48%			
Test Engineer :	Derreck Chen and Ken Wu				Polarization :	Horizontal			
Remark :	Spurious emissions within 30-1000MHz were found more than 20dB below limit line.								
Frequency (MHz)	ERP (dBm)	Limit (dBm)	Over Limit (dB)	SPA Reading (dBm)	S.G. Power (dBm)	TX Cable loss (dB)	TX Antenna Gain (dBi)	Polarization (H/V)	Result
1672	-50.54	-13	-37.54	-61.86	-52.22	0.99	4.82	H	Pass
2509	-50.45	-13	-37.45	-66.03	-52.41	1.29	5.41	H	Pass
3345	-50.43	-13	-37.43	-67.35	-54.04	1.56	7.32	H	Pass

Band :	GSM850				Temperature :	23~24°C			
Test Mode :	GSM Link (GMSK)				Relative Humidity :	46~48%			
Test Engineer :	Derreck Chen and Ken Wu				Polarization :	Vertical			
Remark :	Spurious emissions within 30-1000MHz were found more than 20dB below limit line.								
Frequency (MHz)	ERP (dBm)	Limit (dBm)	Over Limit (dB)	SPA Reading (dBm)	S.G. Power (dBm)	TX Cable loss (dB)	TX Antenna Gain (dBi)	Polarization (H/V)	Result
1672	-46.60	-13	-33.60	-60.22	-48.28	0.99	4.82	V	Pass
2509	-50.43	-13	-37.43	-66.61	-52.39	1.29	5.41	V	Pass
3345	-49.80	-13	-36.80	-67.77	-53.41	1.56	7.32	V	Pass



<High Channel>

Band :	GSM850				Temperature :	23~24°C			
Test Mode :	GSM Link (GMSK)				Relative Humidity :	46~48%			
Test Engineer :	Derreck Chen and Ken Wu				Polarization :	Horizontal			
Remark :	Spurious emissions within 30-1000MHz were found more than 20dB below limit line.								
Frequency (MHz)	ERP (dBm)	Limit (dBm)	Over Limit (dB)	SPA Reading (dBm)	S.G. Power (dBm)	TX Cable loss (dB)	TX Antenna Gain (dBi)	Polarization (H/V)	Result
1696	-51.89	-13	-38.89	-62.84	-53.49	1.00	4.75	H	Pass
2546	-51.03	-13	-38.03	-66.03	-53.01	1.31	5.44	H	Pass
3395	-51.01	-13	-38.01	-67.51	-54.83	1.57	7.54	H	Pass

Band :	GSM850				Temperature :	23~24°C			
Test Mode :	GSM Link (GMSK)				Relative Humidity :	46~48%			
Test Engineer :	Derreck Chen and Ken Wu				Polarization :	Vertical			
Remark :	Spurious emissions within 30-1000MHz were found more than 20dB below limit line.								
Frequency (MHz)	ERP (dBm)	Limit (dBm)	Over Limit (dB)	SPA Reading (dBm)	S.G. Power (dBm)	TX Cable loss (dB)	TX Antenna Gain (dBi)	Polarization (H/V)	Result
1696	-49.68	-13	-36.68	-63.47	-51.28	1.00	4.75	V	Pass
2546	-49.24	-13	-36.24	-65.3	-51.22	1.31	5.44	V	Pass
3395	-49.87	-13	-36.87	-67.86	-53.69	1.57	7.54	V	Pass



<Low Channel>

Band :	GSM850				Temperature :	23~24°C			
Test Mode :	EDGE class 8 Link (8PSK)				Relative Humidity :	46~48%			
Test Engineer :	Derreck Chen and Ken Wu				Polarization :	Horizontal			
Remark :	Spurious emissions within 30-1000MHz were found more than 20dB below limit line.								
Frequency (MHz)	ERP (dBm)	Limit (dBm)	Over Limit (dB)	SPA Reading (dBm)	S.G. Power (dBm)	TX Cable loss (dB)	TX Antenna Gain (dBi)	Polarization (H/V)	Result
1648	-54.46	-13	-41.46	-65.31	-56.22	0.98	4.89	H	Pass
2472	-51.53	-13	-38.53	-66.93	-53.41	1.28	5.32	H	Pass
3296	-50.88	-13	-37.88	-66.91	-54.29	1.54	7.10	H	Pass

Band :	GSM850				Temperature :	23~24°C			
Test Mode :	EDGE class 8 Link (8PSK)				Relative Humidity :	46~48%			
Test Engineer :	Derreck Chen and Ken Wu				Polarization :	Vertical			
Remark :	Spurious emissions within 30-1000MHz were found more than 20dB below limit line.								
Frequency (MHz)	ERP (dBm)	Limit (dBm)	Over Limit (dB)	SPA Reading (dBm)	S.G. Power (dBm)	TX Cable loss (dB)	TX Antenna Gain (dBi)	Polarization (H/V)	Result
1648	-52.29	-13	-39.29	-65.45	-54.05	0.98	4.89	V	Pass
2472	-50.79	-13	-37.79	-66.48	-52.67	1.28	5.32	V	Pass
3296	-49.08	-13	-36.08	-66.96	-52.49	1.54	7.10	V	Pass



<Middle Channel>

Band :	GSM850				Temperature :	23~24°C			
Test Mode :	EDGE class 8 Link (8PSK)				Relative Humidity :	46~48%			
Test Engineer :	Derreck Chen and Ken Wu				Polarization :	Horizontal			
Remark :	Spurious emissions within 30-1000MHz were found more than 20dB below limit line.								
Frequency (MHz)	ERP (dBm)	Limit (dBm)	Over Limit (dB)	SPA Reading (dBm)	S.G. Power (dBm)	TX Cable loss (dB)	TX Antenna Gain (dBi)	Polarization (H/V)	Result
1672	-51.94	-13	-38.94	-63.26	-53.62	0.99	4.82	H	Pass
2509	-50.78	-13	-37.78	-66.02	-52.74	1.29	5.41	H	Pass
3345	-50.60	-13	-37.60	-67.18	-54.21	1.56	7.32	H	Pass

Band :	GSM850				Temperature :	23~24°C			
Test Mode :	EDGE class 8 Link (8PSK)				Relative Humidity :	46~48%			
Test Engineer :	Derreck Chen and Ken Wu				Polarization :	Vertical			
Remark :	Spurious emissions within 30-1000MHz were found more than 20dB below limit line.								
Frequency (MHz)	ERP (dBm)	Limit (dBm)	Over Limit (dB)	SPA Reading (dBm)	S.G. Power (dBm)	TX Cable loss (dB)	TX Antenna Gain (dBi)	Polarization (H/V)	Result
1672	-48.93	-13	-35.93	-62.31	-50.61	0.99	4.82	V	Pass
2509	-49.45	-13	-36.45	-65.72	-51.41	1.29	5.41	V	Pass
3345	-49.68	-13	-36.68	-67.95	-53.29	1.56	7.32	V	Pass



<High Channel>

Band :	GSM850				Temperature :	23~24°C			
Test Mode :	EDGE class 8 Link (8PSK)				Relative Humidity :	46~48%			
Test Engineer :	Derreck Chen and Ken Wu				Polarization :	Horizontal			
Remark :	Spurious emissions within 30-1000MHz were found more than 20dB below limit line.								
Frequency (MHz)	ERP (dBm)	Limit (dBm)	Over Limit (dB)	SPA Reading (dBm)	S.G. Power (dBm)	TX Cable loss (dB)	TX Antenna Gain (dBi)	Polarization (H/V)	Result
1696	-53.82	-13	-40.82	-64.93	-55.42	1.00	4.75	H	Pass
2546	-50.48	-13	-37.48	-65.95	-52.46	1.31	5.44	H	Pass
3395	-51.57	-13	-38.57	-67.62	-55.39	1.57	7.54	H	Pass

Band :	GSM850				Temperature :	23~24°C			
Test Mode :	EDGE class 8 Link (8PSK)				Relative Humidity :	46~48%			
Test Engineer :	Derreck Chen and Ken Wu				Polarization :	Vertical			
Remark :	Spurious emissions within 30-1000MHz were found more than 20dB below limit line.								
Frequency (MHz)	ERP (dBm)	Limit (dBm)	Over Limit (dB)	SPA Reading (dBm)	S.G. Power (dBm)	TX Cable loss (dB)	TX Antenna Gain (dBi)	Polarization (H/V)	Result
1696	-52.46	-13	-39.46	-65.92	-54.06	1.00	4.75	V	Pass
2546	-50.88	-13	-37.88	-66.45	-55.01	1.31	5.44	V	Pass
3395	-48.34	-13	-35.34	-66.19	-54.31	1.57	7.54	V	Pass



<Low Channel>

Band :	GSM1900				Temperature :	23~24°C			
Test Mode :	GSM Link (GMSK)				Relative Humidity :	46~48%			
Test Engineer :	Derreck Chen and Ken Wu				Polarization :	Horizontal			
Remark :	Spurious emissions within 30-1000MHz were found more than 20dB below limit line.								
Frequency (MHz)	EIRP (dBm)	Limit (dBm)	Over Limit (dB)	SPA Reading (dBm)	S.G. Power (dBm)	TX Cable loss (dB)	TX Antenna Gain (dBi)	Polarization (H/V)	Result
3700	-49.69	-13	-36.69	-66.69	-56.26	1.67	8.24	H	Pass
5548	-44.67	-13	-31.67	-66.99	-51.74	2.65	9.72	H	Pass
7403	-38.34	-13	-25.34	-67.59	-47.49	2.46	11.61	H	Pass

Band :	GSM1900				Temperature :	23~24°C			
Test Mode :	GSM Link (GMSK)				Relative Humidity :	46~48%			
Test Engineer :	Derreck Chen and Ken Wu				Polarization :	Vertical			
Remark :	Spurious emissions within 30-1000MHz were found more than 20dB below limit line.								
Frequency (MHz)	EIRP (dBm)	Limit (dBm)	Over Limit (dB)	SPA Reading (dBm)	S.G. Power (dBm)	TX Cable loss (dB)	TX Antenna Gain (dBi)	Polarization (H/V)	Result
3700	-48.32	-13	-35.32	-66.54	-54.89	1.67	8.24	V	Pass
5548	-45.48	-13	-32.48	-67.61	-52.55	2.65	9.72	V	Pass
7403	-38.99	-13	-25.99	-67.58	-48.14	2.46	11.61	V	Pass



<Middle Channel>

Band :	GSM1900				Temperature :	23~24°C			
Test Mode :	GSM Link (GMSK)				Relative Humidity :	46~48%			
Test Engineer :	Derreck Chen and Ken Wu				Polarization :	Horizontal			
Remark :	Spurious emissions within 30-1000MHz were found more than 20dB below limit line.								
Frequency (MHz)	EIRP (dBm)	Limit (dBm)	Over Limit (dB)	SPA Reading (dBm)	S.G. Power (dBm)	TX Cable loss (dB)	TX Antenna Gain (dBi)	Polarization (H/V)	Result
3763	-49.26	-13	-36.26	-66.86	-55.89	1.69	8.32	H	Pass
5639	-44.09	-13	-31.09	-66.66	-51.14	2.71	9.76	H	Pass
7522	-38.11	-13	-25.11	-67.27	-47.5	2.42	11.81	H	Pass

Band :	GSM1900				Temperature :	23~24°C			
Test Mode :	GSM Link (GMSK)				Relative Humidity :	46~48%			
Test Engineer :	Derreck Chen and Ken Wu				Polarization :	Vertical			
Remark :	Spurious emissions within 30-1000MHz were found more than 20dB below limit line.								
Frequency (MHz)	EIRP (dBm)	Limit (dBm)	Over Limit (dB)	SPA Reading (dBm)	S.G. Power (dBm)	TX Cable loss (dB)	TX Antenna Gain (dBi)	Polarization (H/V)	Result
3763	-47.96	-13	-34.96	-66.59	-54.59	1.69	8.32	V	Pass
5639	-44.09	-13	-31.09	-66.22	-51.14	2.71	9.76	V	Pass
7522	-38.89	-13	-25.89	-68.28	-48.28	2.42	11.81	V	Pass



<High Channel>

Band :	GSM1900				Temperature :	23~24°C			
Test Mode :	GSM Link (GMSK)				Relative Humidity :	46~48%			
Test Engineer :	Derreck Chen and Ken Wu				Polarization :	Horizontal			
Remark :	Spurious emissions within 30-1000MHz were found more than 20dB below limit line.								
Frequency (MHz)	EIRP (dBm)	Limit (dBm)	Over Limit (dB)	SPA Reading (dBm)	S.G. Power (dBm)	TX Cable loss (dB)	TX Antenna Gain (dBi)	Polarization (H/V)	Result
3707	-49.69	-13	-36.69	-66.68	-56.27	1.67	8.25	H	Pass
5555	-45.27	-13	-32.27	-67.64	-52.34	2.66	9.72	H	Pass
7410	-38.84	-13	-25.84	-68.14	-48	2.46	11.62	H	Pass

Band :	GSM1900				Temperature :	23~24°C			
Test Mode :	GSM Link (GMSK)				Relative Humidity :	46~48%			
Test Engineer :	Derreck Chen and Ken Wu				Polarization :	Vertical			
Remark :	Spurious emissions within 30-1000MHz were found more than 20dB below limit line.								
Frequency (MHz)	EIRP (dBm)	Limit (dBm)	Over Limit (dB)	SPA Reading (dBm)	S.G. Power (dBm)	TX Cable loss (dB)	TX Antenna Gain (dBi)	Polarization (H/V)	Result
3707	-48.87	-13	-35.87	-66.98	-55.45	1.67	8.25	V	Pass
5555	-45.10	-13	-32.10	-67.28	-52.17	2.66	9.72	V	Pass
7410	-37.96	-13	-24.96	-66.53	-47.12	2.46	11.62	V	Pass



<Low Channel>

Band :	GSM1900				Temperature :	23~24°C			
Test Mode :	EDGE class 8 Link (8PSK)				Relative Humidity :	46~48%			
Test Engineer :	Derreck Chen and Ken Wu				Polarization :	Horizontal			
Remark :	Spurious emissions within 30-1000MHz were found more than 20dB below limit line.								
Frequency (MHz)	EIRP (dBm)	Limit (dBm)	Over Limit (dB)	SPA Reading (dBm)	S.G. Power (dBm)	TX Cable loss (dB)	TX Antenna Gain (dBi)	Polarization (H/V)	Result
3700	-50.01	-13	-37.01	-67.32	-56.58	1.67	8.24	H	Pass
5548	-46.10	-13	-33.10	-68.19	-53.17	2.65	9.72	H	Pass
7403	-38.29	-13	-25.29	-67.3	-47.44	2.46	11.61	H	Pass

Band :	GSM1900				Temperature :	23~24°C			
Test Mode :	EDGE class 8 Link (8PSK)				Relative Humidity :	46~48%			
Test Engineer :	Derreck Chen and Ken Wu				Polarization :	Vertical			
Remark :	Spurious emissions within 30-1000MHz were found more than 20dB below limit line.								
Frequency (MHz)	EIRP (dBm)	Limit (dBm)	Over Limit (dB)	SPA Reading (dBm)	S.G. Power (dBm)	TX Cable loss (dB)	TX Antenna Gain (dBi)	Polarization (H/V)	Result
3700	-48.91	-13	-35.91	-67.63	-55.48	1.67	8.24	V	Pass
5548	-45.55	-13	-32.55	-67.39	-52.62	2.65	9.72	V	Pass
7403	-39.02	-13	-26.02	-68.09	-48.17	2.46	11.61	V	Pass



<Middle Channel>

Band :	GSM1900				Temperature :	23~24°C			
Test Mode :	EDGE class 8 Link (8PSK)				Relative Humidity :	46~48%			
Test Engineer :	Derreck Chen and Ken Wu				Polarization :	Horizontal			
Remark :	Spurious emissions within 30-1000MHz were found more than 20dB below limit line.								
Frequency (MHz)	EIRP (dBm)	Limit (dBm)	Over Limit (dB)	SPA Reading (dBm)	S.G. Power (dBm)	TX Cable loss (dB)	TX Antenna Gain (dBi)	Polarization (H/V)	Result
3763	-50.29	-13	-37.29	-67.29	-56.92	1.69	8.32	H	Pass
5639	-44.22	-13	-31.22	-67.03	-51.27	2.71	9.76	H	Pass
7522	-38.49	-13	-25.49	-67.48	-47.88	2.42	11.81	H	Pass

Band :	GSM1900				Temperature :	23~24°C			
Test Mode :	EDGE class 8 Link (8PSK)				Relative Humidity :	46~48%			
Test Engineer :	Derreck Chen and Ken Wu				Polarization :	Vertical			
Remark :	Spurious emissions within 30-1000MHz were found more than 20dB below limit line.								
Frequency (MHz)	EIRP (dBm)	Limit (dBm)	Over Limit (dB)	SPA Reading (dBm)	S.G. Power (dBm)	TX Cable loss (dB)	TX Antenna Gain (dBi)	Polarization (H/V)	Result
3763	-48.95	-13	-35.95	-67.09	-55.58	1.69	8.32	V	Pass
5639	-45.19	-13	-32.19	-67.32	-52.24	2.71	9.76	V	Pass
7522	-38.72	-13	-25.72	-67.79	-48.11	2.42	11.81	V	Pass



<High Channel>

Band :	GSM1900				Temperature :	23~24°C			
Test Mode :	EDGE class 8 Link (8PSK)				Relative Humidity :	46~48%			
Test Engineer :	Derreck Chen and Ken Wu				Polarization :	Horizontal			
Remark :	Spurious emissions within 30-1000MHz were found more than 20dB below limit line.								
Frequency (MHz)	EIRP (dBm)	Limit (dBm)	Over Limit (dB)	SPA Reading (dBm)	S.G. Power (dBm)	TX Cable loss (dB)	TX Antenna Gain (dBi)	Polarization (H/V)	Result
3819	-50.53	-13	-37.53	-68.23	-57.21	1.70	8.38	H	Pass
5730	-45.14	-13	-32.14	-67.97	-52.17	2.76	9.79	H	Pass
7641	-38.93	-13	-25.93	-67.27	-48.43	2.38	11.88	H	Pass

Band :	GSM1900				Temperature :	23~24°C			
Test Mode :	EDGE class 8 Link (8PSK)				Relative Humidity :	46~48%			
Test Engineer :	Derreck Chen and Ken Wu				Polarization :	Vertical			
Remark :	Spurious emissions within 30-1000MHz were found more than 20dB below limit line.								
Frequency (MHz)	EIRP (dBm)	Limit (dBm)	Over Limit (dB)	SPA Reading (dBm)	S.G. Power (dBm)	TX Cable loss (dB)	TX Antenna Gain (dBi)	Polarization (H/V)	Result
3819	-48.49	-13	-35.49	-67.82	-55.17	1.70	8.38	V	Pass
5730	-45.82	-13	-32.82	-68.32	-52.85	2.76	9.79	V	Pass
7641	-39.29	-13	-26.29	-67.45	-48.79	2.38	11.88	V	Pass



<Low Channel>

Band :	WCDMA Band V				Temperature :	23~24°C			
Test Mode :	RMC 12.2Kbps Link (QPSK)				Relative Humidity :	46~48%			
Test Engineer :	Derreck Chen and Ken Wu				Polarization :	Horizontal			
Remark :	Spurious emissions within 30-1000MHz were found more than 20dB below limit line.								
Frequency (MHz)	ERP (dBm)	Limit (dBm)	Over Limit (dB)	SPA Reading (dBm)	S.G. Power (dBm)	TX Cable loss (dB)	TX Antenna Gain (dBi)	Polarization (H/V)	Result
1656	-54.28	-13	-41.28	-65.43	-56.01	0.98	4.86	H	Pass
2480	-50.72	-13	-37.72	-65.83	-52.63	1.28	5.34	H	Pass
3304	-50.85	-13	-37.85	-66.59	-54.29	1.54	7.14	H	Pass

Band :	WCDMA Band V				Temperature :	23~24°C			
Test Mode :	RMC 12.2Kbps Link (QPSK)				Relative Humidity :	46~48%			
Test Engineer :	Derreck Chen and Ken Wu				Polarization :	Vertical			
Remark :	Spurious emissions within 30-1000MHz were found more than 20dB below limit line.								
Frequency (MHz)	ERP (dBm)	Limit (dBm)	Over Limit (dB)	SPA Reading (dBm)	S.G. Power (dBm)	TX Cable loss (dB)	TX Antenna Gain (dBi)	Polarization (H/V)	Result
1656	-51.78	-13	-38.78	-65.26	-53.51	0.98	4.86	V	Pass
2480	-50.48	-13	-37.48	-66.37	-52.39	1.28	5.34	V	Pass
3304	-49.07	-13	-36.07	-66.74	-52.51	1.54	7.14	V	Pass



<Middle Channel>

Band :	WCDMA Band V				Temperature :	23~24°C			
Test Mode :	RMC 12.2Kbps Link (QPSK)				Relative Humidity :	46~48%			
Test Engineer :	Derreck Chen and Ken Wu				Polarization :	Horizontal			
Remark :	Spurious emissions within 30-1000MHz were found more than 20dB below limit line.								
Frequency (MHz)	ERP (dBm)	Limit (dBm)	Over Limit (dB)	SPA Reading (dBm)	S.G. Power (dBm)	TX Cable loss (dB)	TX Antenna Gain (dBi)	Polarization (H/V)	Result
1672	-54.66	-13	-41.66	-65.76	-56.34	0.99	4.82	H	Pass
2509	-50.00	-13	-37.00	-65.55	-51.96	1.29	5.41	H	Pass
3345	-51.18	-13	-38.18	-67.57	-54.79	1.56	7.32	H	Pass

Band :	WCDMA Band V				Temperature :	23~24°C			
Test Mode :	RMC 12.2Kbps Link (QPSK)				Relative Humidity :	46~48%			
Test Engineer :	Derreck Chen and Ken Wu				Polarization :	Vertical			
Remark :	Spurious emissions within 30-1000MHz were found more than 20dB below limit line.								
Frequency (MHz)	ERP (dBm)	Limit (dBm)	Over Limit (dB)	SPA Reading (dBm)	S.G. Power (dBm)	TX Cable loss (dB)	TX Antenna Gain (dBi)	Polarization (H/V)	Result
1672	-52.40	-13	-39.40	-65.72	-54.08	0.99	4.82	V	Pass
2509	-50.48	-13	-37.48	-66.46	-52.44	1.29	5.41	V	Pass
3345	-49.75	-13	-36.75	-67.74	-53.36	1.56	7.32	V	Pass



<High Channel>

Band :	WCDMA Band V				Temperature :	23~24°C			
Test Mode :	RMC 12.2Kbps Link (QPSK)				Relative Humidity :	46~48%			
Test Engineer :	Derreck Chen and Ken Wu				Polarization :	Horizontal			
Remark :	Spurious emissions within 30-1000MHz were found more than 20dB below limit line.								
Frequency (MHz)	ERP (dBm)	Limit (dBm)	Over Limit (dB)	SPA Reading (dBm)	S.G. Power (dBm)	TX Cable loss (dB)	TX Antenna Gain (dBi)	Polarization (H/V)	Result
1696	-54.59	-13	-41.59	-65.75	-56.19	1.00	4.75	H	Pass
2512	-50.41	-13	-37.41	-66.17	-52.38	1.29	5.41	H	Pass
3344	-51.41	-13	-38.41	-67.55	-55.02	1.56	7.31	H	Pass

Band :	WCDMA Band V				Temperature :	23~24°C			
Test Mode :	RMC 12.2Kbps Link (QPSK)				Relative Humidity :	46~48%			
Test Engineer :	Derreck Chen and Ken Wu				Polarization :	Vertical			
Remark :	Spurious emissions within 30-1000MHz were found more than 20dB below limit line.								
Frequency (MHz)	ERP (dBm)	Limit (dBm)	Over Limit (dB)	SPA Reading (dBm)	S.G. Power (dBm)	TX Cable loss (dB)	TX Antenna Gain (dBi)	Polarization (H/V)	Result
1696	-52.42	-13	-39.42	-65.57	-54.02	1.00	4.75	V	Pass
2512	-50.14	-13	-37.14	-66.21	-52.11	1.29	5.41	V	Pass
3344	-49.67	-13	-36.67	-67.79	-53.28	1.56	7.31	V	Pass



<Low Channel>

Band :	WCDMA Band II				Temperature :	23~24°C			
Test Mode :	RMC 12.2Kbps Link (QPSK)				Relative Humidity :	46~48%			
Test Engineer :	Derreck Chen and Ken Wu				Polarization :	Horizontal			
Remark :	Spurious emissions within 30-1000MHz were found more than 20dB below limit line.								
Frequency (MHz)	EIRP (dBm)	Limit (dBm)	Over Limit (dB)	SPA Reading (dBm)	S.G. Power (dBm)	TX Cable loss (dB)	TX Antenna Gain (dBi)	Polarization (H/V)	Result
3707	-49.89	-13	-36.89	-67.32	-56.47	1.67	8.25	H	Pass
5557	-44.22	-13	-31.22	-66.54	-51.28	2.66	9.72	H	Pass
7409	-38.48	-13	-25.48	-67.56	-47.64	2.46	11.62	H	Pass

Band :	WCDMA Band II				Temperature :	23~24°C			
Test Mode :	RMC 12.2Kbps Link (QPSK)				Relative Humidity :	46~48%			
Test Engineer :	Derreck Chen and Ken Wu				Polarization :	Vertical			
Remark :	Spurious emissions within 30-1000MHz were found more than 20dB below limit line.								
Frequency (MHz)	EIRP (dBm)	Limit (dBm)	Over Limit (dB)	SPA Reading (dBm)	S.G. Power (dBm)	TX Cable loss (dB)	TX Antenna Gain (dBi)	Polarization (H/V)	Result
3707	-49.53	-13	-36.53	-67.69	-56.11	1.67	8.25	V	Pass
5557	-48.95	-13	-35.95	-67.89	-56.01	2.66	9.72	V	Pass
7409	-38.69	-13	-25.69	-67.36	-47.85	2.46	11.62	V	Pass



<Middle Channel>

Band :	WCDMA Band II				Temperature :	23~24°C			
Test Mode :	RMC 12.2Kbps Link (QPSK)				Relative Humidity :	46~48%			
Test Engineer :	Derreck Chen and Ken Wu				Polarization :	Horizontal			
Remark :	Spurious emissions within 30-1000MHz were found more than 20dB below limit line.								
Frequency (MHz)	EIRP (dBm)	Limit (dBm)	Over Limit (dB)	SPA Reading (dBm)	S.G. Power (dBm)	TX Cable loss (dB)	TX Antenna Gain (dBi)	Polarization (H/V)	Result
3760	-49.50	-13	-36.50	-67.15	-56.13	1.69	8.31	H	Pass
5640	-44.06	-13	-31.06	-67.09	-51.11	2.71	9.76	H	Pass
7520	-37.70	-13	-24.70	-66.81	-47.09	2.42	11.81	H	Pass

Band :	WCDMA Band II				Temperature :	23~24°C			
Test Mode :	RMC 12.2Kbps Link (QPSK)				Relative Humidity :	46~48%			
Test Engineer :	Derreck Chen and Ken Wu				Polarization :	Vertical			
Remark :	Spurious emissions within 30-1000MHz were found more than 20dB below limit line.								
Frequency (MHz)	EIRP (dBm)	Limit (dBm)	Over Limit (dB)	SPA Reading (dBm)	S.G. Power (dBm)	TX Cable loss (dB)	TX Antenna Gain (dBi)	Polarization (H/V)	Result
3760	-48.25	-13	-35.25	-66.63	-54.88	1.69	8.31	V	Pass
5640	-44.28	-13	-31.28	-66.73	-51.33	2.71	9.76	V	Pass
7520	-38.15	-13	-25.15	-67.24	-47.54	2.42	11.81	V	Pass



<High Channel>

Band :	WCDMA Band II				Temperature :	23~24°C			
Test Mode :	RMC 12.2Kbps Link (QPSK)				Relative Humidity :	46~48%			
Test Engineer :	Derreck Chen and Ken Wu				Polarization :	Horizontal			
Remark :	Spurious emissions within 30-1000MHz were found more than 20dB below limit line.								
Frequency (MHz)	EIRP (dBm)	Limit (dBm)	Over Limit (dB)	SPA Reading (dBm)	S.G. Power (dBm)	TX Cable loss (dB)	TX Antenna Gain (dBi)	Polarization (H/V)	Result
3812	-50.32	-13	-37.32	-67.86	-56.99	1.70	8.37	H	Pass
5722	-45.03	-13	-32.03	-67.86	-52.07	2.75	9.79	H	Pass
7630	-39.47	-13	-26.47	-67.85	-48.96	2.39	11.88	H	Pass

Band :	WCDMA Band II				Temperature :	23~24°C			
Test Mode :	RMC 12.2Kbps Link (QPSK)				Relative Humidity :	46~48%			
Test Engineer :	Derreck Chen and Ken Wu				Polarization :	Vertical			
Remark :	Spurious emissions within 30-1000MHz were found more than 20dB below limit line.								
Frequency (MHz)	EIRP (dBm)	Limit (dBm)	Over Limit (dB)	SPA Reading (dBm)	S.G. Power (dBm)	TX Cable loss (dB)	TX Antenna Gain (dBi)	Polarization (H/V)	Result
3815	-49.24	-13	-36.24	-67.5	-55.91	1.70	8.38	V	Pass
5722	-44.78	-13	-31.78	-67.33	-51.82	2.75	9.79	V	Pass
7627	-38.60	-13	-25.60	-67.15	-48.09	2.39	11.88	V	Pass

3.8 Frequency Stability Measurement

3.8.1 Description of Frequency Stability Measurement

The frequency stability shall be measured by variation of ambient temperature and variation of primary supply voltage to ensure that the fundamental emission stays within the authorized frequency block. The frequency stability of the transmitter shall be maintained within $\pm 0.00025\%$ ($\pm 2.5\text{ppm}$) of the center frequency.

3.8.2 Measuring Instruments

The measuring equipment is listed in the section 4 of this test report.

3.8.3 Test Procedures for Temperature Variation

1. The testing follows FCC KDB 971168 v02r02 Section 9.0.
2. The EUT was set up in the thermal chamber and connected with the system simulator.
3. With power OFF, the temperature was decreased to -30°C and the EUT was stabilized before testing. Power was applied and the maximum change in frequency was recorded within one minute.
4. With power OFF, the temperature was raised in 10°C steps up to 50°C . The EUT was stabilized at each step for at least half an hour. Power was applied and the maximum frequency change was recorded within one minute.

3.8.4 Test Procedures for Voltage Variation

1. The testing follows FCC KDB 971168 v02r02 Section 9.0.
2. The EUT was placed in a temperature chamber at $25\pm 5^{\circ}\text{C}$ and connected with the system simulator.
3. The power supply voltage to the EUT was varied from BEP to 115% of the nominal value measured at the input to the EUT.
4. The variation in frequency was measured for the worst case.

3.8.5 Test Setup

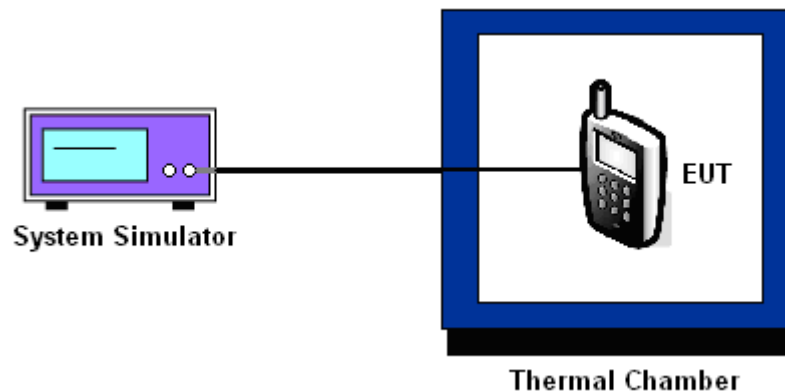



3.8.6 Test Result of Temperature Variation

Band :	GSM 850	Channel :	189
Limit (ppm) :	2.5	Frequency :	836.4 MHz

Temperature (°C)	GSM	EDGE class 8	Result
	Deviation (ppm)	Deviation (ppm)	
50	0.0024	0.0012	PASS
40	0.0012	0.0048	
30	0.0012	0.0060	
20(Ref.)	0.0000	0.0000	
10	0.0024	0.0060	
0	0.0000	0.0048	
-10	0.0060	0.0096	
-20	0.0275	0.0012	
-30	0.0000	0.0036	

Band :	GSM 1900	Channel :	661
Limit (ppm) :	within authorized band	Frequency :	1880.0 MHz

Temperature (°C)	GSM	EDGE class 8	Result
	Deviation (ppm)	Deviation (ppm)	
50	0.0005	0.0011	PASS
40	0.0027	0.0016	
30	0.0005	0.0011	
20(Ref.)	0.0000	0.0000	
10	0.0160	0.0000	
0	0.0144	0.0005	
-10	0.0160	0.0005	
-20	0.0011	0.0011	
-30	0.0154	0.0048	

Note: The frequency fundamental emissions stay within the authorized frequency block based on the frequency deviation measured is small.



Band :	WCDMA Band V	Channel :	4182
Limit (ppm) :	2.5	Frequency :	836.4 MHz

Temperature (°C)	RMC 12.2Kbps	Result
	Deviation (ppm)	
-30	0.0024	PASS
-20	0.0012	
-10	0.0036	
0	0.0000	
10	0.0012	
20(Ref.)	0.0179	
30	0.0179	
40	0.0203	
50	0.0167	

Band :	WCDMA Band II	Channel :	9400
Limit (ppm) :	within authorized band	Frequency :	1880.0 MHz

Temperature (°C)	RMC 12.2Kbps	Result
	Deviation (ppm)	
-30	0.0005	PASS
-20	0.0000	
-10	0.0011	
0	0.0000	
10	0.0090	
20(Ref.)	0.0085	
30	0.0096	
40	0.0101	
50	0.0117	

Note: The frequency fundamental emissions stay within the authorized frequency block based on the frequency deviation measured is small.



3.8.7 Test Result of Voltage Variation

Band & Channel	Mode	Voltage (Volt)	Deviation (ppm)	Limit (ppm)	Result
GSM 850 CH189	GSM	4.2	0.0048	2.5	PASS
		3.8	0.0024		
		BEP	0.0024		
	EDGE class 8	4.2	0.0120		
		3.8	0.0048		
		BEP	0.0096		
GSM 1900 CH661	GSM	4.2	0.0005	(Note 3.)	
		3.8	0.0011		
		BEP	0.0027		
	EDGE class 8	4.2	0.0021		
		3.8	0.0027		
		BEP	0.0016		
WCDMA Band V CH4182	RMC 12.2Kbps	4.2	0.0179	2.5	
		3.8	0.0143		
		BEP	0.0155		
WCDMA Band II CH9400	RMC 12.2Kbps	4.2	0.0085	(Note 3.)	
		3.8	0.0059		
		BEP	0.0074		

Note:

1. Normal Voltage = 3.8V.
2. Battery End Point (BEP) = 3.40 V.
3. The frequency fundamental emissions stay within the authorized frequency block based on the frequency deviation measured is small.



4 List of Measuring Equipment

Instrument	Manufacturer	Model No.	Serial No.	Characteristics	Calibration Date	Test Date	Due Date	Remark
System Simulator	Rohde & Schwarz	CMU200	117995	N/A	Jul. 29, 2014	Dec. 07, 2014 ~ Dec. 08, 2014	Jul. 28, 2015	Conducted (TH02-HY)
Spectrum Analyzer	Rohde & Schwarz	FSP40	100055	9kHz~40GHz	Jun. 09, 2014	Dec. 07, 2014 ~ Dec. 08, 2014	Jun. 08, 2015	Conducted (TH02-HY)
Thermal Chamber	Ten Billion	TTH-D3SP	TBN-930701	N/A	Jul. 17, 2014	Dec. 07, 2014 ~ Dec. 08, 2014	Jul. 16, 2015	Conducted (TH02-HY)
Spectrum Analyzer	Rohde & Schwarz	FSV30	101749	10Hz ~ 30GHz	Feb. 10, 2014	Dec. 02, 2014 ~ Dec. 03, 2014	Feb. 09, 2015	Radiation (03CH07-HY)
Bilog Antenna	Schaffner	CBL6111C	2726	30MHz ~ 1GHz	Sep. 27, 2014	Dec. 02, 2014 ~ Dec. 03, 2014	Sep. 26, 2015	Radiation (03CH07-HY)
Double Ridge Horn Antenna	ESCO	3117	75962	1GHz~18GHz	Aug. 19, 2014	Dec. 02, 2014 ~ Dec. 03, 2014	Aug. 18, 2015	Radiation (03CH07-HY)
SHF-EHF Horn Antenna	SCHWARZBECK	BBHA 9170	BBHA9170251	18GHz~40GHz	Oct. 02, 2014	Dec. 02, 2014 ~ Dec. 03, 2014	Oct. 01, 2015	Radiation (03CH07-HY)
Preamplifier	COM-POWER	PA-103A	161241	10 MHz ~ 1000MHz	Mar. 17, 2014	Dec. 02, 2014 ~ Dec. 03, 2014	Mar. 16, 2015	Radiation (03CH07-HY)
Preamplifier	Agilent	8449B	3008A02362	1 GHz~26.5 GHz	Oct. 21, 2014	Dec. 02, 2014 ~ Dec. 03, 2014	Oct. 20, 2015	Radiation (03CH07-HY)
Turn Table	ChainTek	ChainTek 3000	N/A	0 ~ 360 degree	N/A	Dec. 02, 2014 ~ Dec. 03, 2014	N/A	Radiation (03CH07-HY)
Antenna Mast	ChainTek	M-400-0	114/8000604/L	N/A	N/A	Dec. 02, 2014 ~ Dec. 03, 2014	N/A	Radiation (03CH07-HY)
Signal Generator	Rohde & Schwarz	SMF100A	101107	100kHz~40GHz	May 23, 2014	Dec. 02, 2014 ~ Dec. 03, 2014	May 22, 2015	Radiation (03CH07-HY)
Double Ridge Horn Antenna	ESCO	3117	00066583	1GHz~18GHz	Jul. 24, 2014	Dec. 02, 2014 ~ Dec. 03, 2014	Jul. 23, 2015	Radiation (03CH07-HY)



5 Uncertainty of Evaluation

Uncertainty of Radiated Emission Measurement (30 MHz ~ 1000 MHz)

Measuring Uncertainty for a Level of Confidence of 95% ($U = 2Uc(y)$)	4.50
---	------