



FCC RF Test Report

APPLICANT : Motorola Mobility, LLC
EQUIPMENT : Mobile Cellular Phone
BRAND NAME : Motorola Mobility, LLC
MODEL NAME : 3605
FCC ID : IHDT56QA2
STANDARD : FCC Part 15 Subpart E §15.407
CLASSIFICATION : (NII) Unlicensed National Information Infrastructure

The product was received on May 14, 2014. We, SPORTON INTERNATIONAL INC., would like to declare that the tested sample has been evaluated in accordance with the test procedures and has been in compliance with the applicable technical standards.

The test results in this report apply exclusively to the tested model / sample. Without written approval of SPORTON INTERNATIONAL INC., the test report shall not be reproduced except in full.

Reviewed by: Joseph Lin / Supervisor

Approved by: Jones Tsai / Manager



Testing Laboratory
1190

SPORTON INTERNATIONAL INC.

No. 52, Hwa Ya 1st Rd., Hwa Ya Technology Park, Kwei-Shan Hsiang, Tao Yuan Hsien, Taiwan, R.O.C.



TABLE OF CONTENTS

REVISION HISTORY.....	3
1 GENERAL DESCRIPTION	4
1.1 Applicant.....	4
1.2 Manufacturer.....	4
1.3 Feature of Equipment Under Test.....	4
1.4 Product Specification of Equipment Under Test.....	5
1.5 Modification of EUT	5
APPENDIX A. ORIGINAL REPORT	



1 General Description

1.1 Applicant

Motorola Mobility, LLC

222 W Merchandise Mart Plaza, Suite 1800, Chicago, IL 60654, United States

1.2 Manufacturer

Motorola Mobility, LLC

222 W Merchandise Mart Plaza, Suite 1800, Chicago, IL 60654, United States

1.3 Feature of Equipment Under Test

Product Feature & Specification	
Equipment	Mobile Cellular Phone
Brand Name	Motorola Mobility, LLC
Model Name	3605
FCC ID	IHDT56QA2
EUT supports Radios application	CDMA/EV-DO/GSM/EGPRS/WCDMA/HSPA/LTE/NFC WLAN 11b/g/n HT20 WLAN 11a/n HT20/HT40 WLAN 11ac VHT20/VHT40/VHT80 Bluetooth v3.0 + EDR Bluetooth v4.0 - LE
HW Version	P2A
SW Version	victara_verizon_userdebug_4.4.3_KXE21.110_73_intcfg _test-keys_verizon_US(MSM8974BP_201.56.04.29R)
EUT Stage	Identical Prototype

Remark: The above EUT's information was declared by manufacturer. Please refer to the specifications or user's manual for more detailed description.



1.4 Product Specification of Equipment Under Test

Product Specification subjective to this standard	
Tx/Rx Frequency Range	5180 MHz ~ 5240 MHz 5260 MHz ~ 5320 MHz 5500 MHz ~ 5580 MHz 5660 MHz ~ 5700 MHz
Antenna Type & Antenna Gain	<5180 MHz ~ 5240 MHz> Fixed Internal Antenna with gain 1.20 dBi <5260 MHz ~ 5320 MHz> Fixed Internal Antenna with gain 1.20 dBi <5500 MHz ~ 5580 MHz and 5660 MHz ~ 5700 MHz> Fixed Internal Antenna with gain 1.40 dBi
Type of Modulation	802.11a/n : OFDM (BPSK / QPSK / 16QAM / 64QAM) 802.11ac : OFDM (BPSK / QPSK / 16QAM / 64QAM / 256QAM)

1.5 Modification of EUT

No modifications are made to the EUT during all test items.



Appendix A. Original Report

Please refer to Sporton report number FR442943E as below.



FCC RF Test Report

APPLICANT : Motorola Mobility, LLC
EQUIPMENT : Mobile Cellular Phone
BRAND NAME : Motorola Mobility, LLC
MODEL NAME : 3578
FCC ID : IHDT56QA1
STANDARD : FCC Part 15 Subpart E §15.407
CLASSIFICATION : (NII) Unlicensed National Information Infrastructure

The product was received on Apr. 29, 2014 and testing was completed on Jul. 11, 2014. We, SPORTON INTERNATIONAL INC., would like to declare that the tested sample has been evaluated in accordance with the test procedures and has been in compliance with the applicable technical standards.

The test results in this report apply exclusively to the tested model / sample. Without written approval of SPORTON INTERNATIONAL INC., the test report shall not be reproduced except in full.

Reviewed by: Joseph Lin / Supervisor

Approved by: Jones Tsai / Manager



SPORTON INTERNATIONAL INC.

No. 52, Hwa Ya 1st Rd., Hwa Ya Technology Park, Kwei-Shan Hsiang, Tao Yuan Hsien, Taiwan, R.O.C.

SPORTON INTERNATIONAL INC.

TEL : 886-3-327-3456

FAX : 886-3-328-4978

FCC ID : IHDT56QA1

Page Number : 1 of 143

Report Issued Date : Jul. 11, 2014

Report Version : Rev. 02

Report Template No.: BU5-FR15EWL Version 1.0



TABLE OF CONTENTS

REVISION HISTORY..... 3

SUMMARY OF TEST RESULT 4

1 GENERAL DESCRIPTION 5

 1.1 Applicant 5

 1.2 Manufacturer..... 5

 1.3 Feature of Equipment Under Test 5

 1.4 Product Specification of Equipment Under Test..... 6

 1.5 Modification of EUT 6

 1.6 Testing Location 7

 1.7 Applicable Standards..... 7

2 TEST CONFIGURATION OF EQUIPMENT UNDER TEST 8

 2.1 Carrier Frequency Channel 9

 2.2 Pre-Scanned RF Power..... 10

 2.3 Test Mode..... 16

 2.4 Connection Diagram of Test System..... 19

 2.5 Support Unit used in test configuration and system 20

 2.6 EUT Operation Test Setup 20

 2.7 Measurement Results Explanation Example..... 20

3 TEST RESULT..... 21

 3.1 26dB & 99% Occupied Bandwidth Measurement 21

 3.2 Maximum Conducted Output Power Measurement 33

 3.3 Power Spectral Density Measurement 40

 3.4 Unwanted Radiated Emission Measurement 46

 3.5 AC Conducted Emission Measurement..... 133

 3.6 Frequency Stability Measurement..... 138

 3.7 Automatically Discontinue Transmission 140

 3.8 Antenna Requirements..... 141

4 LIST OF MEASURING EQUIPMENTS..... 142

5 UNCERTAINTY OF EVALUATION 143



SUMMARY OF TEST RESULT

Report Section	FCC Rule	Description	Limit	Result	Remark
3.1	15.403(i)	26dB & 99% Bandwidth	-	Pass	-
3.2	15.407(a)	Maximum Conducted Output Power	≤ 17, 24, 30 dBm (depend on band)	Pass	-
3.3	15.407(a)	Power Spectral Density	≤ 4, 11, 17 dBm (depend on band)	Pass	-
3.4	15.407(b)	Unwanted Emissions	≤ -17, -27 dBm (depend on band)&15.209(a)	Pass	Under limit 0.17 dB at 5448.240 MHz
3.5	15.207	AC Conducted Emission	15.207(a)	Pass	Under limit 16.60 dB at 2.918 MHz
3.6	15.407(g)	Frequency Stability	Within Operation Band	Pass	-
3.7	15.407(c)	Automatically Discontinue Transmission	Discontinue Transmission	Pass	-
3.8	15.203 & 15.407(a)	Antenna Requirement	N/A	Pass	-



1 General Description

1.1 Applicant

Motorola Mobility, LLC

222 W Merchandise Mart Plaza, Suite 1800, Chicago, IL 60654, United States

1.2 Manufacturer

Motorola Mobility, LLC

222 W Merchandise Mart Plaza, Suite 1800, Chicago, IL 60654, United States

1.3 Feature of Equipment Under Test

Product Feature & Specification	
Equipment	Mobile Cellular Phone
Brand Name	Motorola Mobility, LLC
Model Name	3578
FCC ID	IHDT56QA1
EUT supports Radios application	GSM/EGPRS/WCDMA/HSPA/LTE/NFC WLAN 11b/g/n HT20 WLAN 11a/n HT20/HT40 WLAN 11ac VHT20/VHT40/VHT80 Bluetooth v3.0 + EDR Bluetooth v4.0 - LE
HW Version	P2
SW Version	KXE21.99.169
EUT Stage	Identical Prototype

Remark: The above EUT's information was declared by manufacturer. Please refer to the specifications or user's manual for more detailed description.

Accessory List	
AC Adapter	Brand Name : Motorola
	Model Name : SPN5788A
Earphone	Brand Name : Motorola
	Model Name : SJYN1305A



1.4 Product Specification of Equipment Under Test

Product Specification subjective to this standard	
Tx/Rx Frequency Range	5180 MHz ~ 5240 MHz 5260 MHz ~ 5320 MHz 5500 MHz ~ 5580 MHz 5660 MHz ~ 5700 MHz
Maximum Output Power to Antenna	<p><5180 MHz ~ 5240 MHz> 802.11a : 17.49 dBm / 0.0561 W 802.11n HT20 : 17.54 dBm / 0.0568 W 802.11n HT40 : 17.63 dBm / 0.0579 W 802.11ac VHT20 : 17.56 dBm / 0.0570 W 802.11ac VHT40 : 17.17 dBm / 0.0521 W 802.11ac VHT80 : 17.60 dBm / 0.0575 W</p> <p><5260 MHz ~ 5320 MHz> 802.11a : 16.98 dBm / 0.0499 W 802.11n HT20 : 16.93 dBm / 0.0493 W 802.11n HT40 : 16.91 dBm / 0.0491 W 802.11ac VHT20 : 16.99 dBm / 0.0500 W 802.11ac VHT40 : 16.94 dBm / 0.0494 W 802.11ac VHT80 : 15.04 dBm / 0.0319 W</p> <p><5500 MHz ~ 5580 MHz and 5660 MHz ~ 5700 MHz > 802.11a : 17.36 dBm / 0.0545 W 802.11n HT20 : 17.07 dBm / 0.0509 W 802.11n HT40 : 17.21 dBm / 0.0526 W 802.11ac VHT20 : 17.23 dBm / 0.0528 W 802.11ac VHT40 : 17.07 dBm / 0.0509 W 802.11ac VHT80 : 14.22 dBm / 0.0264 W</p>
99% Occupied Bandwidth	802.11a : 18.15 MHz 802.11n HT20 : 19.00 MHz 802.11n HT40 : 36.63 MHz 802.11ac VHT20: 19.00 MHz 802.11ac VHT40 : 36.45 MHz 802.11ac VHT80 : 75.20 MHz
Antenna Type & Antenna Gain	<p><5180 MHz ~ 5240 MHz> Fixed Internal Antenna with gain 1.20 dBi</p> <p><5260 MHz ~ 5320 MHz> Fixed Internal Antenna with gain 1.20 dBi</p> <p><5500 MHz ~ 5580 MHz and 5660 MHz ~ 5700 MHz> Fixed Internal Antenna with gain 1.40 dBi</p>
Type of Modulation	802.11a/n : OFDM (BPSK / QPSK / 16QAM / 64QAM) 802.11ac : OFDM (BPSK / QPSK / 16QAM / 64QAM / 256QAM)

1.5 Modification of EUT

No modifications are made to the EUT during all test items.



1.6 Testing Location

Sporton Lab is accredited to ISO 17025 by Taiwan Accreditation Foundation (TAF code : 1190) and the FCC designation No. TW1022 under the FCC 2.948(e) by Mutual Recognition Agreement (MRA) in FCC Test.

Test Site	SPORTON INTERNATIONAL INC.		
Test Site Location	No. 52, Hwa Ya 1 st Rd., Hwa Ya Technology Park, Kwei-Shan Hsiang, Tao Yuan Hsien, Taiwan, R.O.C. TEL: +886-3-3273456 / FAX: +886-3-3284978		
Test Site No.	Sporton Site No.		
	TH02-HY	CO05-HY	03CH06-HY

1.7 Applicable Standards

According to the specifications of the manufacturer, the EUT must comply with the requirements of the following standards:

- ♦ FCC Part 15 Subpart E
- ♦ FCC KDB 644545 D01 Guidance for IEEE 802.11ac and Pre-ac Device Emissions Testing v01r02.
- ♦ FCC KDB 789033 D02 General UNII Test Procedures New Rules v01
- ♦ ANSI C63.4-2003

Remark:

1. All test items were verified and recorded according to the standards and without any deviation during the test.
2. This EUT has also been tested and complied with the requirements of FCC Part 15, Subpart B, recorded in a separate test report.



2 Test Configuration of Equipment Under Test

The EUT has been associated with peripherals and configuration operated in a manner tended to maximize its emission characteristics in a typical application. Frequency range investigated: conducted emission (150 kHz to 30 MHz) and radiated emission (9 kHz to the 10th harmonic of the highest fundamental frequency or to 40 GHz, whichever is lower). For radiated measurement, pre-scanned in three orthogonal panels, X, Y, Z. The worst cases (Y plane) were recorded in this report.

The final configuration from all the combinations and the worst-case data rates were investigated by measuring the maximum power across all the data rates and modulation modes under section 2.2.

Based on the worst configuration found above, the RF power setting is set individually to meet FCC compliance limit for the final conducted and radiated tests shown in section 2.3.



2.1 Carrier Frequency Channel

Frequency Band	Channel	Freq. (MHz)	Channel	Freq. (MHz)
5150-5250 MHz Band 1 (U-NII-1)	36	5180	44	5220
	38	5190	46	5230
	40	5200	48	5240
	42	5210		

Frequency Band	Channel	Freq. (MHz)	Channel	Freq. (MHz)
5250-5350 MHz Band 2 (U-NII-2A)	52	5260	60	5300
	54	5270	62	5310
	56	5280	64	5320
	58	5290		

Frequency Band	Channel	Freq. (MHz)	Channel	Freq. (MHz)
5470-5600 MHz and 5650-5725 MHz Band 3 (U-NII-2C)	100	5500	112	5560
	102	5510	116	5580
	104	5520	132	5660
	106	5530	134	5670
	108	5540	136	5680
	110	5550	140	5700

Note: The above Frequency and Channel in boldface were 802.11n HT40.



2.2 Pre-Scanned RF Power

Preliminary tests were performed in different data rate and data rate associated with the highest power were chosen for full test in the following tables. Final Output Power equals to Measured Output Power adds the duty factor.

Channel	Frequency	5GHz 802.11a Average Power (dBm) (800ns)							
		Data Rate							
		6 Mbps	9 Mbps	12 Mbps	18 Mbps	24 Mbps	36 Mbps	48 Mbps	54 Mbps
CH 36	5180 MHz	17.49	17.40	17.44	17.48	17.48	17.46	17.46	15.97
CH 44	5220 MHz	17.22	17.17	17.20	17.14	17.19	17.17	17.15	15.66
CH 48	5240 MHz	17.26	17.15	17.19	17.22	17.25	17.21	17.25	15.80
CH 52	5260 MHz	16.89	16.82	16.83	16.82	16.85	16.75	16.80	15.46
CH 60	5300 MHz	16.98	16.94	16.95	16.94	16.97	16.87	16.92	15.58
CH 64	5320 MHz	16.93	16.87	16.88	16.87	16.90	16.80	16.85	15.51
CH 100	5500 MHz	17.28	17.14	17.19	17.13	17.20	16.17	15.41	14.54
CH 116	5580 MHz	17.36	17.24	17.29	17.23	17.30	16.27	15.51	14.64
CH 140	5700 MHz	14.47	14.39	14.43	14.41	14.19	14.35	14.32	14.33

Channel	Frequency	5GHz 802.11a Peak Power (dBm) (800ns)							
		Data Rate							
		6 Mbps	9 Mbps	12 Mbps	18 Mbps	24 Mbps	36 Mbps	48 Mbps	54 Mbps
CH 36	5180 MHz	25.30	25.27	25.23	25.13	25.22	25.26	25.29	25.20
CH 44	5220 MHz	25.12	21.11	25.01	25.05	25.05	25.01	25.02	25.00
CH 48	5240 MHz	25.23	25.15	25.11	25.09	25.06	25.01	25.03	25.02
CH 52	5260 MHz	24.75	24.68	24.70	24.74	24.70	24.65	24.71	24.68
CH 60	5300 MHz	25.08	25.00	25.02	25.06	25.02	24.97	25.03	25.00
CH 64	5320 MHz	25.02	24.91	24.93	24.97	24.93	24.88	24.94	24.91
CH 100	5500 MHz	25.28	25.14	25.13	25.16	25.19	25.10	25.05	24.62
CH 116	5580 MHz	25.50	25.42	25.41	25.44	25.47	25.38	25.33	24.90
CH 140	5700 MHz	24.42	24.21	24.08	24.20	24.17	24.17	24.20	24.41



Channel	Frequency	5GHz 802.11n HT20 Average Power (dBm) (800ns)							
		Data Rate							
		MCS0	MCS1	MCS2	MCS3	MCS4	MCS5	MCS6	MCS7
CH 36	5180 MHz	17.54	17.49	17.49	17.45	17.43	17.45	16.07	13.86
CH 44	5220 MHz	17.34	17.29	17.33	17.26	17.23	17.30	15.94	13.87
CH 48	5240 MHz	17.28	17.27	17.23	17.16	17.14	17.25	15.90	13.88
CH 52	5260 MHz	16.93	16.83	16.90	16.82	16.87	16.86	15.49	13.48
CH 60	5300 MHz	16.79	16.66	16.73	16.65	16.70	16.69	15.32	13.31
CH 64	5320 MHz	16.77	16.64	16.71	16.63	16.68	16.67	15.30	13.29
CH 100	5500 MHz	16.28	16.22	16.27	16.12	16.14	15.34	14.42	13.28
CH 116	5580 MHz	17.07	16.94	16.94	16.91	16.05	15.25	14.33	13.19
CH 140	5700 MHz	13.77	13.67	13.74	13.50	13.74	13.76	13.64	13.07

Channel	Frequency	5GHz 802.11n HT20 Peak Power (dBm) (800ns)							
		Data Rate							
		MCS0	MCS1	MCS2	MCS3	MCS4	MCS5	MCS6	MCS7
CH 36	5180 MHz	25.29	25.25	25.20	25.18	25.28	25.24	24.98	24.32
CH 44	5220 MHz	25.17	25.11	25.01	25.05	25.02	25.01	24.95	24.39
CH 48	5240 MHz	25.14	25.10	25.02	24.92	24.82	24.85	24.92	24.49
CH 52	5260 MHz	24.96	24.93	24.89	24.86	24.83	24.85	24.73	23.48
CH 60	5300 MHz	24.89	24.84	24.80	24.77	24.74	24.76	24.64	23.39
CH 64	5320 MHz	24.80	24.72	24.68	24.65	24.62	24.64	24.52	23.27
CH 100	5500 MHz	25.17	25.14	25.08	25.12	25.16	25.07	24.63	23.48
CH 116	5580 MHz	25.26	25.18	25.09	25.17	25.12	24.92	24.48	23.33
CH 140	5700 MHz	23.92	23.85	23.78	23.75	23.65	23.88	23.84	23.09



Channel	Frequency	5GHz 802.11n HT40 Average Power (dBm) (800ns)							
		Data Rate							
		MCS0	MCS1	MCS2	MCS3	MCS4	MCS5	MCS6	MCS7
CH 38	5190MHz	13.89	13.81	13.87	13.86	13.88	13.71	13.85	13.73
CH 46	5230MHz	17.63	17.31	17.30	17.33	17.36	17.30	15.94	14.01
CH 54	5270MHz	16.91	16.86	16.88	16.86	16.88	16.83	15.71	13.57
CH 62	5310MHz	14.71	14.70	14.67	14.65	14.63	14.63	14.45	13.34
CH 102	5510MHz	14.74	14.72	14.70	14.73	14.47	14.71	14.54	14.71
CH 110	5550MHz	17.21	17.13	17.09	17.10	17.02	16.08	15.52	14.64
CH 134	5670MHz	16.85	16.82	16.79	16.80	16.72	15.78	15.22	14.34

Channel	Frequency	5GHz 802.11n HT40 Peak Power (dBm) (800ns)							
		Data Rate							
		MCS0	MCS1	MCS2	MCS3	MCS4	MCS5	MCS6	MCS7
CH 38	5190MHz	24.23	24.10	24.01	23.95	23.91	24.00	23.95	23.91
CH 46	5230MHz	26.03	26.00	25.79	25.72	25.71	25.80	25.26	23.47
CH 54	5270MHz	25.12	24.92	25.00	25.01	25.09	24.96	24.75	23.34
CH 62	5310MHz	24.43	24.42	24.22	24.26	24.28	24.28	24.38	23.17
CH 102	5510MHz	24.42	24.39	24.36	24.42	24.31	24.21	24.20	24.33
CH 110	5550MHz	25.47	25.28	25.36	25.42	25.40	25.35	24.51	24.40
CH 134	5670MHz	25.11	24.90	24.98	25.04	25.02	24.97	24.13	24.02



Channel	Frequency	5GHz 802.11ac VHT20 Average Power (dBm) (800ns)								
		Data Rate								
		MCS0	MCS1	MCS2	MCS3	MCS4	MCS5	MCS6	MCS7	MCS8
CH 36	5180 MHz	17.56	17.43	17.51	17.41	17.33	17.43	16.14	15.14	13.87
CH 44	5220 MHz	17.26	17.24	17.20	17.22	17.12	17.21	16.13	15.04	13.84
CH 48	5240 MHz	17.36	17.34	17.30	17.32	17.22	17.31	16.23	15.14	13.94
CH 52	5260 MHz	16.93	16.88	16.87	16.78	16.80	16.86	15.35	14.45	13.55
CH 60	5300 MHz	16.99	16.97	16.96	16.87	16.89	16.95	15.44	14.54	13.64
CH 64	5320 MHz	16.86	16.80	16.79	16.70	16.72	16.78	15.27	14.37	13.47
CH 100	5500 MHz	17.23	17.22	17.19	17.15	16.16	15.50	14.54	13.47	12.36
CH 116	5580 MHz	17.19	17.15	17.12	17.08	16.09	15.43	14.47	13.40	12.29
CH 140	5700 MHz	14.60	14.54	14.52	14.53	14.47	14.50	14.41	13.34	12.23

Channel	Frequency	5GHz 802.11ac VHT20 Peak Power (dBm) (800ns)								
		Data Rate								
		MCS0	MCS1	MCS2	MCS3	MCS4	MCS5	MCS6	MCS7	MCS8
CH 36	5180 MHz	25.37	25.28	24.96	25.13	25.28	24.86	24.76	23.93	23.19
CH 44	5220 MHz	25.20	25.12	25.01	25.05	25.01	24.95	24.91	24.01	23.49
CH 48	5240 MHz	25.33	25.11	25.21	25.12	25.13	24.95	24.79	24.05	23.41
CH 52	5260 MHz	24.99	24.92	24.54	24.72	24.87	24.56	24.22	23.49	22.66
CH 60	5300 MHz	25.11	25.05	24.67	24.85	25.00	24.69	24.35	23.62	22.79
CH 64	5320 MHz	25.02	24.92	24.54	24.72	24.87	24.56	24.22	23.49	22.66
CH 100	5500 MHz	25.44	25.38	25.16	25.15	25.30	24.36	23.54	22.46	21.71
CH 116	5580 MHz	25.33	25.21	24.99	24.98	25.13	24.19	23.37	22.29	21.54
CH 140	5700 MHz	24.40	24.34	23.83	24.00	24.30	24.10	23.15	22.07	21.32



Channel	Frequency	5GHz 802.11ac VHT40 Average Power (dBm) (800ns)									
		Data Rate									
		MCS0	MCS1	MCS2	MCS3	MCS4	MCS5	MCS6	MCS7	MCS8	MCS9
CH 38	5190MHz	15.16	15.04	15.13	14.95	15.13	15.08	15.12	13.87	13.06	12.42
CH 46	5230MHz	17.17	17.12	17.13	17.09	17.15	17.06	15.11	13.69	12.74	12.14
CH 54	5270MHz	16.94	16.84	16.86	16.79	16.91	16.90	14.88	13.71	12.68	12.00
CH 62	5310MHz	14.58	14.52	14.50	14.46	14.53	14.54	14.51	13.54	12.69	11.96
CH 102	5510MHz	15.16	15.00	14.97	15.00	15.12	15.04	15.03	14.47	13.59	12.52
CH 110	5550MHz	17.07	17.01	16.90	17.00	17.03	16.44	15.77	14.76	13.73	12.74
CH 134	5670MHz	16.67	16.61	16.62	16.59	16.19	15.46	14.36	13.02	12.40	12.53

Channel	Frequency	5GHz 802.11ac VHT40 Peak Power (dBm) (800ns)									
		Data Rate									
		MCS0	MCS1	MCS2	MCS3	MCS4	MCS5	MCS6	MCS7	MCS8	MCS9
CH 38	5190MHz	24.56	24.50	24.34	24.42	24.21	24.50	24.55	22.99	22.01	21.65
CH 46	5230MHz	25.05	25.00	24.95	24.91	24.90	25.00	24.85	24.81	24.85	24.80
CH 54	5270MHz	24.83	24.80	24.82	24.78	24.72	23.42	24.32	22.75	21.53	21.42
CH 62	5310MHz	24.31	24.18	24.10	24.00	23.88	24.22	24.30	22.62	21.58	21.26
CH 102	5510MHz	24.88	24.75	24.66	24.49	24.36	24.87	24.70	23.53	22.41	21.90
CH 110	5550MHz	25.10	25.06	25.02	25.07	25.00	25.02	25.01	23.84	22.66	21.66
CH 134	5670MHz	24.78	24.72	24.71	24.60	24.70	24.72	23.93	22.36	21.46	22.10



Channel	Frequency	5GHz 802.11ac VHT80 Average Power (dBm) (800ns)									
		Data Rate									
		MCS0	MCS1	MCS2	MCS3	MCS4	MCS5	MCS6	MCS7	MCS8	MCS9
CH 42	5210MHz	17.60	17.56	17.59	17.53	17.02	16.28	15.47	14.63	13.45	12.84
CH 58	5290MHz	15.04	14.85	15.01	15.01	14.91	14.93	14.93	13.94	12.80	12.27
CH 106	5530MHz	14.22	13.91	13.91	13.89	13.84	14.04	13.89	14.16	13.76	12.73

Channel	Frequency	5GHz 802.11ac VHT80 Peak Power (dBm) (800ns)									
		Data Rate									
		MCS0	MCS1	MCS2	MCS3	MCS4	MCS5	MCS6	MCS7	MCS8	MCS9
CH 42	5210MHz	25.33	25.30	25.28	25.29	25.22	25.27	24.65	23.95	23.36	22.47
CH 58	5290MHz	24.74	24.61	24.65	24.67	24.73	24.57	24.60	23.39	22.95	21.98
CH 106	5530MHz	23.89	23.79	23.85	23.82	23.72	23.72	23.69	23.69	23.80	22.50



2.3 Test Mode

Final results of test modes, data rates and test channels are shown as following table.

Test Cases				
Conducted TCs	Test Items	Mode	Data Rate	Test Channel
		26dB and 99% BW Power Spectral Density	802.11a	6 Mbps
802.11n HT20			MCS0	L/M/H
802.11n HT40			MCS0	Band 1 & 2: L/H Band 3: L/M/H
802.11ac VHT20			MCS0	L/M/H
802.11ac VHT40			MCS0	Band 1 & 2: L/H Band 3: L/M/H
802.11ac VHT80			MCS0	M
20dB Occupied Bandwidth		802.11a	6 Mbps	Band 1 & 3: H Band 2: L
		802.11n HT20	MCS0	Band 1 & 3: H Band 2: L
		802.11n HT40	MCS0	Band 1 & 3: H Band 2: L
		802.11ac VHT20	MCS0	Band 1 & 3: H Band 2: L
		802.11ac VHT40	MCS0	Band 1 & 3: H Band 2: L
		802.11ac VHT80	MCS0	M
Output Power		802.11a	6 Mbps	L/M/H
		802.11n HT20	MCS0	L/M/H
		802.11n HT40	MCS0	Band 1 & 2: L/H Band 3: L/M/H
		802.11ac VHT20	MCS0	L/M/H
		802.11ac VHT40	MCS0	Band 1 & 2: L/H Band 3: L/M/H
		802.11ac VHT80	MCS0	M
Frequency Stability		802.11a	6 Mbps	Band 1 & 3: L Band 2: H



Test Cases					
Radiated TCs	Test Items	Mode	Data Rate	Test Channel	
	Radiated Band Edge	802.11a	802.11a	6 Mbps	L/H
		802.11n HT20	802.11n HT20	MCS0	L/H
		802.11n HT40	802.11n HT40	MCS0	L/H
		802.11ac VHT20	802.11ac VHT20	MCS0	L/H
		802.11ac VHT40	802.11ac VHT40	MCS0	L/H
		802.11ac VHT80	802.11ac VHT80	MCS0	M
	Radiated Spurious Emission	802.11a	802.11a	6 Mbps	L/M/H
		802.11n HT20	802.11n HT20	MCS0	L/M/H
		802.11n HT40	802.11n HT40	MCS0	L/M/H
		802.11ac VHT20	802.11ac VHT20	MCS0	L/M/H
		802.11ac VHT40	802.11ac VHT40	MCS0	L/M/H
		802.11ac VHT80	802.11ac VHT80	MCS0	M
AC Conducted Emission	Mode 1: GSM850 Idle + Bluetooth Link + WLAN (5GHz) Link + Earphone + MP3 + Battery + USB Cable (Charging from Adapter)				

Ch. #		Band I : 5150-5250 MHz	Band II : 5250-5350 MHz	Band III : 5470-5600 MHz and 5650-5725MHz
		802.11a	802.11a	802.11a
L	Low	36	52	100
M	Middle	44	60	116
H	High	48	64	140

Ch. #		Band I : 5150-5250 MHz	Band II : 5250-5350 MHz	Band III : 5470-5600 MHz and 5650-5725MHz
		802.11n HT20	802.11n HT20	802.11n HT20
L	Low	36	52	100
M	Middle	44	60	116
H	High	48	64	140



Ch. #		Band I : 5150-5250 MHz	Band II : 5250-5350 MHz	Band III : 5470-5600 MHz and 5650-5725MHz
		802.11n HT40	802.11n HT40	802.11n HT40
L	Low	38	54	102
M	Middle	-	-	110
H	High	46	62	134

Ch. #		Band I : 5150-5250 MHz	Band II : 5250-5350 MHz	Band III : 5470-5600 MHz and 5650-5725MHz
		802.11ac VHT20	802.11ac VHT20	802.11ac VHT20
L	Low	36	52	100
M	Middle	44	60	116
H	High	48	64	140

Ch. #		Band I : 5150-5250 MHz	Band II : 5250-5350 MHz	Band III : 5470-5600 MHz and 5650-5725MHz
		802.11ac VHT40	802.11ac VHT40	802.11ac VHT40
L	Low	38	54	102
M	Middle	-	-	110
H	High	46	62	134

Ch. #		Band I : 5150-5250 MHz	Band II : 5250-5350 MHz	Band III : 5470-5600 MHz and 5650-5725MHz
		802.11ac VHT80	802.11ac VHT80	802.11ac VHT80
L	Low	-	-	-
M	Middle	42	58	106
H	High	-	-	-

2.4 Connection Diagram of Test System

<Radiated Emission Mode>

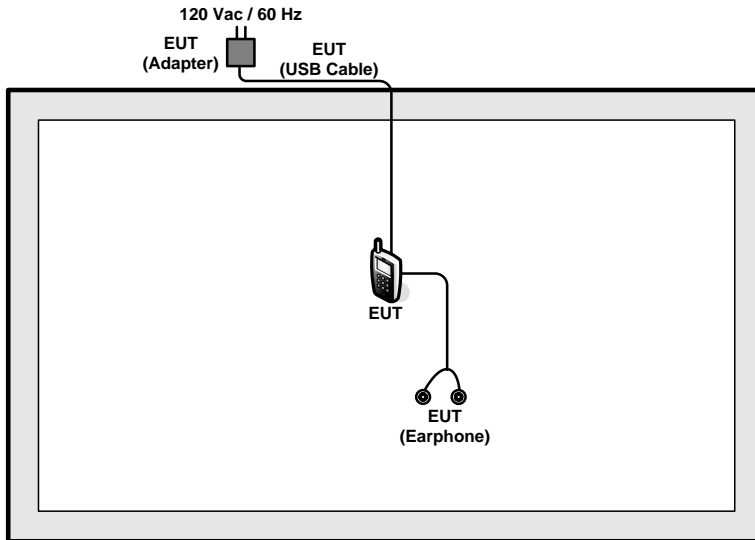

<AC Conducted Emission Mode>

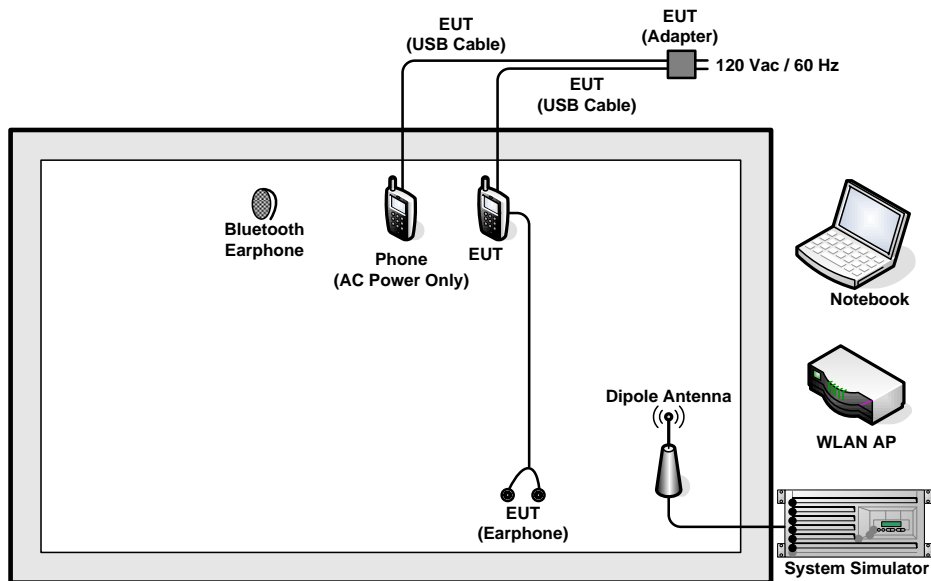



2.5 Support Unit used in test configuration and system

Item	Equipment	Trade Name	Model Name	FCC ID	Data Cable	Power Cord
1.	System Simulator	R&S	CMU 200	N/A	N/A	Unshielded, 1.8 m
2.	Bluetooth Earphone	Sony Ericsson	MW600	PY7DDA-2029	N/A	N/A
3.	WLAN AP	D-Link	DIR-628	KA2DIR628A2	N/A	Unshielded, 1.8 m
4.	Notebook	DELL	Latitude E6320	FCC DoC/ Contains FCC ID: QDS-BRCM1054	N/A	AC I/P: Unshielded, 1.2 m DC O/P: Shielded, 1.8 m
5.	SD Card	SanDisk	MicroSD HC	FCC DoC	N/A	N/A

2.6 EUT Operation Test Setup

For WLAN function, programmed RF utility, "QRCT" installed in the EUT provide functions like channel selection and power level for continuous transmitting and receiving signals.

2.7 Measurement Results Explanation Example

For all conducted test items:

The offset level is set in the spectrum analyzer to compensate the RF cable loss and attenuator factor between EUT conducted output port and spectrum analyzer. With the offset compensation, the spectrum analyzer reading level is exactly the EUT RF output level.

Example :

The spectrum analyzer offset is derived from RF cable loss and attenuator factor.

Offset = RF cable loss + attenuator factor.

Following shows an offset computation example with cable loss 4.2 dB and 10dB attenuator.

$$\begin{aligned} \text{Offset(dB)} &= \text{RF cable loss(dB)} + \text{attenuator factor(dB)}. \\ &= 4.2 + 10 = 14.2 \text{ (dB)} \end{aligned}$$

3 Test Result

3.1 26dB & 99% Occupied Bandwidth Measurement

3.1.1 Description of 26dB & 99% Occupied Bandwidth

This section is for reporting purpose only.

There is no restriction limits for bandwidth.

3.1.2 Measuring Instruments

The measuring equipment is listed in the section 4 of this test report.

3.1.3 Test Procedures

1. The testing follows FCC KDB 789033 D02 General UNII Test Procedures New Rules v01.
Section C) Emission bandwidth
2. Set RBW = approximately 1% of the emission bandwidth.
3. Set the VBW > RBW.
4. Detector = Peak.
5. Trace mode = max hold
6. Measure the maximum width of the emission that is 26 dB down from the peak of the emission.
Compare this with the RBW setting of the analyzer. Readjust RBW and repeat measurement as needed until the RBW/EBW ratio is approximately 1%.
7. For 99% Bandwidth Measurement, the spectrum analyzer's resolution bandwidth (RBW) is set 1MHz and set the Video bandwidth (VBW) $\geq 3 * RBW$.
8. Measure and record the results in the test report.

3.1.4 Test Setup

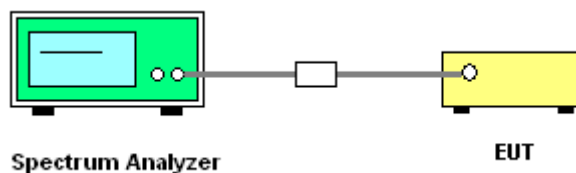



3.1.5 Test Result of 26dB & 99% Occupied Bandwidth Plots

Test Band :	5GHz band 1	Temperature :	21~26°C
Test Engineer :	Alex Lee	Relative Humidity :	45~54%

Mod.	Data Rate	N _{TX}	Channel	Freq. (MHz)	99% Bandwidth (MHz)		IC 99% Bandwidth EIRP Limit (dBm)	
11a	6Mbps	1	36	5180	18.10		22.58	
11a	6Mbps	1	44	5220	18.15		22.59	
11a	6Mbps	1	48	5240	18.10		22.58	
HT20	MCS0	1	36	5180	18.85		22.75	
HT20	MCS0	1	44	5220	19.00		22.79	
HT20	MCS0	1	48	5240	18.95		22.78	
HT40	MCS0	1	38	5190	36.40		23.01	
HT40	MCS0	1	46	5230	36.63		23.01	
VHT20	MCS0	1	36	5180	19.00		22.79	
VHT20	MCS0	1	44	5220	18.90		22.76	
VHT20	MCS0	1	48	5240	18.80		22.74	
VHT40	MCS0	1	38	5190	36.40		23.01	
VHT40	MCS0	1	46	5230	36.45		23.01	
VHT80	MCS0	1	42	5210	75.20		23.01	



Test Band :	5GHz band 2	Temperature :	21~26°C
Test Engineer :	Alex Lee	Relative Humidity :	45~54%

Mod.	Data Rate	N _{TX}	Channel	Freq. (MHz)	99% Bandwidth (MHz)	26dB Bandwidth (MHz)	IC 99% Bandwidth EIRP Limit (dBm)	FCC 26dB Bandwidth Power Limit (dBm)
11a	6Mbps	1	52	5260	18.15	22.15	29.59	23.98
11a	6Mbps	1	60	5300	17.95	22.05	29.54	23.98
11a	6Mbps	1	64	5320	18.00	22.00	29.55	23.98
HT20	MCS0	1	52	5260	18.85	22.60	29.75	23.98
HT20	MCS0	1	60	5300	18.85	22.40	29.75	23.98
HT20	MCS0	1	64	5320	19.00	22.45	29.79	23.98
HT40	MCS0	1	54	5270	36.45	45.18	30.00	23.98
HT40	MCS0	1	62	5310	36.54	44.91	30.00	23.98
VHT20	MCS0	1	52	5260	18.85	22.30	29.75	23.98
VHT20	MCS0	1	60	5300	18.95	22.55	29.78	23.98
VHT20	MCS0	1	64	5320	18.90	22.50	29.76	23.98
VHT40	MCS0	1	54	5270	36.45	44.91	30.00	23.98
VHT40	MCS0	1	62	5310	36.36	44.64	30.00	23.98
VHT80	MCS0	1	58	5290	75.04	84.80	30.00	23.98



Test Band :	5GHz band 3	Temperature :	21~26°C
Test Engineer :	Alex Lee	Relative Humidity :	45~54%

Mod.	Data Rate	N _{TX}	Channel	Freq. (MHz)	99% Bandwidth (MHz)	26dB Bandwidth (MHz)	IC 99% Bandwidth EIRP Limit (dBm)	FCC 26dB Bandwidth Power Limit (dBm)
11a	6Mbps	1	100	5500	18.05	22.20	29.56	23.98
11a	6Mbps	1	116	5580	18.05	22.30	29.56	23.98
11a	6Mbps	1	140	5700	18.05	22.55	29.56	23.98
HT20	MCS0	1	100	5500	18.95	22.60	29.78	23.98
HT20	MCS0	1	116	5580	18.90	22.55	29.76	23.98
HT20	MCS0	1	140	5700	18.80	22.60	29.74	23.98
HT40	MCS0	1	102	5510	36.54	45.27	30.00	23.98
HT40	MCS0	1	110	5550	36.54	44.91	30.00	23.98
HT40	MCS0	1	134	5670	36.45	45.09	30.00	23.98
VHT20	MCS0	1	100	5500	18.90	22.55	29.76	23.98
VHT20	MCS0	1	116	5580	18.95	22.45	29.78	23.98
VHT20	MCS0	1	140	5700	18.85	22.45	29.75	23.98
VHT40	MCS0	1	102	5510	36.63	44.64	30.00	23.98
VHT40	MCS0	1	110	5550	36.54	45.00	30.00	23.98
VHT40	MCS0	1	134	5670	36.54	45.18	30.00	23.98
VHT80	MCS0	1	106	5530	74.72	84.48	30.00	23.98

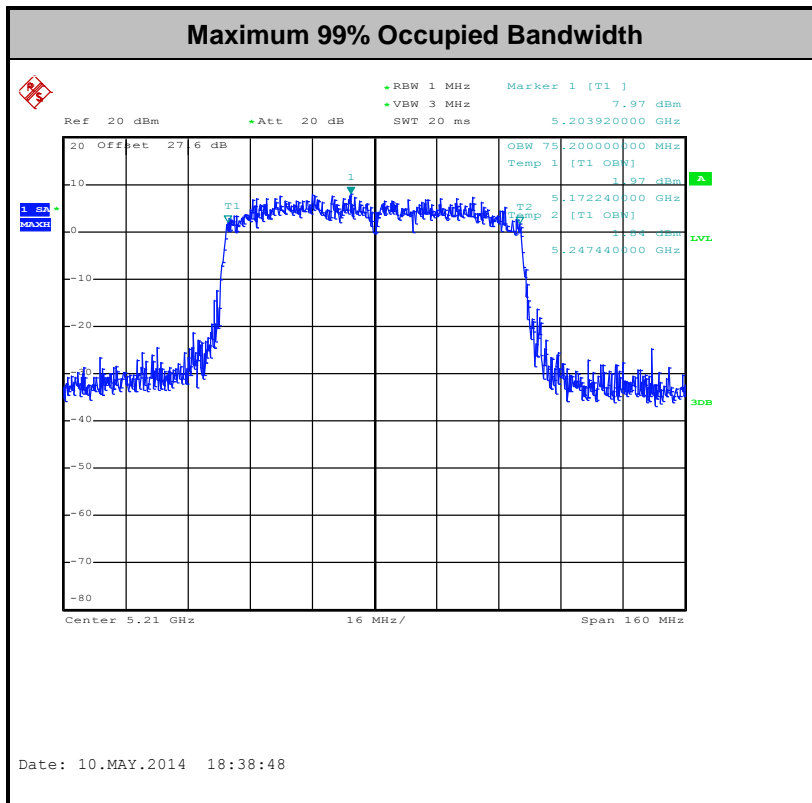
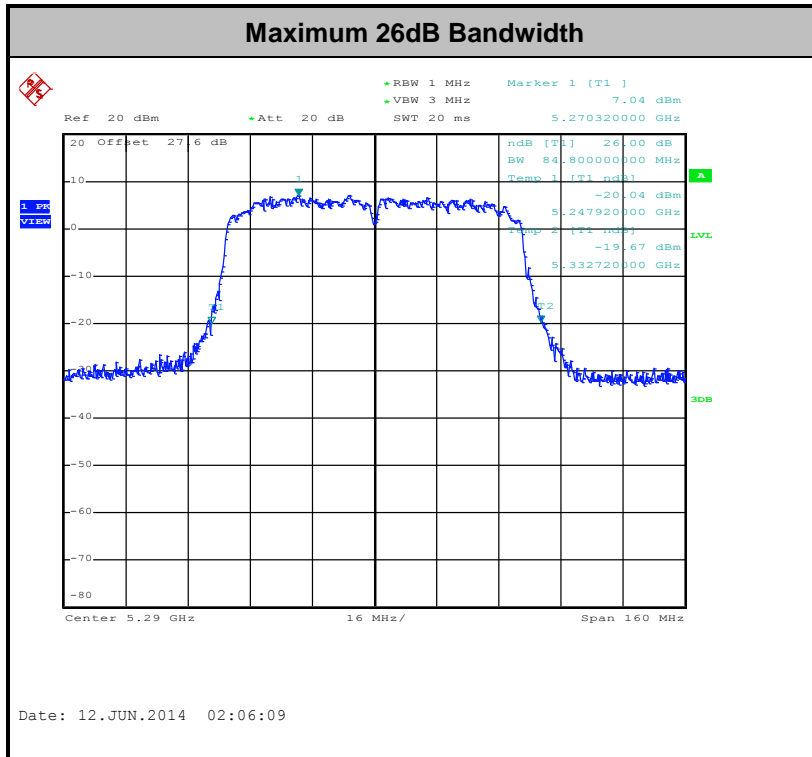

Note: The occupied channel bandwidth is maintained within the band of operation for all of the modulations.



3.1.6 Test Result of 20dB Occupied Bandwidth

Test Band :	5GHz band 1	Temperature :	21~26°C
Test Engineer :	Alex Lee	Relative Humidity :	45~54%

Mod.	Data Rate	N _{TX}	Channel	Freq. (MHz)	20dB Bandwidth (MHz)	20dB Bandwidth Upper Frequency (FH) (MHz)	Upper Limit Line (MHz)	Pass/Fail
11a	6Mbps	1	48	5240	19.80	5249.95	5250	Pass
HT20	MCS0	1	48	5240	20.15	5249.90		Pass
HT40	MCS0	1	46	5230	40.50	5249.98		Pass
VHT20	MCS0	1	48	5240	20.15	5249.90		Pass
VHT40	MCS0	1	46	5230	40.14	5249.98		Pass
VHT80	MCS0	1	42	5210	79.68	5249.84		Pass

Test Band :	5GHz band 2	Temperature :	21~26°C
Test Engineer :	Alex Lee	Relative Humidity :	45~54%

Mod.	Data Rate	N _{TX}	Channel	Freq. (MHz)	20dB Bandwidth (MHz)	20dB Bandwidth Lower Frequency (FL) (MHz)	Low Limit Line (MHz)	Pass/Fail
11a	6Mbps	1	52	5260	19.39	5250.38	5250	Pass
HT20	MCS0	1	52	5260	19.87	5250.06		Pass
HT40	MCS0	1	54	5270	39.95	5250.10		Pass
VHT20	MCS0	1	52	5260	19.79	5250.06		Pass
VHT40	MCS0	1	54	5270	39.38	5250.24		Pass
VHT80	MCS0	1	58	5290	80.51	5250.00		Pass



Test Band :	5GHz band 3	Temperature :	21~26°C
Test Engineer :	Alex Lee	Relative Humidity :	45~54%

Mod.	Data Rate	NTX	Channel	Freq. (MHz)	20dB Bandwidth (MHz)	20dB Bandwidth Lower Frequency (FL) (MHz)	Low Limit Line (MHz)	Pass/Fail
11a	6Mbps	1	132	5660	19.63	5650.06	5650	Pass
HT20	MCS0	1	132	5660	20.03	5650.06		Pass
HT40	MCS0	1	134	5670	39.95	5650.10		Pass
VHT20	MCS0	1	132	5660	19.79	5650.14		Pass
VHT40	MCS0	1	134	5670	39.38	5650.24		Pass

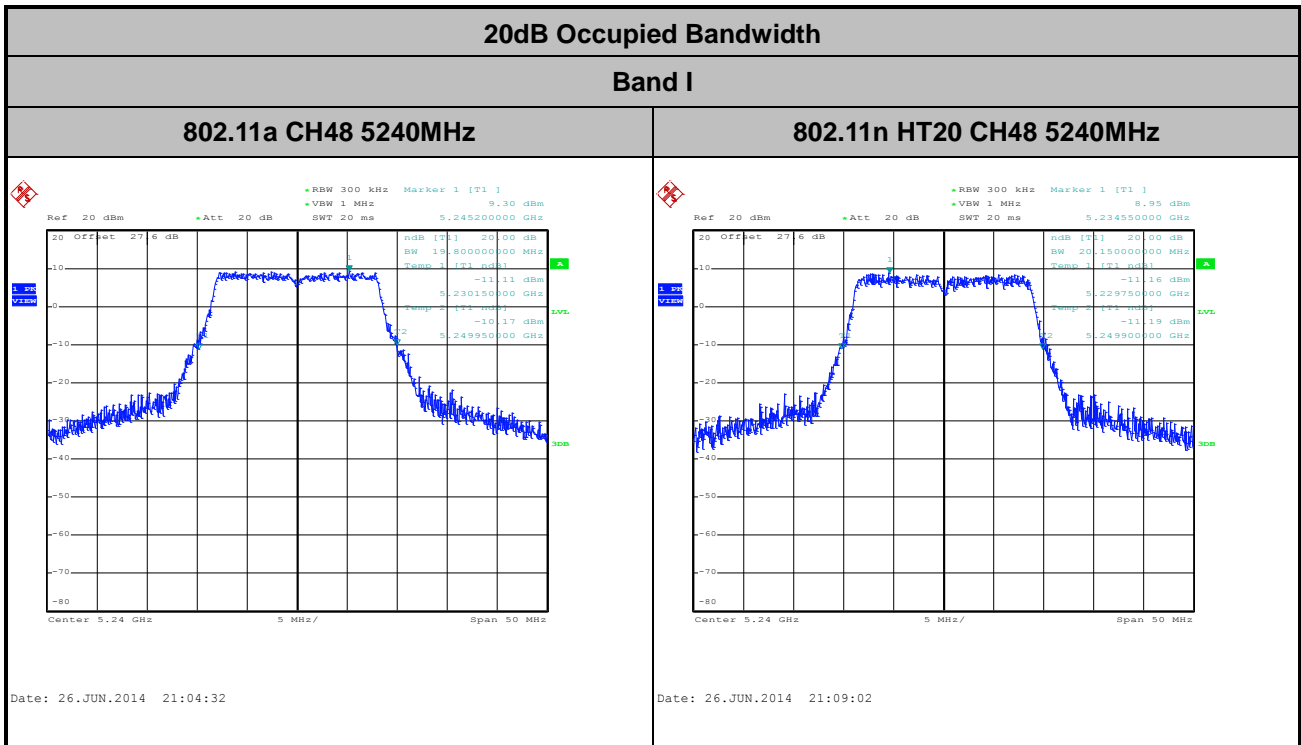



20dB Occupied Bandwidth

Band I

802.11n HT40 CH46 5230MHz

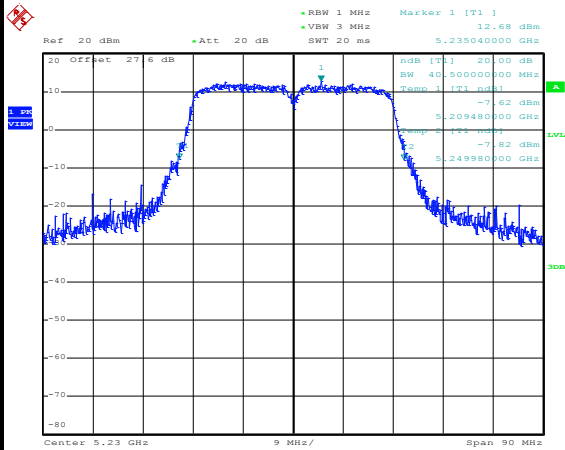

Date: 26.JUN.2014 21:17:09

802.11ac VHT20 CH48 5240MHz

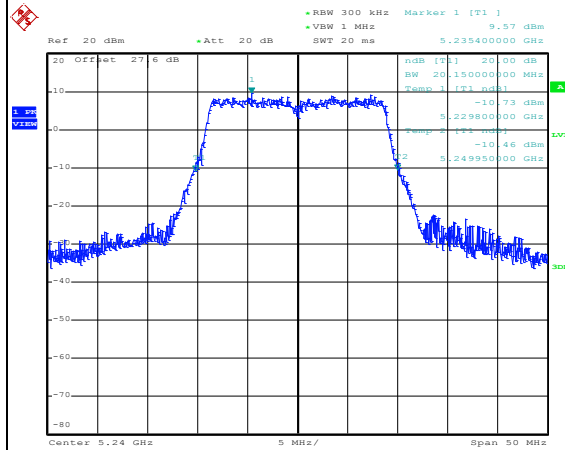

Date: 26.JUN.2014 21:25:19

802.11ac VHT40 CH46 5230MHz

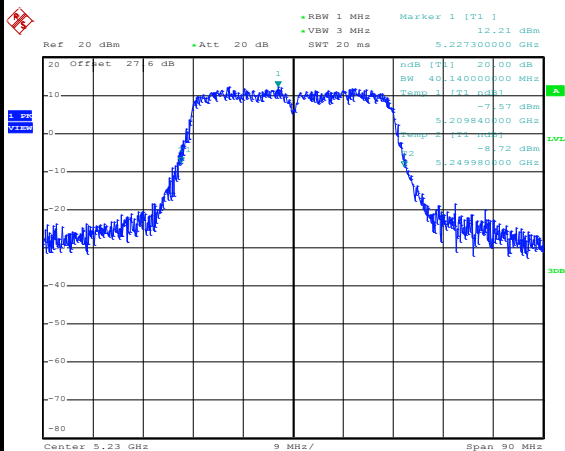

Date: 26.JUN.2014 21:34:46

802.11ac VHT80 CH42 5210MHz

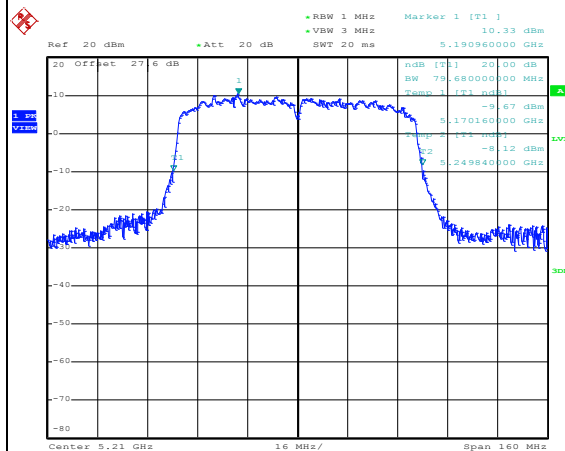

Date: 26.JUN.2014 21:40:11



20dB Occupied Bandwidth

Band II

802.11ac VHT40 CH54 5270MHz

802.11ac VHT80 CH58 5290MHz

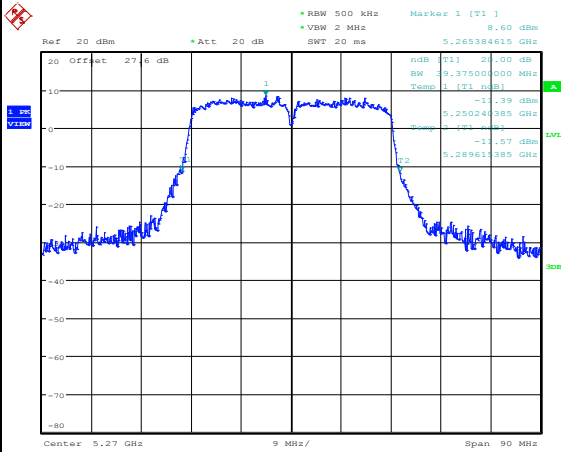

Date: 11.MAY.2014 07:15:53

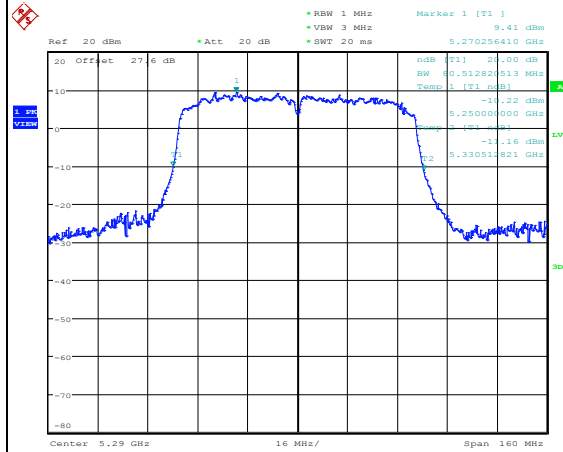

Date: 11.MAY.2014 07:20:01



20dB Occupied Bandwidth

Band III

802.11a CH132 5660MHz

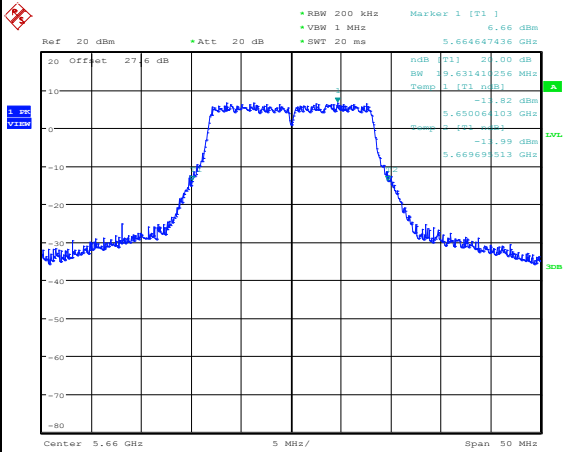

Date: 11.MAY.2014 07:25:08

802.11n HT20 CH132 5660MHz

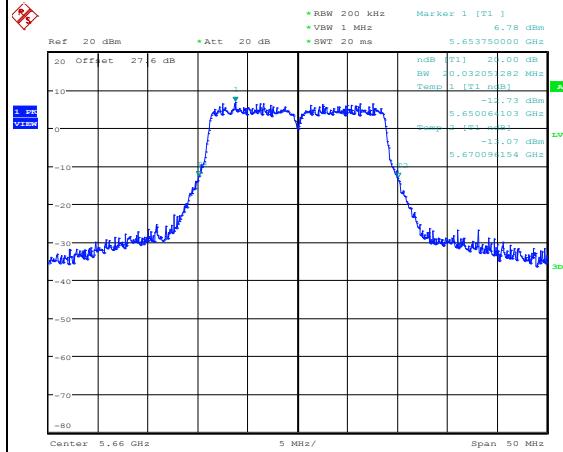

Date: 11.MAY.2014 07:25:59

802.11n HT40 CH134 5670MHz

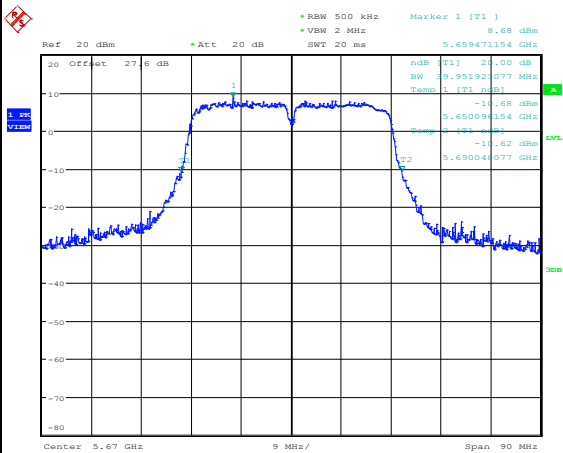

Date: 11.MAY.2014 07:10:06

802.11ac VHT20 CH132 5660MHz

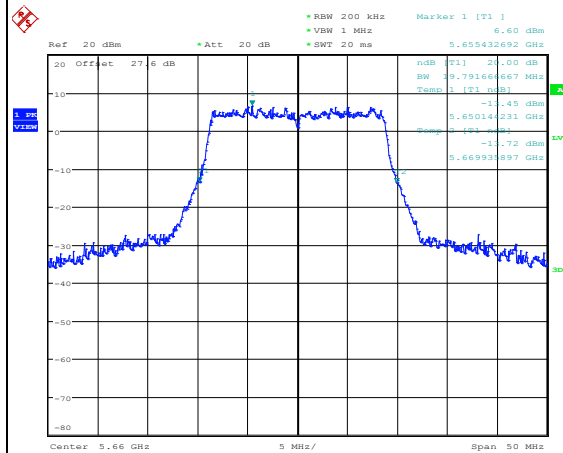

Date: 11.MAY.2014 07:30:35

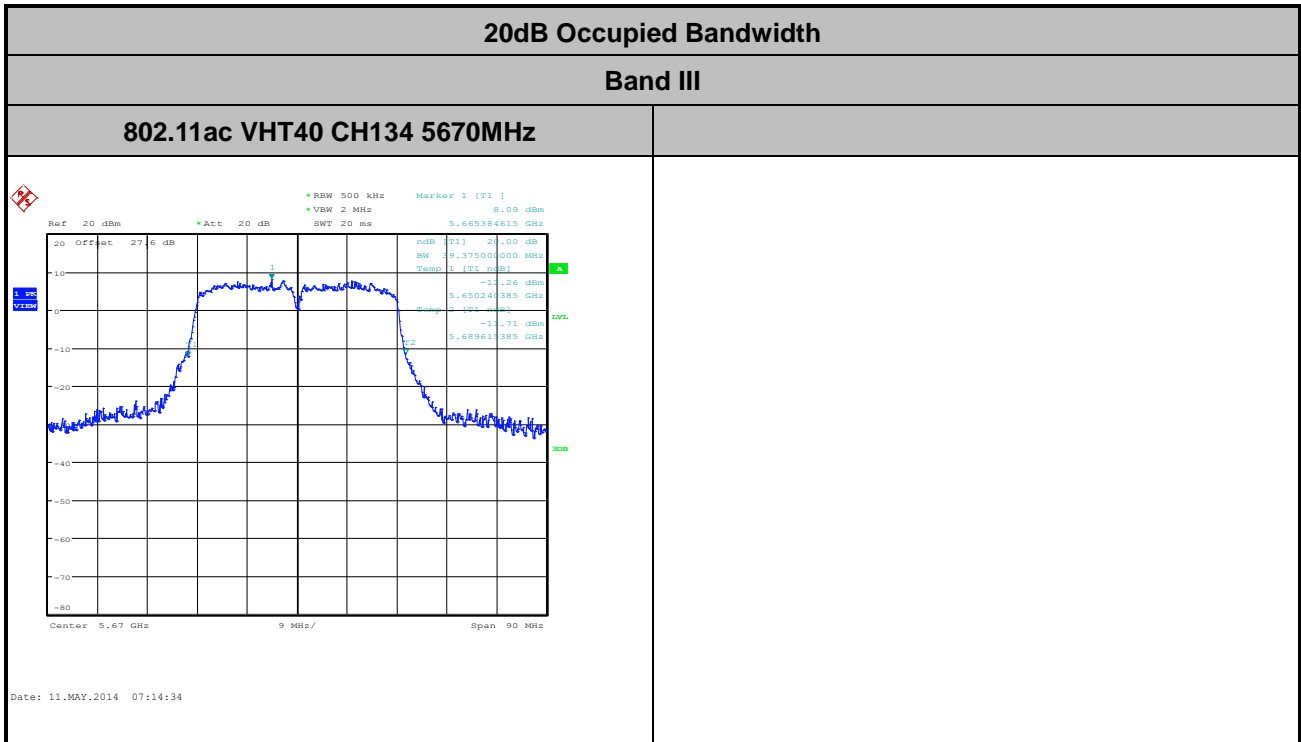



3.2 Maximum Conducted Output Power Measurement

3.2.1 Limit of Maximum Conducted Output Power

<FCC 14-30 CFR 15.407>

For mobile and portable client devices in the 5.15–5.25 GHz band, the maximum conducted output power over the frequency band of operation shall not exceed 250 mW.

For the 5.25–5.35 GHz and 5.47–5.725 GHz bands, the maximum conducted output power over the frequency bands of operation shall not exceed the lesser of 250 mW or $11 \text{ dBm} + 10 \log B$, where B is the 26 dB emission bandwidth in megahertz.

If transmitting antennas of directional gain greater than 6 dBi are used, the peak output power shall be reduced by the amount in dB that the directional gain of the antenna exceeds 6 dBi.

Note that U-NII-2 band, devices with a maximum e.i.r.p. greater than 500 mW shall implement TPC in order to have the capability to operate at least 6 dB below the maximum permitted e.i.r.p. of 1 W.

3.2.2 Measuring Instruments

The measuring equipment is listed in the section 4 of this test report.

3.2.3 Test Procedures

The testing follows Method PM of FCC KDB 789033 D02 General UNII Test Procedures New Rules v01.

Method PM (Measurement using an RF average power meter):

1. Measurement is performed using a wideband RF power meter.
2. The EUT is configured to transmit continuously with a consistent duty cycle at its maximum power control level.
3. Measure the average power of the transmitter, and the average power is corrected with duty factor, $10 \log(1/x)$, where x is the duty cycle.

3.2.4 Test Setup

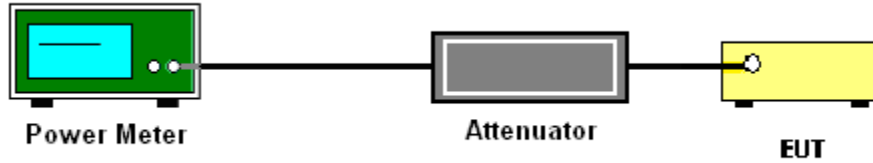

3.2.5 Test Result of Maximum Conducted Output Power

Test Band :	5GHz band 1	Temperature :	21~26°C
Test Engineer :	Alex Lee	Relative Humidity :	45~54%

Mod.	Data Rate	N _{TX}	Channel	Freq. (MHz)	Duty Factor (dB)	Average Conducted Power (dBm)	FCC Conducted Power Limit (dBm)	DG (dBi)	-	Pass/Fail
11a	6Mbps	1	36	5180	0.59	17.49	24.00	1.20		Pass
11a	6Mbps	1	44	5220	0.59	17.22	24.00	1.20		Pass
11a	6Mbps	1	48	5240	0.59	17.26	24.00	1.20		Pass
HT20	MCS0	1	36	5180	0.63	17.54	24.00	1.20		Pass
HT20	MCS0	1	44	5220	0.63	17.34	24.00	1.20		Pass
HT20	MCS0	1	48	5240	0.63	17.28	24.00	1.20		Pass
HT40	MCS0	1	38	5190	1.17	13.89	24.00	1.20		Pass
HT40	MCS0	1	46	5230	1.17	17.63	24.00	1.20		Pass
VHT20	MCS0	1	36	5180	0.80	17.56	24.00	1.20		Pass
VHT20	MCS0	1	44	5220	0.80	17.26	24.00	1.20		Pass
VHT20	MCS0	1	48	5240	0.80	17.36	24.00	1.20		Pass
VHT40	MCS0	1	38	5190	1.47	15.16	24.00	1.20		Pass
VHT40	MCS0	1	46	5230	1.47	17.17	24.00	1.20		Pass
VHT80	MCS0	1	42	5210	2.55	17.60	24.00	1.20		Pass



Mod.	Data Rate	N _{TX}	Channel	Freq. (MHz)	Duty Factor (dB)	Average Conducted Power (dBm)	IC Conducted Power Limit (dBm)	DG (dBi)	EIRP Power Limit (dBm)	Pass/Fail
11a	6Mbps	1	36	5180	0.59	17.49	21.38	1.20	22.58	Pass
11a	6Mbps	1	44	5220	0.59	17.22	21.39	1.20	22.59	Pass
11a	6Mbps	1	48	5240	0.59	17.26	21.38	1.20	22.58	Pass
HT20	MCS0	1	36	5180	0.63	17.54	21.55	1.20	22.75	Pass
HT20	MCS0	1	44	5220	0.63	17.34	21.59	1.20	22.79	Pass
HT20	MCS0	1	48	5240	0.63	17.28	21.58	1.20	22.78	Pass
HT40	MCS0	1	38	5190	1.17	13.89	21.81	1.20	23.01	Pass
HT40	MCS0	1	46	5230	1.17	17.63	21.81	1.20	23.01	Pass
VHT20	MCS0	1	36	5180	0.80	17.56	21.59	1.20	22.79	Pass
VHT20	MCS0	1	44	5220	0.80	17.26	21.56	1.20	22.76	Pass
VHT20	MCS0	1	48	5240	0.80	17.36	21.54	1.20	22.74	Pass
VHT40	MCS0	1	38	5190	1.47	15.16	21.81	1.20	23.01	Pass
VHT40	MCS0	1	46	5230	1.47	17.17	21.81	1.20	23.01	Pass
VHT80	MCS0	1	42	5210	2.55	17.60	21.81	1.20	23.01	Pass

Note:

1. Final Output Power equals to Measured Output Power adds the duty factor.
2. For the band 5150-5250 MHz, the maximum average conducted output power shall not exceed 24dBm for client device for FCC.
3. For the band 5150-5250 MHz, the maximum average EIRP output power shall not exceed lesser of 200 mW (23dBm) or 10 dBm + 10log (B), where B is 99%OBW for IC.



Test Band :	5GHz band 2	Temperature :	21~26°C
Test Engineer :	Alex Lee	Relative Humidity :	45~54%

Mod.	Data Rate	N _{TX}	Channel	Freq. (MHz)	Duty Factor (dB)	Average Conducted Power (dBm)	FCC Conducted Power Limit (dBm)	DG (dBi)		Pass/Fail
11a	6Mbps	1	52	5260	0.59	16.89	23.98	1.20	-	Pass
11a	6Mbps	1	60	5300	0.59	16.98	23.98	1.20		Pass
11a	6Mbps	1	64	5320	0.59	16.93	23.98	1.20		Pass
HT20	MCS0	1	52	5260	0.63	16.93	23.98	1.20		Pass
HT20	MCS0	1	60	5300	0.63	16.79	23.98	1.20		Pass
HT20	MCS0	1	64	5320	0.63	16.77	23.98	1.20		Pass
HT40	MCS0	1	54	5270	1.17	16.91	23.98	1.20		Pass
HT40	MCS0	1	62	5310	1.17	14.71	23.98	1.20		Pass
VHT20	MCS0	1	52	5260	0.80	16.93	23.98	1.20		Pass
VHT20	MCS0	1	60	5300	0.80	16.99	23.98	1.20		Pass
VHT20	MCS0	1	64	5320	0.80	16.86	23.98	1.20		Pass
VHT40	MCS0	1	54	5270	1.47	16.94	23.98	1.20		Pass
VHT40	MCS0	1	62	5310	1.47	14.58	23.98	1.20		Pass
VHT80	MCS0	1	58	5290	2.55	15.04	23.98	1.20		Pass



Mod.	Data Rate	N _{TX}	Channel	Freq. (MHz)	Duty Factor (dB)	Average Conducted Power (dBm)	IC Conducted Power Limit (dBm)	DG (dBi)	EIRP Power Limit (dBm)	Pass/Fail
11a	6Mbps	1	52	5260	0.59	16.89	23.59	1.20	29.59	Pass
11a	6Mbps	1	60	5300	0.59	16.98	23.54	1.20	29.54	Pass
11a	6Mbps	1	64	5320	0.59	16.93	23.55	1.20	29.55	Pass
HT20	MCS0	1	52	5260	0.63	16.93	23.75	1.20	29.75	Pass
HT20	MCS0	1	60	5300	0.63	16.79	23.75	1.20	29.75	Pass
HT20	MCS0	1	64	5320	0.63	16.77	23.79	1.20	29.79	Pass
HT40	MCS0	1	54	5270	1.17	16.91	23.98	1.20	30.00	Pass
HT40	MCS0	1	62	5310	1.17	14.71	23.98	1.20	30.00	Pass
VHT20	MCS0	1	52	5260	0.80	16.93	23.75	1.20	29.75	Pass
VHT20	MCS0	1	60	5300	0.80	16.99	23.78	1.20	29.78	Pass
VHT20	MCS0	1	64	5320	0.80	16.86	23.76	1.20	29.76	Pass
VHT40	MCS0	1	54	5270	1.47	16.94	23.98	1.20	30.00	Pass
VHT40	MCS0	1	62	5310	1.47	14.58	23.98	1.20	30.00	Pass
VHT80	MCS0	1	58	5290	2.55	15.04	23.98	1.20	30.00	Pass

Note:

1. Final Output Power equals to Measured Output Power adds the duty factor.
2. For the 5250-5350 MHz and 5470-5600 MHz and 5650-5725 MHz bands, the maximum conducted output power shall not exceed the lesser of 250 mW (24dBm) or 11 dBm + 10log (B), where B is 26dB BW for FCC and 99% OBW for IC.



Test Band :	5GHz band 3	Temperature :	21~26°C
Test Engineer :	Alex Lee	Relative Humidity :	45~54%

Mod.	Data Rate	N _{TX}	Channel	Freq. (MHz)	Duty Factor (dB)	Average Conducted Power (dBm)	FCC Conducted Power Limit (dBm)	DG (dBi)	Pass/Fail
11a	6Mbps	1	100	5500	0.59	17.28	23.98	1.40	Pass
11a	6Mbps	1	116	5580	0.59	17.36	23.98	1.40	Pass
11a	6Mbps	1	140	5700	0.59	14.47	23.98	1.40	Pass
HT20	MCS0	1	100	5500	0.63	16.28	23.98	1.40	Pass
HT20	MCS0	1	116	5580	0.63	17.07	23.98	1.40	Pass
HT20	MCS0	1	140	5700	0.63	13.77	23.98	1.40	Pass
HT40	MCS0	1	102	5510	1.17	14.74	23.98	1.40	Pass
HT40	MCS0	1	110	5550	1.17	17.21	23.98	1.40	Pass
HT40	MCS0	1	134	5670	1.17	16.85	23.98	1.40	Pass
VHT20	MCS0	1	100	5500	0.80	17.23	23.98	1.40	Pass
VHT20	MCS0	1	116	5580	0.80	17.19	23.98	1.40	Pass
VHT20	MCS0	1	140	5700	0.80	14.60	23.98	1.40	Pass
VHT40	MCS0	1	102	5510	1.47	15.16	23.98	1.40	Pass
VHT40	MCS0	1	110	5550	1.47	17.07	23.98	1.40	Pass
VHT40	MCS0	1	134	5670	1.47	16.67	23.98	1.40	Pass
VHT80	MCS0	1	106	5530	2.55	14.22	23.98	1.40	Pass



Mod.	Data Rate	N _{TX}	Channel	Freq. (MHz)	Duty Factor (dB)	Average Conducted Power (dBm)	IC Conducted Power Limit (dBm)	DG (dBi)	EIRP Power Limit (dBm)	Pass/Fail
11a	6Mbps	1	100	5500	0.59	17.28	23.56	1.40	29.56	Pass
11a	6Mbps	1	116	5580	0.59	17.36	23.56	1.40	29.56	Pass
11a	6Mbps	1	140	5700	0.59	14.47	23.54	1.40	29.54	Pass
HT20	MCS0	1	100	5500	0.63	16.28	23.75	1.40	29.75	Pass
HT20	MCS0	1	116	5580	0.63	17.07	23.76	1.40	29.76	Pass
HT20	MCS0	1	140	5700	0.63	13.77	23.75	1.40	29.75	Pass
HT40	MCS0	1	102	5510	1.17	14.74	23.98	1.40	30.00	Pass
HT40	MCS0	1	110	5550	1.17	17.21	23.98	1.40	30.00	Pass
HT40	MCS0	1	134	5670	1.17	16.85	23.98	1.40	30.00	Pass
VHT20	MCS0	1	100	5500	0.80	17.23	23.76	1.40	29.76	Pass
VHT20	MCS0	1	116	5580	0.80	17.19	23.78	1.40	29.78	Pass
VHT20	MCS0	1	140	5700	0.80	14.60	23.78	1.40	29.78	Pass
VHT40	MCS0	1	102	5510	1.47	15.16	23.98	1.40	30.00	Pass
VHT40	MCS0	1	110	5550	1.47	17.07	23.98	1.40	30.00	Pass
VHT40	MCS0	1	134	5670	1.47	16.67	23.98	1.40	30.00	Pass
VHT80	MCS0	1	106	5530	2.55	14.22	23.98	1.40	30.00	Pass

Note:

1. Final Output Power equals to Measured Output Power adds the duty factor.
2. For the 5250-5350 MHz and 5470-5600 MHz and 5650-5725 MHz bands, the maximum conducted output power shall not exceed the lesser of 250 mW (24dBm) or 11 dBm + 10log (B), where B is 26dB BW for FCC and 99% OBW for IC.



3.3 Power Spectral Density Measurement

3.3.1 Limit of Power Spectral Density

<FCC 14-30 CFR 15.407>

For mobile and portable client devices in the 5.15–5.25 GHz band, the maximum power spectral density shall not exceed 11dBm in any 1 megahertz band.

For the 5.25–5.35 GHz and 5.47–5.725 GHz bands, the maximum power spectral density shall not exceed 11 dBm in any 1 megahertz band.

If transmitting antennas of directional gain greater than 6 dBi are used, the peak output power shall be reduced by the amount in dB that the directional gain of the antenna exceeds 6 dBi.

3.3.2 Measuring Instruments

The measuring equipment is listed in the section 4 of this test report.

3.3.3 Test Procedures

The testing follows FCC KDB 789033 D02 General UNII Test Procedures New Rules v01.

Section F) Maximum power spectral density.

Method SA-2

(trace averaging across on and off times of the EUT transmissions, followed by duty cycle correction).

1. The testing follows Method SA-2 of FCC KDB 789033 D02 General UNII Test Procedures New Rules v01.
 - Measure the duty cycle.
 - Set span to encompass the entire emission bandwidth (EBW) of the signal.
 - Set RBW = 1 MHz.
 - Set VBW \geq 3 MHz.
 - Number of points in sweep \geq 2 Span / RBW.
 - Sweep time = auto.
 - Detector = RMS
 - Trace average at least 100 traces in power averaging mode.
 - Add $10 \log(1/x)$, where x is the duty cycle, to the measured power in order to compute the average power during the actual transmission times. For example, add $10 \log(1/0.25) = 6$ dB if the duty cycle is 25 percent.
2. The RF output of EUT was connected to the spectrum analyzer by a low loss cable.
3. Each plot has already offset with cable loss, and attenuator loss. Measure the PPSD and record it.



Test Band :	5GHz band 1 (IC)	Temperature :	21~26°C
Test Engineer :	Alex Lee	Relative Humidity :	45~54%

Mod.	Data Rate	N _{TX}	CH	Freq. (MHz)	Duty Factor (dB)	Average Power Density (dBm/MHz)	Average PSD Limit (dBm)	DG (dBi)	EIRP PSD Limit (dBm)	Pass/Fail
11a	6Mbps	1	36	5180	0.59	6.68	4.00	1.20	10	Pass
11a	6Mbps	1	44	5220	0.59	6.78	4.00	1.20	10	Pass
11a	6Mbps	1	48	5240	0.59	6.72	4.00	1.20	10	Pass
HT20	MCS0	1	36	5180	0.63	6.54	4.00	1.20	10	Pass
HT20	MCS0	1	44	5220	0.63	6.56	4.00	1.20	10	Pass
HT20	MCS0	1	48	5240	0.63	6.35	4.00	1.20	10	Pass
HT40	MCS0	1	38	5190	1.17	-0.62	4.00	1.20	10	Pass
HT40	MCS0	1	46	5230	1.17	2.70	4.00	1.20	10	Pass
VHT20	MCS0	1	36	5180	0.80	6.49	4.00	1.20	10	Pass
VHT20	MCS0	1	44	5220	0.80	6.61	4.00	1.20	10	Pass
VHT20	MCS0	1	48	5240	0.80	6.35	4.00	1.20	10	Pass
VHT40	MCS0	1	38	5190	1.47	0.67	4.00	1.20	10	Pass
VHT40	MCS0	1	46	5230	1.47	2.77	4.00	1.20	10	Pass
VHT80	MCS0	1	42	5210	2.55	0.83	4.00	1.20	10	Pass



Test Band :	5GHz band 2	Temperature :	21~26°C
Test Engineer :	Alex Lee	Relative Humidity :	45~54%

Mod.	Data Rate	N _{TX}	CH	Freq. (MHz)	Duty Factor (dB)	Average Power Density (dBm/MHz)	Average PSD Limit (dBm)	DG (dBi)	Pass/Fail
11a	6Mbps	1	52	5260	0.59	5.90	11.00	1.20	Pass
11a	6Mbps	1	60	5300	0.59	6.03	11.00	1.20	Pass
11a	6Mbps	1	64	5320	0.59	5.92	11.00	1.20	Pass
HT20	MCS0	1	52	5260	0.63	5.60	11.00	1.20	Pass
HT20	MCS0	1	60	5300	0.63	5.68	11.00	1.20	Pass
HT20	MCS0	1	64	5320	0.63	5.79	11.00	1.20	Pass
HT40	MCS0	1	54	5270	1.17	2.58	11.00	1.20	Pass
HT40	MCS0	1	62	5310	1.17	1.11	11.00	1.20	Pass
VHT20	MCS0	1	52	5260	0.80	5.66	11.00	1.20	Pass
VHT20	MCS0	1	60	5300	0.80	5.72	11.00	1.20	Pass
VHT20	MCS0	1	64	5320	0.80	5.62	11.00	1.20	Pass
VHT40	MCS0	1	54	5270	1.47	2.99	11.00	1.20	Pass
VHT40	MCS0	1	62	5310	1.47	1.35	11.00	1.20	Pass
VHT80	MCS0	1	58	5290	2.55	-1.46	11.00	1.20	Pass



Test Band :	5GHz band 3	Temperature :	21~26°C
Test Engineer :	Alex Lee	Relative Humidity :	45~54%

Mod.	Data Rate	N _{TX}	CH	Freq. (MHz)	Duty Factor (dB)	Average Power Density (dBm/MHz)	Average PSD Limit (dBm)	DG (dBi)	Pass/Fail
11a	6Mbps	1	100	5500	0.59	6.37	11.00	1.40	Pass
11a	6Mbps	1	116	5580	0.59	6.03	11.00	1.40	Pass
11a	6Mbps	1	140	5700	0.59	4.17	11.00	1.40	Pass
HT20	MCS0	1	100	5500	0.63	5.55	11.00	1.40	Pass
HT20	MCS0	1	116	5580	0.63	5.52	11.00	1.40	Pass
HT20	MCS0	1	140	5700	0.63	3.41	11.00	1.40	Pass
HT40	MCS0	1	102	5510	1.17	1.17	11.00	1.40	Pass
HT40	MCS0	1	110	5550	1.17	4.04	11.00	1.40	Pass
HT40	MCS0	1	134	5670	1.17	2.24	11.00	1.40	Pass
VHT20	MCS0	1	100	5500	0.80	5.95	11.00	1.40	Pass
VHT20	MCS0	1	116	5580	0.80	5.61	11.00	1.40	Pass
VHT20	MCS0	1	140	5700	0.80	3.80	11.00	1.40	Pass
VHT40	MCS0	1	102	5510	1.47	1.68	11.00	1.40	Pass
VHT40	MCS0	1	110	5550	1.47	4.48	11.00	1.40	Pass
VHT40	MCS0	1	134	5670	1.47	2.24	11.00	1.40	Pass
VHT80	MCS0	1	106	5530	2.55	-1.97	11.00	1.40	Pass

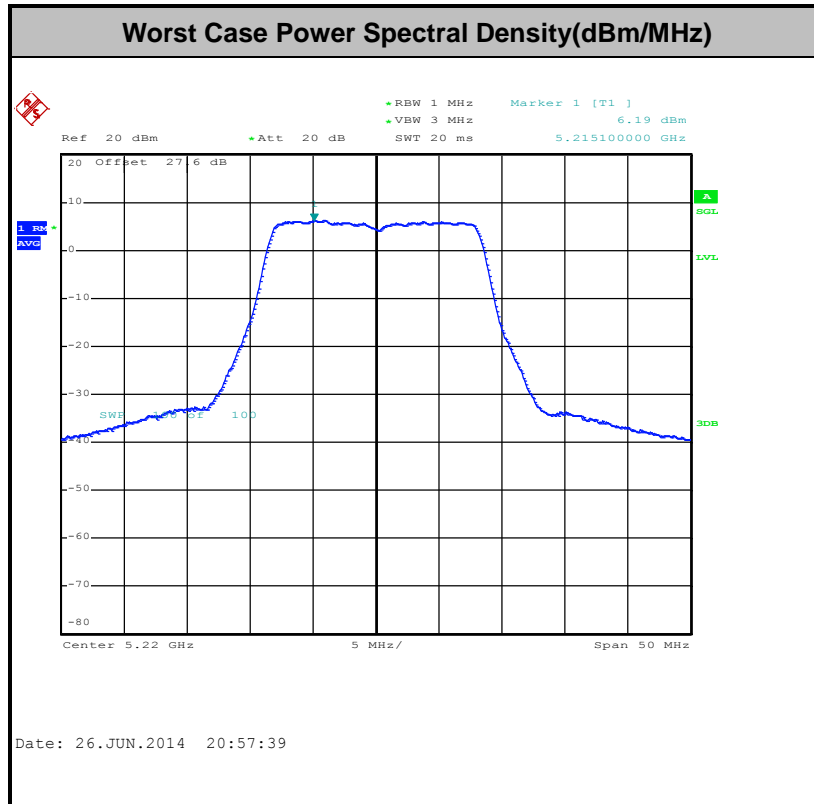

Note: Average Power Density (dB) = Measured value+ Duty Factor



3.4 Unwanted Radiated Emission Measurement

This section as specified in FCC Part 15.407(b) is to measure unwanted emissions through radiated measurement for band edge spurious emissions and out of band emissions measurement. The unwanted emissions shall comply with 15.407(b)(1) to (6), and restricted bands per FCC Part15.205.

3.4.1 Limit of Unwanted Emissions

(1) For transmitters operating in the 5150-5250 MHz band: all emissions outside of the 5150-5350 MHz band shall not exceed an EIRP of -27dBm/MHz.

For transmitters operating in the 5250-5350 MHz band: all emissions outside of the 5150-5350 MHz band shall not exceed an EIRP of -27 dBm/MHz. Devices operating in the 5250-5350 MHz band that generate emissions in the 5150-5250 MHz band must meet all applicable technical requirements for operation in the 5150-5250 MHz band (including indoor use) or alternatively meet an out-of-band emission EIRP limit of -27 dBm/MHz in the 5150-5250 MHz band.

For transmitters operating in the 5470-5600 MHz and 5650-5725MHz band: all emissions outside of the 5470-5600 MHz and 5650-5725MHz band shall not exceed an EIRP of -27 dBm/MHz.

(2) Unwanted spurious emissions fallen in restricted bands per FCC Part15.205 shall comply with the general field strength limits set forth in § 15.209 as below table,

Frequency (MHz)	Field Strength (microvolts/meter)	Measurement Distance (meters)
0.009 – 0.490	2400/F(kHz)	300
0.490 – 1.705	24000/F(kHz)	30
1.705 – 30.0	30	30
30 – 88	100	3
88 – 216	150	3
216 - 960	200	3
Above 960	500	3

Note: The following formula is used to convert the EIRP to field strength.

$$E = \frac{1000000\sqrt{30P}}{3} \mu\text{V/m, where P is the eirp (Watts)}$$

EIRP (dBm)	Field Strength at 3m (dBμV/m)
-17	78.3
- 27	68.3



- (3) KDB789033 v01 G)2)c) As specified in 15.407(b), emissions above 1000 MHz that are outside of the restricted bands are subject to a peak emission limit of -27 dBm/MHz (or -17 dBm/MHz as specified in 15.407(b)(4)). However, an out-of-band emission that complies with both the average and peak limits of 15.209 is not required to satisfy the -27 dBm/MHz or -17 dBm/MHz peak emission limit.

3.4.2 Measuring Instruments

The measuring equipment is listed in the section 4 of this test report.

3.4.3 Test Procedures

1. The testing follows FCC KDB 789033 D02 General UNII Test Procedures New Rules v01.

Section G) Unwanted emissions measurement.

(1) Procedure for Unwanted Emissions Measurements Below 1000MHz

- RBW = 120 kHz
- VBW = 300 kHz
- Detector = Peak
- Trace mode = max hold

(2) Procedure for Peak Unwanted Emissions Measurements Above 1000 MHz

- RBW = 1 MHz
- VBW \geq 3 MHz
- Detector = Peak
- Sweep time = auto
- Trace mode = max hold

(3) Procedures for Average Unwanted Emissions Measurements Above 1000MHz

- RBW = 1 MHz
- VBW = 10 Hz, when duty cycle is no less than 98 percent.
- VBW \geq 1/T, when duty cycle is less than 98 percent where T is the minimum transmission duration over which the transmitter is on and is transmitting at its maximum power control level for the tested mode of operation.



Band	Duty Cycle(%)	T(μs)	1/T(kHz)	VBW Setting
802.11a	87.18	1360.00	0.74	1kHz
802.11n HT20	86.49	1280.00	0.78	1kHz
802.11n HT40	76.43	642.00	1.56	3kHz
802.11n VHT20	82.99	976.00	1.02	3kHz
802.11n VHT40	71.26	496.00	2.02	3kHz
802.11n VHT80	54.63	248.00	4.03	5kHz

2. The EUT was placed on a rotatable table top 0.8 meter above ground.
3. The EUT was set 3 meters from the interference receiving antenna which was mounted on the top of a variable height antenna tower.
4. The antenna is a broadband antenna and its height is adjusted between one meter and four meters above ground to find the maximum value of the field strength for both horizontal polarization and vertical polarization of the antenna.
5. For each suspected emission, the EUT was arranged to its worst case and then adjust the antenna tower (from 1 m to 4 m) and turntable (from 0 degree to 360 degrees) to find the maximum reading.
6. For testing below 1GHz, if the emission level of the EUT in peak mode was 3 dB lower than the limit specified, then peak values of EUT will be reported, otherwise, the emissions will be repeated one by one using the CISPR quasi-peak method and reported.
7. For testing above 1GHz, the emission level of the EUT in peak mode was 20dB lower than average limit (that means the emission level in average mode also complies with the limit in average mode), then peak values of EUT will be reported, otherwise, the emissions will be measured in average mode again and reported.

3.4.4 Test Setup

For radiated emissions below 30MHz

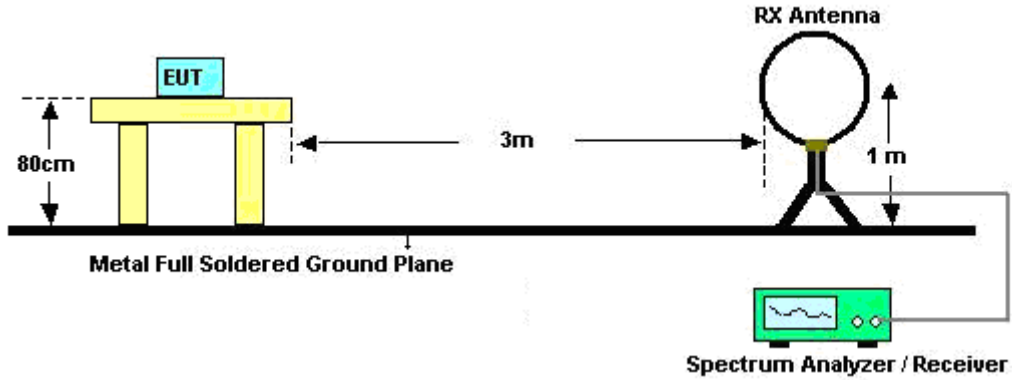

For radiated emissions from 30MHz to 1GHz

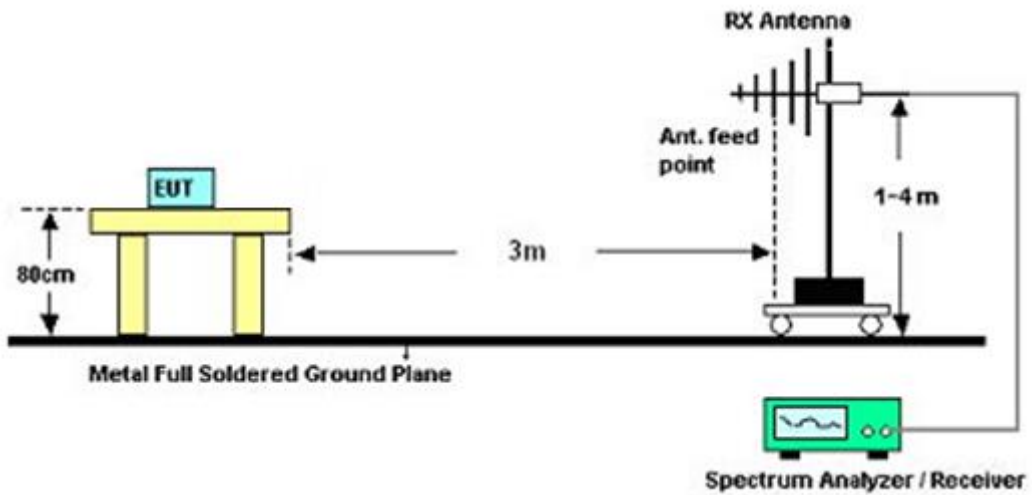

For radiated emissions above 1GHz

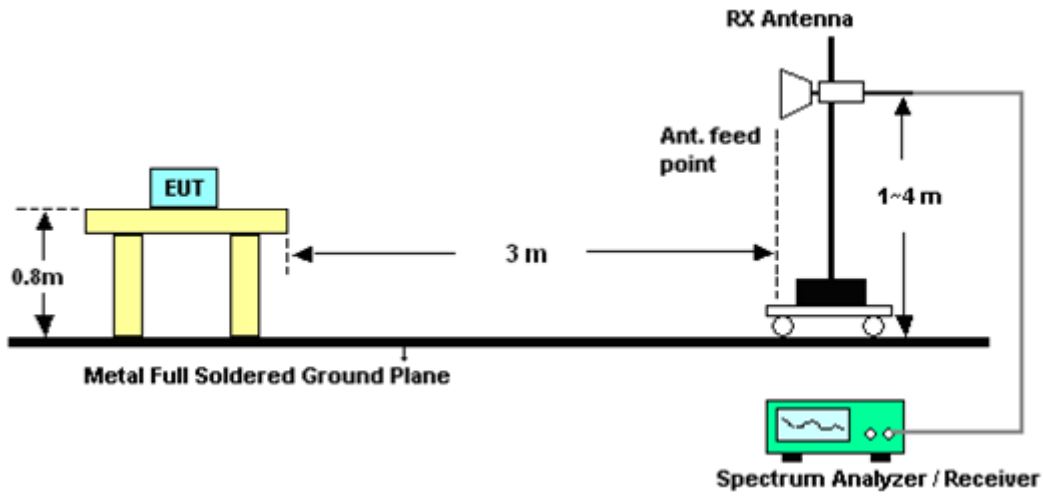

3.4.5 Test Results of Radiated Emissions (9 kHz ~ 30 MHz)

The low frequency, which started from 9 kHz to 30MHz, was pre-scanned and the result which was 20dB lower than the limit line per 15.31(o) was not reported.



3.4.6 Test Result

3.4.7 Test Result of Radiated Band Edges

Test Mode :	802.11a	Temperature :	22~23°C
Test Channel :	36	Relative Humidity :	52~53%
Test Engineer :	Hayden Wu		

ANTENNA POLARITY : HORIZONTAL										
Frequency (MHz)	Level (dBμV/m)	Over Limit (dB)	Limit Line (dBμV/m)	Read Level (dBμV)	Antenna Factor (dB)	Cable Loss (dB)	Preamp Factor (dB)	Ant Pos (cm)	Table Pos (deg)	Remark
5148.8	64.95	-9.05	74	54.05	34.45	10.44	33.99	100	6	Peak
5127.8	48.41	-5.59	54	37.57	34.43	10.4	33.99	100	6	Average

ANTENNA POLARITY : VERTICAL										
Frequency (MHz)	Level (dBμV/m)	Over Limit (dB)	Limit Line (dBμV/m)	Read Level (dBμV)	Antenna Factor (dB)	Cable Loss (dB)	Preamp Factor (dB)	Ant Pos (cm)	Table Pos (deg)	Remark
5149.7	59.89	-14.11	74	48.99	34.45	10.44	33.99	100	151	Peak
5127.95	45.97	-8.03	54	35.13	34.43	10.4	33.99	100	151	Average

Test Mode :	802.11a	Temperature :	22~23°C
Test Channel :	48	Relative Humidity :	52~53%
Test Engineer :	Hayden Wu		

ANTENNA POLARITY : HORIZONTAL										
Frequency (MHz)	Level (dBμV/m)	Over Limit (dB)	Limit Line (dBμV/m)	Read Level (dBμV)	Antenna Factor (dB)	Cable Loss (dB)	Preamp Factor (dB)	Ant Pos (cm)	Table Pos (deg)	Remark
5123.45	54.07	-19.93	74	43.23	34.43	10.4	33.99	117	309	Peak
5147.3	44.04	-9.96	54	33.14	34.45	10.44	33.99	117	309	Average
5380.03	55.69	-18.31	74	44.2	34.68	10.79	33.98	117	309	Peak
5438.77	44.47	-9.53	54	32.86	34.73	10.86	33.98	117	309	Average

ANTENNA POLARITY : VERTICAL										
Frequency (MHz)	Level (dBμV/m)	Over Limit (dB)	Limit Line (dBμV/m)	Read Level (dBμV)	Antenna Factor (dB)	Cable Loss (dB)	Preamp Factor (dB)	Ant Pos (cm)	Table Pos (deg)	Remark
5136.5	54.23	-19.77	74	43.39	34.43	10.4	33.99	197	17	Peak
5148.35	43.85	-10.15	54	32.95	34.45	10.44	33.99	197	17	Average
5382.23	55	-19	74	43.51	34.68	10.79	33.98	197	17	Peak
5453.51	44.43	-9.57	54	32.77	34.75	10.89	33.98	197	17	Average



Test Mode :	802.11a	Temperature :	22~23°C
Test Channel :	52	Relative Humidity :	52~53%
Test Engineer :	Hayden Wu		

ANTENNA POLARITY : HORIZONTAL										
Frequency (MHz)	Level (dBμV/m)	Over Limit (dB)	Limit Line (dBμV/m)	Read Level (dBμV)	Antenna Factor (dB)	Cable Loss (dB)	Preamp Factor (dB)	Ant Pos (cm)	Table Pos (deg)	Remark
5137.1	54.93	-19.07	74	44.09	34.43	10.4	33.99	117	298	Peak
5142.65	43.99	-10.01	54	33.09	34.45	10.44	33.99	117	298	Average
5412.48	55.9	-18.1	74	44.34	34.72	10.82	33.98	117	298	Peak
5438	44.63	-9.37	54	33.02	34.73	10.86	33.98	117	298	Average

ANTENNA POLARITY : VERTICAL										
Frequency (MHz)	Level (dBμV/m)	Over Limit (dB)	Limit Line (dBμV/m)	Read Level (dBμV)	Antenna Factor (dB)	Cable Loss (dB)	Preamp Factor (dB)	Ant Pos (cm)	Table Pos (deg)	Remark
5131.1	55.26	-18.74	74	44.42	34.43	10.4	33.99	100	330	Peak
5144.45	43.88	-10.12	54	32.98	34.45	10.44	33.99	100	330	Average
5409.95	55.8	-18.2	74	44.26	34.7	10.82	33.98	100	330	Peak
5444.16	44.6	-9.4	54	32.99	34.73	10.86	33.98	100	330	Average

Test Mode :	802.11a	Temperature :	22~23°C
Test Channel :	64	Relative Humidity :	52~53%
Test Engineer :	Hayden Wu		

ANTENNA POLARITY : HORIZONTAL										
Frequency (MHz)	Level (dBμV/m)	Over Limit (dB)	Limit Line (dBμV/m)	Read Level (dBμV)	Antenna Factor (dB)	Cable Loss (dB)	Preamp Factor (dB)	Ant Pos (cm)	Table Pos (deg)	Remark
5353.19	68.99	-5.01	74	57.6	34.65	10.72	33.98	103	299	Peak
5372.55	50.9	-3.1	54	39.46	34.67	10.75	33.98	103	299	Average

ANTENNA POLARITY : VERTICAL										
Frequency (MHz)	Level (dBμV/m)	Over Limit (dB)	Limit Line (dBμV/m)	Read Level (dBμV)	Antenna Factor (dB)	Cable Loss (dB)	Preamp Factor (dB)	Ant Pos (cm)	Table Pos (deg)	Remark
5350.55	58.83	-15.17	74	47.44	34.65	10.72	33.98	138	348	Peak
5372.33	45.99	-8.01	54	34.55	34.67	10.75	33.98	138	348	Average



Test Mode :	802.11a	Temperature :	22~23°C
Test Channel :	100	Relative Humidity :	52~53%
Test Engineer :	Hayden Wu		

ANTENNA POLARITY : HORIZONTAL										
Frequency (MHz)	Level (dBμV/m)	Over Limit (dB)	Limit Line (dBμV/m)	Read Level (dBμV)	Antenna Factor (dB)	Cable Loss (dB)	Preamp Factor (dB)	Ant Pos (cm)	Table Pos (deg)	Remark
5469.84	70.83	-3.17	74	59.15	34.77	10.89	33.98	100	2	Peak
5447.6	51.77	-2.23	54	40.14	34.75	10.86	33.98	100	2	Average

ANTENNA POLARITY : VERTICAL										
Frequency (MHz)	Level (dBμV/m)	Over Limit (dB)	Limit Line (dBμV/m)	Read Level (dBμV)	Antenna Factor (dB)	Cable Loss (dB)	Preamp Factor (dB)	Ant Pos (cm)	Table Pos (deg)	Remark
5467.44	60.9	-13.1	74	49.22	34.77	10.89	33.98	100	358	Peak
5447.76	45.51	-8.49	54	33.88	34.75	10.86	33.98	100	358	Average

Test Mode :	802.11a	Temperature :	22~23°C
Test Channel :	140	Relative Humidity :	52~53%
Test Engineer :	Hayden Wu		

ANTENNA POLARITY : HORIZONTAL										
Frequency (MHz)	Level (dBμV/m)	Over Limit (dB)	Limit Line (dBμV/m)	Read Level (dBμV)	Antenna Factor (dB)	Cable Loss (dB)	Preamp Factor (dB)	Ant Pos (cm)	Table Pos (deg)	Remark
5726.6	73.73	-0.27	74	61.36	35.02	11.34	33.99	118	3	Peak
5752.6	50.21	-3.79	54	37.75	35.06	11.39	33.99	118	3	Average

ANTENNA POLARITY : VERTICAL										
Frequency (MHz)	Level (dBμV/m)	Over Limit (dB)	Limit Line (dBμV/m)	Read Level (dBμV)	Antenna Factor (dB)	Cable Loss (dB)	Preamp Factor (dB)	Ant Pos (cm)	Table Pos (deg)	Remark
5725	62.66	-11.34	74	50.29	35.02	11.34	33.99	100	182	Peak
5753.08	45.81	-8.19	54	33.35	35.06	11.39	33.99	100	182	Average



Test Mode :	802.11n HT20	Temperature :	22~23°C
Test Channel :	36	Relative Humidity :	52~53%
Test Engineer :	Hayden Wu		

ANTENNA POLARITY : HORIZONTAL										
Frequency (MHz)	Level (dBμV/m)	Over Limit (dB)	Limit Line (dBμV/m)	Read Level (dBμV)	Antenna Factor (dB)	Cable Loss (dB)	Preamp Factor (dB)	Ant Pos (cm)	Table Pos (deg)	Remark
5150	70.79	-3.21	74	59.89	34.45	10.44	33.99	120	314	Peak
5128.25	51.99	-2.01	54	41.15	34.43	10.4	33.99	120	314	Average

ANTENNA POLARITY : VERTICAL										
Frequency (MHz)	Level (dBμV/m)	Over Limit (dB)	Limit Line (dBμV/m)	Read Level (dBμV)	Antenna Factor (dB)	Cable Loss (dB)	Preamp Factor (dB)	Ant Pos (cm)	Table Pos (deg)	Remark
5149.25	64.71	-9.29	74	53.81	34.45	10.44	33.99	200	124	Peak
5127.95	46.46	-7.54	54	35.62	34.43	10.4	33.99	200	124	Average

Test Mode :	802.11n HT20	Temperature :	22~23°C
Test Channel :	48	Relative Humidity :	52~53%
Test Engineer :	Hayden Wu		

ANTENNA POLARITY : HORIZONTAL										
Frequency (MHz)	Level (dBμV/m)	Over Limit (dB)	Limit Line (dBμV/m)	Read Level (dBμV)	Antenna Factor (dB)	Cable Loss (dB)	Preamp Factor (dB)	Ant Pos (cm)	Table Pos (deg)	Remark
5141.15	54.74	-19.26	74	43.84	34.45	10.44	33.99	117	313	Peak
5148.35	43.98	-10.02	54	33.08	34.45	10.44	33.99	117	313	Average
5454.28	55.51	-18.49	74	43.85	34.75	10.89	33.98	117	313	Peak
5440.42	44.44	-9.56	54	32.83	34.73	10.86	33.98	117	313	Average

ANTENNA POLARITY : VERTICAL										
Frequency (MHz)	Level (dBμV/m)	Over Limit (dB)	Limit Line (dBμV/m)	Read Level (dBμV)	Antenna Factor (dB)	Cable Loss (dB)	Preamp Factor (dB)	Ant Pos (cm)	Table Pos (deg)	Remark
5090	54.65	-19.35	74	43.91	34.4	10.33	33.99	197	0	Peak
5143.55	43.69	-10.31	54	32.79	34.45	10.44	33.99	197	0	Average
5405.99	54.63	-19.37	74	43.09	34.7	10.82	33.98	197	0	Peak
5439.87	44.39	-9.61	54	32.78	34.73	10.86	33.98	197	0	Average



Test Mode :	802.11n HT20	Temperature :	22~23°C
Test Channel :	52	Relative Humidity :	52~53%
Test Engineer :	Hayden Wu		

ANTENNA POLARITY : HORIZONTAL										
Frequency (MHz)	Level (dBμV/m)	Over Limit (dB)	Limit Line (dBμV/m)	Read Level (dBμV)	Antenna Factor (dB)	Cable Loss (dB)	Preamp Factor (dB)	Ant Pos (cm)	Table Pos (deg)	Remark
5130.05	55.2	-18.8	74	44.36	34.43	10.4	33.99	107	309	Peak
5145.05	44.2	-9.8	54	33.3	34.45	10.44	33.99	107	309	Average

ANTENNA POLARITY : VERTICAL										
Frequency (MHz)	Level (dBμV/m)	Over Limit (dB)	Limit Line (dBμV/m)	Read Level (dBμV)	Antenna Factor (dB)	Cable Loss (dB)	Preamp Factor (dB)	Ant Pos (cm)	Table Pos (deg)	Remark
5144.6	54.31	-19.69	74	43.41	34.45	10.44	33.99	100	143	Peak
5144.15	44	-10	54	33.1	34.45	10.44	33.99	100	143	Average

Test Mode :	802.11n HT20	Temperature :	22~23°C
Test Channel :	64	Relative Humidity :	52~53%
Test Engineer :	Hayden Wu		

ANTENNA POLARITY : HORIZONTAL										
Frequency (MHz)	Level (dBμV/m)	Over Limit (dB)	Limit Line (dBμV/m)	Read Level (dBμV)	Antenna Factor (dB)	Cable Loss (dB)	Preamp Factor (dB)	Ant Pos (cm)	Table Pos (deg)	Remark
5357.37	72.81	-1.19	74	61.39	34.65	10.75	33.98	105	310	Peak
5371.56	52.49	-1.51	54	41.05	34.67	10.75	33.98	105	310	Average

ANTENNA POLARITY : VERTICAL										
Frequency (MHz)	Level (dBμV/m)	Over Limit (dB)	Limit Line (dBμV/m)	Read Level (dBμV)	Antenna Factor (dB)	Cable Loss (dB)	Preamp Factor (dB)	Ant Pos (cm)	Table Pos (deg)	Remark
5353.63	60.47	-13.53	74	49.08	34.65	10.72	33.98	176	40	Peak
5371.67	46.05	-7.95	54	34.61	34.67	10.75	33.98	176	40	Average



Test Mode :	802.11n HT20	Temperature :	22~23°C
Test Channel :	100	Relative Humidity :	52~53%
Test Engineer :	Hayden Wu		

ANTENNA POLARITY : HORIZONTAL										
Frequency (MHz)	Level (dBμV/m)	Over Limit (dB)	Limit Line (dBμV/m)	Read Level (dBμV)	Antenna Factor (dB)	Cable Loss (dB)	Preamp Factor (dB)	Ant Pos (cm)	Table Pos (deg)	Remark
5466.8	71.84	-2.16	74	60.16	34.77	10.89	33.98	101	296	Peak
5448.24	53.83	-0.17	54	42.2	34.75	10.86	33.98	101	296	Average

ANTENNA POLARITY : VERTICAL										
Frequency (MHz)	Level (dBμV/m)	Over Limit (dB)	Limit Line (dBμV/m)	Read Level (dBμV)	Antenna Factor (dB)	Cable Loss (dB)	Preamp Factor (dB)	Ant Pos (cm)	Table Pos (deg)	Remark
5469.84	61.44	-12.56	74	49.76	34.77	10.89	33.98	100	350	Peak
5448.4	46.33	-7.67	54	34.7	34.75	10.86	33.98	100	350	Average

Test Mode :	802.11n HT20	Temperature :	22~23°C
Test Channel :	140	Relative Humidity :	52~53%
Test Engineer :	Hayden Wu		

ANTENNA POLARITY : HORIZONTAL										
Frequency (MHz)	Level (dBμV/m)	Over Limit (dB)	Limit Line (dBμV/m)	Read Level (dBμV)	Antenna Factor (dB)	Cable Loss (dB)	Preamp Factor (dB)	Ant Pos (cm)	Table Pos (deg)	Remark
5730.04	73.2	-0.8	74	60.83	35.02	11.34	33.99	108	358	Peak
5751.8	51.8	-2.2	54	39.34	35.06	11.39	33.99	108	358	Average

ANTENNA POLARITY : VERTICAL										
Frequency (MHz)	Level (dBμV/m)	Over Limit (dB)	Limit Line (dBμV/m)	Read Level (dBμV)	Antenna Factor (dB)	Cable Loss (dB)	Preamp Factor (dB)	Ant Pos (cm)	Table Pos (deg)	Remark
5728.84	61.12	-12.88	74	48.75	35.02	11.34	33.99	143	180	Peak
5751.72	45.87	-8.13	54	33.41	35.06	11.39	33.99	143	180	Average



Test Mode :	802.11n HT40	Temperature :	22~23°C
Test Channel :	38	Relative Humidity :	52~53%
Test Engineer :	Hayden Wu		

ANTENNA POLARITY : HORIZONTAL										
Frequency (MHz)	Level (dBμV/m)	Over Limit (dB)	Limit Line (dBμV/m)	Read Level (dBμV)	Antenna Factor (dB)	Cable Loss (dB)	Preamp Factor (dB)	Ant Pos (cm)	Table Pos (deg)	Remark
5149.85	68.58	-5.42	74	57.68	34.45	10.44	33.99	132	314	Peak
5149.55	52.17	-1.83	54	41.27	34.45	10.44	33.99	132	314	Average
5365.62	55.03	-18.97	74	43.59	34.67	10.75	33.98	132	314	Peak
5413.36	44.69	-9.31	54	33.13	34.72	10.82	33.98	132	314	Average

ANTENNA POLARITY : VERTICAL										
Frequency (MHz)	Level (dBμV/m)	Over Limit (dB)	Limit Line (dBμV/m)	Read Level (dBμV)	Antenna Factor (dB)	Cable Loss (dB)	Preamp Factor (dB)	Ant Pos (cm)	Table Pos (deg)	Remark
5148.05	59.38	-14.62	74	48.48	34.45	10.44	33.99	200	122	Peak
5149.4	46.38	-7.62	54	35.48	34.45	10.44	33.99	200	122	Average
5429.53	54.77	-19.23	74	43.16	34.73	10.86	33.98	200	122	Peak
5442.07	44.67	-9.33	54	33.06	34.73	10.86	33.98	200	122	Average



Test Mode :	802.11n HT40	Temperature :	22~23°C
Test Channel :	46	Relative Humidity :	52~53%
Test Engineer :	Hayden Wu		

ANTENNA POLARITY : HORIZONTAL										
Frequency (MHz)	Level (dBμV/m)	Over Limit (dB)	Limit Line (dBμV/m)	Read Level (dBμV)	Antenna Factor (dB)	Cable Loss (dB)	Preamp Factor (dB)	Ant Pos (cm)	Table Pos (deg)	Remark
5126.45	56.7	-17.3	74	45.86	34.43	10.4	33.99	105	307	Peak
5127.65	46.46	-7.54	54	35.62	34.43	10.4	33.99	105	307	Average
5385.42	55.02	-18.98	74	43.53	34.68	10.79	33.98	105	307	Peak
5362.54	44.89	-9.11	54	33.45	34.67	10.75	33.98	105	307	Average

ANTENNA POLARITY : VERTICAL										
Frequency (MHz)	Level (dBμV/m)	Over Limit (dB)	Limit Line (dBμV/m)	Read Level (dBμV)	Antenna Factor (dB)	Cable Loss (dB)	Preamp Factor (dB)	Ant Pos (cm)	Table Pos (deg)	Remark
5143.25	54.97	-19.03	74	44.07	34.45	10.44	33.99	196	12	Peak
5127.95	44.4	-9.6	54	33.56	34.43	10.4	33.99	196	12	Average
5436.79	55.53	-18.47	74	43.92	34.73	10.86	33.98	196	12	Peak
5446.58	44.7	-9.3	54	33.07	34.75	10.86	33.98	196	12	Average



Test Mode :	802.11n HT40	Temperature :	22~23°C
Test Channel :	54	Relative Humidity :	52~53%
Test Engineer :	Hayden Wu		

ANTENNA POLARITY : HORIZONTAL										
Frequency (MHz)	Level (dBμV/m)	Over Limit (dB)	Limit Line (dBμV/m)	Read Level (dBμV)	Antenna Factor (dB)	Cable Loss (dB)	Preamp Factor (dB)	Ant Pos (cm)	Table Pos (deg)	Remark
5141.15	54.9	-19.1	74	44	34.45	10.44	33.99	107	309	Peak
5138.3	44.82	-9.18	54	33.98	34.43	10.4	33.99	107	309	Average
5350.88	59.02	-14.98	74	47.63	34.65	10.72	33.98	107	309	Peak
5372.88	47.1	-6.9	54	35.66	34.67	10.75	33.98	107	309	Average

ANTENNA POLARITY : VERTICAL										
Frequency (MHz)	Level (dBμV/m)	Over Limit (dB)	Limit Line (dBμV/m)	Read Level (dBμV)	Antenna Factor (dB)	Cable Loss (dB)	Preamp Factor (dB)	Ant Pos (cm)	Table Pos (deg)	Remark
5094.35	54.53	-19.47	74	43.75	34.4	10.37	33.99	119	154	Peak
5138.6	44.23	-9.77	54	33.39	34.43	10.4	33.99	119	154	Average
5442.07	55.47	-18.53	74	43.86	34.73	10.86	33.98	119	154	Peak
5375.19	44.94	-9.06	54	33.5	34.67	10.75	33.98	119	154	Average



Test Mode :	802.11n HT40	Temperature :	22~23°C
Test Channel :	62	Relative Humidity :	52~53%
Test Engineer :	Hayden Wu		

ANTENNA POLARITY : HORIZONTAL										
Frequency (MHz)	Level (dBμV/m)	Over Limit (dB)	Limit Line (dBμV/m)	Read Level (dBμV)	Antenna Factor (dB)	Cable Loss (dB)	Preamp Factor (dB)	Ant Pos (cm)	Table Pos (deg)	Remark
5061.65	54.48	-19.52	74	43.8	34.37	10.3	33.99	106	308	Peak
5134.1	44.36	-9.64	54	33.52	34.43	10.4	33.99	106	308	Average
5352.42	67.53	-6.47	74	56.14	34.65	10.72	33.98	106	308	Peak
5350	52.46	-1.54	54	41.07	34.65	10.72	33.98	106	308	Average

ANTENNA POLARITY : VERTICAL										
Frequency (MHz)	Level (dBμV/m)	Over Limit (dB)	Limit Line (dBμV/m)	Read Level (dBμV)	Antenna Factor (dB)	Cable Loss (dB)	Preamp Factor (dB)	Ant Pos (cm)	Table Pos (deg)	Remark
5084.3	54.34	-19.66	74	43.62	34.38	10.33	33.99	165	7	Peak
5144.3	44.17	-9.83	54	33.27	34.45	10.44	33.99	165	7	Average
5354.73	58.93	-15.07	74	47.54	34.65	10.72	33.98	165	7	Peak
5350.55	46.32	-7.68	54	34.93	34.65	10.72	33.98	165	7	Average



Test Mode :	802.11n HT40	Temperature :	22~23°C
Test Channel :	102	Relative Humidity :	52~53%
Test Engineer :	Hayden Wu		

ANTENNA POLARITY : HORIZONTAL										
Frequency (MHz)	Level (dBμV/m)	Over Limit (dB)	Limit Line (dBμV/m)	Read Level (dBμV)	Antenna Factor (dB)	Cable Loss (dB)	Preamp Factor (dB)	Ant Pos (cm)	Table Pos (deg)	Remark
5468.72	68.79	-5.21	74	57.11	34.77	10.89	33.98	100	359	Peak
5470	52.88	-1.12	54	41.2	34.77	10.89	33.98	100	359	Average
5738.2	56.05	-17.95	74	43.66	35.04	11.34	33.99	100	359	Peak
5740.04	45.56	-8.44	54	33.12	35.04	11.39	33.99	100	359	Average

ANTENNA POLARITY : VERTICAL										
Frequency (MHz)	Level (dBμV/m)	Over Limit (dB)	Limit Line (dBμV/m)	Read Level (dBμV)	Antenna Factor (dB)	Cable Loss (dB)	Preamp Factor (dB)	Ant Pos (cm)	Table Pos (deg)	Remark
5468.08	61.68	-12.32	74	50	34.77	10.89	33.98	100	351	Peak
5469.52	46.6	-7.4	54	34.92	34.77	10.89	33.98	100	351	Average
5725	56.25	-17.75	74	43.88	35.02	11.34	33.99	100	351	Peak
5764.92	45.52	-8.48	54	33.03	35.06	11.43	34	100	351	Average



Test Mode :	802.11n HT40	Temperature :	22~23°C
Test Channel :	110	Relative Humidity :	52~53%
Test Engineer :	Hayden Wu		

ANTENNA POLARITY : HORIZONTAL										
Frequency (MHz)	Level (dBμV/m)	Over Limit (dB)	Limit Line (dBμV/m)	Read Level (dBμV)	Antenna Factor (dB)	Cable Loss (dB)	Preamp Factor (dB)	Ant Pos (cm)	Table Pos (deg)	Remark
5469.52	63.84	-10.16	74	52.16	34.77	10.89	33.98	100	0	Peak
5446.32	49.8	-4.2	54	38.17	34.75	10.86	33.98	100	0	Average
5738.92	56.41	-17.59	74	44.02	35.04	11.34	33.99	100	0	Peak
5755.4	45.66	-8.34	54	33.2	35.06	11.39	33.99	100	0	Average

ANTENNA POLARITY : VERTICAL										
Frequency (MHz)	Level (dBμV/m)	Over Limit (dB)	Limit Line (dBμV/m)	Read Level (dBμV)	Antenna Factor (dB)	Cable Loss (dB)	Preamp Factor (dB)	Ant Pos (cm)	Table Pos (deg)	Remark
5456.56	55.57	-18.43	74	43.91	34.75	10.89	33.98	100	351	Peak
5446.16	45.61	-8.39	54	33.98	34.75	10.86	33.98	100	351	Average
5751.24	56.02	-17.98	74	43.58	35.04	11.39	33.99	100	351	Peak
5736.68	45.54	-8.46	54	33.15	35.04	11.34	33.99	100	351	Average



Test Mode :	802.11n HT40	Temperature :	22~23°C
Test Channel :	134	Relative Humidity :	52~53%
Test Engineer :	Hayden Wu		

ANTENNA POLARITY : HORIZONTAL										
Frequency (MHz)	Level (dBμV/m)	Over Limit (dB)	Limit Line (dBμV/m)	Read Level (dBμV)	Antenna Factor (dB)	Cable Loss (dB)	Preamp Factor (dB)	Ant Pos (cm)	Table Pos (deg)	Remark
5461.04	55.88	-18.12	74	44.22	34.75	10.89	33.98	109	356	Peak
5466.64	45.01	-8.99	54	33.33	34.77	10.89	33.98	109	356	Average
5725.32	72.41	-1.59	74	60.04	35.02	11.34	33.99	109	356	Peak
5725.16	52.93	-1.07	54	40.56	35.02	11.34	33.99	109	356	Average

ANTENNA POLARITY : VERTICAL										
Frequency (MHz)	Level (dBμV/m)	Over Limit (dB)	Limit Line (dBμV/m)	Read Level (dBμV)	Antenna Factor (dB)	Cable Loss (dB)	Preamp Factor (dB)	Ant Pos (cm)	Table Pos (deg)	Remark
5399.76	55.28	-18.72	74	43.77	34.7	10.79	33.98	100	181	Peak
5430.64	44.88	-9.12	54	33.27	34.73	10.86	33.98	100	181	Average
5725.24	60.49	-13.51	74	48.12	35.02	11.34	33.99	100	181	Peak
5725.48	46.83	-7.17	54	34.46	35.02	11.34	33.99	100	181	Average



Test Mode :	802.11ac VHT20	Temperature :	22~23°C
Test Channel :	36	Relative Humidity :	52~53%
Test Engineer :	Hayden Wu		

ANTENNA POLARITY : HORIZONTAL										
Frequency (MHz)	Level (dBμV/m)	Over Limit (dB)	Limit Line (dBμV/m)	Read Level (dBμV)	Antenna Factor (dB)	Cable Loss (dB)	Preamp Factor (dB)	Ant Pos (cm)	Table Pos (deg)	Remark
5149.55	70.4	-3.6	74	59.5	34.45	10.44	33.99	107	312	Peak
5128.1	52.27	-1.73	54	41.43	34.43	10.4	33.99	107	312	Average

ANTENNA POLARITY : VERTICAL										
Frequency (MHz)	Level (dBμV/m)	Over Limit (dB)	Limit Line (dBμV/m)	Read Level (dBμV)	Antenna Factor (dB)	Cable Loss (dB)	Preamp Factor (dB)	Ant Pos (cm)	Table Pos (deg)	Remark
5150	63.85	-10.15	74	52.95	34.45	10.44	33.99	186	123	Peak
5127.95	47.99	-6.01	54	37.15	34.43	10.4	33.99	186	123	Average

Test Mode :	802.11ac VHT20	Temperature :	22~23°C
Test Channel :	48	Relative Humidity :	52~53%
Test Engineer :	Hayden Wu		

ANTENNA POLARITY : HORIZONTAL										
Frequency (MHz)	Level (dBμV/m)	Over Limit (dB)	Limit Line (dBμV/m)	Read Level (dBμV)	Antenna Factor (dB)	Cable Loss (dB)	Preamp Factor (dB)	Ant Pos (cm)	Table Pos (deg)	Remark
5138.45	54.89	-19.11	74	44.05	34.43	10.4	33.99	106	307	Peak
5148.65	44.39	-9.61	54	33.49	34.45	10.44	33.99	106	307	Average
5457.47	55.24	-18.76	74	43.58	34.75	10.89	33.98	106	307	Peak
5454.94	44.78	-9.22	54	33.12	34.75	10.89	33.98	106	307	Average

ANTENNA POLARITY : VERTICAL										
Frequency (MHz)	Level (dBμV/m)	Over Limit (dB)	Limit Line (dBμV/m)	Read Level (dBμV)	Antenna Factor (dB)	Cable Loss (dB)	Preamp Factor (dB)	Ant Pos (cm)	Table Pos (deg)	Remark
5114.6	54.87	-19.13	74	44.07	34.42	10.37	33.99	200	155	Peak
5126.15	43.96	-10.04	54	33.12	34.43	10.4	33.99	200	155	Average
5454.06	55.29	-18.71	74	43.63	34.75	10.89	33.98	200	155	Peak
5430.96	44.66	-9.34	54	33.05	34.73	10.86	33.98	200	155	Average



Test Mode :	802.11ac VHT20	Temperature :	22~23°C
Test Channel :	52	Relative Humidity :	52~53%
Test Engineer :	Hayden Wu		

ANTENNA POLARITY : HORIZONTAL										
Frequency (MHz)	Level (dBμV/m)	Over Limit (dB)	Limit Line (dBμV/m)	Read Level (dBμV)	Antenna Factor (dB)	Cable Loss (dB)	Preamp Factor (dB)	Ant Pos (cm)	Table Pos (deg)	Remark
5096.75	54.67	-19.33	74	43.89	34.4	10.37	33.99	108	6	Peak
5142.8	44.45	-9.55	54	33.55	34.45	10.44	33.99	108	6	Average
5437.89	55.65	-18.35	74	44.04	34.73	10.86	33.98	108	6	Peak
5452.3	45.11	-8.89	54	33.45	34.75	10.89	33.98	108	6	Average

ANTENNA POLARITY : VERTICAL										
Frequency (MHz)	Level (dBμV/m)	Over Limit (dB)	Limit Line (dBμV/m)	Read Level (dBμV)	Antenna Factor (dB)	Cable Loss (dB)	Preamp Factor (dB)	Ant Pos (cm)	Table Pos (deg)	Remark
5141	54.58	-19.42	74	43.68	34.45	10.44	33.99	169	164	Peak
5142.35	44.29	-9.71	54	33.39	34.45	10.44	33.99	169	164	Average
5392.57	55.34	-18.66	74	43.85	34.68	10.79	33.98	169	164	Peak
5445.15	44.94	-9.06	54	33.33	34.73	10.86	33.98	169	164	Average

Test Mode :	802.11ac VHT20	Temperature :	22~23°C
Test Channel :	64	Relative Humidity :	52~53%
Test Engineer :	Hayden Wu		

ANTENNA POLARITY : HORIZONTAL										
Frequency (MHz)	Level (dBμV/m)	Over Limit (dB)	Limit Line (dBμV/m)	Read Level (dBμV)	Antenna Factor (dB)	Cable Loss (dB)	Preamp Factor (dB)	Ant Pos (cm)	Table Pos (deg)	Remark
5350.44	70.42	-3.58	74	59.03	34.65	10.72	33.98	117	360	Peak
5371.89	53.22	-0.78	54	41.78	34.67	10.75	33.98	117	360	Average

ANTENNA POLARITY : VERTICAL										
Frequency (MHz)	Level (dBμV/m)	Over Limit (dB)	Limit Line (dBμV/m)	Read Level (dBμV)	Antenna Factor (dB)	Cable Loss (dB)	Preamp Factor (dB)	Ant Pos (cm)	Table Pos (deg)	Remark
5350.55	60.12	-13.88	74	48.73	34.65	10.72	33.98	176	28	Peak
5372	46.08	-7.92	54	34.64	34.67	10.75	33.98	176	28	Average



Test Mode :	802.11ac VHT20	Temperature :	22~23°C
Test Channel :	100	Relative Humidity :	52~53%
Test Engineer :	Hayden Wu		

ANTENNA POLARITY : HORIZONTAL										
Frequency (MHz)	Level (dBμV/m)	Over Limit (dB)	Limit Line (dBμV/m)	Read Level (dBμV)	Antenna Factor (dB)	Cable Loss (dB)	Preamp Factor (dB)	Ant Pos (cm)	Table Pos (deg)	Remark
5470	71.94	-2.06	74	60.26	34.77	10.89	33.98	100	0	Peak
5448.4	53.06	-0.94	54	41.43	34.75	10.86	33.98	100	0	Average

ANTENNA POLARITY : VERTICAL										
Frequency (MHz)	Level (dBμV/m)	Over Limit (dB)	Limit Line (dBμV/m)	Read Level (dBμV)	Antenna Factor (dB)	Cable Loss (dB)	Preamp Factor (dB)	Ant Pos (cm)	Table Pos (deg)	Remark
5469.68	63.64	-10.36	74	51.96	34.77	10.89	33.98	100	350	Peak
5470	47.24	-6.76	54	35.56	34.77	10.89	33.98	100	350	Average

Test Mode :	802.11ac VHT20	Temperature :	22~23°C
Test Channel :	140	Relative Humidity :	52~53%
Test Engineer :	Hayden Wu		

ANTENNA POLARITY : HORIZONTAL										
Frequency (MHz)	Level (dBμV/m)	Over Limit (dB)	Limit Line (dBμV/m)	Read Level (dBμV)	Antenna Factor (dB)	Cable Loss (dB)	Preamp Factor (dB)	Ant Pos (cm)	Table Pos (deg)	Remark
5725.4	72.55	-1.45	74	60.18	35.02	11.34	33.99	107	359	Peak
5751.56	52.27	-1.73	54	39.81	35.06	11.39	33.99	107	359	Average

ANTENNA POLARITY : VERTICAL										
Frequency (MHz)	Level (dBμV/m)	Over Limit (dB)	Limit Line (dBμV/m)	Read Level (dBμV)	Antenna Factor (dB)	Cable Loss (dB)	Preamp Factor (dB)	Ant Pos (cm)	Table Pos (deg)	Remark
5725.8	62.51	-11.49	74	50.14	35.02	11.34	33.99	100	182	Peak
5725.56	46.52	-7.48	54	34.15	35.02	11.34	33.99	100	182	Average



Test Mode :	802.11ac VHT40	Temperature :	22~23°C
Test Channel :	38	Relative Humidity :	52~53%
Test Engineer :	Hayden Wu		

ANTENNA POLARITY : HORIZONTAL										
Frequency (MHz)	Level (dBμV/m)	Over Limit (dB)	Limit Line (dBμV/m)	Read Level (dBμV)	Antenna Factor (dB)	Cable Loss (dB)	Preamp Factor (dB)	Ant Pos (cm)	Table Pos (deg)	Remark
5149.85	67.27	-6.73	74	56.37	34.45	10.44	33.99	131	313	Peak
5150	53.41	-0.59	54	42.51	34.45	10.44	33.99	131	313	Average
5373.65	55.17	-18.83	74	43.73	34.67	10.75	33.98	131	313	Peak
5438.55	44.71	-9.29	54	33.1	34.73	10.86	33.98	131	313	Average

ANTENNA POLARITY : VERTICAL										
Frequency (MHz)	Level (dBμV/m)	Over Limit (dB)	Limit Line (dBμV/m)	Read Level (dBμV)	Antenna Factor (dB)	Cable Loss (dB)	Preamp Factor (dB)	Ant Pos (cm)	Table Pos (deg)	Remark
5146.55	59.87	-14.13	74	48.97	34.45	10.44	33.99	200	122	Peak
5150	47.78	-6.22	54	36.88	34.45	10.44	33.99	200	122	Average
5416.11	54.82	-19.18	74	43.26	34.72	10.82	33.98	200	122	Peak
5436.68	44.65	-9.35	54	33.04	34.73	10.86	33.98	200	122	Average



Test Mode :	802.11ac VHT40	Temperature :	22~23°C
Test Channel :	46	Relative Humidity :	52~53%
Test Engineer :	Hayden Wu		

ANTENNA POLARITY : HORIZONTAL										
Frequency (MHz)	Level (dBμV/m)	Over Limit (dB)	Limit Line (dBμV/m)	Read Level (dBμV)	Antenna Factor (dB)	Cable Loss (dB)	Preamp Factor (dB)	Ant Pos (cm)	Table Pos (deg)	Remark
5125.85	60.2	-13.8	74	49.36	34.43	10.4	33.99	100	309	Peak
5126.3	49.16	-4.84	54	38.32	34.43	10.4	33.99	100	309	Average
5422.05	55.37	-18.63	74	43.81	34.72	10.82	33.98	100	309	Peak
5443.5	44.44	-9.56	54	32.83	34.73	10.86	33.98	100	309	Average

ANTENNA POLARITY : VERTICAL										
Frequency (MHz)	Level (dBμV/m)	Over Limit (dB)	Limit Line (dBμV/m)	Read Level (dBμV)	Antenna Factor (dB)	Cable Loss (dB)	Preamp Factor (dB)	Ant Pos (cm)	Table Pos (deg)	Remark
5141.9	54.61	-19.39	74	43.71	34.45	10.44	33.99	100	26	Peak
5126.75	44.39	-9.61	54	33.55	34.43	10.4	33.99	100	26	Average
5385.53	55.51	-18.49	74	44.02	34.68	10.79	33.98	100	26	Peak
5438.55	44.43	-9.57	54	32.82	34.73	10.86	33.98	100	26	Average



Test Mode :	802.11ac VHT40	Temperature :	22~23°C
Test Channel :	54	Relative Humidity :	52~53%
Test Engineer :	Hayden Wu		

ANTENNA POLARITY : HORIZONTAL										
Frequency (MHz)	Level (dBμV/m)	Over Limit (dB)	Limit Line (dBμV/m)	Read Level (dBμV)	Antenna Factor (dB)	Cable Loss (dB)	Preamp Factor (dB)	Ant Pos (cm)	Table Pos (deg)	Remark
5132	56.32	-17.68	74	45.48	34.43	10.4	33.99	107	312	Peak
5137.25	44.4	-9.6	54	33.56	34.43	10.4	33.99	107	312	Average
5374.09	57.84	-16.16	74	46.4	34.67	10.75	33.98	107	312	Peak
5373.21	47.15	-6.85	54	35.71	34.67	10.75	33.98	107	312	Average

ANTENNA POLARITY : VERTICAL										
Frequency (MHz)	Level (dBμV/m)	Over Limit (dB)	Limit Line (dBμV/m)	Read Level (dBμV)	Antenna Factor (dB)	Cable Loss (dB)	Preamp Factor (dB)	Ant Pos (cm)	Table Pos (deg)	Remark
5136.65	54.5	-19.5	74	43.66	34.43	10.4	33.99	182	360	Peak
5144.45	44.17	-9.83	54	33.27	34.45	10.44	33.99	182	360	Average
5407.2	55.29	-18.71	74	43.75	34.7	10.82	33.98	182	360	Peak
5373.65	45.06	-8.94	54	33.62	34.67	10.75	33.98	182	360	Average



Test Mode :	802.11ac VHT40	Temperature :	22~23°C
Test Channel :	62	Relative Humidity :	52~53%
Test Engineer :	Hayden Wu		

ANTENNA POLARITY : HORIZONTAL										
Frequency (MHz)	Level (dBμV/m)	Over Limit (dB)	Limit Line (dBμV/m)	Read Level (dBμV)	Antenna Factor (dB)	Cable Loss (dB)	Preamp Factor (dB)	Ant Pos (cm)	Table Pos (deg)	Remark
5132.9	54.81	-19.19	74	43.97	34.43	10.4	33.99	106	311	Peak
5146.55	44.28	-9.72	54	33.38	34.45	10.44	33.99	106	311	Average
5352.97	65.62	-8.38	74	54.23	34.65	10.72	33.98	106	311	Peak
5350	52.61	-1.39	54	41.22	34.65	10.72	33.98	106	311	Average

ANTENNA POLARITY : VERTICAL										
Frequency (MHz)	Level (dBμV/m)	Over Limit (dB)	Limit Line (dBμV/m)	Read Level (dBμV)	Antenna Factor (dB)	Cable Loss (dB)	Preamp Factor (dB)	Ant Pos (cm)	Table Pos (deg)	Remark
5147	54.84	-19.16	74	43.94	34.45	10.44	33.99	180	6	Peak
5124.95	44.22	-9.78	54	33.38	34.43	10.4	33.99	180	6	Average
5350.44	61.21	-12.79	74	49.82	34.65	10.72	33.98	180	6	Peak
5350.33	47.34	-6.66	54	35.95	34.65	10.72	33.98	180	6	Average



Test Mode :	802.11ac VHT40	Temperature :	22~23°C
Test Channel :	102	Relative Humidity :	52~53%
Test Engineer :	Hayden Wu		

ANTENNA POLARITY : HORIZONTAL										
Frequency (MHz)	Level (dBμV/m)	Over Limit (dB)	Limit Line (dBμV/m)	Read Level (dBμV)	Antenna Factor (dB)	Cable Loss (dB)	Preamp Factor (dB)	Ant Pos (cm)	Table Pos (deg)	Remark
5466.32	70.27	-3.73	74	58.59	34.77	10.89	33.98	101	359	Peak
5470	53.77	-0.23	54	42.09	34.77	10.89	33.98	101	359	Average
5740.28	56.45	-17.55	74	44.01	35.04	11.39	33.99	101	359	Peak
5727	45.66	-8.34	54	33.29	35.02	11.34	33.99	101	359	Average

ANTENNA POLARITY : VERTICAL										
Frequency (MHz)	Level (dBμV/m)	Over Limit (dB)	Limit Line (dBμV/m)	Read Level (dBμV)	Antenna Factor (dB)	Cable Loss (dB)	Preamp Factor (dB)	Ant Pos (cm)	Table Pos (deg)	Remark
5466.64	60.57	-13.43	74	48.89	34.77	10.89	33.98	100	351	Peak
5470	47.41	-6.59	54	35.73	34.77	10.89	33.98	100	351	Average
5756.6	56.54	-17.46	74	44.09	35.06	11.39	34	100	351	Peak
5757	45.59	-8.41	54	33.14	35.06	11.39	34	100	351	Average



Test Mode :	802.11ac VHT40	Temperature :	22~23°C
Test Channel :	110	Relative Humidity :	52~53%
Test Engineer :	Hayden Wu		

ANTENNA POLARITY : HORIZONTAL										
Frequency (MHz)	Level (dBμV/m)	Over Limit (dB)	Limit Line (dBμV/m)	Read Level (dBμV)	Antenna Factor (dB)	Cable Loss (dB)	Preamp Factor (dB)	Ant Pos (cm)	Table Pos (deg)	Remark
5469.04	62.2	-11.8	74	50.52	34.77	10.89	33.98	100	359	Peak
5446.64	49.71	-4.29	54	38.08	34.75	10.86	33.98	100	359	Average
5727.96	56.47	-17.53	74	44.1	35.02	11.34	33.99	100	359	Peak
5747.88	45.72	-8.28	54	33.28	35.04	11.39	33.99	100	359	Average

ANTENNA POLARITY : VERTICAL										
Frequency (MHz)	Level (dBμV/m)	Over Limit (dB)	Limit Line (dBμV/m)	Read Level (dBμV)	Antenna Factor (dB)	Cable Loss (dB)	Preamp Factor (dB)	Ant Pos (cm)	Table Pos (deg)	Remark
5446.48	56.06	-17.94	74	44.43	34.75	10.86	33.98	100	351	Peak
5444.72	45.96	-8.04	54	34.35	34.73	10.86	33.98	100	351	Average
5732.6	55.73	-18.27	74	43.36	35.02	11.34	33.99	100	351	Peak
5743.56	45.62	-8.38	54	33.18	35.04	11.39	33.99	100	351	Average



Test Mode :	802.11ac VHT40	Temperature :	22~23°C
Test Channel :	134	Relative Humidity :	52~53%
Test Engineer :	Hayden Wu		

ANTENNA POLARITY : HORIZONTAL										
Frequency (MHz)	Level (dBμV/m)	Over Limit (dB)	Limit Line (dBμV/m)	Read Level (dBμV)	Antenna Factor (dB)	Cable Loss (dB)	Preamp Factor (dB)	Ant Pos (cm)	Table Pos (deg)	Remark
5452.88	56.23	-17.77	74	44.57	34.75	10.89	33.98	118	356	Peak
5444.88	45.29	-8.71	54	33.68	34.73	10.86	33.98	118	356	Average
5725.88	70.36	-3.64	74	57.99	35.02	11.34	33.99	118	356	Peak
5725.08	53.57	-0.43	54	41.2	35.02	11.34	33.99	118	356	Average

ANTENNA POLARITY : VERTICAL										
Frequency (MHz)	Level (dBμV/m)	Over Limit (dB)	Limit Line (dBμV/m)	Read Level (dBμV)	Antenna Factor (dB)	Cable Loss (dB)	Preamp Factor (dB)	Ant Pos (cm)	Table Pos (deg)	Remark
5418.16	56.67	-17.33	74	45.11	34.72	10.82	33.98	100	177	Peak
5442.48	45.01	-8.99	54	33.4	34.73	10.86	33.98	100	177	Average
5725.64	60.62	-13.38	74	48.25	35.02	11.34	33.99	100	177	Peak
5725.16	47.43	-6.57	54	35.06	35.02	11.34	33.99	100	177	Average



Test Mode :	802.11ac VHT80	Temperature :	22~23°C
Test Channel :	42	Relative Humidity :	52~53%
Test Engineer :	Hayden Wu		

ANTENNA POLARITY : HORIZONTAL										
Frequency (MHz)	Level (dBμV/m)	Over Limit (dB)	Limit Line (dBμV/m)	Read Level (dBμV)	Antenna Factor (dB)	Cable Loss (dB)	Preamp Factor (dB)	Ant Pos (cm)	Table Pos (deg)	Remark
5149.1	60.31	-13.69	74	49.41	34.45	10.44	33.99	107	307	Peak
5150	47.96	-6.04	54	37.06	34.45	10.44	33.99	107	307	Average
5355.94	44.15	-29.85	74	32.76	34.65	10.72	33.98	107	307	Peak
5384.54	33.15	-20.85	54	21.66	34.68	10.79	33.98	107	307	Average

ANTENNA POLARITY : VERTICAL										
Frequency (MHz)	Level (dBμV/m)	Over Limit (dB)	Limit Line (dBμV/m)	Read Level (dBμV)	Antenna Factor (dB)	Cable Loss (dB)	Preamp Factor (dB)	Ant Pos (cm)	Table Pos (deg)	Remark
5149.1	49.84	-24.16	74	38.94	34.45	10.44	33.99	116	6	Peak
5149.1	38.62	-15.38	54	27.72	34.45	10.44	33.99	116	6	Average
5439.21	43.53	-30.47	74	31.92	34.73	10.86	33.98	116	6	Peak
5390.04	32.97	-21.03	54	21.48	34.68	10.79	33.98	116	6	Average



Test Mode :	802.11ac VHT80	Temperature :	22~23°C
Test Channel :	58	Relative Humidity :	52~53%
Test Engineer :	Hayden Wu		

ANTENNA POLARITY : HORIZONTAL										
Frequency (MHz)	Level (dBμV/m)	Over Limit (dB)	Limit Line (dBμV/m)	Read Level (dBμV)	Antenna Factor (dB)	Cable Loss (dB)	Preamp Factor (dB)	Ant Pos (cm)	Table Pos (deg)	Remark
5121.8	55.19	-18.81	74	44.36	34.42	10.4	33.99	118	312	Peak
5148.95	44.77	-9.23	54	33.87	34.45	10.44	33.99	118	312	Average
5354.84	67.73	-6.27	74	56.34	34.65	10.72	33.98	118	312	Peak
5350.55	53.5	-0.5	54	42.11	34.65	10.72	33.98	118	312	Average

ANTENNA POLARITY : VERTICAL										
Frequency (MHz)	Level (dBμV/m)	Over Limit (dB)	Limit Line (dBμV/m)	Read Level (dBμV)	Antenna Factor (dB)	Cable Loss (dB)	Preamp Factor (dB)	Ant Pos (cm)	Table Pos (deg)	Remark
5146.4	54.71	-19.29	74	43.81	34.45	10.44	33.99	181	6	Peak
5139.5	44.47	-9.53	54	33.61	34.45	10.4	33.99	181	6	Average
5354.62	58.45	-15.55	74	47.06	34.65	10.72	33.98	181	6	Peak
5355.06	46.71	-7.29	54	35.32	34.65	10.72	33.98	181	6	Average



Test Mode :	802.11ac VHT80	Temperature :	22~23°C
Test Channel :	106	Relative Humidity :	52~53%
Test Engineer :	Hayden Wu		

ANTENNA POLARITY : HORIZONTAL										
Frequency (MHz)	Level (dBμV/m)	Over Limit (dB)	Limit Line (dBμV/m)	Read Level (dBμV)	Antenna Factor (dB)	Cable Loss (dB)	Preamp Factor (dB)	Ant Pos (cm)	Table Pos (deg)	Remark
5465.68	65.37	-8.63	74	53.69	34.77	10.89	33.98	100	298	Peak
5469.36	53.47	-0.53	54	41.79	34.77	10.89	33.98	100	298	Average
5744.52	56.28	-17.72	74	43.84	35.04	11.39	33.99	100	298	Peak
5743.4	45.77	-8.23	54	33.33	35.04	11.39	33.99	100	298	Average

ANTENNA POLARITY : VERTICAL										
Frequency (MHz)	Level (dBμV/m)	Over Limit (dB)	Limit Line (dBμV/m)	Read Level (dBμV)	Antenna Factor (dB)	Cable Loss (dB)	Preamp Factor (dB)	Ant Pos (cm)	Table Pos (deg)	Remark
5467.76	57.54	-16.46	74	45.86	34.77	10.89	33.98	100	351	Peak
5469.84	46.6	-7.4	54	34.92	34.77	10.89	33.98	100	351	Average
5738.12	56.62	-17.38	74	44.23	35.04	11.34	33.99	100	351	Peak
5754.12	45.7	-8.3	54	33.24	35.06	11.39	33.99	100	351	Average



3.4.8 Test Result of Unwanted Radiated Emission (30MHz ~ 10th Harmonic)

Test Mode :	802.11a	Temperature :	22~23°C
Test Channel :	36	Relative Humidity :	52~53%
Test Engineer :	Hayden Wu	Polarization :	Horizontal
Remark :	1. 5178 MHz is fundamental signal which can be ignored. 2. 10359 MHz is not within a restricted band and satisfies both the average and peak limits of 15.209. 3. Average measurement was not performed if peak level went lower than the average limit.		

Frequency (MHz)	Level (dBμV/m)	Over Limit (dB)	Limit Line (dBμV/m)	Read Level (dBμV)	Antenna Factor (dB)	Cable Loss (dB)	Preamp Factor (dB)	Ant Pos (cm)	Table Pos (deg)	Remark
48.36	21.51	-18.49	40	43.77	8.73	0.79	31.78	-	-	Peak
185.25	30.44	-13.06	43.5	51.72	9	1.47	31.75	135	244	Peak
243.3	28.26	-17.74	46	46.54	11.76	1.7	31.74	-	-	Peak
314	29.53	-16.47	46	45.79	13.52	1.95	31.73	-	-	Peak
426	29.34	-16.66	46	42.14	16.8	2.25	31.85	-	-	Peak
664	29.65	-16.35	46	39.4	19.45	2.83	32.03	-	-	Peak
5178	101.51	-	-	90.55	34.48	10.47	33.99	100	6	Average
5178	111.42	-	-	100.46	34.48	10.47	33.99	100	6	Peak
10359	43.54	-30.46	74	56.42	37.17	10.64	60.69	100	0	Peak
15540	49.78	-24.22	74	57.73	39.73	11.79	59.47	100	0	Peak



Test Mode :	802.11a	Temperature :	22~23°C
Test Channel :	36	Relative Humidity :	52~53%
Test Engineer :	Hayden Wu	Polarization :	Vertical
Remark :	1. 5178 MHz is fundamental signal which can be ignored. 2. 10359 MHz is not within a restricted band and satisfies both the average and peak limits of 15.209. 3. Average measurement was not performed if peak level went lower than the average limit.		

Frequency (MHz)	Level (dBμV/m)	Over Limit (dB)	Limit Line (dBμV/m)	Read Level (dBμV)	Antenna Factor (dB)	Cable Loss (dB)	Preamp Factor (dB)	Ant Pos (cm)	Table Pos (deg)	Remark
48.36	29.12	-10.88	40	51.38	8.73	0.79	31.78	145	289	Peak
175.26	25.03	-18.47	43.5	45.7	9.55	1.53	31.75	-	-	Peak
232.5	23.55	-22.45	46	43.07	10.56	1.66	31.74	-	-	Peak
364.4	22.78	-23.22	46	37.6	14.85	2.11	31.78	-	-	Peak
573	24.31	-21.69	46	34.35	19.33	2.65	32.02	-	-	Peak
664	25.64	-20.36	46	35.39	19.45	2.83	32.03	-	-	Peak
5178	92.57	-	-	81.61	34.48	10.47	33.99	100	151	Average
5178	102.72	-	-	91.76	34.48	10.47	33.99	100	151	Peak
10359	43.62	-30.38	74	56.5	37.17	10.64	60.69	100	0	Peak
15540	47.37	-26.63	74	55.32	39.73	11.79	59.47	100	0	Peak



Test Mode :	802.11a	Temperature :	22~23°C
Test Channel :	44	Relative Humidity :	52~53%
Test Engineer :	Hayden Wu	Polarization :	Horizontal
Remark :	<ol style="list-style-type: none"> 5222 MHz is fundamental signal which can be ignored. 10440 MHz is not within a restricted band and satisfies both the average and peak limits of 15.209. Average measurement was not performed if peak level went lower than the average limit. 		

Frequency (MHz)	Level (dBμV/m)	Over Limit (dB)	Limit Line (dBμV/m)	Read Level (dBμV)	Antenna Factor (dB)	Cable Loss (dB)	Preamp Factor (dB)	Ant Pos (cm)	Table Pos (deg)	Remark
5222	102.8	-	-	91.73	34.52	10.54	33.99	117	313	Average
5222	113.83	-	-	102.76	34.52	10.54	33.99	117	313	Peak
10440	43.58	-30.42	74	56.29	37.23	10.65	60.59	100	0	Peak
15660	49.97	-24.03	74	57.7	39.86	11.75	59.34	100	0	Peak

Test Mode :	802.11a	Temperature :	22~23°C
Test Channel :	44	Relative Humidity :	52~53%
Test Engineer :	Hayden Wu	Polarization :	Vertical
Remark :	<ol style="list-style-type: none"> 5218 MHz is fundamental signal which can be ignored. 10440 MHz is not within a restricted band and satisfies both the average and peak limits of 15.209. Average measurement was not performed if peak level went lower than the average limit. 		

Frequency (MHz)	Level (dBμV/m)	Over Limit (dB)	Limit Line (dBμV/m)	Read Level (dBμV)	Antenna Factor (dB)	Cable Loss (dB)	Preamp Factor (dB)	Ant Pos (cm)	Table Pos (deg)	Remark
5218	90.4	-	-	79.33	34.52	10.54	33.99	100	176	Average
5218	100.17	-	-	89.1	34.52	10.54	33.99	100	176	Peak
10440	43.94	-30.06	74	56.65	37.23	10.65	60.59	100	0	Peak
15660	46.93	-27.07	74	54.66	39.86	11.75	59.34	100	0	Peak



Test Mode :	802.11a	Temperature :	22~23°C
Test Channel :	48	Relative Humidity :	52~53%
Test Engineer :	Hayden Wu	Polarization :	Horizontal
Remark :	<ol style="list-style-type: none"> 5238 MHz is fundamental signal which can be ignored. 10479 MHz is not within a restricted band and satisfies both the average and peak limits of 15.209. Average measurement was not performed if peak level went lower than the average limit. 		

Frequency (MHz)	Level (dBμV/m)	Over Limit (dB)	Limit Line (dBμV/m)	Read Level (dBμV)	Antenna Factor (dB)	Cable Loss (dB)	Preamp Factor (dB)	Ant Pos (cm)	Table Pos (deg)	Remark
5238	102.25	-	-	91.13	34.53	10.58	33.99	117	309	Average
5238	111.6	-	-	100.48	34.53	10.58	33.99	117	309	Peak
10479	44.47	-29.53	74	57.05	37.28	10.66	60.52	100	0	Peak
15720	47.86	-26.14	74	55.48	39.92	11.74	59.28	100	0	Peak

Test Mode :	802.11a	Temperature :	22~23°C
Test Channel :	48	Relative Humidity :	52~53%
Test Engineer :	Hayden Wu	Polarization :	Vertical
Remark :	<ol style="list-style-type: none"> 5238 MHz is fundamental signal which can be ignored. 10479 MHz is not within a restricted band and satisfies both the average and peak limits of 15.209. Average measurement was not performed if peak level went lower than the average limit. 		

Frequency (MHz)	Level (dBμV/m)	Over Limit (dB)	Limit Line (dBμV/m)	Read Level (dBμV)	Antenna Factor (dB)	Cable Loss (dB)	Preamp Factor (dB)	Ant Pos (cm)	Table Pos (deg)	Remark
5238	94.49	-	-	83.37	34.53	10.58	33.99	197	17	Average
5238	103.97	-	-	92.85	34.53	10.58	33.99	197	17	Peak
10479	42.4	-31.6	74	54.98	37.28	10.66	60.52	100	0	Peak
15720	46.97	-27.03	74	54.59	39.92	11.74	59.28	100	0	Peak



Test Mode :	802.11a	Temperature :	22~23°C
Test Channel :	52	Relative Humidity :	52~53%
Test Engineer :	Hayden Wu	Polarization :	Horizontal
Remark :	<ol style="list-style-type: none"> 5258 MHz is fundamental signal which can be ignored. 10520 MHz is not within a restricted band and satisfies both the average and peak limits of 15.209. Average measurement was not performed if peak level went lower than the average limit. 		

Frequency (MHz)	Level (dBμV/m)	Over Limit (dB)	Limit Line (dBμV/m)	Read Level (dBμV)	Antenna Factor (dB)	Cable Loss (dB)	Preamp Factor (dB)	Ant Pos (cm)	Table Pos (deg)	Remark
5258	101.27	-	-	90.12	34.55	10.58	33.98	117	298	Average
5258	111.55	-	-	100.4	34.55	10.58	33.98	117	298	Peak
10520	44.96	-29.04	74	57.43	37.31	10.67	60.45	100	0	Peak
15780	46.6	-27.4	74	54.12	39.98	11.72	59.22	100	0	Peak

Test Mode :	802.11a	Temperature :	22~23°C
Test Channel :	52	Relative Humidity :	52~53%
Test Engineer :	Hayden Wu	Polarization :	Vertical
Remark :	<ol style="list-style-type: none"> 5262 MHz is fundamental signal which can be ignored. 10520 MHz is not within a restricted band and satisfies both the average and peak limits of 15.209. Average measurement was not performed if peak level went lower than the average limit. 		

Frequency (MHz)	Level (dBμV/m)	Over Limit (dB)	Limit Line (dBμV/m)	Read Level (dBμV)	Antenna Factor (dB)	Cable Loss (dB)	Preamp Factor (dB)	Ant Pos (cm)	Table Pos (deg)	Remark
5262	90.81	-	-	79.61	34.57	10.61	33.98	100	330	Average
5262	100.48	-	-	89.28	34.57	10.61	33.98	100	330	Peak
10520	44.33	-29.67	74	56.8	37.31	10.67	60.45	100	0	Peak
15780	47.31	-26.69	74	54.83	39.98	11.72	59.22	100	0	Peak



Test Mode :	802.11a	Temperature :	22~23°C
Test Channel :	60	Relative Humidity :	52~53%
Test Engineer :	Hayden Wu	Polarization :	Horizontal
Remark :	1. 5297 MHz is fundamental signal which can be ignored. 2. Average measurement was not performed if peak level went lower than the average limit.		

Frequency (MHz)	Level (dBμV/m)	Over Limit (dB)	Limit Line (dBμV/m)	Read Level (dBμV)	Antenna Factor (dB)	Cable Loss (dB)	Preamp Factor (dB)	Ant Pos (cm)	Table Pos (deg)	Remark
5297	101.22	-	-	89.95	34.6	10.65	33.98	103	9	Average
5297	111.33	-	-	100.06	34.6	10.65	33.98	103	9	Peak
10600	44.74	-29.26	74	56.91	37.36	10.68	60.21	100	0	Peak
15900	45.34	-28.66	74	52.66	40.1	11.68	59.1	100	0	Peak

Test Mode :	802.11a	Temperature :	22~23°C
Test Channel :	60	Relative Humidity :	52~53%
Test Engineer :	Hayden Wu	Polarization :	Vertical
Remark :	1. 5302 MHz is fundamental signal which can be ignored. 2. Average measurement was not performed if peak level went lower than the average limit.		

Frequency (MHz)	Level (dBμV/m)	Over Limit (dB)	Limit Line (dBμV/m)	Read Level (dBμV)	Antenna Factor (dB)	Cable Loss (dB)	Preamp Factor (dB)	Ant Pos (cm)	Table Pos (deg)	Remark
5302	91.4	-	-	80.13	34.6	10.65	33.98	100	349	Average
5302	101.76	-	-	90.49	34.6	10.65	33.98	100	349	Peak
10600	44.95	-29.05	74	57.12	37.36	10.68	60.21	100	0	Peak
15900	46.75	-27.25	74	54.07	40.1	11.68	59.1	100	0	Peak



Test Mode :	802.11a	Temperature :	22~23°C
Test Channel :	64	Relative Humidity :	52~53%
Test Engineer :	Hayden Wu	Polarization :	Horizontal
Remark :	1. 5318 MHz is fundamental signal which can be ignored. 2. Average measurement was not performed if peak level went lower than the average limit.		

Frequency (MHz)	Level (dBμV/m)	Over Limit (dB)	Limit Line (dBμV/m)	Read Level (dBμV)	Antenna Factor (dB)	Cable Loss (dB)	Preamp Factor (dB)	Ant Pos (cm)	Table Pos (deg)	Remark
291.36	35.11	-10.89	46	51.94	13.02	1.87	31.72	-	-	Peak
294.6	36.81	-9.19	46	53.55	13.1	1.88	31.72	112	354	Peak
297.84	34.77	-11.23	46	51.43	13.16	1.9	31.72	-	-	Peak
310.5	34.08	-11.92	46	50.47	13.4	1.94	31.73	-	-	Peak
506.5	30.91	-15.09	46	42.49	17.86	2.5	31.94	-	-	Peak
889.4	25.81	-20.19	46	33.15	20.9	3.34	31.58	-	-	Peak
5318	102.57	-	-	91.25	34.62	10.68	33.98	103	299	Average
5318	112.32	-	-	101	34.62	10.68	33.98	103	299	Peak
10640	44.69	-29.31	74	56.73	37.38	10.69	60.11	100	0	Peak
15960	46.16	-27.84	74	53.36	40.17	11.66	59.03	100	0	Peak



Test Mode :	802.11a	Temperature :	22~23°C
Test Channel :	64	Relative Humidity :	52~53%
Test Engineer :	Hayden Wu	Polarization :	Vertical
Remark :	1. 5318 MHz is fundamental signal which can be ignored. 2. Average measurement was not performed if peak level went lower than the average limit.		

Frequency (MHz)	Level (dBμV/m)	Over Limit (dB)	Limit Line (dBμV/m)	Read Level (dBμV)	Antenna Factor (dB)	Cable Loss (dB)	Preamp Factor (dB)	Ant Pos (cm)	Table Pos (deg)	Remark
31.35	29.5	-10.5	40	42.74	17.9	0.65	31.79	100	285	Peak
100.74	27.37	-16.13	43.5	47.05	10.96	1.11	31.75	-	-	Peak
291.36	26.29	-19.71	46	43.12	13.02	1.87	31.72	-	-	Peak
310.5	26.77	-19.23	46	43.16	13.4	1.94	31.73	-	-	Peak
786.5	23.57	-22.43	46	32.33	20.14	3.06	31.96	-	-	Peak
949.6	26.14	-19.86	46	32.56	21.3	3.35	31.07	-	-	Peak
5318	93.5	-	-	82.18	34.62	10.68	33.98	138	348	Average
5318	104.12	-	-	92.8	34.62	10.68	33.98	138	348	Peak
10640	45.4	-28.6	74	57.44	37.38	10.69	60.11	100	0	Peak
15960	45.94	-28.06	74	53.14	40.17	11.66	59.03	100	0	Peak



Test Mode :	802.11a	Temperature :	22~23°C
Test Channel :	100	Relative Humidity :	52~53%
Test Engineer :	Hayden Wu	Polarization :	Horizontal
Remark :	<ol style="list-style-type: none"> 5498 MHz is fundamental signal which can be ignored. 16500 MHz is not within a restricted band and satisfies both the average and peak limits of 15.209. Average measurement was not performed if peak level went lower than the average limit. 		

Frequency (MHz)	Level (dBμV/m)	Over Limit (dB)	Limit Line (dBμV/m)	Read Level (dBμV)	Antenna Factor (dB)	Cable Loss (dB)	Preamp Factor (dB)	Ant Pos (cm)	Table Pos (deg)	Remark
5498	103.68	-	-	91.93	34.8	10.93	33.98	100	2	Average
5498	113.49	-	-	101.74	34.8	10.93	33.98	100	2	Peak
11000	44.65	-29.35	74	55.39	37.6	10.76	59.1	100	0	Peak
16500	44.67	-29.33	74	50.75	41	11.82	58.9	100	0	Peak

Test Mode :	802.11a	Temperature :	22~23°C
Test Channel :	100	Relative Humidity :	52~53%
Test Engineer :	Hayden Wu	Polarization :	Vertical
Remark :	<ol style="list-style-type: none"> 5498 MHz is fundamental signal which can be ignored. 16500 MHz is not within a restricted band and satisfies both the average and peak limits of 15.209. Average measurement was not performed if peak level went lower than the average limit. 		

Frequency (MHz)	Level (dBμV/m)	Over Limit (dB)	Limit Line (dBμV/m)	Read Level (dBμV)	Antenna Factor (dB)	Cable Loss (dB)	Preamp Factor (dB)	Ant Pos (cm)	Table Pos (deg)	Remark
5498	93.47	-	-	81.72	34.8	10.93	33.98	100	358	Average
5498	102.5	-	-	90.75	34.8	10.93	33.98	100	358	Peak
11000	45.39	-28.61	74	56.13	37.6	10.76	59.1	100	0	Peak
16500	45.29	-28.71	74	51.37	41	11.82	58.9	100	0	Peak



Test Mode :	802.11a	Temperature :	22~23°C
Test Channel :	116	Relative Humidity :	52~53%
Test Engineer :	Hayden Wu	Polarization :	Horizontal
Remark :	<ol style="list-style-type: none"> 5577 MHz is fundamental signal which can be ignored. 16740 MHz is not within a restricted band and satisfies both the average and peak limits of 15.209. Average measurement was not performed if peak level went lower than the average limit. 		

Frequency (MHz)	Level (dBμV/m)	Over Limit (dB)	Limit Line (dBμV/m)	Read Level (dBμV)	Antenna Factor (dB)	Cable Loss (dB)	Preamp Factor (dB)	Ant Pos (cm)	Table Pos (deg)	Remark
5577	103.67	-	-	91.69	34.87	11.09	33.98	110	358	Average
5577	113.41	-	-	101.43	34.87	11.09	33.98	110	358	Peak
11160	45.23	-28.77	74	55.62	37.67	10.84	58.9	100	0	Peak
16740	45.81	-28.19	74	51.42	41.24	11.91	58.76	100	0	Peak

Test Mode :	802.11a	Temperature :	22~23°C
Test Channel :	116	Relative Humidity :	52~53%
Test Engineer :	Hayden Wu	Polarization :	Vertical
Remark :	<ol style="list-style-type: none"> 5582 MHz is fundamental signal which can be ignored. 16740 MHz is not within a restricted band and satisfies both the average and peak limits of 15.209. Average measurement was not performed if peak level went lower than the average limit. 		

Frequency (MHz)	Level (dBμV/m)	Over Limit (dB)	Limit Line (dBμV/m)	Read Level (dBμV)	Antenna Factor (dB)	Cable Loss (dB)	Preamp Factor (dB)	Ant Pos (cm)	Table Pos (deg)	Remark
5582	93.96	-	-	81.97	34.89	11.09	33.99	158	358	Average
5582	104.73	-	-	92.74	34.89	11.09	33.99	158	358	Peak
11160	45.15	-28.85	74	55.54	37.67	10.84	58.9	100	0	Peak
16740	46.52	-27.48	74	52.13	41.24	11.91	58.76	100	0	Peak



Test Mode :	802.11a	Temperature :	22~23°C
Test Channel :	140	Relative Humidity :	52~53%
Test Engineer :	Hayden Wu	Polarization :	Horizontal
Remark :	1. 5698 MHz is fundamental signal which can be ignored. 2. 17100 MHz is not within a restricted band and satisfies both the average and peak limits of 15.209. 3. Average measurement was not performed if peak level went lower than the average limit.		

Frequency (MHz)	Level (dBμV/m)	Over Limit (dB)	Limit Line (dBμV/m)	Read Level (dBμV)	Antenna Factor (dB)	Cable Loss (dB)	Preamp Factor (dB)	Ant Pos (cm)	Table Pos (deg)	Remark
104.25	26.29	-17.21	43.5	45.32	11.6	1.12	31.75	-	-	Peak
214.14	27.83	-15.67	43.5	48.85	9.14	1.59	31.75	-	-	Peak
297.84	32.75	-13.25	46	49.41	13.16	1.9	31.72	-	-	Peak
317.5	34.42	-11.58	46	50.6	13.61	1.95	31.74	112	315	Peak
364.4	32	-14	46	46.82	14.85	2.11	31.78	-	-	Peak
499.5	31.27	-14.73	46	42.93	17.79	2.48	31.93	-	-	Peak
5698	102.63	-	-	90.33	34.99	11.3	33.99	118	3	Average
5698	112.74	-	-	100.44	34.99	11.3	33.99	118	3	Peak
11400	44.43	-29.57	74	54.3	37.76	10.99	58.62	100	0	Peak
17100	45.91	-28.09	74	51.05	41.34	12.12	58.6	100	0	Peak



Test Mode :	802.11a	Temperature :	22~23°C
Test Channel :	140	Relative Humidity :	52~53%
Test Engineer :	Hayden Wu	Polarization :	Vertical
Remark :	1. 5698 MHz is fundamental signal which can be ignored. 2. 17100 MHz is not within a restricted band and satisfies both the average and peak limits of 15.209. 3. Average measurement was not performed if peak level went lower than the average limit.		

Frequency (MHz)	Level (dBμV/m)	Over Limit (dB)	Limit Line (dBμV/m)	Read Level (dBμV)	Antenna Factor (dB)	Cable Loss (dB)	Preamp Factor (dB)	Ant Pos (cm)	Table Pos (deg)	Remark
30.54	33.3	-6.7	40	46.55	17.9	0.65	31.8	100	214	Peak
98.85	29.13	-14.37	43.5	49.12	10.66	1.1	31.75	-	-	Peak
297.84	29.21	-16.79	46	45.87	13.16	1.9	31.72	-	-	Peak
422.5	32.77	-13.23	46	45.56	16.8	2.25	31.84	-	-	Peak
454	33.79	-12.21	46	46.33	17.02	2.32	31.88	-	-	Peak
713	26.11	-19.89	46	35.6	19.59	2.93	32.01	-	-	Peak
5698	91.93	-	-	79.63	34.99	11.3	33.99	100	182	Average
5698	101.29	-	-	88.99	34.99	11.3	33.99	100	182	Peak
11400	44.21	-29.79	74	54.08	37.76	10.99	58.62	100	0	Peak
17100	46.28	-27.72	74	51.42	41.34	12.12	58.6	100	0	Peak



Test Mode :	802.11n HT20	Temperature :	22~23°C
Test Channel :	36	Relative Humidity :	52~53%
Test Engineer :	Hayden Wu	Polarization :	Horizontal
Remark :	1. 5182 MHz is fundamental signal which can be ignored. 2. 10359 MHz is not within a restricted band and satisfies both the average and peak limits of 15.209. 3. Average measurement was not performed if peak level went lower than the average limit.		

Frequency (MHz)	Level (dBμV/m)	Over Limit (dB)	Limit Line (dBμV/m)	Read Level (dBμV)	Antenna Factor (dB)	Cable Loss (dB)	Preamp Factor (dB)	Ant Pos (cm)	Table Pos (deg)	Remark
48.36	20.06	-19.94	40	42.32	8.73	0.79	31.78	-	-	Peak
180.66	30.66	-12.84	43.5	51.66	9.3	1.45	31.75	100	235	Peak
260.85	28.61	-17.39	46	44.74	13.81	1.79	31.73	-	-	Peak
426	28.45	-17.55	46	41.25	16.8	2.25	31.85	-	-	Peak
665.4	26.14	-19.86	46	35.89	19.45	2.83	32.03	-	-	Peak
959.4	25.59	-20.41	46	31.83	21.39	3.35	30.98	-	-	Peak
5182	102.88	-	-	91.92	34.48	10.47	33.99	120	314	Average
5182	112.65	-	-	101.69	34.48	10.47	33.99	120	314	Peak
10359	43.36	-30.64	74	56.24	37.17	10.64	60.69	100	0	Peak
15540	46.99	-27.01	74	54.94	39.73	11.79	59.47	100	0	Peak



Test Mode :	802.11n HT20	Temperature :	22~23°C
Test Channel :	36	Relative Humidity :	52~53%
Test Engineer :	Hayden Wu	Polarization :	Vertical
Remark :	1. 5178 MHz is fundamental signal which can be ignored. 2. 10359 MHz is not within a restricted band and satisfies both the average and peak limits of 15.209. 3. Average measurement was not performed if peak level went lower than the average limit.		

Frequency (MHz)	Level (dBμV/m)	Over Limit (dB)	Limit Line (dBμV/m)	Read Level (dBμV)	Antenna Factor (dB)	Cable Loss (dB)	Preamp Factor (dB)	Ant Pos (cm)	Table Pos (deg)	Remark
48.36	28.26	-11.74	40	50.52	8.73	0.79	31.78	102	235	Peak
152.85	25.84	-17.66	43.5	45.81	10.4	1.38	31.75	-	-	Peak
260.04	24.8	-21.2	46	40.84	13.9	1.79	31.73	-	-	Peak
426	24.68	-21.32	46	37.48	16.8	2.25	31.85	-	-	Peak
664	27.3	-18.7	46	37.05	19.45	2.83	32.03	-	-	Peak
947.5	25.34	-20.66	46	31.78	21.3	3.35	31.09	-	-	Peak
5178	94.34	-	-	83.38	34.48	10.47	33.99	200	124	Average
5178	104.46	-	-	93.5	34.48	10.47	33.99	200	124	Peak
10359	43.87	-30.13	74	56.75	37.17	10.64	60.69	100	0	Peak
15540	47.3	-26.7	74	55.25	39.73	11.79	59.47	100	0	Peak



Test Mode :	802.11n HT20	Temperature :	22~23°C
Test Channel :	44	Relative Humidity :	52~53%
Test Engineer :	Hayden Wu	Polarization :	Horizontal
Remark :	<ol style="list-style-type: none"> 5222 MHz is fundamental signal which can be ignored. 10440 MHz is not within a restricted band and satisfies both the average and peak limits of 15.209. Average measurement was not performed if peak level went lower than the average limit. 		

Frequency (MHz)	Level (dBμV/m)	Over Limit (dB)	Limit Line (dBμV/m)	Read Level (dBμV)	Antenna Factor (dB)	Cable Loss (dB)	Preamp Factor (dB)	Ant Pos (cm)	Table Pos (deg)	Remark
5222	103.49	-	-	92.42	34.52	10.54	33.99	117	312	Average
5222	113.86	-	-	102.79	34.52	10.54	33.99	117	312	Peak
10440	44.08	-29.92	74	56.79	37.23	10.65	60.59	100	0	Peak
15660	46.93	-27.07	74	54.66	39.86	11.75	59.34	100	0	Peak

Test Mode :	802.11n HT20	Temperature :	22~23°C
Test Channel :	44	Relative Humidity :	52~53%
Test Engineer :	Hayden Wu	Polarization :	Vertical
Remark :	<ol style="list-style-type: none"> 5218 MHz is fundamental signal which can be ignored. 10440 MHz is not within a restricted band and satisfies both the average and peak limits of 15.209. Average measurement was not performed if peak level went lower than the average limit. 		

Frequency (MHz)	Level (dBμV/m)	Over Limit (dB)	Limit Line (dBμV/m)	Read Level (dBμV)	Antenna Factor (dB)	Cable Loss (dB)	Preamp Factor (dB)	Ant Pos (cm)	Table Pos (deg)	Remark
5218	90.57	-	-	79.5	34.52	10.54	33.99	100	303	Average
5218	100.2	-	-	89.13	34.52	10.54	33.99	100	303	Peak
10440	43.94	-30.06	74	56.65	37.23	10.65	60.59	100	0	Peak
15660	47.37	-26.63	74	55.1	39.86	11.75	59.34	100	0	Peak



Test Mode :	802.11n HT20	Temperature :	22~23°C
Test Channel :	48	Relative Humidity :	52~53%
Test Engineer :	Hayden Wu	Polarization :	Horizontal
Remark :	<ol style="list-style-type: none"> 5242 MHz is fundamental signal which can be ignored. 10479 MHz is not within a restricted band and satisfies both the average and peak limits of 15.209. Average measurement was not performed if peak level went lower than the average limit. 		

Frequency (MHz)	Level (dBμV/m)	Over Limit (dB)	Limit Line (dBμV/m)	Read Level (dBμV)	Antenna Factor (dB)	Cable Loss (dB)	Preamp Factor (dB)	Ant Pos (cm)	Table Pos (deg)	Remark
5242	102.74	-	-	91.6	34.55	10.58	33.99	117	313	Average
5242	112.69	-	-	101.55	34.55	10.58	33.99	117	313	Peak
10479	45.37	-28.63	74	57.95	37.28	10.66	60.52	100	0	Peak
15720	46.6	-27.4	74	54.22	39.92	11.74	59.28	100	0	Peak

Test Mode :	802.11n HT20	Temperature :	22~23°C
Test Channel :	48	Relative Humidity :	52~53%
Test Engineer :	Hayden Wu	Polarization :	Vertical
Remark :	<ol style="list-style-type: none"> 5238 MHz is fundamental signal which can be ignored. 10479 MHz is not within a restricted band and satisfies both the average and peak limits of 15.209. Average measurement was not performed if peak level went lower than the average limit. 		

Frequency (MHz)	Level (dBμV/m)	Over Limit (dB)	Limit Line (dBμV/m)	Read Level (dBμV)	Antenna Factor (dB)	Cable Loss (dB)	Preamp Factor (dB)	Ant Pos (cm)	Table Pos (deg)	Remark
5238	94.3	-	-	83.18	34.53	10.58	33.99	197	0	Average
5238	103.88	-	-	92.76	34.53	10.58	33.99	197	0	Peak
10479	45.09	-28.91	74	57.67	37.28	10.66	60.52	100	0	Peak
15720	47.31	-26.69	74	54.93	39.92	11.74	59.28	100	0	Peak



Test Mode :	802.11n HT20	Temperature :	22~23°C
Test Channel :	52	Relative Humidity :	52~53%
Test Engineer :	Hayden Wu	Polarization :	Horizontal
Remark :	<ol style="list-style-type: none"> 5262 MHz is fundamental signal which can be ignored. 10521 MHz is not within a restricted band and satisfies both the average and peak limits of 15.209. Average measurement was not performed if peak level went lower than the average limit. 		

Frequency (MHz)	Level (dBμV/m)	Over Limit (dB)	Limit Line (dBμV/m)	Read Level (dBμV)	Antenna Factor (dB)	Cable Loss (dB)	Preamp Factor (dB)	Ant Pos (cm)	Table Pos (deg)	Remark
5262	104.1	-	-	92.95	34.55	10.58	33.98	107	309	Average
5262	114.03	-	-	102.88	34.55	10.58	33.98	107	309	Peak
10521	44.2	-29.8	74	56.67	37.31	10.67	60.45	100	0	Peak
15780	46.24	-27.76	74	53.76	39.98	11.72	59.22	100	0	Peak

Test Mode :	802.11n HT20	Temperature :	22~23°C
Test Channel :	52	Relative Humidity :	52~53%
Test Engineer :	Hayden Wu	Polarization :	Vertical
Remark :	<ol style="list-style-type: none"> 5258 MHz is fundamental signal which can be ignored. 10521 MHz is not within a restricted band and satisfies both the average and peak limits of 15.209. Average measurement was not performed if peak level went lower than the average limit. 		

Frequency (MHz)	Level (dBμV/m)	Over Limit (dB)	Limit Line (dBμV/m)	Read Level (dBμV)	Antenna Factor (dB)	Cable Loss (dB)	Preamp Factor (dB)	Ant Pos (cm)	Table Pos (deg)	Remark
5258	93.15	-	-	82	34.55	10.58	33.98	100	143	Average
5258	102.94	-	-	91.79	34.55	10.58	33.98	100	143	Peak
10521	44.83	-29.17	74	57.3	37.31	10.67	60.45	100	0	Peak
15780	45.95	-28.05	74	53.47	39.98	11.72	59.22	100	0	Peak



Test Mode :	802.11n HT20	Temperature :	22~23°C
Test Channel :	60	Relative Humidity :	52~53%
Test Engineer :	Hayden Wu	Polarization :	Horizontal
Remark :	<ol style="list-style-type: none"> 5298 MHz is fundamental signal which can be ignored. 10599 MHz is not within a restricted band and satisfies both the average and peak limits of 15.209. Average measurement was not performed if peak level went lower than the average limit. 		

Frequency (MHz)	Level (dBμV/m)	Over Limit (dB)	Limit Line (dBμV/m)	Read Level (dBμV)	Antenna Factor (dB)	Cable Loss (dB)	Preamp Factor (dB)	Ant Pos (cm)	Table Pos (deg)	Remark
5298	104.16	-	-	92.89	34.6	10.65	33.98	106	311	Average
5298	114.09	-	-	102.82	34.6	10.65	33.98	106	311	Peak
10599	45.28	-28.72	74	57.45	37.36	10.68	60.21	100	0	Peak
15900	45.3	-28.7	74	52.62	40.1	11.68	59.1	100	0	Peak

Test Mode :	802.11n HT20	Temperature :	22~23°C
Test Channel :	60	Relative Humidity :	52~53%
Test Engineer :	Hayden Wu	Polarization :	Vertical
Remark :	<ol style="list-style-type: none"> 5302 MHz is fundamental signal which can be ignored. 10599 MHz is not within a restricted band and satisfies both the average and peak limits of 15.209. Average measurement was not performed if peak level went lower than the average limit. 		

Frequency (MHz)	Level (dBμV/m)	Over Limit (dB)	Limit Line (dBμV/m)	Read Level (dBμV)	Antenna Factor (dB)	Cable Loss (dB)	Preamp Factor (dB)	Ant Pos (cm)	Table Pos (deg)	Remark
5302	94.04	-	-	82.77	34.6	10.65	33.98	176	54	Average
5302	103.8	-	-	92.53	34.6	10.65	33.98	176	54	Peak
10599	45.14	-28.86	74	57.31	37.36	10.68	60.21	100	0	Peak
15900	45.9	-28.1	74	53.22	40.1	11.68	59.1	100	0	Peak



Test Mode :	802.11n HT20	Temperature :	22~23°C
Test Channel :	64	Relative Humidity :	52~53%
Test Engineer :	Hayden Wu	Polarization :	Horizontal
Remark :	1. 5318 MHz is fundamental signal which can be ignored. 2. Average measurement was not performed if peak level went lower than the average limit.		

Frequency (MHz)	Level (dBμV/m)	Over Limit (dB)	Limit Line (dBμV/m)	Read Level (dBμV)	Antenna Factor (dB)	Cable Loss (dB)	Preamp Factor (dB)	Ant Pos (cm)	Table Pos (deg)	Remark
104.25	26.29	-17.21	43.5	45.32	11.6	1.12	31.75	-	-	Peak
294.6	31.57	-14.43	46	48.31	13.1	1.88	31.72	-	-	Peak
297.84	32.75	-13.25	46	49.41	13.16	1.9	31.72	112	358	Peak
364.4	32	-14	46	46.82	14.85	2.11	31.78	-	-	Peak
499.5	31.27	-14.73	46	42.93	17.79	2.48	31.93	-	-	Peak
924.4	25.03	-20.97	46	31.84	21.14	3.36	31.31	-	-	Peak
5318	103.77	-	-	92.45	34.62	10.68	33.98	105	310	Average
5318	113.68	-	-	102.36	34.62	10.68	33.98	105	310	Peak
10641	45.07	-28.93	74	57.11	37.38	10.69	60.11	100	0	Peak
15960	44.86	-29.14	74	52.06	40.17	11.66	59.03	100	0	Peak



Test Mode :	802.11n HT20	Temperature :	22~23°C
Test Channel :	64	Relative Humidity :	52~53%
Test Engineer :	Hayden Wu	Polarization :	Vertical
Remark :	1. 5322 MHz is fundamental signal which can be ignored. 2. Average measurement was not performed if peak level went lower than the average limit.		

Frequency (MHz)	Level (dBμV/m)	Over Limit (dB)	Limit Line (dBμV/m)	Read Level (dBμV)	Antenna Factor (dB)	Cable Loss (dB)	Preamp Factor (dB)	Ant Pos (cm)	Table Pos (deg)	Remark
30.81	34.01	-5.99	40	47.25	17.9	0.65	31.79	100	235	Peak
44.04	28.89	-11.11	40	49.65	10.26	0.76	31.78	-	-	Peak
287.85	28.17	-17.83	46	45.07	12.96	1.86	31.72	-	-	Peak
499.5	33.94	-12.06	46	45.6	17.79	2.48	31.93	-	-	Peak
713	26.11	-19.89	46	35.6	19.59	2.93	32.01	-	-	Peak
940.5	25.39	-20.61	46	31.9	21.3	3.35	31.16	-	-	Peak
5322	93.61	-	-	82.29	34.62	10.68	33.98	176	40	Average
5322	103.75	-	-	92.43	34.62	10.68	33.98	176	40	Peak
10641	44.7	-29.3	74	56.74	37.38	10.69	60.11	100	0	Peak
15960	44.91	-29.09	74	52.11	40.17	11.66	59.03	100	0	Peak



Test Mode :	802.11n HT20	Temperature :	22~23°C
Test Channel :	100	Relative Humidity :	52~53%
Test Engineer :	Hayden Wu	Polarization :	Horizontal
Remark :	1. 5498 MHz is fundamental signal which can be ignored. 2. 16500 MHz is not within a restricted band and satisfies both the average and peak limits of 15.209. 3. Average measurement was not performed if peak level went lower than the average limit.		

Frequency (MHz)	Level (dBμV/m)	Over Limit (dB)	Limit Line (dBμV/m)	Read Level (dBμV)	Antenna Factor (dB)	Cable Loss (dB)	Preamp Factor (dB)	Ant Pos (cm)	Table Pos (deg)	Remark
97.77	22.53	-20.97	43.5	42.67	10.52	1.09	31.75	-	-	Peak
214.14	27.83	-15.67	43.5	48.85	9.14	1.59	31.75	-	-	Peak
297.84	32.75	-13.25	46	49.41	13.16	1.9	31.72	-	-	Peak
317.5	34.42	-11.58	46	50.6	13.61	1.95	31.74	100	325	Peak
499.5	31.27	-14.73	46	42.93	17.79	2.48	31.93	-	-	Peak
924.4	25.03	-20.97	46	31.84	21.14	3.36	31.31	-	-	Peak
5498	104.85	-	-	93.1	34.8	10.93	33.98	101	296	Average
5498	114.97	-	-	103.22	34.8	10.93	33.98	101	296	Peak
11001	45.86	-28.14	74	56.6	37.6	10.76	59.1	100	0	Peak
16500	43.55	-30.45	74	49.63	41	11.82	58.9	100	0	Peak



Test Mode :	802.11n HT20	Temperature :	22~23°C
Test Channel :	100	Relative Humidity :	52~53%
Test Engineer :	Hayden Wu	Polarization :	Vertical
Remark :	1. 5502 MHz is fundamental signal which can be ignored. 2. 16500 MHz is not within a restricted band and satisfies both the average and peak limits of 15.209. 3. Average measurement was not performed if peak level went lower than the average limit.		

Frequency (MHz)	Level (dBμV/m)	Over Limit (dB)	Limit Line (dBμV/m)	Read Level (dBμV)	Antenna Factor (dB)	Cable Loss (dB)	Preamp Factor (dB)	Ant Pos (cm)	Table Pos (deg)	Remark
30	33.45	-6.55	40	46.11	18.5	0.64	31.8	100	248	Peak
98.85	29.13	-14.37	43.5	49.12	10.66	1.1	31.75	-	-	Peak
297.84	29.21	-16.79	46	45.87	13.16	1.9	31.72	-	-	Peak
307	31.23	-14.77	46	47.68	13.35	1.93	31.73	-	-	Peak
713	26.11	-19.89	46	35.6	19.59	2.93	32.01	-	-	Peak
924.4	24.74	-21.26	46	31.55	21.14	3.36	31.31	-	-	Peak
5502	95.26	-	-	83.48	34.8	10.96	33.98	100	350	Average
5502	105.72	-	-	93.94	34.8	10.96	33.98	100	350	Peak
11001	46.36	-27.64	74	57.1	37.6	10.76	59.1	100	0	Peak
16500	44.38	-29.62	74	50.46	41	11.82	58.9	100	0	Peak



Test Mode :	802.11n HT20	Temperature :	22~23°C
Test Channel :	116	Relative Humidity :	52~53%
Test Engineer :	Hayden Wu	Polarization :	Horizontal
Remark :	1. 5582 MHz is fundamental signal which can be ignored. 2. 16740 MHz is not within a restricted band and satisfies both the average and peak limits of 15.209. 3. Average measurement was not performed if peak level went lower than the average limit.		

Frequency (MHz)	Level (dBμV/m)	Over Limit (dB)	Limit Line (dBμV/m)	Read Level (dBμV)	Antenna Factor (dB)	Cable Loss (dB)	Preamp Factor (dB)	Ant Pos (cm)	Table Pos (deg)	Remark
5582	105.19	-	-	93.21	34.87	11.09	33.98	100	1	Average
5582	115.47	-	-	103.49	34.87	11.09	33.98	100	1	Peak
11160	44.35	-29.65	74	54.74	37.67	10.84	58.9	100	0	Peak
16740	44.09	-29.91	74	49.7	41.24	11.91	58.76	100	0	Peak

Test Mode :	802.11n HT20	Temperature :	22~23°C
Test Channel :	116	Relative Humidity :	52~53%
Test Engineer :	Hayden Wu	Polarization :	Vertical
Remark :	1. 5578 MHz is fundamental signal which can be ignored. 2. 16740 MHz is not within a restricted band and satisfies both the average and peak limits of 15.209. 3. Average measurement was not performed if peak level went lower than the average limit.		

Frequency (MHz)	Level (dBμV/m)	Over Limit (dB)	Limit Line (dBμV/m)	Read Level (dBμV)	Antenna Factor (dB)	Cable Loss (dB)	Preamp Factor (dB)	Ant Pos (cm)	Table Pos (deg)	Remark
5578	96.79	-	-	84.85	34.87	11.05	33.98	100	349	Average
5578	107.22	-	-	95.28	34.87	11.05	33.98	100	349	Peak
11160	44.9	-29.1	74	55.29	37.67	10.84	58.9	100	0	Peak
16740	44.38	-29.62	74	49.99	41.24	11.91	58.76	100	0	Peak



Test Mode :	802.11n HT20	Temperature :	22~23°C
Test Channel :	140	Relative Humidity :	52~53%
Test Engineer :	Hayden Wu	Polarization :	Horizontal
Remark :	<ol style="list-style-type: none"> 5702 MHz is fundamental signal which can be ignored. 17100 MHz is not within a restricted band and satisfies both the average and peak limits of 15.209. Average measurement was not performed if peak level went lower than the average limit. 		

Frequency (MHz)	Level (dBμV/m)	Over Limit (dB)	Limit Line (dBμV/m)	Read Level (dBμV)	Antenna Factor (dB)	Cable Loss (dB)	Preamp Factor (dB)	Ant Pos (cm)	Table Pos (deg)	Remark
5702	102.97	-	-	90.65	35.01	11.3	33.99	108	358	Average
5702	113.25	-	-	100.93	35.01	11.3	33.99	108	358	Peak
11400	44.23	-29.77	74	54.1	37.76	10.99	58.62	100	0	Peak
17100	46.15	-27.85	74	51.29	41.34	12.12	58.6	100	0	Peak

Test Mode :	802.11n HT20	Temperature :	22~23°C
Test Channel :	140	Relative Humidity :	52~53%
Test Engineer :	Hayden Wu	Polarization :	Vertical
Remark :	<ol style="list-style-type: none"> 5702 MHz is fundamental signal which can be ignored. 17100 MHz is not within a restricted band and satisfies both the average and peak limits of 15.209. Average measurement was not performed if peak level went lower than the average limit. 		

Frequency (MHz)	Level (dBμV/m)	Over Limit (dB)	Limit Line (dBμV/m)	Read Level (dBμV)	Antenna Factor (dB)	Cable Loss (dB)	Preamp Factor (dB)	Ant Pos (cm)	Table Pos (deg)	Remark
5702	91.74	-	-	79.44	34.99	11.3	33.99	143	180	Average
5702	101.49	-	-	89.19	34.99	11.3	33.99	143	180	Peak
11400	44.42	-29.58	74	54.29	37.76	10.99	58.62	100	0	Peak
17100	45.07	-28.93	74	50.21	41.34	12.12	58.6	100	0	Peak



Test Mode :	802.11n HT40	Temperature :	22~23°C
Test Channel :	38	Relative Humidity :	52~53%
Test Engineer :	Hayden Wu	Polarization :	Horizontal
Remark :	1. 5188 MHz is fundamental signal which can be ignored. 2. 10380 MHz is not within a restricted band and satisfies both the average and peak limits of 15.209. 3. Average measurement was not performed if peak level went lower than the average limit.		

Frequency (MHz)	Level (dBμV/m)	Over Limit (dB)	Limit Line (dBμV/m)	Read Level (dBμV)	Antenna Factor (dB)	Cable Loss (dB)	Preamp Factor (dB)	Ant Pos (cm)	Table Pos (deg)	Remark
48.36	26.02	-13.98	40	48.28	8.73	0.79	31.78	-	-	Peak
181.74	35.04	-8.46	43.5	56.1	9.24	1.45	31.75	110	237	Peak
275.16	30.39	-15.61	46	47.4	12.89	1.83	31.73	-	-	Peak
441.4	31.38	-14.62	46	44.15	16.81	2.29	31.87	-	-	Peak
665.4	25.71	-20.29	46	35.46	19.45	2.83	32.03	-	-	Peak
956.6	25.65	-20.35	46	31.94	21.36	3.35	31	-	-	Peak
5188	98.77	-	-	87.81	34.48	10.47	33.99	132	314	Average
5188	107.94	-	-	96.98	34.48	10.47	33.99	132	314	Peak
10380	43.89	-30.11	74	43.89	0	0	0	100	0	Peak
15570	47	-27	74	47	0	0	0	100	0	Peak



Test Mode :	802.11n HT40	Temperature :	22~23°C
Test Channel :	38	Relative Humidity :	52~53%
Test Engineer :	Hayden Wu	Polarization :	Vertical
Remark :	1. 5188 MHz is fundamental signal which can be ignored. 2. 10380 MHz is not within a restricted band and satisfies both the average and peak limits of 15.209. 3. Average measurement was not performed if peak level went lower than the average limit.		

Frequency (MHz)	Level (dBμV/m)	Over Limit (dB)	Limit Line (dBμV/m)	Read Level (dBμV)	Antenna Factor (dB)	Cable Loss (dB)	Preamp Factor (dB)	Ant Pos (cm)	Table Pos (deg)	Remark
46.74	32.32	-7.68	40	54.16	9.17	0.77	31.78	105	215	Peak
184.44	27.47	-16.03	43.5	48.7	9.06	1.46	31.75	-	-	Peak
248.16	24.93	-21.07	46	42.73	12.22	1.72	31.74	-	-	Peak
448.4	26.46	-19.54	46	39.14	16.88	2.31	31.87	-	-	Peak
665.4	27.5	-18.5	46	37.25	19.45	2.83	32.03	-	-	Peak
888	25	-21	46	32.34	20.9	3.34	31.58	-	-	Peak
5188	89.14	-	-	78.18	34.48	10.47	33.99	200	122	Average
5188	99.1	-	-	88.14	34.48	10.47	33.99	200	122	Peak
10380	44.44	-29.56	74	44.44	0	0	0	100	0	Peak
15570	47.31	-26.69	74	47.31	0	0	0	100	0	Peak



Test Mode :	802.11n HT40	Temperature :	22~23°C
Test Channel :	46	Relative Humidity :	52~53%
Test Engineer :	Hayden Wu	Polarization :	Horizontal
Remark :	1. 5232 MHz is fundamental signal which can be ignored. 2. 10461 MHz is not within a restricted band and satisfies both the average and peak limits of 15.209. 3. Average measurement was not performed if peak level went lower than the average limit.		

Frequency (MHz)	Level (dBμV/m)	Over Limit (dB)	Limit Line (dBμV/m)	Read Level (dBμV)	Antenna Factor (dB)	Cable Loss (dB)	Preamp Factor (dB)	Ant Pos (cm)	Table Pos (deg)	Remark
5232	100.29	-	-	89.21	34.53	10.54	33.99	105	307	Average
5232	110.86	-	-	99.78	34.53	10.54	33.99	105	307	Peak
10461	44.12	-29.88	74	56.74	37.27	10.66	60.55	100	0	Peak
15690	46.65	-27.35	74	54.32	39.89	11.75	59.31	100	0	Peak

Test Mode :	802.11n HT40	Temperature :	22~23°C
Test Channel :	46	Relative Humidity :	52~53%
Test Engineer :	Hayden Wu	Polarization :	Vertical
Remark :	1. 5232 MHz is fundamental signal which can be ignored. 2. 10461 MHz is not within a restricted band and satisfies both the average and peak limits of 15.209. 3. Average measurement was not performed if peak level went lower than the average limit.		

Frequency (MHz)	Level (dBμV/m)	Over Limit (dB)	Limit Line (dBμV/m)	Read Level (dBμV)	Antenna Factor (dB)	Cable Loss (dB)	Preamp Factor (dB)	Ant Pos (cm)	Table Pos (deg)	Remark
5232	91.84	-	-	80.76	34.53	10.54	33.99	196	12	Average
5232	101.4	-	-	90.32	34.53	10.54	33.99	196	12	Peak
10461	44.21	-29.79	74	56.83	37.27	10.66	60.55	100	0	Peak
15690	46.78	-27.22	74	54.45	39.89	11.75	59.31	100	0	Peak



Test Mode :	802.11n HT40	Temperature :	22~23°C
Test Channel :	54	Relative Humidity :	52~53%
Test Engineer :	Hayden Wu	Polarization :	Horizontal
Remark :	1. 5272 MHz is fundamental signal which can be ignored. 2. 10539 MHz is not within a restricted band and satisfies both the average and peak limits of 15.209. 3. Average measurement was not performed if peak level went lower than the average limit.		

Frequency (MHz)	Level (dBμV/m)	Over Limit (dB)	Limit Line (dBμV/m)	Read Level (dBμV)	Antenna Factor (dB)	Cable Loss (dB)	Preamp Factor (dB)	Ant Pos (cm)	Table Pos (deg)	Remark
5272	101.61	-	-	90.41	34.57	10.61	33.98	107	309	Average
5272	111.39	-	-	100.19	34.57	10.61	33.98	107	309	Peak
10539	44.8	-29.2	74	57.21	37.32	10.67	60.4	100	0	Peak
15810	45.25	-28.75	74	52.72	40.01	11.71	59.19	100	0	Peak

Test Mode :	802.11n HT40	Temperature :	22~23°C
Test Channel :	54	Relative Humidity :	52~53%
Test Engineer :	Hayden Wu	Polarization :	Vertical
Remark :	1. 5272 MHz is fundamental signal which can be ignored. 2. 10539 MHz is not within a restricted band and satisfies both the average and peak limits of 15.209. 3. Average measurement was not performed if peak level went lower than the average limit.		

Frequency (MHz)	Level (dBμV/m)	Over Limit (dB)	Limit Line (dBμV/m)	Read Level (dBμV)	Antenna Factor (dB)	Cable Loss (dB)	Preamp Factor (dB)	Ant Pos (cm)	Table Pos (deg)	Remark
5272	91.9	-	-	80.7	34.57	10.61	33.98	119	154	Average
5272	101.9	-	-	90.7	34.57	10.61	33.98	119	154	Peak
10539	44.29	-29.71	74	56.7	37.32	10.67	60.4	100	0	Peak
15810	45.85	-28.15	74	53.32	40.01	11.71	59.19	100	0	Peak



Test Mode :	802.11n HT40	Temperature :	22~23°C
Test Channel :	62	Relative Humidity :	52~53%
Test Engineer :	Hayden Wu	Polarization :	Horizontal
Remark :	1. 5312 MHz is fundamental signal which can be ignored. 2. Average measurement was not performed if peak level went lower than the average limit.		

Frequency (MHz)	Level (dBμV/m)	Over Limit (dB)	Limit Line (dBμV/m)	Read Level (dBμV)	Antenna Factor (dB)	Cable Loss (dB)	Preamp Factor (dB)	Ant Pos (cm)	Table Pos (deg)	Remark
211.44	28.78	-14.72	43.5	49.84	9.11	1.58	31.75	-	-	Peak
291.36	32.04	-13.96	46	48.87	13.02	1.87	31.72	-	-	Peak
297.84	33.07	-12.93	46	49.73	13.16	1.9	31.72	100	142	Peak
375.6	31.74	-14.26	46	46.42	15	2.12	31.8	-	-	Peak
531	27.42	-18.58	46	38.5	18.37	2.52	31.97	-	-	Peak
763.4	24.52	-21.48	46	33.28	20.17	3.05	31.98	-	-	Peak
5312	100	-	-	88.68	34.62	10.68	33.98	106	308	Average
5312	110.85	-	-	99.53	34.62	10.68	33.98	106	308	Peak
10620	44.35	-29.65	74	56.45	37.37	10.69	60.16	100	0	Peak
15930	45.93	-28.07	74	53.2	40.13	11.67	59.07	100	0	Peak



Test Mode :	802.11n HT40	Temperature :	22~23°C
Test Channel :	62	Relative Humidity :	52~53%
Test Engineer :	Hayden Wu	Polarization :	Vertical
Remark :	1. 5312 MHz is fundamental signal which can be ignored. 2. Average measurement was not performed if peak level went lower than the average limit.		

Frequency (MHz)	Level (dBμV/m)	Over Limit (dB)	Limit Line (dBμV/m)	Read Level (dBμV)	Antenna Factor (dB)	Cable Loss (dB)	Preamp Factor (dB)	Ant Pos (cm)	Table Pos (deg)	Remark
30	30.81	-9.19	40	43.47	18.5	0.64	31.8	100	198	Peak
44.85	27.54	-12.46	40	48.96	9.6	0.76	31.78	-	-	Peak
294.6	29.05	-16.95	46	45.79	13.1	1.88	31.72	-	-	Peak
307	30.57	-15.43	46	47.02	13.35	1.93	31.73	-	-	Peak
387.5	28.63	-17.37	46	42.87	15.42	2.15	31.81	-	-	Peak
522.6	31.32	-14.68	46	42.68	18.09	2.51	31.96	-	-	Peak
5312	90.72	-	-	79.4	34.62	10.68	33.98	165	7	Average
5312	100.41	-	-	89.09	34.62	10.68	33.98	165	7	Peak
10620	44.9	-29.1	74	57	37.37	10.69	60.16	100	0	Peak
15930	45.76	-28.24	74	53.03	40.13	11.67	59.07	100	0	Peak



Test Mode :	802.11n HT40	Temperature :	22~23°C
Test Channel :	102	Relative Humidity :	52~53%
Test Engineer :	Hayden Wu	Polarization :	Horizontal
Remark :	<ol style="list-style-type: none"> 5512 MHz is fundamental signal which can be ignored. 16530 MHz is not within a restricted band and satisfies both the average and peak limits of 15.209. Average measurement was not performed if peak level went lower than the average limit. 		

Frequency (MHz)	Level (dBμV/m)	Over Limit (dB)	Limit Line (dBμV/m)	Read Level (dBμV)	Antenna Factor (dB)	Cable Loss (dB)	Preamp Factor (dB)	Ant Pos (cm)	Table Pos (deg)	Remark
5512	100.63	-	-	88.85	34.8	10.96	33.98	100	359	Average
5512	110.58	-	-	98.8	34.8	10.96	33.98	100	359	Peak
11019	45.29	-28.71	74	56	37.61	10.76	59.08	100	0	Peak
16530	46.36	-27.64	74	52.38	41.03	11.83	58.88	100	0	Peak

Test Mode :	802.11n HT40	Temperature :	22~23°C
Test Channel :	102	Relative Humidity :	52~53%
Test Engineer :	Hayden Wu	Polarization :	Vertical
Remark :	<ol style="list-style-type: none"> 5512 MHz is fundamental signal which can be ignored. 16530 MHz is not within a restricted band and satisfies both the average and peak limits of 15.209. Average measurement was not performed if peak level went lower than the average limit. 		

Frequency (MHz)	Level (dBμV/m)	Over Limit (dB)	Limit Line (dBμV/m)	Read Level (dBμV)	Antenna Factor (dB)	Cable Loss (dB)	Preamp Factor (dB)	Ant Pos (cm)	Table Pos (deg)	Remark
5512	90.96	-	-	79.18	34.8	10.96	33.98	100	351	Average
5512	100.6	-	-	88.82	34.8	10.96	33.98	100	351	Peak
11019	44.86	-29.14	74	55.57	37.61	10.76	59.08	100	0	Peak
16530	46.13	-27.87	74	52.15	41.03	11.83	58.88	100	0	Peak



Test Mode :	802.11n HT40	Temperature :	22~23°C
Test Channel :	110	Relative Humidity :	52~53%
Test Engineer :	Hayden Wu	Polarization :	Horizontal
Remark :	<ol style="list-style-type: none"> 5548 MHz is fundamental signal which can be ignored. 16650 MHz is not within a restricted band and satisfies both the average and peak limits of 15.209. Average measurement was not performed if peak level went lower than the average limit. 		

Frequency (MHz)	Level (dBμV/m)	Over Limit (dB)	Limit Line (dBμV/m)	Read Level (dBμV)	Antenna Factor (dB)	Cable Loss (dB)	Preamp Factor (dB)	Ant Pos (cm)	Table Pos (deg)	Remark
5548	103.29	-	-	91.37	34.85	11.05	33.98	100	0	Average
5548	112.63	-	-	100.71	34.85	11.05	33.98	100	0	Peak
11100	45.61	-28.39	74	56.13	37.64	10.82	58.98	100	0	Peak
16650	44.87	-29.13	74	50.64	41.16	11.88	58.81	100	0	Peak

Test Mode :	802.11n HT40	Temperature :	22~23°C
Test Channel :	110	Relative Humidity :	52~53%
Test Engineer :	Hayden Wu	Polarization :	Vertical
Remark :	<ol style="list-style-type: none"> 5552 MHz is fundamental signal which can be ignored. 16650 MHz is not within a restricted band and satisfies both the average and peak limits of 15.209. Average measurement was not performed if peak level went lower than the average limit. 		

Frequency (MHz)	Level (dBμV/m)	Over Limit (dB)	Limit Line (dBμV/m)	Read Level (dBμV)	Antenna Factor (dB)	Cable Loss (dB)	Preamp Factor (dB)	Ant Pos (cm)	Table Pos (deg)	Remark
5552	93.97	-	-	82.05	34.85	11.05	33.98	100	351	Average
5552	103.31	-	-	91.39	34.85	11.05	33.98	100	351	Peak
11100	45.62	-28.38	74	56.14	37.64	10.82	58.98	100	0	Peak
16650	46.69	-27.31	74	52.46	41.16	11.88	58.81	100	0	Peak



Test Mode :	802.11n HT40	Temperature :	22~23°C
Test Channel :	134	Relative Humidity :	52~53%
Test Engineer :	Hayden Wu	Polarization :	Horizontal
Remark :	1. 5672 MHz is fundamental signal which can be ignored. 2. 17010 MHz is not within a restricted band and satisfies both the average and peak limits of 15.209. 3. Average measurement was not performed if peak level went lower than the average limit.		

Frequency (MHz)	Level (dBμV/m)	Over Limit (dB)	Limit Line (dBμV/m)	Read Level (dBμV)	Antenna Factor (dB)	Cable Loss (dB)	Preamp Factor (dB)	Ant Pos (cm)	Table Pos (deg)	Remark
103.44	26.2	-17.3	43.5	45.39	11.44	1.12	31.75	-	-	Peak
211.44	28.13	-15.37	43.5	49.19	9.11	1.58	31.75	-	-	Peak
294.6	32.42	-13.58	46	49.16	13.1	1.88	31.72	-	-	Peak
307	34.13	-11.87	46	50.58	13.35	1.93	31.73	100	274	Peak
506.5	31.57	-14.43	46	43.15	17.86	2.5	31.94	-	-	Peak
867	25.34	-20.66	46	32.86	20.87	3.28	31.67	-	-	Peak
5672	101.96	-	-	89.72	34.97	11.26	33.99	109	356	Average
5672	111.77	-	-	99.53	34.97	11.26	33.99	109	356	Peak
11340	47.27	-26.73	74	57.28	37.73	10.96	58.7	100	0	Peak
17010	45.77	-28.23	74	50.9	41.47	12	58.6	100	0	Peak



Test Mode :	802.11n HT40	Temperature :	22~23°C
Test Channel :	134	Relative Humidity :	52~53%
Test Engineer :	Hayden Wu	Polarization :	Vertical
Remark :	1. 5672 MHz is fundamental signal which can be ignored. 2. 17010 MHz is not within a restricted band and satisfies both the average and peak limits of 15.209. 3. Average measurement was not performed if peak level went lower than the average limit.		

Frequency (MHz)	Level (dBμV/m)	Over Limit (dB)	Limit Line (dBμV/m)	Read Level (dBμV)	Antenna Factor (dB)	Cable Loss (dB)	Preamp Factor (dB)	Ant Pos (cm)	Table Pos (deg)	Remark
30.54	30.78	-9.22	40	44.03	17.9	0.65	31.8	100	102	Peak
45.66	27.45	-12.55	40	49.08	9.38	0.77	31.78	-	-	Peak
294.6	28.92	-17.08	46	45.66	13.1	1.88	31.72	-	-	Peak
454	31.64	-14.36	46	44.18	17.02	2.32	31.88	-	-	Peak
503	32.45	-13.55	46	44.06	17.83	2.49	31.93	-	-	Peak
872.6	24.69	-21.31	46	32.14	20.9	3.29	31.64	-	-	Peak
5672	93.16	-	-	80.92	34.97	11.26	33.99	100	181	Average
5672	101.96	-	-	89.72	34.97	11.26	33.99	100	181	Peak
11340	45.56	-28.44	74	55.57	37.73	10.96	58.7	100	0	Peak
17010	46.2	-27.8	74	51.33	41.47	12	58.6	100	0	Peak



Test Mode :	802.11ac VHT20	Temperature :	22~23°C
Test Channel :	36	Relative Humidity :	52~53%
Test Engineer :	Hayden Wu	Polarization :	Horizontal
Remark :	<ol style="list-style-type: none"> 5182 MHz is fundamental signal which can be ignored. 10359 MHz is not within a restricted band and satisfies both the average and peak limits of 15.209. Average measurement was not performed if peak level went lower than the average limit. 		

Frequency (MHz)	Level (dBμV/m)	Over Limit (dB)	Limit Line (dBμV/m)	Read Level (dBμV)	Antenna Factor (dB)	Cable Loss (dB)	Preamp Factor (dB)	Ant Pos (cm)	Table Pos (deg)	Remark
5182	103.04	-	-	92.08	34.48	10.47	33.99	107	312	Average
5182	112.66	-	-	101.7	34.48	10.47	33.99	107	312	Peak
10359	44.1	-29.9	74	56.98	37.17	10.64	60.69	100	0	Peak
15540	48.07	-25.93	74	56.02	39.73	11.79	59.47	100	0	Peak

Test Mode :	802.11ac VHT20	Temperature :	22~23°C
Test Channel :	36	Relative Humidity :	52~53%
Test Engineer :	Hayden Wu	Polarization :	Vertical
Remark :	<ol style="list-style-type: none"> 5178 MHz is fundamental signal which can be ignored. 10359 MHz is not within a restricted band and satisfies both the average and peak limits of 15.209. Average measurement was not performed if peak level went lower than the average limit. 		

Frequency (MHz)	Level (dBμV/m)	Over Limit (dB)	Limit Line (dBμV/m)	Read Level (dBμV)	Antenna Factor (dB)	Cable Loss (dB)	Preamp Factor (dB)	Ant Pos (cm)	Table Pos (deg)	Remark
5178	96.23	-	-	85.27	34.48	10.47	33.99	186	123	Average
5178	105.65	-	-	94.69	34.48	10.47	33.99	186	123	Peak
10359	43.73	-30.27	74	56.61	37.17	10.64	60.69	100	0	Peak
15540	47.59	-26.41	74	55.54	39.73	11.79	59.47	100	0	Peak



Test Mode :	802.11ac VHT20	Temperature :	22~23°C
Test Channel :	44	Relative Humidity :	52~53%
Test Engineer :	Hayden Wu	Polarization :	Horizontal
Remark :	<ol style="list-style-type: none"> 5222 MHz is fundamental signal which can be ignored. 10440 MHz is not within a restricted band and satisfies both the average and peak limits of 15.209. Average measurement was not performed if peak level went lower than the average limit. 		

Frequency (MHz)	Level (dBμV/m)	Over Limit (dB)	Limit Line (dBμV/m)	Read Level (dBμV)	Antenna Factor (dB)	Cable Loss (dB)	Preamp Factor (dB)	Ant Pos (cm)	Table Pos (deg)	Remark
5222	103.57	-	-	92.5	34.52	10.54	33.99	107	307	Average
5222	113.18	-	-	102.11	34.52	10.54	33.99	107	307	Peak
10440	44.49	-29.51	74	57.2	37.23	10.65	60.59	100	0	Peak
15561	47.67	-26.33	74	55.55	39.77	11.78	59.43	100	0	Peak

Test Mode :	802.11ac VHT20	Temperature :	22~23°C
Test Channel :	44	Relative Humidity :	52~53%
Test Engineer :	Hayden Wu	Polarization :	Vertical
Remark :	<ol style="list-style-type: none"> 5218 MHz is fundamental signal which can be ignored. 10440 MHz is not within a restricted band and satisfies both the average and peak limits of 15.209. Average measurement was not performed if peak level went lower than the average limit. 		

Frequency (MHz)	Level (dBμV/m)	Over Limit (dB)	Limit Line (dBμV/m)	Read Level (dBμV)	Antenna Factor (dB)	Cable Loss (dB)	Preamp Factor (dB)	Ant Pos (cm)	Table Pos (deg)	Remark
5218	92.39	-	-	81.32	34.52	10.54	33.99	185	156	Average
5218	101.82	-	-	90.75	34.52	10.54	33.99	185	156	Peak
10440	44.53	-29.47	74	57.24	37.23	10.65	60.59	100	0	Peak
15561	46.95	-27.05	74	54.83	39.77	11.78	59.43	100	0	Peak



Test Mode :	802.11ac VHT20	Temperature :	22~23°C
Test Channel :	48	Relative Humidity :	52~53%
Test Engineer :	Hayden Wu	Polarization :	Horizontal
Remark :	<ol style="list-style-type: none"> 5238 MHz is fundamental signal which can be ignored. 10479 MHz is not within a restricted band and satisfies both the average and peak limits of 15.209. Average measurement was not performed if peak level went lower than the average limit. 		

Frequency (MHz)	Level (dBμV/m)	Over Limit (dB)	Limit Line (dBμV/m)	Read Level (dBμV)	Antenna Factor (dB)	Cable Loss (dB)	Preamp Factor (dB)	Ant Pos (cm)	Table Pos (deg)	Remark
5238	103.7	-	-	92.58	34.53	10.58	33.99	106	307	Average
5238	113.15	-	-	102.03	34.53	10.58	33.99	106	307	Peak
10479	44.46	-29.54	74	57.04	37.28	10.66	60.52	100	0	Peak
15720	47.19	-26.81	74	54.81	39.92	11.74	59.28	100	0	Peak

Test Mode :	802.11ac VHT20	Temperature :	22~23°C
Test Channel :	48	Relative Humidity :	52~53%
Test Engineer :	Hayden Wu	Polarization :	Vertical
Remark :	<ol style="list-style-type: none"> 5238 MHz is fundamental signal which can be ignored. 10479 MHz is not within a restricted band and satisfies both the average and peak limits of 15.209. Average measurement was not performed if peak level went lower than the average limit. 		

Frequency (MHz)	Level (dBμV/m)	Over Limit (dB)	Limit Line (dBμV/m)	Read Level (dBμV)	Antenna Factor (dB)	Cable Loss (dB)	Preamp Factor (dB)	Ant Pos (cm)	Table Pos (deg)	Remark
5238	92.33	-	-	81.21	34.53	10.58	33.99	200	155	Average
5238	101.15	-	-	90.03	34.53	10.58	33.99	200	155	Peak
10479	44.8	-29.2	74	57.38	37.28	10.66	60.52	100	0	Peak
15720	47.02	-26.98	74	54.64	39.92	11.74	59.28	100	0	Peak



Test Mode :	802.11ac VHT20	Temperature :	22~23°C
Test Channel :	52	Relative Humidity :	52~53%
Test Engineer :	Hayden Wu	Polarization :	Horizontal
Remark :	1. 5262 MHz is fundamental signal which can be ignored. 2. 10521 MHz is not within a restricted band and satisfies both the average and peak limits of 15.209. 3. Average measurement was not performed if peak level went lower than the average limit.		

Frequency (MHz)	Level (dBμV/m)	Over Limit (dB)	Limit Line (dBμV/m)	Read Level (dBμV)	Antenna Factor (dB)	Cable Loss (dB)	Preamp Factor (dB)	Ant Pos (cm)	Table Pos (deg)	Remark
5262	103.26	-	-	92.06	34.57	10.61	33.98	108	6	Average
5262	112.71	-	-	101.51	34.57	10.61	33.98	108	6	Peak
10521	44.9	-29.1	74	57.37	37.31	10.67	60.45	100	0	Peak
15780	47.28	-26.72	74	54.8	39.98	11.72	59.22	100	0	Peak

Test Mode :	802.11ac VHT20	Temperature :	22~23°C
Test Channel :	52	Relative Humidity :	52~53%
Test Engineer :	Hayden Wu	Polarization :	Vertical
Remark :	1. 5262 MHz is fundamental signal which can be ignored. 2. 10521 MHz is not within a restricted band and satisfies both the average and peak limits of 15.209. 3. Average measurement was not performed if peak level went lower than the average limit.		

Frequency (MHz)	Level (dBμV/m)	Over Limit (dB)	Limit Line (dBμV/m)	Read Level (dBμV)	Antenna Factor (dB)	Cable Loss (dB)	Preamp Factor (dB)	Ant Pos (cm)	Table Pos (deg)	Remark
5262	93.64	-	-	82.44	34.57	10.61	33.98	169	164	Average
5262	102.66	-	-	91.46	34.57	10.61	33.98	169	164	Peak
10521	44.57	-29.43	74	57.04	37.31	10.67	60.45	100	0	Peak
15780	48.42	-25.58	74	55.94	39.98	11.72	59.22	100	0	Peak



Test Mode :	802.11ac VHT20	Temperature :	22~23°C
Test Channel :	60	Relative Humidity :	52~53%
Test Engineer :	Hayden Wu	Polarization :	Horizontal
Remark :	1. 5302 MHz is fundamental signal which can be ignored. 2. 10599 MHz is not within a restricted band and satisfies both the average and peak limits of 15.209. 3. Average measurement was not performed if peak level went lower than the average limit.		

Frequency (MHz)	Level (dBμV/m)	Over Limit (dB)	Limit Line (dBμV/m)	Read Level (dBμV)	Antenna Factor (dB)	Cable Loss (dB)	Preamp Factor (dB)	Ant Pos (cm)	Table Pos (deg)	Remark
5302	103.47	-	-	92.2	34.6	10.65	33.98	105	309	Average
5302	112.89	-	-	101.62	34.6	10.65	33.98	105	309	Peak
10599	44.55	-29.45	74	56.72	37.36	10.68	60.21	100	0	Peak
15900	46.39	-27.61	74	53.71	40.1	11.68	59.1	100	0	Peak

Test Mode :	802.11ac VHT20	Temperature :	22~23°C
Test Channel :	60	Relative Humidity :	52~53%
Test Engineer :	Hayden Wu	Polarization :	Vertical
Remark :	1. 5302 MHz is fundamental signal which can be ignored. 2. 10599 MHz is not within a restricted band and satisfies both the average and peak limits of 15.209. 3. Average measurement was not performed if peak level went lower than the average limit.		

Frequency (MHz)	Level (dBμV/m)	Over Limit (dB)	Limit Line (dBμV/m)	Read Level (dBμV)	Antenna Factor (dB)	Cable Loss (dB)	Preamp Factor (dB)	Ant Pos (cm)	Table Pos (deg)	Remark
5302	94.57	-	-	83.3	34.6	10.65	33.98	176	38	Average
5302	104.1	-	-	92.83	34.6	10.65	33.98	176	38	Peak
10599	44.75	-29.25	74	56.92	37.36	10.68	60.21	100	0	Peak
15900	46.6	-27.4	74	53.92	40.1	11.68	59.1	100	0	Peak



Test Mode :	802.11ac VHT20	Temperature :	22~23°C
Test Channel :	64	Relative Humidity :	52~53%
Test Engineer :	Hayden Wu	Polarization :	Horizontal
Remark :	1. 5322 MHz is fundamental signal which can be ignored. 2. Average measurement was not performed if peak level went lower than the average limit.		

Frequency (MHz)	Level (dBμV/m)	Over Limit (dB)	Limit Line (dBμV/m)	Read Level (dBμV)	Antenna Factor (dB)	Cable Loss (dB)	Preamp Factor (dB)	Ant Pos (cm)	Table Pos (deg)	Remark
5322	103.93	-	-	92.61	34.62	10.68	33.98	117	360	Average
5322	112.8	-	-	101.48	34.62	10.68	33.98	117	360	Peak
10641	44.83	-29.17	74	56.87	37.38	10.69	60.11	100	0	Peak
15960	45.64	-28.36	74	52.84	40.17	11.66	59.03	100	0	Peak

Test Mode :	802.11ac VHT20	Temperature :	22~23°C
Test Channel :	64	Relative Humidity :	52~53%
Test Engineer :	Hayden Wu	Polarization :	Vertical
Remark :	1. 5322 MHz is fundamental signal which can be ignored. 2. Average measurement was not performed if peak level went lower than the average limit.		

Frequency (MHz)	Level (dBμV/m)	Over Limit (dB)	Limit Line (dBμV/m)	Read Level (dBμV)	Antenna Factor (dB)	Cable Loss (dB)	Preamp Factor (dB)	Ant Pos (cm)	Table Pos (deg)	Remark
5322	94.24	-	-	82.92	34.62	10.68	33.98	176	28	Average
5322	104.01	-	-	92.69	34.62	10.68	33.98	176	28	Peak
10641	44.99	-29.01	74	57.03	37.38	10.69	60.11	100	0	Peak
15960	46.15	-27.85	74	53.35	40.17	11.66	59.03	100	0	Peak



Test Mode :	802.11ac VHT20	Temperature :	22~23°C
Test Channel :	100	Relative Humidity :	52~53%
Test Engineer :	Hayden Wu	Polarization :	Horizontal
Remark :	<ol style="list-style-type: none"> 5502 MHz is fundamental signal which can be ignored. 16500 MHz is not within a restricted band and satisfies both the average and peak limits of 15.209. Average measurement was not performed if peak level went lower than the average limit. 		

Frequency (MHz)	Level (dBμV/m)	Over Limit (dB)	Limit Line (dBμV/m)	Read Level (dBμV)	Antenna Factor (dB)	Cable Loss (dB)	Preamp Factor (dB)	Ant Pos (cm)	Table Pos (deg)	Remark
5502	105.04	-	-	93.26	34.8	10.96	33.98	100	0	Average
5502	114.01	-	-	102.23	34.8	10.96	33.98	100	0	Peak
11001	44.74	-29.26	74	55.48	37.6	10.76	59.1	100	0	Peak
16500	45.01	-28.99	74	51.09	41	11.82	58.9	100	0	Peak

Test Mode :	802.11ac VHT20	Temperature :	22~23°C
Test Channel :	100	Relative Humidity :	52~53%
Test Engineer :	Hayden Wu	Polarization :	Vertical
Remark :	<ol style="list-style-type: none"> 5502 MHz is fundamental signal which can be ignored. 16500 MHz is not within a restricted band and satisfies both the average and peak limits of 15.209. Average measurement was not performed if peak level went lower than the average limit. 		

Frequency (MHz)	Level (dBμV/m)	Over Limit (dB)	Limit Line (dBμV/m)	Read Level (dBμV)	Antenna Factor (dB)	Cable Loss (dB)	Preamp Factor (dB)	Ant Pos (cm)	Table Pos (deg)	Remark
5502	95.96	-	-	84.18	34.8	10.96	33.98	100	350	Average
5502	105.16	-	-	93.38	34.8	10.96	33.98	100	350	Peak
11001	44.82	-29.18	74	55.56	37.6	10.76	59.1	100	0	Peak
16500	44.45	-29.55	74	50.53	41	11.82	58.9	100	0	Peak



Test Mode :	802.11ac VHT20	Temperature :	22~23°C
Test Channel :	116	Relative Humidity :	52~53%
Test Engineer :	Hayden Wu	Polarization :	Horizontal
Remark :	<ol style="list-style-type: none"> 5582 MHz is fundamental signal which can be ignored. 16740 MHz is not within a restricted band and satisfies both the average and peak limits of 15.209. Average measurement was not performed if peak level went lower than the average limit. 		

Frequency (MHz)	Level (dBμV/m)	Over Limit (dB)	Limit Line (dBμV/m)	Read Level (dBμV)	Antenna Factor (dB)	Cable Loss (dB)	Preamp Factor (dB)	Ant Pos (cm)	Table Pos (deg)	Remark
5582	105.13	-	-	93.14	34.89	11.09	33.99	100	298	Average
5582	114.65	-	-	102.66	34.89	11.09	33.99	100	298	Peak
11160	44.88	-29.12	74	55.27	37.67	10.84	58.9	100	0	Peak
16740	45.68	-28.32	74	51.29	41.24	11.91	58.76	100	0	Peak

Test Mode :	802.11ac VHT20	Temperature :	22~23°C
Test Channel :	116	Relative Humidity :	52~53%
Test Engineer :	Hayden Wu	Polarization :	Vertical
Remark :	<ol style="list-style-type: none"> 5582 MHz is fundamental signal which can be ignored. 16740 MHz is not within a restricted band and satisfies both the average and peak limits of 15.209. Average measurement was not performed if peak level went lower than the average limit. 		

Frequency (MHz)	Level (dBμV/m)	Over Limit (dB)	Limit Line (dBμV/m)	Read Level (dBμV)	Antenna Factor (dB)	Cable Loss (dB)	Preamp Factor (dB)	Ant Pos (cm)	Table Pos (deg)	Remark
5582	96.49	-	-	84.5	34.89	11.09	33.99	100	350	Peak
5582	106.65	-	-	94.71	34.87	11.05	33.98	100	350	5582
11160	45.2	-28.8	74	55.59	37.67	10.84	58.9	100	0	Peak
16740	45.29	-28.71	74	50.9	41.24	11.91	58.76	100	0	Peak



Test Mode :	802.11ac VHT20	Temperature :	22~23°C
Test Channel :	140	Relative Humidity :	52~53%
Test Engineer :	Hayden Wu	Polarization :	Horizontal
Remark :	<ol style="list-style-type: none"> 5702 MHz is fundamental signal which can be ignored. 17100 MHz is not within a restricted band and satisfies both the average and peak limits of 15.209. Average measurement was not performed if peak level went lower than the average limit. 		

Frequency (MHz)	Level (dBμV/m)	Over Limit (dB)	Limit Line (dBμV/m)	Read Level (dBμV)	Antenna Factor (dB)	Cable Loss (dB)	Preamp Factor (dB)	Ant Pos (cm)	Table Pos (deg)	Remark
5702	103.36	-	-	91.04	35.01	11.3	33.99	107	359	Average
5702	113.02	-	-	100.7	35.01	11.3	33.99	107	359	Peak
11400	43.92	-30.08	74	53.79	37.76	10.99	58.62	100	0	Peak
17100	46.36	-27.64	74	51.5	41.34	12.12	58.6	100	0	Peak

Test Mode :	802.11ac VHT20	Temperature :	22~23°C
Test Channel :	140	Relative Humidity :	52~53%
Test Engineer :	Hayden Wu	Polarization :	Vertical
Remark :	<ol style="list-style-type: none"> 5702 MHz is fundamental signal which can be ignored. 17100 MHz is not within a restricted band and satisfies both the average and peak limits of 15.209. Average measurement was not performed if peak level went lower than the average limit. 		

Frequency (MHz)	Level (dBμV/m)	Over Limit (dB)	Limit Line (dBμV/m)	Read Level (dBμV)	Antenna Factor (dB)	Cable Loss (dB)	Preamp Factor (dB)	Ant Pos (cm)	Table Pos (deg)	Remark
5702	93.42	-	-	81.1	35.01	11.3	33.99	100	182	Average
5702	102.21	-	-	89.89	35.01	11.3	33.99	100	182	Peak
11400	43.74	-30.26	74	53.61	37.76	10.99	58.62	100	0	Peak
17100	45.99	-28.01	74	51.13	41.34	12.12	58.6	100	0	Peak



Test Mode :	802.11ac VHT40	Temperature :	22~23°C
Test Channel :	38	Relative Humidity :	52~53%
Test Engineer :	Hayden Wu	Polarization :	Horizontal
Remark :	1. 5188 MHz is fundamental signal which can be ignored. 2. 10380 MHz is not within a restricted band and satisfies both the average and peak limits of 15.209. 3. Average measurement was not performed if peak level went lower than the average limit.		

Frequency (MHz)	Level (dBμV/m)	Over Limit (dB)	Limit Line (dBμV/m)	Read Level (dBμV)	Antenna Factor (dB)	Cable Loss (dB)	Preamp Factor (dB)	Ant Pos (cm)	Table Pos (deg)	Remark
5188	100.49	-	-	89.53	34.48	10.47	33.99	131	313	Average
5188	110.02	-	-	99.06	34.48	10.47	33.99	131	313	Peak
10380	43.55	-30.45	74	56.39	37.18	10.64	60.66	100	0	Peak
15570	47.56	-26.44	74	55.44	39.77	11.78	59.43	100	0	Peak

Test Mode :	802.11ac VHT40	Temperature :	22~23°C
Test Channel :	38	Relative Humidity :	52~53%
Test Engineer :	Hayden Wu	Polarization :	Vertical
Remark :	1. 5188 MHz is fundamental signal which can be ignored. 2. 10380 MHz is not within a restricted band and satisfies both the average and peak limits of 15.209. 3. Average measurement was not performed if peak level went lower than the average limit.		

Frequency (MHz)	Level (dBμV/m)	Over Limit (dB)	Limit Line (dBμV/m)	Read Level (dBμV)	Antenna Factor (dB)	Cable Loss (dB)	Preamp Factor (dB)	Ant Pos (cm)	Table Pos (deg)	Remark
5188	89.44	-	-	78.48	34.48	10.47	33.99	200	122	Average
5188	98.77	-	-	87.81	34.48	10.47	33.99	200	122	Peak
10380	44.3	-29.7	74	57.14	37.18	10.64	60.66	100	0	Peak
15570	47.17	-26.83	74	55.05	39.77	11.78	59.43	100	0	Peak



Test Mode :	802.11ac VHT40	Temperature :	22~23°C
Test Channel :	46	Relative Humidity :	52~53%
Test Engineer :	Hayden Wu	Polarization :	Horizontal
Remark :	1. 5230 MHz is fundamental signal which can be ignored. 2. 10461 MHz is not within a restricted band and satisfies both the average and peak limits of 15.209. 3. Average measurement was not performed if peak level went lower than the average limit.		

Frequency (MHz)	Level (dBμV/m)	Over Limit (dB)	Limit Line (dBμV/m)	Read Level (dBμV)	Antenna Factor (dB)	Cable Loss (dB)	Preamp Factor (dB)	Ant Pos (cm)	Table Pos (deg)	Remark
5230	100.85	-	-	89.73	34.53	10.58	33.99	100	309	Average
5230	110.76	-	-	99.64	34.53	10.58	33.99	100	309	Peak
10461	45.04	-28.96	74	57.66	37.27	10.66	60.55	100	0	Peak
15609	46.99	-27.01	74	54.82	39.8	11.77	59.4	100	0	Peak

Test Mode :	802.11ac VHT40	Temperature :	22~23°C
Test Channel :	46	Relative Humidity :	52~53%
Test Engineer :	Hayden Wu	Polarization :	Vertical
Remark :	1. 5226 MHz is fundamental signal which can be ignored. 2. 10461 MHz is not within a restricted band and satisfies both the average and peak limits of 15.209. 3. Average measurement was not performed if peak level went lower than the average limit.		

Frequency (MHz)	Level (dBμV/m)	Over Limit (dB)	Limit Line (dBμV/m)	Read Level (dBμV)	Antenna Factor (dB)	Cable Loss (dB)	Preamp Factor (dB)	Ant Pos (cm)	Table Pos (deg)	Remark
5226	90.29	-	-	79.21	34.53	10.54	33.99	100	26	Average
5226	99.49	-	-	88.41	34.53	10.54	33.99	100	26	Peak
10461	44.41	-29.59	74	57.03	37.27	10.66	60.55	100	0	Peak
15690	46.93	-27.07	74	54.6	39.89	11.75	59.31	100	0	Peak



Test Mode :	802.11ac VHT40	Temperature :	22~23°C
Test Channel :	54	Relative Humidity :	52~53%
Test Engineer :	Hayden Wu	Polarization :	Horizontal
Remark :	<ol style="list-style-type: none"> 5272 MHz is fundamental signal which can be ignored. 10540 MHz is not within a restricted band and satisfies both the average and peak limits of 15.209. Average measurement was not performed if peak level went lower than the average limit. 		

Frequency (MHz)	Level (dBμV/m)	Over Limit (dB)	Limit Line (dBμV/m)	Read Level (dBμV)	Antenna Factor (dB)	Cable Loss (dB)	Preamp Factor (dB)	Ant Pos (cm)	Table Pos (deg)	Remark
5272	100.35	-	-	89.14	34.58	10.61	33.98	107	312	Average
5272	110.21	-	-	99	34.58	10.61	33.98	107	312	Peak
10540	44.68	-29.32	74	57.09	37.32	10.67	60.4	100	0	Peak
15810	46.38	-27.62	74	53.85	40.01	11.71	59.19	100	0	Peak

Test Mode :	802.11ac VHT40	Temperature :	22~23°C
Test Channel :	54	Relative Humidity :	52~53%
Test Engineer :	Hayden Wu	Polarization :	Vertical
Remark :	<ol style="list-style-type: none"> 5268 MHz is fundamental signal which can be ignored. 10540 MHz is not within a restricted band and satisfies both the average and peak limits of 15.209. Average measurement was not performed if peak level went lower than the average limit. 		

Frequency (MHz)	Level (dBμV/m)	Over Limit (dB)	Limit Line (dBμV/m)	Read Level (dBμV)	Antenna Factor (dB)	Cable Loss (dB)	Preamp Factor (dB)	Ant Pos (cm)	Table Pos (deg)	Remark
5268	91.79	-	-	80.58	34.58	10.61	33.98	182	360	Average
5268	101.77	-	-	90.56	34.58	10.61	33.98	182	360	Peak
10540	44.76	-29.24	74	57.17	37.32	10.67	60.4	100	0	Peak
15810	45.92	-28.08	74	53.39	40.01	11.71	59.19	100	0	Peak



Test Mode :	802.11ac VHT40	Temperature :	22~23°C
Test Channel :	62	Relative Humidity :	52~53%
Test Engineer :	Hayden Wu	Polarization :	Horizontal
Remark :	1. 5308 MHz is fundamental signal which can be ignored. 2. Average measurement was not performed if peak level went lower than the average limit.		

Frequency (MHz)	Level (dBμV/m)	Over Limit (dB)	Limit Line (dBμV/m)	Read Level (dBμV)	Antenna Factor (dB)	Cable Loss (dB)	Preamp Factor (dB)	Ant Pos (cm)	Table Pos (deg)	Remark
5308	100.46	-	-	89.14	34.62	10.68	33.98	106	311	Average
5308	109.99	-	-	98.67	34.62	10.68	33.98	106	311	Peak
10620	44.51	-29.49	74	56.61	37.37	10.69	60.16	100	0	Peak
15930	45.81	-28.19	74	53.08	40.13	11.67	59.07	100	0	Peak

Test Mode :	802.11ac VHT40	Temperature :	22~23°C
Test Channel :	62	Relative Humidity :	52~53%
Test Engineer :	Hayden Wu	Polarization :	Vertical
Remark :	1. 5312 MHz is fundamental signal which can be ignored. 2. Average measurement was not performed if peak level went lower than the average limit.		

Frequency (MHz)	Level (dBμV/m)	Over Limit (dB)	Limit Line (dBμV/m)	Read Level (dBμV)	Antenna Factor (dB)	Cable Loss (dB)	Preamp Factor (dB)	Ant Pos (cm)	Table Pos (deg)	Remark
5312	92.02	-	-	80.7	34.62	10.68	33.98	180	6	Average
5312	101.77	-	-	90.45	34.62	10.68	33.98	180	6	Peak
10620	44.66	-29.34	74	56.76	37.37	10.69	60.16	100	0	Peak
15930	46.72	-27.28	74	53.99	40.13	11.67	59.07	100	0	Peak



Test Mode :	802.11ac VHT40	Temperature :	22~23°C
Test Channel :	102	Relative Humidity :	52~53%
Test Engineer :	Hayden Wu	Polarization :	Horizontal
Remark :	<ol style="list-style-type: none"> 5508 MHz is fundamental signal which can be ignored. 16530 MHz is not within a restricted band and satisfies both the average and peak limits of 15.209. Average measurement was not performed if peak level went lower than the average limit. 		

Frequency (MHz)	Level (dBμV/m)	Over Limit (dB)	Limit Line (dBμV/m)	Read Level (dBμV)	Antenna Factor (dB)	Cable Loss (dB)	Preamp Factor (dB)	Ant Pos (cm)	Table Pos (deg)	Remark
5508	101.38	-	-	89.6	34.8	10.96	33.98	101	359	Average
5508	111.64	-	-	99.86	34.8	10.96	33.98	101	359	Peak
11020	44.52	-29.48	74	55.23	37.61	10.76	59.08	100	0	Peak
16530	44.63	-29.37	74	50.65	41.03	11.83	58.88	100	0	Peak

Test Mode :	802.11ac VHT40	Temperature :	22~23°C
Test Channel :	102	Relative Humidity :	52~53%
Test Engineer :	Hayden Wu	Polarization :	Vertical
Remark :	<ol style="list-style-type: none"> 5512 MHz is fundamental signal which can be ignored. 16530 MHz is not within a restricted band and satisfies both the average and peak limits of 15.209. Average measurement was not performed if peak level went lower than the average limit. 		

Frequency (MHz)	Level (dBμV/m)	Over Limit (dB)	Limit Line (dBμV/m)	Read Level (dBμV)	Antenna Factor (dB)	Cable Loss (dB)	Preamp Factor (dB)	Ant Pos (cm)	Table Pos (deg)	Remark
5512	91.59	-	-	79.84	34.8	10.93	33.98	100	351	Average
5512	101.72	-	-	89.97	34.8	10.93	33.98	100	351	Peak
11020	44.42	-29.58	74	55.13	37.61	10.76	59.08	100	0	Peak
16530	45.91	-28.09	74	51.93	41.03	11.83	58.88	100	0	Peak



Test Mode :	802.11ac VHT40	Temperature :	22~23°C
Test Channel :	110	Relative Humidity :	52~53%
Test Engineer :	Hayden Wu	Polarization :	Horizontal
Remark :	<ol style="list-style-type: none"> 5548 MHz is fundamental signal which can be ignored. 16650 MHz is not within a restricted band and satisfies both the average and peak limits of 15.209. Average measurement was not performed if peak level went lower than the average limit. 		

Frequency (MHz)	Level (dBμV/m)	Over Limit (dB)	Limit Line (dBμV/m)	Read Level (dBμV)	Antenna Factor (dB)	Cable Loss (dB)	Preamp Factor (dB)	Ant Pos (cm)	Table Pos (deg)	Remark
5548	103	-	-	91.08	34.85	11.05	33.98	100	359	Average
5548	113.38	-	-	101.46	34.85	11.05	33.98	100	359	Peak
11100	44.28	-29.72	74	54.8	37.64	10.82	58.98	100	0	Peak
16650	45.06	-28.94	74	50.83	41.16	11.88	58.81	100	0	Peak

Test Mode :	802.11ac VHT40	Temperature :	22~23°C
Test Channel :	110	Relative Humidity :	52~53%
Test Engineer :	Hayden Wu	Polarization :	Vertical
Remark :	<ol style="list-style-type: none"> 5552 MHz is fundamental signal which can be ignored. 16650 MHz is not within a restricted band and satisfies both the average and peak limits of 15.209. Average measurement was not performed if peak level went lower than the average limit. 		

Frequency (MHz)	Level (dBμV/m)	Over Limit (dB)	Limit Line (dBμV/m)	Read Level (dBμV)	Antenna Factor (dB)	Cable Loss (dB)	Preamp Factor (dB)	Ant Pos (cm)	Table Pos (deg)	Remark
5552	94.27	-	-	82.35	34.85	11.05	33.98	100	351	Average
5552	103.83	-	-	91.91	34.85	11.05	33.98	100	351	Peak
11100	45.03	-28.97	74	55.55	37.64	10.82	58.98	100	0	Peak
16650	45.12	-28.88	74	50.89	41.16	11.88	58.81	100	0	Peak



Test Mode :	802.11ac VHT40	Temperature :	22~23°C
Test Channel :	134	Relative Humidity :	52~53%
Test Engineer :	Hayden Wu	Polarization :	Horizontal
Remark :	<ol style="list-style-type: none"> 5668 MHz is fundamental signal which can be ignored. 17010 MHz is not within a restricted band and satisfies both the average and peak limits of 15.209. Average measurement was not performed if peak level went lower than the average limit. 		

Frequency (MHz)	Level (dBµV/m)	Over Limit (dB)	Limit Line (dBµV/m)	Read Level (dBµV)	Antenna Factor (dB)	Cable Loss (dB)	Preamp Factor (dB)	Ant Pos (cm)	Table Pos (deg)	Remark
5668	102.26	-	-	90.06	34.97	11.22	33.99	118	356	Average
5668	112.55	-	-	100.35	34.97	11.22	33.99	118	356	Peak
11340	44.93	-29.07	74	54.94	37.73	10.96	58.7	100	0	Peak
17010	44.93	-29.07	74	50.06	41.47	12	58.6	100	0	Peak

Test Mode :	802.11ac VHT40	Temperature :	22~23°C
Test Channel :	134	Relative Humidity :	52~53%
Test Engineer :	Hayden Wu	Polarization :	Vertical
Remark :	<ol style="list-style-type: none"> 5668 MHz is fundamental signal which can be ignored. 17010 MHz is not within a restricted band and satisfies both the average and peak limits of 15.209. Average measurement was not performed if peak level went lower than the average limit. 		

Frequency (MHz)	Level (dBµV/m)	Over Limit (dB)	Limit Line (dBµV/m)	Read Level (dBµV)	Antenna Factor (dB)	Cable Loss (dB)	Preamp Factor (dB)	Ant Pos (cm)	Table Pos (deg)	Remark
5668	93.34	-	-	81.14	34.97	11.22	33.99	100	177	Average
5668	103.39	-	-	91.19	34.97	11.22	33.99	100	177	Peak
11340	46.41	-27.59	74	56.42	37.73	10.96	58.7	100	0	Peak
17010	45.91	-28.09	74	51.04	41.47	12	58.6	100	0	Peak



Test Mode :	802.11ac VHT80	Temperature :	22~23°C
Test Channel :	42	Relative Humidity :	52~53%
Test Engineer :	Hayden Wu	Polarization :	Horizontal
Remark :	<ol style="list-style-type: none"> 1. 5210 MHz is fundamental signal which can be ignored. 2. 10419 MHz is not within a restricted band and satisfies both the average and peak limits of 15.209. 3. Average measurement was not performed if peak level went lower than the average limit. 		

Frequency (MHz)	Level (dBμV/m)	Over Limit (dB)	Limit Line (dBμV/m)	Read Level (dBμV)	Antenna Factor (dB)	Cable Loss (dB)	Preamp Factor (dB)	Ant Pos (cm)	Table Pos (deg)	Remark
92.64	19.6	-23.9	43.5	40.78	9.5	1.07	31.75	-	-	Peak
183.9	32.69	-10.81	43.5	53.92	9.06	1.46	31.75	125	321	Peak
248.16	30.06	-15.94	46	47.86	12.22	1.72	31.74	-	-	Peak
426	26.85	-19.15	46	39.65	16.8	2.25	31.85	-	-	Peak
664	25.59	-20.41	46	35.34	19.45	2.83	32.03	-	-	Peak
861.4	24.58	-21.42	46	32.2	20.81	3.26	31.69	-	-	Peak
5210	94.4	-	-	83.36	34.52	10.51	33.99	107	307	Average
5210	103.94	-	-	92.9	34.52	10.51	33.99	107	307	Peak
10419	43.35	-30.65	74	56.1	37.22	10.65	60.62	100	0	Peak
15630	47.52	-26.48	74	55.28	39.84	11.76	59.36	100	0	Peak



Test Mode :	802.11ac VHT80	Temperature :	22~23°C
Test Channel :	42	Relative Humidity :	52~53%
Test Engineer :	Hayden Wu	Polarization :	Vertical
Remark :	<ol style="list-style-type: none"> 5210 MHz is fundamental signal which can be ignored. 10419 MHz is not within a restricted band and satisfies both the average and peak limits of 15.209. Average measurement was not performed if peak level went lower than the average limit. 		

Frequency (MHz)	Level (dBμV/m)	Over Limit (dB)	Limit Line (dBμV/m)	Read Level (dBμV)	Antenna Factor (dB)	Cable Loss (dB)	Preamp Factor (dB)	Ant Pos (cm)	Table Pos (deg)	Remark
92.64	19.6	-23.9	43.5	40.78	9.5	1.07	31.75	-	-	Peak
183.9	32.69	-10.81	43.5	53.92	9.06	1.46	31.75	125	321	Peak
248.16	30.06	-15.94	46	47.86	12.22	1.72	31.74	-	-	Peak
426	26.85	-19.15	46	39.65	16.8	2.25	31.85	-	-	Peak
664	25.59	-20.41	46	35.34	19.45	2.83	32.03	-	-	Peak
861.4	24.58	-21.42	46	32.2	20.81	3.26	31.69	-	-	Peak
5210	94.4	-	-	83.36	34.52	10.51	33.99	107	307	Average
5210	103.94	-	-	92.9	34.52	10.51	33.99	107	307	Peak
10419	43.35	-30.65	74	56.1	37.22	10.65	60.62	100	0	Peak
15630	47.52	-26.48	74	55.28	39.84	11.76	59.36	100	0	Peak



Test Mode :	802.11ac VHT80	Temperature :	22~23°C
Test Channel :	58	Relative Humidity :	52~53%
Test Engineer :	Hayden Wu	Polarization :	Horizontal
Remark :	<ol style="list-style-type: none"> 1. 5210 MHz is fundamental signal which can be ignored. 2. 10419 MHz is not within a restricted band and satisfies both the average and peak limits of 15.209. 3. Average measurement was not performed if peak level went lower than the average limit. 		

Frequency (MHz)	Level (dBμV/m)	Over Limit (dB)	Limit Line (dBμV/m)	Read Level (dBμV)	Antenna Factor (dB)	Cable Loss (dB)	Preamp Factor (dB)	Ant Pos (cm)	Table Pos (deg)	Remark
51.6	28.04	-11.96	40	51.03	7.98	0.81	31.78	117	295	Peak
169.05	28.63	-14.87	43.5	48.95	9.82	1.61	31.75	-	-	Peak
248.7	27.55	-18.45	46	45.35	12.22	1.72	31.74	-	-	Peak
366.5	23.1	-22.9	46	37.92	14.86	2.11	31.79	-	-	Peak
664	31.43	-14.57	46	41.18	19.45	2.83	32.03	-	-	Peak
853	24.8	-21.2	46	32.49	20.8	3.24	31.73	-	-	Peak
5210	86.46	-	-	75.42	34.52	10.51	33.99	116	6	Average
5210	95.16	-	-	84.12	34.52	10.51	33.99	116	6	Peak
10419	43.91	-30.09	74	56.66	37.22	10.65	60.62	100	0	Peak
15630	46.5	-27.5	74	54.26	39.84	11.76	59.36	100	0	Peak



Test Mode :	802.11ac VHT80	Temperature :	22~23°C
Test Channel :	58	Relative Humidity :	52~53%
Test Engineer :	Hayden Wu	Polarization :	Vertical
Remark :	<ol style="list-style-type: none"> 5292 MHz is fundamental signal which can be ignored. 10580 MHz is not within a restricted band and satisfies both the average and peak limits of 15.209. Average measurement was not performed if peak level went lower than the average limit. 		

Frequency (MHz)	Level (dBμV/m)	Over Limit (dB)	Limit Line (dBμV/m)	Read Level (dBμV)	Antenna Factor (dB)	Cable Loss (dB)	Preamp Factor (dB)	Ant Pos (cm)	Table Pos (deg)	Remark
30.27	32.79	-7.21	40	45.45	18.5	0.64	31.8	100	189	Peak
102.9	26.63	-16.87	43.5	45.98	11.28	1.12	31.75	-	-	Peak
297.84	30.18	-15.82	46	46.84	13.16	1.9	31.72	-	-	Peak
384	29.02	-16.98	46	43.42	15.26	2.14	31.8	-	-	Peak
550.6	29.3	-16.7	46	39.28	19.48	2.54	32	-	-	Peak
896.4	25.1	-20.9	46	32.27	21.02	3.36	31.55	-	-	Peak
5292	88.42	-	-	77.21	34.58	10.61	33.98	181	6	Average
5292	98.51	-	-	87.3	34.58	10.61	33.98	181	6	Peak
10580	44.2	-29.8	74	56.43	37.35	10.68	60.26	100	0	Peak
15870	46.08	-27.92	74	53.43	40.08	11.69	59.12	100	0	Peak



Test Mode :	802.11ac VHT80	Temperature :	22~23°C
Test Channel :	106	Relative Humidity :	52~53%
Test Engineer :	Hayden Wu	Polarization :	Horizontal
Remark :	1. 5528 MHz is fundamental signal which can be ignored. 2. 16590 MHz is not within a restricted band and satisfies both the average and peak limits of 15.209. 3. Average measurement was not performed if peak level went lower than the average limit.		

Frequency (MHz)	Level (dBμV/m)	Over Limit (dB)	Limit Line (dBμV/m)	Read Level (dBμV)	Antenna Factor (dB)	Cable Loss (dB)	Preamp Factor (dB)	Ant Pos (cm)	Table Pos (deg)	Remark
98.85	22.49	-21.01	43.5	42.48	10.66	1.1	31.75	-	-	Peak
211.44	29.01	-14.49	43.5	50.07	9.11	1.58	31.75	-	-	Peak
297.84	33.48	-12.52	46	50.14	13.16	1.9	31.72	-	-	Peak
307	34.87	-11.13	46	51.32	13.35	1.93	31.73	112	360	Peak
697.6	22.61	-23.39	46	32.35	19.4	2.88	32.02	-	-	Peak
924.4	25.01	-20.99	46	31.82	21.14	3.36	31.31	-	-	Peak
5528	96.91	-	-	85.11	34.82	10.96	33.98	100	298	Average
5528	106.87	-	-	95.07	34.82	10.96	33.98	100	298	Peak
11060	45.21	-28.79	74	55.81	37.63	10.79	59.02	100	0	Peak
16590	44.69	-29.31	74	50.59	41.09	11.86	58.85	100	0	Peak



Test Mode :	802.11ac VHT80	Temperature :	22~23°C
Test Channel :	106	Relative Humidity :	52~53%
Test Engineer :	Hayden Wu	Polarization :	Vertical
Remark :	1. 5532 MHz is fundamental signal which can be ignored. 2. 16590 MHz is not within a restricted band and satisfies both the average and peak limits of 15.209. 3. Average measurement was not performed if peak level went lower than the average limit.		

Frequency (MHz)	Level (dBμV/m)	Over Limit (dB)	Limit Line (dBμV/m)	Read Level (dBμV)	Antenna Factor (dB)	Cable Loss (dB)	Preamp Factor (dB)	Ant Pos (cm)	Table Pos (deg)	Remark
35.4	26.62	-13.38	40	42.73	14.98	0.7	31.79	100	209	Peak
102.9	26.63	-16.87	43.5	45.98	11.28	1.12	31.75	-	-	Peak
297.84	30.18	-15.82	46	46.84	13.16	1.9	31.72	-	-	Peak
307	30	-16	46	46.45	13.35	1.93	31.73	-	-	Peak
522.6	30.72	-15.28	46	42.08	18.09	2.51	31.96	-	-	Peak
896.4	25.1	-20.9	46	32.27	21.02	3.36	31.55	-	-	Peak
5532	87.46	-	-	75.68	34.8	10.96	33.98	100	351	Average
5532	97.03	-	-	85.25	34.8	10.96	33.98	100	351	Peak
11060	44.9	-29.1	74	55.5	37.63	10.79	59.02	100	0	Peak
16590	45.56	-28.44	74	51.46	41.09	11.86	58.85	100	0	Peak



3.5 AC Conducted Emission Measurement

3.5.1 Limit of AC Conducted Emission

For equipment that is designed to be connected to the public utility (AC) power line, the radio frequency voltage that is conducted back onto the AC power line on any frequency or frequencies within the band 150 kHz to 30 MHz shall not exceed the limits in the following table.

Frequency of emission (MHz)	Conducted limit (dB μ V)	
	Quasi-peak	Average
0.15-0.5	66 to 56*	56 to 46*
0.5-5	56	46
5-30	60	50

*Decreases with the logarithm of the frequency.

3.5.2 Measuring Instruments

The measuring equipment is listed in the section 4 of this test report.

3.5.3 Test Procedures

1. The EUT was placed 0.4 meter from the conducting wall of the shielding room was kept at least 80 centimeters from any other grounded conducting surface.
2. Connect EUT to the power mains through a line impedance stabilization network (LISN).
3. All the support units are connecting to the other LISN.
4. The LISN provides 50 ohm coupling impedance for the measuring instrument.
5. The FCC states that a 50 ohm, 50 microhenry LISN should be used.
6. Both sides of AC line were checked for maximum conducted interference.
7. The frequency range from 150 kHz to 30 MHz was searched.
8. Set the test-receiver system to Peak Detect Function and specified bandwidth with Maximum Hold Mode.

3.5.4 Test Setup

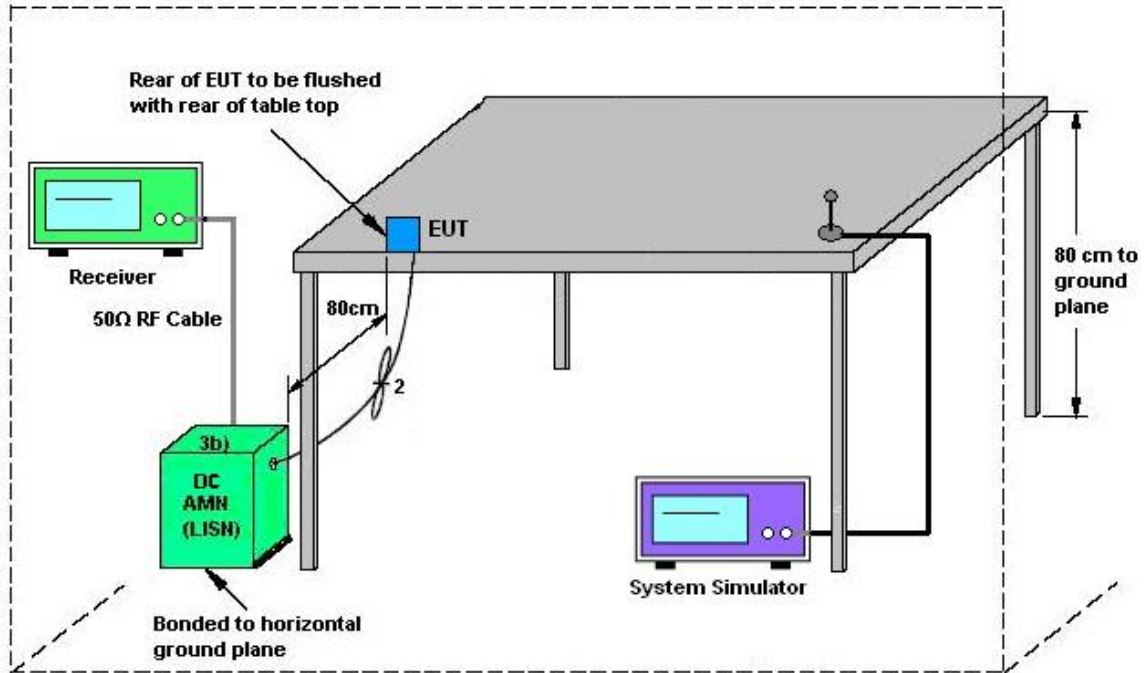

AMN = Artificial mains network (LISN)
 AE = Associated equipment
 EUT = Equipment under test
 ISN = Impedance stabilization network



3.5.5 Test Result of AC Conducted Emission

Test Mode :	Mode 1	Temperature :	20~22°C
Test Engineer :	Cosmo Xu	Relative Humidity :	45~47%
Test Voltage :	120Vac / 60Hz	Phase :	Line
Function Type :	GSM850 Idle + Bluetooth Link + WLAN (5GHz) Link + Earphone + MP3 + Battery + USB Cable (Charging from Adapter)		

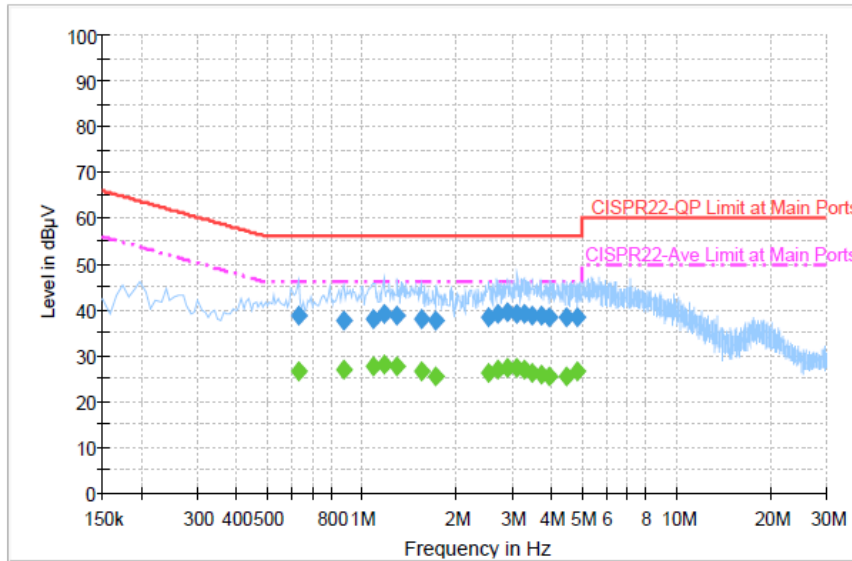

Final Result : QuasiPeak

Frequency (MHz)	QuasiPeak (dBµV)	Filter	Line	Corr. (dB)	Margin (dB)	Limit (dBµV)
0.630000	38.7	Off	L1	19.4	17.3	56.0
0.878000	37.8	Off	L1	19.4	18.2	56.0
1.086000	38.1	Off	L1	19.5	17.9	56.0
1.174000	39.0	Off	L1	19.5	17.0	56.0
1.294000	38.6	Off	L1	19.5	17.4	56.0
1.542000	37.9	Off	L1	19.4	18.1	56.0
1.718000	37.6	Off	L1	19.5	18.4	56.0
2.534000	38.5	Off	L1	19.6	17.5	56.0
2.702000	39.1	Off	L1	19.5	16.9	56.0
2.918000	39.4	Off	L1	19.6	16.6	56.0
3.118000	39.0	Off	L1	19.6	17.0	56.0
3.278000	39.2	Off	L1	19.6	16.8	56.0
3.486000	38.7	Off	L1	19.6	17.3	56.0
3.734000	38.7	Off	L1	19.6	17.3	56.0
3.942000	38.4	Off	L1	19.6	17.6	56.0
4.486000	38.2	Off	L1	19.6	17.8	56.0
4.838000	38.5	Off	L1	19.6	17.5	56.0



Test Mode :	Mode 1	Temperature :	20~22°C
Test Engineer :	Cosmo Xu	Relative Humidity :	45~47%
Test Voltage :	120Vac / 60Hz	Phase :	Line
Function Type :	GSM850 Idle + Bluetooth Link + WLAN (5GHz) Link + Earphone + MP3 + Battery + USB Cable (Charging from Adapter)		

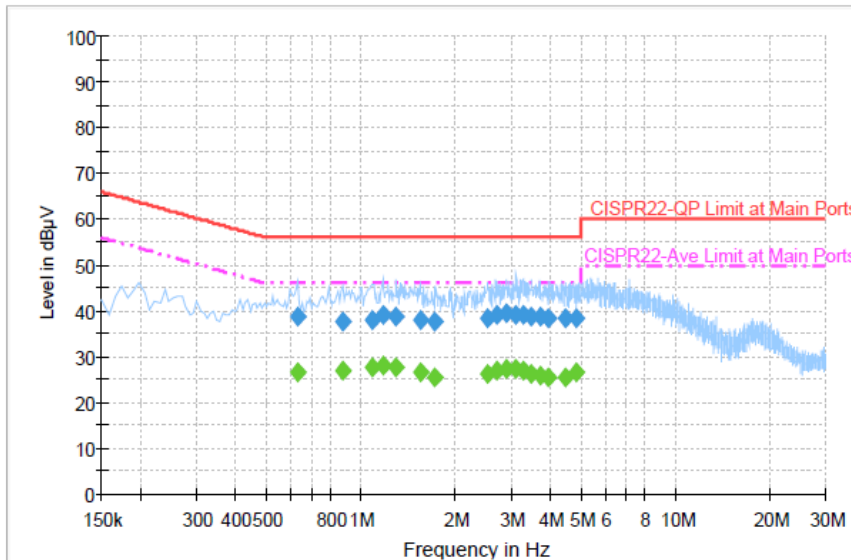

Final Result : Average

Frequency (MHz)	Average (dBµV)	Filter	Line	Corr. (dB)	Margin (dB)	Limit (dBµV)
0.630000	26.6	Off	L1	19.4	19.4	46.0
0.878000	27.1	Off	L1	19.4	18.9	46.0
1.086000	27.5	Off	L1	19.5	18.5	46.0
1.174000	27.9	Off	L1	19.5	18.1	46.0
1.294000	27.6	Off	L1	19.5	18.4	46.0
1.542000	26.5	Off	L1	19.4	19.5	46.0
1.718000	25.5	Off	L1	19.5	20.5	46.0
2.534000	26.1	Off	L1	19.6	19.9	46.0
2.702000	26.9	Off	L1	19.5	19.1	46.0
2.918000	27.4	Off	L1	19.6	18.6	46.0
3.118000	27.2	Off	L1	19.6	18.8	46.0
3.278000	27.0	Off	L1	19.6	19.0	46.0
3.486000	26.3	Off	L1	19.6	19.7	46.0
3.734000	25.7	Off	L1	19.6	20.3	46.0
3.942000	25.5	Off	L1	19.6	20.5	46.0
4.486000	25.4	Off	L1	19.6	20.6	46.0
4.838000	26.5	Off	L1	19.6	19.5	46.0



Test Mode :	Mode 1	Temperature :	20~22°C
Test Engineer :	Cosmo Xu	Relative Humidity :	45~47%
Test Voltage :	120Vac / 60Hz	Phase :	Neutral
Function Type :	GSM850 Idle + Bluetooth Link + WLAN (5GHz) Link + Earphone + MP3 + Battery + USB Cable (Charging from Adapter)		

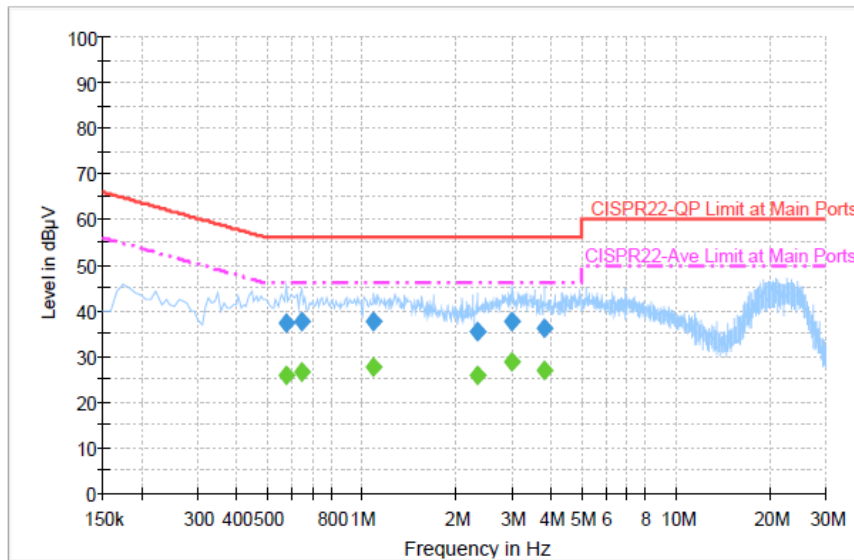

Final Result : QuasiPeak

Frequency (MHz)	QuasiPeak (dBµV)	Filter	Line	Corr. (dB)	Margin (dB)	Limit (dBµV)
0.574000	37.4	Off	N	19.3	18.6	56.0
0.646000	37.5	Off	N	19.4	18.5	56.0
1.094000	37.5	Off	N	19.5	18.5	56.0
2.334000	35.3	Off	N	19.6	20.7	56.0
3.014000	37.6	Off	N	19.6	18.4	56.0
3.814000	36.1	Off	N	19.6	19.9	56.0

Final Result : Average

Frequency (MHz)	Average (dBµV)	Filter	Line	Corr. (dB)	Margin (dB)	Limit (dBµV)
0.574000	25.7	Off	N	19.3	20.3	46.0
0.646000	26.5	Off	N	19.4	19.5	46.0
1.094000	27.8	Off	N	19.5	18.2	46.0
2.334000	25.8	Off	N	19.6	20.2	46.0
3.014000	28.7	Off	N	19.6	17.3	46.0
3.814000	26.9	Off	N	19.6	19.1	46.0

3.6 Frequency Stability Measurement

3.6.1 Limit of Frequency Stability

Manufacturers of U-NII devices are responsible for ensuring frequency stability such that an emission is maintained within the band of operation under all conditions of normal operation as specified in the user's manual.

3.6.2 Measuring Instruments

The measuring equipment is listed in the section 4 of this test report.

3.6.3 Test Procedures

1. To ensure emission at the band edge is maintained within the authorized band, those values shall be measured by radiation emissions at upper and lower frequency points, and finally compensated by frequency deviation as procedures below.
2. The EUT was operated at the maximum output power, and connected to the spectrum analyzer, which is set to maximum hold function and peak detector. The peak value of the power envelope was measured and noted. The upper and lower frequency points were respectively measured relatively 10dB lower than the measured peak value.
3. The frequency deviation was calculated by adding the upper frequency point and the lower frequency point divided by two. Those detailed values of frequency deviation are provided in table below.

3.6.4 Test Setup





3.6.5 Test Result of Frequency Stability

Test Band :	5GHz band 1,2,3	Test Engineer :	Alex Lee
-------------	-----------------	-----------------	----------

Mod.	Data Rate	NTX	Channel	Freq. (MHz)	Center Frequency (MHz)	Frequency Deviation (MHz)	Frequency Stability (ppm)	Temperature (°C)	Voltage (V)
11a	6Mbps	1	36	5180	5180.000	0.000	0.00	20	3.4
11a	6Mbps	1	36	5180	5180.000	0.000	0.00	20	4.35
11a	6Mbps	1	36	5180	5179.975	-0.025	-4.83	20	3.9
11a	6Mbps	1	36	5180	5180.100	0.100	19.31	-30	3.9
11a	6Mbps	1	36	5180	5180.000	0.000	0.00	60	3.9

Mod.	Data Rate	NTX	Channel	Freq. (MHz)	Center Frequency (MHz)	Frequency Deviation (MHz)	Frequency Stability (ppm)	Temperature (°C)	Voltage (V)
11a	6Mbps	1	64	5320	5320.000	0.000	0.00	20	3.40
11a	6Mbps	1	64	5320	5320.000	0.000	0.00	20	4.35
11a	6Mbps	1	64	5320	5320.000	0.000	0.00	20	3.90
11a	6Mbps	1	64	5320	5320.050	0.050	9.40	-30	3.90
11a	6Mbps	1	64	5320	5319.975	-0.025	-4.70	60	3.90

Mod.	Data Rate	NTX	Channel	Freq. (MHz)	Center Frequency (MHz)	Frequency Deviation (MHz)	Frequency Stability (ppm)	Temperature (°C)	Voltage (V)
11a	6Mbps	1	100	5500	5500.000	0.000	0.00	20	3.40
11a	6Mbps	1	100	5500	5500.025	0.025	4.55	20	4.35
11a	6Mbps	1	100	5500	5500.000	0.000	0.00	20	3.90
11a	6Mbps	1	100	5500	5500.000	0.000	0.00	-30	3.90
11a	6Mbps	1	100	5500	5500.000	0.000	0.00	60	3.90

Note: Center Frequency = (Low Frequency + High Frequency) / 2.



3.7 Automatically Discontinue Transmission

3.7.1 Limit of Automatically Discontinue Transmission

The device shall automatically discontinue transmission in case of either absence of information to transmit or operational failure. These provisions are not intended to preclude the transmission of control or signaling information or the use of repetitive codes used by certain digital technologies to complete frame or burst intervals. Applicants shall include in their application for equipment authorization to describe how this requirement is met.

3.7.2 Measuring Instruments

The measuring equipment is listed in the section 4 of this test report.

3.7.3 Test Result of Automatically Discontinue Transmission

While the EUT is not transmitting any information, the EUT can automatically discontinue transmission and become standby mode for power saving. The EUT can detect the controlling signal of ACK message transmitting from remote device and verify whether it shall resend or discontinue transmission.



3.8 Antenna Requirements

3.8.1 Standard Applicable

According to FCC 47 CFR Section 15.407(a)(1)(2) ,if transmitting antenna directional gain is greater than 6 dBi, both the peak transmit power and the peak power spectral density shall be reduced by the amount in dB that the directional gain of the antenna exceeds 6 dBi.

3.8.2 Antenna Anti-Replacement Construction

Non-standard antenna connector is used.

3.8.3 Antenna Gain

The antenna gain is less than 6 dBi. Therefore, it is not necessary to reduce maximum peak output power limit.



4 List of Measuring Equipments

Instrument	Manufacturer	Model No.	Serial No.	Characteristics	Calibration Date	Test Date	Due Date	Remark
Spectrum Analyzer	Rohde & Schwarz	FSP40	100057	9kHz~40GHz	Oct. 23, 2013	May 01, 2014 ~ Jul. 11, 2014	Oct. 22, 2014	Conducted (TH02-HY)
Power Meter	Anritsu	ML2495A	1036004	300MHz~40GHz	Aug. 17, 2013	May 01, 2014 ~ Jul. 11, 2014	Aug. 16, 2014	Conducted (TH02-HY)
Power Sensor	Anritsu	MA2411B	1027253	300MHz~40GHz	Aug. 17, 2013	May 01, 2014 ~ Jul. 11, 2014	Aug. 16, 2014	Conducted (TH02-HY)
Spectrum Analyzer	R&S	FSP30	101067	9kHz ~ 30GHz	Nov. 20, 2013	Jun. 08, 2014 ~ Jul. 11, 2014	Nov. 19, 2014	Radiation (03CH06-HY)
Spectrum Analyzer	Agilent	E4408B	MY44211030	9kHz ~ 26.5GHz	Dec. 02, 2013	Jun. 08, 2014 ~ Jul. 11, 2014	Dec. 01, 2014	Radiation (03CH06-HY)
EMI Test Receiver	R&S	ESVS10	834468/0003	20MHz ~ 1000MHz	May 06, 2014	Jun. 08, 2014 ~ Jul. 11, 2014	May 05, 2015	Radiation (03CH06-HY)
Loop Antenna	Rohde & Schwarz	HFH2-Z2	860004/0001	9kHz ~ 30MHz	Jul. 03, 2012	Jun. 08, 2014 ~ Jun. 11, 2014	Jul. 02, 2014	Radiation (03CH06-HY)
Loop Antenna	TESEQ	HLA6120	31244	9kHz ~ 30MHz	Dec. 02, 2012	Jul. 11, 2014	Dec. 01, 2014	Radiation (03CH06-HY)
Bilog Antenna	Schaffner	CBL6112B	2885	30MHz ~ 2GHz	Oct. 10, 2013	Jun. 08, 2014 ~ Jul. 11, 2014	Oct. 09, 2014	Radiation (03CH06-HY)
Double Ridge Horn Antenna	EMCO	3117	00066583	1GHz ~ 18GHz	Aug. 02, 2013	Jun. 08, 2014 ~ Jul. 11, 2014	Aug. 01, 2014	Radiation (03CH06-HY)
Amplifier	SONOMA	310N	186713	9kHz ~ 1GHz	Apr. 16, 2014	Jun. 08, 2014 ~ Jul. 11, 2014	Apr. 15, 2015	Radiation (03CH06-HY)
Pre Amplifier	EMCI	EMC051845	SN980048	1GHz ~ 18GHz	Jul. 18, 2013	Jun. 08, 2014 ~ Jul. 11, 2014	Jul. 17, 2014	Radiation (03CH06-HY)
SHF-EHF Horn Antenna	SCHWARZBECK	BBHA 9170	BBHA9170251	15GHz ~ 40GHz	Oct. 03, 2013	Jun. 08, 2014 ~ Jul. 11, 2014	Oct. 02, 2014	Radiation (03CH06-HY)
Preamplifier	Agilent	8449B	3008A01917	1GHz ~ 26.5GHz	Apr. 10, 2014	Jun. 08, 2014 ~ Jul. 11, 2014	Apr. 09, 2015	Radiation (03CH06-HY)
Amplifier	EM	EM18G40G	060604	18GHz ~ 40GHz	Oct. 17, 2013	Jun. 08, 2014 ~ Jul. 11, 2014	Oct. 16, 2014	Radiation (03CH06-HY)
Turn Table	INN-CO	DS2000	420/650/00	0 ~ 360 degree	N/A	Jun. 08, 2014 ~ Jul. 11, 2014	N/A	Radiation (03CH06-HY)
Antenna Mast	MF	MF-7802	MF780208212	1 m ~ 4 m	N/A	Jun. 08, 2014 ~ Jul. 11, 2014	N/A	Radiation (03CH06-HY)
EMI Test Receiver	Rohde & Schwarz	ESCS 30	100356	9kHz ~ 2.75GHz	Nov. 15, 2013	May 14, 2014	Nov. 14, 2014	Conduction (CO05-HY)
LISN (for auxiliary equipment)	Rohde & Schwarz	ENV216	100081	9kHz ~ 30MHz	Dec. 12, 2013	May 14, 2014	Dec. 11, 2014	Conduction (CO05-HY)
LISN	Rohde & Schwarz	ENV216	100080	9kHz ~ 30MHz	Dec. 04, 2013	May 14, 2014	Dec. 03, 2014	Conduction (CO05-HY)
AC Power Source	ChainTek	APC-1000W	N/A	N/A	N/A	May 14, 2014	N/A	Conduction (CO05-HY)



5 Uncertainty of Evaluation

Uncertainty of Conducted Emission Measurement (150kHz ~ 30MHz)

Measuring Uncertainty for a Level of Confidence of 95% ($U = 2Uc(y)$)	2.26
---	------

Uncertainty of Radiated Emission Measurement (30 MHz ~ 1000 MHz)

Measuring Uncertainty for a Level of Confidence of 95% ($U = 2Uc(y)$)	4.50
---	------