



FCC RF Test Report

APPLICANT : Motorola Mobility, LLC
EQUIPMENT : Mobile Cellular Phone
BRAND NAME : Motorola Mobility, LLC
MODEL NAME : 4079
FCC ID : IHDT56PK2
STANDARD : FCC Part 15 Subpart C §15.225
CLASSIFICATION : (DXX) Low Power Communication Device Transmitter

The testing was completed on Aug. 26, 2014. We, SPORTON INTERNATIONAL INC., would like to declare that the tested sample has been evaluated in accordance with the test procedures and has been in compliance with the applicable technical standards.

The test results in this report apply exclusively to the tested model / sample. Without written approval of SPORTON INTERNATIONAL INC., the test report shall not be reproduced except in full.

Reviewed by: Joseph Lin / Supervisor

Approved by: Jones Tsai / Manager



SPORTON INTERNATIONAL INC.

No. 52, Hwa Ya 1st Rd., Hwa Ya Technology Park, Kwei-Shan Hsiang, Tao Yuan Hsien, Taiwan, R.O.C.



Table of Contents

1. GENERAL INFORMATION.....	4
1.1 Applicant	4
1.2 Manufacturer.....	4
1.3 Product Details.....	4
1.4 Modification of EUT.....	4
APPENDIX A. ORIGINAL REPORT	



1. GENERAL INFORMATION

1.1 Applicant

Motorola Mobility, LLC

222 W Merchandise Mart Plaza, Suite 1800, Chicago, IL 60654, United States

1.2 Manufacturer

Motorola Mobility, LLC

222 W Merchandise Mart Plaza, Suite 1800, Chicago, IL 60654, United States

1.3 Product Details

Items	Description
Tx/Rx Frequency Range	13.553 ~ 13.567MHz
Channel Number	1
Antenna Type	FPC + Ferrite Antenna
Type of Modulation	ASK

Remark: The above EUT's information was declared by manufacturer. Please refer to the specifications or user's manual for more detailed description.

1.4 Modification of EUT

No modifications are made to the EUT during all test items.



Appendix A. Original Report

Please refer to Sporton report number FR462024D as below.



FCC RF Test Report

APPLICANT : Motorola Mobility, LLC
EQUIPMENT : Mobile Cellular Phone
BRAND NAME : Motorola Mobility, LLC
MODEL NAME : 3584
FCC ID : IHDT56PK1
STANDARD : FCC Part 15 Subpart C §15.225
CLASSIFICATION : (DXX) Low Power Communication Device Transmitter

The testing was completed on Aug. 01, 2014. We, SPORTON INTERNATIONAL INC., would like to declare that the tested sample has been evaluated in accordance with the test procedures and has been in compliance with the applicable technical standards.

The test results in this report apply exclusively to the tested model / sample. Without written approval of SPORTON INTERNATIONAL INC., the test report shall not be reproduced except in full.

Reviewed by: Joseph Lin / Supervisor

Approved by: Jones Tsai / Manager



SPORTON INTERNATIONAL INC.

No. 52, Hwa Ya 1st Rd., Hwa Ya Technology Park, Kwei-Shan Hsiang, Tao Yuan Hsien, Taiwan, R.O.C.



Table of Contents

1. SUMMARY OF THE TEST RESULT	4
2. GENERAL INFORMATION.....	5
2.1 Applicant	5
2.2 Manufacturer.....	5
2.3 Product Details.....	5
2.4 Modification of EUT.....	5
2.5 Testing Location	6
2.6 Applicable Standards	6
2.7 Test Modes.....	6
2.8 Test Configurations.....	7
2.9 Table for Supporting Units	8
3. CONDUCTED EMISSION TEST.....	9
3.1 Measuring Instruments	9
3.2 Test setup	9
3.3 Test Result of Conducted Emission Test.....	9
3.4 AC Power Line Conducted Emissions Measurement	10
4. CONDUCTED TEST ITEMS	11
4.1 Measuring Instruments	11
4.2 Test Setup	11
4.3 Test Result of Conducted Test Items.....	11
4.4 20dB Spectrum Bandwidth Measurement	12
4.5 Frequency Stability Measurement	12
5. RADIATED TEST ITEMS.....	13
5.1 Measuring Instruments	13
5.2 Test Setup	13
5.3 Test Result of Radiated Test Items	13
5.4 Field Strength of Fundamental Emissions and Mask Measurement	14
5.5 Radiated Emissions Measurement	15
6. LIST OF MEASURING EQUIPMENT	17
APPENDIX A. TEST RESULTS OF CONDUCTED EMISSION TEST	
APPENDIX B. TEST RESULTS OF CONDUCTED TEST ITEMS	
B.1. Test Result of 20dB Spectrum Bandwidth	
B.2 Test Result of Frequency Stability	
APPENDIX C. TEST RESULTS OF RADIATED TEST ITEMS	
C.1 Test Result of Field Strength of Fundamental Emissions	
C.2 Results of Radiated Emissions (9 kHz~30MHz)	
C.3 Results of Radiated Emissions (30MHz~1GHz)	



1. SUMMARY OF THE TEST RESULT

Applied Standard: 47 CFR FCC Part 15 Subpart C				
Part	FCC Rule	Description of Test	Result	Under Limit
3.1	15.207	AC Power Line Conducted Emissions	Complies	13.10 dB at 1.430MHz
3.2	15.225(a)(b)(c)	Field Strength of Fundamental Emissions	Complies	63.56 dB at 13.560 MHz
3.3	2.1049	20dB Spectrum Bandwidth	Complies	-
3.4	15.225(d) 15.209	Radiated Emissions	Complies	5.03 dB at 31.620 MHz for Peak
3.5	15.225(e)	Frequency Stability	Complies	-
3.6	15.203	Antenna Requirements	Complies	-

Test Items	Uncertainty	Remark
AC Power Line Conducted Emissions	±2.26dB	Confidence levels of 95%
Radiated Emissions (30MHz~1000MHz)	±4.70dB	Confidence levels of 95%



2. GENERAL INFORMATION

2.1 Applicant

Motorola Mobility, LLC

222 W Merchandise Mart Plaza, Suite 1800, Chicago, IL 60654, United States

2.2 Manufacturer

Motorola Mobility, LLC

222 W Merchandise Mart Plaza, Suite 1800, Chicago, IL 60654, United States

2.3 Product Details

Items	Description
Tx/Rx Frequency Range	13.553 ~ 13.567MHz
Channel Number	1
20dBW	2.640KHz
99%OBW	2.240KHz
Antenna Type	FPC + Ferrite Antenna
Type of Modulation	ASK

Remark: The above EUT's information was declared by manufacturer. Please refer to the specifications or user's manual for more detailed description.

2.4 Modification of EUT

No modifications are made to the EUT during all test items.



2.5 Testing Location

Sporton Lab is accredited to ISO 17025 by Taiwan Accreditation Foundation (TAF code : 1190) and the FCC designation No. TW1022 under the FCC 2.948(e) by Mutual Recognition Agreement (MRA) in FCC Test.

Test Site	SPORTON INTERNATIONAL INC.		
Test Site Location	No. 52, Hwa Ya 1 st Rd., Hwa Ya Technology Park, Kwei-Shan Hsiang, Tao Yuan Hsien, Taiwan, R.O.C. TEL: +886-3-3273456 / FAX: +886-3-3284978		
Test Site No.	Sporton Site No.		
	TH02-HY	CO05-HY	03CH07-HY
Test Engineer	Tommy Lee	Cosmo Xu	Eric Shih
Temperature	22~24°C	20~22°C	21~23°C
Relative Humidity	53~55%	46~48%	47~49%

2.6 Applicable Standards

According to the specifications of the manufacturer, the EUT must comply with the requirements of the following standards:

- FCC Part 15 Subpart C §15.225
- ANSI C63.4-2003

2.7 Test Modes

Investigation has been done on all the possible configurations for searching the worst cases. The following table is a list of the test modes shown in this test report.

Test Items	
AC Power Line Conducted Emissions	Field Strength of Fundamental Emissions
20dB Spectrum Bandwidth	Frequency Stability
Radiated Emissions 9kHz~30MHz	Radiated Emissions 30MHz~1GHz
Note:	
1. The EUT was programmed to be in continuously transmitting mode.	
2. The ancillary equipment, NFC card, is used to make the EUT (NFC) continuously transmit at 13.56MHz and is placed around 3 cm gap to the EUT.	
3. The NFC function cannot work simultaneously with wireless power charging feature.	

2.8 Test Configurations

<AC Conducted Emissions>

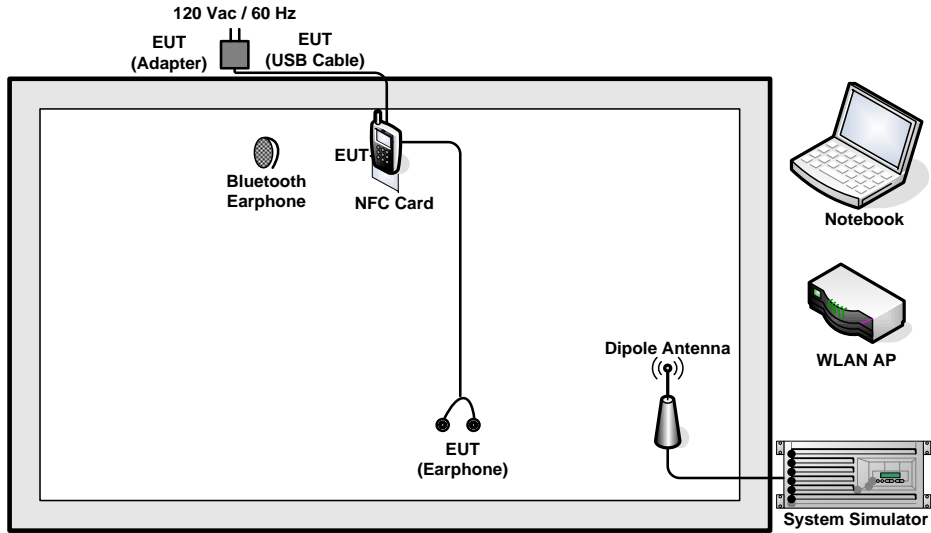

<For Fundamental Emissions and Mask and Radiated Emissions Measurement>

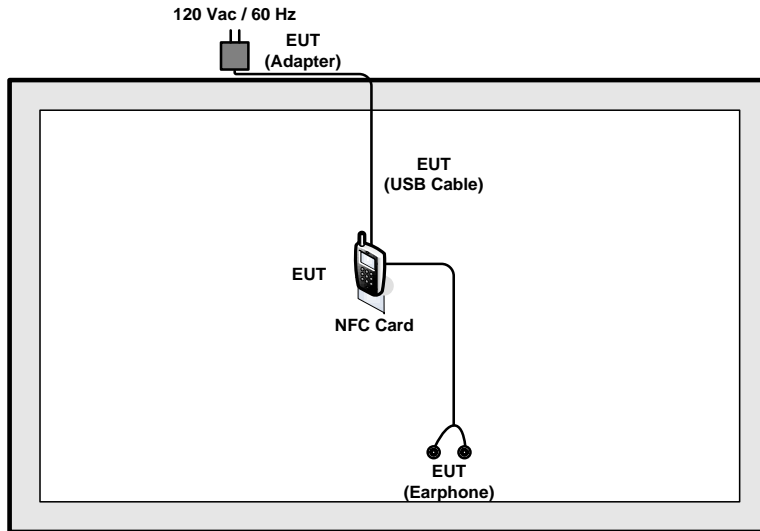



2.9 Table for Supporting Units

Support Unit	Manufacturer	Model	FCC ID
System Simulator	R&S	CMU 200	N/A
WLAN AP	D-Link	DIR-628	KA2DIR628A2
Bluetooth Earphone	Sony Ericsson	MW600	PY70DA2029
Notebook	DELL	Latitude E6320	FCC DoC/ Contains FCC ID: QDS-BRCM1054
NFC Card	Metro Taipei	Easy Card	N/A

3. CONDUCTED EMISSION TEST

3.1 Measuring Instruments

See list of measuring instruments of this test report.

3.2 Test setup

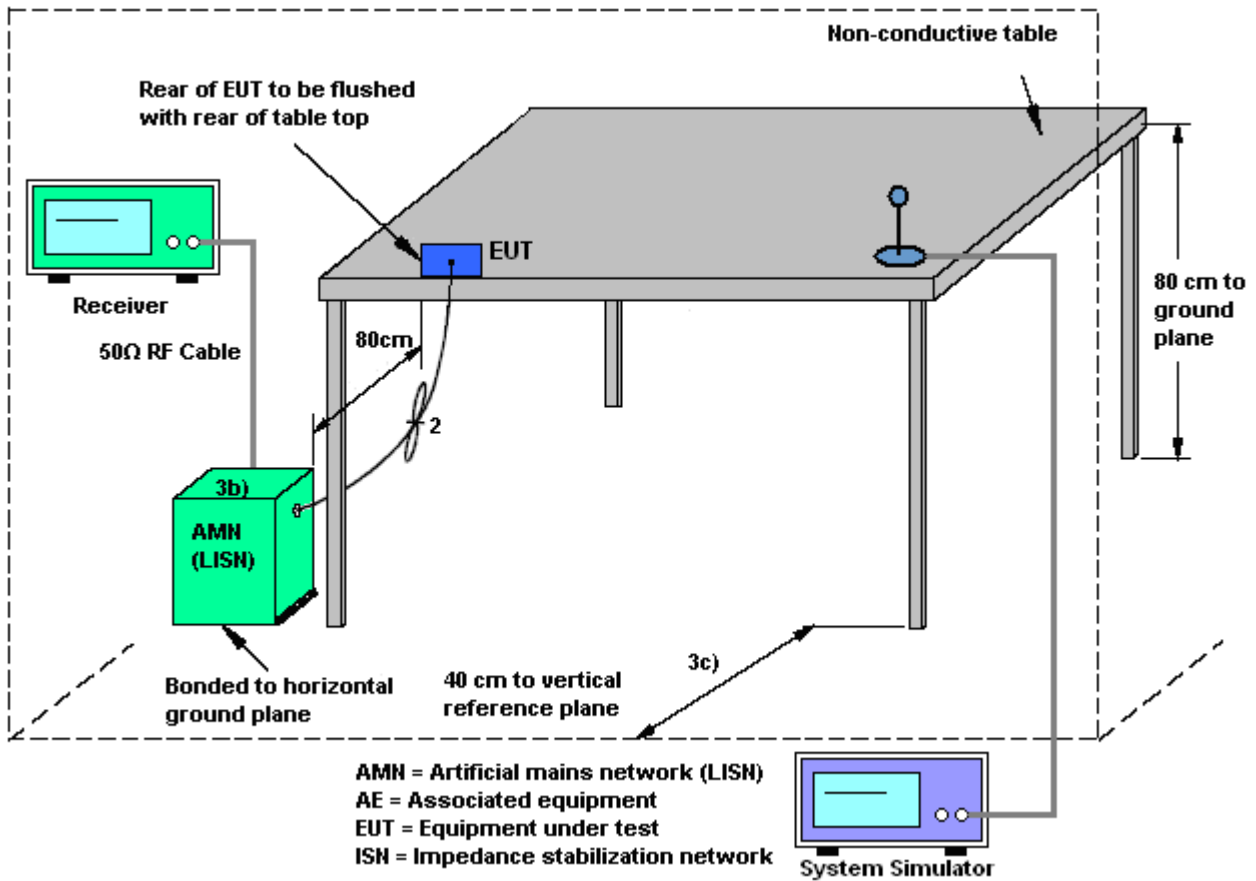

3.3 Test Result of Conducted Emission Test

Please refer to Appendix A.



3.4 AC Power Line Conducted Emissions Measurement

3.4.1 Limit

For equipment that is designed to be connected to the public utility (AC) power line, the radio frequency voltage that is conducted back onto the AC power line on any frequency or frequencies within the band 150 kHz to 30 MHz shall not exceed the limits in the following table.

Frequency of Emission (MHz)	Conducted Limit (dBµV)	
	Quasi-Peak	Average
0.15-0.5	66 to 56*	56 to 46*
0.5-5	56	46
5-30	60	50

*Decreases with the logarithm of the frequency.

3.4.2 Test Procedures

1. The EUT was placed 0.4 meter from the conducting wall of the shielding room, and it was kept at least 80 centimeters from any other grounded conducting surface.
2. Connect EUT to the power mains through a line impedance stabilization network (LISN).
3. All the support units are connecting to the other LISN.
4. The LISN provides 50 ohm coupling impedance for the measuring instrument.
5. The FCC states that a 50 ohm, 50 microhenry LISN should be used.
6. Both sides of AC line were checked for maximum conducted interference.
7. The frequency range from 150 kHz to 30 MHz was searched.
8. Set the test-receiver system to Peak Detect Function and specified bandwidth with Maximum Hold Mode.
9. Compliance with the limit is tested using a receiver with RBW set to a 9kHz

4. CONDUCTED TEST ITEMS

4.1 Measuring Instruments

See list of measuring instruments of this test report.

4.2 Test Setup

4.2.1 20dB Spectrum Bandwidth

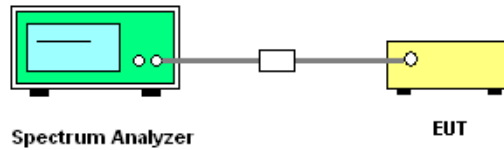

4.2.2 Frequency Stability

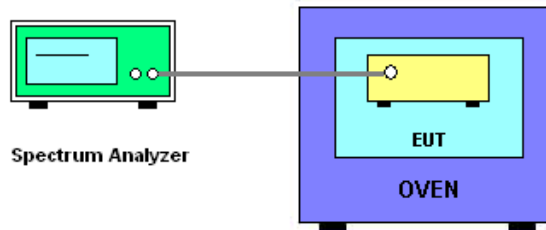

4.3 Test Result of Conducted Test Items

Please refer to Appendix B.



4.4 20dB Spectrum Bandwidth Measurement

4.4.1 Limit

Intentional radiators must be designed to ensure that the 20 dB bandwidth of the emissions in the specific band 13.553~13.567MHz

4.4.2 Test Procedures

1. The transmitter output (antenna port) was connected to the spectrum analyzer in peak Max hold mode.
2. The resolution bandwidth of 1 kHz and the video bandwidth of 3 kHz were used.
3. Measured the spectrum width with power higher than 20dB below carrier.

4.5 Frequency Stability Measurement

4.5.1 Limit

The frequency tolerance of the carrier signal shall be maintained within +/- 0.01% (100ppm) of the operating frequency over a temperature variation of -20 degrees to +50 degrees C at normal supply voltage, and for a variation in the primary supply voltage from 85% to 115% of the rated supply voltage at a temperature of 20 degrees C. For battery operated equipment, the equipment tests shall be performed using a new battery.

4.5.2 Test Procedures

1. The transmitter output (antenna port) was connected to the spectrum analyzer.
2. EUT have transmitted signal and fixed channelize.
3. Set the spectrum analyzer span to view the entire emissions bandwidth.
4. Set RBW = 1 kHz, VBW = 3 kHz with peak detector and maxhold settings.
5. The fc is declaring of channel frequency. Then the frequency error formula is $(f_c - f) / f_c \times 10^6$ ppm and the limit is less than ± 100 ppm.
6. Extreme temperature rule is -20°C~50°C.

5. RADIATED TEST ITEMS

5.1 Measuring Instruments

See list of measuring instruments of this test report.

5.2 Test Setup

5.2.1 For radiated emissions below 30MHz

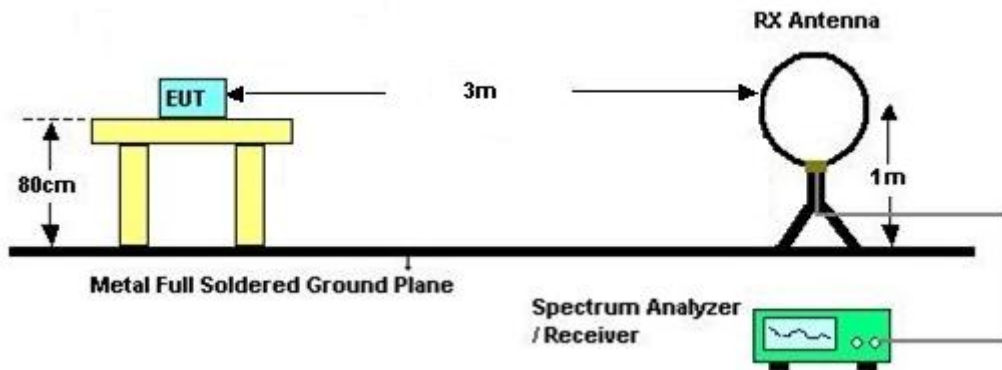

5.2.2 For radiated emissions above 30MHz

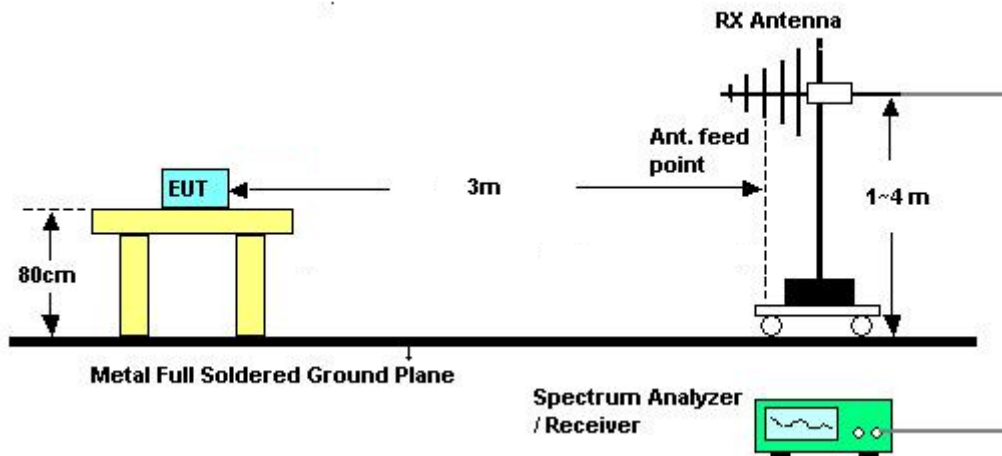

5.3 Test Result of Radiated Test Items

Please refer to Appendix C.



5.4 Field Strength of Fundamental Emissions and Mask Measurement

5.4.1 Limit

Rules and specifications	CFR 47 Part 15 section 15.225(a)-(d)			
Description	Compliance with the spectrum mask is tested using a spectrum analyzer with RBW set to a 9kHz for the band 13.553~13.567MHz			
Freq. of Emission (MHz)	Field Strength (μV/m) at 30m	Field Strength (dBμV/m) at 30m	Field Strength (dBμV/m) at 10m	Field Strength (dBμV/m) at 3m
1.705~13.110	30	29.5	48.58	69.5
13.110~13.410	106	40.5	59.58	80.5
13.410~13.553	334	50.5	69.58	90.5
13.553~13.567	15848	84.0	103.08	124.0
13.567~13.710	334	50.5	69.58	90.5
13.710~14.010	106	40.5	59.58	80.5
14.010~30.000	30	29.5	48.58	69.5

5.4.2 Test Procedures

1. Configure the EUT according to ANSI C63.4. The EUT was placed on the top of the turntable 0.8 meter above ground. The phase center of the loop receiving antenna mounted antenna tower was placed 3 meters far away from the turntable.
2. Power on the EUT and all the supporting units. The turntable was rotated by 360 degrees to determine the position of the highest radiation.
3. The height of the receiving antenna was fixed at one meter above ground to find the maximum emissions field strength.
4. For Fundamental emissions, use the receiver to measure QP reading.
5. When the radiated emissions limits are expressed in terms of the average value of the emissions, and pulsed operation is employed, the measurement field strength shall be determined by averaging over one complete pulse train, including blanking intervals, as long as the pulse train does not exceed 0.1 seconds. As an alternative (provided the transmitter operates for longer than 0.1 seconds) or in cases where the pulse train exceeds 0.1 seconds, the measured field strength shall be determined from the average absolute voltage during a 0.1 second interval during which the field strength is at its maximum value.
6. Compliance with the spectrum mask is tested using a spectrum analyzer with RBW set to a 9kHz for the band 13.553~13.567MHz.

Note: Emission level (dBμV/m) = 20 log Emission level (μV/m).



5.5 Radiated Emissions Measurement

5.5.1 Limit

The field strength of any emissions which appear outside of 13.553~13.567MHz band shall not exceed the general radiated emissions limits.

Frequencies (MHz)	Field Strength (µV/m)	Measurement Distance (meters)
0.009~0.490	2400/F(kHz)	300
0.490~1.705	24000/F(kHz)	30
1.705~30.0	30	30
30~88	100	3
88~216	150	3
216~960	200	3
Above 960	500	3

5.5.2 Measuring Instrument Setting

The following table is the setting of receiver.

Receiver Parameter	Setting
Attenuation	Auto
Frequency Range: 9kHz~150kHz	RBW 200Hz for QP
Frequency Range: 150kHz~30MHz	RBW 9kHz for QP
Frequency Range: 30MHz~1000MHz	RBW 120kHz for Peak

Note: The emission limits shown in the above table are based on measurements employing a CISPR quasi-peak detector except for the frequency bands 9-90 kHz, 110-490 kHz. Radiated emission limits in these two bands are based on measurements employing an average detector.



5.5.3 Test Procedures

1. Configure the EUT according to ANSI C63.4. The EUT was placed on the top of the turntable 0.8 meter above ground. The phase center of the receiving antenna mounted on the top of a height-variable antenna tower was placed 3 meters far away from the turntable.
2. Power on the EUT and all the supporting units. The turntable was rotated by 360 degrees to determine the position of the highest radiation.
3. The height of the broadband receiving antenna was varied between one meter and four meters above ground to find the maximum emissions field strength of both horizontal and vertical polarization.
4. For each suspected emissions, the antenna tower was scan (from 1 M to 4 M) and then the turntable was rotated (from 0 degree to 360 degrees) to find the maximum reading.
5. Set the test-receiver system to Peak or CISPR quasi-peak Detect Function with specified bandwidth under Maximum Hold Mode.
6. When the radiated emissions limits are expressed in terms of the average value of the emissions, and pulsed operation is employed, the measurement field strength shall be determined by averaging over one complete pulse train, including blanking intervals, as long as the pulse train does not exceed 0.1 seconds. As an alternative (provided the transmitter operates for longer than 0.1 seconds) or in cases where the pulse train exceeds 0.1 seconds, the measured field strength shall be determined from the average absolute voltage during a 0.1 second interval during which the field strength is at its maximum value.
7. In case the emission is lower than 30MHz, loop antenna has to be used for measurement and the recorded data should be QP measured by receiver. Antenna Requirements

5.5.4 Limit

Except for special regulations, the Low-power Radio-frequency Devices must not be equipped with any jacket for installing an antenna with extension cable. An intentional radiator shall be designed to ensure that no antenna other than that furnished by the responsible party shall be used with the device. The use of a permanently attached antenna or of an antenna that uses a unique coupling to the intentional radiator shall be considered sufficient to comply with the provisions of this Section. The manufacturer may design the unit so that the user can replace a broken antenna, but the use of a standard antenna jack or electrical connector is prohibited.

5.5.5 Antenna Anti-Replacement Construction

An embedded-in antenna design is used.



6. LIST OF MEASURING EQUIPMENT

Instrument	Manufacturer	Model No.	Serial No.	Characteristics	Calibration Date	Test Date	Due Date	Remark
Spectrum Analyzer	Rohde & Schwarz	FSP40	100055	9kHz~40GHz	Jun. 09, 2014	Jul. 24, 2014	Jun. 08, 2015	Conducted (TH02-HY)
Thermal Chamber	Ten Billion	TTH-D3SP	TBN-930701	N/A	Jul. 17, 2014	Jul. 24, 2014	Jul. 16, 2015	Conducted (TH02-HY)
EMI Test Receiver	Rohde & Schwarz	ESCS 30	100356	9kHz ~ 2.75GHz	Nov. 15, 2013	Jul. 29, 2014 ~ Aug. 01, 2014	Nov. 14, 2014	Conduction (CO05-HY)
LISN (for auxiliary equipment)	Rohde & Schwarz	ENV216	100081	9kHz ~ 30MHz	Dec. 12, 2013	Jul. 29, 2014 ~ Aug. 01, 2014	Dec. 11, 2014	Conduction (CO05-HY)
LISN	Rohde & Schwarz	ENV216	100080	9kHz ~ 30MHz	Dec. 04, 2013	Jul. 29, 2014 ~ Aug. 01, 2014	Dec. 03, 2014	Conduction (CO05-HY)
AC Power Source	ChainTek	APC-1000W	N/A	N/A	N/A	Jul. 29, 2014 ~ Aug. 01, 2014	N/A	Conduction (CO05-HY)
EMI Test Receiver	Rohde & Schwarz	ESCI 7	100724	9kHz~7GHz	Sep. 06, 2013	Jul. 30, 2014	Sep. 05, 2014	Radiation (03CH07-HY)
Loop Antenna	Rohde & Schwarz	HFH2-Z2	100330	9 kHz~30 MHz	Nov. 15, 2014	Jul. 30, 2014	Nov. 14, 2014	Radiation (03CH07-HY)
Bilog Antenna	Schaffner	CBL6111C	2726	30MHz ~ 1GHz	Oct. 10, 2013	Jul. 30, 2014	Oct. 09, 2014	Radiation (03CH07-HY)
Preamplifier	COM-POWER	PA-103A	161241	10 MHz ~ 1000MHz	Mar. 17, 2014	Jul. 30, 2014	Mar. 16, 2015	Radiation (03CH07-HY)
Turn Table	ChainTek	ChainTek 3000	N/A	0 ~ 360 degree	N/A	Jul. 30, 2014	N/A	Radiation (03CH07-HY)
Antenna Mast	ChainTek	ChainTek 3000	N/A	N/A	N/A	Jul. 30, 2014	N/A	Radiation (03CH07-HY)

Appendix A. Test Results of Conducted Emission Test

<EUT with Antenna>

Test Mode :	NFC Tx	Test Voltage :	120Vac / 60Hz
Function Type :	GSM850 Idle + Bluetooth Link + WLAN Link + USB Cable (Charging from Adapter) + Earphone + NFC Tx		

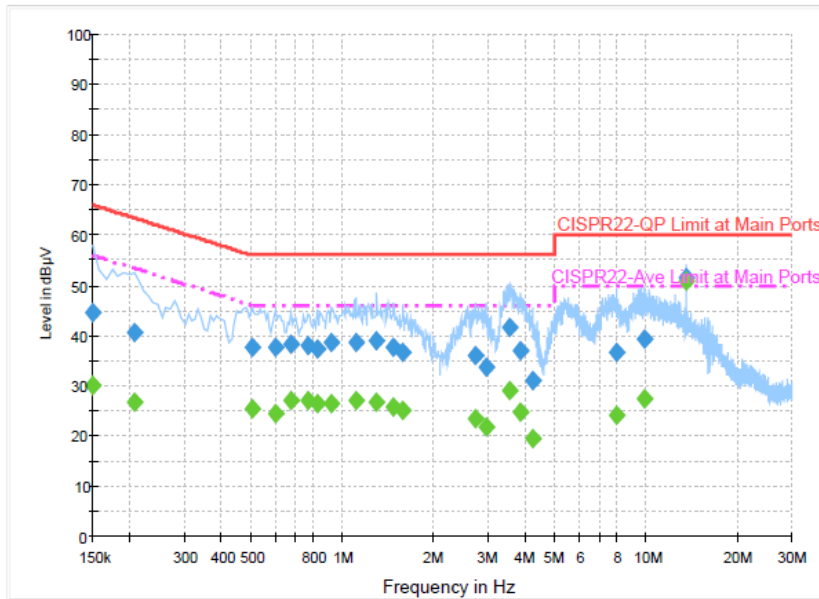

Final Result : Quasi-Peak

Frequency (MHz)	Quasi-Peak (dBµV)	Filter	Line	Corr. (dB)	Margin (dB)	Limit (dBµV)
0.150000	44.6	Off	L1	19.3	21.4	66.0
0.206000	40.4	Off	L1	19.3	23.0	63.4
0.502000	37.5	Off	L1	19.4	18.5	56.0
0.598000	37.6	Off	L1	19.4	18.4	56.0
0.678000	38.3	Off	L1	19.5	17.7	56.0
0.766000	38.1	Off	L1	19.5	17.9	56.0
0.822000	37.2	Off	L1	19.5	18.8	56.0
0.918000	38.5	Off	L1	19.4	17.5	56.0
1.102000	38.7	Off	L1	19.4	17.3	56.0
1.294000	38.8	Off	L1	19.5	17.2	56.0
1.470000	37.6	Off	L1	19.5	18.4	56.0
1.574000	36.8	Off	L1	19.4	19.2	56.0
2.734000	36.1	Off	L1	19.5	19.9	56.0
2.950000	33.7	Off	L1	19.5	22.3	56.0
3.518000	41.5	Off	L1	19.6	14.5	56.0
3.854000	36.8	Off	L1	19.5	19.2	56.0
4.206000	31.1	Off	L1	19.6	24.9	56.0
7.990000	36.7	Off	L1	19.6	23.3	60.0
9.854000	39.3	Off	L1	19.7	20.7	60.0
13.558000	51.6	Off	L1	19.8	8.4	60.0



Test Mode :	NFC Tx	Test Voltage :	120Vac / 60Hz
Function Type :	GSM850 Idle + Bluetooth Link + WLAN Link + USB Cable (Charging from Adapter) + Earphone + NFC Tx		

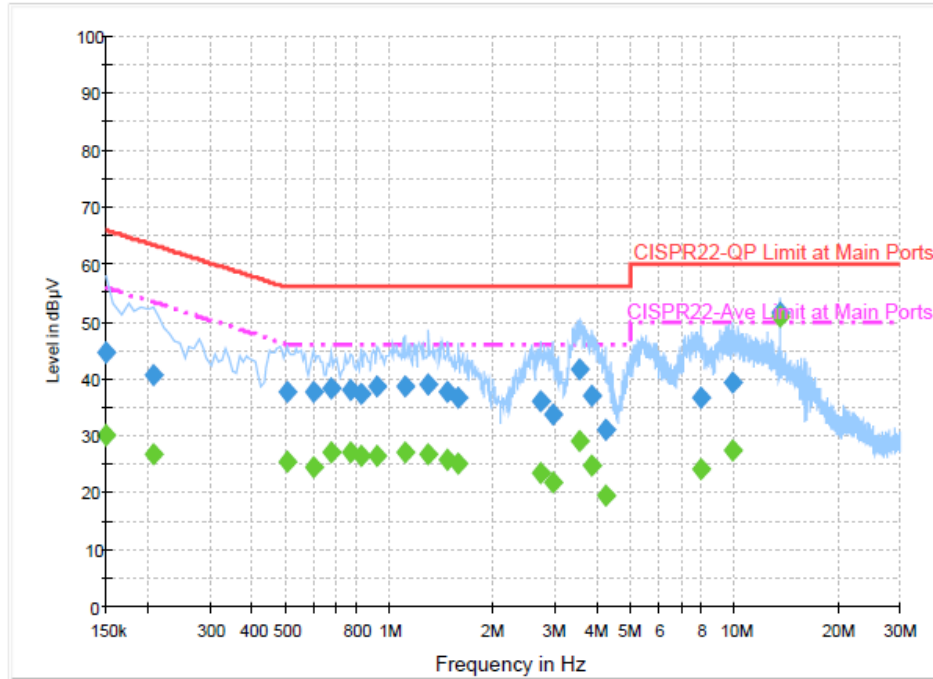

Final Result : Average

Frequency (MHz)	Average (dBµV)	Filter	Line	Corr. (dB)	Margin (dB)	Limit (dBµV)
0.150000	30.2	Off	L1	19.3	25.8	56.0
0.206000	26.8	Off	L1	19.3	26.6	53.4
0.502000	25.5	Off	L1	19.4	20.5	46.0
0.598000	24.3	Off	L1	19.4	21.7	46.0
0.678000	27.0	Off	L1	19.5	19.0	46.0
0.766000	27.0	Off	L1	19.5	19.0	46.0
0.822000	26.5	Off	L1	19.5	19.5	46.0
0.918000	26.5	Off	L1	19.4	19.5	46.0
1.102000	27.0	Off	L1	19.4	19.0	46.0
1.294000	26.6	Off	L1	19.5	19.4	46.0
1.470000	25.9	Off	L1	19.5	20.1	46.0
1.574000	25.2	Off	L1	19.4	20.8	46.0
2.734000	23.4	Off	L1	19.5	22.6	46.0
2.950000	21.7	Off	L1	19.5	24.3	46.0
3.518000	28.9	Off	L1	19.6	17.1	46.0
3.854000	24.7	Off	L1	19.5	21.3	46.0
4.206000	19.5	Off	L1	19.6	26.5	46.0
7.990000	24.2	Off	L1	19.6	25.8	50.0
9.854000	27.3	Off	L1	19.7	22.7	50.0
13.558000	50.7	Off	L1	19.8	-0.7	50.0

Note : The 13.558MHz can be excluded due to NFC fundamental signal.



Test Mode :	NFC Tx	Test Voltage :	120Vac / 60Hz
Function Type :	GSM850 Idle + Bluetooth Link + WLAN Link + USB Cable (Charging from Adapter) + Earphone + NFC Tx		

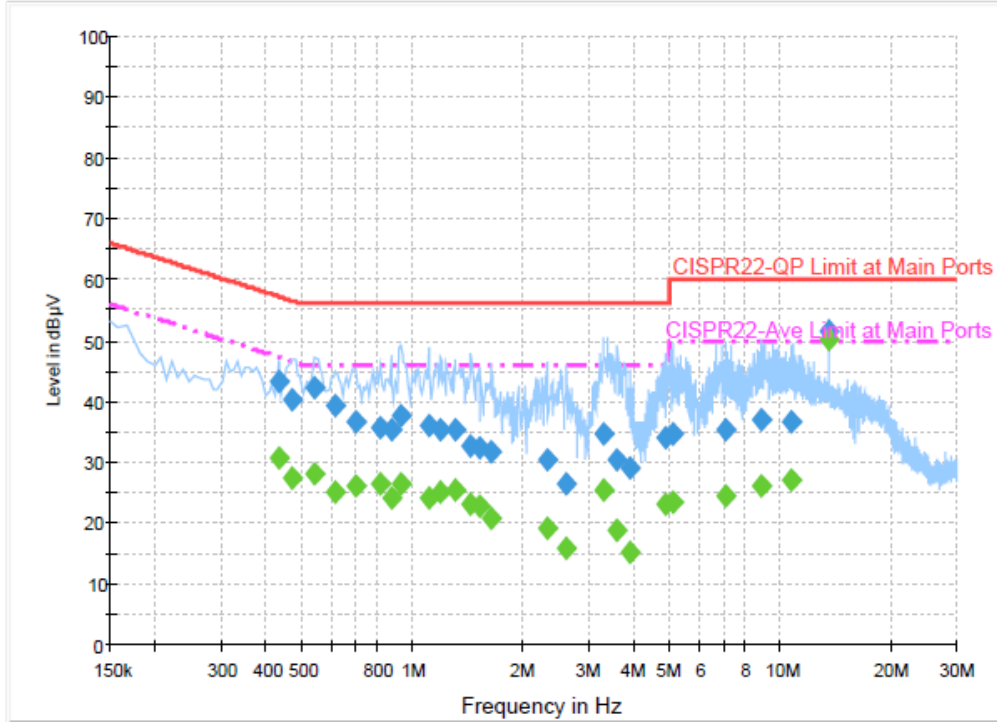

Final Result : Quasi-Peak

Frequency (MHz)	Quasi-Peak (dBµV)	Filter	Line	Corr. (dB)	Margin (dB)	Limit (dBµV)
0.430000	43.1	Off	N	19.4	14.2	57.3
0.470000	40.1	Off	N	19.5	16.4	56.5
0.542000	42.1	Off	N	19.4	13.9	56.0
0.614000	39.1	Off	N	19.4	16.9	56.0
0.702000	36.6	Off	N	19.5	19.4	56.0
0.814000	35.7	Off	N	19.5	20.3	56.0
0.870000	35.3	Off	N	19.5	20.7	56.0
0.926000	37.6	Off	N	19.5	18.4	56.0
1.102000	35.9	Off	N	19.4	20.1	56.0
1.190000	35.4	Off	N	19.5	20.6	56.0
1.302000	35.4	Off	N	19.5	20.6	56.0
1.438000	32.8	Off	N	19.6	23.2	56.0
1.510000	32.3	Off	N	19.5	23.7	56.0
1.638000	31.6	Off	N	19.5	24.4	56.0



Test Mode :	NFC Tx	Test Voltage :	120Vac / 60Hz
Function Type :	GSM850 Idle + Bluetooth Link + WLAN Link + USB Cable (Charging from Adapter) + Earphone + NFC Tx		

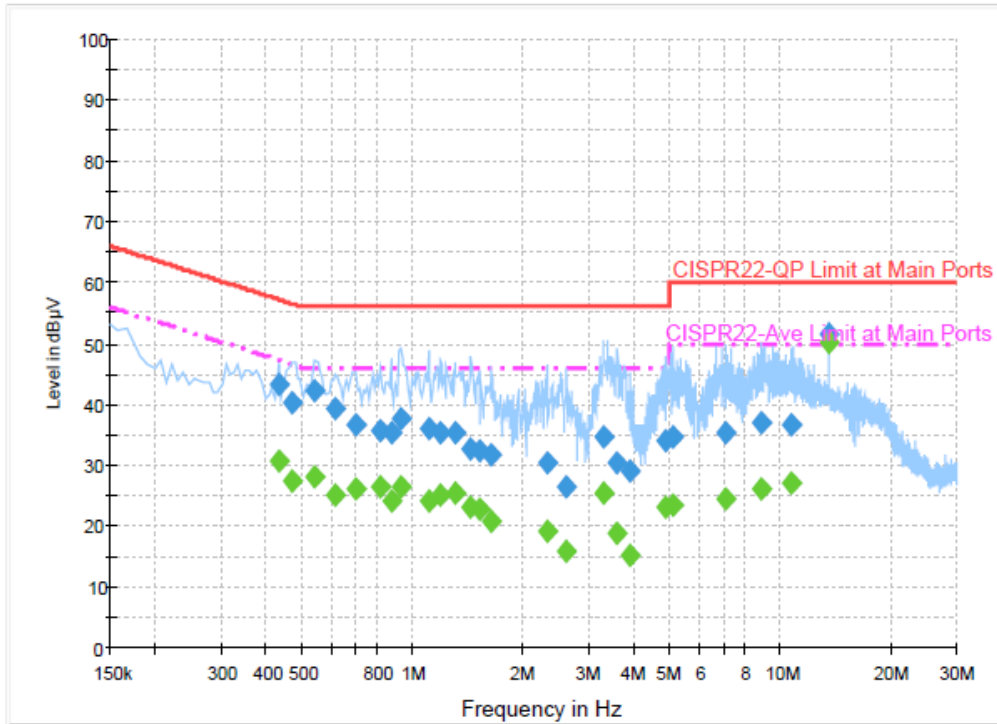

Final Result : Quasi-Peak

Frequency (MHz)	Quasi-Peak (dBµV)	Filter	Line	Corr. (dB)	Margin (dB)	Limit (dBµV)
2.310000	30.2	Off	N	19.5	25.8	56.0
2.614000	26.5	Off	N	19.5	29.5	56.0
3.294000	34.7	Off	N	19.6	21.3	56.0
3.598000	30.3	Off	N	19.5	25.7	56.0
3.878000	29.1	Off	N	19.6	26.9	56.0
4.878000	34.0	Off	N	19.6	22.0	56.0
5.070000	34.7	Off	N	19.6	25.3	60.0
7.078000	35.2	Off	N	19.6	24.8	60.0
8.870000	36.9	Off	N	19.8	23.1	60.0
10.678000	36.5	Off	N	19.7	23.5	60.0
13.558000	51.6	Off	N	19.8	8.4	60.0



Test Mode :	NFC Tx	Test Voltage :	120Vac / 60Hz
Function Type :	GSM850 Idle + Bluetooth Link + WLAN Link + USB Cable (Charging from Adapter) + Earphone + NFC Tx		

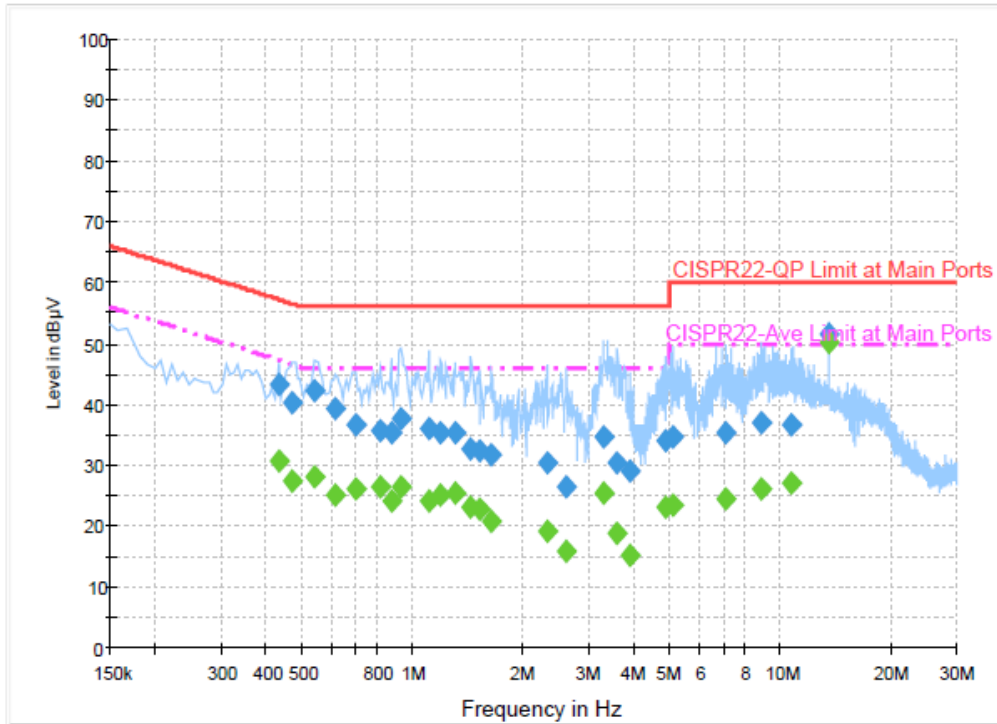

Final Result : Average

Frequency (MHz)	Average (dBµV)	Filter	Line	Corr. (dB)	Margin (dB)	Limit (dBµV)
0.430000	30.8	Off	N	19.4	16.5	47.3
0.470000	27.5	Off	N	19.5	19.0	46.5
0.542000	27.9	Off	N	19.4	18.1	46.0
0.614000	25.2	Off	N	19.4	20.8	46.0
0.702000	25.9	Off	N	19.5	20.1	46.0
0.814000	26.5	Off	N	19.5	19.5	46.0
0.870000	24.1	Off	N	19.5	21.9	46.0
0.926000	26.4	Off	N	19.5	19.6	46.0
1.102000	24.2	Off	N	19.4	21.8	46.0
1.190000	25.1	Off	N	19.5	20.9	46.0
1.302000	25.3	Off	N	19.5	20.7	46.0
1.438000	23.0	Off	N	19.6	23.0	46.0
1.510000	22.7	Off	N	19.5	23.3	46.0
1.638000	20.7	Off	N	19.5	25.3	46.0



Test Mode :	NFC Tx	Test Voltage :	120Vac / 60Hz
Function Type :	GSM850 Idle + Bluetooth Link + WLAN Link + USB Cable (Charging from Adapter) + Earphone + NFC Tx		

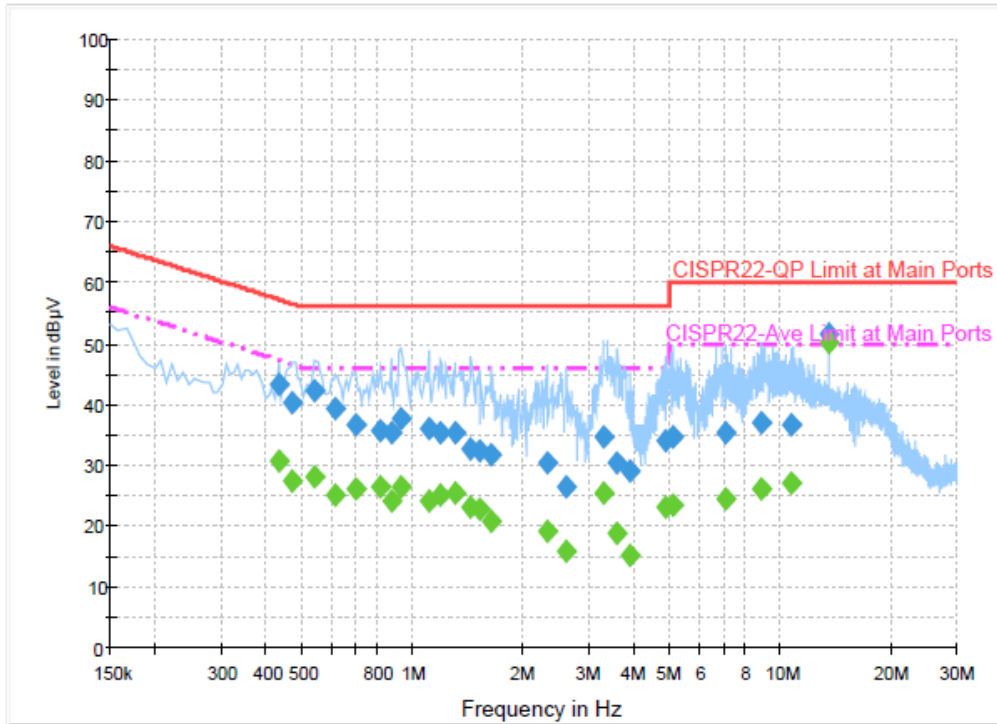

Final Result : Average

Frequency (MHz)	Average (dBµV)	Filter	Line	Corr. (dB)	Margin (dB)	Limit (dBµV)
2.310000	19.3	Off	N	19.5	26.7	46.0
2.614000	15.7	Off	N	19.5	30.3	46.0
3.294000	25.3	Off	N	19.6	20.7	46.0
3.598000	18.9	Off	N	19.5	27.1	46.0
3.878000	15.3	Off	N	19.6	30.7	46.0
4.878000	22.9	Off	N	19.6	23.1	46.0
5.070000	23.3	Off	N	19.6	26.7	50.0
7.078000	24.5	Off	N	19.6	25.5	50.0
8.870000	26.1	Off	N	19.8	23.9	50.0
10.678000	27.1	Off	N	19.7	22.9	50.0
13.558000	50.1	Off	N	19.8	-0.1	50.0

Note : The 13.558MHz can be excluded due to NFC fundamental signal.



<EUT with dummy load>

Test Mode :	NFC Tx	Test Voltage :	120Vac / 60Hz
Function Type :	GSM850 Idle + Bluetooth Link + WLAN Link + USB Cable (Charging from Adapter) + Earphone + NFC Tx		

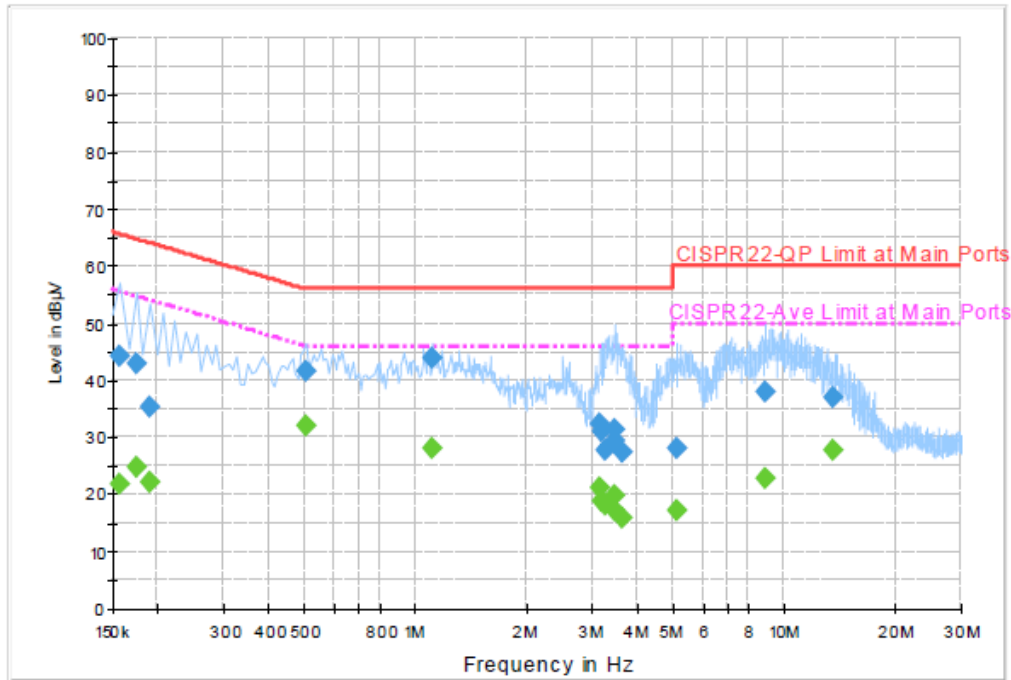

Final Result : Quasi-Peak

Frequency (MHz)	Quasi-Peak (dBµV)	Filter	Line	Corr. (dB)	Margin (dB)	Limit (dBµV)
0.158000	44.2	Off	L1	19.3	21.4	65.6
0.174000	42.9	Off	L1	19.3	21.9	64.8
0.190000	35.4	Off	L1	19.3	28.6	64.0
0.502000	41.6	Off	L1	19.4	14.4	56.0
1.110000	43.9	Off	L1	19.4	12.1	56.0
3.142000	32.4	Off	L1	19.6	23.6	56.0
3.198000	31.0	Off	L1	19.5	25.0	56.0
3.262000	27.8	Off	L1	19.5	28.2	56.0
3.462000	29.4	Off	L1	19.6	26.6	56.0
3.470000	31.4	Off	L1	19.6	24.6	56.0
3.622000	27.4	Off	L1	19.5	28.6	56.0
5.110000	27.9	Off	L1	19.6	32.1	60.0
8.830000	38.0	Off	L1	19.7	22.0	60.0
13.558000	36.9	Off	L1	19.8	23.1	60.0



Test Mode :	NFC Tx	Test Voltage :	120Vac / 60Hz
Function Type :	GSM850 Idle + Bluetooth Link + WLAN Link + USB Cable (Charging from Adapter) + Earphone + NFC Tx		

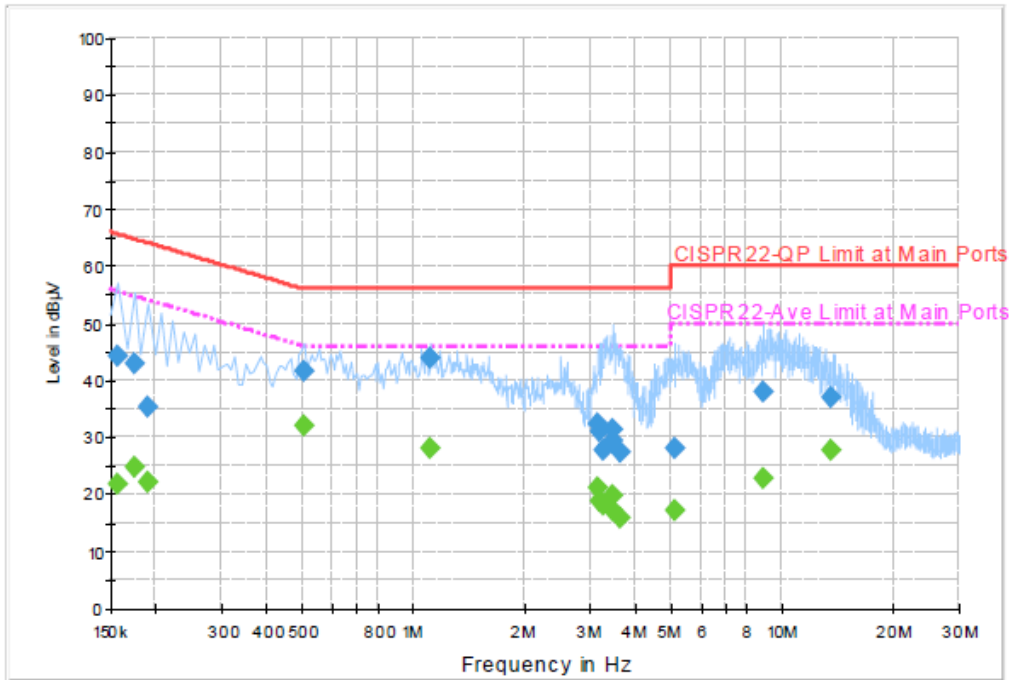

Final Result : Average

Frequency (MHz)	Average (dBµV)	Filter	Line	Corr. (dB)	Margin (dB)	Limit (dBµV)
0.158000	21.8	Off	L1	19.3	33.8	55.6
0.174000	24.8	Off	L1	19.3	30.0	54.8
0.190000	22.0	Off	L1	19.3	32.0	54.0
0.502000	32.1	Off	L1	19.4	13.9	46.0
1.110000	27.9	Off	L1	19.4	18.1	46.0
3.142000	21.1	Off	L1	19.6	24.9	46.0
3.198000	18.9	Off	L1	19.5	27.1	46.0
3.262000	18.3	Off	L1	19.5	27.7	46.0
3.462000	17.2	Off	L1	19.6	28.8	46.0
3.470000	19.7	Off	L1	19.6	26.3	46.0
3.622000	15.8	Off	L1	19.5	30.2	46.0
5.110000	17.3	Off	L1	19.6	32.7	50.0
8.830000	22.9	Off	L1	19.7	27.1	50.0
13.558000	27.6	Off	L1	19.8	22.4	50.0



Test Mode :	NFC Tx	Test Voltage :	120Vac / 60Hz
Function Type :	GSM850 Idle + Bluetooth Link + WLAN Link + USB Cable (Charging from Adapter) + Earphone + NFC Tx		

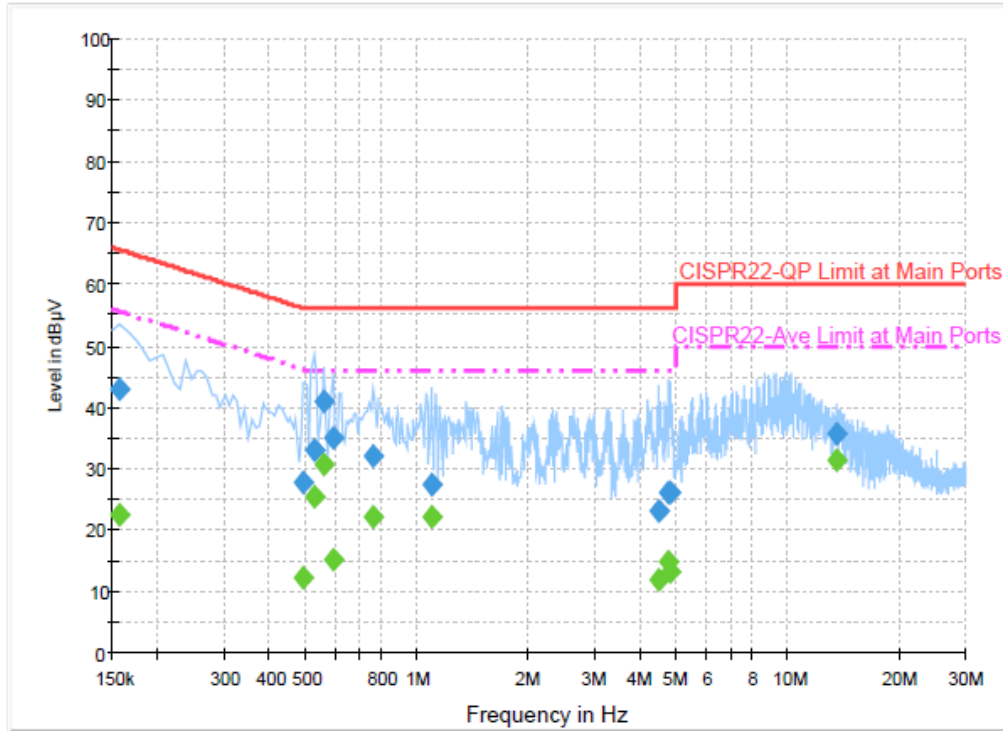

Final Result : Quasi-Peak

Frequency (MHz)	Quasi-Peak (dBµV)	Filter	Line	Corr. (dB)	Margin (dB)	Limit (dBµV)
0.158000	42.8	Off	N	19.4	22.8	65.6
0.494000	27.8	Off	N	19.4	28.3	56.1
0.526000	33.0	Off	N	19.4	23.0	56.0
0.558000	40.9	Off	N	19.4	15.1	56.0
0.590000	35.1	Off	N	19.4	20.9	56.0
0.758000	32.0	Off	N	19.5	24.0	56.0
1.086000	27.2	Off	N	19.5	28.8	56.0
4.478000	23.2	Off	N	19.6	32.8	56.0
4.766000	25.9	Off	N	19.6	30.1	56.0
4.790000	26.1	Off	N	19.6	29.9	56.0
13.558000	35.6	Off	N	19.8	24.4	60.0



Test Mode :	NFC Tx	Test Voltage :	120Vac / 60Hz
Function Type :	GSM850 Idle + Bluetooth Link + WLAN Link + USB Cable (Charging from Adapter) + Earphone + NFC Tx		

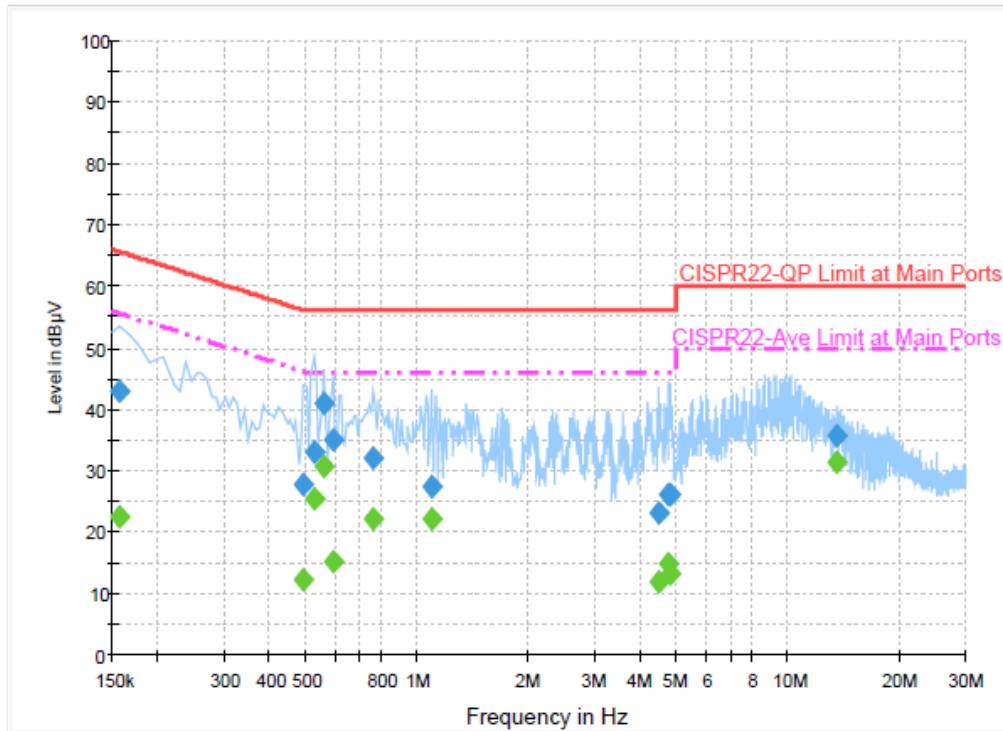

Final Result : Average

Frequency (MHz)	Average (dBµV)	Filter	Line	Corr. (dB)	Margin (dB)	Limit (dBµV)
0.158000	22.4	Off	N	19.4	33.2	55.6
0.494000	12.2	Off	N	19.4	33.9	46.1
0.526000	25.5	Off	N	19.4	20.5	46.0
0.558000	30.6	Off	N	19.4	15.4	46.0
0.590000	15.2	Off	N	19.4	30.8	46.0
0.758000	22.2	Off	N	19.5	23.8	46.0
1.086000	22.0	Off	N	19.5	24.0	46.0
4.478000	12.0	Off	N	19.6	34.0	46.0
4.766000	14.7	Off	N	19.6	31.3	46.0
4.790000	13.3	Off	N	19.6	32.7	46.0
13.558000	31.4	Off	N	19.8	18.6	50.0



Appendix B. Test Results of Conducted Test Items

C.1 Test Result of 20dB Spectrum Bandwidth

Test mode	NFC Tx	Test Frequency (MHz)	13.56
Date: 24.JUL.2014 15:23:58		Date: 24.JUL.2014 15:37:48	
20dB Bandwidth (kHz)	2.640	99% Occupied BW(kHz)	2.240
Frequency range (MHz)	$f_L > 13.553$	13.55870	Test Result
	$f_H < 13.567$	13.56094	Complies



C.2 Test Result of Frequency Stability

Voltage vs. Frequency Stability		Temperature vs. Frequency Stability	
Voltage (Vac)	Measurement Frequency (MHz)	Temperature (°C)	Measurement Frequency (MHz)
120	13.559810	-20	13.559900
102	13.559820	-10	13.559880
138	13.559820	0	13.559880
		10	13.559840
		20	13.559830
		30	13.559820
		40	13.559800
		50	13.559790
Max.Deviation (MHz)	-0.000190	Max.Deviation (MHz)	-0.000210
Max.Deviation (ppm)	-14.0118	Max.Deviation (ppm)	-15.4867
Limit	FS < ±100 ppm	Limit	FS < ±100 ppm
Test Result	PASS	Test Result	PASS

Note : The test was also verified by a full charged battery and the result was not significantly changed.



Appendix C. Test Results of Radiated Test Items

D.1 Test Result of Field Strength of Fundamental Emissions

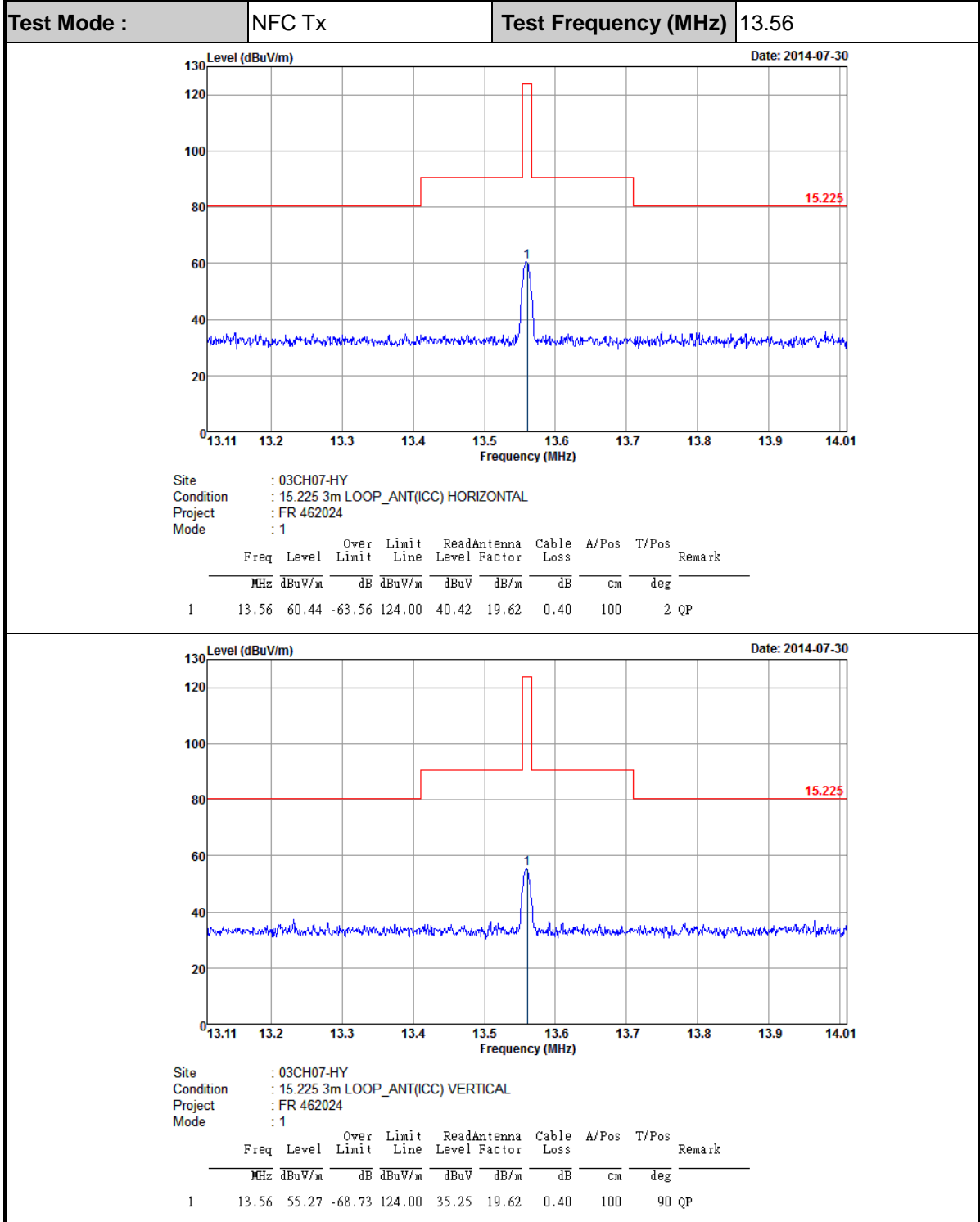

Note: All NFC's spurious emissions are below 20dB of limits.



D.2 Results of Radiated Emissions (9 kHz~30MHz)

Test Mode :		NFC Tx			Polarization :		Horizontal			
Frequency (MHz)	Level (dBμV/m)	Over Limit (dB)	Limit Line (dBμV/m)	Read Level (dBμV)	Antenna Factor (dB)	Cable Loss (dB)	Preamp Factor (dB)	Ant Pos (cm)	Table Pos (deg)	Remark
0.01339	33.12	-91.95	125.07	12.55	20.28	0.29	-	-	-	Average
0.07098	23.45	-87.13	110.58	3.09	20.07	0.29	-	-	-	Average
0.0924	20.95	-87.34	108.29	0.61	20.05	0.29	-	-	-	QP
0.14172	22.28	-82.3	104.58	1.97	20.02	0.29	-	-	-	Average
0.45702	39.95	-54.46	94.41	19.76	19.9	0.29	-	-	-	Average
1.752	44.57	-25.43	70	24.3	19.94	0.33	-	100	47	QP
10.376	35.58	-34.42	70	15.44	19.75	0.39	-	-	-	QP
13.56	61.31	-8.69	70	41.29	19.62	0.4	-	-	-	QP
18.925	37.44	-32.56	70	17.07	19.94	0.43	-	-	-	QP
29.085	36.35	-33.65	70	15.53	20.31	0.51	-	-	-	QP



Test Mode :		NFC Tx			Polarization :		Vertical			
Frequency (MHz)	Level (dB μ V/m)	Over Limit (dB)	Limit Line (dB μ V/m)	Read Level (dB μ V)	Antenna Factor (dB)	Cable Loss (dB)	Preamp Factor (dB)	Ant Pos (cm)	Table Pos (deg)	Remark
0.01283	36.75	-88.69	125.44	16.18	20.28	0.29	-	-	-	Average
0.07872	23.04	-86.64	109.68	2.68	20.07	0.29	-	-	-	Average
0.09676	21.89	-86	107.89	1.55	20.05	0.29	-	-	-	QP
0.14172	23.99	-80.59	104.58	3.68	20.02	0.29	-	-	-	Average
0.45702	44.06	-50.35	94.41	23.87	19.9	0.29	-	-	-	Average
1.316	37.78	-27.44	65.22	17.54	19.93	0.31	-	100	307	QP
9.592	36.56	-33.44	70	16.41	19.76	0.39	-	-	-	QP
13.56	56.89	-13.11	70	36.87	19.62	0.4	-	-	-	QP
21.094	37.96	-32.04	70	17.42	20.11	0.43	-	-	-	QP
25.62	35.95	-34.05	70	15.15	20.33	0.47	-	-	-	QP

Note:

1. 13.56 MHz is fundamental signal which can be ignored.
2. The amplitude of spurious emissions which are attenuated by more than 20dB below the permissible value has no need to be reported.
3. Distance extrapolation factor = $40 \log (\text{specific distance} / \text{test distance})$ (dB);
4. Limit line = specific limits (dB μ V) + distance extrapolation factor.



D.3 Results of Radiated Emissions (30MHz~1GHz)

Test Mode :	NFC Tx	Polarization :	Horizontal
-------------	--------	----------------	------------

Frequency (MHz)	Level (dBμV/m)	Over Limit (dB)	Limit Line (dBμV/m)	Read Level (dBμV)	Antenna Factor (dB)	Cable Loss (dB)	Preamp Factor (dB)	Ant Pos (cm)	Table Pos (deg)	Remark
58.89	28.29	-11.71	40	52.74	6.08	0.75	31.28	-	-	Peak
106.95	32.09	-11.41	43.5	51.61	10.62	1.03	31.17	-	-	Peak
161.76	35.93	-7.57	43.5	55.67	10.22	1.22	31.18	114	51	Peak
406.4	19.4	-26.6	46	32.02	16.09	2.16	30.87	-	-	Peak
591.9	22.82	-23.18	46	31.26	19.52	2.67	30.63	-	-	Peak
865.6	26.81	-19.19	46	30.79	23.1	3.29	30.37	-	-	Peak

Test Mode :	NFC Tx	Polarization :	Vertical
-------------	--------	----------------	----------

Frequency (MHz)	Level (dBμV/m)	Over Limit (dB)	Limit Line (dBμV/m)	Read Level (dBμV)	Antenna Factor (dB)	Cable Loss (dB)	Preamp Factor (dB)	Ant Pos (cm)	Table Pos (deg)	Remark
31.62	34.97	-5.03	40	48.08	17.76	0.55	31.42	125	278	Peak
91.02	29.61	-13.89	43.5	50.96	8.8	0.95	31.1	-	-	Peak
159.33	28.98	-14.52	43.5	48.42	10.54	1.22	31.2	-	-	Peak
440.7	21.72	-24.28	46	33.14	17	2.28	30.7	-	-	Peak
636.7	23.62	-22.38	46	30.95	20.4	2.8	30.53	-	-	Peak
786.5	25.76	-20.24	46	31.03	21.94	3.12	30.33	-	-	Peak

Note:

1. The amplitude of spurious emissions which are attenuated by more than 20dB below the permissible value has no need to be reported.
2. Emission level (dBμV/m) = 20 log Emission level (μV/m).
3. Corrected Reading: Antenna Factor + Cable Loss + Read Level - Preamp Factor= Level.