



motorola
a Google company

HAC Test Report for Near Field Emissions

Tests Requested By: Motorola Mobility, LLC
600 N. US Highway 45
Libertyville, IL 60048

Test Report #: 25510-1
Date of Test: Aug-14-2013
Date of Report: Sep-06-2013

Test Laboratory: Motorola Mobility, LLC - ADR Test Service Laboratory
600 N. US Highway 45
Libertyville, IL 60048

Report Author: Thomas Knipple
Senior Staff Test Engineer

Statement of Compliance: Motorola declares under its sole responsibility that portable cellular telephone FCC ID IHDT56PF3 to which this declaration relates, complies with recommendations and guidelines per FCC 47 CFR §20.19. The measurements were performed to ensure compliance to ANSI C63.19-2011. It also declares that the product was tested in accordance with the appropriate measurement standards, guidelines and recommended practices. Any deviations from these standards, guidelines and recommended practices are noted below:

(none)

Results Summary: M Category = **M3**

©Motorola Mobility, LLC 2013

This test report shall not be reproduced except in full, without written approval of the laboratory. The results and statements contained herein relate only to the items tested. The names of individuals involved may be mentioned only in connection with the statements or results from this report. Motorola encourages all feedback, both positive and negative, on this test report.

Table of Contents

1 Introduction.....3

2 Description of the Device Under Test.....3

 2.1 Signaling Capabilities3

 2.2 Device Conducted Power Measurements.....4

 2.2.1 CDMA.....4

 2.2.2 Wi-Fi4

3 Test Equipment Used.....5

 3.1 SPEAG System5

 3.2 Additional Equipment5

 3.3 Test System Validations.....6

4 Test Methodology, Analysis, and Results.....7

 4.1 Modulation Interference Factor (MIF).....7

 4.2 Evaluation for Test Exemption8

 4.3 DUT and DASY Setup for RF HAC Testing9

 4.4 RF HAC Test Limits and Measurement Results10

- Appendix 1: Distribution Plots for Test System Validations
- Appendix 2: Distribution Plots for RF HAC Measurements
- Appendix 3: Measurement Uncertainty Budget
- Appendix 4: Pictures of Test Setup
- Appendix 5: Probe Calibration Certificates
- Appendix 6: Dipole Characterization Certificates
- Appendix 7: UID Specifications

Revision History

Revision Version	Date	Notes
Rev. 0	Aug-22-2013	Initial report release
Rev. A	Sep-06-2013	Update per FCC inquiry

1 Introduction

The Motorola Mobility ADR Test Services Laboratory has performed Hearing Aid Compatibility (HAC) measurements for the portable cellular phone (FCC ID IHDT56PF3). The portable cellular phone was tested in accordance with the ANSI C63.19-2011 standard. The test results presented herein clearly demonstrate compliance per FCC 47 CFR § 20.19. This report demonstrates compliance for near-field emissions only and not for Telecoil HAC performance compliance.

2 Description of the Device Under Test

Serial Number(s)	LDXZ230024
Production Unit or Identical Prototype (47 CFR §2.908)	Identical Prototype
Device Category	Portable

2.1 Signaling Capabilities

Air Interface	Frequency Bands	Transport Type	Maximum Output Power Setting (dBm)	CMRS Voice Support on Interface?	Evaluated for HAC?	Concurrent Simultaneous Operation with:	Other Concurrent Operation with:	Voice Support via OTT Capability
CDMA	BC0, BC1, BC10	VOICE/DATA	25.0	YES	YES	Wi-Fi, Bluetooth	NONE	YES
Wi-Fi 802.11b/g/n	2.44 GHz	DATA	18.1	YES (1)	YES (1)	CDMA	NONE	YES
Bluetooth	2.44 GHz	DATA	12.1	NO	NO	CDMA	NONE	NO

Note (1): Carrier-specific software will allow the DUT to support voice calls with the ability to seamlessly transition between the cellular transmitter and the Wi-Fi transmitter for network connectivity. Thus, the Wi-Fi transmitter has been evaluated for HAC as part of a CMRS. For the purpose of this report no associated T-coil measurements have been made, in accordance with the guidance issued by the OET in KDB publication 285076 D02 *T-Coil testing for CMRS IP*.

2.2 Device Conducted Power Measurements

2.2.1 CDMA

Conducted Power for CDMA modes evaluated for HAC			
Band	Mode	Channel	Measured Value (dBm)
CDMA BC10	RC1 SO3 1/8 th Rate	564	25.20
CDMA 800	RC1 SO3 1/8 th Rate	1013	24.99
		384	25.20
		777	25.10
CDMA 1900	RC1 SO3 1/8 th Rate	25	24.87
		600	25.00
		1175	24.95

2.2.2 Wi-Fi

Mode	Freq [MHz]	Channel	802.11b (2.4 GHz) Conducted Power [dBm]			
			Data Rate [Mbps]			
			1	2	5.5	11
802.11b	2412	1*	18.17	18.20	18.23	18.21
			20.8	20.83	20.84	20.83
802.11b	2437	6*	18.05	18.04	18.03	18.03
			20.68	20.65	20.67	20.66
802.11b	2462	11*	17.87	17.89	17.86	17.86
			20.6	20.59	20.60	20.60

Mode	Freq [MHz]	Channel	802.11g (2.4 GHz) Conducted Power [dBm]							
			Data Rate [Mbps]							
			6	9	12	18	24	36	48	54
802.11g	2412	1	16.34	16.34	16.34	16.34	15.38	15.35	15.37	14.39
			22.74	22.75	22.77	22.83	22.47	22.41	22.47	21.97
802.11g	2437	6	16.21	16.22	16.24	16.25	15.23	15.18	15.20	14.22
			22.53	22.52	22.61	22.60	22.26	22.21	22.23	21.85
802.11g	2462	11	16.01	16.07	16.03	16.04	14.93	14.92	14.89	13.82
			22.57	22.64	22.65	22.69	22.24	22.20	22.20	21.75

Mode	Freq [MHz]	Channel	802.11n (2.4 GHz - SGI) Conducted Power [dBm]							
			Data Rate [Mbps]							
			MCS0	MCS1	MCS2	MCS3	MCS4	MCS5	MCS6	MCS7
802.11n	2412	1	16.33	16.35	16.38	15.41	15.41	14.40	13.43	12.42
			22.76	22.81	22.78	22.46	22.45	22.00	21.38	20.74
802.11n	2437	6	16.37	16.22	16.26	15.23	15.26	14.27	13.31	12.27
			22.59	22.60	22.61	22.23	22.36	21.75	21.36	20.56
802.11n	2462	11	16.03	16.03	16.04	14.96	14.94	13.88	12.93	11.82
			22.61	22.67	22.61	22.25	22.21	21.79	21.40	20.63

Mode	Freq [MHz]	Channel	802.11n (2.4 GHz - LGI) Conducted Power [dBm]							
			Data Rate [Mbps]							
			MCS0	MCS1	MCS2	MCS3	MCS4	MCS5	MCS6	MCS7
802.11n	2412	1	16.33	16.36	16.34	15.36	15.36	14.39	13.37	12.43
			22.74	22.78	22.80	22.43	22.38	21.90	21.56	20.87
802.11n	2437	6	16.22	16.24	16.22	15.29	15.27	14.26	13.30	12.25
			22.51	22.57	22.58	22.25	22.22	21.82	21.37	20.60
802.11n	2462	11	16.07	16.09	16.09	15.01	14.98	13.87	12.87	11.81
			22.62	22.61	22.66	22.25	22.22	21.77	21.20	20.61

Note: Average power measurements in blue, peak power measurements in black/white.

3 Test Equipment Used

3.1 SPEAG System

The Motorola Mobility ADR Test Services Laboratory utilizes a Dosimetric Assessment System (DASY52™) manufactured by Schmid & Partner Engineering AG (SPEAG™), of Zurich, Switzerland. All HAC measurements are taken within a shielded enclosure. The measurement uncertainty budget is given in Appendix 3. The list of calibrated equipment used for the measurements is shown below.

Description	Serial Number	Cal Date	Cal Due Date
E-Field Probe ER3DV6R	2245	Jun-25-2013	Jun-25-2014
DAE4	1312	Sep-04-2012	Sep-04-2013
835 MHz Dipole CD835V3	1042	Mar-05-2013	Mar-05-2014
1880 MHz Dipole CD1880V3	1059	Mar-05-2013	Mar-05-2014

3.2 Additional Equipment

Description	Serial Number	Cal Due Date	Cal Due Date
Power Supply 6632B	US37360829		
Signal Generator E4438C	MY45092912	Jul-29-2013	Jul-29-2015
Amplifier ZHL-42-SMA	1040		
3 dB Attenuator 8491A	50540	Jul-19-2013	Jul-19-2015
Directional Coupler 778D	18610	Jul-22-2013	Jul-22-2015
Power Meter E4417A	MY45100481	Oct-07-2011	Oct-07-2013
Power Sensor #1 – E9323A	MY51450011	Jun-28-2013	Jun-28-2014
Power Sensor #2 – E9323A	US40412067	Jun-10-2013	Jun-10-2014
10 dB Attenuator 8491A	MY39267955	Jan-23-2013	Jan-23-2015
Spectrum Analyzer E4403B	US39440480	Jul-18-2013	Jul-18-2014
Power Splitter ZAPD-21-S(+)	SU327300437		

3.3 Test System Validations

Validation measurements of the DASY52 test system were performed using the equipment listed in Section 3.1 and Section 3.2. All system validations occur in free space using the DASY test arch for spatial reference. The probe-to-dipole separation is 15 mm, measured from the top edge of the dipole to the calibration reference point of the probe, as specified in ANSI C63.19-2011. System validations were performed at 835 MHz and/or 1880 MHz. The results obtained from the system validations are displayed in the table below. The field contour plots are included in Appendix 1.

System validations were performed to verify that measured E-field values are within $\pm 18\%$ from the target reference values provided by the manufacturer, as specified in the calibration certificates provided in Appendix 6. Per Note 2 in Table 5.1 found in Section 5.4.3.1 of the ANSI C63.19-2011 standard, “Values within $\pm 18\%$ are acceptable, of which 12% is deviation and 13% is measurement uncertainty”. Therefore, the E-field dipole validation results shown in the table below are in accordance with the acceptable parameters defined by the standard.

Dipole Validation Measurement Summary							
Date	Dipole	f (MHz)	Protocol	Input Power (mW)	E-Field Results (V/m)	Target for Dipole (V/m)	% Deviation
Aug-13-2013	1042	835	CW	100	116.35	106.0	+9.8%
Aug-13-2013	1059	1880	CW	100	92.64	90.2	+2.7%

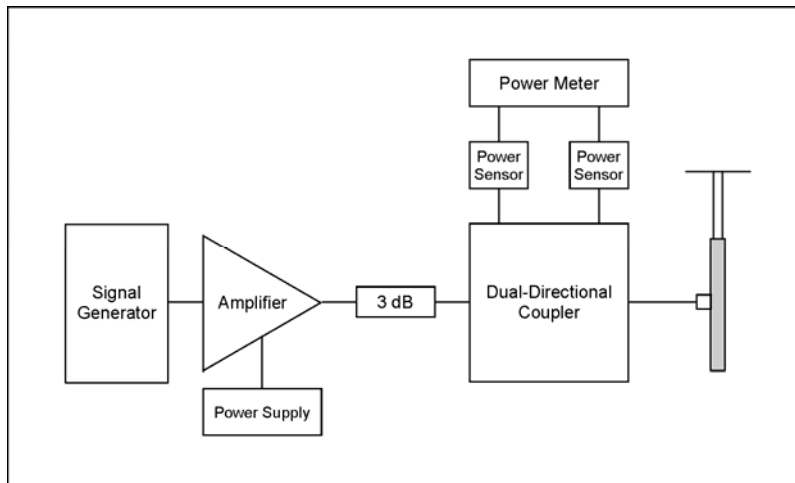

Figure 1: Setup for Validation measurements

4 Test Methodology, Analysis, and Results

4.1 Modulation Interference Factor (MIF)

The ANSI C63.19-2011 HAC standard defines an air-interface agnostic scaling value, called the Modulation Interference Factor (MIF). The MIF replaces the need for the Articulation Weighting Factor (AWF) previously used for RF HAC evaluation, and is applicable to any modulation scheme.

The MIF (in dB) is added to the measured average E-field (in dB V/m) to convert it to the RF Audio Interference Level (in dB V/m). This level considers the audible amplitude modulation components in the RF E-Field. CW fields without amplitude modulation are assumed to not interfere with hearing aid electronics. Modulations without time slots or gating, and low fluctuations at low frequencies, have low MIF values. Time-division modulations with narrow transmission and repetition rates in the range of hundreds of hertz have high MIF values and give similar classifications as per evaluations using ANSI C63.19-2007.

The evaluation method for the MIF is defined in ANSI C6.19-2011 section D.7. An RMS-demodulated RF signal is fed to a spectral filter (similar to an A-weighting filter) and forwarded to a temporal filter acting as a quasi-peak detector. The averaged output of this filtering is compared to a 1 kHz 80% AM signal as reference. It may alternately be determined through analysis and simulation, because the MIF is constrained and characteristic for a given communication signal. DASY52 uses well-defined signals for PMR calibration. The MIF of these signals has been determined by simulation by SPEAG, and is automatically applied.

MIF values used were not measured by the Motorola Mobility ADR Test Services Laboratory, but are instead based on analysis provided by SPEAG for each air interface of interest. SPEAG provides MIF values for each of these air interfaces as given in the table below. The data included in this report are for the worst-case operating modes for each air interface.

SPEAG UID	Communication System Name	MIF (dB)
10039-CAA	CDMA2000 (1xRTT, RC1)	-19.77
10295-AAA	CDMA2000, RC1, SO3, 1/8 th Rate 25 fr.	3.26

ER3D E-Field probes available from SPEAG have a bandwidth less than 10 kHz, and cannot evaluate the RF envelope in the full audio band directly. DASY52 therefore uses the “indirect” measurement method according to ANSI C63.19-2011, which is the preferred method. These near-field probes measure the averaged E-field output of the device under test. Especially for high peak-to-average (PAR) signal types, per SPEAG, the probes shall be linearized by probe modulation response (PMR) calibration in order to take accurate field readings. Per the indirect measurement method, the combination of these probe field readings and the MIF value results in the final RF Audio Interference Level result.

4.2 Evaluation for Test Exemption

Per Clause 4 of ANSI C63.19-2011, an RF air interface technology of a device may be exempted from testing when its average antenna input power plus its MIF is less than or equal to 17 dBm for any of its operating modes. If a device supports multiple RF air interfaces, each RF air interface shall be evaluated individually.

Evaluations for exemption were done using the maximum tune-up power allowed for each air interface noted in the table below, to demonstrate the worst-case operating case for each. Cases where a test exemption cannot be applied are highlighted **in bold**, and measurement results for these cases can be found in Section 4.4. Per Clause 4 of the standard, those air interfaces that are exempted from testing shall be rated M4 for the purposes of RF HAC evaluation.

Air Interface and Band [Mode]	Maximum Average Antenna Input Power (dBm)	MIF (dB)	Input Power plus MIF (dBm)	Exempted from Testing?
CDMA (BC10) [Full Rate]	25.0	-19.77	5.23	YES
CDMA (BC10) [1/8th Rate]	25.0	3.26	28.26	NO
CDMA 800 (BC0) [Full Rate]	25.0	-19.77	5.23	YES
CDMA 800 (BC0) [1/8th Rate]	25.0	3.26	28.26	NO
CDMA 1900 (BC1) [Full Rate]	25.0	-19.77	5.23	YES
CDMA 1900 (BC1) [1/8th Rate]	25.0	3.26	28.26	NO

Per the noted clause of the standard, an RF air interface technology of a device may instead be exempted from testing when its peak antenna input power is less than or equal to 23 dBm for any of its operating modes.

Evaluation for exemption of the Wi-Fi transmitter was done using the peak antenna input power supported by the DUT, as provided in section 2.2.2 above. Per Clause 4 of the standard, the Wi-Fi transmitter is exempted from testing and shall be rated M4 for the purposes of RF HAC evaluation.

Air Interface and Band [Mode]	Worst-Case Peak Antenna Input Power (dBm)	Exempted from Testing?
Wi-Fi 802.11b/g/n 2.44 GHz	22.83	YES

4.3 DUT and DASY Setup for RF HAC Testing

The phone was tested in normal configurations for against-the-ear use. When applicable, configurations are tested with the antenna in its fully-extended position. These tests are measured at the high, middle and low frequency channels (when applicable) for each air interface, band, and mode.

For CDMA, the signal was set up by creating and maintaining an over-the-air connection between the DUT and an Agilent 8960 Wireless Communications Test Set. The CDMA radio is available on CDMA 2000(1X) and IS-95. The test equipment was configured to use "All Up Bits" for RC1 / SO3 on J-STD-008 for CDMA 1900 and TSB-84 for CDMA 800 MHz.

The DUT tested in this report uses the following default battery:

Battery #1 – SNN5932A – 2000 mAH Battery

The phone is placed in the HAC measurement system with a fully charged battery. At the end of each test the DASY™ system measures the drift of the field strength at a fixed reference point to ensure that the DUT has not changed in transmitter power.

The DASY52 measurement system specified in Section 3.1 was utilized within the intended operations as set by SPEAG. The method of measurement utilized by the DASY52 system conforms to clause 5.5.1 of the ANSI C63.19-2011 standard, utilizing the indirect measurement method described in clause 5.5.1.3. The default settings for the grid spacing of the scan were set to 5 mm as shown in the field plots included in Appendix 2. The 50 mm by 50 mm area measurement grid is centered on the acoustic output of the device. The Test Arch provided by SPEAG is used to position the DUT. The DUT reference plane is parallel to the device and contains the highest point on its contour in the area of the acoustic output that normally rests against the user's ear. The measurement plane contains the center point of the probe sensor(s). The device is positioned such that the reference plane is located 15 mm from, and parallel to, the measurement plane. This is in accordance with clause 5.5 of the standard.

During testing, the DUT is placed into a polystyrene block (3-pound expanded polystyrene) which is machined to precisely fit the DUT's shape. The test positioner, provided by SPEAG, is used to grip the block. This positioning conforms to the specifications given in the paragraph above. The addition of the block does not increase the uncertainty budget, which is provided in Appendix 3. Pictures of the measurement setup are included in Appendix 4.

The HAC rating measurement results are shown in Section 4.4. Also shown are the measured drifts, excluded subgrids, MIF values, final RF audio interference levels, and margin to the M2/M3 rating limit. MIF values are taken from Section 4.1, as provided by SPEAG. The worst-case test conditions are indicated in **bold**, and detailed measurement plots are provided for these cases in Appendix 2.

Drift was measured using the typical DASY52 measurement routines. The field is measured at the reference location at the beginning of the test. After completion of the E-field measurement, the probe returns to the same reference location and takes another measurement. The drift is the delta between these two values and is included in the test report scans.

4.4 RF HAC Test Limits and Measurement Results

DUT Emissions Limits f < 960 MHz	
Rating	E-Field (dB V/m)
M1	50 to 55
M2	45 to 50
M3	40 to 45
M4	< 40

DUT Emissions Limits f > 960 MHz	
Rating	E-Field (dB V/m)
M1	40 to 45
M2	35 to 40
M3	30 to 35
M4	< 30

Air Interface and Band (Mode)	Channel Setting	Drift (dB)	Excluded Subgrids	MIF	RFAIL (dB V/m)	Margin (dB)	Rating
CDMA BC10 (RC1 SO3 1/8 th Rate)	564	-0.07	6,8,9	3.26	31.52	13.48	M4
CDMA 800 (RC1 SO3 1/8 th Rate)	1013	0.03	6,8,9	3.26	31.09	13.91	M4
	384	-0.12	6,8,9		32.26	12.74	M4
	777	-0.08	6,8,9		32.09	12.91	M4
CDMA 1900 (RC1 SO3 1/8 th Rate)	25	-0.03	1,2,3	3.26	24.90	10.1	M4
	600	-0.03	1,2,4		30.16	4.84	M3
	1175	-0.05	2,3,6		27.17	7.83	M4
Wi-Fi 802.11b/g/n 2.44 GHz	Any	N/A	N/A	N/A	N/A	N/A	M4 (1)

Note (1): Wi-Fi was found to be exempt from testing (see 4.2 above) in accordance with C63.19-2011 clause 4.4, and is rated M4.

Appendix 1

Distribution Plots for Test System Validations

Test Laboratory: Motorola Mobility - Aug-13-2013 835 MHz E-Field

HAC-Dipole 835 MHz; Type: CD835V3; FCC ID: IHDT56PF3

Procedure Notes: 835 MHz HAC Validation; Dipole Sn# 1042; Input Power = 100 mW

Communication System: _CW - Dipole (0); Frequency: 835 MHz; Duty Cycle: 1:1

Medium: Air; Medium parameters used: $\sigma = 0$ S/m, $\epsilon_r = 1$; $\rho = 0$ kg/m³

DASY4 Configuration:

- Probe: ER3DV6R - SN2245; ConvF(1, 1, 1); Calibrated: 6/25/2013;
- Sensor-Surface: 0mm (Fix Surface), Sensor-Surface: (Fix Surface)
- Electronics: DAE4 Sn1312; Calibrated: 9/4/2012
- Phantom: R-7, HAC Test Arch (rev.2); Type: SD HAC P01 BA; Serial: 1064; Phantom section: RF Section
- SEMCAD X Version 14.6.8 (7028)

HAC E Dipole @ 15mm Template, 835 Dipole at 15mm distance (41x361x1):

Interpolated grid: dx=0.5000 mm, dy=0.5000 mm; Device Reference Point: 0, 0, -6.3 mm

Reference Value = 119.4 V/m; Power Drift = -0.08 dB; Applied MIF = 0.00 dB

Maximum value of Total (interpolated) = 116.68 V/m

Average value of Total (interpolated) = $(116.68 + 116.01) / 2 = 116.35$ V/m

E-field

Grid 1 113.11 V/m	Grid 2 116.01 V/m	Grid 3 114.95 V/m
Grid 4 65.24 V/m	Grid 5 66.37 V/m	Grid 6 65.39 V/m
Grid 7 113.11 V/m	Grid 8 116.68 V/m	Grid 9 115.88 V/m

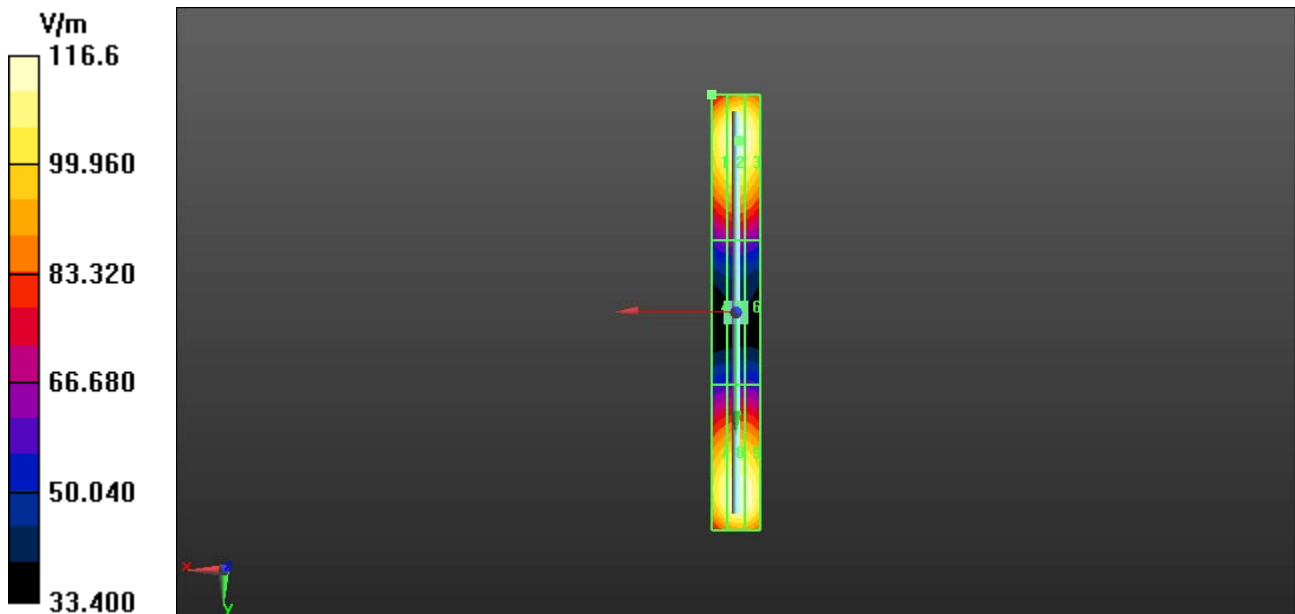

Test Laboratory: Motorola Mobility - Aug-13-2013 1880 MHz E-Field

HAC Dipole 1880 MHz; Type: CD1880V3; FCC ID: IHDT56PF3

Procedure Notes: 1880 MHz HAC Validation; Dipole Sn# 1059; Input Power = 100 mW

Communication System: _CW - Dipole (0); Frequency: 1880 MHz; Duty Cycle: 1:1

Medium: Air; Medium parameters used: $\sigma = 0$ S/m, $\epsilon_r = 1$; $\rho = 0$ kg/m³

DASY4 Configuration:

- Probe: ER3DV6R - SN2245; ConvF(1, 1, 1); Calibrated: 6/25/2013;
- Sensor-Surface: 0mm (Fix Surface), Sensor-Surface: (Fix Surface)
- Electronics: DAE4 Sn1312; Calibrated: 9/4/2012
- Phantom: R-7, HAC Test Arch (rev.2); Type: SD HAC P01 BA; Serial: 1064; Phantom section: RF Section
- SEMCAD X Version 14.6.8 (7028)

HAC E Dipole @ 15mm Template, 1880 Dipole at 15mm distance (41x181x1):

Interpolated grid: dx=0.5000 mm, dy=0.5000 mm; Device Reference Point: 0, 0, -6.3 mm

Reference Value = 152.8 V/m; Power Drift = -0.00 dB; Applied MIF = 0.00 dB

Maximum value of Total (interpolated) = 95.94 V/m

Average value of Total (interpolated) = $(95.94 + 89.33) / 2 = 92.64$ V/m

E-field

Grid 1 94.41 V/m	Grid 2 95.94 V/m	Grid 3 94.19 V/m
Grid 4 72.19 V/m	Grid 5 72.69 V/m	Grid 6 70.96 V/m
Grid 7 85.61 V/m	Grid 8 89.33 V/m	Grid 9 89.02 V/m

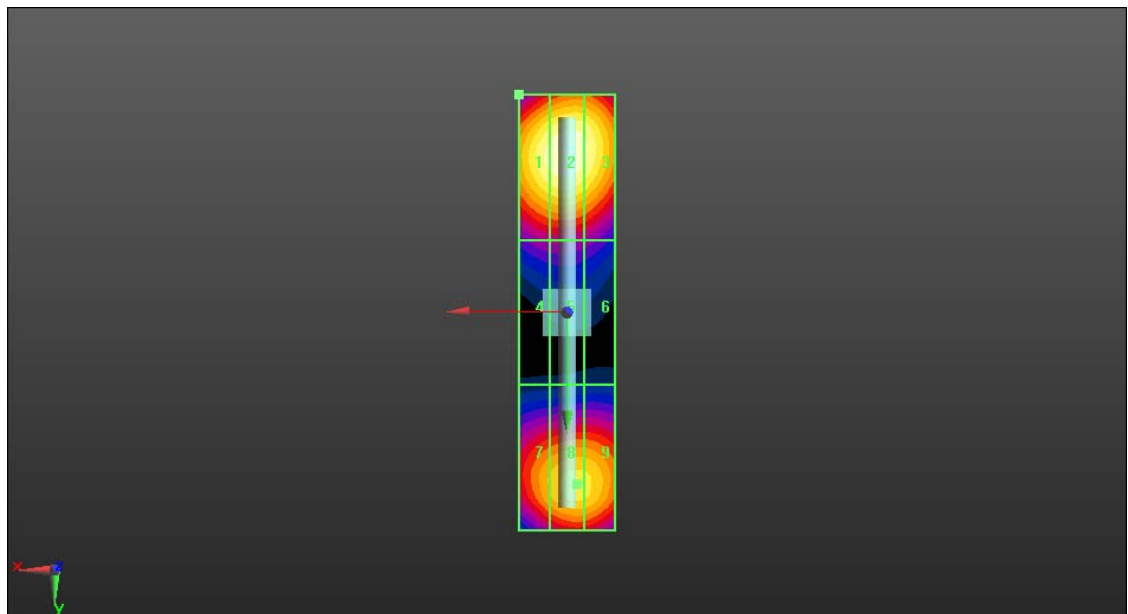
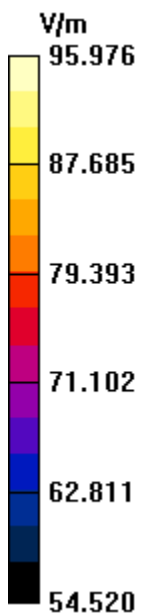

Appendix 2

Distribution Plots for RF HAC Measurements

Test Laboratory: Motorola Mobility - CDMA BC10 E-Field

Serial: LDXZ230024; FCC ID: IHDT56PF3

Communication System: CDMA2000, RC1, SO3, 1/8th Rate 25 fr.; Frequency: 820.1 MHz

Communication System Channel Number: 564; Duty Cycle: 1:17.7419

Medium: Air; Medium parameters used: $\sigma = 0$ S/m, $\epsilon_r = 1$; $\rho = 0$ kg/m³

DASY4 Configuration:

- Probe: ER3DV6R - SN2245; ConvF(1, 1, 1); Calibrated: 6/25/2013;
- Sensor-Surface: (Fix Surface)
- Electronics: DAE4 Sn1312; Calibrated: 9/4/2012
- Phantom: R-7, HAC Test Arch (rev.2); Type: SD HAC P01 BA; Serial: 1064; Phantom section: RF Section
- SEMCAD X Version 14.6.8 (7028)

E-Field HAC for DASY5 Template, Hearing Aid Compatibility Test (101x101x1):

Measured grid: dx=5mm, dy=5mm; Interpolated grid: dx=0.5000 mm, dy=0.5000 mm

Device Reference Point: 0, 0, -6.3 mm

Reference Value = 31.57 V/m; Power Drift = -0.07 dB; Applied MIF = 3.26 dB

RF audio interference level = 31.52 dBV/m

Emission category: M4

MIF scaled E-field

Grid 1 M4 29.56 dBV/m	Grid 2 M4 30.99 dBV/m	Grid 3 M4 30.95 dBV/m
Grid 4 M4 29.83 dBV/m	Grid 5 M4 31.52 dBV/m	Grid 6 M4 31.29 dBV/m
Grid 7 M4 29.88 dBV/m	Grid 8 M4 33.37 dBV/m	Grid 9 M4 31.5 dBV/m

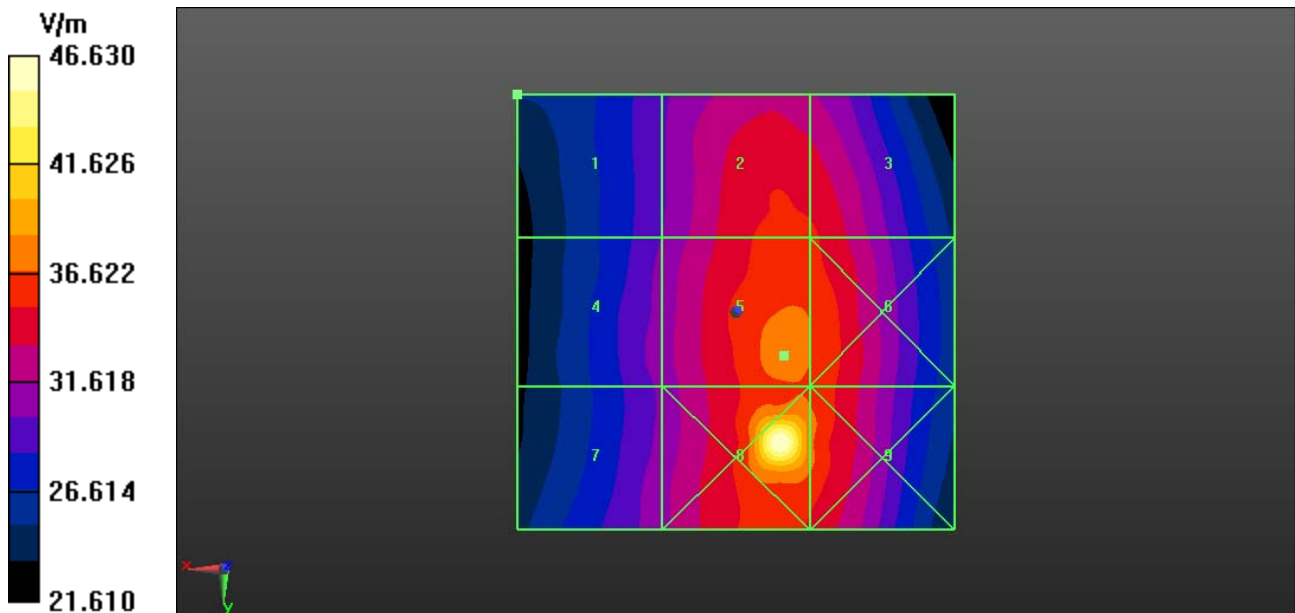

Test Laboratory: Motorola Mobility - CDMA 800 E-Field

Serial: LDXZ230024; FCC ID: IHDT56PF3

Communication System: CDMA2000, RC1, SO3, 1/8th Rate 25 fr.; Frequency: 836.52 MHz

Communication System Channel Number: 384; Duty Cycle: 1:17.7419

Medium: Air; Medium parameters used: $\sigma = 0$ S/m, $\epsilon_r = 1$; $\rho = 0$ kg/m³

DASY4 Configuration:

- Probe: ER3DV6R - SN2245; ConvF(1, 1, 1); Calibrated: 6/25/2013;
- Sensor-Surface: (Fix Surface)
- Electronics: DAE4 Sn1312; Calibrated: 9/4/2012
- Phantom: R-7, HAC Test Arch (rev.2); Type: SD HAC P01 BA; Serial: 1064; Phantom section: RF Section
- SEMCAD X Version 14.6.8 (7028)

E-Field HAC for DASY5 Template, Hearing Aid Compatibility Test (101x101x1):

Measurement grid: dx=5mm, dy=5mm; Interpolated grid: dx=0.5000 mm, dy=0.5000 mm

Device Reference Point: 0, 0, -6.3 mm

Reference Value = 34.67 V/m; Power Drift = -0.12 dB; Applied MIF = 3.26 dB

RF audio interference level = 32.26 dBV/m

Emission category: M4

MIF scaled E-field

Grid 1 M4 30.2 dBV/m	Grid 2 M4 31.93 dBV/m	Grid 3 M4 31.91 dBV/m
Grid 4 M4 30.58 dBV/m	Grid 5 M4 32.26 dBV/m	Grid 6 M4 32.18 dBV/m
Grid 7 M4 30.76 dBV/m	Grid 8 M4 32.21 dBV/m	Grid 9 M4 32.19 dBV/m

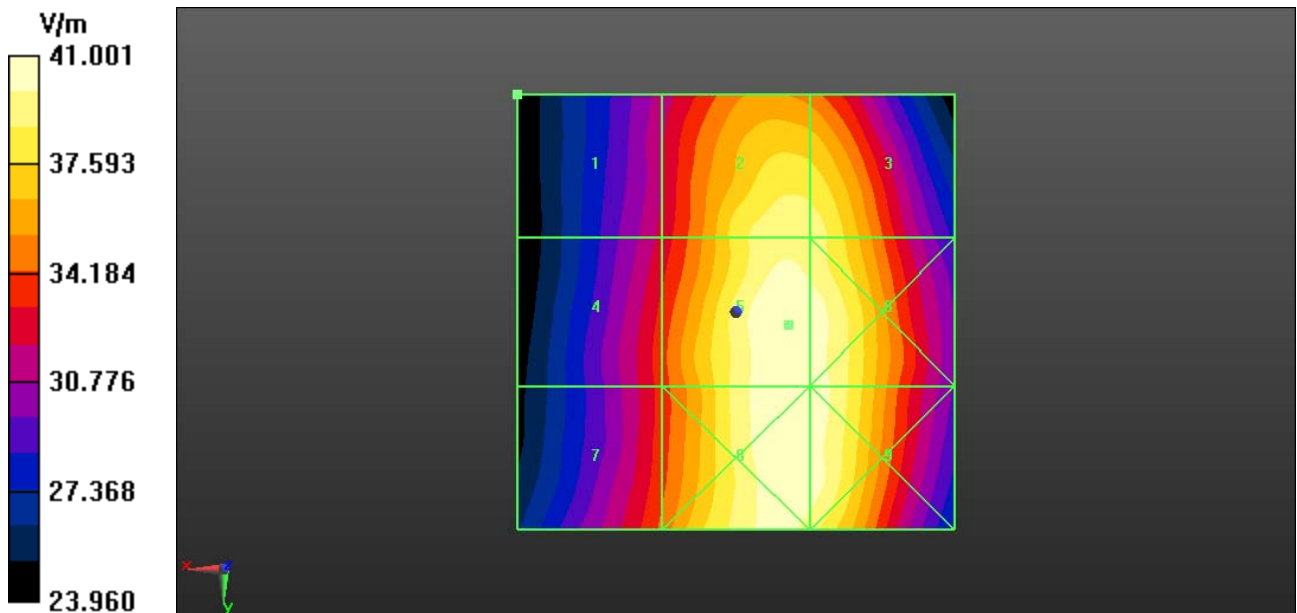

Test Laboratory: Motorola Mobility - CDMA 1900 E-Field

Serial: LDXZ230024; FCC ID: IHDT56PF3

Communication System: CDMA2000, RC1, SO3, 1/8th Rate 25 fr.; Frequency: 1880 MHz

Communication System Channel Number: 600; Duty Cycle: 1:17.7419

Medium: Air; Medium parameters used: $\sigma = 0$ S/m, $\epsilon_r = 1$; $\rho = 0$ kg/m³

DASY4 Configuration:

- Probe: ER3DV6R - SN2245; ConvF(1, 1, 1); Calibrated: 6/25/2013;
- Sensor-Surface: (Fix Surface)
- Electronics: DAE4 Sn1312; Calibrated: 9/4/2012
- Phantom: R-7, HAC Test Arch (rev.2); Type: SD HAC P01 BA; Serial: 1064; Phantom section: RF Section
- SEMCAD X Version 14.6.8 (7028)

E-Field HAC for DASY5 Template, Hearing Aid Compatibility Test (101x101x1):

Measurement grid: dx=5mm, dy=5mm; Interpolated grid: dx=0.5000 mm, dy=0.5000 mm

Device Reference Point: 0, 0, -6.3 mm

Reference Value = 14.38 V/m; Power Drift = -0.03 dB; Applied MIF = 3.26 dB

RF audio interference level = 30.16 dBV/m

Emission category: M3

MIF scaled E-field

Grid 1 M3 31.25 dBV/m	Grid 2 M4 29.83 dBV/m	Grid 3 M4 25.83 dBV/m
Grid 4 M4 29.12 dBV/m	Grid 5 M3 30.16 dBV/m	Grid 6 M4 25.53 dBV/m
Grid 7 M4 20.94 dBV/m	Grid 8 M4 24.64 dBV/m	Grid 9 M4 24.64 dBV/m

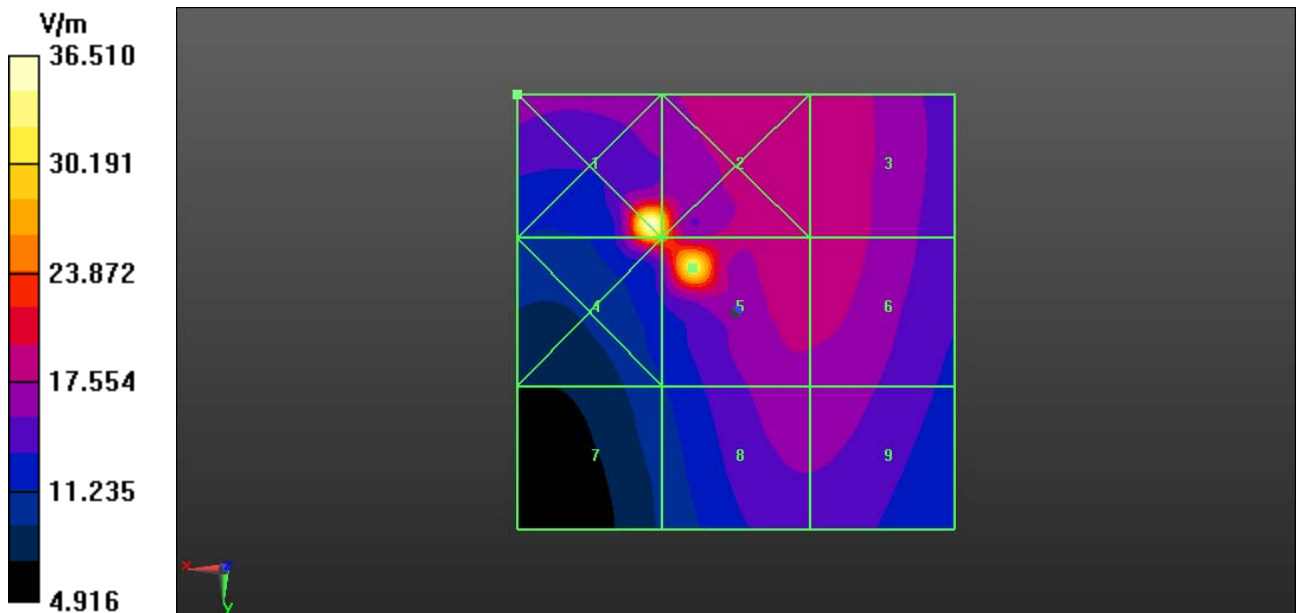

Appendix 3
Measurement Uncertainty Budget

A3.1 Motorola Uncertainty Budget for RF HAC Testing

UNCERTAINTY DESCRIPTION	Uncertainty Value (+/- %)	Prob. Dist.	Div.	(ci) E	Std. Unc. E
MEASUREMENT SYSTEM					
Probe Calibration	5.1%	N	1.0000	1	5.1%
Axial Isotropy	7.8%	R	1.7321	1	4.5%
Sensor Displacement	16.5%	R	1.7321	1	9.5%
Boundary Effects	2.4%	R	1.7321	1	1.4%
Test Arch	7.2%	R	1.7321	1	4.2%
Linearity	4.7%	R	1.7321	1	2.7%
Scaling with PMR Calibration	10.0%	R	1.7321	1	5.8%
System Detection Limit	1.0%	R	1.7321	1	0.6%
Readout Electronics	0.3%	N	1.0000	1	0.3%
Response Time	0.8%	R	1.7321	1	0.5%
Integration Time	2.6%	R	1.7321	1	1.5%
RF Ambient Conditions	3.0%	R	1.7321	1	1.7%
RF Reflections	5.6%	R	1.7321	1	3.2%
Probe Positioner	1.2%	R	1.7321	1	0.7%
Probe Positioning	4.7%	R	1.7321	1	2.7%
Extrap. & Interpolation	1.0%	R	1.7321	1	0.6%
TEST SAMPLE RELATED					
Total Device Positioning	3.2%	R	1.7321	1	1.8%
Device Holder & Phantom	2.4%	R	1.7321	1	1.4%
Power Drift	5.0%	R	1.7321	1	2.9%
PHANTOM AND SETUP RELATED					
Phantom Thickness	2.4%	R	1.7321	1	1.4%
Combined Std.Uncertainty on Power					15.4%
Combined Std.Uncertainty on Field					7.7%
Expanded Std. Uncertainty on Power					30.8%
Expanded Std. Uncertainty on Field					15.4%

Appendix 4
Pictures of Test Setup

See Exhibit 7B

Appendix 5
Probe Calibration Certificates



Accredited by the Swiss Accreditation Service (SAS)
The Swiss Accreditation Service is one of the signatories to the EA
Multilateral Agreement for the recognition of calibration certificates

Accreditation No.: **SCS 108**

Client **Motorola MDb**

Certificate No: **ER3-2245_Jun13/2**

CALIBRATION CERTIFICATE (Replacement of No: ER3-2245_Jun13)

Object **ER3DV6R - SN:2245**

Calibration procedure(s) **QA CAL-02.v6, QA CAL-25.v4
Calibration procedure for E-field probes optimized for close near field
evaluations in air**

Calibration date: **June 25, 2013**

This calibration certificate documents the traceability to national standards, which realize the physical units of measurements (SI).
The measurements and the uncertainties with confidence probability are given on the following pages and are part of the certificate.

All calibrations have been conducted in the closed laboratory facility: environment temperature (22 ± 3)°C and humidity < 70%.

Calibration Equipment used (M&TE critical for calibration)

Primary Standards	ID	Cal Date (Certificate No.)	Scheduled Calibration
Power meter E4419B	GB41293874	04-Apr-13 (No. 217-01733)	Apr-14
Power sensor E4412A	MY41498087	04-Apr-13 (No. 217-01733)	Apr-14
Reference 3 dB Attenuator	SN: S5054 (3c)	04-Apr-13 (No. 217-01737)	Apr-14
Reference 20 dB Attenuator	SN: S5277 (20x)	04-Apr-13 (No. 217-01735)	Apr-14
Reference 30 dB Attenuator	SN: S5129 (30b)	04-Apr-13 (No. 217-01738)	Apr-14
Reference Probe ER3DV6	SN: 2328	12-Oct-12 (No. ER3-2328_Oct12)	Oct-13
DAE4	SN: 789	15-May-13 (No. DAE4-789_May13)	May-14
Secondary Standards	ID	Check Date (in house)	Scheduled Check
RF generator HP 8648C	US3642U01700	4-Aug-99 (in house check Apr-13)	In house check: Apr-15
Network Analyzer HP 8753E	US37390585	18-Oct-01 (in house check Oct-12)	In house check: Oct-13

Calibrated by:	Name Katja Pokovic	Function Technical Manager	Signature
Approved by:	Name Niels Kuster	Function Quality Manager	

Issued: June 25, 2013

This calibration certificate shall not be reproduced except in full without written approval of the laboratory.



Accredited by the Swiss Accreditation Service (SAS)

Accreditation No.: **SCS 108**

The Swiss Accreditation Service is one of the signatories to the EA Multilateral Agreement for the recognition of calibration certificates

Glossary:

NORM _{x,y,z}	sensitivity in free space
DCP	diode compression point
CF	crest factor (1/duty_cycle) of the RF signal
A, B, C, D	modulation dependent linearization parameters
Polarization φ	φ rotation around probe axis
Polarization ϑ	ϑ rotation around an axis that is in the plane normal to probe axis (at measurement center), i.e., $\vartheta = 0$ is normal to probe axis
Connector Angle	information used in DASY system to align probe sensor X to the robot coordinate system

Calibration is Performed According to the Following Standards:

- IEEE Std 1309-2005, " IEEE Standard for calibration of electromagnetic field sensors and probes, excluding antennas, from 9 kHz to 40 GHz", December 2005
- CTIA Test Plan for Hearing Aid Compatibility, April 2010.

Methods Applied and Interpretation of Parameters:

- NORM_{x,y,z}*: Assessed for E-field polarization $\vartheta = 0$ for XY sensors and $\vartheta = 90$ for Z sensor ($f \leq 900$ MHz in TEM-cell; $f > 1800$ MHz: R22 waveguide).
- NORM(f)_{x,y,z}* = *NORM_{x,y,z}* * *frequency_response* (see Frequency Response Chart).
- DCP_{x,y,z}*: DCP are numerical linearization parameters assessed based on the data of power sweep with CW signal (no uncertainty required). DCP does not depend on frequency nor media.
- PAR*: PAR is the Peak to Average Ratio that is not calibrated but determined based on the signal characteristics
- A_{x,y,z}; B_{x,y,z}; C_{x,y,z}; D_{x,y,z}; VR_{x,y,z}*: A, B, C, D are numerical linearization parameters assessed based on the data of power sweep for specific modulation signal. The parameters do not depend on frequency nor media. VR is the maximum calibration range expressed in RMS voltage across the diode.
- Spherical isotropy (3D deviation from isotropy)*: in a locally homogeneous field realized using an open waveguide setup.
- Sensor Offset*: The sensor offset corresponds to the offset of virtual measurement center from the probe tip (on probe axis). No tolerance required.
- Connector Angle*: The angle is assessed using the information gained by determining the *NORM_x* (no uncertainty required).

Probe ER3DV6R

SN:2245

Manufactured: February 1, 2000
Calibrated: June 25, 2013

Calibrated for DASY/EASY Systems
(Note: non-compatible with DASY2 system!)

DASY/EASY - Parameters of Probe: ER3DV6R - SN:2245

Basic Calibration Parameters

	Sensor X	Sensor Y	Sensor Z	Unc (k=2)
Norm ($\mu\text{V}/(\text{V}/\text{m})^2$)	1.61	1.52	1.97	$\pm 10.1 \%$
DCP (mV) ^B	98.9	98.8	99.8	

Modulation Calibration Parameters

UID	Communication System Name		A dB	B dB $\sqrt{\mu\text{V}}$	C	D dB	VR mV	Unc ^E (k=2)
0	CW	X	0.0	0.0	1.0	0.00	152.4	$\pm 2.7 \%$
		Y	0.0	0.0	1.0		198.6	
		Z	0.0	0.0	1.0		156.5	
10011- CAA	UMTS-FDD (WCDMA)	X	3.22	66.2	18.2	2.91	124.2	$\pm 0.5 \%$
		Y	3.20	66.2	18.3		119.3	
		Z	3.27	66.8	18.5		124.6	
10021- DAA	GSM-FDD (TDMA, GMSK)	X	20.24	100.0	28.3	9.39	123.8	$\pm 1.9 \%$
		Y	17.58	99.5	28.8		117.7	
		Z	21.50	99.7	28.3		133.6	
10039- CAA	CDMA2000 (1xRTT, RC1)	X	4.76	66.3	18.9	4.57	122.6	$\pm 0.9 \%$
		Y	4.73	66.3	19.0		119.0	
		Z	4.73	66.5	19.0		122.4	
10295- AAA	CDMA2000, RC1, SO3, 1/8th Rate 25 fr.	X	15.45	98.7	40.6	12.49	108.9	$\pm 3.0 \%$
		Y	15.26	99.4	41.3		105.9	
		Z	16.59	99.7	40.4		119.5	
10313- AAA	iDEN 1:3	X	10.64	91.0	35.6	10.51	101.6	$\pm 3.5 \%$
		Y	11.94	95.7	38.1		100.4	
		Z	10.57	88.9	34.0		108.6	
10314- AAA	iDEN 1:6	X	8.36	81.5	33.2	13.48	59.2	$\pm 3.0 \%$
		Y	8.07	80.6	32.9		59.2	
		Z	7.98	78.0	30.6		63.0	

The reported uncertainty of measurement is stated as the standard uncertainty of measurement multiplied by the coverage factor $k=2$, which for a normal distribution corresponds to a coverage probability of approximately 95%.

^B Numerical linearization parameter: uncertainty not required.

^E Uncertainty is determined using the max. deviation from linear response applying rectangular distribution and is expressed for the square of the field value.

Frequency Response of E-Field (TEM-Cell:ifi110 EXX, Waveguide: R22)

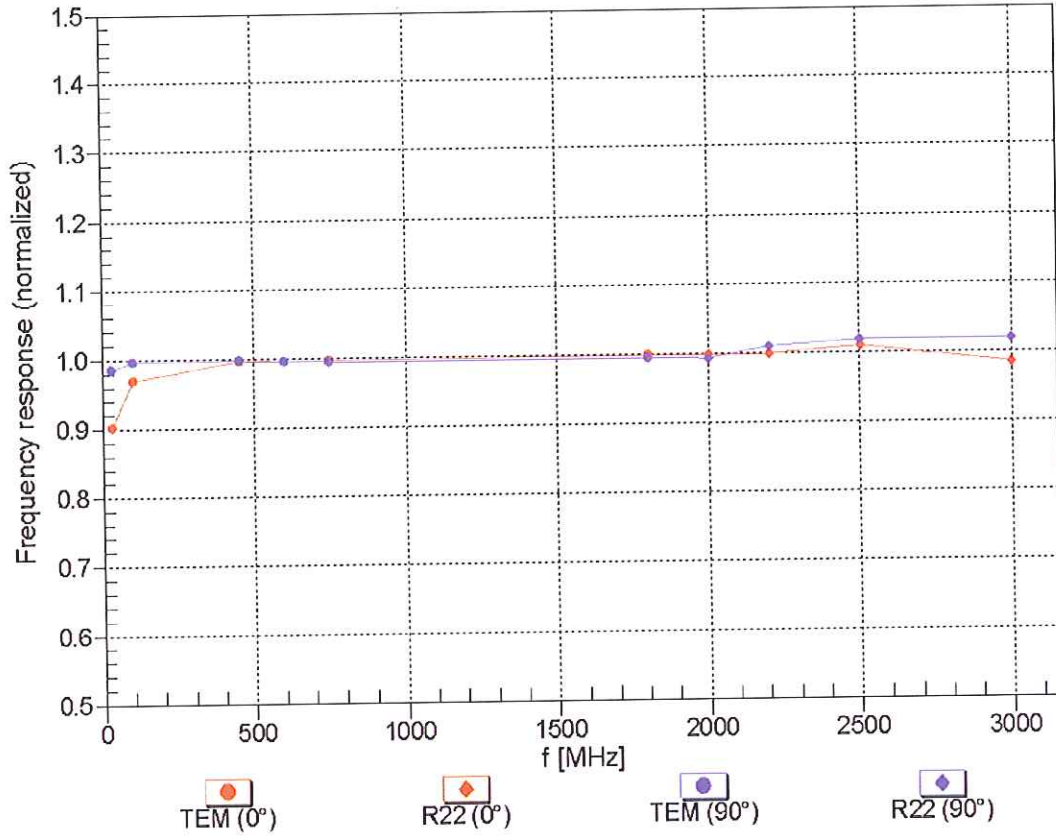

Uncertainty of Frequency Response of E-field: $\pm 6.3\%$ (k=2)

Receiving Pattern (ϕ), $\vartheta = 0^\circ$

f=600 MHz, TEM, 0°

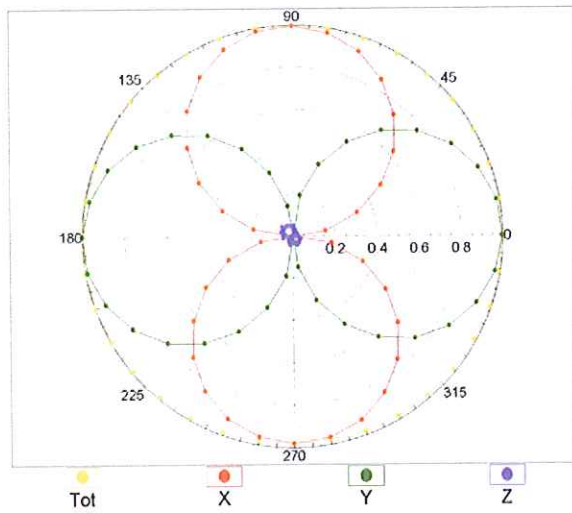

f=2500 MHz, R22, 0°

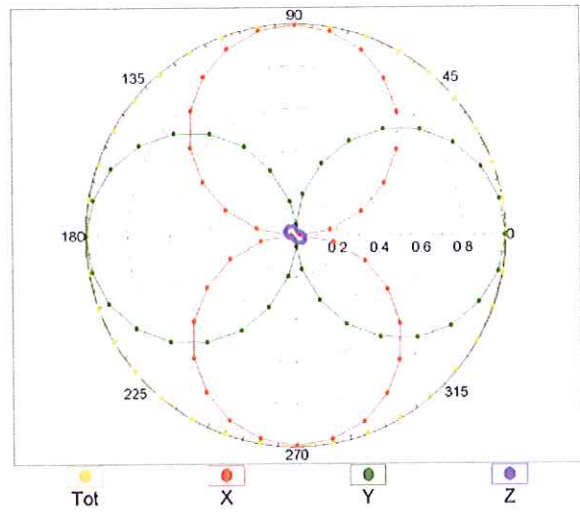

Receiving Pattern (ϕ), $\vartheta = 90^\circ$

f=600 MHz, TEM, 90°

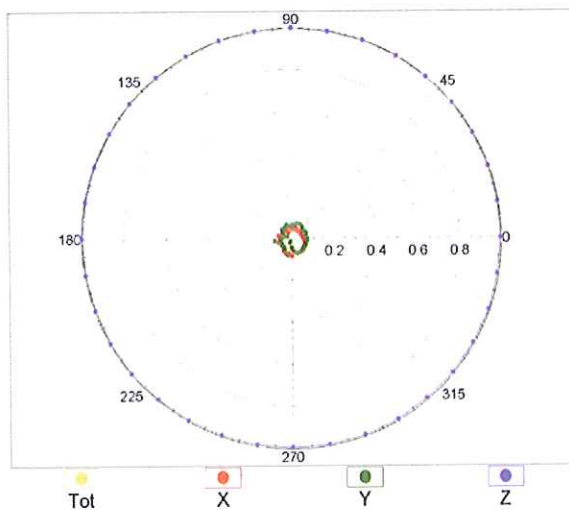

f=2500 MHz, R22, 90°

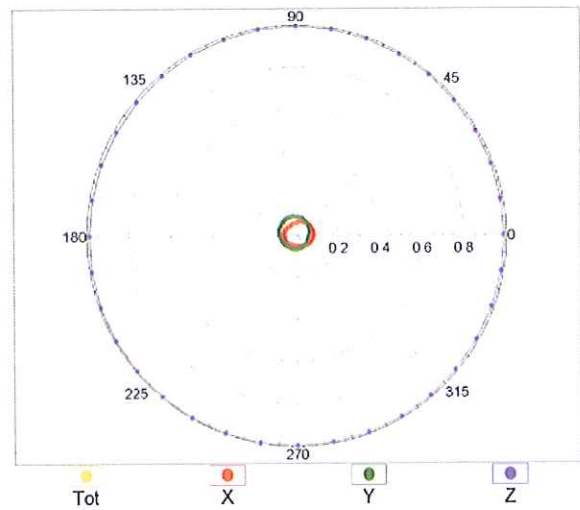

Receiving Pattern (ϕ), $\vartheta = 0^\circ$

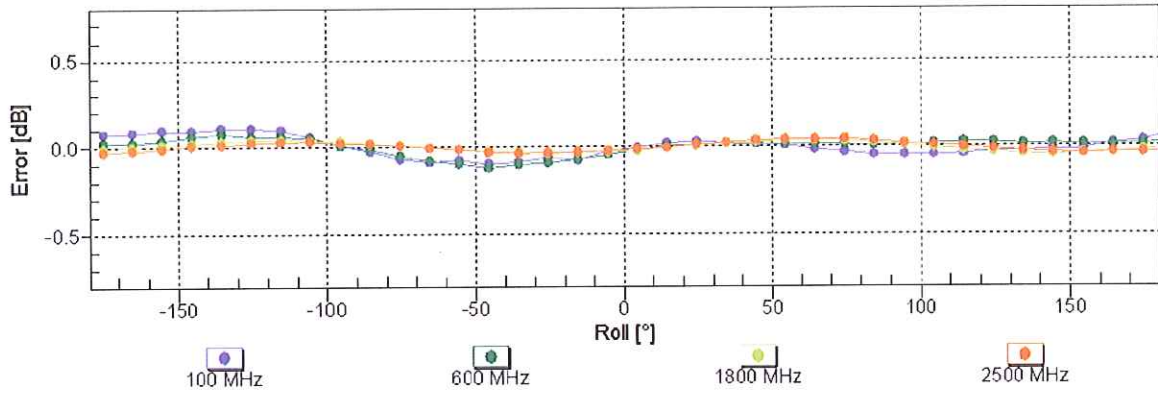

Uncertainty of Axial Isotropy Assessment: $\pm 0.5\%$ (k=2)

Receiving Pattern (ϕ), $\vartheta = 90^\circ$

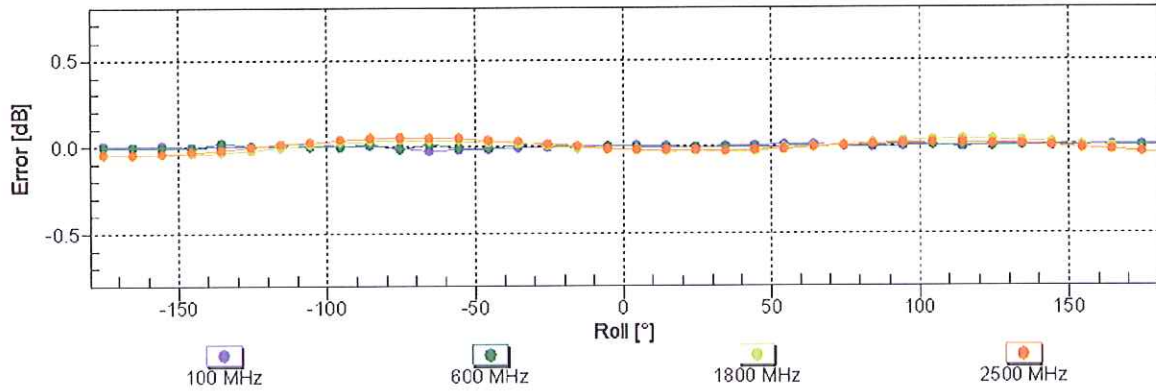

Uncertainty of Axial Isotropy Assessment: $\pm 0.5\%$ (k=2)

Dynamic Range f(E-field) (TEM cell , f = 900 MHz)

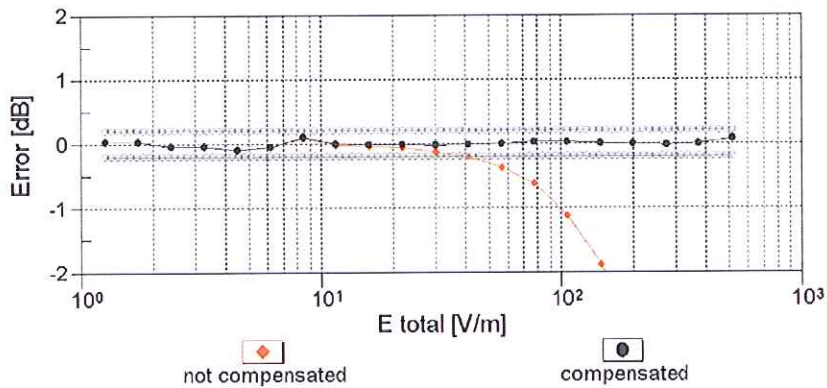
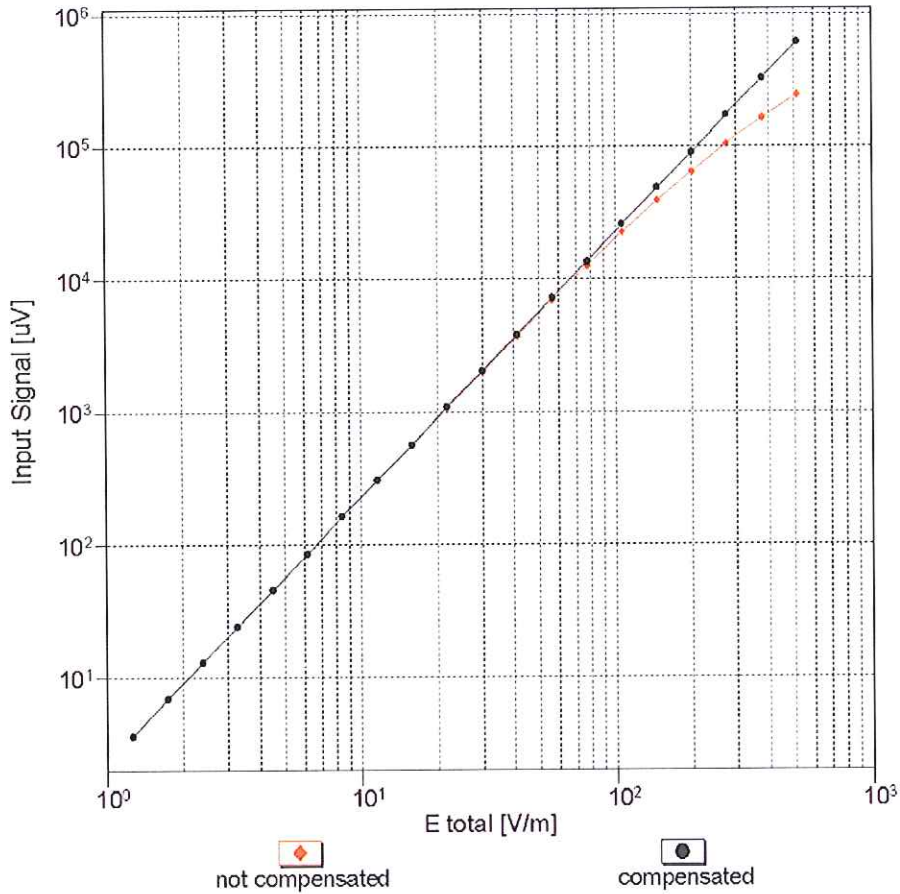

Uncertainty of Linearity Assessment: ± 0.6% (k=2)

Deviation from Isotropy in Air

Error (ϕ , θ), $f = 900$ MHz

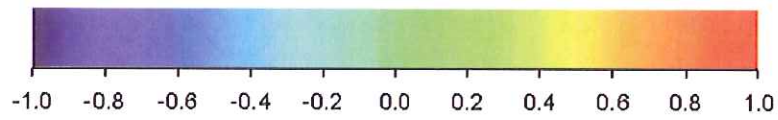
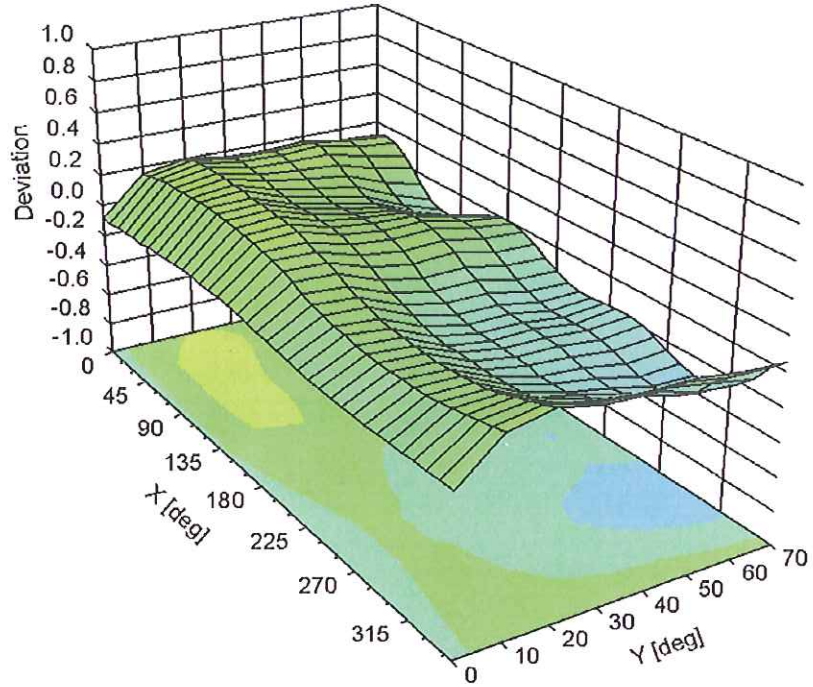

Uncertainty of Spherical Isotropy Assessment: $\pm 2.6\%$ ($k=2$)

DASY/EASY - Parameters of Probe: ER3DV6R - SN:2245

Other Probe Parameters

Sensor Arrangement	Rectangular
Connector Angle (°)	34.5
Mechanical Surface Detection Mode	enabled
Optical Surface Detection Mode	disabled
Probe Overall Length	337 mm
Probe Body Diameter	10 mm
Tip Length	10 mm
Tip Diameter	8 mm
Probe Tip to Sensor X Calibration Point	2.5 mm
Probe Tip to Sensor Y Calibration Point	2.5 mm
Probe Tip to Sensor Z Calibration Point	2.5 mm

Appendix 6
Dipole Characterization Certificates



Accredited by the Swiss Accreditation Service (SAS)
The Swiss Accreditation Service is one of the signatories to the EA
Multilateral Agreement for the recognition of calibration certificates

Accreditation No.: **SCS 108**

Client **Motorola MDb**

Certificate No: **CD835V3-1042_Mar13**

CALIBRATION CERTIFICATE

Object **CD835V3 - SN: 1042**

Calibration procedure(s) **QA CAL-20.v6
Calibration procedure for dipoles in air**

Calibration date: **March 05, 2013**

This calibration certificate documents the traceability to national standards, which realize the physical units of measurements (SI).
The measurements and the uncertainties with confidence probability are given on the following pages and are part of the certificate.

All calibrations have been conducted in the closed laboratory facility: environment temperature (22 ± 3)°C and humidity < 70%.

Calibration Equipment used (M&TE critical for calibration)

Primary Standards	ID #	Cal Date (Certificate No.)	Scheduled Calibration
Power meter EPM-442A	GB37480704	01-Nov-12 (No. 217-01640)	Oct-13
Power sensor HP 8481A	US37292783	01-Nov-12 (No. 217-01640)	Oct-13
Reference 10 dB Attenuator	SN: 5047.2 (10q)	27-Mar-12 (No. 217-01527)	Apr-13
Probe ER3DV6	SN: 2336	28-Dec-12 (No. ER3-2336_Dec12)	Dec-13
Probe H3DV6	SN: 6065	28-Dec-12 (No. H3-6065_Dec12)	Dec-13
DAE4	SN: 781	29-May-12 (No. DAE4-781_May12)	May-13

Secondary Standards	ID #	Check Date (in house)	Scheduled Check
Power meter Agilent 4419B	SN: GB42420191	09-Oct-09 (in house check Oct-12)	In house check: Oct-13
Power sensor HP E4412A	SN: MY41495277	01-Apr-08 (in house check Oct-12)	In house check: Oct-13
Power sensor HP 8482A	SN: US37295597	09-Oct-09 (in house check Oct-12)	In house check: Oct-13
Network Analyzer HP 8753E	US37390585	18-Oct-01 (in house check Oct-12)	In house check: Oct-13
RF generator R&S SMT-06	SN: 832283/011	27-Aug-12 (in house check Oct-12)	In house check: Oct-14

	Name	Function	Signature
Calibrated by:	Dimce Iliev	Laboratory Technician	
Approved by:	Fin Bomholt	Deputy Technical Manager	

Issued: March 6, 2013

This calibration certificate shall not be reproduced except in full without written approval of the laboratory.



Accredited by the Swiss Accreditation Service (SAS)

The Swiss Accreditation Service is one of the signatories to the EA
Multilateral Agreement for the recognition of calibration certificates

Accreditation No.: **SCS 108**

References

- [1] ANSI-C63.19-2011
American National Standard, Methods of Measurement of Compatibility between Wireless Communications
Devices and Hearing Aids.

Methods Applied and Interpretation of Parameters:

- *Coordinate System:* y-axis is in the direction of the dipole arms. z-axis is from the basis of the antenna (mounted on the table) towards its feed point between the two dipole arms. x-axis is normal to the other axes. In coincidence with the standards [1], the measurement planes (probe sensor center) are selected to be at a distance of 15 mm above the top metal edge of the dipole arms.
- *Measurement Conditions:* Further details are available from the hardcopies at the end of the certificate. All figures stated in the certificate are valid at the frequency indicated. The forward power to the dipole connector is set with a calibrated power meter connected and monitored with an auxiliary power meter connected to a directional coupler. While the dipole under test is connected, the forward power is adjusted to the same level.
- *Antenna Positioning:* The dipole is mounted on a HAC Test Arch phantom using the matching dipole positioner with the arms horizontal and the feeding cable coming from the floor. The measurements are performed in a shielded room with absorbers around the setup to reduce the reflections. It is verified before the mounting of the dipole under the Test Arch phantom, that its arms are perfectly in a line. It is installed on the HAC dipole positioner with its arms parallel below the dielectric reference wire and able to move elastically in vertical direction without changing its relative position to the top center of the Test Arch phantom. The vertical distance to the probe is adjusted after dipole mounting with a DASY5 Surface Check job. Before the measurement, the distance between phantom surface and probe tip is verified. The proper measurement distance is selected by choosing the matching section of the HAC Test Arch phantom with the proper device reference point (upper surface of the dipole) and the matching grid reference point (tip of the probe) considering the probe sensor offset. The vertical distance to the probe is essential for the accuracy.
- *Feed Point Impedance and Return Loss:* These parameters are measured using a HP 8753E Vector Network Analyzer. The impedance is specified at the SMA connector of the dipole. The influence of reflections was eliminating by applying the averaging function while moving the dipole in the air, at least 70cm away from any obstacles.
- *E-field distribution:* E field is measured in the x-y-plane with an isotropic ER3D-field probe with 100 mW forward power to the antenna feed point. In accordance with [1], the scan area is 20mm wide, its length exceeds the dipole arm length (180 or 90mm). The sensor center is 15 mm (in z) above the metal top of the dipole arms. Two 3D maxima are available near the end of the dipole arms. Assuming the dipole arms are perfectly in one line, the average of these two maxima (in subgrid 2 and subgrid 8) is determined to compensate for any non-parallelity to the measurement plane as well as the sensor displacement. The E-field value stated as calibration value represents the maximum of the interpolated 3D-E-field, in the plane above the dipole surface.

The reported uncertainty of measurement is stated as the standard uncertainty of measurement multiplied by the coverage factor $k=2$, which for a normal distribution corresponds to a coverage probability of approximately 95%.

Measurement Conditions

DASY system configuration, as far as not given on page 1.

DASY Version	DASY5	V52.8.5
Extrapolation	Advanced Extrapolation	
Phantom	HAC Test Arch	
Distance Dipole Top - Probe Center	15mm	
Scan resolution	dx, dy = 5 mm	
Frequency	835 MHz \pm 1 MHz 898 MHz \pm 1 MHz	
Input power drift	< 0.05 dB	

Maximum Field values at 835 MHz

E-field 15 mm above dipole surface	condition	Interpolated maximum
Maximum measured above high end	100 mW input power	106.7 V / m
Maximum measured above low end	100 mW input power	105.2 V / m
Averaged maximum above arm	100 mW input power	106.0 V / m \pm 12.8 % (k=2)

Maximum Field values at 898 MHz

E-field 15 mm above dipole surface	condition	Interpolated maximum
Maximum measured above high end	100 mW input power	102.6 V / m
Maximum measured above low end	100 mW input power	101.0 V / m
Averaged maximum above arm	100 mW input power	101.8 V / m \pm 12.8 % (k=2)

Appendix

Antenna Parameters

Nominal Frequencies

Frequency	Return Loss	Impedance
800 MHz	14.5 dB	45.1 Ω - 17.5 j Ω
835 MHz	31.6 dB	47.5 Ω + 0.2 j Ω
900 MHz	17.3 dB	52.2 Ω - 13.9 j Ω
950 MHz	19.1 dB	42.4 Ω + 7.0 j Ω
960 MHz	15.7 dB	47.1 Ω + 15.8 j Ω

Additional Frequencies

Frequency	Return Loss	Impedance
898 MHz	16.8 dB	52.9 Ω - 14.7 j Ω

3.2 Antenna Design and Handling

The calibration dipole has a symmetric geometry with a built-in two stub matching network, which leads to the enhanced bandwidth.

The dipole is built of standard semirigid coaxial cable. The internal matching line is open ended. The antenna is therefore open for DC signals.

Do not apply force to dipole arms, as they are liable to bend. The soldered connections near the feedpoint may be damaged. After excessive mechanical stress or overheating, check the impedance characteristics to ensure that the internal matching network is not affected.

After long term use with 40W radiated power, only a slight warming of the dipole near the feedpoint can be measured.

Impedance Measurement Plot

6 Mar 2013 11:52:31

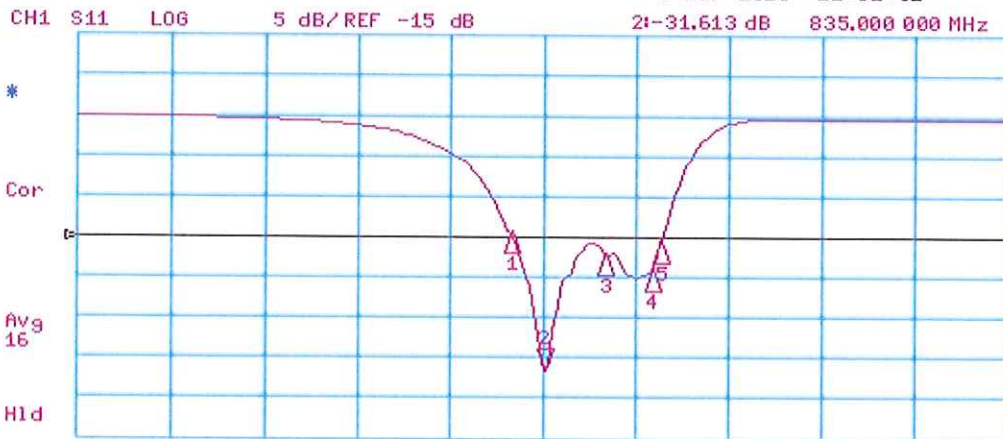

CH1 Markers

1:	-14.516 dB	800.000 MHz
3:	-17.325 dB	900.000 MHz
4:	-19.108 dB	950.000 MHz
5:	-15.735 dB	960.000 MHz

CH2 S11 1 U FS 2: 47.451 Ω 0.2285 Ω 43.556 pF 835.000 000 MHz

De1
Cor
Avg 16
H1d

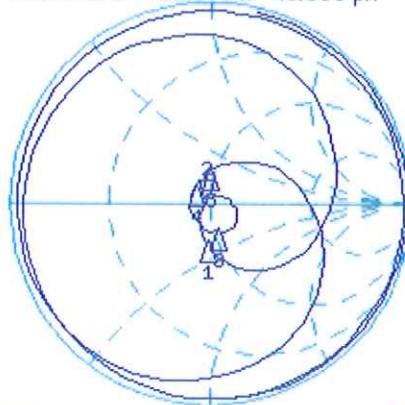

CH2 Markers

1:	45.084 Ω	-17.500 Ω	800.000 MHz
3:	52.174 Ω	-13.861 Ω	900.000 MHz
4:	42.449 Ω	6.9668 Ω	950.000 MHz
5:	47.086 Ω	15.805 Ω	960.000 MHz

START 335.000 000 MHz

STOP 1 335.000 000 MHz

DASY5 E-field Result

Date: 05.03.2013

Test Laboratory: SPEAG Lab2

DUT: HAC-Dipole 835 MHz; Type: CD835V3; Serial: CD835V3 - SN: 1042

Communication System: CW; Frequency: 835 MHz, Frequency: 898 MHz

Medium parameters used: $\sigma = 0$ S/m, $\epsilon_r = 1$; $\rho = 1000$ kg/m³

Phantom section: RF Section

Measurement Standard: DASY5 (IEEE/IEC/ANSI C63.19-2011)

DASY52 Configuration:

- Probe: ER3DV6 - SN2336; ConvF(1, 1, 1); Calibrated: 28.12.2012;
- Sensor-Surface: (Fix Surface)
- Electronics: DAE4 Sn781; Calibrated: 29.05.2012
- Phantom: HAC Test Arch with AMCC; Type: SD HAC P01 BA; Serial: 1070
- DASY52 52.8.5(1059); SEMCAD X 14.6.8(7028)

Dipole E-Field measurement @ 835MHz/E-Scan - 835MHz d=15mm/Hearing Aid Compatibility Test (41x361x1): Interpolated grid: dx=0.5000 mm, dy=0.5000 mm

Device Reference Point: 0, 0, -6.3 mm

Reference Value = 105.7 V/m; Power Drift = -0.03 dB

PMR not calibrated. PMF = 1.000 is applied.

E-field emissions = 106.7 V/m

Near-field category: M4 (AWF 0 dB)

PMF scaled E-field

Grid 1 M4 103.5 V/m	Grid 2 M4 105.2 V/m	Grid 3 M4 102.8 V/m
Grid 4 M4 63.47 V/m	Grid 5 M4 64.45 V/m	Grid 6 M4 63.52 V/m
Grid 7 M4 103.4 V/m	Grid 8 M4 106.7 V/m	Grid 9 M4 106.0 V/m

Dipole E-Field measurement @ 835MHz/E-Scan - 898MHz d=15mm/Hearing Aid Compatibility Test (41x361x1):

Interpolated grid: dx=0.5000 mm, dy=0.5000 mm

Device Reference Point: 0, 0, -6.3 mm

Reference Value = 94.37 V/m; Power Drift = -0.03 dB

PMR not calibrated. PMF = 1.000 is applied.

E-field emissions = 102.6 V/m

Near-field category: M4 (AWF 0 dB)

PMF scaled E-field

Grid 1 M4 101.0 V/m	Grid 2 M4 102.6 V/m	Grid 3 M4 100.7 V/m
Grid 4 M4 57.26 V/m	Grid 5 M4 57.97 V/m	Grid 6 M4 57.09 V/m
Grid 7 M4 97.89 V/m	Grid 8 M4 101.0 V/m	Grid 9 M4 100.4 V/m

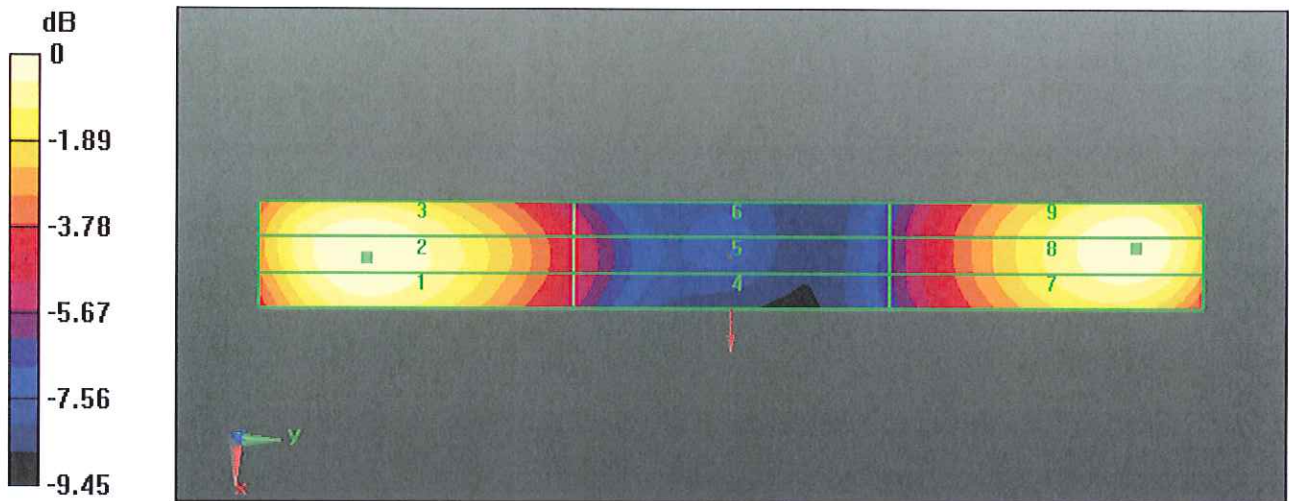

0 dB = 106.7 V/m = 40.56 dBV/m



Accredited by the Swiss Accreditation Service (SAS)
The Swiss Accreditation Service is one of the signatories to the EA
Multilateral Agreement for the recognition of calibration certificates

Accreditation No.: **SCS 108**

Client **Motorola MDb**

Certificate No: **CD1880V3-1059_Mar13**

CALIBRATION CERTIFICATE

Object **CD1880V3 - SN: 1059**

Calibration procedure(s) **QA CAL-20.v6
Calibration procedure for dipoles in air**

Calibration date: **March 05, 2013**

This calibration certificate documents the traceability to national standards, which realize the physical units of measurements (SI).
The measurements and the uncertainties with confidence probability are given on the following pages and are part of the certificate.

All calibrations have been conducted in the closed laboratory facility: environment temperature (22 ± 3)°C and humidity < 70%.

Calibration Equipment used (M&TE critical for calibration)

Primary Standards	ID #	Cal Date (Certificate No.)	Scheduled Calibration
Power meter EPM-442A	GB37480704	01-Nov-12 (No. 217-01640)	Oct-13
Power sensor HP 8481A	US37292783	01-Nov-12 (No. 217-01640)	Oct-13
Reference 10 dB Attenuator	SN: 5047.2 (10q)	27-Mar-12 (No. 217-01527)	Apr-13
Probe ER3DV6	SN: 2336	28-Dec-12 (No. ER3-2336_Dec12)	Dec-13
Probe H3DV6	SN: 6065	28-Dec-12 (No. H3-6065_Dec12)	Dec-13
DAE4	SN: 781	29-May-12 (No. DAE4-781_May12)	May-13

Secondary Standards	ID #	Check Date (in house)	Scheduled Check
Power meter Agilent 4419B	SN: GB42420191	09-Oct-09 (in house check Oct-12)	In house check: Oct-13
Power sensor HP E4412A	SN: MY41495277	01-Apr-08 (in house check Oct-12)	In house check: Oct-13
Power sensor HP 8482A	SN: US37295597	09-Oct-09 (in house check Oct-12)	In house check: Oct-13
Network Analyzer HP 8753E	US37390585	18-Oct-01 (in house check Oct-12)	In house check: Oct-13
RF generator R&S SMT-06	SN: 832283/011	27-Aug-12 (in house check Oct-12)	In house check: Oct-14

	Name	Function	Signature
Calibrated by:	Dimce Iliev	Laboratory Technician	
Approved by:	Fin Bomholt	Deputy Technical Manager	

Issued: March 6, 2013

This calibration certificate shall not be reproduced except in full without written approval of the laboratory.



Accredited by the Swiss Accreditation Service (SAS)

The Swiss Accreditation Service is one of the signatories to the EA
Multilateral Agreement for the recognition of calibration certificates

Accreditation No.: **SCS 108**

References

- [1] ANSI-C63.19-2011
American National Standard, Methods of Measurement of Compatibility between Wireless Communications Devices and Hearing Aids.

Methods Applied and Interpretation of Parameters:

- *Coordinate System:* y-axis is in the direction of the dipole arms. z-axis is from the basis of the antenna (mounted on the table) towards its feed point between the two dipole arms. x-axis is normal to the other axes. In coincidence with the standards [1], the measurement planes (probe sensor center) are selected to be at a distance of 15 mm above the top metal edge of the dipole arms.
- *Measurement Conditions:* Further details are available from the hardcopies at the end of the certificate. All figures stated in the certificate are valid at the frequency indicated. The forward power to the dipole connector is set with a calibrated power meter connected and monitored with an auxiliary power meter connected to a directional coupler. While the dipole under test is connected, the forward power is adjusted to the same level.
- *Antenna Positioning:* The dipole is mounted on a HAC Test Arch phantom using the matching dipole positioner with the arms horizontal and the feeding cable coming from the floor. The measurements are performed in a shielded room with absorbers around the setup to reduce the reflections. It is verified before the mounting of the dipole under the Test Arch phantom, that its arms are perfectly in a line. It is installed on the HAC dipole positioner with its arms parallel below the dielectric reference wire and able to move elastically in vertical direction without changing its relative position to the top center of the Test Arch phantom. The vertical distance to the probe is adjusted after dipole mounting with a DASY5 Surface Check job. Before the measurement, the distance between phantom surface and probe tip is verified. The proper measurement distance is selected by choosing the matching section of the HAC Test Arch phantom with the proper device reference point (upper surface of the dipole) and the matching grid reference point (tip of the probe) considering the probe sensor offset. The vertical distance to the probe is essential for the accuracy.
- *Feed Point Impedance and Return Loss:* These parameters are measured using a HP 8753E Vector Network Analyzer. The impedance is specified at the SMA connector of the dipole. The influence of reflections was eliminated by applying the averaging function while moving the dipole in the air, at least 70cm away from any obstacles.
- *E-field distribution:* E field is measured in the x-y-plane with an isotropic ER3D-field probe with 100 mW forward power to the antenna feed point. In accordance with [1], the scan area is 20mm wide, its length exceeds the dipole arm length (180 or 90mm). The sensor center is 15 mm (in z) above the metal top of the dipole arms. Two 3D maxima are available near the end of the dipole arms. Assuming the dipole arms are perfectly in one line, the average of these two maxima (in subgrid 2 and subgrid 8) is determined to compensate for any non-parallelity to the measurement plane as well as the sensor displacement. The E-field value stated as calibration value represents the maximum of the interpolated 3D-E-field, in the plane above the dipole surface.

The reported uncertainty of measurement is stated as the standard uncertainty of measurement multiplied by the coverage factor $k=2$, which for a normal distribution corresponds to a coverage probability of approximately 95%.

Measurement Conditions

DASY system configuration, as far as not given on page 1.

DASY Version	DASY5	V52.8.5
Extrapolation	Advanced Extrapolation	
Phantom	HAC Test Arch	
Distance Dipole Top - Probe Center	15mm	
Scan resolution	dx, dy = 5 mm	
Frequency	1730 MHz \pm 1 MHz 1880 MHz \pm 1 MHz	
Input power drift	< 0.05 dB	

Maximum Field values at 1730 MHz

E-field 15 mm above dipole surface	condition	Interpolated maximum
Maximum measured above high end	100 mW input power	98.7 V / m
Maximum measured above low end	100 mW input power	98.4 V / m
Averaged maximum above arm	100 mW input power	98.5 V / m \pm 12.8 % (k=2)

Maximum Field values at 1880 MHz

E-field 15 mm above dipole surface	condition	Interpolated maximum
Maximum measured above high end	100 mW input power	91.2 V / m
Maximum measured above low end	100 mW input power	89.1 V / m
Averaged maximum above arm	100 mW input power	90.2 V / m \pm 12.8 % (k=2)

Appendix

Antenna Parameters

Nominal Frequencies

Frequency	Return Loss	Impedance
1730 MHz	22.8 dB	$49.3 \Omega + 7.2 j\Omega$
1880 MHz	22.7 dB	$50.7 \Omega + 7.4 j\Omega$
1900 MHz	24.5 dB	$52.7 \Omega + 5.5 j\Omega$
1950 MHz	31.2 dB	$52.8 \Omega + 0.1 j\Omega$
2000 MHz	19.6 dB	$40.9 \Omega + 2.5 j\Omega$

Additional Frequencies

Frequency	Return Loss	Impedance
1730 MHz	22.8 dB	$49.3 \Omega + 7.2 j\Omega$

3.2 Antenna Design and Handling

The calibration dipole has a symmetric geometry with a built-in two stub matching network, which leads to the enhanced bandwidth.

The dipole is built of standard semirigid coaxial cable. The internal matching line is open ended. The antenna is therefore open for DC signals.

Do not apply force to dipole arms, as they are liable to bend. The soldered connections near the feedpoint may be damaged. After excessive mechanical stress or overheating, check the impedance characteristics to ensure that the internal matching network is not affected.

After long term use with 40W radiated power, only a slight warming of the dipole near the feedpoint can be measured.

Impedance Measurement Plot

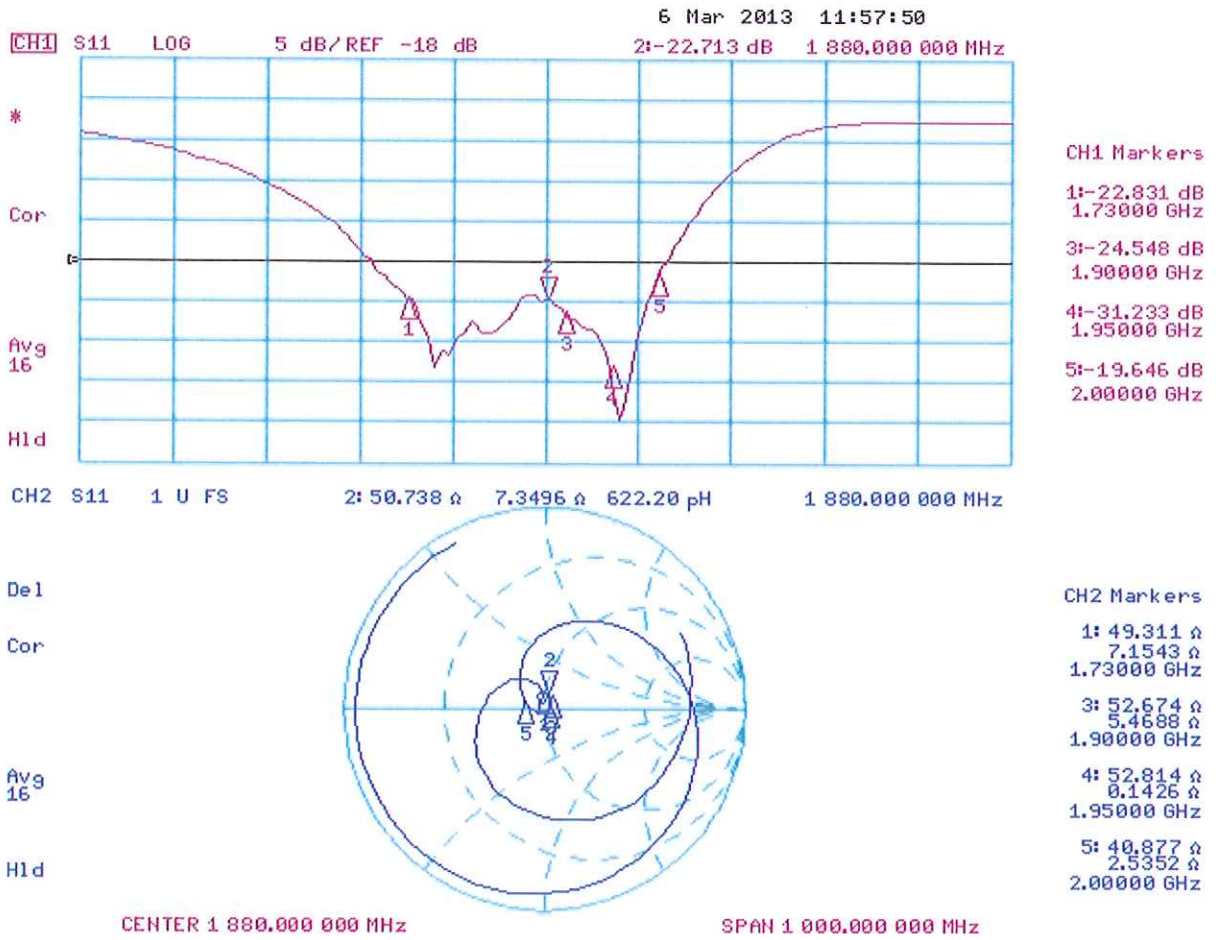

DASY5 E-field Result

Date: 05.03.2013

Test Laboratory: SPEAG Lab2

DUT: HAC Dipole 1880 MHz; Type: CD1880V3; Serial: CD1880V3 - SN: 1059

Communication System: CW; Frequency: 1730 MHz, Frequency: 1880 MHz

Medium parameters used: $\sigma = 0$ S/m, $\epsilon_r = 1$; $\rho = 1000$ kg/m³

Phantom section: RF Section

Measurement Standard: DASY5 (IEEE/IEC/ANSI C63.19-2011)

DASY52 Configuration:

- Probe: ER3DV6 - SN2336; ConvF(1, 1, 1); Calibrated: 28.12.2012;
- Sensor-Surface: (Fix Surface)
- Electronics: DAE4 Sn781; Calibrated: 29.05.2012
- Phantom: HAC Test Arch with AMCC; Type: SD HAC P01 BA; Serial: 1070
- DASY52 52.8.5(1059); SEMCAD X 14.6.8(7028)

Dipole E-Field measurement @ 1880MHz/E-Scan - 1730MHz d=15mm/Hearing Aid Compatibility Test (41x181x1): Interpolated grid: dx=0.5000 mm, dy=0.5000 mm

Device Reference Point: 0, 0, -6.3 mm

Reference Value = 173.2 V/m; Power Drift = 0.02 dB

PMR not calibrated. PMF = 1.000 is applied.

E-field emissions = 98.65 V/m

Near-field category: M3 (AWF 0 dB)

PMF scaled E-field

Grid 1 M3 95.30 V/m	Grid 2 M3 98.38 V/m	Grid 3 M3 97.42 V/m
Grid 4 M3 76.23 V/m	Grid 5 M3 77.85 V/m	Grid 6 M3 76.96 V/m
Grid 7 M3 95.05 V/m	Grid 8 M3 98.65 V/m	Grid 9 M3 98.11 V/m

Dipole E-Field measurement @ 1880MHz/E-Scan - 1880MHz d=15mm/Hearing Aid Compatibility Test (41x181x1):

Interpolated grid: dx=0.5000 mm, dy=0.5000 mm

Device Reference Point: 0, 0, -6.3 mm

Reference Value = 156.8 V/m; Power Drift = -0.00 dB

PMR not calibrated. PMF = 1.000 is applied.

E-field emissions = 91.18 V/m

Near-field category: M3 (AWF 0 dB)

PMF scaled E-field

Grid 1 M3 88.69 V/m	Grid 2 M3 91.18 V/m	Grid 3 M3 90.27 V/m
Grid 4 M3 70.48 V/m	Grid 5 M3 71.69 V/m	Grid 6 M3 70.90 V/m
Grid 7 M3 85.85 V/m	Grid 8 M3 89.13 V/m	Grid 9 M3 88.74 V/m

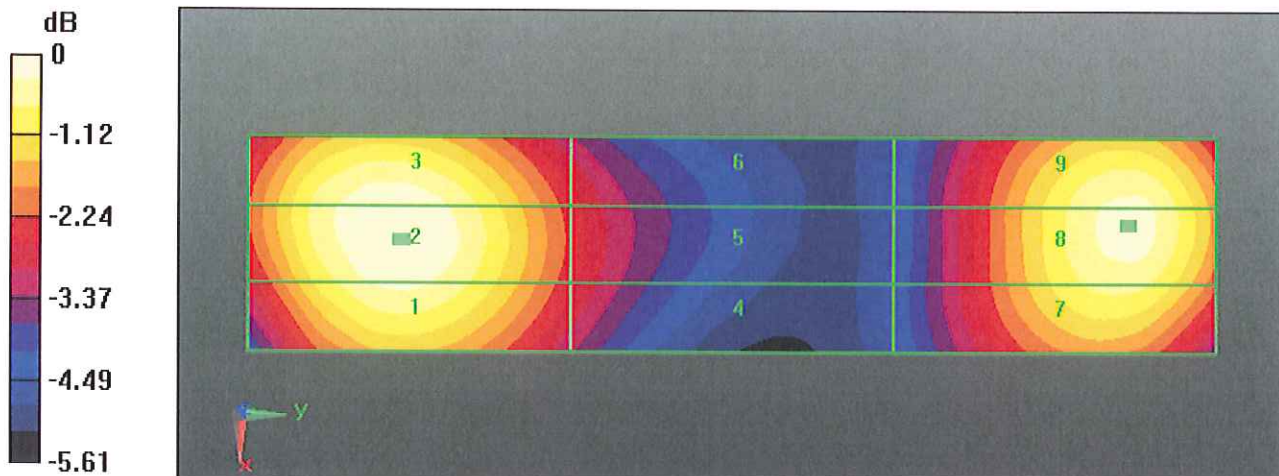

0 dB = 98.65 V/m = 39.88 dBV/m

Appendix 7
UID Specifications

**Calibration Laboratory of
Schmid & Partner
Engineering AG**
Zeughausstrasse 43, 8004 Zurich, Switzerland

Name:	CDMA2000 (1xRTT, RC1)
Group:	CDMA2000
UID:	10039-CAA
PAR: ¹	4.57 dB
MIF: ²	-19.77 dB
Standard Reference:	3GPP2 C.S0002-C-1, Chapter 2.1.3.9.2.3 FCC OET KDB 941225 D01 SAR test for 3G devices (v02)
Category:	Random amplitude modulation
Modulation:	64-ary orthogonal
Frequency Band:	Band Class 0 (824.0-849.0 MHz, 20039) Band Class 1 (1850.0-1910.0 MHz, 20040) Band Class 2 (872.0-915.0 MHz, 20041) Band Class 3 (887.0-925.0 MHz, 20042) Band Class 4 (1750.0-1780.0 MHz, 20043) Band Class 5 (411.7-483.5 MHz, 20044) Band Class 6 (1920.0-1980.0 MHz, 20045) Band Class 7 (776.0-794.0 MHz, 20046) Band Class 8 (1710.0-1785.0 MHz, 20047) Band Class 9 (880.0-915.0 MHz, 20048) Band Class 10 (806.0-901.0 MHz, 20049) Band Class 11 (410.0-462.5 MHz, 20050) Band Class 12 (870.0-876.0 MHz, 20051)
Detailed Specification:	Radio Configurations 1 (RC1) Output Slot: FCH 9.6 kpbs (PN9fix)
Bandwidth:	1.2 MHz
Integration Time:	80.0 ms

¹ PAR (0.1%) in accordance with FCC KDB 971168, Section 6.0 "Measurement of the Peak-to-Average Power Ratio (PAPR)"

² Modulation Interference Factor (MIF) value valid only in conjunction with advanced probe response linearization calibration for the same communication system (same UID and version).

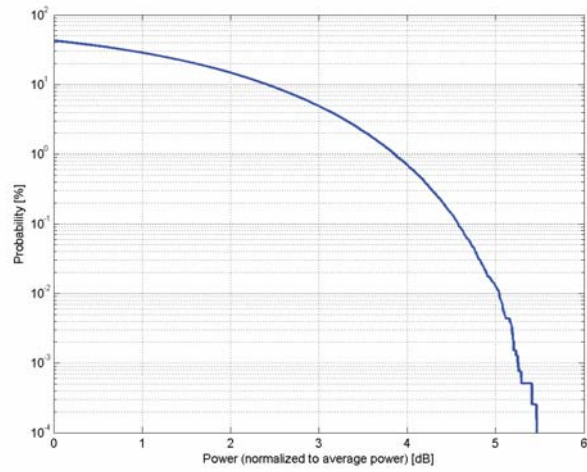

Complementary Cumulative Distribution Function (CCDF)

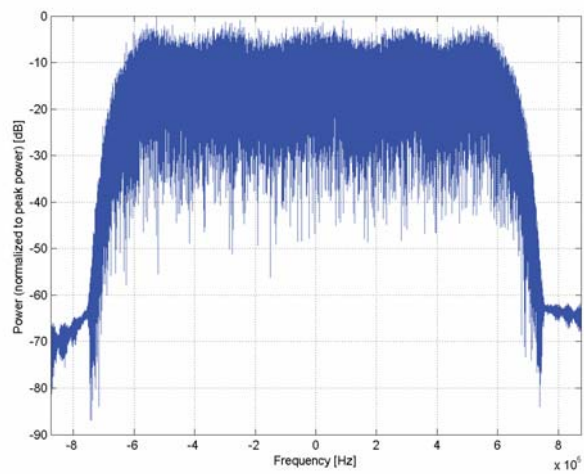

Frequency Domain

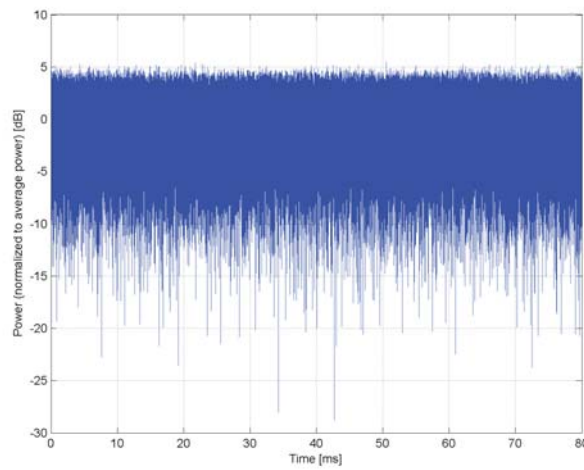

Time Domain

Name:	CDMA2000, RC1, SO3, 1/8th Rate 25 fr.
Group:	CDMA2000
UID:	10295-AAA
PAR: ¹	12.49 dB
MIF: ²	3.26 dB
Standard Reference:	3GPP2 C.S0002-C-1, Chapter 2.1.3.9.2.3 FCC OET KDB 941225 D01 SAR test for 3G devices (v02)
Category:	Random amplitude modulation
Modulation:	64-ary orthogonal
Frequency Band:	Band Class 0 (824.0-849.0 MHz, 20039) Band Class 1 (1850.0-1910.0 MHz, 20040) Band Class 2 (872.0-915.0 MHz, 20041) Band Class 3 (887.0-925.0 MHz, 20042) Band Class 4 (1750.0-1780.0 MHz, 20043) Band Class 5 (411.7-483.5 MHz, 20044) Band Class 6 (1920.0-1980.0 MHz, 20045) Band Class 7 (776.0-794.0 MHz, 20046) Band Class 8 (1710.0-1785.0 MHz, 20047) Band Class 9 (880.0-915.0 MHz, 20048) Band Class 10 (806.0-901.0 MHz, 20049) Band Class 11 (410.0-462.5 MHz, 20050) Band Class 12 (870.0-876.0 MHz, 20051)
Detailed Specification:	Radio Configuration 1 (RC1) Service Option 3 (SO3) Speech codec: 8k EVRC (Enhanced Voice Rate Codec) 1/8th frame rate
Bandwidth:	1.2 MHz
Integration Time:	500.0 ms

¹ PAR (0.1%) in accordance with FCC KDB 971168, Section 6.0 "Measurement of the Peak-to-Average Power Ratio (PAPR)"

² Modulation Interference Factor (MIF) value valid only in conjunction with advanced probe response linearization calibration for the same communication system (same UID and version).

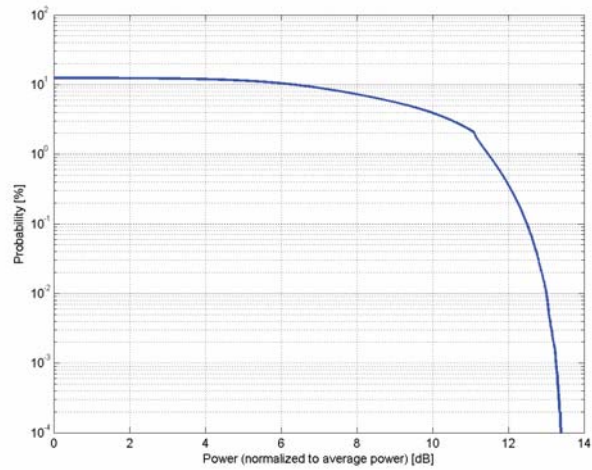

Complementary Cumulative Distribution Function (CCDF)

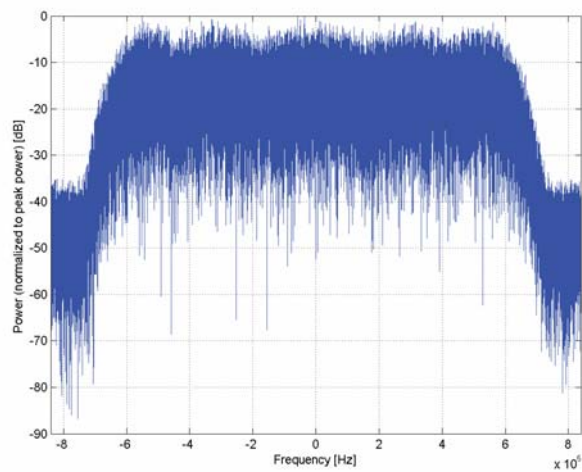

Frequency Domain

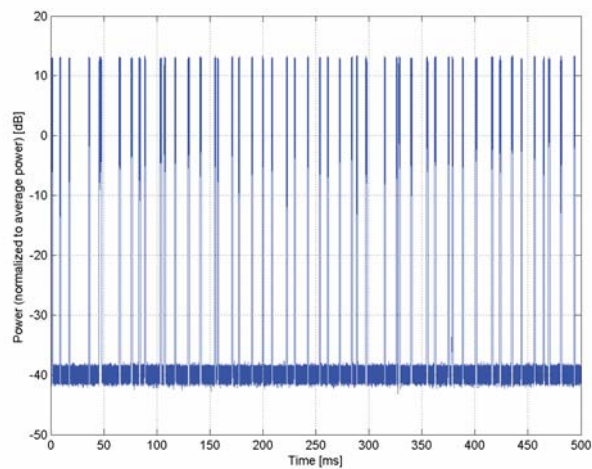

Time Domain

END OF REPORT