



**motorola**  
a Google company

## Portable Cellular Phone SAR Test Report

**Tests Requested By:** Motorola Mobility, LLC  
600 N. US Highway 45  
Libertyville, IL 60048

**Test Report #:** 25492-1F  
**Date of Report:** August 14, 2013  
**Date of Test:** July 25 – August 7, 2013  
**FCC ID #:** IHDT56PF2  
**IC ID #:** 1090-T56PF2  
**Generic Name:** M0DED

**Test Laboratory:** Motorola Mobility, LLC - ADR Test Service Laboratory  
600 N. US Highway 45  
Libertyville, IL 60048

**Report Author:** Steve Hauswirth  
Distinguished Member of the Technical Staff

This laboratory is accredited to ISO/IEC 17025-2005 to perform the following tests:

**Accreditation:**



Tests:  
Electromagnetic Specific Absorption Rate

Procedures:  
IEC 62209-1  
RSS-102  
IEEE 1528 - 2003  
FCC OET Bulletin 65 (*including Supplement C*)  
Australian Communications Authority Radio  
Communications (Electromagnetic Radiation –  
Human Exposure) Standard 2003  
CENELEC EN 50360  
ARIB Std. T-56 (2002)

On the following products or types of products:

Wireless Communications Devices (Examples): Two Way Radios; Portable Phones (including Cellular, Licensed Non-Broadcast and PCS); Low Frequency Readers; and Pagers

**Statement of Compliance:**

Motorola declares under its sole responsibility that the portable cellular telephone model to which this declaration relates, is in conformity with the appropriate General Population/Uncontrolled RF exposure standards, recommendations and guidelines (FCC 47 CFR §2.1093) as well as with CENELEC en50360:2001 and ANSI / IEEE C95.1. It also declares that the product was tested in accordance with IEEE 1528 / CENELEC EN62209-1 (2006), along with other published guidance indicated in the references at the end of this report, as well as other appropriate measurement standards, guidelines and recommended practices. Any deviations from these standards, guidelines and recommended practices are noted below:

(none)

©Motorola Mobility, LLC 2013

This test report shall not be reproduced except in full, without written approval of the laboratory. The results and statements contained herein relate only to the items tested. The names of individuals involved may be mentioned only in connection with the statements or results from this report. Motorola encourages all feedback, both positive and negative, on this test report.

## Table of Contents

- 1 Introduction.....3
- 2 Details of the Device Under Test.....4
  - 2.1 Sample Information.....4
  - 2.2 Antenna Description.....4
  - 2.3 Transmission Band Summary .....5
  - 2.4 Device Test Setup, Operating Configurations, and Conducted Power Measurements.....6
    - 2.4.1 GSM.....6
    - 2.4.2 WCDMA .....8
    - 2.4.3 Wi-Fi 802.11 .....9
    - 2.4.4 Bluetooth .....10
  - 2.5 Transmitter power reduction conditions and modes .....11
  - 2.6 Accessories for the Device Under Test .....12
    - 2.6.1 Batteries .....12
    - 2.6.2 Body-Worn Carry Accessories .....12
- 3 Test Equipment Used.....13
  - 3.1 Dosimetric Measurement System.....13
  - 3.2 Test System Validations.....14
  - 3.3 Test System Verifications (System Performance Checks).....15
  - 3.4 Simulated Tissue Dielectric Properties .....16
- 4 Test Setup Information, SAR Measurement Results, and Analysis.....18
  - 4.1 Overview of Test Setup and Results .....18
  - 4.2 Head-Adjacent Exposure Results.....19
  - 4.3 Body-Worn Accessory Exposure Results .....20
  - 4.4 Mobile Hotspot Exposure Results.....21
  - 4.5 Measurement Variability Analysis.....23
  - 4.6 Description and Evaluation of Simultaneous Transmitters .....24
- 5 References to Test Standards and Guidance .....29

- Appendix 1: SAR Distribution Plots for Test System Verification
- Appendix 2: SAR Distribution Plots for Head-Adjacent Test Results
- Appendix 3: SAR Distribution Plots for Body-Worn Accessory Test Results
- Appendix 4: SAR Distribution Plots for Mobile Hotspot Test Results
- Appendix 5: Measurement Uncertainty Budget
- Appendix 6: Probe Calibration Certificates
- Appendix 7: Dipole Characterization Certificates

### Revision History

Revision Version	Date	Notes
Rev. 0	Aug-14-2013	Initial report release
Rev. A	Sep-05-2013	Fix typos in power summary, reference tables and other TCB requested items
Rev. B	Sep-19-2013	Replace 802.11b Channel 1 SAR data with 802.11b Channel 6 measurements.
Rev. C	Sep-23-2013	Updates per TCB request

## 1 Introduction

The Motorola Mobility ADR Test Services Laboratory has performed measurements of the maximum potential exposure to the user of the portable cellular phone covered by this test report. The Specific Absorption Rate (SAR) of this product was measured. The portable cellular phone was tested in accordance with [1], [5], [9], and per FCC KDB 941225 D06 for mobile hotspot operation. The SAR values measured for the portable cellular phone are below the maximum recommended levels of 1.6 W/kg in a 1 g average set in [3] and 2.0 W/kg in a 10 g average set in [2].

For ANSI / IEEE C95.1 (1 g), the final stand-alone SAR readings for this phone are given in the table below. These measurements were performed using a DASY52™ system manufactured by Schmid & Partner Engineering AG (SPEAG), of Zurich Switzerland.

Transmit Band	Head SAR (1 g <sup>W</sup> /kg)	Body-Worn Accessory SAR (1 g <sup>W</sup> /kg)	Mobile Hotspot SAR (1 g <sup>W</sup> /kg)
GSM 850	0.49	0.83	0.44
GSM 1900	0.60	0.90	1.31
WCDMA 850	0.52	0.95	0.58
WCDMA 1700	0.24	0.65	1.42
WCDMA 1900	1.17	1.06	1.07
Wi-Fi 2.45 GHz	0.51	0.12	0.25
Bluetooth	N/A		

## 2 Details of the Device Under Test

### 2.1 Sample Information

<b>Serial Number(s) (Functional Use)</b>	LDXU220297	All WCDMA testing
	LDXU220002	GPRS Mobile Hotspot Power Reduction Testing
	LDXU220303	All WLAN testing
	LDXU220015	GSM Head and Body Testing
<b>Production Unit or Identical Prototype (47 CFR §2.908)</b>	Identical Prototype	
<b>Device Category</b>	Portable (Mobile Station Class B)	
<b>RF Exposure Limits</b>	General Population / Uncontrolled	

### 2.2 Antenna Description

Main (850/1900 MHz) Antenna

<b>Type</b>	Internal	
<b>Location</b>	Bottom of Transceiver	
<b>Dimensions</b>	Width	5.6 mm
	Length	55.0 mm

Bluetooth/Wi-Fi 2.45 GHz Antenna

<b>Type</b>	Internal	
<b>Location</b>	Left-Side Rear of Transceiver	
<b>Dimensions</b>	Width	9.00 mm
	Length	10.00 mm

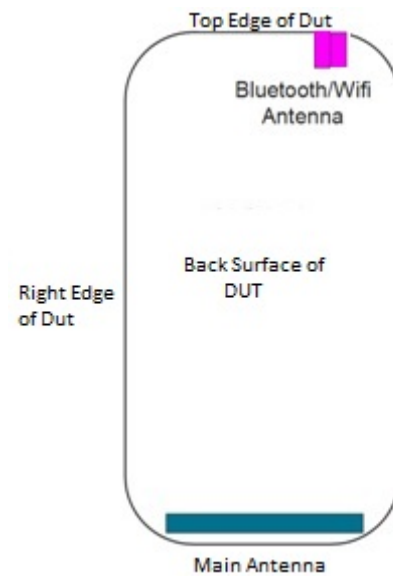

### 2.3 Transmission Band Summary

Mode(s) of Operation	Modulation Mode(s)	Target Output Power Setting	Tune-Up Tolerance	Duty Cycle	Transmitting Frequency Range(s)
GSM 850	GMSK	32.5 dBm	-1.0 dB / +1.0 dB	1:8	824.2 - 848.8 MHz
GPRS/EDGE 850	GMSK	32.5 dBm	-1.0 dB / +1.0 dB	1:8, 2:8, 3:8, 4:8	824.2 - 848.8 MHz
EDGE 850	8PSK	26.5 dBm	-1.5 dB / +1.5 dB	1:8, 2:8, 3:8, 4:8	824.2 - 848.8 MHz
GSM 1900	GMSK	29.5 dBm	-1.0 dB / +1.0 dB	1:8	1850.2 - 1909.8 MHz
GPRS/EDGE 1900	GMSK	29.5 dBm	-1.0 dB / +1.0 dB	1:8, 2:8, 3:8, 4:8	1850.2 - 1909.8 MHz
EDGE 1900	8PSK	25.5 dBm	-1.5 dB / +1.5 dB	1:8, 2:8, 3:8, 4:8	1850.2 - 1909.8 MHz
WCDMA 850	QPSK	22.5 dBm	-1.5 dB / +1.5 dB	1:1	826.4 - 846.6 MHz
WCDMA 1700	QPSK	22.5 dBm	-1.5 dB / +1.5 dB	1:1	1712.4 - 1752.6 MHz
WCDMA 1900	QPSK	22.5 dBm	-1.5 dB / +1.5 dB	1:1	1852.4 - 1907.6 MHz
Wi-Fi 802.11b/g/n	BPSK	19.0 dBm		1:1	2412.0 - 2462.0 MHz
Bluetooth	GFSK	11.0 dBm		1:1	2402.0 - 2480.0 MHz

## 2.4 Device Test Setup, Operating Configurations, and Conducted Power Measurements

### 2.4.1 GSM

#### Technical Description

The phone under test contains a GSM transmitter that supports voice (circuit-switched) capability, and data (packet-switched) capabilities over GPRS/EDGE (GMSK) or EDGE (8PSK).

#### Exposure Conditions and Test Exclusions

Mode	Type	Head-Adjacent	Body-Worn Accessory	Mobile Hotspot
GSM (GMSK 1-Slot)	Voice	Tested	Tested	N/A
GPRS/EDGE (GMSK Multi-Slot)	Data	Tested (1) (3)	Tested (1) (3)	Tested (3)
EDGE (8PSK Multi-Slot)	Data	Excluded (2) (3)	Excluded (2) (3)	Excluded (2) (3)

#### Notes:

- (1) GPRS/EDGE (GMSK Multi-Slot), as a data-only mode, was tested against the Head and in Body-Worn Accessory exposure conditions to support evaluation for 3<sup>rd</sup> Party VOIP applications potentially installed and used by the end-user. Due to the common transmit lineup and antenna used for GPRS/EDGE, only the configurations (head/body placement and channel used) that resulted in the highest measured GSM voice SAR were used for VoIP (GPRS) measurements.
- (2) EDGE (8PSK Multi-Slot) was excluded from testing per FCC KDB 941225 D03, as the source-based time-averaged output power in this mode is lower than that measured in normal GSM voice mode and GPRS/EDGE (GMSK Multi-Slot) data modes.
- (3) GPRS/EDGE (GMSK Multi-Slot) and EDGE (8PSK Multi-Slot) utilize reduced output power as additional time slots are transmitted in the uplink frame, as demonstrated in the following table. The values noted are maximum limits, and conform to the same power tune-up tolerances noted in section 2.3 above. The multi-slot configuration that results in the highest source-based time-averaged output power from the device was chosen for testing when testing of these modes is required.

GSM Data Functionality	GPRS/EDGE Class 12 (4 uplink timeslots; 4 downlink timeslots; 5 total timeslots per frame)							
	Class B (DTM not supported)							
Mode(s) of Operation	GPRS/EDGE 850				GPRS/EDGE 1900			
Modulation	GMSK				GMSK			
Maximum TX Burst Output Power Setting (dBm)	33.5	<b>32.5</b>	28.75	28.0	30.5	<b>29.5</b>	25.75	25.0
Maximum Time Average Output Power Setting (dBm)	24.5	<b>26.5</b>	24.45	25.0	21.5	<b>23.5</b>	21.45	22.0
Duty Cycle	1:8	<b>2:8</b>	3:8	4:8	1:8	<b>2:8</b>	3:8	4:8
Transmitting Frequency Range(s)	824.2 - 848.8 MHz				1850.2 - 1909.8 MHz			
Mode(s) of Operation	EDGE 850				EDGE 1900			
Modulation	8PSK				8PSK			
Maximum TX Burst Output Power Setting (dBm)	28.0	27.0	24.0	22.5	27.0	26.0	22.75	21.5
Maximum Time Average Output Power Setting (dBm)	19.0	21.0	19.7	19.5	18.0	20.0	18.45	18.5
Duty Cycle	1:8	2:8	3:8	4:8	1:8	2:8	3:8	4:8
Transmitting Frequency Range(s)	824.2 - 848.8 MHz				1850.2 - 1909.8 MHz			

## Device Test Setup

For GSM modes, the test sample was operated using transmission to a base station simulator. The base station simulator was set up for the proper channel and transmit mode of operation on the phone's uplink. The transmitter power level and power control were set to maximum at power step 5 for GSM 850 band, and power step 0 for GSM 1900 band.

## Conducted Power Measurements

Band	Channel	Conducted power (dBm) for GSM modes (Burst Average Power)								
		GSM CS Voice (1 Slot)	GPRS PS Data (1 Slot)	GPRS PS Data (2 Slots)	GPRS PS Data (3 Slots)	GPRS PS Data (4 Slots)	EDGE PS Data (1 Slot)	EDGE PS Data (2 Slots)	EDGE PS Data (3 Slots)	EDGE PS Data (4 Slots)
GSM 850	128	32.59	32.61	31.53	27.69	26.34	26.30	25.43	22.08	20.89
	190	32.67	32.67	31.51	27.76	26.48	26.34	25.46	22.13	20.99
	251	32.68	32.67	31.43	27.81	26.43	26.29	25.42	22.44	20.95
GSM 1900	512	29.70	29.68	28.63	25.15	23.83	25.58	24.51	21.45	20.47
	661	29.76	29.76	28.64	25.14	23.78	25.58	24.45	21.43	20.36
	810	29.61	29.61	28.49	25.03	23.67	25.46	24.32	21.34	20.55

Band	Channel	Conducted power (dBm) for GSM modes (Source-Based Time-Averaged Power)								
		GSM CS Voice (1 Slot)	GPRS PS Data (1 Slot)	GPRS PS Data (2 Slots)	GPRS PS Data (3 Slots)	GPRS PS Data (4 Slots)	EDGE PS Data (1 Slot)	EDGE PS Data (2 Slots)	EDGE PS Data (3 Slots)	EDGE PS Data (4 Slots)
GSM 850	128	23.56	23.58	25.51	23.43	23.33	23.29	22.42	19.07	17.88
	190	23.64	23.64	25.49	23.50	23.47	23.33	22.45	19.12	17.98
	251	23.65	23.64	25.41	23.55	23.42	23.28	22.41	19.43	17.94
GSM 1900	512	20.67	20.65	22.61	20.89	20.82	22.57	21.50	18.44	17.46
	661	20.73	20.73	22.62	20.88	20.77	22.57	21.44	18.42	17.35
	810	20.58	20.58	22.47	20.77	20.66	22.45	21.31	18.33	17.54

Burst Average Power was measured using a power meter set to the appropriate profile to capture average power in the transmitting timeslot(s). Source-Based Time-Averaged Power, being related to the Burst Average Power by a fixed factor dependent on the number of time slots active in the frame, was calculated as follows (in dB), where  $x$  is the number of time slots active:

$$P_{Source} = P_{Burst} - 10 * \log \left( \frac{x}{8.3} \right)$$

CS Voice denotes circuit-switched transmission for voice call operation, and PS Data denotes packet-switched transmission for data sessions.

## 2.4.2 WCDMA

### Technical Description

The phone under test contains a WCDMA transmitter designed per 3GPP TS 25.101, that supports both voice and data capabilities.

### Exposure Conditions and Test Exclusions

Mode	Type	Head-Adjacent	Body-Worn Accessory	Mobile Hotspot
RMC	Voice/Data	Tested	Tested	Tested
AMR	Voice/Data	Excluded (1)	Excluded (1)	Excluded (1)
HSDPA (Rel 5) Modes	Data	Excluded (1)	Excluded (1)	Excluded (1)
HSPA (Rel 6) Modes	Data	Excluded (1)	Excluded (1)	Excluded (1)

#### Notes:

(1) AMR, HSDPA (Rel. 5), and HSPA (Rel. 6) were excluded from testing per FCC KDB 941225 D01, as the measured output power in these modes is not more than ¼ dB higher than that measured in RMC and the maximum SAR for the RMC mode is < 75% of the SAR limit.

### Device Test Setup

For WCDMA modes, the test sample was operated using transmission to a base station simulator. The base station simulator was set up for the proper channel and transmit mode of operation on the phone's uplink. The transmitter power level and transmit power control were set to "All 1's" for RMC and AMR modes in WCDMA or HSDPA, or inner loop power control procedures were applied to maintain maximum output power while HSUPA was active.

### Conducted Power Measurements

Power measurements were executed per FCC KDB 941225 D01:

Band	Channel	Conducted power (dBm) for WCDMA modes		Conducted Power (dBm) for WCDMA – HSDPA (Rel 5) Modes				Conducted Power (dBm) for WCDMA – HSPA (HSUPA/HSDPA-Rel 6) Modes				
		RMC	AMR	Subtest 1	Subtest 2	Subtest 3	Subtest 4	Subtest 1	Subtest 2	Subtest 3	Subtest 4	Subtest 5
WCDMA 850	4132	22.85	23.10	21.89	21.41	21.43	21.45	20.57	20.93	20.66	20.64	21.86
	4180	22.89	23.10	21.97	21.46	21.41	21.48	21.09	20.98	20.82	20.58	21.01
	4233	22.78	22.97	21.75	21.24	21.34	21.38	21.25	20.74	20.78	20.61	20.43
WCDMA 1700	1312	22.85	22.89	21.78	21.24	21.39	21.28	21.29	21.19	20.42	21.35	21.44
	1413	22.72	22.78	21.66	21.23	21.19	21.25	21.07	20.90	20.82	21.46	21.13
	1513	22.97	23.04	21.84	21.50	21.44	21.51	21.19	21.14	21.05	21.67	21.36
WCDMA 1900	9262	23.07	22.91	21.92	21.37	21.50	21.41	21.36	21.36	21.70	21.80	21.85
	9400	22.90	22.86	21.85	21.24	21.39	21.36	21.23	21.12	21.47	21.53	21.60
	9538	22.85	22.81	21.81	21.27	21.31	21.36	21.32	20.73	21.02	21.37	21.87

### 2.4.3 Wi-Fi 802.11

#### Technical Description

The phone under test contains a Wi-Fi 802.11b/g/n transmitter capable of data transmission in the 2.45 GHz ISM band.

#### Exposure Conditions and Test Exclusions

Mode	Type	Head-Adjacent	Body-Worn Accessory	Mobile Hotspot
802.11b	Data	Tested (1)	Tested (1)	Tested (1)
802.11g / 802.11n	Data	Excluded (1)	Excluded (1)	Excluded (1)

#### Notes:

- (1) Per FCC KDB 248227 D01 and the April 2010 FCC/TCB Meeting Notes, the highest average output power channel for the lowest data rate for 802.11b was selected for SAR evaluation. Other 802.11 modes (including 802.11g and 802.11n) were not investigated because the average output powers over all channels and data rates were not more than ¼ dB higher than the tested channel in the lowest data rate of the 802.11b mode. The **bolded** data rate and channel in the following conducted power tables was used for SAR testing.

#### Device Test Setup

For Wi-Fi 802.11 modes, the test sample was operated using manufacturer test mode software per guidance provided in FCC KDB 248227. The test software was set up for the proper channel, transmitter power level and transmit modes of operation on the phone's uplink.

#### Conducted Power Measurements

Band	Channel	Average Conducted Power (dBm) for 802.11b Mode Data Rates			
		1 Mbps	2 Mbps	5.5 Mbps	11 Mbps
2450 MHz	1	18.19	18.17	18.22	18.18
	6	<b>18.91</b>	18.92	18.89	18.92
	11	17.90	17.87	17.87	17.83

Band	Channel	Average Conducted Power (dBm) for 802.11g Mode Data Rates							
		6 Mbps	9 Mbps	12 Mbps	18 Mbps	24 Mbps	36 Mbps	48 Mbps	54 Mbps
2450 MHz	1	11.38	11.40	11.41	11.39	11.44	11.34	11.32	11.31
	6	17.02	17.01	17.02	17.03	16.98	16.98	17.02	17.01
	11	11.75	11.75	11.75	11.76	11.74	11.76	11.72	11.72

Band	Channel	Average Conducted Power (dBm) for 802.11n Mode Data Rates (20 MHz Channel, 800 ns Guard Interval)							
		6.5 Mbps	13 Mbps	19.5 Mbps	26 Mbps	39 Mbps	52 Mbps	58.5 Mbps	65 Mbps
2450 MHz	1	11.41	11.43	11.40	11.28	11.26	11.10	11.18	11.23
	6	16.98	17.02	16.98	16.88	16.87	16.94	16.83	16.78
	11	11.77	11.73	11.84	11.78	11.76	11.70	11.62	11.65

Band	Channel	Average Conducted Power (dBm) for 802.11n Mode Data Rates (20 MHz Channel, 400 ns Guard Interval)							
		7.2 Mbps	14.4 Mbps	21.6 Mbps	28.8 Mbps	43.3 Mbps	57.7 Mbps	65 Mbps	72.2 Mbps
2450 MHz	1	11.41	11.45	11.37	11.31	11.32	11.29	11.27	11.14
	6	17.00	17.02	16.99	17.00	16.91	16.95	16.92	16.85
	11	11.83	11.88	11.84	11.70	11.73	11.68	11.70	11.73

## 2.4.4 Bluetooth

### Technical Description

The phone under test contains a Bluetooth transmitter capable of data transmission in the 2.45 GHz ISM band.

### Exposure Conditions and Test Exclusions

Mode	Type	Head-Adjacent	Body-Worn Accessory	Mobile Hotspot
All Modes	Data	Excluded (2)	Excluded (1)(2)	Excluded (1)(2)

Notes:

(1) Per FCC KDB 447498 D01, standalone SAR measurements of the Bluetooth transmitter in this phone were not required based on the maximum conducted power and the Bluetooth antenna-to-user separation distance. As detailed by the KDB publication, the SAR exclusion threshold for distances < 50 mm is defined by the following equation:

$$\frac{[maximum\ power\ of\ channel,\ including\ tune\ -\ up\ tolerance]_{(mW)}}{[minimum\ test\ separation\ distance]_{(mm)}} \times \sqrt{f_{(GHz)}} \leq 3.0$$

Based on the maximum conducted power of Bluetooth and the most conservative antenna-to-user separation distance used in testing, standalone SAR measurements for Bluetooth were not required.

$$\frac{[13]_{(mW)}}{[10]_{(mm)}} \times \sqrt{2.41_{(GHz)}} = 2.0 \leq 3.0$$

Note that simultaneous SAR evaluations include estimations for Bluetooth SAR, as detailed in section 4.6 below.

(2) Per IC RSS-102 section 2.5.1, routine SAR evaluation of the Bluetooth transmitter in this phone was not required as the maximum conducted power of this transmitter is below 20 mW for a device operating between 2.2 GHz and 3 GHz.

### Conducted Power Measurements

Frequency [MHz]	Data Rate [Mbps]	Channel Number	Conducted Power [mW]
2402	1.0	0	11.566
2441	1.0	39	10.782
2480	1.0	78	10.046
2402	2.0	0	11.717
2441	2.0	39	10.937
2480	2.0	78	10.228
2402	3.0	0	12.112
2441	3.0	39	11.306
2480	3.0	78	10.524

Frequency [MHz]	Mode	Channel Number	Conducted Power [mW]
2402	LE	0	1.613
2441	LE	39	1.535
2480	LE	78	1.364

## 2.5 Transmitter power reduction conditions and modes

The phone utilizes reduced limits for the maximum transmit power for its transmitters when operating under the following noted conditions to ensure SAR exposure compliance is maintained. Tables of the reduced limits used for testing are given below. A complete description of this functionality is provided in the “Operational Description” contained within Exhibit 12. The implementation to trigger the reduction in power requires the device to be radiating, which prevents conducted power measurements of this functionality without modification to the unit.

While operating in body-adjacent exposure configurations during a mobile hotspot session, a reduced maximum power limit is enforced for the GSM and WCDMA modes. Tables of the reduced limits used for testing are given below.

Mode(s) of Operation	WCDMA 850	WCDMA 1700	WCDMA 1900
Channel Range	4132 - 4233	1312 – 1513	9262 - 9538
Maximum Output Power Setting (dBm)	24.0	24.0	24.0
Reduced Maximum Output Power Setting (dBm)	22.0	22.0	19.0

Mode(s) of Operation	GPRS 850				EDGE 850			
Channel Range	975-124				975-124			
Modulation	GMSK				8PSK			
Duty Cycle	1:8.3	<b>2:8.3</b>	3:8.3	4:8.3	1:8.3	<b>2:8.3</b>	3:8.3	4:8.3
Maximum Output Power Setting (dBm)	33.5	<b>32.5</b>	28.75	28.0	28.0	<b>27.0</b>	24.0	22.5
Time Average Output Power Setting (dBm)	24.5	<b>26.5</b>	24.45	25.0	19.0	<b>21.0</b>	19.7	19.5
Reduced Maximum Output Power Setting (dBm)	30.5	<b>27.5</b>	24.75	23.5	28.0	<b>27.0</b>	24.0	22.5
Reduced Time Average Output Power Setting (dBm)	21.5	<b>21.5</b>	21.45	20.5	19.0	<b>21.0</b>	19.7	19.5

Mode(s) of Operation	GPRS 1900				EDGE 1900			
Channel Range	975-124				975-124			
Modulation	GMSK				8PSK			
Duty Cycle	1:8.3	<b>2:8.3</b>	3:8.3	4:8.3	1:8.3	<b>2:8.3</b>	3:8.3	4:8.3
Maximum Output Power Setting (dBm)	30.5	<b>29.5</b>	25.75	25.0	27.0	<b>26.0</b>	22.75	21.5
Time Average Output Power Setting (dBm)	21.5	<b>23.5</b>	21.45	22.0	18.0	<b>20.0</b>	18.45	18.5
Reduced Maximum Output Power Setting (dBm)	27.0	<b>24.0</b>	21.75	20.5	26.0	<b>23.5</b>	21.0	20.0
Reduced Time Average Output Power Setting (dBm)	18.0	<b>18.0</b>	17.45	17.5	17.0	<b>17.5</b>	16.7	17.0

See section 4.4 for tables detailing the complete interoperation of this power limit reduction schema.

## **2.6 Accessories for the Device Under Test**

### **2.6.1 Batteries**

The phone tested was an internal battery, part number: Model SNN5932A

This battery was used to do all of the SAR testing. The phone was placed in the SAR measurement system with a fully charged battery.

### **2.6.2 Body-Worn Carry Accessories**

There are no body-worn accessories available for this phone at the time of testing thus the device was tested per the Supplement C testing guidelines for devices that do not have body-worn accessories. A separation distance of 15 mm between the device and the flat phantom was used for testing body-worn accessory SAR. The chosen separation distance of 15 mm is utilized in order to support any case or holder accessories offered or to be offered by Motorola for this product. The device was tested with the front and back of the device facing the phantom. Both sides of the device were tested for Body SAR for the purpose of including the SAR evaluation for body-worn accessories that support the device with either side facing the user.

### 3 Test Equipment Used

#### 3.1 Dosimetric Measurement System

The Motorola Mobility ADR Test Services Laboratory utilizes a DASY52™ Dosimetric Assessment System manufactured by Schmid & Partner Engineering AG (SPEAG™), of Zurich Switzerland. All SAR measurements are taken within a shielded enclosure. The overall 10 g RSS uncertainty of the measurement system is  $\pm 11\%$  (K=1) with an expanded uncertainty of  $\pm 22\%$  (K=2). The overall 1 g RSS uncertainty of the measurement system is  $\pm 11\%$  (K=1) with an expanded uncertainty of  $\pm 22\%$  (K=2). The measurement uncertainty budget is given in Appendix 5. Per IEEE 1528, this uncertainty budget is applicable to the SAR range of 0.4 W/kg to 10 W/kg.

The list of calibrated equipment used for the measurements is shown in the following table. All equipment was brought into service and used only during its noted calibration period, except where indicated. Equipment without a calibration period was in service for the entirety of the test period.

Description	Serial Number	Cal Date	Cal Due Date	Service Notes
DASY™ DAE V1	661	May-21-2013	May-21-2014	Measurement System 1
E-Field Probe ES3DV3	3180	Feb-11-2013	Feb-11-2014	Measurement System 1
Twin SAM Phantom V4.0	TP-1156			Measurement System 1
Twin SAM Phantom V4.0	TP-1319			Measurement System 1
MFP V5.1 C Triple Modular Flat Phantom	1101			Measurement System 1
DASY™ DAE V1	376	Sep-3-2012	Sep-3-2013	Measurement System 2
E-Field Probe ES3DV3	3124	Aug-20-2012	Aug-20-2013	Measurement System 2
Twin SAM Phantom V4.0	TP-1235			Measurement System 2
Twin SAM Phantom V4.0	TP-1136			Measurement System 2
MFP V5.1 C Triple Modular Flat Phantom	1102			Measurement System 2
DASY™ DAE V1	784	Mar-6-2013	Mar-6-2014	Measurement System 3
E-Field Probe EX3DV4	3730	Aug-24-2012	Aug-24-2013	Measurement System 3
Twin SAM Phantom V4.0	TP-1106			Measurement System 3
Twin SAM Phantom V4.0	TP-1153			Measurement System 3
MFP V5.1 C Triple Modular Flat Phantom	1103			Measurement System 3
Dipole Validation Kit, DV835V2	422TR	Mar-18-2011	Mar-18-2012	Calibration extension, see note.
Dipole Validation Kit, DV835V2	436TR	Mar-18-2011	Mar-18-2012	Calibration extension, see note.
Dipole Validation Kit, DV1800V2	2D190	Jan-5-2012	Jan-5-2013	Calibration extension, see note.
Dipole Validation Kit, DV1800V2	259TR	Oct-20-2011	Oct-20-2012	Calibration extension, see note.
Dipole Validation Kit, DV2450V2	740	Feb-7-2012	Feb-7-2013	Calibration extension, see note.

Note: Per FCC KDB 865664 D01 v01r01, Section 3.2.2., evaluation for the extension of the dipole calibration was carried out. Results are provided in Appendix 7 in addition to the original calibration certificate.

### 3.2 Test System Validations

Per [5] and FCC KDB 865664 D01, each SAR system (including probes, system components, and software) used for device testing was validated against its performance specifications prior to deployment. These validation measurements are taken to ensure the accuracy of device test results. Validation measurements utilize reference dipoles and the required tissue-equivalent media, and include assessments of system sensitivity, probe linearity, and probe isotropy. Per FCC KDB 865664 D02, a tabulated summary of the validation results for each SAR system used in testing is given below.

<b>DASY52™ Measurement System 1</b>												
<b>System Validation Measurements</b>												
Probe	Tissue Type	f (MHz)	CW Validations				Modulated Validations					
			Date	Dielectric Parameters		Result	Date	Mod. Type	Dielectric Parameters		Duty Factor Linearity Results	High PAR Linearity Results
				Measured $\sigma$ (S/m)	Measured $\epsilon_r$				Measured $\sigma$ (S/m)	Measured $\epsilon_r$		
3180	Head	750	21-Feb-13	0.8599	41.52	pass						
3180	Head	835	21-Feb-13	0.941	41.98	pass	3/7/2013	GMSK	0.912	39.6	PASS	N/A
3180	Head	1800	21-Feb-13	1.37	39.23	pass	3/7/2013	GMSK	1.384	38.24	PASS	N/A
3180	Head	1900	21-Feb-13	1.476	38.79	pass						
3180	Head	2450	25-Feb-13	1.75	36.59	pass	3/14/2013	OFDM	1.807	37.8	N/A	PASS
3180	Head	2600	25-Feb-13	1.897	36.17	pass						
3180	Body	750	21-Feb-13	0.9525	54.36	pass						
3180	Body	835	21-Feb-13	1	55.04	pass	3/7/2013	GMSK	0.996	54.068	PASS	N/A
3180	Body	1800	21-Feb-13	1.445	49.43	pass	3/7/2013	GMSK	1.582	49.18	PASS	N/A
3180	Body	1900	21-Feb-13	1.561	49.05	pass						
3180	Body	2450	25-Feb-13	1.926	49.22	pass	3/12/2013	OFDM	1.999	50.5	N/A	PASS
3180	Body	2600	25-Feb-13	2.097	48.83	pass						

<b>DASY52™ Measurement System 2</b>												
<b>System Validation Measurements</b>												
Probe	Tissue Type	f (MHz)	CW Validations				Modulated Validations					
			Date	Dielectric Parameters		Result	Date	Mod. Type	Dielectric Parameters		Duty Factor Linearity Results	High PAR Linearity Results
				Measured $\sigma$ (S/m)	Measured $\epsilon_r$				Measured $\sigma$ (S/m)	Measured $\epsilon_r$		
3124	Head	750	1/16/2013	0.876	42.29	PASS						
3124	Head	835	1/16/2013	0.895	39.11	PASS	1/14/2013	GMSK	0.914	40.63	PASS	N/A
3124	Head	1800	1/15/2013	1.365	38.34	PASS	1/14/2013	GMSK	1.373	39.61	PASS	N/A
3124	Head	1900	1/15/2013	1.457	38.20	PASS						
3124	Head	2450	1/16/2013	1.812	39.28	PASS	3/12/2013	OFDM	1.795	37.65	N/A	PASS
3124	Head	2600	1/16/2013	1.971	38.77	PASS						
3124	Body	750	1/16/2013	0.967	54.55	PASS						
3124	Body	835	1/15/2013	0.989	53.55	PASS	1/15/2013	GMSK	0.99	53.547	PASS	N/A
3124	Body	1800	1/15/2013	1.448	51.40	PASS	1/14/2013	GMSK	1.45	52.38	PASS	N/A
3124	Body	1900	1/15/2013	1.568	51.03	PASS						
3124	Body	2450	1/16/2013	1.992	50.89	PASS	3/12/2013	OFDM	1.999	50.5	N/A	PASS
3124	Body	2600	1/16/2013	2.179	50.40	PASS						

<b>DASY52™ Measurement System 3</b>												
<b>System Validation Measurements</b>												
Probe	Tissue Type	f (MHz)	CW Validations				Modulated Validations					
			Date	Dielectric Parameters			Date	Mod. Type	Dielectric Parameters		Duty Factor Linearity Results	High PAR Linearity Results
				Measured $\sigma$ (S/m)	Measured $\epsilon_r$	Result			Measured $\sigma$ (S/m)	Measured $\epsilon_r$		
3730	Head	2450	1/16/2013	1.812	39.28	PASS	3/12/2013	OFDM	1.795	37.65	N/A	PASS
3730	Head	2600	1/16/2013	1.972	38.77	PASS						
3730	Head	5200	1/15/2013	4.547	35.00	PASS	3/18/2013	OFDM	4.562	35.362	N/A	PASS
3730	Head	5300	1/15/2013	4.663	34.79	PASS	3/18/2013	OFDM	4.679	35.123	N/A	PASS
3730	Head	5600	1/15/2013	4.981	34.10	PASS	3/18/2013	OFDM	5.014	34.448	N/A	PASS
3730	Head	5800	1/14/2013	5.204	33.67	PASS	3/19/2013	OFDM	5.243	34.016	N/A	PASS
3730	Body	2450	1/16/2013	1.992	50.89	PASS	3/12/2013	OFDM	1.999	50.5	N/A	PASS
3730	Body	2600	1/16/2013	2.179	50.40	PASS						
3730	Body	5200	1/14/2013	5.204	46.23	PASS	3/18/2013	OFDM	5.233	47.237	N/A	PASS
3730	Body	5300	1/14/2013	5.353	46.00	PASS	3/18/2013	OFDM	5.386	46.995	N/A	PASS
3730	Body	5600	1/14/2013	5.766	45.24	PASS	3/18/2013	OFDM	5.815	46.248	N/A	PASS
3730	Body	5800	1/14/2013	6.061	44.77	PASS	3/19/2013	OFDM	6.114	45.753	N/A	PASS

### 3.3 Test System Verifications (System Performance Checks)

System accuracy verifications of the DASY52™ were performed using the measurement equipment listed in Section 3.1. The daily system performance check occurs within the flat section of the SAM phantom.

A SAR measurement was performed to verify the measured SAR was within ±10% from the target SAR indicated in Appendix 6. These frequencies are within ±10% of the compliance test mid-band frequency as required in [1] and [5]. The test was conducted within 24 hours prior to the measurement of the phone. Recommended limits for permittivity and conductivity, specified in [5], are shown in the table below. The obtained results from the system accuracy verification are also displayed in the table below. SAR values are normalized to 1 W forward power delivered to the dipole. It is seen that the system is operating within its specification, as the results are within acceptable tolerance of the reference values. The distributions of SAR compare well with those of the reference measurements (see Appendix 1). For frequencies below 3 GHz, the simulated tissue depth was verified to be 15.0 cm ± 0.5 cm. Z-axis scans showing the SAR penetration are also included in Appendix 1.

<b>DASY52™ Measurement System 1</b>												
<b>System Verification Measurements for Head SAR Measurements</b>												
f (MHz)	Description	Probe	Dipole	Measured SAR (W/kg), 1 gram	Normalized SAR (W/kg), 1 gram	Dielectric Parameters				Ambient Temp (°C)	Tissue Temp (°C)	
						Measured $\sigma$ (S/m)	Deviation $\sigma$ (S/m)	Measured $\epsilon_r$	Deviation $\epsilon_r$			
835	Measured, Aug-1-2013	3180	422TR	1.83	9.15	0.91	-0.6%	40.2	-3.2%	20.3	21.3	
	Recommended Limits	3180	422TR		9.33	0.90	±10%	41.5	±10%	18-25	18-25	
1800	Measured, Aug-2-2013	3180	259TR	7.46	37.30	1.33	-5.0%	38.2	-4.5%	20.5	20.6	
	Recommended Limits	3180	259TR		38.10	1.40	±10%	40.0	±10%	18-25	18-25	

<b>DASY52™ Measurement System 2</b>												
<b>System Verification Measurements for Head SAR Measurements</b>												
f (MHz)	Description	Probe	Dipole	Measured SAR (W/kg), 1 gram	Normalized SAR (W/kg), 1 gram	Dielectric Parameters				Ambient Temp (°C)	Tissue Temp (°C)	
						Measured $\sigma$ (S/m)	Deviation $\sigma$ (S/m)	Measured $\epsilon_r$	Deviation $\epsilon_r$			
835	Measured, Jul-25-2013	3124	436TR	1.98	9.90	0.90	0.0%	39.18	-5.6%	20.1	21.0	
	Recommended Limits	3124	436TR		9.73	0.90	±10%	41.5	±10%	18-25	18-25	
1800	Measured, Jul-26-2013	3124	2d190	7.41	37.05	1.33	-5.0%	38.9	-2.8%	20.2	20.8	
	Recommended Limits	3124	2d190		39.30	1.40	±10%	40.0	±10%	18-25	18-25	

<b>DASY52™ Measurement System 3</b>												
<b>System Verification Measurements for Head SAR Measurements</b>												
f (MHz)	Description	Probe	Dipole	Measured SAR (W/kg), 1 gram	Normalized SAR (W/kg), 1 gram	Dielectric Parameters				Ambient Temp (°C)	Tissue Temp (°C)	
						Measured $\sigma$ (S/m)	Deviation $\sigma$ (S/m)	Measured $\epsilon_r$	Deviation $\epsilon_r$			
2450	Measured, Jul-27-2013	3730	740	5.26	52.60	1.76	-2.2%	36.9	-5.9%	20.4	20.6	
	Recommended Limits	3730	740		52.30	1.80	±10%	39.2	±10%	18-25	18-25	

<b>DASY52™ Measurement System 1</b>											
<b>System Verification Measurements for Body SAR Measurements</b>											
<i>f</i> (MHz)	Description	Probe	Dipole	Measured SAR (W/kg), 1 gram	Normalized SAR (W/kg), 1 gram	Dielectric Parameters				Ambient Temp (°C)	Tissue Temp (°C)
						Measured $\sigma$ (S/m)	Deviation $\sigma$ (S/m)	Measured $\epsilon_r$	Deviation $\epsilon_r$		
<b>835</b>	Measured, Aug-6-2013	3180	422TR	1.92	9.60	1.00	3.1%	54.0	-2.2%	20.5	21.0
	Recommended Limits	3180	422TR		9.77	0.97	±10%	55.2	±10%	18-25	18-25
<b>1800</b>	Measured, Aug-5-2013	3180	259TR	7.31	36.55	1.45	-4.6%	52.4	-1.7%	20.3	19.9
	Recommended Limits	3180	259TR		39.10	1.52	±10%	53.3	±10%	18-25	18-25
	Measured, Aug-7-2013	3180	259TR	7.37	36.85	1.45	-4.6%	52.7	-1.1%	20.3	19.9
	Recommended Limits	3180	259TR		39.10	1.52	±10%	53.3	±10%	18-25	18-25

<b>DASY52™ Measurement System 2</b>											
<b>System Verification Measurements for Body SAR Measurements</b>											
<i>f</i> (MHz)	Description	Probe	Dipole	Measured SAR (W/kg), 1 gram	Normalized SAR (W/kg), 1 gram	Dielectric Parameters				Ambient Temp (°C)	Tissue Temp (°C)
						Measured $\sigma$ (S/m)	Deviation $\sigma$ (S/m)	Measured $\epsilon_r$	Deviation $\epsilon_r$		
<b>835</b>	Measured, Jul-25-2013	3124	436TR	1.96	9.8	1.00	3.1%	53.6	-2.9%	20.2	20.7
	Recommended Limits	3124	436TR		10.10	0.97	±10%	55.2	±10%	18-25	18-25
<b>1800</b>	Measured, Jul-26-2013	3124	2d190	7.73	38.65	1.54	1.3%	50.5	-5.3%	20.3	20.7
	Recommended Limits	3124	2d190		37.80	1.52	±10%	53.3	±10%	18-25	18-25

<b>DASY52™ Measurement System 3</b>											
<b>System Verification Measurements for Body SAR Measurements</b>											
<i>f</i> (MHz)	Description	Probe	Dipole	Measured SAR (W/kg), 1 gram	Normalized SAR (W/kg), 1 gram	Dielectric Parameters				Ambient Temp (°C)	Tissue Temp (°C)
						Measured $\sigma$ (S/m)	Deviation $\sigma$ (S/m)	Measured $\epsilon_r$	Deviation $\epsilon_r$		
<b>2450</b>	Measured, Jul-26-2013	3730	740	5.02	50.20	1.95	0.0%	49.9	-5.3%	20.4	20.8
	Recommended Limits	3730	740		49.50	1.95	±10%	52.7	±10%	18-25	18-25

### 3.4 Simulated Tissue Dielectric Properties

Validation, System Performance Check, and device SAR measurements are performed using the DASY52™ system along with liquids specified to simulate head and body tissues subjected to electromagnetic exposure. The list of ingredients and the percent composition of the tissue-simulating liquids used for testing are indicated in the following table.

Ingredient	782 / 835 / 900 MHz Head	782 / 835 / 900 MHz Body	1800 MHz / 1900 MHz Head	1800 MHz / 1900 MHz Body	2450 MHz Head	2450 MHz Body	5 GHz Head	5 GHz Body
Sugar	57.0	44.9	--	--	--	--	--	--
DGBE	--	--	47.0	30.8	6.89	8.0	--	--
Water	40.45	53.06	52.62	68.8	57.95	71.8	65.52	78.66
Salt	1.45	0.94	0.38	0.4	0.15	0.2	--	--
HEC	1.0	1.0	--	--	--	--	--	--
Bact.	0.1	0.1	--	--	--	--	--	--
Triton X-100	--	--	--	--	35.02	20.0	17.24	10.67
Di(ethylene glycol) Hexyl Ether	--	--	--	--	--	--	17.24	10.67

Prior to conducting SAR measurements, the relative permittivity,  $\epsilon_r$ , and conductivity,  $\sigma$ , of the tissue-simulating liquids were measured with a SPEAG™ DAK-3.5 Dielectric Assessment Kit across the frequency ranges of interest. These values, along with recommended targets, percent deviation from the targets, and the temperature of the simulated tissue are shown in the tables below.

For SAR measurements, the dielectric measurements from the DAK-3.5 are imported into the DASY software which performs interpolation to determine the dielectric parameters at the specific frequencies used for device testing. The DASY software also implements SAR error compensation algorithms to automatically correct the measured SAR results for deviations between the measured and target dielectric parameters. This error compensation has been verified by the lab to meet the requirements in FCC KDB 865664 D01. Therefore, where frequencies of test fall within ±50 MHz of a calibration point of the probe used for test, the acceptable range of tissue variation is ±10% per FCC KDB 865664 D01 section 2.4. For test frequencies outside of ±50 MHz of a probe calibration point, the range of tissue variation is reduced per section 2.6 part 2 of the same KDB, to ensure that tissues used in testing are within the required specification regardless of device performance. A mass density of  $\rho = 1 \text{ g/cm}^3$  was entered into the system for all cases. It can be seen that the measured parameters are within tolerance of the recommended targets specified in [1] and [5].

Head Simulated-Tissue Dielectric Parameters									
Index	Date Measured	f (MHz)	Target $\sigma$ (S/m)	Target $\epsilon_r$	Measured $\sigma$ (S/m)	Deviation $\sigma$ (%)	Measured $\epsilon_r$	Deviation $\epsilon_r$ (%)	Temp (°C)
835	Jul-25-2013	820.0	0.90 ±10%	41.58 ±10%	0.89	-1.0%	39.4	-5.4%	21.0
		835.0	0.90 ±10%	41.50 ±10%	0.90	0.0%	39.2	-5.6%	
		849.0	0.92 ±10%	41.50 ±10%	0.91	-0.6%	39.0	-6.1%	
	Aug-01-2013	820.0	0.90 ±10%	41.58 ±10%	0.90	0.2%	40.4	-2.9%	21.3
		835.0	0.90 ±10%	41.50 ±10%	0.91	1.2%	40.2	-3.2%	
		849.0	0.92 ±10%	41.50 ±10%	0.93	1.7%	40.0	-3.7%	
1750	Jul-26-2013	1709.0	1.35 -5%/+10%	40.13 -10%/+5%	1.31	-2.9%	38.7	-3.6%	20.9
		1730.0	1.36 -5%/+10%	40.10 -10%/+5%	1.33	-2.3%	38.6	-3.8%	
		1755.0	1.37 -5%/+10%	40.06 -10%/+5%	1.36	-1.1%	38.5	-4.0%	
1880	Aug-02-2013	1850.0	1.40 ±10%	40.00 ±10%	1.38	-1.5%	38.0	-5.0%	20.6
		1880.0	1.40 -5%/+10%	40.00 -10%/+5%	1.42	1.5%	37.9	-5.3%	
		1915.0	1.40 -5%/+10%	40.00 -10%/+5%	1.45	3.6%	37.7	-5.7%	
	Jul-26-2013	1850.0	1.40 ±10%	40.00 ±10%	1.38	-1.5%	38.7	-3.4%	20.8
		1880.0	1.40 -5%/+10%	40.00 -10%/+5%	1.42	1.5%	38.6	-3.7%	
		1915.0	1.40 -5%/+10%	40.00 -10%/+5%	1.45	3.6%	38.4	-4.1%	
2450	Jul-27-2013	2412.0	1.77 ±10%	39.27 ±10%	1.72	-2.7%	36.9	-6.0%	20.6
		2450.0	1.80 ±10%	39.20 ±10%	1.76	-2.3%	36.9	-6.0%	
		2462.0	1.81 ±10%	39.18 ±10%	1.77	-2.4%	36.8	-6.1%	

Body Simulated-Tissue Dielectric Parameters									
Index	Date Measured	f (MHz)	Target $\sigma$ (S/m)	Target $\epsilon_r$	Measured $\sigma$ (S/m)	Deviation $\sigma$ (%)	Measured $\epsilon_r$	Deviation $\epsilon_r$ (%)	Temp (°C)
835	Aug-6-2013	820.0	0.97 ±10%	55.26 ±10%	0.98	1.2%	54.2	-1.9%	21.0
		835.0	0.97 ±10%	55.20 ±10%	1.00	3.1%	54.0	-2.2%	
		849.0	0.99 ±10%	55.16 ±10%	1.01	2.4%	53.9	-2.3%	
	Jul-25-2013	820.0	0.97 ±10%	55.26 ±10%	0.98	1.2%	53.7	-2.9%	20.7
		835.0	0.97 ±10%	55.20 ±10%	1.00	3.1%	53.6	-3.0%	
		849.0	0.99 ±10%	55.16 ±10%	1.01	2.4%	53.4	-3.2%	
1750	Jul-26-2013	1709.0	1.35 -5%/+10%	40.13 -10%/+5%	1.45	-1.1%	50.8	-5.2%	20.8
		1730.0	1.36 -5%/+10%	40.10 -10%/+5%	1.47	-0.7%	50.7	-5.2%	
		1755.0	1.37 -5%/+10%	40.06 -10%/+5%	1.49	-0.3%	50.6	-5.2%	
1880	Aug-7-2013	1850.0	1.52 ±10%	53.30 ±10%	1.51	-0.7%	52.1	-2.3%	20.6
		1880.0	1.52 -5%/+10%	53.30 -10%/+5%	1.55	2.0%	52.0	-2.5%	
		1915.0	1.52 -5%/+10%	53.30 -10%/+5%	1.59	4.7%	51.9	-2.8%	
	Jul-26-2013	1850.0	1.52 ±10%	53.30 ±10%	1.50	-1.4%	52.7	-1.3%	20.7
		1880.0	1.52 -5%/+10%	53.30 -10%/+5%	1.54	1.4%	52.6	-1.4%	
		1915.0	1.52 -5%/+10%	53.30 -10%/+5%	1.58	4.0%	52.5	-1.6%	
2450	Jul-26-2013	2412.0	1.91 ±10%	52.75 ±10%	1.91	-0.3%	50.0	-5.3%	20.8
		2450.0	1.95 ±10%	52.70 ±10%	1.96	0.6%	49.9	-5.4%	
		2462.0	1.97 ±10%	52.68 ±10%	1.97	0.2%	49.9	-5.4%	

## 4 Test Setup Information, SAR Measurement Results, and Analysis

### 4.1 Overview of Test Setup and Results

The phone was tested in the exposure configurations stipulated in [1], [5], [9], and per FCC KDB 941225 D06 for mobile hotspot operation. The phone was positioned into these configurations using the device holder supplied with the DASY52™ SAR measurement system. The default settings for the SAR scans are set in accordance with FCC KDB 865664 D01 for all area scan resolutions, zoom scan resolutions and volumes, and probe positioning. Please refer to the DASY52™ manual for additional information on SAR scanning procedures and algorithms used.

The SAR measurements were performed using the SAM and Flat phantoms listed in section 3.1. The same phantoms and simulated tissues were used for the system performance checks and the device SAR measurements. Consequently the Z-axis scans included in Appendix 1 are applicable for verification of the required simulated tissue depths of 15.0 cm ± 0.5 cm for frequencies less than 3 GHz, or 10.0 cm ± 0.5 cm for frequencies greater than 3 GHz.

The SAR results shown in following tables are maximum SAR values averaged over 1 gram of phantom tissue, to demonstrate compliance to [3] and also over 10 grams of phantom tissue, to demonstrate compliance to [6]. Also shown are the maximum device power, measured device power, temperature of the simulated tissue after the test, the measured drift and the scaled SAR. The exact method of scaling is:

$$\text{Scaled SAR} = (\text{Measured SAR}) * 10^{\left(\frac{(\text{Maximum Power}) - (\text{Measured Power})}{10}\right)} * 10^{\left(\frac{(-\text{Drift})}{10}\right)}$$

The SAR reported at the end of the measurement process by the DASY52™ measurement system can be scaled up by the measured drift to determine the SAR at the beginning of the measurement process. This is the most conservative SAR because it corresponds to the average output power at the beginning of the SAR test. This extrapolation has been done because when the DUT is operating properly it may exhibit a slump in radiated power and SAR over time. This is verified by measuring the SAR drift after the test. Note that measured SAR is scaled only in the manner which results in a more conservative scaled value, i.e. to a higher SAR value as a consequence of measured power being below the maximum allowed power, or for negative drift values.

Per FCC KDB 447498 D01, area-scan based 1 g SAR estimation was used for initial testing in all combinations of device modes and exposure conditions. The highest SAR measurements for each combination of device mode and exposure condition, and all conditions where the area scan estimation reported values greater than 1.2 W/kg, were further evaluated with a zoom scan. When operating conditions for the SAR system verifications did not demonstrate that the verification area scan 1 g SAR estimation resulted in values within 3% of zoom scan 1 g SAR, zoom scans were executed for all SAR tests.

The test conditions that produced the highest SAR values for each combination of DUT mode and exposure condition are indicated as **bold** numbers in the following tables. Plots of these tests are included in Appendices 2 through 4.

### 4.2 Head-Adjacent Exposure Results

Left Cheek-Touch Position												
Mode	Battery/Accessory	Channel	f (MHz)	DUT Power		Temp (°C)	Drift (dB)	10 g SAR value		1 g SAR value		Plot Page
				Maximum (dBm)	Measured (dBm)			Measured (W/kg)	Corrected (W/kg)	Measured (W/kg)	Corrected (W/kg)	
GSM 850, CS Voice	SNN5932A	190	836.6	33.50	32.67	21.2	0.0	0.287	0.35	0.383	0.46	
GSM 1900, CS Voice	SNN5932A	661	1880.0	30.50	29.76	20.6	0.03	0.219	0.26	0.369	0.44	
GPRS 1900 Class 10	SNN5932A	<b>661</b>	<b>1880.0</b>	<b>29.50</b>	<b>28.64</b>	<b>20.2</b>	<b>-0.01</b>	<b>0.288</b>	<b>0.35</b>	<b>0.488</b>	<b>0.60</b>	<b>A17</b>
WCDMA 850, RMC	SNN5932A	4180	836.0	24.00	22.89	20.5	0.09	0.264	0.34	0.353	0.46	
WCDMA 1700, RMC	SNN5932A	1513	1752.6	24.00	22.72	20.5	-0.13	0.103	0.13	0.164	0.21	
WCDMA 1900, RMC	SNN5932A	9400	1800.0	24.00	22.90	20.1	-0.03	0.44	0.57	0.745	0.97	
WCDMA 1900, RMC	SNN5932A	9262	1852.4	24.00	23.07	20.1	0.06	0.346	0.43	0.58	0.72	
WCDMA 1900, RMC	SNN5932A	<b>9538</b>	<b>1907.6</b>	<b>24.00</b>	<b>22.85</b>	<b>20.1</b>	<b>0.00</b>	<b>0.525</b>	<b>0.68</b>	<b>0.898</b>	<b>1.17</b>	<b>A20</b>
802.11b, 1 Mbps	SNN5932A	6	2412	19.00	18.91	20.6	0.02	0.141	0.14	0.292	0.30	

Table 4-1: SAR measurement results in a head-adjacent position against the ICNIRP and ANSI SAR Limit.

Right Cheek-Touch Position												
Mode	Battery/Accessory	Channel	f (MHz)	DUT Power		Temp (°C)	Drift (dB)	10 g SAR value		1 g SAR value		Plot Page
				Maximum (dBm)	Measured (dBm)			Measured (W/kg)	Corrected (W/kg)	Measured (W/kg)	Corrected (W/kg)	
GSM 850, CS Voice	SNN5932A	<b>190</b>	<b>836.6</b>	<b>33.50</b>	<b>32.67</b>	<b>20.4</b>	<b>-0.01</b>	<b>0.305</b>	<b>0.37</b>	<b>0.404</b>	<b>0.49</b>	<b>A16</b>
GPRS 850 Class 10	SNN5932A	190	836.6	32.50	31.51	21.0	-0.12	0.256	0.33	0.341	0.44	
GSM 1900, CS Voice	SNN5932A	661	1880.0	30.50	29.76	20.5	-0.02	0.103	0.12	0.17	0.20	
WCDMA 850, RMC	SNN5932A	<b>4180</b>	<b>836.0</b>	<b>24.00</b>	<b>22.89</b>	<b>20.5</b>	<b>-0.11</b>	<b>0.294</b>	<b>0.39</b>	<b>0.392</b>	<b>0.52</b>	<b>A18</b>
WCDMA 1700, RMC	SNN5932A	<b>1513</b>	<b>1752.6</b>	<b>24.00</b>	<b>22.72</b>	<b>20.5</b>	<b>0.14</b>	<b>0.118</b>	<b>0.15</b>	<b>0.187</b>	<b>0.24</b>	<b>A19</b>
WCDMA 1900, RMC	SNN5932A	9400	1800.0	24.00	22.90	20.0	-0.03	0.208	0.27	0.338	0.44	
802.11b, 1 Mbps	SNN5932A	6	2412	19.00	18.91	20.6	-0.02	0.198	0.20	0.414	0.42	

Table 4-2: SAR measurement results in a head-adjacent position against the ICNIRP and ANSI SAR Limit.

Left 15° Tilt Position												
Mode	Battery/Accessory	Channel	f (MHz)	DUT Power		Temp (°C)	Drift (dB)	10 g SAR value		1 g SAR value		Plot Page
				Maximum (dBm)	Measured (dBm)			Measured (W/kg)	Corrected (W/kg)	Measured (W/kg)	Corrected (W/kg)	
GSM 850, CS Voice	SNN5932A	190	836.6	33.50	32.67	20.3	0.03	0.207	0.25	0.271	0.33	
GSM 1900, CS Voice	SNN5932A	661	1880.0	30.50	29.76	20.5	0.17	0.072	0.09	0.127	0.15	
WCDMA 850, RMC	SNN5932A	4180	836.0	24.00	22.89	20.5	0.02	0.201	0.26	0.263	0.34	
WCDMA 1700, RMC	SNN5932A	1513	1752.6	24.00	22.72	20.5	0.08	0.0778	0.10	0.129	0.16	
WCDMA 1900, RMC	SNN5932A	9400	1800.0	24.00	22.90	20.0	0.02	0.147	0.19	0.254	0.33	
802.11b, 1 Mbps	SNN5932A	6	2412	19.00	18.91	20.6	-0.05	0.178	0.18	0.369	0.38	

Table 4-3: SAR measurement results in a head-adjacent position against the ICNIRP and ANSI SAR Limit.

Right 15° Tilt Position												
Mode	Battery/Accessory	Channel	f (MHz)	DUT Power		Temp (°C)	Drift (dB)	10 g SAR value		1 g SAR value		Plot Page
				Maximum (dBm)	Measured (dBm)			Measured (W/kg)	Corrected (W/kg)	Measured (W/kg)	Corrected (W/kg)	
GSM 850, CS Voice	SNN5932A	190	836.6	33.50	32.67	20.5	0.04	0.217	0.26	0.285	0.35	
GSM 1900, CS Voice	SNN5932A	661	1880.0	30.50	29.76	20.4	-0.02	0.0668	0.08	0.113	0.13	
WCDMA 850, RMC	SNN5932A	4180	836.0	24.00	22.89	20.5	0.07	0.168	0.22	0.219	0.28	
WCDMA 1700, RMC	SNN5932A	1513	1752.6	24.00	22.72	20.5	0.02	0.0759	0.10	0.131	0.17	
WCDMA 1900, RMC	SNN5932A	9400	1800.0	24.00	22.90	20.0	-0.09	0.127	0.17	0.213	0.28	
802.11b, 1 Mbps	SNN5932A	<b>6</b>	<b>2412</b>	<b>19.00</b>	<b>18.91</b>	<b>20.6</b>	<b>0.01</b>	<b>0.227</b>	<b>0.23</b>	<b>0.504</b>	<b>0.51</b>	<b>A21</b>

Table 4-4: SAR measurement results in a head-adjacent position against the ICNIRP and ANSI SAR Limit.

### 4.3 Body-Worn Accessory Exposure Results

Body-Worn Accessory Position, Front of Phone 15 mm from Phantom												
Mode	Battery/ Accessory	Channel	f (MHz)	DUT Power		Temp (°C)	Drift (dB)	10 g SAR value		1 g SAR value		Plot Page
				Maximum (dBm)	Measured (dBm)			Measured (W/kg)	Corrected (W/kg)	Measured (W/kg)	Corrected (W/kg)	
GSM 850, CS Voice	SNN5932A	190	836.6	33.50	32.67	20.5	-0.01	0.414	0.50	0.451	0.66	
GPRS 850 Class 10	SNN5932A	<b>190</b>	<b>836.6</b>	<b>32.50</b>	<b>31.51</b>	<b>20.5</b>	<b>-0.13</b>	<b>0.478</b>	<b>0.62</b>	<b>0.641</b>	<b>0.83</b>	<b>A23</b>
GSM 1900, CS Voice	SNN5932A	661	1880.0	30.50	29.76	20.5	-0.04	0.173	0.21	0.306	0.37	
WCDMA 850, RMC	SNN5932A	4180	836.0	24.00	22.89	20.4	-0.11	0.407	0.54	0.534	0.71	
WCDMA 1700, RMC	SNN5932A	1513	1752.6	24.00	22.72	20.5	-0.03	0.182	0.23	0.318	0.41	
WCDMA 1900, RMC	SNN5932A	9400	1800.0	24.00	22.90	20.2	-0.05	0.285	0.37	0.491	0.64	
802.11b, 1 Mbps	SNN5932A	6	2412	19.00	18.91	19.7	0.00	0.0392	0.04	0.0703	0.07	

Table 4-5: SAR measurement results in a body-adjacent position against the ICNIRP and ANSI SAR Limit.

Body-Worn Accessory Position, Back of Phone 15 mm from Phantom												
Mode	Battery/ Accessory	Channel	f (MHz)	DUT Power		Temp (°C)	Drift (dB)	10 g SAR value		1 g SAR value		Plot Page
				Maximum (dBm)	Measured (dBm)			Measured (W/kg)	Corrected (W/kg)	Measured (W/kg)	Corrected (W/kg)	
GSM 850, CS Voice	SNN5932A	190	836.6	33.50	32.67	20.5	-0.09	0.336	0.42	0.446	0.55	
GSM 1900, CS Voice	SNN5932A	661	1880.0	30.50	29.76	20.5	-0.15	0.322	0.40	0.573	0.50	
GPRS 1900 Class 10	SNN5932A	<b>661</b>	<b>1880.0</b>	<b>29.50</b>	<b>28.64</b>	<b>20.5</b>	<b>-0.15</b>	<b>0.409</b>	<b>0.52</b>	<b>0.711</b>	<b>0.90</b>	<b>A24</b>
WCDMA 850, RMC	SNN5932A	4180	836.0	24.00	22.89	20.4	-0.12	0.528	0.70	0.702	0.93	
WCDMA 850, RMC	SNN5932A	4132	826.4	24.00	22.85	20.4	-0.09	0.415	0.55	0.55	0.73	
WCDMA 850, RMC	SNN5932A	<b>4233</b>	<b>846.6</b>	<b>24.00</b>	<b>22.78</b>	<b>20.4</b>	<b>-0.04</b>	<b>0.53</b>	<b>0.71</b>	<b>0.708</b>	<b>0.95</b>	<b>A25</b>
WCDMA 1700, RMC	SNN5932A	<b>1513</b>	<b>1752.6</b>	<b>24.00</b>	<b>22.72</b>	<b>20.5</b>	<b>-0.07</b>	<b>0.29</b>	<b>0.37</b>	<b>0.503</b>	<b>0.65</b>	<b>A26</b>
WCDMA 1900, RMC	SNN5932A	9400	1800.0	24.00	22.90	20.2	-0.07	0.455	0.60	0.794	1.04	
WCDMA 1900, RMC	SNN5932A	9262	1852.4	24.00	23.07	20.2	-0.03	0.432	0.54	0.749	0.93	
WCDMA 1900, RMC	SNN5932A	<b>9538</b>	<b>1907.6</b>	<b>24.00</b>	<b>22.85</b>	<b>20.2</b>	<b>-0.05</b>	<b>0.461</b>	<b>0.61</b>	<b>0.806</b>	<b>1.06</b>	<b>A27</b>
802.11b, 1 Mbps	SNN5932A	6	2412	19.00	18.91	19.7	0.09	0.064	0.07	0.115	0.12	A28

Table 4-6: SAR measurement results in a body-adjacent position against the ICNIRP and ANSI SAR Limit.

### 4.4 Mobile Hotspot Exposure Results

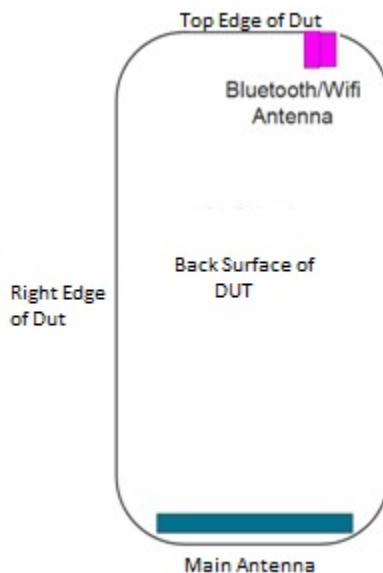

Mobile Hotspot Surfaces/Edges for SAR testing						
Mode	Front	Back	Left	Right	Top	Bottom
GSM	Yes	Yes	Yes	Yes	No	Yes
WCDMA	Yes	Yes	Yes	Yes	No	Yes
Wi-Fi	Yes	Yes	Yes	No	Yes	No

Mobile Hotspot Position, Front of Phone 10 mm from Phantom												
Mode	Battery/Accessory	Channel	f (MHz)	DUT Power		Temp (°C)	Drift (dB)	10 g SAR value		1 g SAR value		Plot Page
				Maximum (dBm)	Measured (dBm)			Measured (W/kg)	Corrected (W/kg)	Measured (W/kg)	Corrected (W/kg)	
GPRS 850 Class 10	SNN5932A	190	836.6	27.5	See Supplemental	20.5	-0.02	0.232	0.23	0.297	0.30	
GPRS 1900 Class 10	SNN5932A	661	1880.0	24.0	See Supplemental	20.3	-0.14	0.253	0.26	0.483	0.50	
WCDMA 850, RMC	SNN5932A	4180	836.0	22.0	See Supplemental	20.2	-0.15	0.233	0.31	0.302	0.40	
WCDMA 1700, RMC	SNN5932A	1513	1752.6	22.0	See Supplemental	20.6	-0.05	0.274	0.35	0.522	0.67	
WCDMA 1900, RMC	SNN5932A	9400	1800.0	19.0	See Supplemental	20.3	-0.05	0.148	0.19	0.274	0.36	
802.11b, 1 Mbps	SNN5932A	6	2412	19.0	18.91	19.7	-0.06	0.0639	0.07	0.12	0.12	

Table 4-7: SAR measurement results in a body-adjacent position against the ICNIRP and ANSI SAR Limit.

Body-Worn Accessory Position, Back of Phone 10 mm from Phantom												
Mode	Battery/Accessory	Channel	f (MHz)	DUT Power		Temp (°C)	Drift (dB)	10 g SAR value		1 g SAR value		Plot Page
				Maximum (dBm)	Measured (dBm)			Measured (W/kg)	Corrected (W/kg)	Measured (W/kg)	Corrected (W/kg)	
GPRS 850 Class 10	SNN5932A	190	836.6	27.5	See Supplemental	20.5	-0.05	0.329	0.33	0.434	0.44	A30
GPRS 1900 Class 10	SNN5932A	661	1880.0	24.0	See Supplemental	20.3	-0.20	0.359	0.38	0.678	0.71	
WCDMA 850, RMC	SNN5932A	4180	836.0	22.0	See Supplemental	20.2	-0.02	0.337	0.44	0.445	0.58	A32
WCDMA 1700, RMC	SNN5932A	1513	1752.6	22.0	See Supplemental	20.6	0.00	0.401	0.51	0.763	0.97	
WCDMA 1700, RMC	SNN5932A	1312	1712.4	22.0	See Supplemental	20.6	-0.03	0.247	0.32	0.456	0.60	
WCDMA 1700, RMC	SNN5932A	1413	1732.5	22.0	See Supplemental	20.6	-0.11	0.322	0.44	0.60	0.83	
WCDMA 1900, RMC	SNN5932A	9400	1800.0	19.0	See Supplemental	20.3	-0.06	0.233	0.30	0.438	0.57	
802.11b, 1 Mbps	SNN5932A	6	2412	19.0	18.91	19.8	0.13	0.124	0.13	0.242	0.25	A35

Table 4-8: SAR measurement results in a body-adjacent position against the ICNIRP and ANSI SAR Limit.

Mobile Hotspot Position, Left Edge of Phone 10 mm from Phantom												
Mode	Battery/ Accessory	Channel	f (MHz)	DUT Power		Temp (°C)	Drift (dB)	10 g SAR value		1 g SAR value		Plot Page
				Maximum (dBm)	Measured (dBm)			Measured (W/kg)	Corrected (W/kg)	Measured (W/kg)	Corrected (W/kg)	
GPRS 850 Class 10	SNN5932A	190	836.6	27.5	See Supplemental	20.5	0.03	0.186	0.19	0.270	0.27	
GPRS 1900 Class 10	SNN5932A	661	1880.0	24.0	See Supplemental	20.3	0.01	0.0841	0.08	0.142	0.14	
WCDMA 850, RMC	SNN5932A	4180	836.0	22.0	See Supplemental	20.2	0.01	0.214	0.28	0.309	0.40	
WCDMA 1700, RMC	SNN5932A	1513	1752.6	22.0	See Supplemental	20.6	-0.01	0.0351	0.04	0.0585	0.07	
WCDMA 1900, RMC	SNN5932A	9400	1800.0	19.0	See Supplemental	20.3	0.04	0.058	0.07	0.0969	0.12	
802.11b, 1 Mbps	SNN5932A	6	2412	19.0	18.91	19.7	-0.01	0.0435	0.04	0.0771	0.08	

Table 4-9: SAR measurement results in a body-adjacent position against the ICNIRP and ANSI SAR Limit.

Body-Worn Accessory Position, Right Edge of Phone 10 mm from Phantom												
Mode	Battery/ Accessory	Channel	f (MHz)	DUT Power		Temp (°C)	Drift (dB)	10 g SAR value		1 g SAR value		Plot Page
				Maximum (dBm)	Measured (dBm)			Measured (W/kg)	Corrected (W/kg)	Measured (W/kg)	Corrected (W/kg)	
GPRS 850 Class 10	SNN5932A	190	836.6	27.5	See Supplemental	20.7	0.02	0.20	0.20	0.291	0.29	
GPRS 1900 Class 10	SNN5932A	661	1880.0	24.0	See Supplemental	20.3	-0.03	0.0211	0.02	0.0361	0.04	
WCDMA 850, RMC	SNN5932A	4180	836.0	22.0	See Supplemental	20.2	0.10	0.221	0.29	0.318	0.41	
WCDMA 1700, RMC	SNN5932A	1513	1752.6	22.0	See Supplemental	20.6	0.03	0.0476	0.06	0.0788	0.10	
WCDMA 1900, RMC	SNN5932A	9400	1800.0	19.0	See Supplemental	20.3	0.0	0.00929	0.01	0.0166	0.02	

Table 4-10: SAR measurement results in a body-adjacent position against the ICNIRP and ANSI SAR Limit.

Mobile Hotspot Position, Top Edge of Phone 10 mm from Phantom												
Mode	Battery/ Accessory	Channel	f (MHz)	DUT Power		Temp (°C)	Drift (dB)	10 g SAR value		1 g SAR value		Plot Page
				Maximum (dBm)	Measured (dBm)			Measured (W/kg)	Corrected (W/kg)	Measured (W/kg)	Corrected (W/kg)	
802.11b, 1 Mbps	SNN5932A	6	2412	19.0	18.91	19.8	-0.03	0.0944	0.10	0.184	0.19	

Table 4-11: SAR measurement results in a body-adjacent position against the ICNIRP and ANSI SAR Limit.

Body-Worn Accessory Position, Bottom Edge of Phone 10 mm from Phantom												
Mode	Battery/ Accessory	Channel	f (MHz)	DUT Power		Temp (°C)	Drift (dB)	10 g SAR value		1 g SAR value		Plot Page
				Maximum (dBm)	Measured (dBm)			Measured (W/kg)	Corrected (W/kg)	Measured (W/kg)	Corrected (W/kg)	
GPRS 850 Class 10	SNN5932A	190	836.6	27.5	See Supplemental	20.6	-0.08	0.0148	0.01	0.0241	0.02	
GPRS 1900 Class 10	SNN5932A	<b>661</b>	<b>1880.0</b>	<b>24.0</b>	See Supplemental	<b>20.2</b>	<b>-0.08</b>	<b>0.655</b>	<b>0.67</b>	<b>1.29</b>	<b>1.31</b>	<b>A31</b>
GPRS 1900 Class 10	SNN5932A	512	1850.2	21.0	See Supplemental	20.2	-0.12	0.628	0.65	1.23	1.26	
GPRS 1900 Class 10	SNN5932A	810	1909.8	21.0	See Supplemental	20.2	-0.11	0.586	0.60	1.17	1.20	
WCDMA 850, RMC	SNN5932A	4180	836.0	22.0	See Supplemental	20.2	0.06	0.0166	0.02	0.0294	0.04	
WCDMA 1700, RMC	SNN5932A	<b>1513</b>	<b>1752.6</b>	<b>22.0</b>	See Supplemental	<b>20.6</b>	<b>-0.03</b>	<b>0.564</b>	<b>0.72</b>	<b>1.11</b>	<b>1.42</b>	<b>A33</b>
WCDMA 1700, RMC	SNN5932A	1312	1712.4	22.0	See Supplemental	20.6	0.10	0.396	0.52	0.776	1.01	
WCDMA 1700, RMC	SNN5932A	1413	1732.5	22.0	See Supplemental	20.6	-0.02	0.53	0.71	1.05	1.42	
WCDMA 1900, RMC	SNN5932A	9400	1800.0	19.0	See Supplemental	20.3	-0.1	0.406	0.54	0.791	1.04	
WCDMA 1900, RMC	SNN5932A	9262	1852.4	19.0	See Supplemental	20.3	-0.12	0.417	0.53	0.808	1.03	
WCDMA 1900, RMC	SNN5932A	<b>9538</b>	<b>1907.6</b>	19.0	See Supplemental	<b>20.3</b>	<b>-0.02</b>	<b>0.413</b>	<b>0.54</b>	<b>0.814</b>	<b>1.07</b>	<b>A34</b>

Table 4-12: SAR measurement results in a body-adjacent position against the ICNIRP and ANSI SAR Limit.

## 4.5 Measurement Variability Analysis

Per FCC KDB 865664 D01, SAR measurement variability was assessed for each frequency band as determined by the SAR probe calibration points and tissue-equivalent mediums used for the device measurements. These additional measurements are executed after the completion of all measurements requiring the same head or body tissue-equivalent medium in a frequency band. The phone was returned to ambient conditions (normal room temperature) with the battery fully charged before it was re-mounted on the device holder for these measurements, to minimize any unexpected variations in the repeated results.

SAR measurement variability was assessed using the following procedures for each frequency band:

1. If the original highest measured SAR is  $< 0.8 \text{ W/kg}$ , the following steps do not apply and no repeat measurements were executed.
2. If the original highest measured SAR is  $\geq 0.8 \text{ W/kg}$ , that measurement was repeated once.
3. If the ratio of the largest to smallest SAR for the original and first repeated measurement was  $> 1.2$ , or if the original or first repeated measurement was  $\geq 1.45 \text{ W/kg}$ , the measurement was repeated a second time.
4. If the ratio of the largest to smallest SAR for the original, first repeated, or second repeated measurement was  $> 1.2$ , and one of those measurements was  $\geq 1.5 \text{ W/kg}$ , the measurement was repeated a third time.

SAR Measurement Variability Results										
Mode	Exposure Condition	Channel	$f$ (MHz)	Original Measured SAR (W/kg)	1st Repeated SAR (W/kg)	Ratio	2nd Repeated SAR (W/kg)	Ratio	3rd Repeated SAR (W/kg)	Ratio
GSM 1900	Body-Worn Accessory Position, Bottom Edge of Phone 10 mm from Phantom	661	1880.0	1.29	1.14	1.13	N/A	N/A	N/A	N/A
WCDMA 1700	Body-Worn Accessory Position, Bottom Edge of Phone 10 mm from Phantom	1513	1752.6	1.11	1.11	1.00	N/A	N/A	N/A	N/A
WCDMA 1900	Left Cheek-Touch Position	9538	1907.6	0.898	0.838	1.07	N/A	N/A	N/A	N/A

**Table 4-13: SAR measurement results for Variability Analysis**

### 4.6 Description and Evaluation of Simultaneous Transmitters

Per FCC KDB 447498 D01, the necessity of simultaneous SAR testing was evaluated for the licensed and unlicensed transmitters of the phone under test.

By design some or all of the transmitters built into the phone may operate simultaneously, as described in the tables on the following pages. A simplified model of the transmit paths and a diagram of the separation distances between the transmitting antennas are provided below.

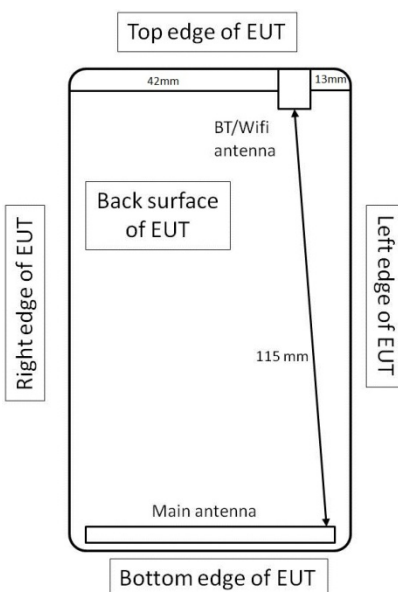
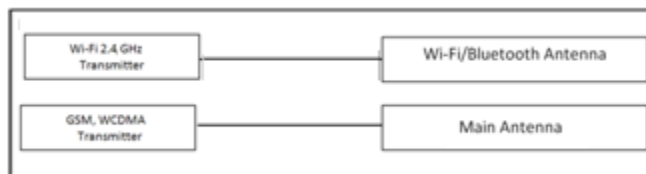

When standalone SAR test exclusion applies to a mode and antenna that transmits simultaneously with other modes and antennas, the KDB directs that the standalone SAR of that mode must be estimated for evaluation in the SAR summations.

For simultaneous SAR evaluation, Bluetooth SAR was estimated and included in all applicable SAR summations. For Body-Worn Accessory simultaneous SAR evaluation, the value used for inclusion in these summations was found to be:

$$\frac{[13]_{(mW)}}{[15]_{(mm)}} \times \frac{\sqrt{2.41_{(GHz)}}}{7.5} = 0.2 W/kg_{(estimated)}$$

For Mobile Hotspot simultaneous SAR evaluation, the value used for inclusion in these summations was found to be:

$$\frac{[13]_{(mW)}}{[10]_{(mm)}} \times \frac{\sqrt{2.41_{(GHz)}}}{7.5} = 0.3 W/kg_{(estimated)}$$

Note Bluetooth and Wi-Fi share the same transmit path, and cannot transmit simultaneously.

A description of the power conditions or reduced limits for simultaneous transmit modes is provided in section 2.5 and in expanded detail in Exhibit 12. The notation used in the “Exposure Condition” tables is as follows for the *PWR* column:

- *N/A* indicates the transmitter in this case has no reduced power limit enforced and may operate up to its maximum power, and no conditions are contingent on this transmitter’s operation.
- *Values other than “N/A”* indicate an enforced power limit, at the value stated in dBm, on the noted transmitter for this simultaneous transmit case.

Per FCC KDB 447498 D01 section 4.3.2, when the sum of the 1 g SAR values of all simultaneously transmitting antennas and device modes in an exposure condition is within the SAR limit, that simultaneous transmission configuration may be excluded from SAR measurements. Simultaneous SAR summations for the head-adjacent, dispatch/push-to-talk, body-worn accessory, and mobile hotspot exposure conditions with the worst-case SAR transmitter configurations are presented in the following tables.

Head Exposure Conditions; Simultaneous Transmit Configurations, including Power					
Case	Transmitter #1		Transmitter #2		Notes
	Transmitter Configuration	PWR	Transmitter Configuration	PWR	
H1	GSM 850 CS Voice	N/A	Wi-Fi 2.4 GHz	N/A	Voice + Background Data
H2	GSM 1900 CS Voice	N/A	Wi-Fi 2.4 GHz	N/A	Voice + Background Data
H3	WCDMA 850	N/A	Wi-Fi 2.4 GHz	N/A	Voice + Background Data
H4	WCDMA 850	N/A	Wi-Fi 2.4 GHz	N/A	Voice + Background Data
H5	WCDMA 1900	N/A	Wi-Fi 2.4 GHz	N/A	Voice + Background Data
H6	GPRS 850	N/A	Wi-Fi 2.4 GHz	N/A	VoIP + Mobile Hotspot
H7	GPRS 1900	N/A	Wi-Fi 2.4 GHz	N/A	VoIP + Mobile Hotspot

		Transmitter Stand-Alone 1 g SAR Values (W/kg)			1 g SAR Summations (W/kg)	
		GSM 850	GSM 1900	Wi-Fi 2.4 GHz	Case H1	Case H2
Band		GSM 850	GSM 1900	Wi-Fi 2.4 GHz	GSM 850 + Wi-Fi 2.4 GHz	GSM 1900 + Wi-Fi 2.4 GHz
Power Condition or Reduced Limit		N/A	N/A	N/A		
Position	Left Head Cheek	0.46	0.44	0.30	0.76	0.74
	Left Head 15° Tilt	0.33	0.15	0.38	0.71	0.53
	Right Head Cheek	0.49	0.20	0.42	0.91	0.62
	Right Head 15° Tilt	0.35	0.13	0.51	0.86	0.64

Table 4-14: SAR summations for simultaneous evaluation – GSM in Head Positions

		Transmitter Stand-Alone 1 g SAR Values (W/kg)				1 g SAR Summations (W/kg)		
		WCDMA 850	WCDMA 1700	WCDMA 1900	Wi-Fi 2.4 GHz	Case H3	Case H4	Case H5
Band		WCDMA 850	WCDMA 1700	WCDMA 1900	Wi-Fi 2.4 GHz	WCDMA 850 + Wi-Fi 2.4 GHz	WCDMA 1700 + Wi-Fi 2.4 GHz	WCDMA 1900 + Wi-Fi 2.4 GHz
Power Condition or Reduced Limit		N/A	N/A	N/A	N/A			
Position	Left Head Cheek	0.46	0.21	1.17	0.30	0.76	0.51	1.47
	Left Head 15° Tilt	0.34	0.16	0.33	0.38	0.72	0.54	0.71
	Right Head Cheek	0.52	0.24	0.44	0.42	0.94	0.66	0.86
	Right Head 15° Tilt	0.28	0.17	0.28	0.51	0.79	0.68	0.79

Table 4-15: SAR summations for simultaneous evaluation – WCDMA in Head Positions

		Transmitter Stand-Alone 1 g SAR Values (W/kg)			1 g SAR Summations (W/kg)	
		GPRS 850	GPRS 1900	Wi-Fi 2.4 GHz	Case H6	Case H7
Band		GPRS 850	GPRS 1900	Wi-Fi 2.4 GHz	GPRS 850 + Wi-Fi 2.4 GHz	GPRS 1900 + Wi-Fi 2.4 GHz
Power Condition or Reduced Limit		N/A	N/A	N/A		
Position	Left Head Cheek	N/A	0.58	0.30		0.88
	Left Head 15° Tilt	N/A	N/A	0.38		
	Right Head Cheek	0.44	N/A	0.42	0.86	
	Right Head 15° Tilt	N/A	N/A	0.51	N/A	N/A

Table 4-16: SAR summations for simultaneous evaluation – GSM in Head Positions for VoIP and MHS

Body-Worn Accessory Exposure Conditions; Simultaneous Transmit Configurations, including Power Conditions					
Case	Transmitter #1		Transmitter #2		Notes
	Transmitter Configuration	PWR	Transmitter Configuration	PWR	
B1	GSM 850 CS Voice	N/A	Wi-Fi 2.4 GHz	N/A	Voice + Background Data
B2	GSM 1900 CS Voice	N/A	Wi-Fi 2.4 GHz	N/A	Voice + Background Data
B3	WCDMA 850	N/A	Wi-Fi 2.4 GHz	N/A	Voice + Background Data
B4	WCDMA 1700	N/A	Wi-Fi 2.4 GHz	N/A	Voice + Background Data
B5	WCDMA 1900	N/A	Wi-Fi 2.4 GHz	N/A	Voice + Background Data
B6	GSM 850 CS Voice	N/A	Bluetooth	N/A	Voice + Wireless Headset
B7	GPRS 850	N/A	Bluetooth	N/A	VoIP + Wireless Headset
B8	GSM 1900 CS Voice	N/A	Bluetooth	N/A	Voice + Wireless Headset
B9	GPRS 1900	N/A	Bluetooth	N/A	VoIP + Wireless Headset
B10	WCDMA 850	N/A	Bluetooth	N/A	Voice + Wireless Headset
B11	WCDMA 1700	N/A	Bluetooth	N/A	Voice + Wireless Headset
B12	WCDMA 1900	N/A	Bluetooth	N/A	Voice + Wireless Headset

		Transmitter Stand-Alone 1 g SAR Values (W/kg)			1 g SAR Summations (W/kg)	
Band		GSM 850	GSM 1900	Wi-Fi 2.4 GHz	Case B1	Case B2
Power Condition or Reduced Limit		N/A	N/A	N/A	GSM 850 + Wi-Fi 2.4 GHz	GSM 1900 + Wi-Fi 2.4 GHz
Position	Body Worn, Front of Phone 15 mm from Phantom	0.66	0.37	0.07	0.73	0.44
	Body Worn, Back of Phone 15 mm from Phantom	0.55	0.50	0.12	0.67	0.62

Table 4-17: SAR summations for simultaneous evaluation – GSM in Body-Worn Accessory Positions w/WiFi

		Transmitter Stand-Alone 1 g SAR Values (W/kg)				1 g SAR Summations (W/kg)		
Band		WCDMA 850	WCDMA 1750	WCDMA 1900	Wi-Fi 2.4 GHz	Case B3	Case B4	Case B5
Power Condition or Reduced Limit		N/A	N/A	N/A	N/A	WCDMA 850 + Wi-Fi 2.4 GHz	WCDMA 1700 + Wi-Fi 2.4 GHz	WCDMA 1900 + Wi-Fi 2.4 GHz
Position	Body Worn, Front of Phone 15 mm from Phantom	0.71	0.41	0.64	0.07	0.78	0.48	0.71
	Body Worn, Back of Phone 15 mm from Phantom	0.95	0.65	1.06	0.12	1.07	0.77	1.18

Table 4-18: SAR summations for simultaneous evaluation – WCDMA in Body-Worn Accessory Positions w/WiFi

		Transmitter Stand-Alone 1 g SAR Values (W/kg)					1 g SAR Summations (W/kg)			
Band		GSM 850	GPRS 850	GSM 1900	GPRS 1900	Bluetooth	Case B6	Case B7	Case B8	Case B9
Power Condition or Reduced Limit		N/A	N/A	N/A	N/A	N/A	GSM 850 + Bluetooth	GPRS 850 + Bluetooth	GSM 1900 + Bluetooth	GPRS 1900 + Bluetooth
Position	Body Worn, Front of Phone 15 mm from Phantom	0.66	0.83	0.37	N/A	0.20	0.86	1.03	0.57	N/A
	Body Worn, Back of Phone 15 mm from Phantom	0.55	N/A	0.50	0.90	0.20	0.75	N/A	0.70	1.10

Table 4-19: SAR summations for simultaneous evaluation – GSM/GPRS in Body-Worn Accessory Positions w/BT

		Transmitter Stand-Alone 1 g SAR Values (W/kg)				1 g SAR Summations (W/kg)		
Band		WCDMA 850	WCDMA 1750	WCDMA 1900	Bluetooth	Case B10	Case B11	Case B12
Power Condition or Reduced Limit		N/A	N/A	N/A	N/A	WCDMA 850 + Bluetooth	WCDMA 1700 + Bluetooth	WCDMA 1900 + Bluetooth
Position	Body Worn, Front of Phone 15 mm from Phantom	0.71	0.41	0.64	0.20	0.91	0.61	0.84
	Body Worn, Back of Phone 15 mm from Phantom	0.95	0.65	1.06	0.20	1.15	0.85	1.26

Table 4-20: SAR summations for simultaneous evaluation – WCDMA in Body-Worn Accessory Positions w/BT

Mobile Hotspot Exposure Conditions; Simultaneous Transmit Configurations, including Reduced Power Limits					
Case	Transmitter #1		Transmitter #2		Notes
	Transmitter Configuration	PWR	Transmitter Configuration	PWR	
M1	GPRS 850	26.5	Wi-Fi 2.4 GHz	N/A	Mobile Hotspot session
M2	GPRS 1900	23.5	Wi-Fi 2.4 GHz	N/A	Mobile Hotspot session
M3	WCDMA 850	22.0	Wi-Fi 2.4 GHz	N/A	Mobile Hotspot session
M4	WCDMA 1700	22.0	Wi-Fi 2.4 GHz	N/A	Mobile Hotspot session
M5	WCDMA 1900	19.0	Wi-Fi 2.4 GHz	N/A	Mobile Hotspot session
M6	GPRS 850	26.5	Bluetooth	N/A	Mobile Hotspot session
M7	GPRS 1900	23.5	Bluetooth	N/A	Mobile Hotspot session
M8	WCDMA 850	22.0	Bluetooth	N/A	Mobile Hotspot session
M9	WCDMA 1700	22.0	Bluetooth	N/A	Mobile Hotspot session
M10	WCDMA 1900	19.0	Bluetooth	N/A	Mobile Hotspot session

		Transmitter Stand-Alone 1 g SAR Values (W/kg)					1 g SAR Summations (W/kg)					
		GPRS 850	GPRS 1900	WCDMA 850	WCDMA 1700	WCDMA 1900	Wi-Fi 2.4 GHz	Case M1	Case M2	Case M3	Case M4	Case M5
<b>Band</b>		GPRS 850	GPRS 1900	WCDMA 850	WCDMA 1700	WCDMA 1900	Wi-Fi 2.4 GHz	GPRS 850 + Wi-Fi 2.4 GHz	GPRS 1900 + Wi-Fi 2.4 GHz	WCDMA 850 + Wi-Fi 2.4 GHz	WCDMA 1700 + Wi-Fi 2.4 GHz	WCDMA 1900 + Wi-Fi 2.4 GHz
<b>Power Condition or Reduced Limit</b>		26.5	23.5	22.0	22.0	19.0	N/A					
<b>Position</b>	Front of Phone 10 mm from Phantom	0.30	0.50	0.40	0.67	0.36	0.12	0.42	0.62	0.52	0.79	0.48
	Back of Phone 10 mm from Phantom	0.44	0.71	0.58	0.97	0.57	0.25	0.69	0.96	0.83	1.22	0.82
	Left Edge of Phone 10 mm from Phantom	0.27	0.14	0.40	0.07	0.12	0.08	0.35	0.22	0.48	0.15	0.20
	Right Edge of Phone 10 mm from Phantom	0.29	0.04	0.41	0.10	0.02	0.00	0.29	0.04	0.41	0.10	0.02
	Top Edge of Phone 10 mm from Phantom	0.00	0.00	0.00	0.00	0.00	0.19	0.19	0.19	0.19	0.19	0.19
	Bottom Edge of Phone 10 mm from Phantom	0.02	1.31	0.04	1.42	1.07	0.00	0.02	1.31	0.04	1.42	1.07

Table 4-21: SAR summations for simultaneous evaluation – Positions during a Mobile Hotspot session w/ WiFi

		Transmitter Stand-Alone 1 g SAR Values (W/kg)					1 g SAR Summations (W/kg)					
		GPRS 850	GPRS 1900	WCDMA 850	WCDMA 1700	WCDMA 1900	Bluetooth	Case M1	Case M2	Case M3	Case M4	Case M5
<b>Band</b>		GPRS 850	GPRS 1900	WCDMA 850	WCDMA 1700	WCDMA 1900	Bluetooth	GPRS 850 + Bluetooth	GPRS 1900 + Bluetooth	WCDMA 850 + Bluetooth	WCDMA 1700 + Bluetooth	WCDMA 1900 + Bluetooth
<b>Power Condition or Reduced Limit</b>		26.5	23.5	22.0	22.0	19.0	N/A					
<b>Position</b>	Front of Phone 10 mm from Phantom	0.30	0.50	0.40	0.67	0.36	0.30	0.60	0.80	0.70	0.97	0.66
	Back of Phone 10 mm from Phantom	0.44	0.71	0.58	0.97	0.57	0.30	0.74	1.01	0.88	1.27	0.87
	Left Edge of Phone 10 mm from Phantom	0.27	0.14	0.40	0.07	0.12	0.30	0.57	0.44	0.70	0.37	0.42
	Right Edge of Phone 10 mm from Phantom	0.29	0.04	0.41	0.10	0.02	0.00	0.29	0.04	0.41	0.10	0.02
	Top Edge of Phone 10 mm from Phantom	0.00	0.00	0.00	0.00	0.00	0.30	0.30	0.30	0.30	0.30	0.30
	Bottom Edge of Phone 10 mm from Phantom	0.02	1.31	0.04	1.42	1.07	0.00	0.02	1.31	0.04	1.42	1.07

Table 4-22: SAR summations for simultaneous evaluation – Positions during a Mobile Hotspot session w/ BT

**Simultaneous Evaluation Conclusion**

As no summation of transmitter SAR values results in a value greater than the compliance limit, no measurements for simultaneous SAR are required.

## 5 References to Test Standards and Guidance

- [1] CENELEC, EN 62209-1:2006 “Human exposure to radio frequency fields from hand-held and body-mounted wireless communication devices – Human models, instrumentation, and procedures - Part 1: Procedure to determine the specific absorption rate (SAR) for hand-held devices used in close proximity to the ear (frequency range of 300 MHz to 3 GHz)”
- [2] CENELEC, EN 50360:2001 “Product standard to demonstrate the compliance of mobile phones with the basic restrictions related to human exposure to electromagnetic fields (300 MHz – 3 GHz)”.
- [3] ANSI / IEEE, C95.1 1992 Edition “IEEE Standard for Safety Levels with Respect to Human Exposure to Radio Frequency Electromagnetic Fields, 3 kHz to 300 GHz”
- [4] Removed
- [5] IEEE 1528 2003 Edition “IEEE Recommended Practice for Determining the Peak Spatial-Average Specific Absorption Rate (SAR) in the Human Head from Wireless Communications Devices: Measurement Techniques”
- [6] ICNIRP Guidelines “Guidelines for Limiting Exposure to Time-Varying Electric, Magnetic, and Electromagnetic Fields (up to 300 GHz)”
- [7] IC RSS-102 “Radio Frequency (RF) Exposure Compliance of Radiocommunication Apparatus (All Frequency Bands)”
- [8] IC Notice 2012-DRS1203 “RE: Applicability of Latest FCC RF Exposure KDB Procedures (Publication Date: October 24, 2012) and Other Procedures”
- [9] CENELEC, EN 62209-2:2010 “Human exposure to radio frequency fields from hand-held and body-mounted wireless communication devices - Human models, instrumentation, and procedures - Part 2: Procedure to determine the specific absorption rate (SAR) for wireless communication devices used in close proximity to the human body (frequency range of 30 MHz to 6 GHz)”
- [10] FCC KDB Publication 248227 D01 v01r02 “SAR Measurement Procedures for 802.11 a/b/g Transmitters”
- [11] FCC KDB Publication 447498 D01 v05r01 “Mobile and Portable Devices RF Exposure Procedures and Equipment Authorization Policies”
- [12] FCC KDB Publication 648474 D04 v01r01 “SAR Evaluation Considerations for Wireless Handsets”
- [13] FCC KDB Publication 865664 D01 v01r01 “SAR Measurement Requirements for 100 MHz to 6 GHz”
- [14] FCC KDB Publication 865664 D02 v01r01 “RF Exposure Compliance Reporting and Documentation Considerations”
- [15] FCC KDB Publication 941225 D01 v02r02 “SAR Measurement Procedures for 3G Devices”
- [16] FCC KDB Publication 941225 D03 v01r01 “Recommended SAR Test Reduction Procedures for GSM/GPRS/EDGE”
- [17] FCC KDB Publication 941225 D05 v02r02 “SAR Evaluation Considerations for LTE Devices”
- [18] FCC KDB Publication 941225 D06 v01 “SAR Evaluation Procedures for Portable Devices with Wireless Router Capabilities”

## **Appendix 1**

### **SAR Distribution Plots for Test System Verification**

## **System Accuracy Verification Measurements for Head SAR Measurements**

Date/Time: 8/1/2013 8:55:46 AM

**Test Lab: Motorola Mobility - CW System Verification for SAR using Dipoles**

**DUT Serial: D835V2 - SN:422tr**

**DASY Configuration:**

- Probe: ES3DV3 - SN3180; ConvF(6.23,6.23,6.23); Calibrated: 2/11/2013;
- Sensor-Surface: 4 mm (Mechanical Surface Detection)
- Electronics: DAE4 Sn661; Calibrated: 5/21/2013
- Phantom: R#1 - Sugar SAM (extended range), Rev.2 (24-Feb-12);  
Type: SAM v4.0; Serial: TP-1156
- DASY52 52.8.7(1137); SEMCAD X Version 14.6.10 (7164)

Communication System: CW for SAR Dipoles; Frequency: 835.0 MHz; Duty Cycle: 1:1.000  
Medium Parameters used:  $f=835$  MHz;  $\sigma = 0.9142$ ;  $\epsilon_r = 40.18$  mho/m;  $\rho = 1.000$  kg/m<sup>3</sup>

**<2 GHz, SAM Daily SPC Check/fastSAR, Dipole Area Scan (41x141x1):**

**Interpolated grid: dx=1.000 mm, dy=1.500 mm**

Fast SAR: SAR(1g) = 1.83 W/kg; SAR(10g) = 1.22 W/kg

**<2 GHz, SAM Daily SPC Check/CUBE SAR, 5x5x7 (21x21x36)/Cube 0:**

**Interpolated grid: dx=1.600 mm, dy=1.600 mm, dz=1.000 mm**

Reference Value = 46.459 V/m, Power Drift = 0.032 dB

Averaged SAR: SAR(1g) = 1.83 W/kg; SAR(10g) = 1.20 W/kg

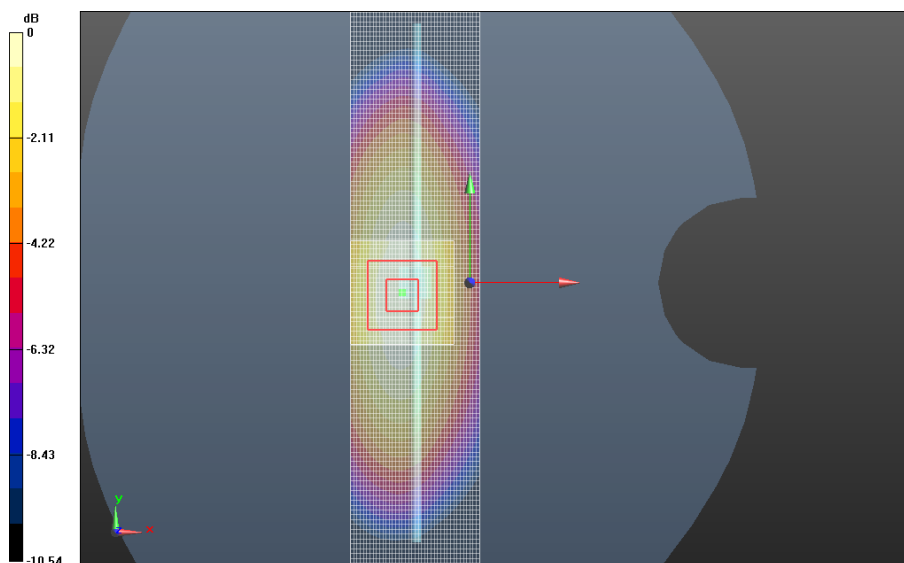

**Daily SPC Check**

Date/Time: 8/2/2013 7:12:05 AM

**Test Lab: Motorola Mobility - CW System Verification for SAR using Dipoles**

DUT Serial: D1800V2 - SN:259tr

**DASY Configuration:**

- Probe: ES3DV3 - SN3180; ConvF(5.01,5.01,5.01); Calibrated: 2/11/2013;
- Sensor-Surface: 4 mm (Mechanical Surface Detection)
- Electronics: DAE4 Sn661; Calibrated: 5/21/2013
- Phantom: R#-1, Triple Flat Phantom 5.1C (Rev.4);  
Type: QD 000 P51 CA; Serial: n/a
- DASY52 52.8.7(1137); SEMCAD X Version 14.6.10 (7164)

Communication System: CW for SAR Dipoles; Frequency: 1800 MHz; Duty Cycle: 1:1.000  
Medium Parameters used:  $f=1800$  MHz;  $\sigma = 1.333$ ;  $\epsilon_r = 38.23$  mho/m;  $\rho = 1.000$  kg/m<sup>3</sup>

**< 2GHz, Daily SPC Check/fastSAR, Dipole Area Scan (41x141x1):****Interpolated grid: dx=1.000 mm, dy=1.500 mm**

Fast SAR: SAR(1g) = 7.51 W/kg; SAR(10g) = 4.06 W/kg

**< 2GHz, Daily SPC Check/CUBE SAR, 5x5x7 (21x21x36)/Cube 0:****Interpolated grid: dx=1.600 mm, dy=1.600 mm, dz=1.000 mm**

Reference Value = 79.455 V/m, Power Drift = 0.022 dB

Averaged SAR: SAR(1g) = 7.46 W/kg; SAR(10g) = 3.93 W/kg

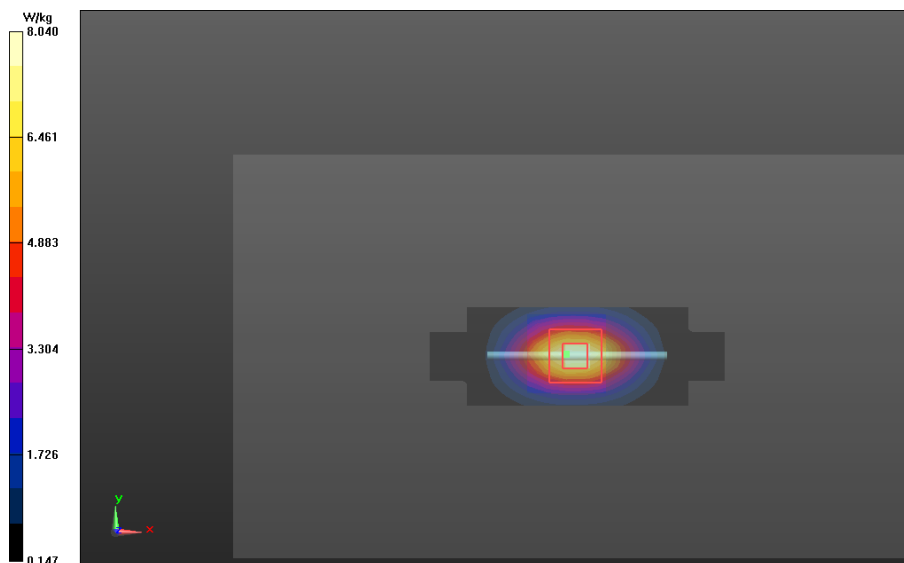
**Daily SPC Check**

Date/Time: 7/25/2013 7:51:19 AM

**Test Lab: Motorola Mobility - CW System Verification for SAR using Dipoles**

**DUT Serial: D835V2 - SN:436tr**

**DASY Configuration:**

- Probe: ES3DV3 - SN3124; ConvF(6.01,6.01,6.01); Calibrated: 8/20/2012;
- Sensor-Surface: 4 mm (Mechanical Surface Detection)
- Electronics: DAE4 Sn376; Calibrated: 9/3/2012
- Phantom: R#2 Sugar SAM (extended range), Rev.2 (24-Feb-12);  
Type: SAM v4.0; Serial: TP-1235
- DASY52 52.8.7(1137); SEMCAD X Version 14.6.10 (7164)

Communication System: CW for SAR Dipoles; Frequency: 835.0 MHz; Duty Cycle: 1:1.000  
Medium Parameters used:  $f=835$  MHz;  $\sigma = 0.9009$ ;  $\epsilon_r = 39.18$  mho/m;  $\rho = 1.000$  kg/m<sup>3</sup>

**<2 GHz, SAM Daily SPC Check/fastSAR, Dipole Area Scan (41x141x1):**

**Interpolated grid: dx=1.000 mm, dy=1.500 mm**

Fast SAR: SAR(1g) = 1.99 W/kg; SAR(10g) = 1.33 W/kg

**<2 GHz, SAM Daily SPC Check/CUBE SAR, 5x5x7 (21x21x36)/Cube 0:**

**Interpolated grid: dx=1.600 mm, dy=1.600 mm, dz=1.000 mm**

Reference Value = 49.525 V/m, Power Drift = -0.014 dB

Averaged SAR: SAR(1g) = 1.98 W/kg; SAR(10g) = 1.30 W/kg

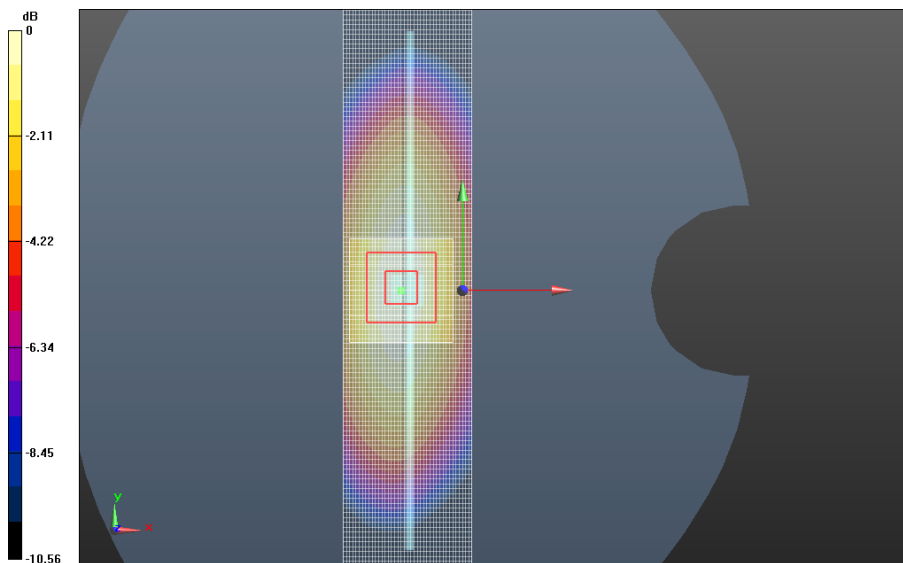

**Daily SPC Check**

Date/Time: 7/26/2013 7:11:28 AM

**Test Lab: Motorola Mobility - CW System Verification for SAR using Dipoles**

**DUT Serial: D1800V2 - SN:2d190**

**DASY Configuration:**

- Probe: ES3DV3 - SN3124; ConvF(5.07,5.07,5.07); Calibrated: 8/20/2012;
- Sensor-Surface: 4 mm (Mechanical Surface Detection)
- Electronics: DAE4 Sn376; Calibrated: 9/3/2012
- Phantom: R#2 Triple Flat Phantom 5.1C (Rev.4);  
Type: QD 000 P51 CA; Serial: n/a
- DASY52 52.8.7(1137); SEMCAD X Version 14.6.10 (7164)

Communication System: CW for SAR Dipoles; Frequency: 1800 MHz; Duty Cycle: 1:1.000  
Medium Parameters used:  $f=1800$  MHz;  $\sigma = 1.329$ ;  $\epsilon_r = 38.88$  mho/m;  $\rho = 1.000$  kg/m<sup>3</sup>

**< 2GHz, Daily SPC Check/fastSAR, Dipole Area Scan (41x141x1):**

**Interpolated grid: dx=1.000 mm, dy=1.500 mm**

Fast SAR: SAR(1g) = 7.60 W/kg; SAR(10g) = 4.05 W/kg

**< 2GHz, Daily SPC Check/CUBE SAR, 5x5x7 (21x21x36)/Cube 0:**

**Interpolated grid: dx=1.600 mm, dy=1.600 mm, dz=1.000 mm**

Reference Value = 79.152 V/m, Power Drift = -0.043 dB

Averaged SAR: SAR(1g) = 7.41 W/kg; SAR(10g) = 3.91 W/kg

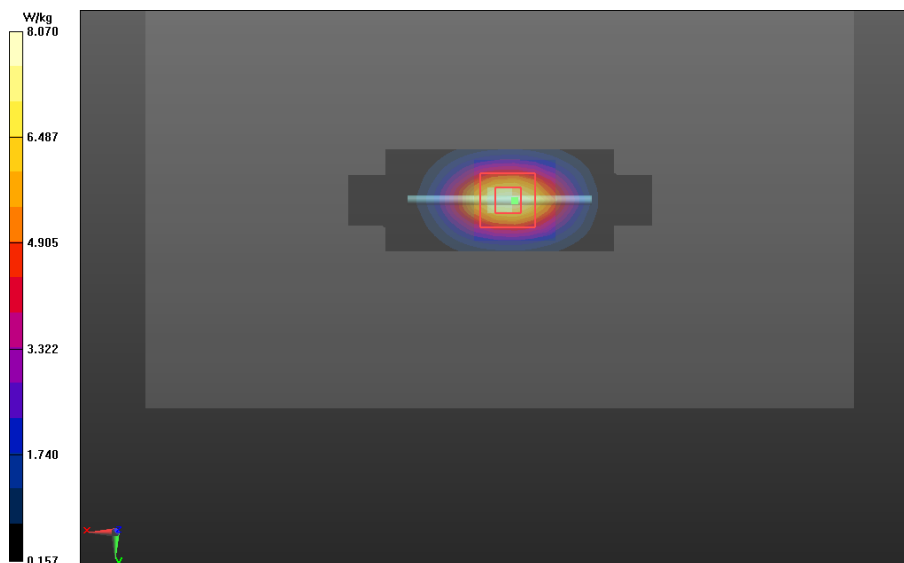

**Daily SPC Check**

Date/Time: 7/27/2013 6:20:03 AM

**Test Lab: Motorola Mobility - CW System Verification for SAR using Dipoles****DUT Serial: D2450V2 - SN:740****DASY Configuration:**

- Probe: EX3DV4 - SN3730; ConvF(6.9,6.9,6.9); Calibrated: 8/24/2012;
- Sensor-Surface: 4 mm (Mechanical Surface Detection)
- Electronics: DAE4 Sn784; Calibrated: 3/6/2013
- Phantom: R#3, 2450 WiFi SAM (extended range), Rev.2 (24-Feb-12);  
Type: SAM v4.0; Serial: TP-1153
- DASY52 52.8.7(1137); SEMCAD X Version 14.6.10 (7164)

Communication System: CW for SAR Dipoles; Frequency: 2450 MHz; Duty Cycle: 1:1.000  
Medium Parameters used:  $f=2450$  MHz;  $\sigma = 1.759$ ;  $\epsilon_r = 36.85$  mho/m;  $\rho = 1.000$  kg/m<sup>3</sup>

**2-3 GHz, SAM Daily SPC Check/fastSAR, Dipole Area Scan (41x221x1):****Interpolated grid: dx=1.000 mm, dy=1.000 mm**

Fast SAR: SAR(1g) = 5.23 W/kg; SAR(10g) = 2.47 W/kg

**2-3 GHz, SAM Daily SPC Check/CUBE SAR, 7x7x7 (31x31x36)/Cube 0:****Interpolated grid: dx=1.000 mm, dy=1.000 mm, dz=1.000 mm**

Reference Value = 58.166 V/m, Power Drift = 0.026 dB

Averaged SAR: SAR(1g) = 5.26 W/kg; SAR(10g) = 2.43 W/kg

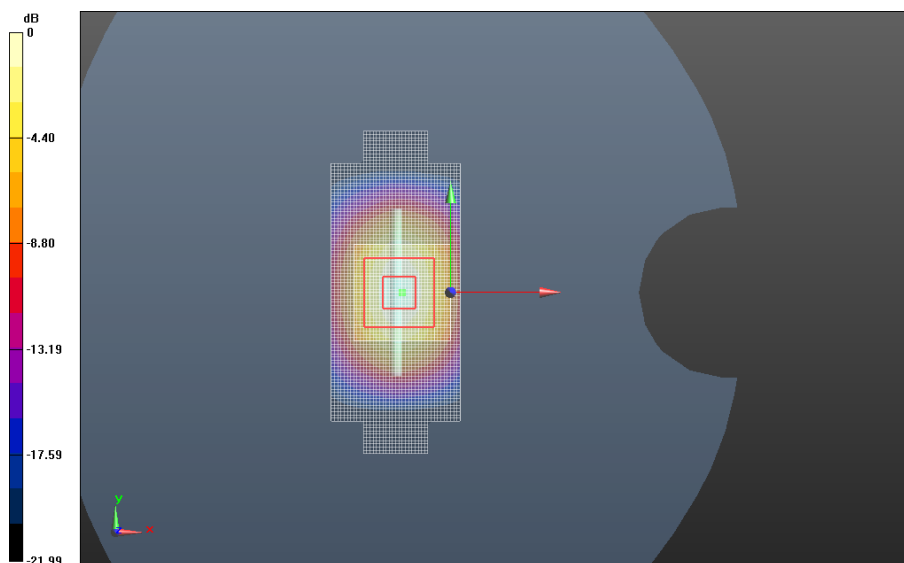
**Daily SPC Check**

## **System Accuracy Verification Measurements for Body SAR Measurements**

Date/Time: 8/6/2013 9:41:38 PM

**Test Lab: Motorola Mobility - CW System Verification for SAR using Dipoles****DUT Serial: D835V2 - SN:422tr****DASY Configuration:**

- Probe: ES3DV3 - SN3180; ConvF(6.05,6.05,6.05); Calibrated: 2/11/2013;
- Sensor-Surface: 4 mm (Mechanical Surface Detection)
- Electronics: DAE4 Sn661; Calibrated: 5/21/2013
- Phantom: R#-1, Triple Flat Phantom 5.1C (Rev.4);  
Type: QD 000 P51 CA; Serial: n/a
- DASY52 52.8.7(1137); SEMCAD X Version 14.6.10 (7164)

Communication System: CW for SAR Dipoles; Frequency: 835.0 MHz; Duty Cycle: 1:1.000  
Medium Parameters used:  $f=835$  MHz;  $\sigma = 0.9978$ ;  $\epsilon_r = 54.04$  mho/m;  $\rho = 1.000$  kg/m<sup>3</sup>

**< 2GHz, Daily SPC Check/fastSAR, Dipole Area Scan (41x141x1):****Interpolated grid: dx=1.000 mm, dy=1.500 mm**

Fast SAR: SAR(1g) = 1.91 W/kg; SAR(10g) = 1.27 W/kg

**< 2GHz, Daily SPC Check/CUBE SAR, 5x5x7 (21x21x36)/Cube 0:****Interpolated grid: dx=1.600 mm, dy=1.600 mm, dz=1.000 mm**

Reference Value = 46.662 V/m, Power Drift = 0.043 dB

Averaged SAR: SAR(1g) = 1.92 W/kg; SAR(10g) = 1.28 W/kg

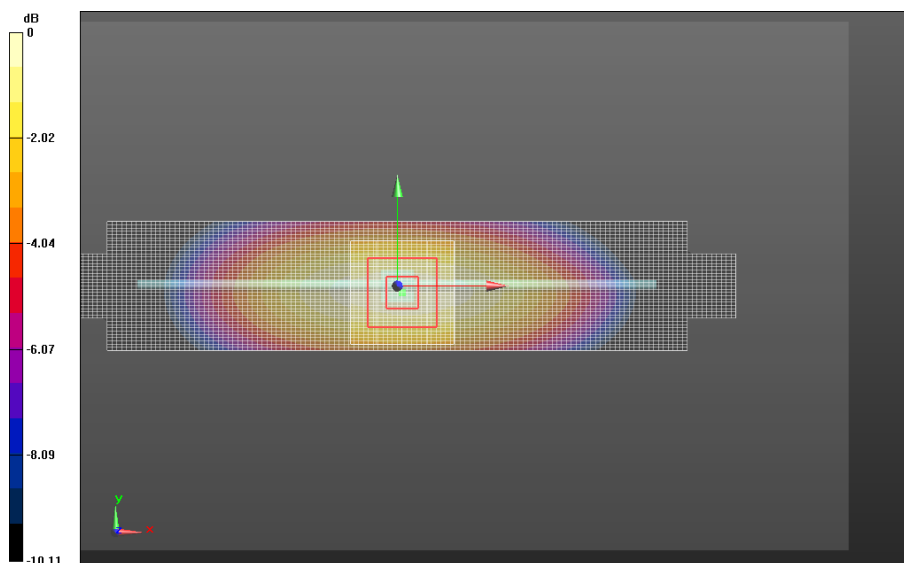
**Daily SPC Check**

Date/Time: 8/7/2013 12:56:22 AM

**Test Lab: Motorola Mobility - CW System Verification for SAR using Dipoles**

DUT Serial: D1800V2 - SN:259tr

**DASY Configuration:**

- Probe: ES3DV3 - SN3180; ConvF(4.78,4.78,4.78); Calibrated: 2/11/2013;
- Sensor-Surface: 4 mm (Mechanical Surface Detection)
- Electronics: DAE4 Sn661; Calibrated: 5/21/2013
- Phantom: R#-1, Triple Flat Phantom 5.1C (Rev.4);  
Type: QD 000 P51 CA; Serial: n/a
- DASY52 52.8.7(1137); SEMCAD X Version 14.6.10 (7164)

Communication System: CW for SAR Dipoles; Frequency: 1800 MHz; Duty Cycle: 1:1.000  
Medium Parameters used:  $f=1800$  MHz;  $\sigma = 1.451$ ;  $\epsilon_r = 52.74$  mho/m;  $\rho = 1.000$  kg/m<sup>3</sup>

**< 2GHz, Daily SPC Check/fastSAR, Dipole Area Scan (41x141x1):****Interpolated grid: dx=1.000 mm, dy=1.500 mm**

Fast SAR: SAR(1g) = 7.44 W/kg; SAR(10g) = 3.95 W/kg

**< 2GHz, Daily SPC Check/CUBE SAR, 5x5x7 (21x21x36)/Cube 0:****Interpolated grid: dx=1.600 mm, dy=1.600 mm, dz=1.000 mm**

Reference Value = 76.227 V/m, Power Drift = 0.011 dB

Averaged SAR: SAR(1g) = 7.37 W/kg; SAR(10g) = 3.93 W/kg

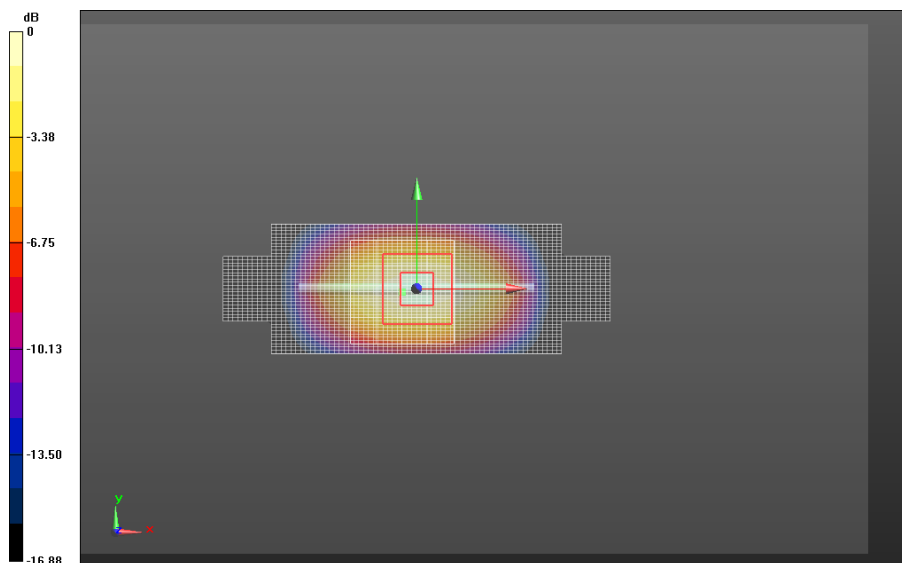
**Daily SPC Check**

Date/Time: 8/5/2013 7:50:24 PM

## Test Lab: Motorola Mobility - CW System Verification for SAR using Dipoles

**DUT Serial: D1800V2 - SN:259tr****DASY Configuration:**

- Probe: ES3DV3 - SN3180; ConvF(4.78,4.78,4.78); Calibrated: 2/11/2013;
- Sensor-Surface: 4 mm (Mechanical Surface Detection)
- Electronics: DAE4 Sn661; Calibrated: 5/21/2013
- Phantom: R#-1, Triple Flat Phantom 5.1C (Rev.4); Type: QD 000 P51 CA; Serial: n/a
- DASY52 52.8.7(1137); SEMCAD X Version 14.6.10 (7164)

Communication System: CW for SAR Dipoles; Frequency: 1800 MHz; Duty Cycle: 1:1.000  
Medium Parameters used:  $f=1800$  MHz;  $\sigma = 1.456$ ;  $\epsilon_r = 52.36$  mho/m;  $\rho = 1.000$  kg/m<sup>3</sup>

**< 2GHz, Daily SPC Check/fastSAR, Dipole Area Scan (41x141x1):****Interpolated grid: dx=1.000 mm, dy=1.500 mm**

Fast SAR: SAR(1g) = 7.44 W/kg; SAR(10g) = 3.95 W/kg

**< 2GHz, Daily SPC Check/CUBE SAR, 5x5x7 (21x21x36)/Cube 0:****Interpolated grid: dx=1.600 mm, dy=1.600 mm, dz=1.000 mm**

Reference Value = 73.747 V/m, Power Drift = -0.028 dB

Averaged SAR: SAR(1g) = 7.31 W/kg; SAR(10g) = 3.90 W/kg

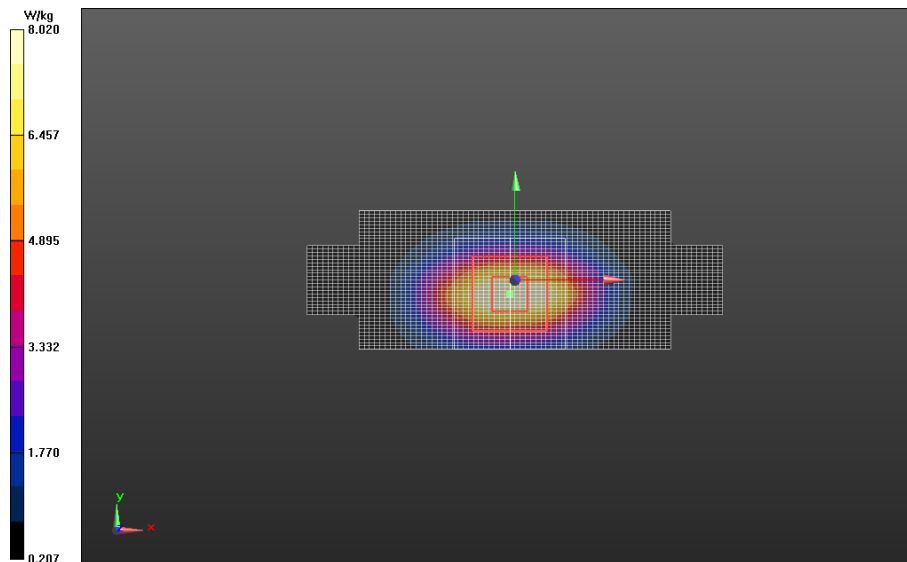
**Daily SPC Check**

Date/Time: 7/25/2013 2:27:51 PM

**Test Lab: Motorola Mobility - CW System Verification for SAR using Dipoles**

DUT Serial: D835V2 - SN:436tr

**DASY Configuration:**

- Probe: ES3DV3 - SN3124; ConvF(6.02,6.02,6.02); Calibrated: 8/20/2012;
- Sensor-Surface: 4 mm (Mechanical Surface Detection)
- Electronics: DAE4 Sn376; Calibrated: 9/3/2012
- Phantom: R#2 Triple Flat Phantom 5.1C (Rev.4);  
Type: QD 000 P51 CA; Serial: n/a
- DASY52 52.8.7(1137); SEMCAD X Version 14.6.10 (7164)

Communication System: CW for SAR Dipoles; Frequency: 835.0 MHz; Duty Cycle: 1:1.000  
Medium Parameters used:  $f=835$  MHz;  $\sigma = 0.9972$ ;  $\epsilon_r = 53.56$  mho/m;  $\rho = 1.000$  kg/m<sup>3</sup>

**< 2GHz, Daily SPC Check/fastSAR, Dipole Area Scan (41x141x1):****Interpolated grid: dx=1.000 mm, dy=1.500 mm**

Fast SAR: SAR(1g) = 1.96 W/kg; SAR(10g) = 1.30 W/kg

**< 2GHz, Daily SPC Check/CUBE SAR, 5x5x7 (21x21x36)/Cube 0:****Interpolated grid: dx=1.600 mm, dy=1.600 mm, dz=1.000 mm**

Reference Value = 47.469 V/m, Power Drift = -0.012 dB

Averaged SAR: SAR(1g) = 1.96 W/kg; SAR(10g) = 1.30 W/kg

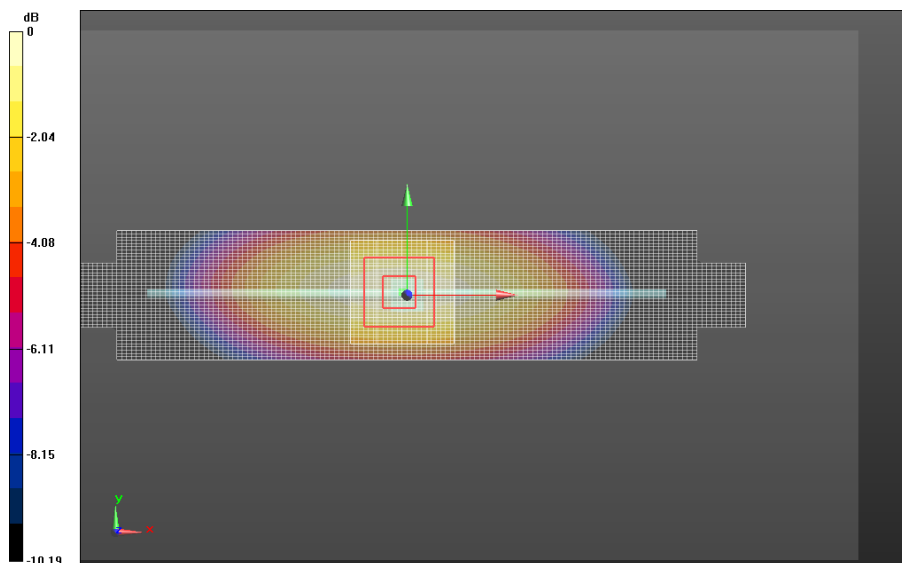
**Daily SPC Check**

Date/Time: 7/26/2013 9:31:02 AM

**Test Lab: Motorola Mobility - CW System Verification for SAR using Dipoles****DUT Serial: D1800V2 - SN:2d190****DASY Configuration:**

- Probe: ES3DV3 - SN3124; ConvF(4.76,4.76,4.76); Calibrated: 8/20/2012;
- Sensor-Surface: 4 mm (Mechanical Surface Detection)
- Electronics: DAE4 Sn376; Calibrated: 9/3/2012
- Phantom: R#2 Triple Flat Phantom 5.1C (Rev.4);  
Type: QD 000 P51 CA; Serial: n/a
- DASY52 52.8.7(1137); SEMCAD X Version 14.6.10 (7164)

Communication System: CW for SAR Dipoles; Frequency: 1800 MHz; Duty Cycle: 1:1.000  
Medium Parameters used:  $f=1800$  MHz;  $\sigma = 1.541$ ;  $\epsilon_r = 50.48$  mho/m;  $\rho = 1.000$  kg/m<sup>3</sup>

**< 2GHz, Daily SPC Check/fastSAR, Dipole Area Scan (41x141x1):****Interpolated grid: dx=1.000 mm, dy=1.500 mm**

Fast SAR: SAR(1g) = 7.95 W/kg; SAR(10g) = 4.20 W/kg

**< 2GHz, Daily SPC Check/CUBE SAR, 5x5x7 (21x21x36)/Cube 0:****Interpolated grid: dx=1.600 mm, dy=1.600 mm, dz=1.000 mm**

Reference Value = 71.988 V/m, Power Drift = -0.014 dB

Averaged SAR: SAR(1g) = 7.73 W/kg; SAR(10g) = 4.10 W/kg

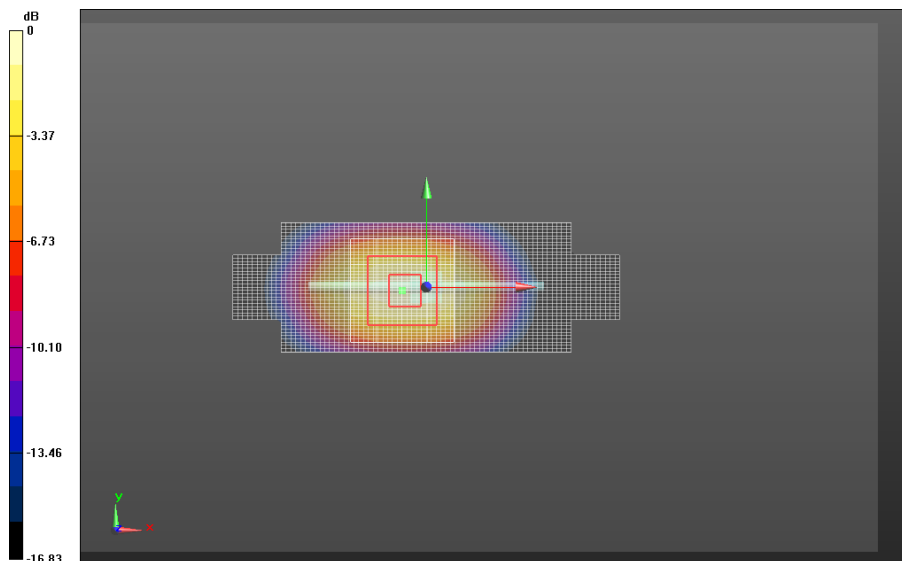
**Daily SPC Check**

Date/Time: 7/26/2013 3:12:21 PM

**Test Lab: Motorola Mobility - CW System Verification for SAR using Dipoles****DUT Serial: D2450V2 - SN:740****DASY Configuration:**

- Probe: EX3DV4 - SN3730; ConvF(6.86,6.86,6.86); Calibrated: 8/24/2012;
- Sensor-Surface: 4 mm (Mechanical Surface Detection)
- Electronics: DAE4 Sn784; Calibrated: 3/6/2013
- Phantom: R#-3, Triple Flat Phantom 5.1C (Rev.4);  
Type: QD 000 P51 CA; Serial: n/a
- DASY52 52.8.7(1137); SEMCAD X Version 14.6.10 (7164)

Communication System: CW for SAR Dipoles; Frequency: 2450 MHz; Duty Cycle: 1:1.000  
Medium Parameters used:  $f=2450$  MHz;  $\sigma = 1.955$ ;  $\epsilon_r = 49.88$  mho/m;  $\rho = 1.000$  kg/m<sup>3</sup>

**2-3GHz, Daily SPC Check/fastSAR, Dipole Area Scan (41x221x1):****Interpolated grid: dx=1.000 mm, dy=1.000 mm**

Fast SAR: SAR(1g) = 5.04 W/kg; SAR(10g) = 2.34 W/kg

**2-3GHz, Daily SPC Check/CUBE SAR, 7x7x7 (31x31x36)/Cube 0:****Interpolated grid: dx=1.000 mm, dy=1.000 mm, dz=1.000 mm**

Reference Value = 51.565 V/m, Power Drift = 0.033 dB

Averaged SAR: SAR(1g) = 5.02 W/kg; SAR(10g) = 2.34 W/kg

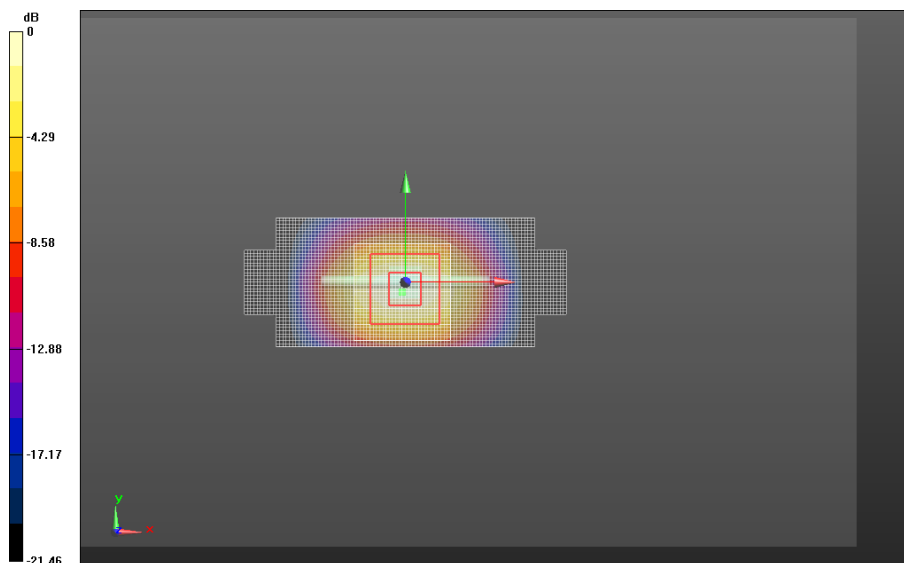
**Daily SPC Check**

## **Appendix 2**

### **SAR Distribution Plots for Head-Adjacent Test Results**

Date/Time: 8/1/2013 7:20:21 PM

## Test Lab: Motorola Mobility

### DUT Serial: LDXU220015;

Antenna: Internal;

Test Configuration: Cheek

### DASY Configuration:

- Probe: ES3DV3 - SN3180; ConvF(6.23,6.23,6.23); Calibrated: 2/11/2013;
- Sensor-Surface: 4 mm (Mechanical Surface Detection)
- Electronics: DAE4 Sn661; Calibrated: 5/21/2013
- Phantom: R#1 - Sugar SAM (extended range), Rev.2 (24-Feb-12); Type: SAM v4.0; Serial: TP-1156
- DASY52 52.8.7(1137); SEMCAD X Version 14.6.10 (7164)

Communication System: \_GSM (0); Communication System Band: GSM 850; Frequency: 836.6 MHz;  
Duty Cycle: 1:8.300

Medium Parameters used:  $f=836.6$  MHz;  $\sigma = 0.9158$ ;  $\epsilon_r = 40.16$  mho/m;  $\rho = 1.000$  kg/m<sup>3</sup>

### 0.6-2GHz Right Head Template/15mm, Area Scan (61x161x1):

Interpolated grid:  $dx=1.500$  mm,  $dy=1.500$  mm

Fast SAR: SAR(1g) = 0.403 W/kg; SAR(10g) = 0.275 W/kg

### 0.6-2GHz Right Head Template/5x5x7 Zoom Scan (0.6-2GHz) (21x21x36)/Cube 0:

Interpolated grid:  $dx=1.600$  mm,  $dy=1.600$  mm,  $dz=1.000$  mm

Reference Value = 21.375 V/m, Power Drift = -0.00626 dB

Averaged SAR: SAR(1g) = 0.404 W/kg; SAR(10g) = 0.305 W/kg

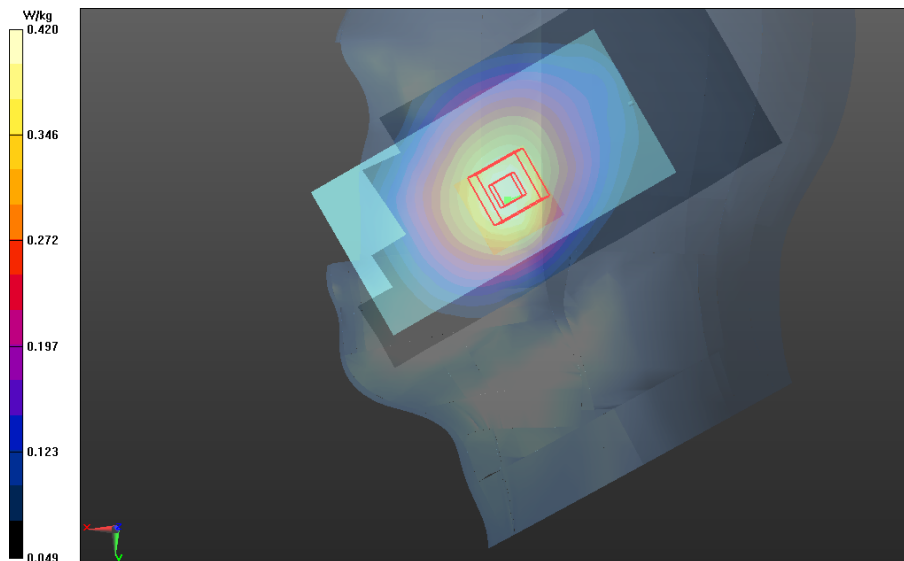

0.6-2GHz Right Head Template

Date/Time: 8/3/2013 2:03:25 AM

## Test Lab: Motorola Mobility

### DUT Serial: LDXU220015;

Antenna: Internal;

Test Configuration: Cheek

### DASY Configuration:

- Probe: ES3DV3 - SN3180; ConvF(5.01,5.01,5.01); Calibrated: 2/11/2013;
- Sensor-Surface: 4 mm (Mechanical Surface Detection)
- Electronics: DAE4 Sn661; Calibrated: 5/21/2013
- Phantom: R#1 - Glycol SAM (extended range), Rev.2 (24-Feb-12); Type: SAM v4.0; Serial: TP-1319
- DASY52 52.8.7(1137); SEMCAD X Version 14.6.10 (7164)

Communication System: \_GPRS Class 10 (0); Communication System Band: 1900 MHz; Frequency: 1880 MHz; Duty Cycle: 1:4.150

Medium Parameters used:  $f=1880$  MHz;  $\sigma = 1.417$ ;  $\epsilon_r = 37.90$  mho/m;  $\rho = 1.000$  kg/m<sup>3</sup>

### 0.6-2GHz, Left Head Template/15mm, Area Scan (61x161x1):

Interpolated grid:  $dx=1.500$  mm,  $dy=1.500$  mm

Fast SAR: SAR(1g) = 0.474 W/kg; SAR(10g) = 0.271 W/kg

### 0.6-2GHz, Left Head Template/5x5x7 Zoom Scan (0.6-2GHz) (21x21x36)/Cube 0:

Interpolated grid:  $dx=1.600$  mm,  $dy=1.600$  mm,  $dz=1.000$  mm

Reference Value = 15.974 V/m, Power Drift = -0.00538 dB

Averaged SAR: SAR(1g) = 0.488 W/kg; SAR(10g) = 0.288 W/kg

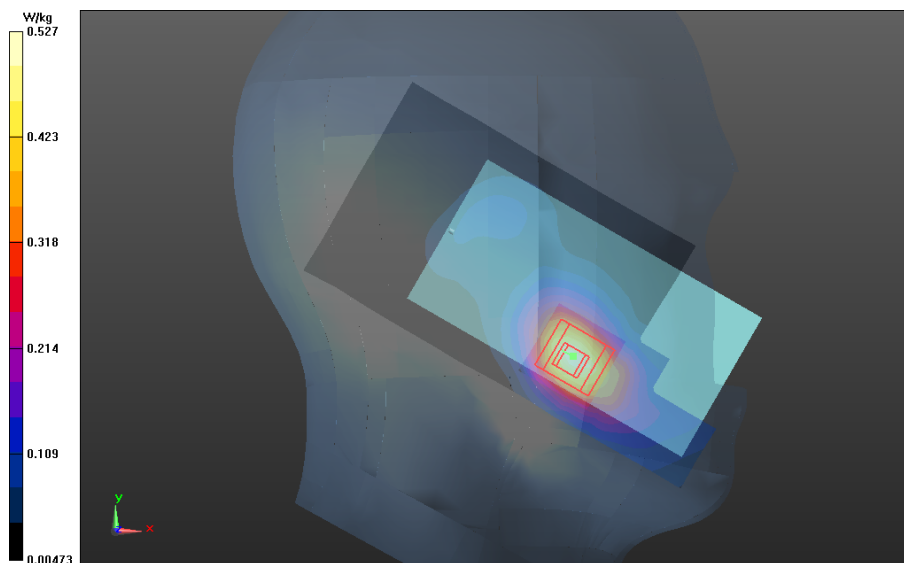

0.6-2GHz, Left Head Template

Date/Time: 7/25/2013 8:22:06 PM

## Test Lab: Motorola Mobility

### DUT Serial: LDXU220297;

Antenna: Internal;

Test Configuration: Cheek

### DASY Configuration:

- Probe: ES3DV3 - SN3124; ConvF(6.01,6.01,6.01); Calibrated: 8/20/2012;
- Sensor-Surface: 4 mm (Mechanical Surface Detection)
- Electronics: DAE4 Sn376; Calibrated: 9/3/2012
- Phantom: R#2 Sugar SAM (extended range), Rev.2 (24-Feb-12); Type: SAM v4.0; Serial: TP-1235
- DASY52 52.8.7(1137); SEMCAD X Version 14.6.10 (7164)

Communication System: \_WCDMA (0); Communication System Band: WCDMA-850, Band 5;  
Frequency: 836.0 MHz; Duty Cycle: 1:1.000

Medium Parameters used:  $f=836$  MHz;  $\sigma = 0.9019$ ;  $\epsilon_r = 39.17$  mho/m;  $\rho = 1.000$  kg/m<sup>3</sup>

### 0.6-2GHz Right Head Template/15mm, Area Scan (61x161x1):

Interpolated grid:  $dx=1.500$  mm,  $dy=1.500$  mm

Fast SAR: SAR(1g) = 0.394 W/kg; SAR(10g) = 0.269 W/kg

### 0.6-2GHz Right Head Template/5x5x7 Zoom Scan (0.6-2GHz) (21x21x36)/Cube 0:

Interpolated grid:  $dx=1.600$  mm,  $dy=1.600$  mm,  $dz=1.000$  mm

Reference Value = 21.182 V/m, Power Drift = -0.107 dB

Averaged SAR: SAR(1g) = 0.392 W/kg; SAR(10g) = 0.294 W/kg

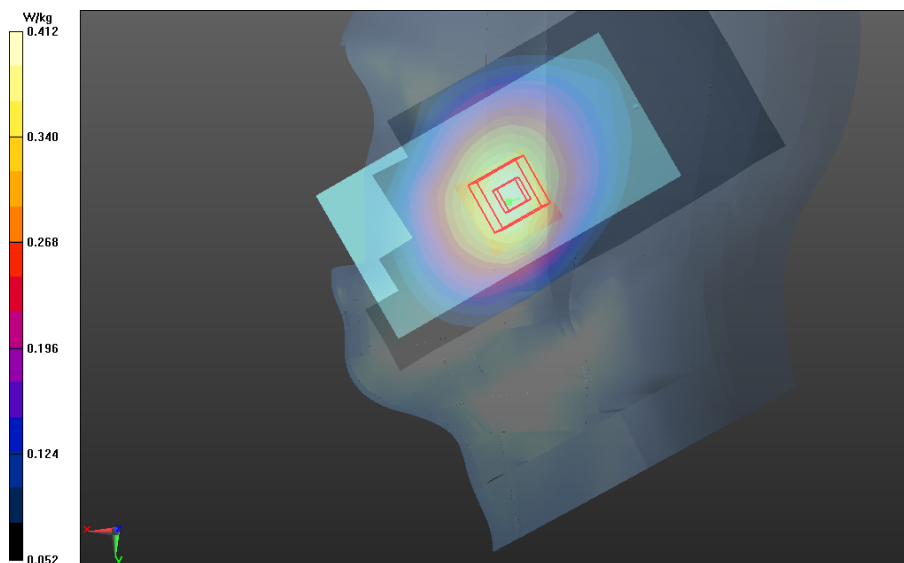

0.6-2GHz Right Head Template

Date/Time: 7/26/2013 4:36:45 PM

## Test Lab: Motorola Mobility

### DUT Serial: LDXU220297;

Antenna: Internal;

Test Configuration: Cheek

### DASY Configuration:

- Probe: ES3DV3 - SN3124; ConvF(5.07,5.07,5.07); Calibrated: 8/20/2012;
- Sensor-Surface: 4 mm (Mechanical Surface Detection)
- Electronics: DAE4 Sn376; Calibrated: 9/3/2012
- Phantom: R#2 Glycol SAM (extended range), Rev.2 (24-Feb-12); Type: SAM v4.0; Serial: TP-1136
- DASY52 52.8.7(1137); SEMCAD X Version 14.6.10 (7164)

Communication System: \_WCDMA (0); Communication System Band: WCDMA-1700, Band 4;  
Frequency: 1752 MHz; Duty Cycle: 1:1.000

Medium Parameters used:  $f=1752$  MHz;  $\sigma = 1.354$ ;  $\epsilon_r = 38.51$  mho/m;  $\rho = 1.000$  kg/m<sup>3</sup>

### 0.6-2GHz Right Head Template/15mm, Area Scan (61x161x1):

Interpolated grid:  $dx=1.500$  mm,  $dy=1.500$  mm

Fast SAR: SAR(1g) = 0.188 W/kg; SAR(10g) = 0.110 W/kg

### 0.6-2GHz Right Head Template/5x5x7 Zoom Scan (0.6-2GHz) (21x21x36)/Cube 0:

Interpolated grid:  $dx=1.600$  mm,  $dy=1.600$  mm,  $dz=1.000$  mm

Reference Value = 10.119 V/m, Power Drift = 0.142 dB

Averaged SAR: SAR(1g) = 0.187 W/kg; SAR(10g) = 0.118 W/kg

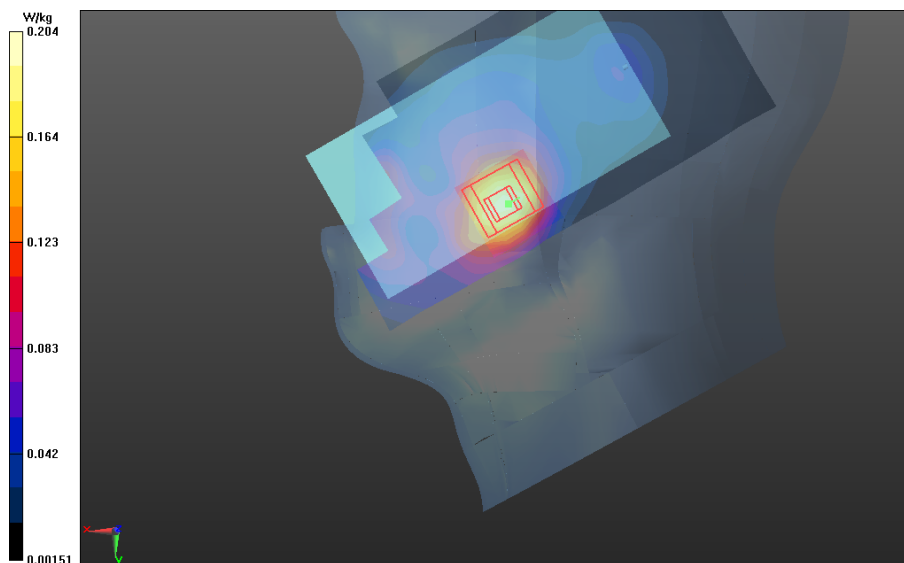

0.6-2GHz Right Head Template

Date/Time: 7/27/2013 1:47:13 AM

## Test Lab: Motorola Mobility

### DUT Serial: LDXU220297;

Antenna: Internal;

Test Configuration: Cheek

### DASY Configuration:

- Probe: ES3DV3 - SN3124; ConvF(5.07,5.07,5.07); Calibrated: 8/20/2012;
- Sensor-Surface: 4 mm (Mechanical Surface Detection)
- Electronics: DAE4 Sn376; Calibrated: 9/3/2012
- Phantom: R#2 Glycol SAM (extended range), Rev.2 (24-Feb-12); Type: SAM v4.0; Serial: TP-1136
- DASY52 52.8.7(1137); SEMCAD X Version 14.6.10 (7164)

Communication System: \_WCDMA (0); Communication System Band: WCDMA-1900, Band 2;  
Frequency: 1908 MHz; Duty Cycle: 1:1.000

Medium Parameters used:  $f=1907.6$  MHz;  $\sigma = 1.447$ ;  $\epsilon_r = 38.42$  mho/m;  $\rho = 1.000$  kg/m<sup>3</sup>

### 0.6-2GHz, Left Head Template/15mm, Area Scan (61x161x1):

Interpolated grid:  $dx=1.500$  mm,  $dy=1.500$  mm

Fast SAR: SAR(1g) = 0.871 W/kg; SAR(10g) = 0.496 W/kg

### 0.6-2GHz, Left Head Template/5x5x7 Zoom Scan (0.6-2GHz) (21x21x36)/Cube 0:

Interpolated grid:  $dx=1.600$  mm,  $dy=1.600$  mm,  $dz=1.000$  mm

Reference Value = 22.015 V/m, Power Drift = 0.00346 dB

Averaged SAR: SAR(1g) = 0.898 W/kg; SAR(10g) = 0.525 W/kg

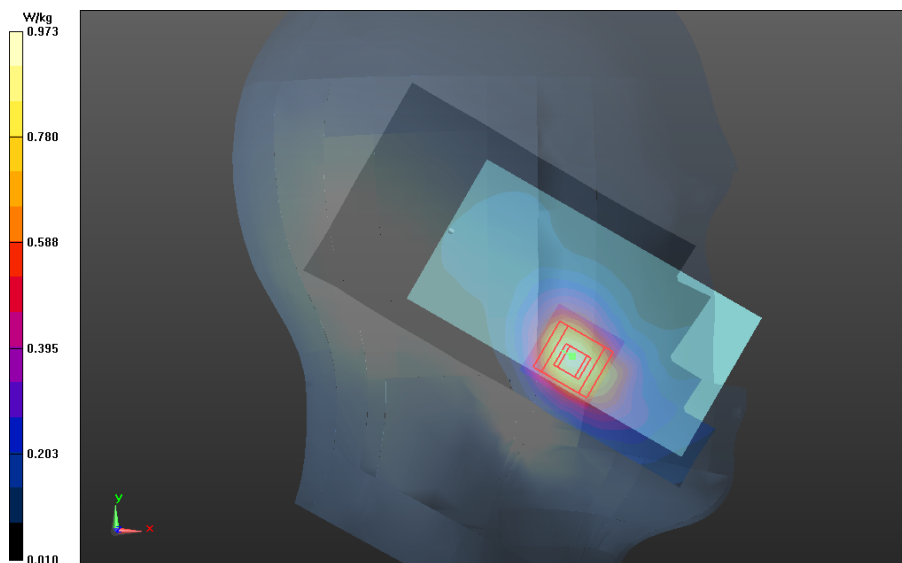

0.6-2GHz, Left Head Template

Date/Time: 7/27/2013 11:28:23 AM

## Test Lab: Motorola Mobility

**DUT Serial: LDXU220303;**

Test Configuration: Tilt

**DASY Configuration:**

- Probe: EX3DV4 - SN3730; ConvF(6.9,6.9,6.9); Calibrated: 8/24/2012;
- Sensor-Surface: 4 mm (Mechanical Surface Detection)
- Electronics: DAE4 Sn784; Calibrated: 3/6/2013
- Phantom: R#3, 2450 WiFi SAM (extended range), Rev.2 (24-Feb-12); Type: SAM v4.0; Serial: TP-1153
- DASY52 52.8.7(1137); SEMCAD X Version 14.6.10 (7164)

Communication System: \_Wi-Fi 2450MHz (0); Communication System Band: 2450MHz WIFI;  
Frequency: 2437 MHz; Duty Cycle: 1:1.000

Medium Parameters used:  $f=2437$  MHz;  $\sigma = 1.747$ ;  $\epsilon_r = 36.87$  mho/m;  $\rho = 1.000$  kg/m<sup>3</sup>

**2-3GHz Right Head Template/10mm, Area Scan (91x241x1):****Interpolated grid: dx=1.000 mm, dy=1.000 mm**

Fast SAR: SAR(1g) = 0.492 W/kg; SAR(10g) = 0.228 W/kg

**2-3GHz Right Head Template/7x7x7 Zoom Scan (2-3GHz) (31x31x36)/Cube 0:****Interpolated grid: dx=1.000 mm, dy=1.000 mm, dz=1.000 mm**

Reference Value = 17.193 V/m, Power Drift = 0.011 dB

Averaged SAR: SAR(1g) = 0.504 W/kg; SAR(10g) = 0.227 W/kg

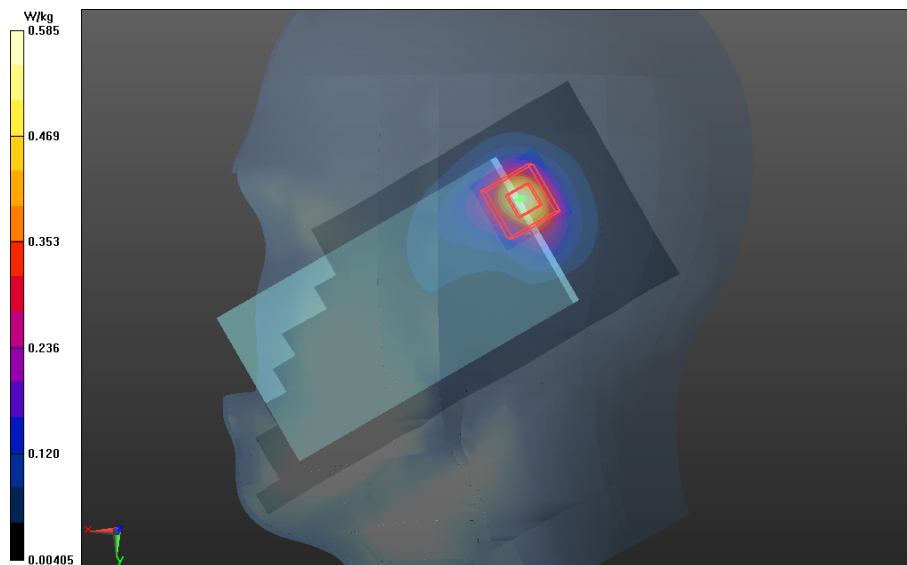
**2-3GHz Right Head Template**

## **Appendix 3**

### **SAR Distribution Plots for Body-Worn Accessory Test Results**

Date/Time: 8/7/2013 5:24:35 PM

## Test Lab: Motorola Mobility

### DUT Serial: LDXU220015;

Antenna: Internal;

Test Configuration: Body Worn, Front of Phone from Phantom

### DASY Configuration:

- Probe: ES3DV3 - SN3180; ConvF(6.05,6.05,6.05); Calibrated: 2/11/2013;
- Sensor-Surface: 4 mm (Mechanical Surface Detection)
- Electronics: DAE4 Sn661; Calibrated: 5/21/2013
- Phantom: R#-1, Triple Flat Phantom 5.1C (Rev.4); Type: QD 000 P51 CA; Serial: n/a
- DASY52 52.8.7(1137); SEMCAD X Version 14.6.10 (7164)

Communication System: \_GPRS Class 10 (0); Communication System Band: 850 MHz; Frequency: 836.6 MHz; Duty Cycle: 1:4.150

Medium Parameters used:  $f=836.6$  MHz;  $\sigma = 0.9994$ ;  $\epsilon_r = 54.02$  mho/m;  $\rho = 1.000$  kg/m<sup>3</sup>

### 0.6-2GHz Triple Flat Phone Template/Area Scan (15mm), not for EDGES (181x101x1): Interpolated grid: dx=1.500 mm, dy=1.500 mm

Fast SAR: SAR(1g) = 0.612 W/kg; SAR(10g) = 0.433 W/kg

### 0.6-2GHz Triple Flat Phone Template/5x5x7 Zoom Scan (0.6-2GHz) (21x21x36)/Cube 0: Interpolated grid: dx=1.600 mm, dy=1.600 mm, dz=1.000 mm

Reference Value = 25.886 V/m, Power Drift = -0.132 dB

Averaged SAR: SAR(1g) = 0.641 W/kg; SAR(10g) = 0.478 W/kg

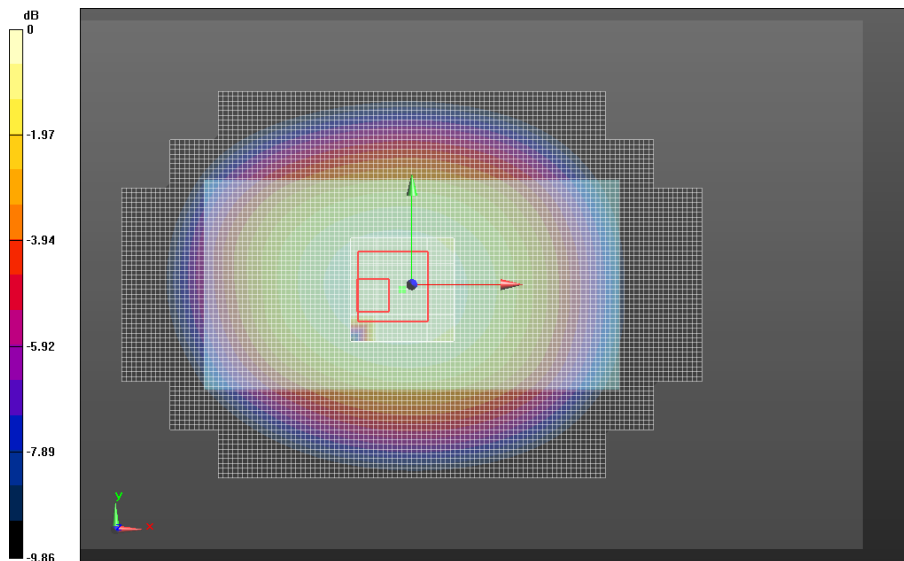

0.6-2GHz Triple Flat Phone Template

Date/Time: 8/7/2013 5:53:42 PM

## Test Lab: Motorola Mobility

### DUT Serial: LDXU220015;

Antenna: Internal;

Test Configuration: Body Worn, Back of Phone from Phantom

### DASY Configuration:

- Probe: ES3DV3 - SN3180; ConvF(4.78,4.78,4.78); Calibrated: 2/11/2013;
- Sensor-Surface: 4 mm (Mechanical Surface Detection)
- Electronics: DAE4 Sn661; Calibrated: 5/21/2013
- Phantom: R#-1, Triple Flat Phantom 5.1C (Rev.4); Type: QD 000 P51 CA; Serial: n/a
- DASY52 52.8.7(1137); SEMCAD X Version 14.6.10 (7164)

Communication System: \_GPRS Class 10 (0); Communication System Band: 1900 MHz; Frequency: 1880 MHz; Duty Cycle: 1:4.150

Medium Parameters used:  $f=1880$  MHz;  $\sigma = 1.548$ ;  $\epsilon_r = 51.99$  mho/m;  $\rho = 1.000$  kg/m<sup>3</sup>

### 0.6-2GHz Triple Flat Phone Template/Area Scan (15mm), not for EDGES (181x101x1): Interpolated grid: dx=1.500 mm, dy=1.500 mm

Fast SAR: SAR(1g) = 0.706 W/kg; SAR(10g) = 0.378 W/kg

### 0.6-2GHz Triple Flat Phone Template/5x5x7 Zoom Scan (0.6-2GHz) (21x21x36)/Cube 0: Interpolated grid: dx=1.600 mm, dy=1.600 mm, dz=1.000 mm

Reference Value = 16.967 V/m, Power Drift = -0.146 dB

Averaged SAR: SAR(1g) = 0.711 W/kg; SAR(10g) = 0.409 W/kg

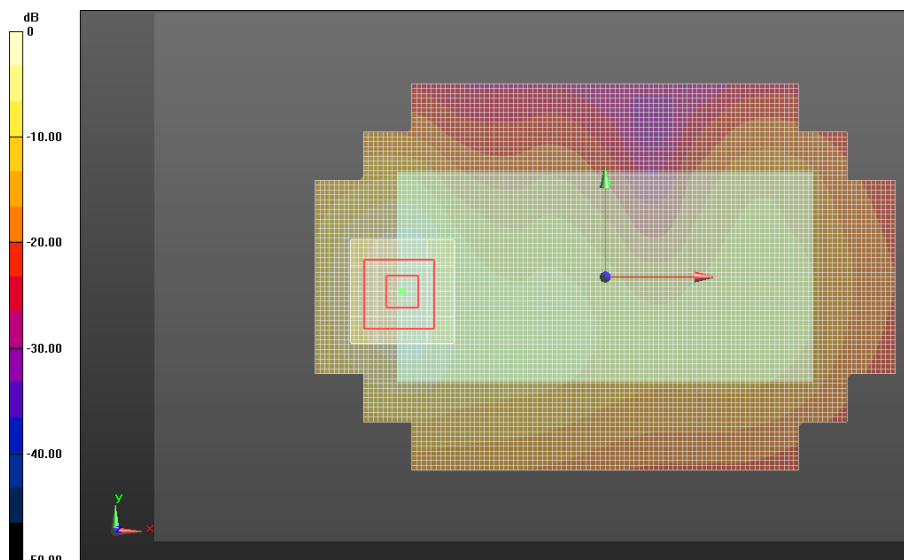

0.6-2GHz Triple Flat Phone Template

Date/Time: 7/25/2013 5:21:04 PM

## Test Lab: Motorola Mobility

### DUT Serial: LDXU220297;

Antenna: Internal;

Test Configuration: Body Worn, Back of Phone from Phantom

### DASY Configuration:

- Probe: ES3DV3 - SN3124; ConvF(6.02,6.02,6.02); Calibrated: 8/20/2012;
- Sensor-Surface: 4 mm (Mechanical Surface Detection)
- Electronics: DAE4 Sn376; Calibrated: 9/3/2012
- Phantom: R#2 Triple Flat Phantom 5.1C (Rev.4); Type: QD 000 P51 CA; Serial: n/a
- DASY52 52.8.7(1137); SEMCAD X Version 14.6.10 (7164)

Communication System: \_WCDMA (0); Communication System Band: WCDMA-850, Band 5;  
Frequency: 846.6 MHz; Duty Cycle: 1:1.000

Medium Parameters used:  $f=846.6$  MHz;  $\sigma = 1.010$ ;  $\epsilon_r = 53.43$  mho/m;  $\rho = 1.000$  kg/m<sup>3</sup>

### 0.6-2GHz Triple Flat Phone Template/Area Scan (15mm), not for EDGES (181x101x1): Interpolated grid: dx=1.500 mm, dy=1.500 mm

Fast SAR: SAR(1g) = 0.704 W/kg; SAR(10g) = 0.492 W/kg

### 0.6-2GHz Triple Flat Phone Template/5x5x7 Zoom Scan (0.6-2GHz) (21x21x36)/Cube 0: Interpolated grid: dx=1.600 mm, dy=1.600 mm, dz=1.000 mm

Reference Value = 27.241 V/m, Power Drift = -0.041 dB

Averaged SAR: SAR(1g) = 0.708 W/kg; SAR(10g) = 0.530 W/kg

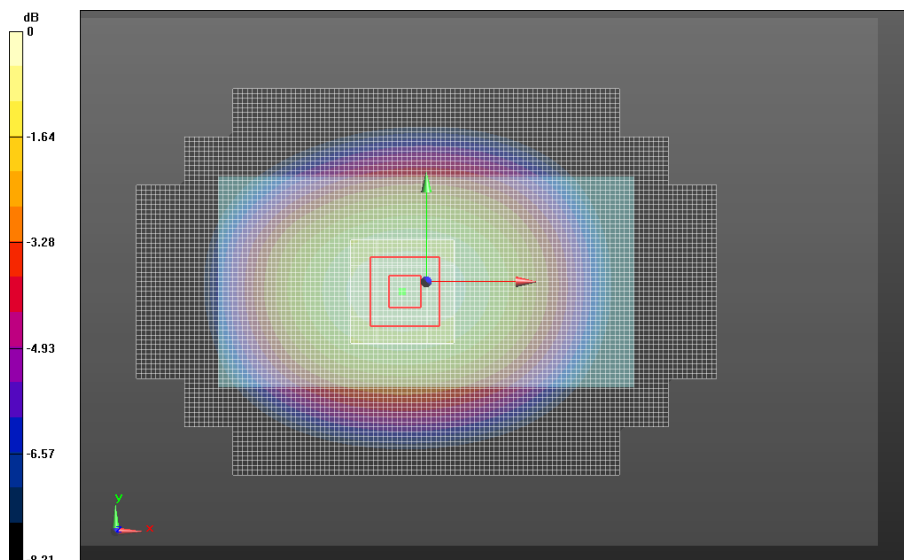

0.6-2GHz Triple Flat Phone Template

Date/Time: 7/26/2013 3:39:08 PM

## Test Lab: Motorola Mobility

### DUT Serial: LDXU220297;

Antenna: Internal;

Test Configuration: Body Worn, Back of Phone from Phantom

### DASY Configuration:

- Probe: ES3DV3 - SN3124; ConvF(4.76,4.76,4.76); Calibrated: 8/20/2012;
- Sensor-Surface: 4 mm (Mechanical Surface Detection)
- Electronics: DAE4 Sn376; Calibrated: 9/3/2012
- Phantom: R#2 Triple Flat Phantom 5.1C (Rev.4); Type: QD 000 P51 CA; Serial: n/a
- DASY52 52.8.7(1137); SEMCAD X Version 14.6.10 (7164)

Communication System: \_WCDMA (0); Communication System Band: WCDMA-1700, Band 4;  
Frequency: 1752 MHz; Duty Cycle: 1:1.000

Medium Parameters used:  $f=1752$  MHz;  $\sigma = 1.492$ ;  $\epsilon_r = 50.65$  mho/m;  $\rho = 1.000$  kg/m<sup>3</sup>

### 0.6-2GHz Triple Flat Phone Template/Area Scan (15mm), not for EDGES (181x101x1): Interpolated grid: dx=1.500 mm, dy=1.500 mm

Fast SAR: SAR(1g) = 0.492 W/kg; SAR(10g) = 0.274 W/kg

### 0.6-2GHz Triple Flat Phone Template/5x5x7 Zoom Scan (0.6-2GHz) (21x21x36)/Cube 0: Interpolated grid: dx=1.600 mm, dy=1.600 mm, dz=1.000 mm

Reference Value = 17.053 V/m, Power Drift = -0.066 dB

Averaged SAR: SAR(1g) = 0.503 W/kg; SAR(10g) = 0.290 W/kg

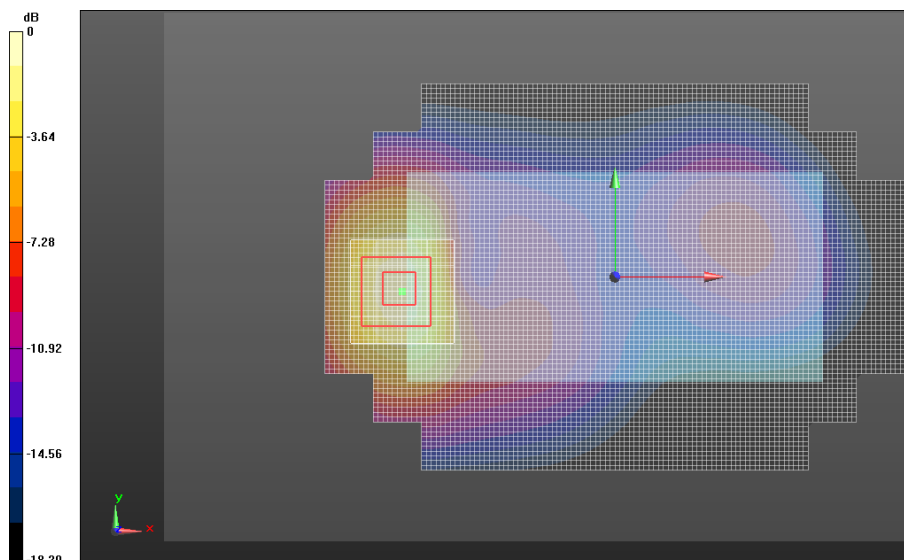

0.6-2GHz Triple Flat Phone Template

Date/Time: 7/26/2013 11:27:46 PM

## Test Lab: Motorola Mobility

**DUT Serial: LDXU220297;**

Antenna: Internal;

Test Configuration: Body Worn, Back of Phone from Phantom

### DASY Configuration:

- Probe: ES3DV3 - SN3124; ConvF(4.76,4.76,4.76); Calibrated: 8/20/2012;
- Sensor-Surface: 4 mm (Mechanical Surface Detection)
- Electronics: DAE4 Sn376; Calibrated: 9/3/2012
- Phantom: R#2 Triple Flat Phantom 5.1C (Rev.4); Type: QD 000 P51 CA; Serial: n/a
- DASY52 52.8.7(1137); SEMCAD X Version 14.6.10 (7164)

Communication System: \_WCDMA (0); Communication System Band: WCDMA-1900, Band 2;  
Frequency: 1908 MHz; Duty Cycle: 1:1.000

Medium Parameters used:  $f=1907.6$  MHz;  $\sigma = 1.572$ ;  $\epsilon_r = 52.50$  mho/m;  $\rho = 1.000$  kg/m<sup>3</sup>

**0.6-2GHz Triple Flat Phone Template/Area Scan (15mm), not for EDGES (181x101x1):  
Interpolated grid: dx=1.500 mm, dy=1.500 mm**

Fast SAR: SAR(1g) = 0.781 W/kg; SAR(10g) = 0.430 W/kg

**0.6-2GHz Triple Flat Phone Template/5x5x7 Zoom Scan (0.6-2GHz) (21x21x36)/Cube 0:  
Interpolated grid: dx=1.600 mm, dy=1.600 mm, dz=1.000 mm**

Reference Value = 19.616 V/m, Power Drift = -0.048 dB

Averaged SAR: SAR(1g) = 0.806 W/kg; SAR(10g) = 0.461 W/kg

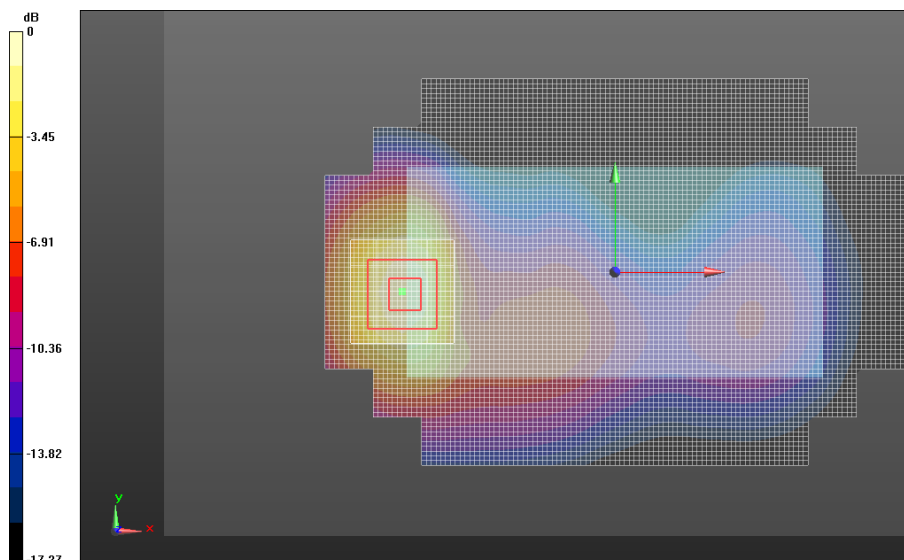

**0.6-2GHz Triple Flat Phone Template**

Date/Time: 7/26/2013 9:37:52 PM

## Test Lab: Motorola Mobility

**DUT Serial: LDXU220303;**

Test Configuration: Body Worn, Back of Phone 15 mm from Phantom

### DASY Configuration:

- Probe: EX3DV4 - SN3730; ConvF(6.86,6.86,6.86); Calibrated: 8/24/2012;
- Sensor-Surface: 4 mm (Mechanical Surface Detection)
- Electronics: DAE4 Sn784; Calibrated: 3/6/2013
- Phantom: R#-3, Triple Flat Phantom 5.1C (Rev.4); Type: QD 000 P51 CA; Serial: n/a
- DASY52 52.8.7(1137); SEMCAD X Version 14.6.10 (7164)

Communication System: \_Wi-Fi 2450MHz (0); Communication System Band: 2450MHz WIFI;  
Frequency: 2437 MHz; Duty Cycle: 1:1.000

Medium Parameters used:  $f=2437$  MHz;  $\sigma = 1.938$ ;  $\epsilon_r = 49.91$  mho/m;  $\rho = 1.000$  kg/m<sup>3</sup>

### 2-3GHz Triple Flat Phone Template/Area Scan (10mm) (261x141x1):

**Interpolated grid: dx=1.000 mm, dy=1.000 mm**

Fast SAR: SAR(1g) = 0.114 W/kg; SAR(10g) = 0.0622 W/kg

### 2-3GHz Triple Flat Phone Template/7x7x7 Zoom Scan (2-3GHz) (31x31x36)/Cube 0:

**Interpolated grid: dx=1.000 mm, dy=1.000 mm, dz=1.000 mm**

Reference Value = 7.447 V/m, Power Drift = 0.090 dB

Averaged SAR: SAR(1g) = 0.115 W/kg; SAR(10g) = 0.0640 W/kg

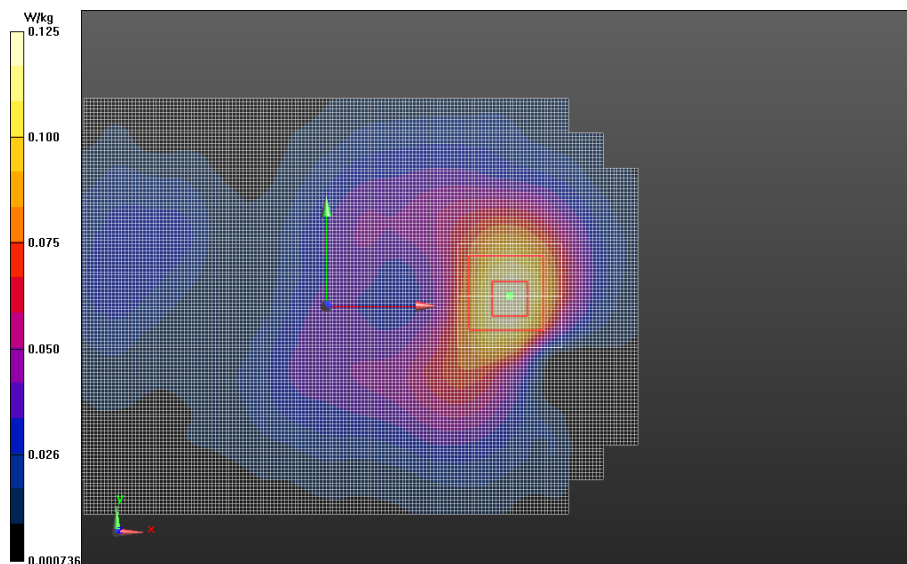

**2-3GHz Triple Flat Phone Template**

## **Appendix 4**

### **SAR Distribution Plots for Mobile Hotspot Test Results**

Date/Time: 8/6/2013 11:37:42 PM

### Test Lab: Motorola Mobility

DUT Serial: LDXU220002;

Test Configuration: Back of Phone 10 mm from Phantom

**DASY Configuration:**

- Probe: ES3DV3 - SN3180; ConvF(6.05,6.05,6.05); Calibrated: 2/11/2013;
- Sensor-Surface: 4 mm (Mechanical Surface Detection)
- Electronics: DAE4 Sn661; Calibrated: 5/21/2013
- Phantom: R#-1, Triple Flat Phantom 5.1C (Rev.4); Type: QD 000 P51 CA; Serial: n/a
- DASY52 52.8.7(1137); SEMCAD X Version 14.6.10 (7164)

Communication System: \_GPRS Class 10 (0); Communication System Band: 850 MHz; Frequency: 836.6 MHz; Duty Cycle: 1:4.150

Medium Parameters used:  $f=836.6$  MHz;  $\sigma = 0.9992$ ;  $\epsilon_r = 54.03$  mho/m;  $\rho = 1.000$  kg/m<sup>3</sup>

**0.6-2GHz Triple Flat Phone Template/Area Scan (15mm), not for EDGES (181x101x1):**

**Interpolated grid: dx=1.500 mm, dy=1.500 mm**

Fast SAR: SAR(1g) = 0.435 W/kg; SAR(10g) = 0.304 W/kg

**0.6-2GHz Triple Flat Phone Template/5x5x7 Zoom Scan (0.6-2GHz) (21x21x36)/Cube 0:**

**Interpolated grid: dx=1.600 mm, dy=1.600 mm, dz=1.000 mm**

Reference Value = 21.158 V/m, Power Drift = -0.046 dB

Averaged SAR: SAR(1g) = 0.434 W/kg; SAR(10g) = 0.329 W/kg

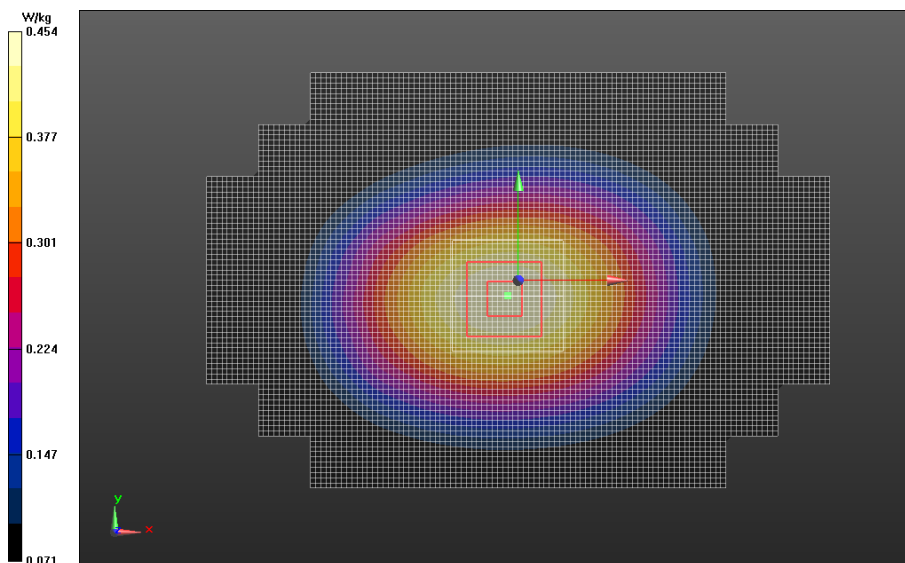

**0.6-2GHz Triple Flat Phone Template**

Date/Time: 8/6/2013 6:36:54 PM

## Test Lab: Motorola Mobility

### DUT Serial: LDXU220002;

Antenna: Internal;

Test Configuration: Bottom Edge of Phone 10 mm from Phantom

### DASY Configuration:

- Probe: ES3DV3 - SN3180; ConvF(4.78,4.78,4.78); Calibrated: 2/11/2013;
- Sensor-Surface: 4 mm (Mechanical Surface Detection)
- Electronics: DAE4 Sn661; Calibrated: 5/21/2013
- Phantom: R#-1, Triple Flat Phantom 5.1C (Rev.4); Type: QD 000 P51 CA; Serial: n/a
- DASY52 52.8.7(1137); SEMCAD X Version 14.6.10 (7164)

Communication System: \_GPRS Class 10 (0); Communication System Band: 1900 MHz; Frequency: 1880 MHz; Duty Cycle: 1:4.150

Medium Parameters used:  $f=1880$  MHz;  $\sigma = 1.544$ ;  $\epsilon_r = 52.52$  mho/m;  $\rho = 1.000$  kg/m<sup>3</sup>

### 0.6-2GHz Triple Flat Phone Template/Area Scan (10mm) (261x141x1):

Interpolated grid:  $dx=1.000$  mm,  $dy=1.000$  mm

Fast SAR: SAR(1g) = 1.30 W/kg; SAR(10g) = 0.642 W/kg

### 0.6-2GHz Triple Flat Phone Template/5x5x7 Zoom Scan (0.6-2GHz) (21x21x36)/Cube 0:

Interpolated grid:  $dx=1.600$  mm,  $dy=1.600$  mm,  $dz=1.000$  mm

Reference Value = 27.471 V/m, Power Drift = -0.079 dB

Averaged SAR: SAR(1g) = 1.29 W/kg; SAR(10g) = 0.655 W/kg

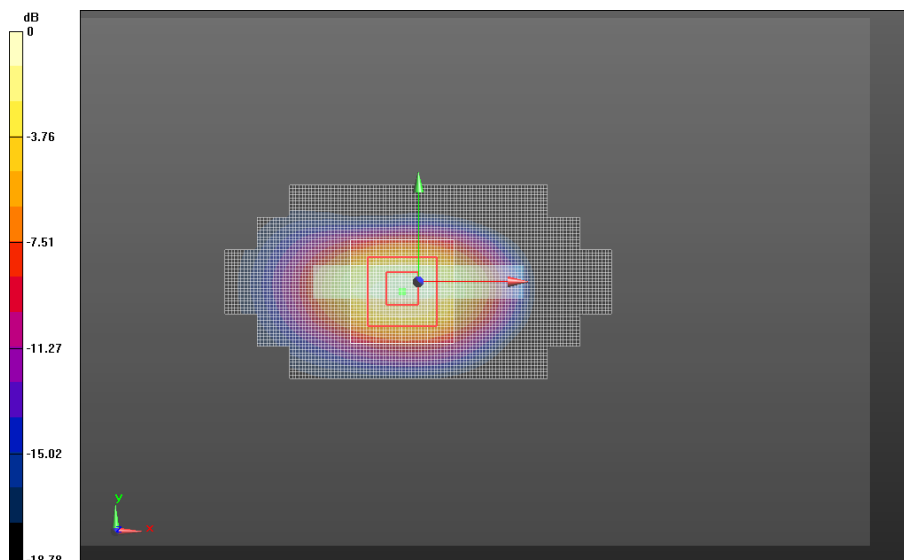

0.6-2GHz Triple Flat Phone Template

Date/Time: 7/25/2013 9:14:21 PM

## Test Lab: Motorola Mobility

**DUT Serial: LDXU220297;**

Antenna: Internal;

Test Configuration: Back of Phone 10 mm from Phantom

### DASY Configuration:

- Probe: ES3DV3 - SN3124; ConvF(6.02,6.02,6.02); Calibrated: 8/20/2012;
- Sensor-Surface: 4 mm (Mechanical Surface Detection)
- Electronics: DAE4 Sn376; Calibrated: 9/3/2012
- Phantom: R#2 Triple Flat Phantom 5.1C (Rev.4); Type: QD 000 P51 CA; Serial: n/a
- DASY52 52.8.7(1137); SEMCAD X Version 14.6.10 (7164)

Communication System: \_WCDMA (0); Communication System Band: WCDMA-850, Band 5;  
Frequency: 836.0 MHz; Duty Cycle: 1:1.000

Medium Parameters used:  $f=836$  MHz;  $\sigma = 0.9983$ ;  $\epsilon_r = 53.54$  mho/m;  $\rho = 1.000$  kg/m<sup>3</sup>

**0.6-2GHz Triple Flat Phone Template/Area Scan (15mm), not for EDGES (181x101x1):**  
**Interpolated grid: dx=1.500 mm, dy=1.500 mm**

Fast SAR: SAR(1g) = 0.445 W/kg; SAR(10g) = 0.311 W/kg

**0.6-2GHz Triple Flat Phone Template/5x5x7 Zoom Scan (0.6-2GHz) (21x21x36)/Cube 0:**  
**Interpolated grid: dx=1.600 mm, dy=1.600 mm, dz=1.000 mm**

Reference Value = 21.909 V/m, Power Drift = -0.024 dB

Averaged SAR: SAR(1g) = 0.445 W/kg; SAR(10g) = 0.337 W/kg

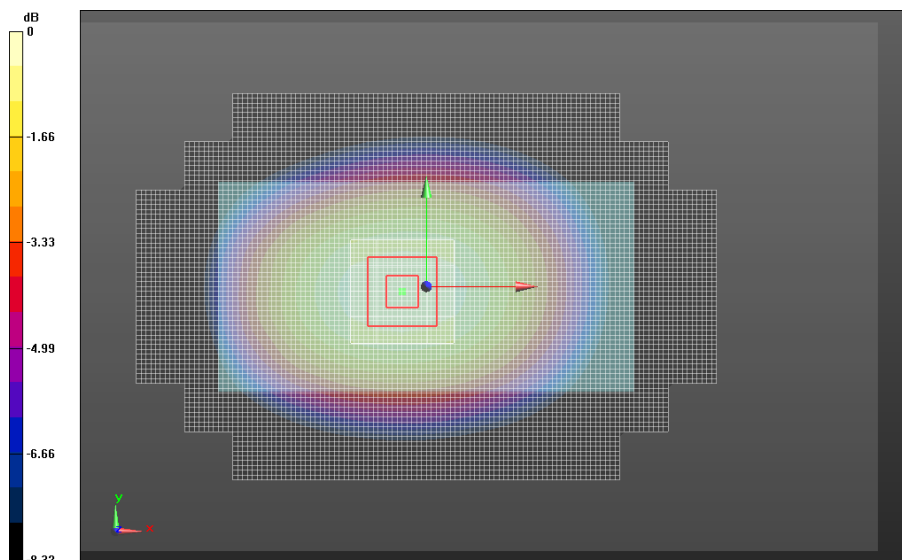

**0.6-2GHz Triple Flat Phone Template**

Date/Time: 7/26/2013 12:48:09 PM

## Test Lab: Motorola Mobility

**DUT Serial: LDXU220297;**

Antenna: Internal;

Test Configuration: Bottom Edge of Phone 10 mm from Phantom

### DASY Configuration:

- Probe: ES3DV3 - SN3124; ConvF(4.76,4.76,4.76); Calibrated: 8/20/2012;
- Sensor-Surface: 4 mm (Mechanical Surface Detection)
- Electronics: DAE4 Sn376; Calibrated: 9/3/2012
- Phantom: R#2 Triple Flat Phantom 5.1C (Rev.4); Type: QD 000 P51 CA; Serial: n/a
- DASY52 52.8.7(1137); SEMCAD X Version 14.6.10 (7164)

Communication System: \_WCDMA (0); Communication System Band: WCDMA-1700, Band 4;  
Frequency: 1752 MHz; Duty Cycle: 1:1.000

Medium Parameters used:  $f=1752$  MHz;  $\sigma = 1.492$ ;  $\epsilon_r = 50.65$  mho/m;  $\rho = 1.000$  kg/m<sup>3</sup>

### 0.6-2GHz Triple Flat Phone Template/Area Scan (10mm) (261x141x1):

**Interpolated grid: dx=1.000 mm, dy=1.000 mm**

Fast SAR: SAR(1g) = 1.13 W/kg; SAR(10g) = 0.561 W/kg

### 0.6-2GHz Triple Flat Phone Template/5x5x7 Zoom Scan (0.6-2GHz) (21x21x36)/Cube 0:

**Interpolated grid: dx=1.600 mm, dy=1.600 mm, dz=1.000 mm**

Reference Value = 23.412 V/m, Power Drift = -0.032 dB

Averaged SAR: SAR(1g) = 1.11 W/kg; SAR(10g) = 0.564 W/kg

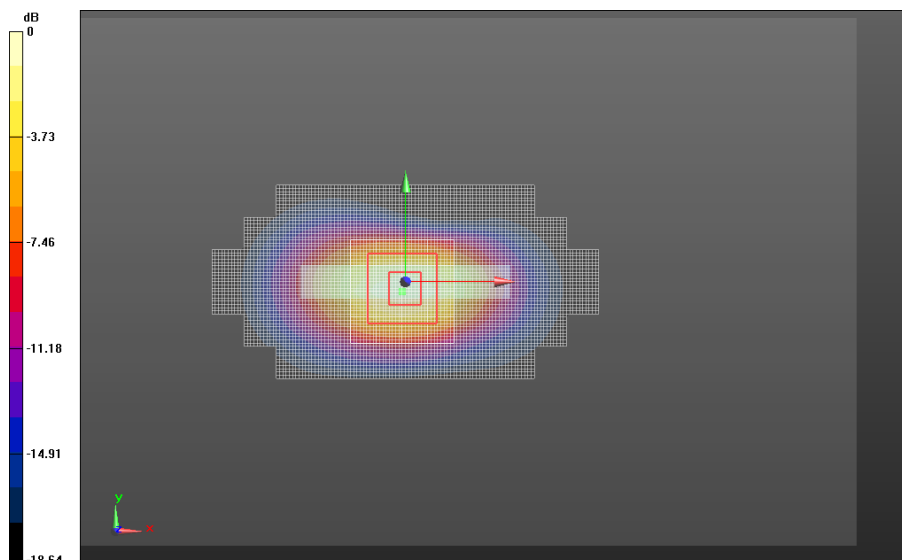

**0.6-2GHz Triple Flat Phone Template**

Date/Time: 7/26/2013 9:16:24 PM

## Test Lab: Motorola Mobility

**DUT Serial: LDXU220297;**

Antenna: Internal;

Test Configuration: Bottom Edge of Phone 10 mm from Phantom

**DASY Configuration:**

- Probe: ES3DV3 - SN3124; ConvF(4.76,4.76,4.76); Calibrated: 8/20/2012;
- Sensor-Surface: 4 mm (Mechanical Surface Detection)
- Electronics: DAE4 Sn376; Calibrated: 9/3/2012
- Phantom: R#2 Triple Flat Phantom 5.1C (Rev.4); Type: QD 000 P51 CA; Serial: n/a
- DASY52 52.8.7(1137); SEMCAD X Version 14.6.10 (7164)

Communication System: \_WCDMA (0); Communication System Band: WCDMA-1900, Band 2;  
Frequency: 1908 MHz; Duty Cycle: 1:1.000

Medium Parameters used:  $f=1907.6$  MHz;  $\sigma = 1.572$ ;  $\epsilon_r = 52.50$  mho/m;  $\rho = 1.000$  kg/m<sup>3</sup>

**0.6-2GHz Triple Flat Phone Template/Area Scan (10mm) (261x141x1):****Interpolated grid: dx=1.000 mm, dy=1.000 mm**

Fast SAR: SAR(1g) = 0.816 W/kg; SAR(10g) = 0.403 W/kg

**0.6-2GHz Triple Flat Phone Template/5x5x7 Zoom Scan (0.6-2GHz) (21x21x36)/Cube 0:****Interpolated grid: dx=1.600 mm, dy=1.600 mm, dz=1.000 mm**

Reference Value = 21.167 V/m, Power Drift = -0.023 dB

Averaged SAR: SAR(1g) = 0.814 W/kg; SAR(10g) = 0.413 W/kg

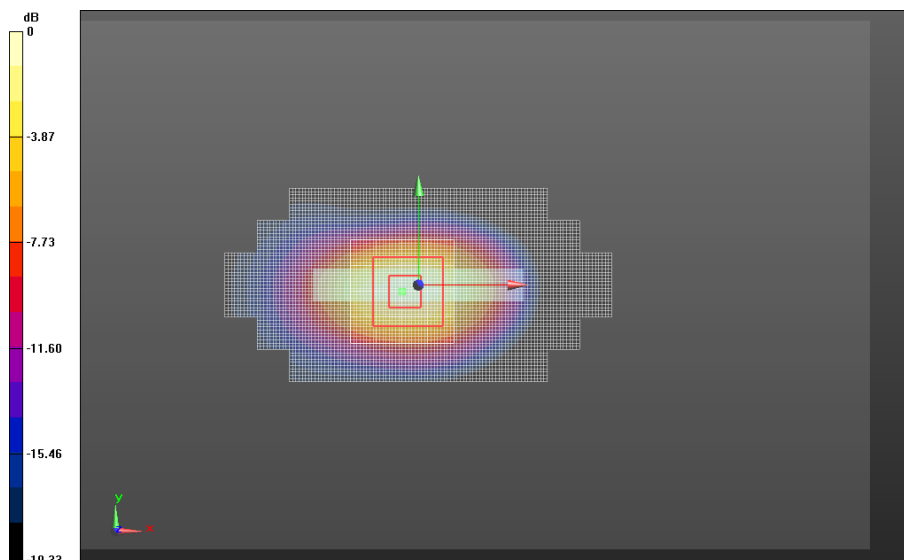
**0.6-2GHz Triple Flat Phone Template**

Date/Time: 7/26/2013 9:00:15 PM

### Test Lab: Motorola Mobility

DUT Serial: LDXU220303;

Test Configuration: Back of Phone 10 mm from Phantom

**DASY Configuration:**

- Probe: EX3DV4 - SN3730; ConvF(6.86,6.86,6.86); Calibrated: 8/24/2012;
- Sensor-Surface: 4 mm (Mechanical Surface Detection)
- Electronics: DAE4 Sn784; Calibrated: 3/6/2013
- Phantom: R#-3, Triple Flat Phantom 5.1C (Rev.4); Type: QD 000 P51 CA; Serial: n/a
- DASY52 52.8.7(1137); SEMCAD X Version 14.6.10 (7164)

Communication System: \_Wi-Fi 2450MHz (0); Communication System Band: 2450MHz WIFI;  
 Frequency: 2437 MHz; Duty Cycle: 1:1.000

Medium Parameters used: f=2437 MHz;  $\sigma = 1.938$ ;  $\epsilon_r = 49.91$  mho/m;  $\rho = 1.000$  kg/m<sup>3</sup>

**2-3GHz Triple Flat Phone Template/Area Scan (10mm) (261x141x1):**

**Interpolated grid: dx=1.000 mm, dy=1.000 mm**

Fast SAR: SAR(1g) = 0.241 W/kg; SAR(10g) = 0.124 W/kg

**2-3GHz Triple Flat Phone Template/7x7x7 Zoom Scan (2-3GHz) (31x31x36)/Cube 0:**

**Interpolated grid: dx=1.000 mm, dy=1.000 mm, dz=1.000 mm**

Reference Value = 9.897 V/m, Power Drift = 0.134 dB

Averaged SAR: SAR(1g) = 0.242 W/kg; SAR(10g) = 0.124 W/kg

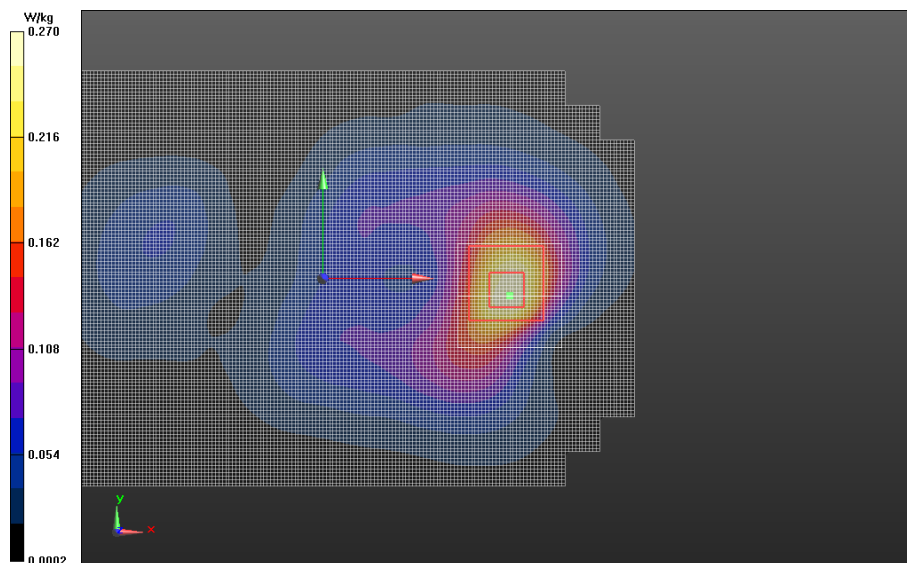

**2-3GHz Triple Flat Phone Template**

## **Appendix 5**

### **Measurement Uncertainty Budget**

**Uncertainty Budget for Device Under Test, for 735 MHz to 3 GHz**

<i>a</i>	<i>b</i>	<i>c</i>	<i>d</i>	<i>e = f(d,k)</i>	<i>f</i>	<i>g</i>	<i>h = c x f / e</i>	<i>i = c x g / e</i>	<i>k</i>
<b>Uncertainty Component</b>	Description IEEE 1528(2003) / IEC 62209-1(2005)	Tol. (± %)	Prob Dist	Div.	<i>c<sub>f</sub></i> (1 g)	<i>c<sub>g</sub></i> (10 g)	1 g <i>u<sub>f</sub></i> (±%)	10 g <i>u<sub>g</sub></i> (±%)	<i>v<sub>i</sub></i>
<b>Measurement System</b>									
Probe Calibration [ES3DV3]	E.2.1 / 7.2.1	6.0	N	1.00	1	1	6.0	6.0	∞
Axial Isotropy	E.2.2 / 7.2.1.2	4.7	R	1.73	0.707	0.707	1.9	1.9	∞
Hemispherical Isotropy	E.2.2 / 7.2.1.2	9.6	R	1.73	0.707	0.707	3.9	3.9	∞
Boundary Effect	E.2.3 / 7.2.1.5	1.0	R	1.73	1	1	0.6	0.6	∞
Linearity	E.2.4 / 7.2.1.3	4.7	R	1.73	1	1	2.7	2.7	∞
System Detection Limits	E.2.5 / 7.2.1.4	1.0	R	1.73	1	1	0.6	0.6	∞
Readout Electronics	E.2.6 / 7.2.1.6	0.3	N	1.00	1	1	0.3	0.3	∞
Response Time	E.2.7 / 7.2.1.7	1.1	R	1.73	1	1	0.6	0.6	∞
Integration Time	E.2.8 / 7.2.1.8	1.1	R	1.73	1	1	0.6	0.6	∞
RF Ambient Conditions - Noise	E.6.1 / 7.2.3.6	3.0	R	1.73	1	1	1.7	1.7	∞
RF Ambient Conditions - Reflections	E.6.1 / 7.2.3.6	3.0	R	1.73	1	1	1.7	1.7	∞
Probe Positioner Mech. Tolerance	E.6.2 / 7.2.2.1	0.4	R	1.73	1	1	0.2	0.2	∞
Probe Positioning w.r.t Phantom	E.6.3 / 7.2.2.3	2.9	R	1.73	1	1	1.7	1.7	∞
Max. SAR Evaluation (ext., int., avg.)	E.5 / 7.2.4	3.4	R	1.73	1	1	2.0	2.0	∞
<b>Test sample Related</b>									
Test Sample Positioning	E.4.2 / 7.2.2.4	3.4	N	1.00	1	1	3.4	3.4	79
Device Holder Uncertainty	E.4.1 / 7.2.2.4.2	4.5	N	1.00	1	1	4.5	4.5	11
SAR drift	6.6.2 / 7.2.3.5	0.0	R	1.73	1	1	0.0	0.0	∞
<b>Phantom and Tissue Parameters</b>									
Phantom Uncertainty	E.3.1 / 7.2.2.2	6.1	R	1.73	1	1	3.5	3.5	∞
SAR Correction		1.9	R	1.73	1	0.84	1.1	0.9	∞
Liquid Conductivity (measurement)	E.3.3 / 7.2.3.3	1.3	N	1.00	0.64	0.43	0.9	0.6	6
Liquid Permittivity (measurement)	E.3.2 / 7.2.3.4	0.7	N	1.00	0.6	0.49	0.4	0.3	6
<b>Combined Standard Uncertainty</b>				RSS			11	11	390
<b>Expanded Uncertainty</b> (95% CONFIDENCE LEVEL)				<i>k</i> =2			22	22	