



HAC Test Report for Near Field Emissions IHDT56PE2

Tests Requested By: Motorola Mobility, LLC
600 N. US Highway 45
Libertyville, IL 60048

Date of Tests: May 6, 2013 to May 8, 2013
Date of Report: June 21, 2013

Test Laboratory: Motorola Mobility, LLC - ADR Test Services Laboratory
600 N. US Highway 45
Libertyville, Illinois 60048

Report Author: Thomas Knipple
Senior Staff Test Engineer

Statement of Compliance: Motorola declares under its sole responsibility that portable cellular telephone FCC ID IHDT56PE2 to which this declaration relates, complies with recommendations and guidelines per FCC 47 CFR §20.19. The measurements were performed to ensure compliance to ANSI C63.19-2007. It also declares that the product was tested in accordance with the appropriate measurement standards, guidelines and recommended practices. Any deviations from these standards, guidelines and recommended practices are noted below:

(none)

Results Summary: M Category = M3

©Motorola Mobility, LLC 2013

This test report shall not be reproduced except in full, without written approval of the laboratory.

The results and statements contained herein relate only to the items tested. The names of individuals involved may be mentioned only in connection with the statements or results from this report.

Motorola encourages all feedback, both positive and negative, on this test report.

Table of Contents

1. INTRODUCTION3

2. DESCRIPTION OF THE DEVICE UNDER TEST.....3

3. TEST EQUIPMENT USED.....4

4. VALIDATION5

5. PROBE MODULATION FACTOR6

6. TEST RESULTS.....8

7. DEVICE CONDUCTED POWER MEASUREMENTS.....11

Appendix 1: Details justifying the conversion to peak
 A1.1 Procedure for PMF measurements
 A1.2 0-span spectrum plots for PMF measurements

Appendix 2: HAC Distribution Plots for Validation

Appendix 3: HAC Distribution Plots for E-Field and H-Field

Appendix 4: Motorola Uncertainty Budget
 A4.1 Motorola Uncertainty Budget for RF HAC testing
 A4.2 Probe Rotation Contributions to Isotropy Error

Appendix 5: Pictures of Test Setup

Appendix 6: Probe Calibration Certificates

Appendix 7: Dipole Characterization Certificates

Revision History

| Revision Version | Date | Notes |
|------------------|-------------|-------------------------|
| Rev. 0 | Jun-06-2013 | Initial report release |
| Rev. A | Jun-21-2013 | Revised per TCB inquiry |

1. Introduction

The Motorola Mobility ADR Test Services Laboratory has performed Hearing Aid Compatibility (HAC) measurements for the portable cellular phone (FCC ID IHDT56PE2). The portable cellular phone was tested in accordance with the ANSI C63.19-2007 standard. The test results presented herein clearly demonstrate compliance per FCC 47 CFR § 20.19. This report demonstrates compliance for near-field emissions only and not for Telecoil HAC performance compliance.

2. Description of the Device Under Test

Table 1: Information for the Device Under Test

| | |
|---|---------------------|
| Serial Number(s) | LUWV260010 |
| Production Unit or Identical Prototype (47 CFR §2.908) | Identical Prototype |
| Device Category | Portable |

| Mode(s) of Operation | Modulation Mode(s) | Maximum Output Power Setting | Duty Cycle | Transmitting Frequency Range(s) | Defined in C63.19-2007? | Transport Type | Voice Support via OTT Capability | Concurrent connections using Simultaneous Operation with: | Concurrent connections using other modes: | HAC Tested |
|----------------------|--------------------|------------------------------|----------------------------|---------------------------------|-------------------------|----------------|----------------------------------|---|---|-------------|
| LTE Band 4 | QPSK, 16QAM | 24.0 dBm | 1:1 | 1710 - 1755 MHz | NO | DATA | YES | CDMA, Wi-Fi, Bluetooth | None | NO |
| LTE Band 13 | QPSK, 16QAM | 24.0 dBm | 1:1 | 777 - 787 MHz | NO | DATA | YES | CDMA, Wi-Fi, Bluetooth | None | NO |
| CDMA 800 | QPSK | 25.0 dBm | 1:1 | 824.70 - 848.31 MHz | YES | VOICE/DATA | YES (1x data or EVDO) | LTE, Wi-Fi, Bluetooth | None | YES |
| CDMA 1900 | QPSK | 25.0 dBm | 1:1 | 1851.20 - 1908.75 MHz | YES | VOICE/DATA | YES (1x data or EVDO) | LTE, Wi-Fi, Bluetooth | None | YES |
| GSM 850 | GMSK | 33.5 dBm | 1:8 | 824.2 - 848.8 MHz | YES | VOICE | N/A | Wi-Fi, Bluetooth | None | YES |
| GPRS/EDGE 850 | GMSK | 33.5 dBm | 1:8.3, 2:8.3, 3:8.3, 4:8.3 | 824.2 - 848.8 MHz | NO | DATA | YES | Wi-Fi, Bluetooth | None | NO |
| EDGE 850 | 8PSK | 28.0 dBm | 1:8.3, 2:8.3, 3:8.3, 4:8.3 | 824.2 - 848.8 MHz | NO | DATA | YES | Wi-Fi, Bluetooth | None | NO |
| GSM 1900 | GMSK | 30.5 dBm | 1:8 | 1850.2 - 1909.8 MHz | YES | VOICE | N/A | Wi-Fi, Bluetooth | None | YES |
| GPRS/EDGE 1900 | GMSK | 30.5 dBm | 1:8.3, 2:8.3, 3:8.3, 4:8.3 | 1850.2 - 1909.8 MHz | NO | DATA | YES | Wi-Fi, Bluetooth | None | NO |
| EDGE 1900 | 8PSK | 27.0 dBm | 1:8.3, 2:8.3, 3:8.3, 4:8.3 | 1850.2 - 1909.8 MHz | NO | DATA | YES | Wi-Fi, Bluetooth | None | NO |
| WCDMA 850 | QPSK | 24.0 dBm | 1:1 | 826.4 - 846.6 MHz | YES | VOICE/DATA | YES (HSPA) | Wi-Fi, Bluetooth | Not Tested (Note 1) | YES |
| WCDMA 1900 | QPSK | 24.0 dBm | 1:1 | 1852.4 - 1907.6 MHz | YES | VOICE/DATA | YES (HSPA) | Wi-Fi, Bluetooth | Not Tested (Note 1) | YES |
| Wi-Fi 802.11b/g/n | BPSK | 18.20 dBm | 1:1 | 2412.0 - 2462.0 MHz | NO | DATA | YES | LTE, CDMA, GSM, GPRS/EDGE, WCDMA | None | NO (Note 2) |
| Wi-Fi 802.11a/n/ac | BPSK | 14.39 dBm | 1:1 | 5180.0 - 5240.0 MHz | NO | DATA | YES | LTE, CDMA, GSM, GPRS/EDGE, WCDMA | None | NO (Note 2) |
| Wi-Fi 802.11a/n/ac | BPSK | 13.34 dBm | 1:1 | 5745.0 - 5825.0 MHz | NO | DATA | YES | LTE, CDMA, GSM, GPRS/EDGE, WCDMA | None | NO (Note 2) |
| Bluetooth | GFSK | 8.13 dBm | 1:1 | 2402.0 - 2480.0 MHz | NO | DATA | N/A | LTE, CDMA, GSM, GPRS/EDGE, WCDMA | None | NO (Note 3) |

Note 1: Non-concurrent operation was found to be the worst-case mode, and was utilized for testing.

Note 2: Wi-Fi capability is included in this phone without measurements for hearing aid compatibility based on the interim ruling by the FCC according to paragraph 37 of the Federal Register, Volume 3, Number 89, as of May 7, 2008. Users shall be informed of this via the product user guide per the same FCC ruling.

Note 3: No Bluetooth profile exists in this phone that will allow a Bluetooth link while in a cellular call that passes audio to the earpiece. If the user had Bluetooth enabled and a link established, they could not be listening to the phone through the earpiece.

3. Test Equipment Used

The Motorola Mobility ADR Test Services Laboratory utilizes a Dosimetric Assessment System (DASY4™ v4.7) manufactured by Schmid & Partner Engineering AG (SPEAG™), of Zurich Switzerland. All the HAC measurements are taken within a shielded enclosure. The measurement uncertainty budget is given in Appendix 4. The list of calibrated equipment used for the measurements is shown below.

Table 2: Dosimetric System Equipment

| Description | Serial Number | Cal Due Date |
|--------------------------|---------------|--------------|
| E-Field Probe ER3DV6R | 2248 | Jan-11-2014 |
| DAE4 | 1313 | Jan-28-2014 |
| H-Field Probe H3DV6 | 6074 | Jan-11-2014 |
| DAE3 | 365 | Jan-28-2014 |
| 835 MHz Dipole CD835V3 | 1076 | Mar-08-2014 |
| 1880 MHz Dipole CD1880V3 | 1034 | Mar-08-2014 |

Table 3: Additional Test Equipment

| Description | Serial Number | Cal Date | Cal Due Date |
|-----------------------------|---------------|-------------|--------------|
| Power Supply 6623A | US37360829 | | |
| Signal Generator E4438C | MY45090104 | Aug-12-2011 | Aug-12-2013 |
| Amplifier ZHL-42-SMA | 1040 | | |
| 3 dB Attenuator 8491A | 50581 | Aug-15-2011 | Aug-15-2013 |
| Directional Coupler 778D | MY48220504 | Aug-29-2012 | Aug-29-2013 |
| Power Meter E4417A | MY45100481 | Oct-07-2011 | Oct-07-2013 |
| Power Sensor #1 – E9323A | MY51490002 | Jul-27-2012 | Jul-27-2013 |
| Power Sensor #2 - E9323A | MY51490001 | Jul-27-2012 | Jul-27-2013 |
| 10 dB Attenuator 8491A | MY39267955 | Jan-23-2013 | Jan-23-2015 |
| Spectrum Analyzer E4403B | MY45107934 | Aug-28-2012 | Aug-28-2013 |
| Power Splitter ZAPD-21-S(+) | SU327300437 | | |

4. Validation

Validations of the DASY4 v4.7 test system were performed using the measurement equipment listed in Section 3.1. All validations occur in free space using the DASY4 test arch. Note that the 10 mm probe-to-dipole separation is measured from the top edge of the dipole to the calibration reference point of the probe. SPEAG uses the center point of the probe sensor(s) as the reference point when establishing targets for their dipoles. Therefore, because SPEAG’s dipoles and targets are used, it is appropriate to measure the 10 mm separation distance to the center of the sensors as they do. This reference point was used for validation only. Validations were performed at 835 MHz and/or 1880 MHz. These frequencies are within each operating band and are within 2 MHz of the mid-band frequency of the test device. The results obtained from the validations are displayed in the table below. The field contour plots are included in Appendix 2.

Validations were performed to verify that measured E-field and H-field values are within ±25% from the target reference values provided by the manufacturer (Ref: Appendix 7). Per Section 4.3.2.1 of the C63.19 standard, “Values within ±25% are acceptable, of which 12% is deviation and 13% is measurement uncertainty”. Therefore, the E-field and H-field dipole verification results shown in Table 4 are in accordance with the acceptable parameters defined by the standard.

Table 4: Dipole Measurement Summary

| Date | Dipole | f (MHz) | Protocol | Input Power (mW) | E-Field Results (V/m) | Target for Dipole (V/m) | % Deviation |
|-------------|--------|---------|----------|------------------|-----------------------|-------------------------|-------------|
| May-07-2013 | 1076 | 835 | CW | 100 | 169.85 | 170.2 | -0.2% |
| May-06-2013 | 1034 | 1880 | CW | 100 | 138.7 | 141.3 | -1.8% |

| Date | Dipole | f (MHz) | Protocol | Input Power (mW) | H-Field Results (A/m) | Target for Dipole (A/m) | % Deviation |
|-------------|--------|---------|----------|------------------|-----------------------|-------------------------|-------------|
| May-07-2013 | 1076 | 835 | CW | 100 | 0.470 | 0.468 | +0.4% |
| May-06-2013 | 1034 | 1880 | CW | 100 | 0.464 | 0.464 | 0.0% |

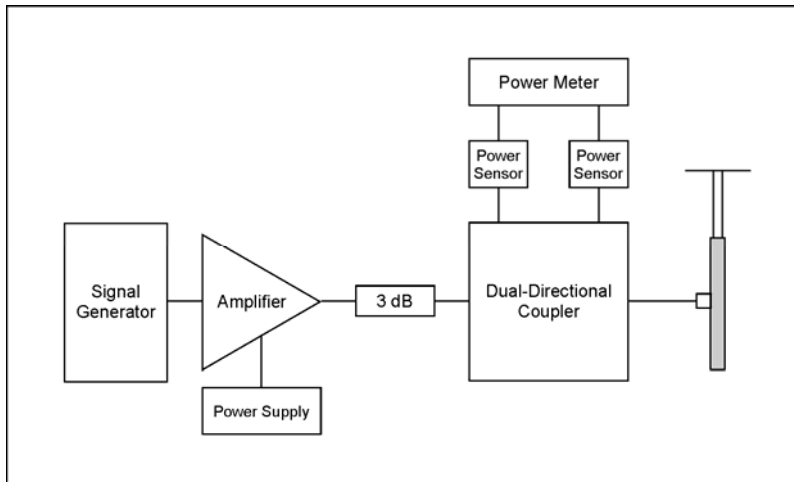

Figure 1: Setup for Validation measurements

5. Probe Modulation Factor

After every probe calibration, the response of the probe to each applicable modulated signal (CDMA, GSM, etc) must be assessed at the frequencies of operation. The response of the probe system to a CW field at each frequency of interest is compared to its response to a modulated signal with equal peak amplitude. For each PMF assessment, a signal generator was used to replace the original CW signal with the desired modulated signal. The PMF results applicable to this test document are shown in Table 5.

RF Field Probe Modulation Response was measured with the field probe and associated measurement equipment. The PMF was measured using a signal generator as follows:

1. Illuminate a dipole with a CW signal at the intended measured frequency.
2. Fix the probe at a set location relative to the dipole, typically located at the field reference point.
3. Record the reading of the probe measurement system of the CW signal.
4. Substitute a modulated signal of the same amplitude, using the same modulation as that used by the intended WD for the CW signal.
5. Record the reading of the probe measurement system of the modulated signal.
6. The ratio of the CW to modulated signal reading is the probe modulation factor.

Using a dual-directional coupler, the forward power and reverse power are measured and adjusted when connected to the dipole and spectrum analyzer through a power splitter and matched cables. The spectrum analyzer is used to set the peak amplitude of the modulated signal equal to the amplitude of the CW signal. The procedure used to ensure that the amplitudes are the same is given in Appendix 1. 0-Span spectrum plots for each signal type measured are also provided in Appendix 1.

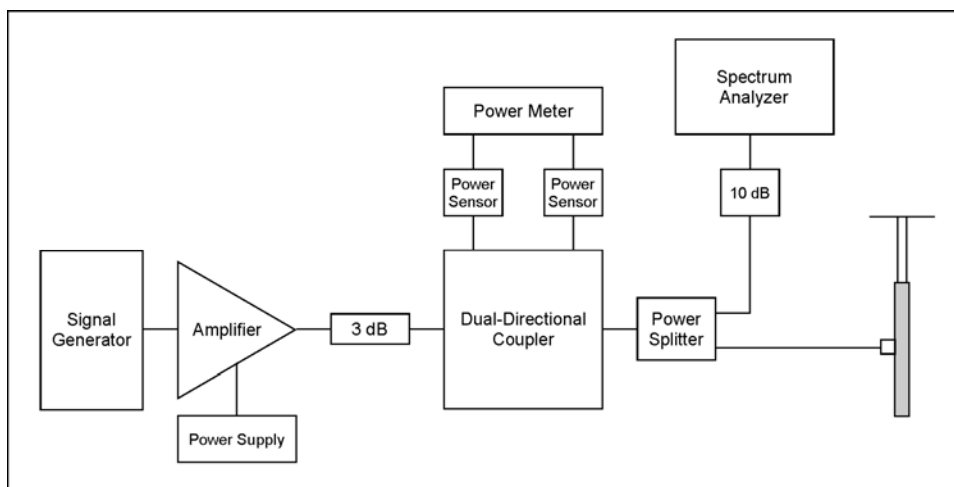

Figure 2: Setup for PMF measurements

When measuring PMFs for a GSM signal, a power level which results in a measured field strength approximately equal to the M3 category limit is used.

To measure the PMF for a CDMA, WCDMA, or iDEN signal, the modulated signal is injected into the dipole. When the peak power level produces a field strength less than or equal to the M3 category limit, this power level is used. If this peak power level produces a field strength much greater than the M3 category limit, a power level which produces a field strength approximately equal to the M3 category limit is used instead.

Table 5: PMF Measurement Summary

| f (MHz) | Protocol | E-Field Probe SN 2248 | | H-Field Probe SN 6074 | |
|------------|------------------------------|--------------------------|---------------------------------|--------------------------|---------------------------------|
| | | E-Field (V/m) | E-Field Modulation Factor | H-Field (A/m) | H-Field Modulation Factor |
| 835 | CW | 221.5 | | 0.8701 | |
| | CDMA, Full Rate | 211.4 | 1.05 | 0.8565 | 1.02 |
| | CDMA, 1/8 TH Rate | 77.34 | 2.86 | 0.3444 | 2.53 |
| 1880 | CW | 98.98 | | 0.3555 | |
| | CDMA, Full Rate | 92.88 | 1.07 | 0.3456 | 1.03 |
| | CDMA, 1/8 TH Rate | 33.86 | 2.92 | 0.1398 | 2.54 |

| f (MHz) | Protocol | E-Field Probe SN 2248 | | H-Field Probe SN 6074 | |
|------------|----------|--------------------------|---------------------------------|--------------------------|---------------------------------|
| | | E-Field (V/m) | E-Field Modulation Factor | H-Field (A/m) | H-Field Modulation Factor |
| 835 | CW | 322.9 | | 0.7964 | |
| | GSM | 116.9 | 2.76 | 0.3262 | 2.44 |
| 1880 | CW | 83.46 | | 0.2600 | |
| | GSM | 29.47 | 2.83 | 0.1009 | 2.58 |

| f (MHz) | Protocol | E-Field Probe SN 2248 | | H-Field Probe SN 6074 | |
|------------|----------|--------------------------|---------------------------------|--------------------------|---------------------------------|
| | | E-Field (V/m) | E-Field Modulation Factor | H-Field (A/m) | H-Field Modulation Factor |
| 835 | CW | 197.2 | | 0.7733 | |
| | WCDMA | 212.5 | 0.93 | 0.8385 | 0.92 |
| 1880 | CW | 98.98 | | 0.3555 | |
| | WCDMA | 105 | 0.94 | 0.3831 | 0.93 |

| (MHz) | Protocol | E-Field Probe SN 2248 | | H-Field Probe SN 6074 | |
|-------|----------|--------------------------|---------------------------------|--------------------------|---------------------------------|
| | | E-Field (V/m) | E-Field Modulation Factor | H-Field (A/m) | H-Field Modulation Factor |
| 835 | CW | 120.9 | | 0.4875 | |
| | 80% AM | 75.34 | 1.60 | 0.3132 | 1.56 |
| 1880 | CW | 139.8 | | 0.5023 | |
| | 80% AM | 87.08 | 1.61 | 0.3449 | 1.46 |

6. Test Results

The phone was tested in normal configurations for against-the-ear use. When applicable, configurations are tested with the antenna in its fully-extended position. These test configurations are tested at the high, middle and low frequency channels of each applicable operating band and mode; for example, GSM, CDMA, WCDMA, or iDEN.

For CDMA, the signal was set up by creating and maintaining an over-the-air connection between the DUT and an Agilent 8960 Wireless Communications Test Set. The CDMA radio is available on CDMA 2000(1X) and IS-95. The test equipment was configured to use "All up Bits" for RC1 / SO2 on J-STD-008 for CDMA 1900 and TSB-84 for CDMA 800 MHz.

For GSM, the DUT's signal is the typical GMSK modulated signal used for GSM calls and connections in a cellular network. The signal was set up by creating and maintaining an over-the-air connection between the DUT and an Agilent 8960 Wireless Communications Test Set. This allows direct control over the DUT's cellular band, transmit channel and power step.

For Wideband CDMA, the signal was set up by creating and maintaining an over-the-air connection between the DUT and an Agilent 8960 Wireless Communications Test Set. The test equipment was configured to all "1's" for 12.2 kbps AMR.

The phone is placed in the HAC measurement system with a fully charged battery. At the end of each test the DASY™ system measures the drift of the field strength at a fixed reference point to ensure that the DUT has not changed in transmitter power.

The DASY4 v4.7 measurement system specified in section 3.1 was utilized within the intended operations as set by the SPEAG™ setup. The default settings for the grid spacing of the scan were set to 5 mm as shown in the Field plots included in Appendix 2 and 3. The 5 cm x 5 cm area measurement grid is centered on the acoustic output of the device. The Test Arch provided by SPEAG is used to position the DUT. The pictures of the setup are included in Appendix 5. The WD reference plane is parallel to the device and contains the highest point on its contour in the area of the phone that normally rests against the user's ear. The measurement plane contains the center point of the probe sensor(s). The device is positioned such that the WD reference plane is located 15 mm from, and parallel to, the measurement plane. This is in accordance with section 4.4 of the standard, which states that "The WD reference plane is a plane parallel with the front "face" of the WD and containing the highest point on its contour in the area of the phone that normally rests against the user's ear."

During testing, the DUT is placed into a polystyrene block (3-pound expanded polystyrene) which is machined to precisely fit the DUT's shape. The test positioner, provided by SPEAG, is used to grip the block. This positioning conforms to the specifications given in the paragraph above. The addition of the block does not increase the uncertainty budget, which is provided in Appendix 4. The pictures of the measurement setup are included in Appendix 5.

The HAC Rating results for E-Field and H-field are shown in Tables 6 and 7. Also shown are the measured conducted output powers, the measured drifts, excluded areas, and the peak field values. PMF measurements are taken from Section 5. The worst-case test conditions are indicated with **bold numbers** in the tables and are detailed in Appendix 3: HAC distribution plots for E-Field and H-Field.

Drift was measured using the typical DASY4 v4.7 measurement routines. The field is measured at the reference location (center of the ear piece) at the beginning of the test. After completion of the E-field or H-field measurement, the probe returns to the same reference location and takes another measurement. The drift is the delta between these two values and is included in the test report scans.

Per SPEAG's recommendation, the phone plots in Appendix 3 use the following standard transmitter ratios as "Duty Cycle": 1:8 for GSM transmitters; 1:1 for full-rate CDMA and 1:8 for 1/8th rate CDMA; 1:1 for WCDMA; 1:6 for 1:6th rate iDEN and 1:3 for 2:6th rate iDEN. Per SPEAG's recommendation, in order to account for probe modulation response, PMF is applied during post-processing of the measured data in SEMCAD. PMF also appears in the phone plots in Appendix 3.

| DUT Emissions Limits (AWF = 0) f < 960 MHz | |
|--|-------------------|
| Rating | E-Field |
| M3 | 199.5 – 354.8 V/m |
| M4 | < 199.5 V/m |

| DUT Emissions Limits (AWF = 0) f > 960 MHz | |
|--|------------------|
| Rating | E-Field |
| M3 | 63.1 – 112.2 V/m |
| M4 | < 63.1 V/m |

| DUT Emissions Limits (AWF = -5) f < 960 MHz | |
|---|-------------------|
| Rating | E-Field |
| M3 | 149.6 – 266.1 V/m |
| M4 | < 149.6 V/m |

| DUT Emissions Limits (AWF = -5) f > 960 MHz | |
|---|-----------------|
| Rating | E-Field |
| M3 | 47.3 – 84.1 V/m |
| M4 | < 47.3 V/m |

Table 6: HAC E-Field measurement results for the portable cellular telephone at highest possible output power.

| Band (Mode) | Channel Setting | AWF | Measured PMF | Drift (dB) | Excluded Cells | Peak Field (V/m) | Rating |
|------------------------------------|-----------------|-----|--------------|---------------|----------------|------------------|-----------|
| CDMA 800 (Full Rate) | 1013 | 0 | 1.05 | 0.000 | 2,3 | 65.7 | M4 |
| | 384 | | | -0.149 | 2,3 | 74.0 | M4 |
| | 777 | | | 0.095 | 2,3 | 65.0 | M4 |
| CDMA 800 (1/8 th Rate) | 1013 | 0 | 2.86 | -0.049 | 2,3 | 66.0 | M4 |
| | 384 | | | -0.044 | 2,3 | 72.1 | M4 |
| | 777 | | | 0.091 | 2,3 | 59.0 | M4 |
| CDMA 1900 (Full Rate) | 25 | 0 | 1.07 | 0.000 | 2,3 | 51.5 | M4 |
| | 600 | | | -0.023 | 8,9 | 56.3 | M4 |
| | 1175 | | | -0.097 | 8,9 | 51.0 | M4 |
| CDMA 1900 (1/8 th Rate) | 25 | 0 | 2.92 | 0.164 | 2,3 | 50.7 | M4 |
| | 600 | | | 0.070 | 8,9 | 56.0 | M4 |
| | 1175 | | | 0.176 | 8,9 | 54.0 | M4 |
| GSM 850 | 128 | -5 | 2.76 | -0.024 | 2,3 | 113.7 | M4 |
| | 190 | | | -0.047 | 2,3 | 133.3 | M4 |
| | 251 | | | 0.007 | 2,3 | 139.9 | M4 |
| GSM 1900 | 512 | -5 | 2.83 | -0.041 | 2,3 | 79.1 | M3 |
| | 661 | | | -0.023 | 8,9 | 78.8 | M3 |
| | 810 | | | 0.011 | 8,9 | 69.7 | M3 |
| WCDMA 850 | 4132 | 0 | 0.93 | 0.065 | 2,3 | 37.2 | M4 |
| | 4180 | | | 0.081 | 2,3 | 44.3 | M4 |
| | 4233 | | | 0.096 | 2,3 | 39.2 | M4 |
| WCDMA 1900 | 9262 | 0 | 0.94 | 0.131 | 3,6 | 47.3 | M4 |
| | 9400 | | | -0.014 | 6,8,9 | 44.1 | M4 |
| | 9538 | | | 0.106 | 6,8,9 | 39.2 | M4 |

| DUT Emissions Limits (AWF = 0) f < 960 MHz | |
|--|-----------------|
| Rating | H-Field |
| M3 | 0.60 – 1.07 A/m |
| M4 | < 0.60 A/m |

| DUT Emissions Limits (AWF = 0) f > 960 MHz | |
|--|-----------------|
| Rating | H-Field |
| M3 | 0.19 – 0.34 A/m |
| M4 | < 0.19 A/m |

| DUT Emissions Limits (AWF = -5) f < 960 MHz | |
|---|-----------------|
| Rating | H-Field |
| M3 | 0.45 – 0.80 A/m |
| M4 | < 0.45 A/m |

| DUT Emissions Limits (AWF = -5) f > 960 MHz | |
|---|-----------------|
| Rating | H-Field |
| M3 | 0.14 – 0.25 A/m |
| M4 | < 0.14 A/m |

Table 7: HAC H-Field measurement results for the portable cellular telephone at highest possible output power.

| Band (Mode) | Channel Setting | AWF | Measured PMF | Drift (dB) | Excluded Cells | Peak Field (A/m) | Rating |
|------------------------------------|-----------------|-----|--------------|---------------|----------------|------------------|-----------|
| CDMA 800 (Full Rate) | 1013 | 0 | 1.02 | -0.072 | 1,4,7 | 0.092 | M4 |
| | 384 | | | -0.046 | 1,4,7 | 0.108 | M4 |
| | 777 | | | -0.044 | 1,4,7 | 0.097 | M4 |
| CDMA 800 (1/8 th Rate) | 1013 | 0 | 2.53 | -0.125 | 1,4,7 | 0.088 | M4 |
| | 384 | | | -0.041 | 1,4,7 | 0.099 | M4 |
| | 777 | | | 0.003 | 1,4,7 | 0.078 | M4 |
| CDMA 1900 (Full Rate) | 25 | 0 | 1.03 | -0.168 | 1,4,7 | 0.139 | M4 |
| | 600 | | | -0.095 | 4,7,8 | 0.155 | M4 |
| | 1175 | | | -0.033 | 4,7,8 | 0.135 | M4 |
| CDMA 1900 (1/8 th Rate) | 25 | 0 | 2.54 | 0.119 | 1,4,7 | 0.122 | M4 |
| | 600 | | | -0.092 | 4,7,8 | 0.142 | M4 |
| | 1175 | | | -0.169 | 4,7,8 | 0.127 | M4 |
| GSM 850 | 128 | -5 | 2.44 | -0.152 | 1,4,7 | 0.138 | M4 |
| | 190 | | | 0.002 | 1,4,7 | 0.166 | M4 |
| | 251 | | | 0.119 | 1,4,7 | 0.169 | M4 |
| GSM 1900 | 512 | -5 | 2.58 | -0.031 | 1,4,7 | 0.203 | M3 |
| | 661 | | | -0.082 | 4,7,8 | 0.203 | M3 |
| | 810 | | | 0.017 | 4,7,8 | 0.179 | M3 |
| WCDMA 850 | 4132 | 0 | 0.92 | 0.076 | 1,4,7 | 0.056 | M4 |
| | 4180 | | | 0.054 | 1,4,7 | 0.067 | M4 |
| | 4233 | | | -0.029 | 1,4,7 | 0.060 | M4 |
| WCDMA 1900 | 9262 | 0 | 0.93 | 0.043 | 1,4,7 | 0.135 | M4 |
| | 9400 | | | -0.128 | 4,7,8 | 0.123 | M4 |
| | 9538 | | | -0.077 | 4,7,8 | 0.106 | M4 |

7. Device Conducted Power Measurements

For CDMA devices, RC1 and RC3 CDMA modes are considered in S055 service option. In addition, RC1 and RC3 modes are considered in S02 service option. The conducted power measurements for each mode are shown in the table below.

| Conducted Power (dBm) for CDMA modes | | | | | |
|--------------------------------------|---------|-------|-------|-------|-------|
| | Channel | RC1 | | RC3 | |
| | | S02 | S055 | S02 | S055 |
| CDMA 800 | 1013 | 25.12 | 25.12 | 25.16 | 24.99 |
| | 384 | 25.04 | 25.03 | 25.08 | 24.96 |
| | 777 | 25.12 | 25.13 | 25.10 | 24.99 |
| CDMA 1900 | 25 | 24.87 | 24.89 | 24.91 | 25.05 |
| | 600 | 24.84 | 24.86 | 24.87 | 24.99 |
| | 1175 | 24.72 | 24.74 | 24.73 | 24.86 |

For GSM devices, 1-slot circuit-switch voice mode is considered. The conducted power measurements for this mode are shown in the table below.

| Conducted power (dBm) for GSM modes | | |
|-------------------------------------|---------|----------|
| | Channel | CS Voice |
| GSM 850 | 128 | 33.32 |
| | 190 | 33.70 |
| | 251 | 33.59 |
| GSM 1900 | 512 | 30.61 |
| | 661 | 30.63 |
| | 810 | 30.50 |

For WCDMA devices, 12.2 kbps RMC and 12.2 kbps AMR modes are considered. The conducted power measurements for each mode are shown in the table below.

| Conducted power (dBm) for WCDMA modes | | | |
|---------------------------------------|---------|-------|-------|
| | Channel | RMC | AMR |
| WCDMA 850 | 4132 | 23.93 | 23.93 |
| | 4180 | 23.99 | 24.03 |
| | 4233 | 24.01 | 24.03 |
| WCDMA 1900 | 9262 | 23.96 | 24.07 |
| | 9400 | 24.03 | 24.03 |
| | 9538 | 23.88 | 23.92 |

Appendix 1

Details justifying the conversion to peak

A1.1 Procedure for PMF measurements

1. Set up and calibrate the HAC validation rack as noted in Figure 2; a power splitter is connected to the dual-directional coupler, which is then connected to both the spectrum analyzer and dipole on the output side of the splitter using matched cables. This cabling arrangement will remain in place throughout the following steps.
2. Command the HAC validation rack as you would for a normal CW HAC validation with forward power per Table A1 for the mode, frequency, and field probe type of interest.
3. Set up the dipole and phantom as you would for a normal CW HAC validation.
4. In the DASY software, open appropriate job template and verify the following parameters:
Medium = "Air";
Communication System = "HAC – Dipole";
Ensure the proper probe & DAE are installed and laser aligned
5. **Measure the CW signal:** With the CW signal transmitting through the dipole, command the DASY system to run the appropriate field measurement job.
6. Do **not** turn off the signal generator power.
7. **Setting the CW Reference Level on the Spectrum Analyzer:**
 - a. Set up the Spectrum Analyzer for the following Settings:

| | |
|-------------|---|
| Frequency: | Freq. being tested (EX: 835/1880) |
| Span: | Zero Span |
| Res BW: | iDEN – 100 kHz; GSM – 300 kHz; CDMA – 3 MHz; WCDMA – 5 MHz; |
| Video BW: | iDEN – 300 kHz; GSM – 1MHz; CDMA and WCDMA – 30 kHz**; |
| Sweep Time: | 20 ms; 120 ms for iDEN |
| Scale: | 1 dB |
| Detector: | PEAK / Manual |
 - b. Adjust the REF level until the CW signal is aligned with the Center Line (approx. 15 dB). NOTE: After this point, the Reference Line must remain fixed. Do not change it.
8. **Measure the modulated signal(s):**
 - a. Command the signal generator to the desired modulation.
 - b. Set the Spectrum Analyzer Sweep Time to 20 ms.
 - c. Adjust the amplitude of the power on the signal generator so that the PEAK of the modulated signal is at the CW Reference Line:
 - i. On the Spectrum Analyzer, press the [View Trace] button and then select (Max Hold), this will show only the Peak output.
 - ii. Press (Clear Write) and then (Max Hold) each time an amplitude adjustment is made.
 - d. Allow the Max Hold line to stabilize. Then check that the highest peak of the Max Hold line corresponds with the CW Reference Line (without going over). If not correct, repeat the steps beginning with step 8c.
9. Command the DASY system to run the appropriate field measurement job.
10. Repeat steps 2 through 9 until all PMF measurements have been completed.

**The use of 30 kHz VBW is validated. The power measurements are verified using an average power meter.

Table A1: PMF Measurement, CW Signal Dipole Input Power

| Mode | f (MHz) | Field Probe Type | Dipole Input Power | Notes |
|----------------------------------|---------|------------------|--------------------|-------|
| 80% AM | 813 | E and H | 100 mW | |
| | 835 | | | |
| | 898 | | | |
| | 1730 | | | |
| | 1880 | | | |
| CDMA (Full & 1/8 th) | 835 | E and H | 320 mW | 1 |
| | 1730 | | 50 mW | 2 |
| | 1880 | | 50 mW | 2 |
| WCDMA | 835 | E and H | 250 mW | 1 |
| | 1730 | | 50 mW | 2 |
| | 1880 | | 50 mW | 2 |
| GSM | 835 | E-Field | 690 mW | 2 |
| | | H-Field | 270 mW | 2 |
| | 1880 | E-Field | 35 mW | 2 |
| | | H-Field | 27 mW | 2 |
| iDEN (1:6 & 2:6) | 813 | E-Field | 640 mW | 1 |
| | | H-Field | 460 mW | 2 |
| | 898 | E-Field | 640 mW | 1 |
| | | H-Field | 580 mW | 2 |

Note 1: The power level shown represents the typical DUT peak power level for this configuration.

Note 2: The typical peak power level for this configuration results in a field strength significantly higher than the relevant M3 category limit field strength, and is therefore not realistic. The power level shown results in a field strength approximating the M3 category limit value.

A1.2 0-Span Spectrum Plots for PMF measurements

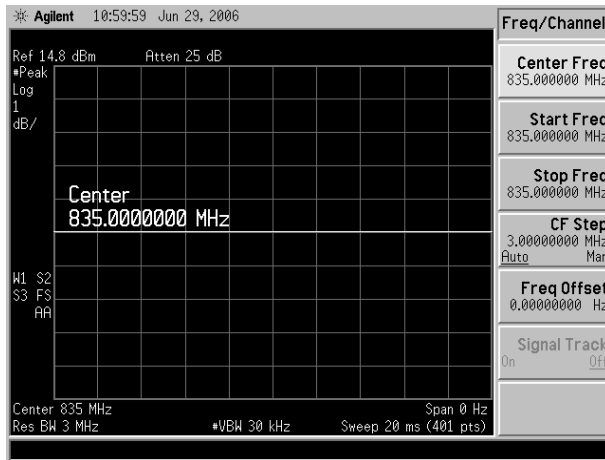

CW 835 MHz

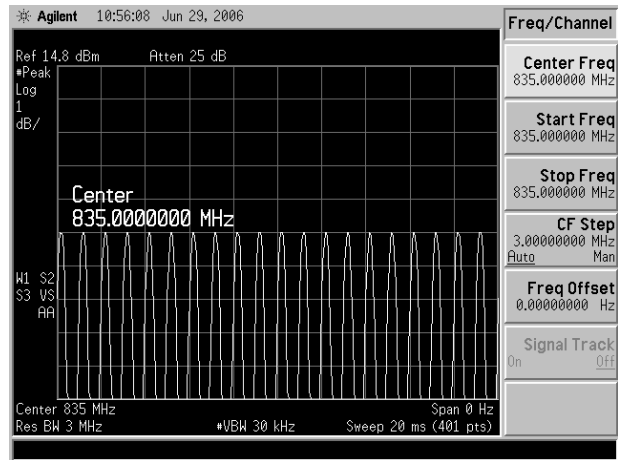

80% AM 835 MHz

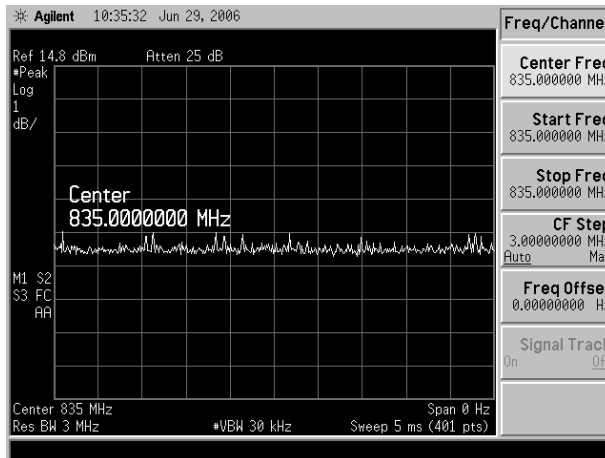

CDMA 835 MHz (Full rate)

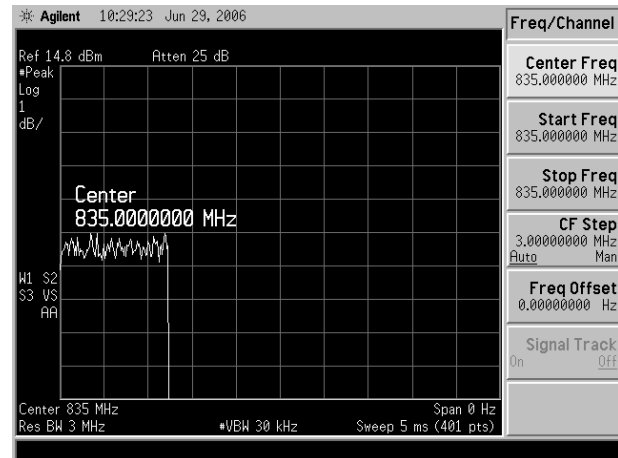

CDMA 835 MHz (1/8 rate)

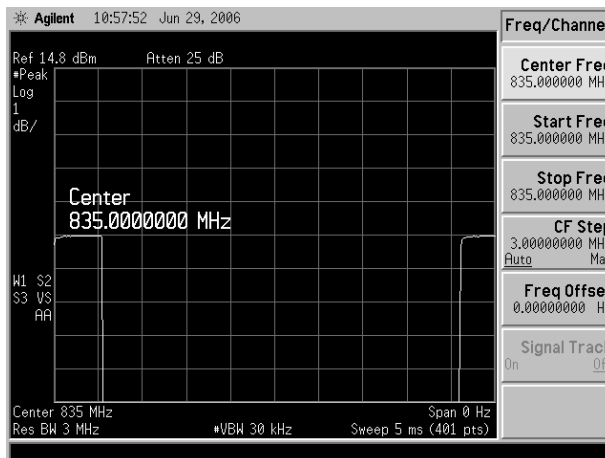

GSM 835 MHz

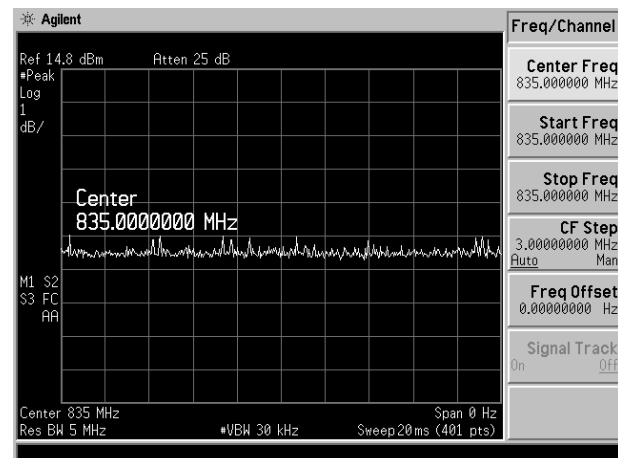

WCDMA 835 MHz

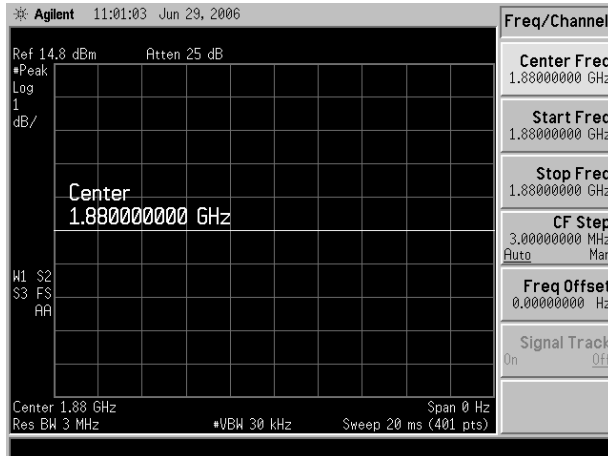

CW 1880 MHz

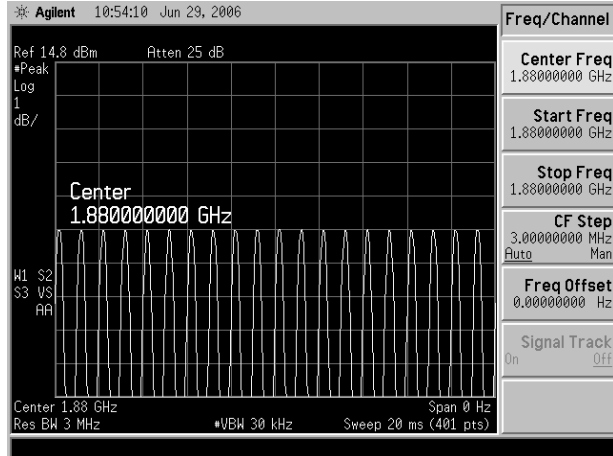

80% AM 1880 MHz

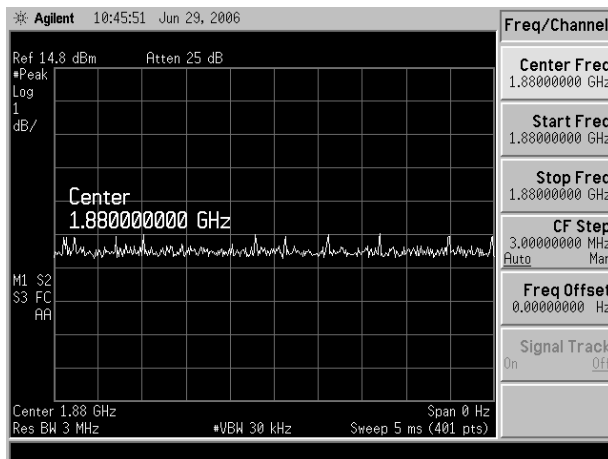

CDMA 1880 MHz (Full rate)

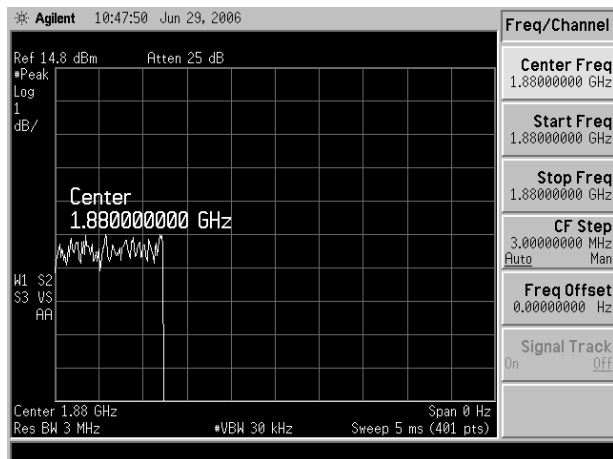

CDMA 1880 MHz (1/8 rate)

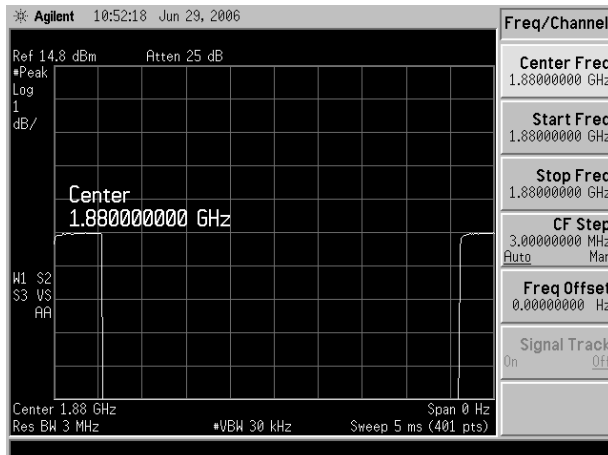

GSM 1880 MHz

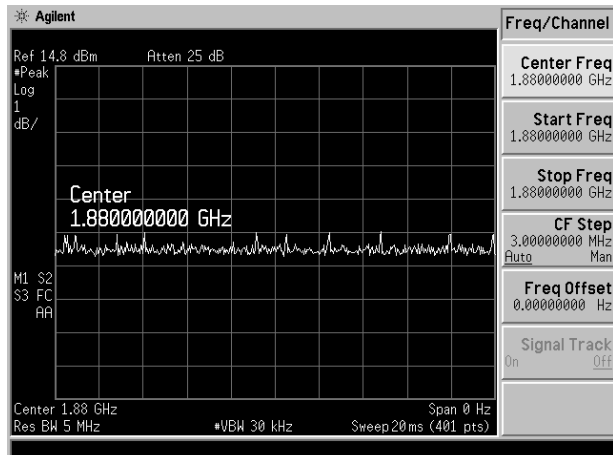

WCDMA 1880 MHz

Appendix 2

HAC distribution plots for Validation

Test Laboratory: Motorola - May-07-2013 E-Field 835 MHz CW

DUT: HAC-Dipole 835 MHz; Type: CD835V3; FCC ID: IHDT56PE2
Procedure Notes: 835 MHz HAC Validation; Dipole Sn# 1076; Input Power = 100 mW
Communication System: CW - HAC; Frequency: 835 MHz; Duty Cycle: 1:1
Medium: Air; Medium parameters used: $\sigma = 0$ mho/m, $\epsilon_r = 1$; $\rho = 0$ kg/m³

DASY4 Configuration:

- Probe: ER3DV6R - SN2248; ConvF(1, 1, 1); Calibrated: 1/11/2013
- Sensor-Surface: 0mm (Fix Surface)Sensor-Surface: (Fix Surface)
- Electronics: DAE4 Sn1313; Calibrated: 1/28/2013
- Phantom: R-6, HAC Test Arch (rev.2); Type: SD HAC P01 BA; Serial: 1071; Phantom section: RF Section
- Measurement SW: DASY4, V4.7 Build 80; Postprocessing SW: SEMCAD, V1.8 Build 186

E Scan - Probe center 10mm above Dipole/Hearing Aid Compatibility Test (41x361x1):

Measurement grid: dx=5mm, dy=5mm; Probe Modulation Factor = 1.00
Device Reference Point: 0.000, 0.000, -6.30 mm; Reference Value = 124.2 V/m; Power Drift = -0.030 dB
Maximum value of Total (interpolated) = 176.3 V/m
Average value of Total (interpolated) = $(176.3 + 163.4) / 2 = 169.85$ V/m

Peak E-field in V/m

| | | |
|---------------------------|----------------------------------|---------------------------|
| Grid 1 166.3 M4 | Grid 2 176.3 M4 | Grid 3 172.9 M4 |
| Grid 4 86.6 M4 | Grid 5 89.4 M4 | Grid 6 87.5 M4 |
| Grid 7 159.8 M4 | Grid 8 163.4 M4 | Grid 9 160.5 M4 |

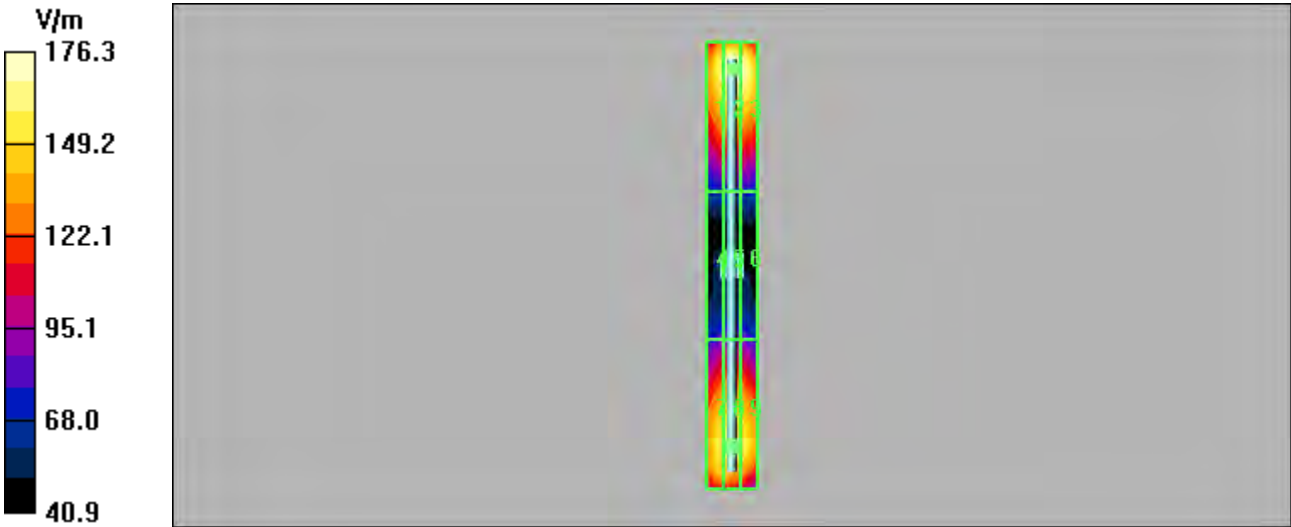

Test Laboratory: Motorola - May-06-2013 E-Field 1880 MHz CW

DUT: HAC Dipole 1880 MHz; Type: CD1880V3; FCC ID: IHDT56PE2
Procedure Notes: 1880 MHz HAC Validation; Dipole Sn# 1034; Input Power = 100 mW
Communication System: CW - HAC; Frequency: 1880 MHz; Duty Cycle: 1:1
Medium: Air; Medium parameters used: $\sigma = 0$ mho/m, $\epsilon_r = 1$; $\rho = 0$ kg/m³

DASY4 Configuration:

- Probe: ER3DV6R - SN2248; ConvF(1, 1, 1); Calibrated: 1/11/2013
- Sensor-Surface: 0mm (Fix Surface)Sensor-Surface: (Fix Surface)
- Electronics: DAE4 Sn1313; Calibrated: 1/28/2013
- Phantom: R-6, HAC Test Arch (rev.2); Type: SD HAC P01 BA; Serial: 1071; Phantom section: RF Section
- Measurement SW: DASY4, V4.7 Build 80; Postprocessing SW: SEMCAD, V1.8 Build 186

E Scan - Probe center 10mm above Dipole/Hearing Aid Compatibility Test (41x181x1):

Measurement grid: dx=5mm, dy=5mm; Probe Modulation Factor = 1.00
Device Reference Point: 0.000, 0.000, -6.30 mm; Reference Value = 135.7 V/m; Power Drift = 0.018 dB
Maximum value of Total (interpolated) = 143.4 V/m
Average value of Total (interpolated) = (143.4 + 134.0) / 2 = 138.7 V/m

Peak E-field in V/m

| | | |
|---------------------------|----------------------------------|---------------------------|
| Grid 1 140.4 M2 | Grid 2 143.4 M2 | Grid 3 137.1 M2 |
| Grid 4 87.1 M3 | Grid 5 91.3 M3 | Grid 6 90.0 M3 |
| Grid 7 129.0 M2 | Grid 8 134.0 M2 | Grid 9 132.6 M2 |

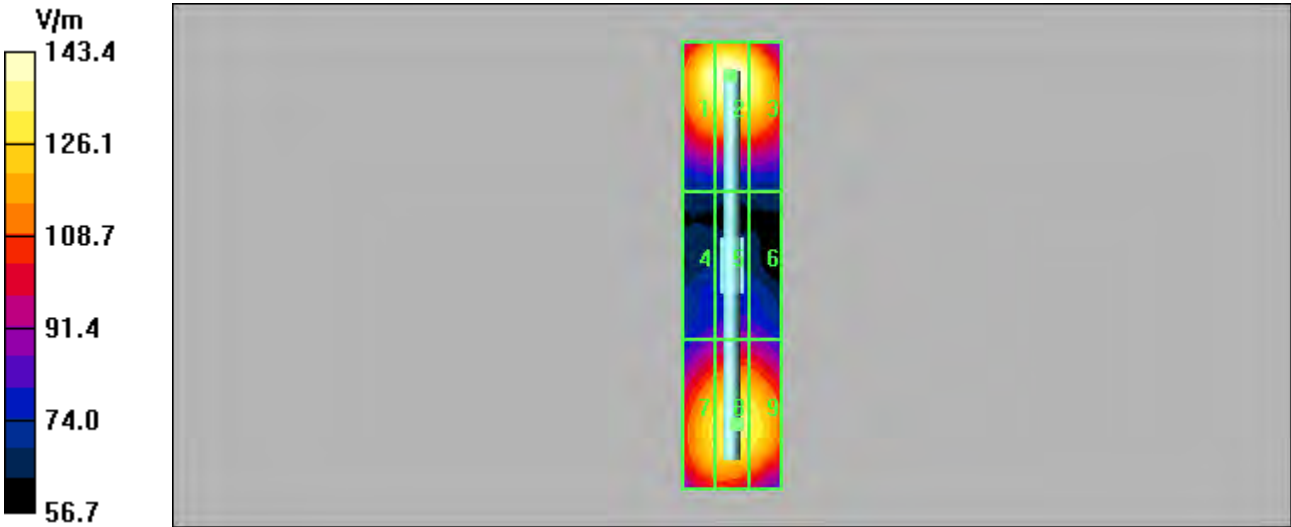

Test Laboratory: Motorola - May-07-2013 H-Field 835 MHz CW**DUT: HAC-Dipole 835 MHz; Type: CD835V3; FCC ID: IHDT56PE2**

Procedure Notes: 835 MHz HAC Validation; Dipole Sn# 1076; Input Power = 100 mW

Communication System: CW - HAC; Frequency: 835 MHz; Duty Cycle: 1:1

Medium: Air; Medium parameters used: $\sigma = 0$ mho/m, $\epsilon_r = 1$; $\rho = 0$ kg/m³

DASY4 Configuration:

- Probe: H3DV6 - SN6074; ; Calibrated: 1/11/2013
- Sensor-Surface: 0mm (Fix Surface)Sensor-Surface: (Fix Surface)
- Electronics: DAE3 Sn365; Calibrated: 1/28/2013
- Phantom: R-6, HAC Test Arch (rev.2); Type: SD HAC P01 BA; Serial: 1071; Phantom section: RF Section
- Measurement SW: DASY4, V4.7 Build 80; Postprocessing SW: SEMCAD, V1.8 Build 186

H Scan - Probe center 10mm above Dipole/Hearing Aid Compatibility Test (41x361x1):

Measurement grid: dx=5mm, dy=5mm; Probe Modulation Factor = 1.00

Device Reference Point: 0.000, 0.000, -6.30 mm; Reference Value = 0.497 A/m; Power Drift = -0.056 dB

Maximum value of Total (interpolated) = 0.470 A/m

Peak H-field in A/m

| | | |
|---------------------------|---------------------------|---------------------------|
| Grid 1 0.376 M4 | Grid 2 0.413 M4 | Grid 3 0.404 M4 |
| Grid 4 0.434 M4 | Grid 5 0.470 M4 | Grid 6 0.455 M4 |
| Grid 7 0.389 M4 | Grid 8 0.423 M4 | Grid 9 0.409 M4 |

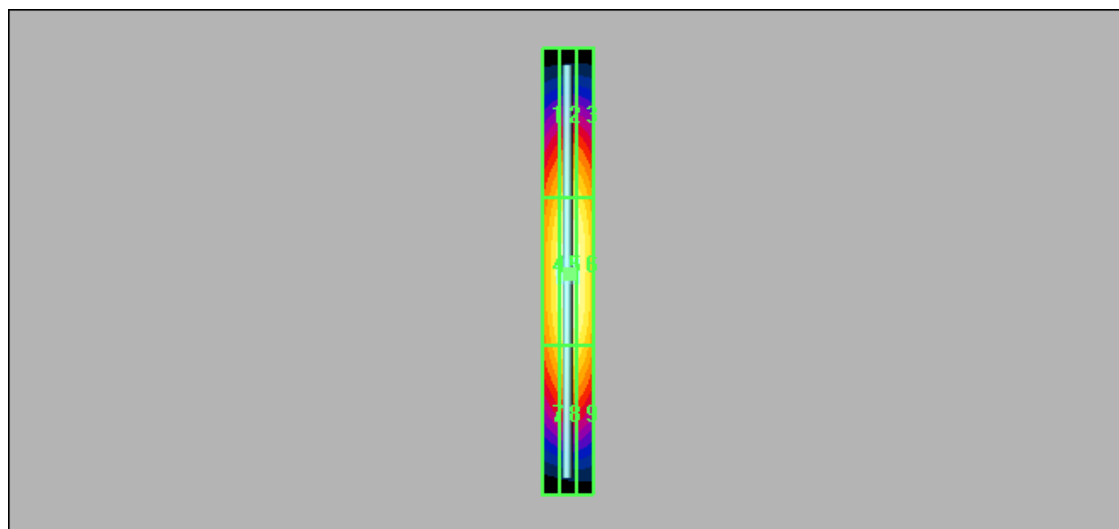
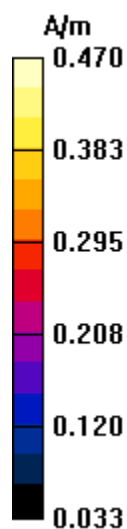

Test Laboratory: Motorola - May-06-2013 H-Field 1880 MHz CW

DUT: HAC Dipole 1880 MHz; Type: CD1880V3; FCC ID: IHDT56PE2
Procedure Notes: 1880 MHz HAC Validation; Dipole Sn# 1034; Input Power = 100 mW
Communication System: CW - HAC; Frequency: 1880 MHz; Duty Cycle: 1:1
Medium: Air; Medium parameters used: $\sigma = 0$ mho/m, $\epsilon_r = 1$; $\rho = 0$ kg/m³

DASY4 Configuration:

- Probe: H3DV6 - SN6074; ; Calibrated: 1/11/2013
- Sensor-Surface: 0mm (Fix Surface)Sensor-Surface: (Fix Surface)
- Electronics: DAE3 Sn365; Calibrated: 1/28/2013
- Phantom: R-6, HAC Test Arch (rev.2); Type: SD HAC P01 BA; Serial: 1071; Phantom section: RF Section
- Measurement SW: DASY4, V4.7 Build 80; Postprocessing SW: SEMCAD, V1.8 Build 186

H Scan - Probe center 10mm above Dipole/Hearing Aid Compatibility Test (41x181x1):

Measurement grid: dx=5mm, dy=5mm; Probe Modulation Factor = 1.00
Device Reference Point: 0.000, 0.000, -6.30 mm; Reference Value = 0.489 A/m; Power Drift = 0.030 dB
Maximum value of Total (interpolated) = 0.464 A/m

Peak H-field in A/m

| | | |
|---------------------------|----------------------------------|---------------------------|
| Grid 1 0.390 M2 | Grid 2 0.421 M2 | Grid 3 0.410 M2 |
| Grid 4 0.432 M2 | Grid 5 0.464 M2 | Grid 6 0.455 M2 |
| Grid 7 0.395 M2 | Grid 8 0.426 M2 | Grid 9 0.418 M2 |

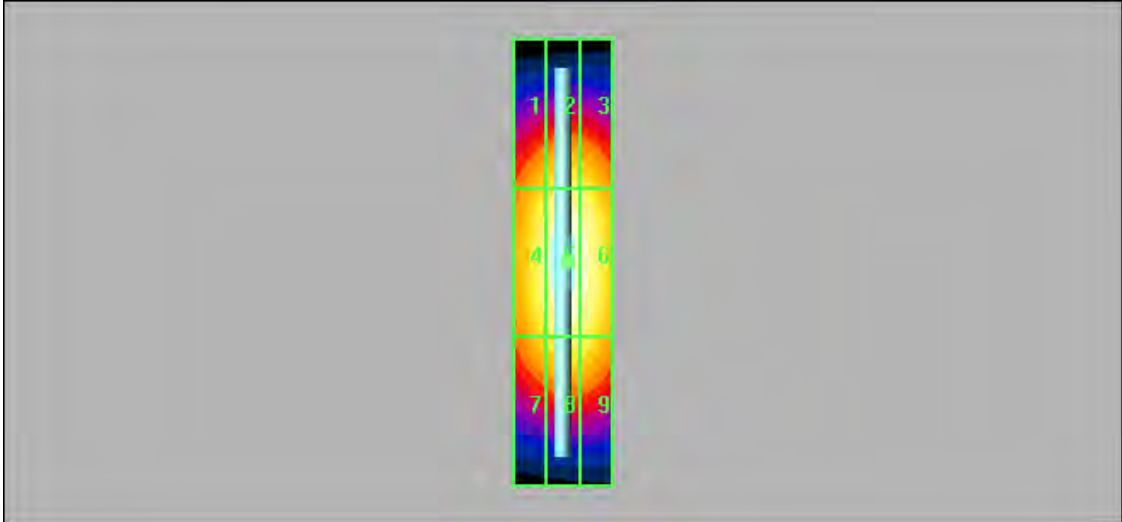
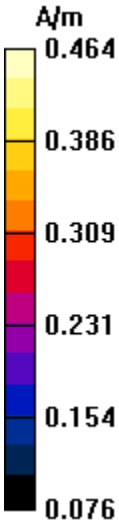

Appendix 3

HAC distribution plots for E-Field and H-Field

Test Laboratory: Motorola - CDMA 800 E-Field, Full Rate
Serial: LUWV260010; FCC ID: IHDT56PE2

Communication System: CDMA 835; Frequency: 836.52 MHz; Channel Number: 384; Duty Cycle: 1:1
 Medium: Air; Medium parameters used: $\sigma = 0$ mho/m, $\epsilon_r = 1$; $\rho = 0$ kg/m³

DASY4 Configuration:

- Probe: ER3DV6R - SN2248; ConvF(1, 1, 1); Calibrated: 1/11/2013
- Sensor-Surface: (Fix Surface)
- Electronics: DAE4 Sn1313; Calibrated: 1/28/2013
- Phantom: R-6, HAC Test Arch (rev.2); Type: SD HAC P01 BA; Serial: 1071; Phantom section: RF Section
- Measurement SW: DASY4, V4.7 Build 80; Postprocessing SW: SEMCAD, V1.8 Build 186

E Scan - Sensor center 15mm above WD, Hearing Aid Compatibility Test (101x101x1):

Measurement grid: dx=5mm, dy=5mm
 Maximum value of peak Total field = 74.0 V/m; Probe Modulation Factor = 1.05
 Device Reference Point: 0.000, 0.000, -6.30 mm; Reference Value = 84.2 V/m; Power Drift = -0.149 dB

Hearing Aid Near-Field Category: M4 (AWF 0 dB)

Peak E-field in V/m

| | | |
|--------------------------|--------------------------|--------------------------|
| Grid 1 68.2 M4 | Grid 2 78.3 M4 | Grid 3 78.0 M4 |
| Grid 4 61.6 M4 | Grid 5 74.0 M4 | Grid 6 74.0 M4 |
| Grid 7 56.6 M4 | Grid 8 68.0 M4 | Grid 9 67.9 M4 |

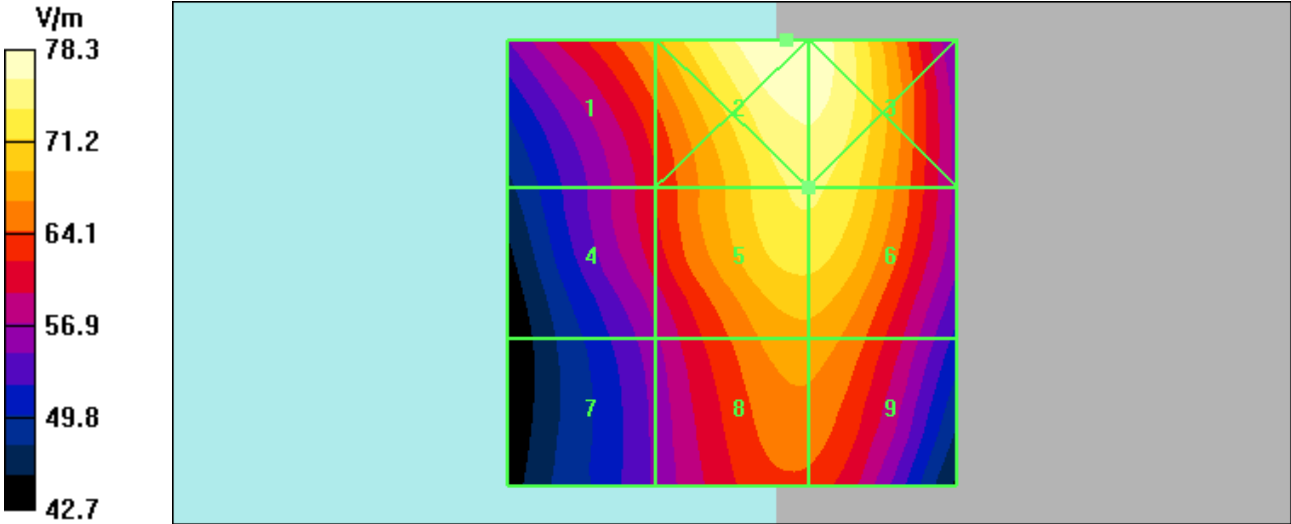

Test Laboratory: Motorola - CDMA 800 E-Field, 1/8th Rate
Serial: LUWV260010; FCC ID: IHDT56PE2

Communication System: CDMA 835, 1/8 Vocoder; Frequency: 836.52 MHz; Channel Number: 384; Duty Cycle: 1:8

Medium: Air; Medium parameters used: $\sigma = 0$ mho/m, $\epsilon_r = 1$; $\rho = 0$ kg/m³

DASY4 Configuration:

- Probe: ER3DV6R - SN2248; ConvF(1, 1, 1); Calibrated: 1/11/2013
- Sensor-Surface: (Fix Surface)
- Electronics: DAE4 Sn1313; Calibrated: 1/28/2013
- Phantom: R-6, HAC Test Arch (rev.2); Type: SD HAC P01 BA; Serial: 1071; Phantom section: RF Section
- Measurement SW: DASY4, V4.7 Build 80; Postprocessing SW: SEMCAD, V1.8 Build 186

E Scan - Sensor center 15mm above WD, Hearing Aid Compatibility Test (101x101x1):

Measurement grid: dx=5mm, dy=5mm

Maximum value of peak Total field = 72.1 V/m; Probe Modulation Factor = 2.86

Device Reference Point: 0.000, 0.000, -6.30 mm; Reference Value = 29.3 V/m; Power Drift = -0.044 dB

Hearing Aid Near-Field Category: M4 (AWF 0 dB)

Peak E-field in V/m

| | | |
|--------------------------|--------------------------|--------------------------|
| Grid 1 66.6 M4 | Grid 2 76.1 M4 | Grid 3 75.8 M4 |
| Grid 4 60.4 M4 | Grid 5 72.1 M4 | Grid 6 72.1 M4 |
| Grid 7 55.8 M4 | Grid 8 66.7 M4 | Grid 9 66.7 M4 |

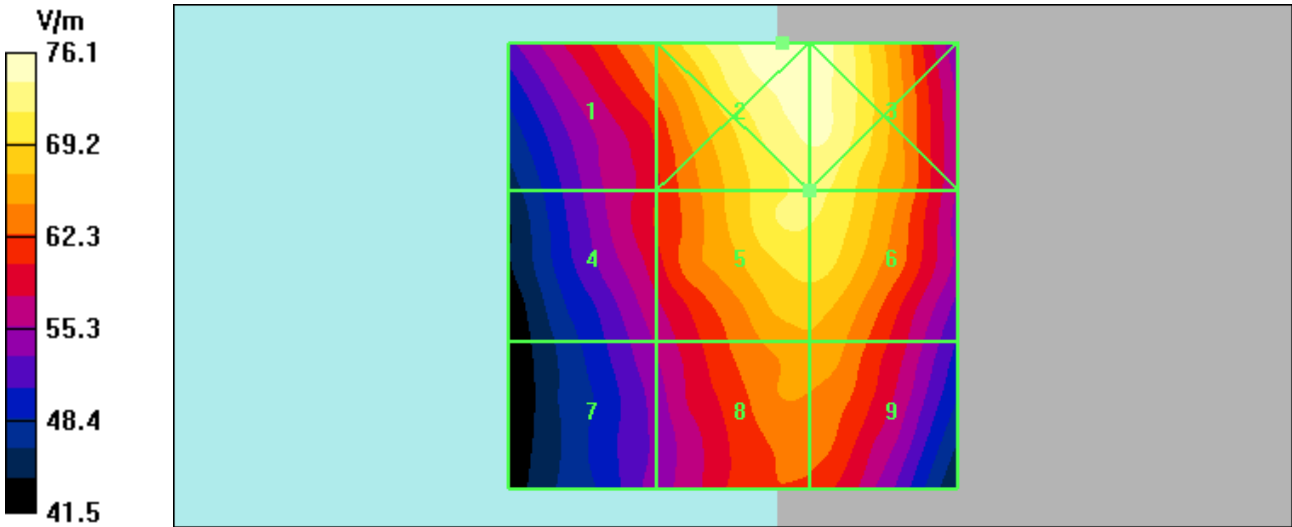

Test Laboratory: Motorola - CDMA 1900 E-Field, Full Rate
Serial: LUWV260010; FCC ID: IHDT56PE2

Communication System: CDMA 1900; Frequency: 1880 MHz; Channel Number: 600; Duty Cycle: 1:1
 Medium: Air; Medium parameters used: $\sigma = 0$ mho/m, $\epsilon_r = 1$; $\rho = 0$ kg/m³

DASY4 Configuration:

- Probe: ER3DV6R - SN2248; ConvF(1, 1, 1); Calibrated: 1/11/2013
- Sensor-Surface: (Fix Surface)
- Electronics: DAE4 Sn1313; Calibrated: 1/28/2013
- Phantom: R-6, HAC Test Arch (rev.2); Type: SD HAC P01 BA; Serial: 1071; Phantom section: RF Section
- Measurement SW: DASY4, V4.7 Build 80; Postprocessing SW: SEMCAD, V1.8 Build 186

E Scan - Sensor center 15mm above WD, Hearing Aid Compatibility Test (101x101x1):

Measurement grid: dx=5mm, dy=5mm

Maximum value of peak Total field = 56.3 V/m; Probe Modulation Factor = 1.07

Device Reference Point: 0.000, 0.000, -6.30 mm; Reference Value = 55.2 V/m; Power Drift = -0.023 dB

Hearing Aid Near-Field Category: M4 (AWF 0 dB)

Peak E-field in V/m

| | | |
|--------------------------|--------------------------|--------------------------|
| Grid 1 32.7 M4 | Grid 2 54.4 M4 | Grid 3 54.6 M4 |
| Grid 4 35.5 M4 | Grid 5 55.8 M4 | Grid 6 56.3 M4 |
| Grid 7 46.0 M4 | Grid 8 54.7 M4 | Grid 9 55.3 M4 |

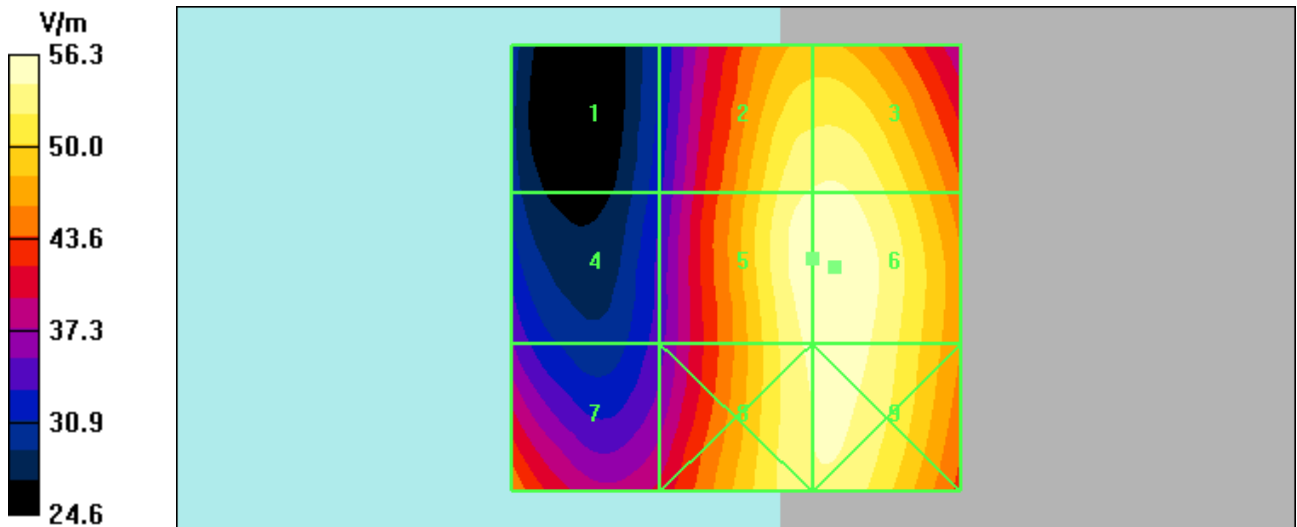

Test Laboratory: Motorola - CDMA 1900 E-Field, 1/8th Rate
Serial: LUWV260010; FCC ID: IHDT56PE2

Communication System: CDMA 1900, 8th Vocoder; Frequency: 1880 MHz; Channel Number: 600; Duty Cycle: 1:8
 Medium: Air; Medium parameters used: $\sigma = 0$ mho/m, $\epsilon_r = 1$; $\rho = 0$ kg/m³

DASY4 Configuration:

- Probe: ER3DV6R - SN2248; ConvF(1, 1, 1); Calibrated: 1/11/2013
- Sensor-Surface: (Fix Surface)
- Electronics: DAE4 Sn1313; Calibrated: 1/28/2013
- Phantom: R-6, HAC Test Arch (rev.2); Type: SD HAC P01 BA; Serial: 1071; Phantom section: RF Section
- Measurement SW: DASY4, V4.7 Build 80; Postprocessing SW: SEMCAD, V1.8 Build 186

E Scan - Sensor center 15mm above WD, Hearing Aid Compatibility Test (101x101x1):

Measurement grid: dx=5mm, dy=5mm

Maximum value of peak Total field = 56.0 V/m; Probe Modulation Factor = 2.92

Device Reference Point: 0.000, 0.000, -6.30 mm; Reference Value = 20.0 V/m; Power Drift = 0.070 dB

Hearing Aid Near-Field Category: M4 (AWF 0 dB)

Peak E-field in V/m

| | | |
|--------------------------|--------------------------|--------------------------|
| Grid 1 32.6 M4 | Grid 2 53.9 M4 | Grid 3 54.1 M4 |
| Grid 4 34.8 M4 | Grid 5 55.6 M4 | Grid 6 56.0 M4 |
| Grid 7 45.0 M4 | Grid 8 54.2 M4 | Grid 9 54.6 M4 |

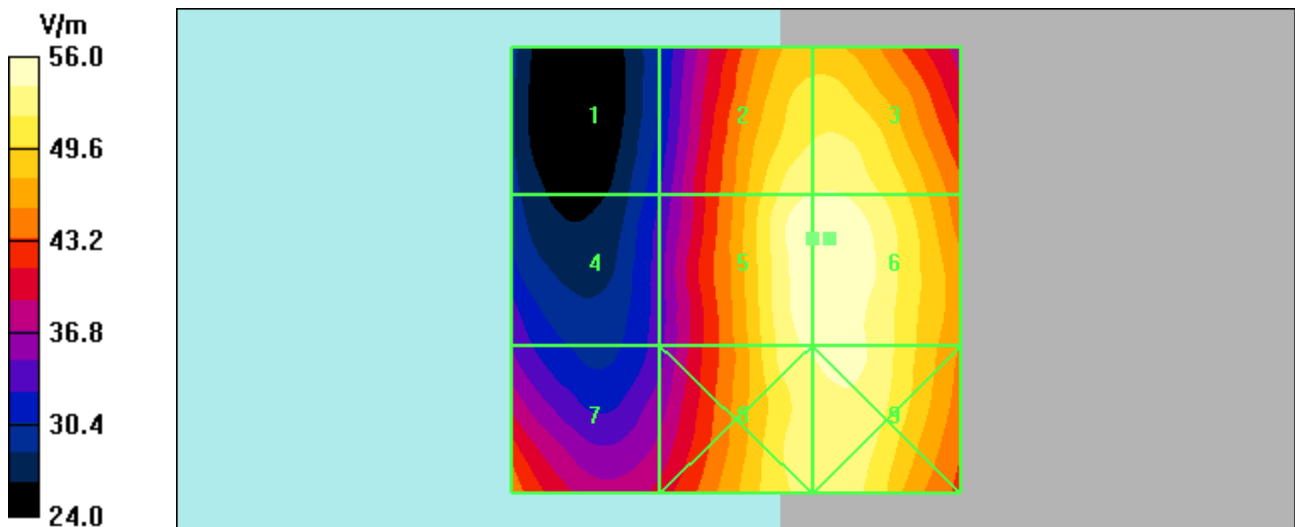

Test Laboratory: Motorola - GSM 850 E-Field
Serial: LUWV260010; FCC ID: IHDT56PE2

Communication System: GSM 850; Frequency: 848.8 MHz; Channel Number: 251; Duty Cycle: 1:8.3
 Medium: Air; Medium parameters used: $\sigma = 0$ mho/m, $\epsilon_r = 1$; $\rho = 0$ kg/m³

DASY4 Configuration:

- Probe: ER3DV6R - SN2248; ConvF(1, 1, 1); Calibrated: 1/11/2013
- Sensor-Surface: (Fix Surface)
- Electronics: DAE4 Sn1313; Calibrated: 1/28/2013
- Phantom: R-6, HAC Test Arch (rev.2); Type: SD HAC P01 BA; Serial: 1071; Phantom section: RF Section
- Measurement SW: DASY4, V4.7 Build 80; Postprocessing SW: SEMCAD, V1.8 Build 186

E Scan - Sensor center 15mm above WD, Hearing Aid Compatibility Test (101x101x1):

Measurement grid: dx=5mm, dy=5mm

Maximum value of peak Total field = 139.9 V/m; Probe Modulation Factor = 2.76

Device Reference Point: 0.000, 0.000, -6.30 mm; Reference Value = 60.0 V/m; Power Drift = 0.007 dB

Hearing Aid Near-Field Category: M4 (AWF -5 dB)

Peak E-field in V/m

| | | |
|---------------------------|---------------------------|---------------------------|
| Grid 1 123.1 M4 | Grid 2 138.1 M4 | Grid 3 137.6 M4 |
| Grid 4 117.9 M4 | Grid 5 139.9 M4 | Grid 6 139.5 M4 |
| Grid 7 111.0 M4 | Grid 8 135.0 M4 | Grid 9 134.8 M4 |

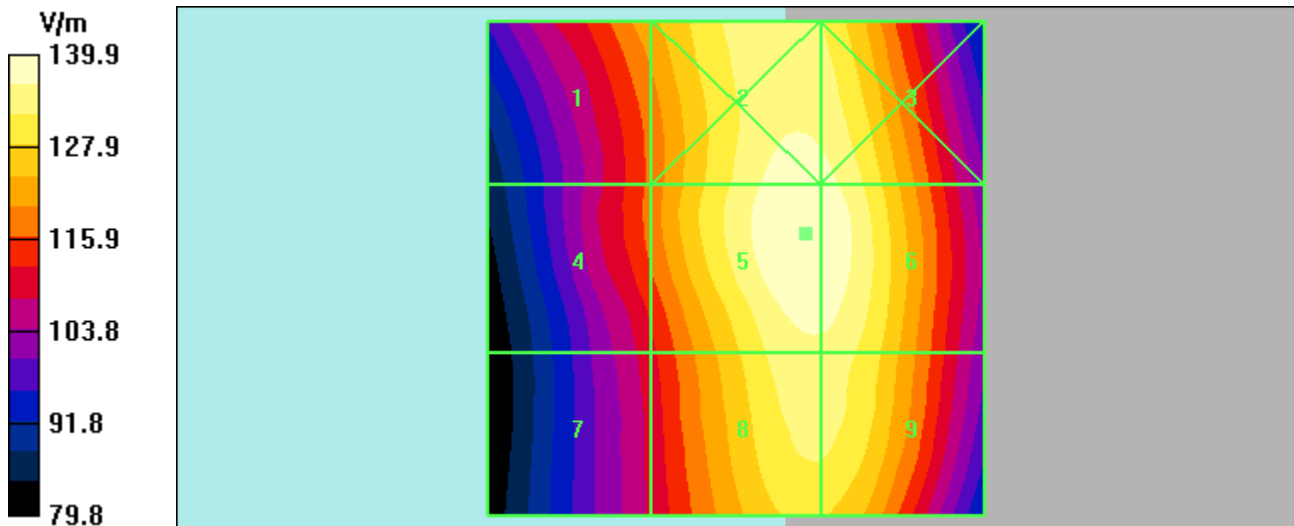

Test Laboratory: Motorola - GSM 1900 E-Field

Serial: LUWV260010; FCC ID: IHDT56PE2

Communication System: GSM 1900; Frequency: 1850.2 MHz; Channel Number: 512; Duty Cycle: 1:8.3

Medium: Air; Medium parameters used: $\sigma = 0$ mho/m, $\epsilon_r = 1$; $\rho = 0$ kg/m³

DASY4 Configuration:

- Probe: ER3DV6R - SN2248; ConvF(1, 1, 1); Calibrated: 1/11/2013
- Sensor-Surface: (Fix Surface)
- Electronics: DAE4 Sn1313; Calibrated: 1/28/2013
- Phantom: R-6, HAC Test Arch (rev.2); Type: SD HAC P01 BA; Serial: 1071; Phantom section: RF Section
- Measurement SW: DASY4, V4.7 Build 80; Postprocessing SW: SEMCAD, V1.8 Build 186

E Scan - Sensor center 15mm above WD, Hearing Aid Compatibility Test (101x101x1):

Measurement grid: dx=5mm, dy=5mm

Maximum value of peak Total field = 79.1 V/m; Probe Modulation Factor = 2.83

Device Reference Point: 0.000, 0.000, -6.30 mm; Reference Value = 28.8 V/m; Power Drift = -0.041 dB

Hearing Aid Near-Field Category: M3 (AWF -5 dB)

Peak E-field in V/m

| | | |
|--------------------------|--------------------------|--------------------------|
| Grid 1 49.0 M3 | Grid 2 77.8 M3 | Grid 3 78.4 M3 |
| Grid 4 46.2 M4 | Grid 5 78.4 M3 | Grid 6 79.1 M3 |
| Grid 7 62.3 M3 | Grid 8 73.5 M3 | Grid 9 74.4 M3 |

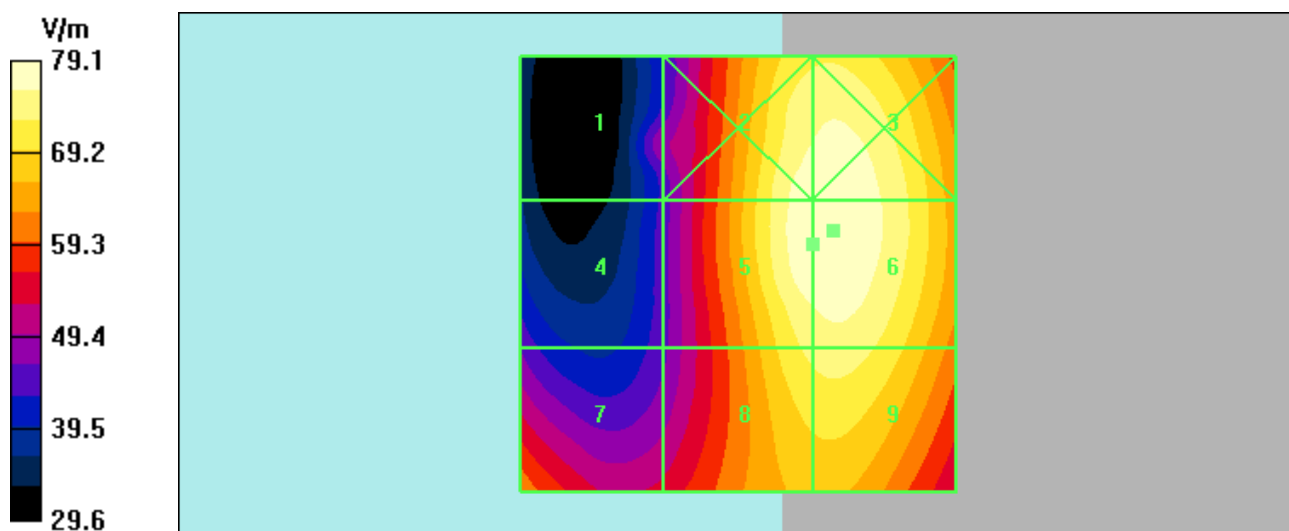

Test Laboratory: Motorola - WCDMA 850 E-Field
Serial: LUWV260010; FCC ID: IHDT56PE2

Communication System: WCDMA 850; Frequency: 836 MHz; Channel Number: 4180; Duty Cycle: 1:1
Medium: Air; Medium parameters used: $\sigma = 0$ mho/m, $\epsilon_r = 1$; $\rho = 0$ kg/m³

DASY4 Configuration:

- Probe: ER3DV6R - SN2248; ConvF(1, 1, 1); Calibrated: 1/11/2013
- Sensor-Surface: (Fix Surface)
- Electronics: DAE4 Sn1313; Calibrated: 1/28/2013
- Phantom: R-6, HAC Test Arch (rev.2); Type: SD HAC P01 BA; Serial: 1071; Phantom section: RF Section
- Measurement SW: DASY4, V4.7 Build 80; Postprocessing SW: SEMCAD, V1.8 Build 186

E Scan - Sensor center 15mm above WD, Hearing Aid Compatibility Test (101x101x1):

Measurement grid: dx=5mm, dy=5mm
Maximum value of peak Total field = 44.3 V/m; Probe Modulation Factor = 0.930
Device Reference Point: 0.000, 0.000, -6.30 mm; Reference Value = 55.9 V/m; Power Drift = 0.081 dB

Hearing Aid Near-Field Category: M4 (AWF 0 dB)

Peak E-field in V/m

| | | |
|--------------------------|--------------------------|--------------------------|
| Grid 1 40.2 M4 | Grid 2 45.8 M4 | Grid 3 45.7 M4 |
| Grid 4 37.3 M4 | Grid 5 44.3 M4 | Grid 6 44.3 M4 |
| Grid 7 35.2 M4 | Grid 8 41.9 M4 | Grid 9 41.8 M4 |

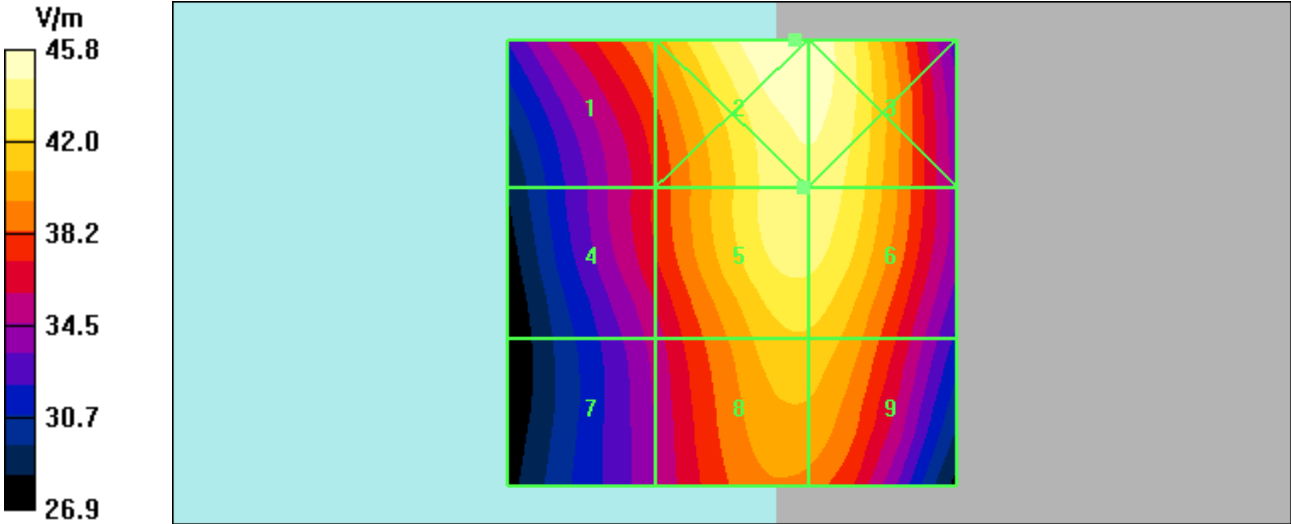

Test Laboratory: Motorola - WCDMA 1900 E-Field

Serial: LUWV260010; FCC ID: IHDT56PE2

Communication System: WCDMA 1900; Frequency: 1852.5 MHz; Channel Number: 9262; Duty Cycle: 1:1
 Medium: Air; Medium parameters used: $\sigma = 0$ mho/m, $\epsilon_r = 1$; $\rho = 0$ kg/m³

DASY4 Configuration:

- Probe: ER3DV6R - SN2248; ConvF(1, 1, 1); Calibrated: 1/11/2013
- Sensor-Surface: (Fix Surface)
- Electronics: DAE4 Sn1313; Calibrated: 1/28/2013
- Phantom: R-6, HAC Test Arch (rev.2); Type: SD HAC P01 BA; Serial: 1071; Phantom section: RF Section
- Measurement SW: DASY4, V4.7 Build 80; Postprocessing SW: SEMCAD, V1.8 Build 186

E Scan - Sensor center 15mm above WD, Hearing Aid Compatibility Test (101x101x1):

Measurement grid: dx=5mm, dy=5mm

Maximum value of peak Total field = 47.3 V/m; Probe Modulation Factor = 0.940

Device Reference Point: 0.000, 0.000, -6.30 mm; Reference Value = 51.2 V/m; Power Drift = 0.131 dB

Hearing Aid Near-Field Category: M4 (AWF 0 dB)

Peak E-field in V/m

| | | |
|--------------------------|--------------------------|--------------------------|
| Grid 1 27.0 M4 | Grid 2 46.8 M4 | Grid 3 47.2 M4 |
| Grid 4 29.0 M4 | Grid 5 47.3 M4 | Grid 6 47.7 M4 |
| Grid 7 37.4 M4 | Grid 8 45.1 M4 | Grid 9 45.6 M4 |

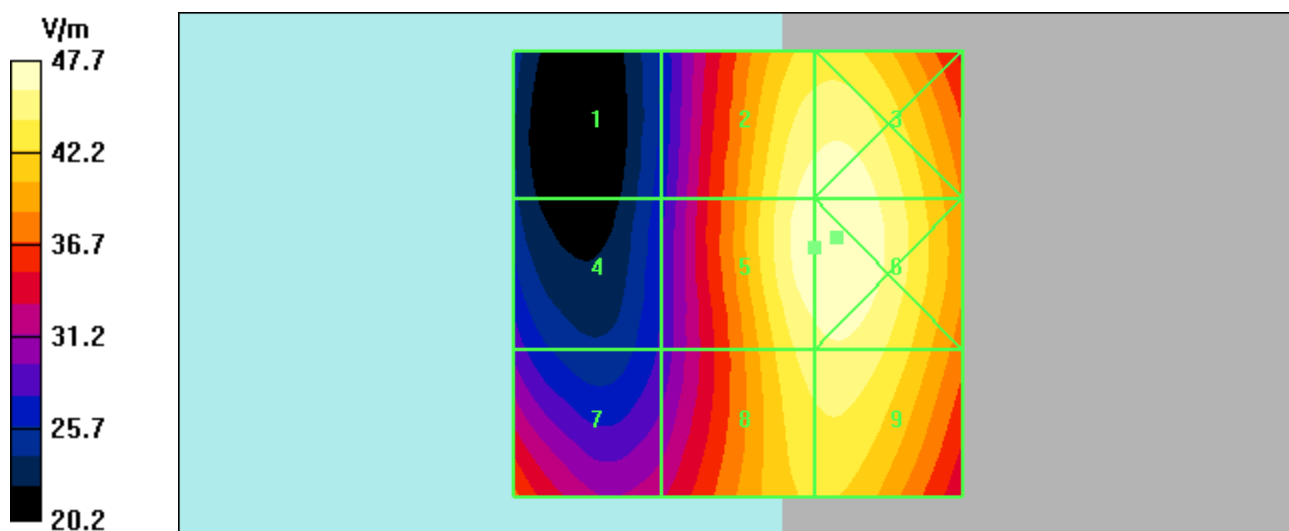

Test Laboratory: Motorola - CDMA 800 H-Field, Full Rate
Serial: LUWV260010; FCC ID: IHDT56PE2

Communication System: CDMA 835; Frequency: 836.52 MHz; Channel Number: 384; Duty Cycle: 1:1
Medium: Air; Medium parameters used: $\sigma = 0$ mho/m, $\epsilon_r = 1$; $\rho = 0$ kg/m³

DASY4 Configuration:

- Probe: H3DV6 - SN6074; ; Calibrated: 1/11/2013
- Sensor-Surface: (Fix Surface)
- Electronics: DAE3 Sn365; Calibrated: 1/28/2013
- Phantom: R-6, HAC Test Arch (rev.2); Type: SD HAC P01 BA; Serial: 1071; Phantom section: RF Section
- Measurement SW: DASY4, V4.7 Build 80; Postprocessing SW: SEMCAD, V1.8 Build 186

H Scan - Sensor center 15mm above WD, Hearing Aid Compatibility Test (101x101x1):

Measurement grid: dx=5mm, dy=5mm
Maximum value of peak Total field = 0.108 A/m; Probe Modulation Factor = 1.02
Device Reference Point: 0.000, 0.000, -6.30 mm; Reference Value = 0.075 A/m; Power Drift = -0.046 dB

Hearing Aid Near-Field Category: M4 (AWF 0 dB)

Peak H-field in A/m

| | | |
|---------------------------|---------------------------|---------------------------|
| Grid 1 0.144 M4 | Grid 2 0.104 M4 | Grid 3 0.055 M4 |
| Grid 4 0.132 M4 | Grid 5 0.097 M4 | Grid 6 0.063 M4 |
| Grid 7 0.146 M4 | Grid 8 0.108 M4 | Grid 9 0.074 M4 |

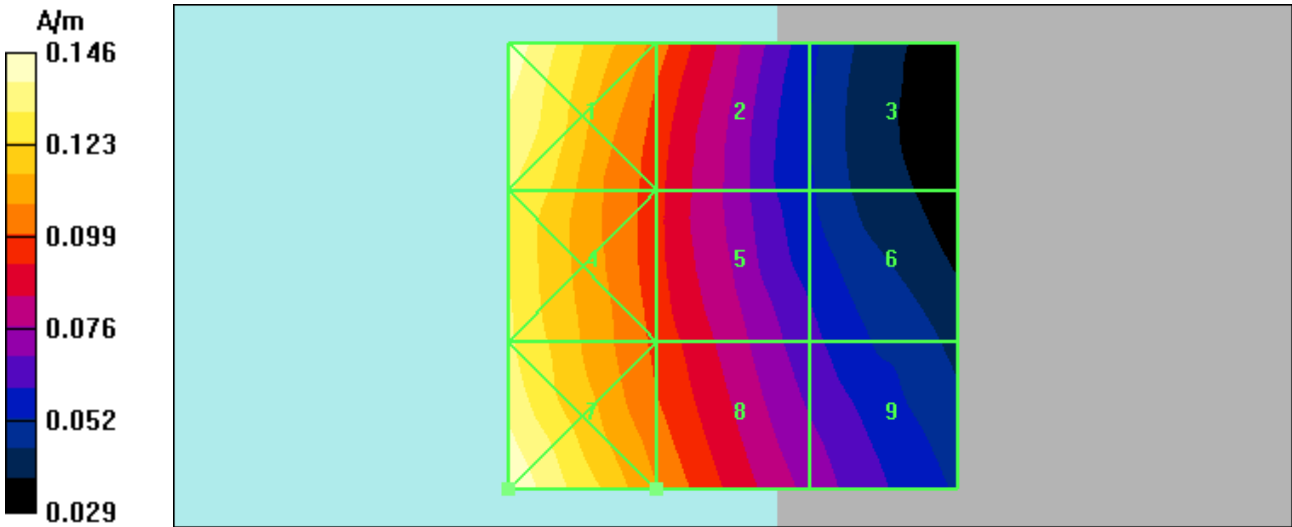

Test Laboratory: Motorola - CDMA 800 H-Field, 1/8th Rate
Serial: LUWV260010; FCC ID: IHDT56PE2

Communication System: CDMA 835, 1/8 Vocoder; Frequency: 836.52 MHz; Channel Number: 384; Duty Cycle: 1:8
 Medium: Air; Medium parameters used: $\sigma = 0$ mho/m, $\epsilon_r = 1$; $\rho = 0$ kg/m³

DASY4 Configuration:

- Probe: H3DV6 - SN6074; ; Calibrated: 1/11/2013
- Sensor-Surface: (Fix Surface)
- Electronics: DAE3 Sn365; Calibrated: 1/28/2013
- Phantom: R-6, HAC Test Arch (rev.2); Type: SD HAC P01 BA; Serial: 1071; Phantom section: RF Section
- Measurement SW: DASY4, V4.7 Build 80; Postprocessing SW: SEMCAD, V1.8 Build 186

H Scan - Sensor center 15mm above WD, Hearing Aid Compatibility Test (101x101x1):

Measurement grid: dx=5mm, dy=5mm

Maximum value of peak Total field = 0.099 A/m; Probe Modulation Factor = 2.53

Device Reference Point: 0.000, 0.000, -6.30 mm; Reference Value = 0.029 A/m; Power Drift = -0.041 dB

Hearing Aid Near-Field Category: M4 (AWF 0 dB)

Peak H-field in A/m

| | | |
|---------------------------|---------------------------|---------------------------|
| Grid 1 0.135 M4 | Grid 2 0.094 M4 | Grid 3 0.053 M4 |
| Grid 4 0.122 M4 | Grid 5 0.092 M4 | Grid 6 0.061 M4 |
| Grid 7 0.135 M4 | Grid 8 0.099 M4 | Grid 9 0.071 M4 |

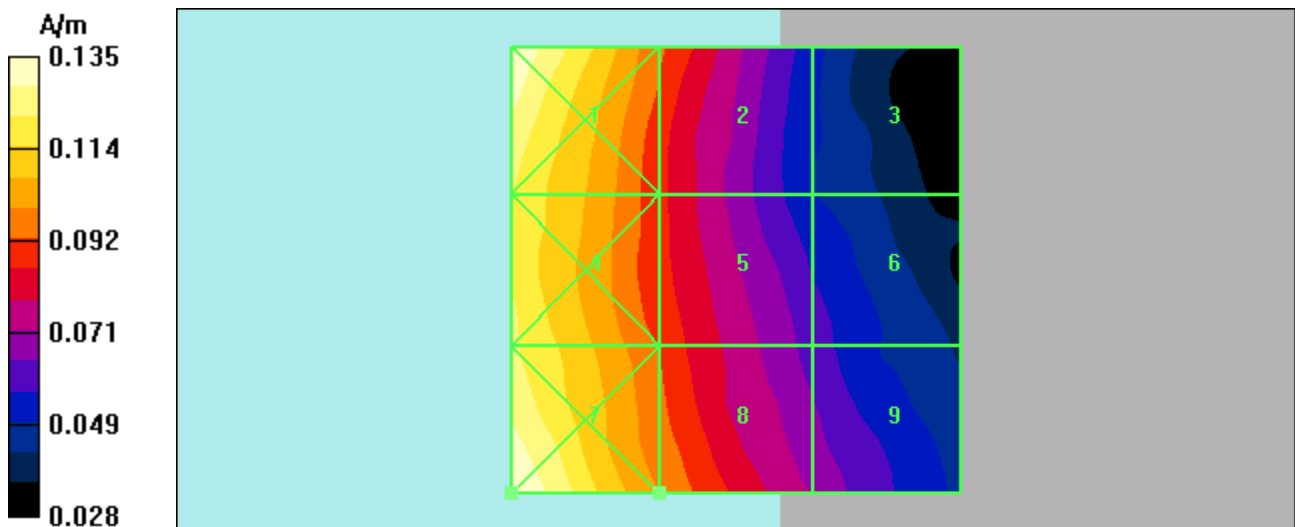

Test Laboratory: Motorola - CDMA 1900 H-Field, Full Rate
Serial: LUWV260010; FCC ID: IHDT56PE2

Communication System: CDMA 1900; Frequency: 1880 MHz; Channel Number: 600; Duty Cycle: 1:1
 Medium: Air; Medium parameters used: $\sigma = 0$ mho/m, $\epsilon_r = 1$; $\rho = 0$ kg/m³

DASY4 Configuration:

- Probe: H3DV6 - SN6074; ; Calibrated: 1/11/2013
- Sensor-Surface: (Fix Surface)
- Electronics: DAE3 Sn365; Calibrated: 1/28/2013
- Phantom: R-6, HAC Test Arch (rev.2); Type: SD HAC P01 BA; Serial: 1071; Phantom section: RF Section
- Measurement SW: DASY4, V4.7 Build 80; Postprocessing SW: SEMCAD, V1.8 Build 186

H Scan - Sensor center 15mm above WD, Hearing Aid Compatibility Test (101x101x1):

Measurement grid: dx=5mm, dy=5mm

Maximum value of peak Total field = 0.155 A/m; Probe Modulation Factor = 1.03

Device Reference Point: 0.000, 0.000, -6.30 mm; Reference Value = 0.111 A/m; Power Drift = -0.095 dB

Hearing Aid Near-Field Category: M4 (AWF 0 dB)

Peak H-field in A/m

| | | |
|---------------------------|---------------------------|---------------------------|
| Grid 1 0.155 M4 | Grid 2 0.142 M4 | Grid 3 0.096 M4 |
| Grid 4 0.153 M4 | Grid 5 0.142 M4 | Grid 6 0.101 M4 |
| Grid 7 0.176 M4 | Grid 8 0.165 M4 | Grid 9 0.123 M4 |

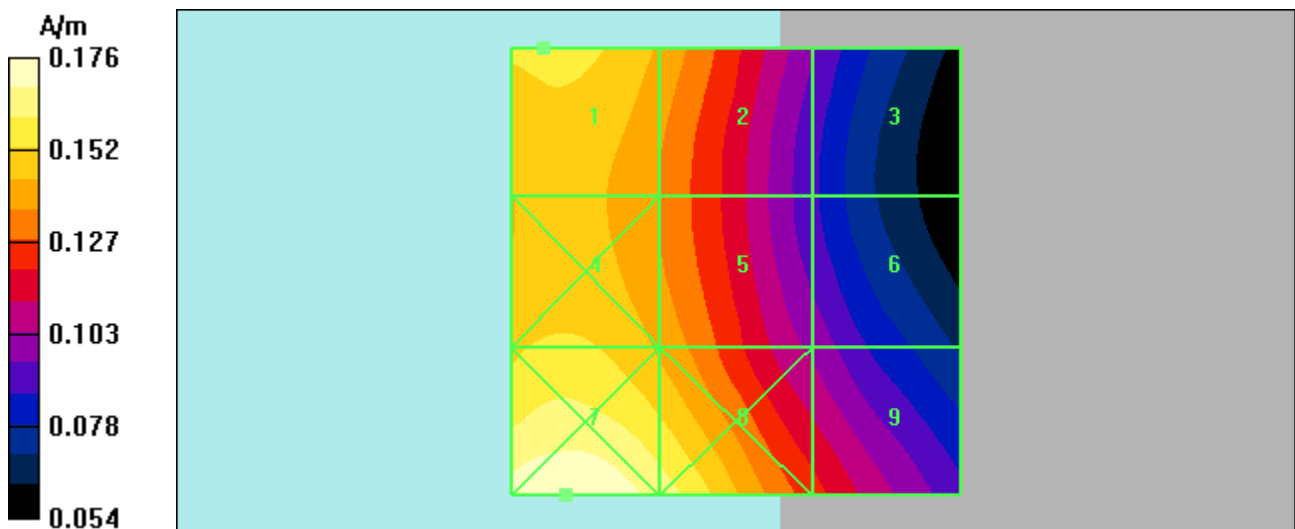

Test Laboratory: Motorola - CDMA 1900 H-Field, 1/8th Rate
Serial: LUWV260010; FCC ID: IHDT56PE2

Communication System: CDMA 1900, 8th Vocoder; Frequency: 1880 MHz; Channel Number: 600; Duty Cycle: 1:8
Medium: Air; Medium parameters used: $\sigma = 0$ mho/m, $\epsilon_r = 1$; $\rho = 0$ kg/m³

DASY4 Configuration:

- Probe: H3DV6 - SN6074; ; Calibrated: 1/11/2013
- Sensor-Surface: (Fix Surface)
- Electronics: DAE3 Sn365; Calibrated: 1/28/2013
- Phantom: R-6, HAC Test Arch (rev.2); Type: SD HAC P01 BA; Serial: 1071; Phantom section: RF Section
- Measurement SW: DASY4, V4.7 Build 80; Postprocessing SW: SEMCAD, V1.8 Build 186

H Scan - Sensor center 15mm above WD, Hearing Aid Compatibility Test (101x101x1):

Measurement grid: dx=5mm, dy=5mm

Maximum value of peak Total field = 0.142 A/m; Probe Modulation Factor = 2.54

Device Reference Point: 0.000, 0.000, -6.30 mm; Reference Value = 0.041 A/m; Power Drift = -0.092 dB

Hearing Aid Near-Field Category: M4 (AWF 0 dB)

Peak H-field in A/m

| | | |
|----------------------------------|---------------------------|---------------------------|
| Grid 1 0.142 M4 | Grid 2 0.130 M4 | Grid 3 0.086 M4 |
| Grid 4 0.140 M4 | Grid 5 0.128 M4 | Grid 6 0.101 M4 |
| Grid 7 0.162 M4 | Grid 8 0.149 M4 | Grid 9 0.111 M4 |

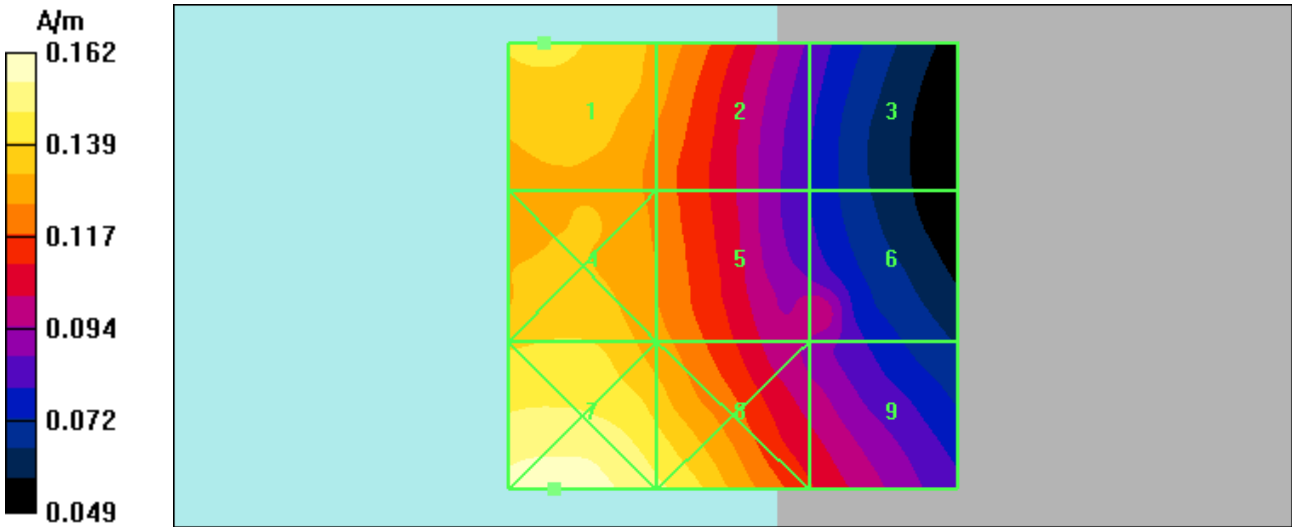

Test Laboratory: Motorola - GSM 850 H-Field
Serial: LUWV260010; FCC ID: IHDT56PE2

Communication System: GSM 850; Frequency: 848.8 MHz; Channel Number: 251; Duty Cycle: 1:8.3
 Medium: Air; Medium parameters used: $\sigma = 0$ mho/m, $\epsilon_r = 1$; $\rho = 0$ kg/m³

DASY4 Configuration:

- Probe: H3DV6 - SN6074; ; Calibrated: 1/11/2013
- Sensor-Surface: (Fix Surface)
- Electronics: DAE3 Sn365; Calibrated: 1/28/2013
- Phantom: R-6, HAC Test Arch (rev.2); Type: SD HAC P01 BA; Serial: 1071; Phantom section: RF Section
- Measurement SW: DASY4, V4.7 Build 80; Postprocessing SW: SEMCAD, V1.8 Build 186

H Scan - Sensor center 15mm above WD, Hearing Aid Compatibility Test (101x101x1):

Measurement grid: dx=5mm, dy=5mm

Maximum value of peak Total field = 0.169 A/m; Probe Modulation Factor = 2.44

Device Reference Point: 0.000, 0.000, -6.30 mm; Reference Value = 0.046 A/m; Power Drift = 0.119 dB

Hearing Aid Near-Field Category: M4 (AWF -5 dB)

Peak H-field in A/m

| | | |
|---------------------------|---------------------------|---------------------------|
| Grid 1 0.219 M4 | Grid 2 0.152 M4 | Grid 3 0.087 M4 |
| Grid 4 0.207 M4 | Grid 5 0.151 M4 | Grid 6 0.089 M4 |
| Grid 7 0.233 M4 | Grid 8 0.169 M4 | Grid 9 0.107 M4 |

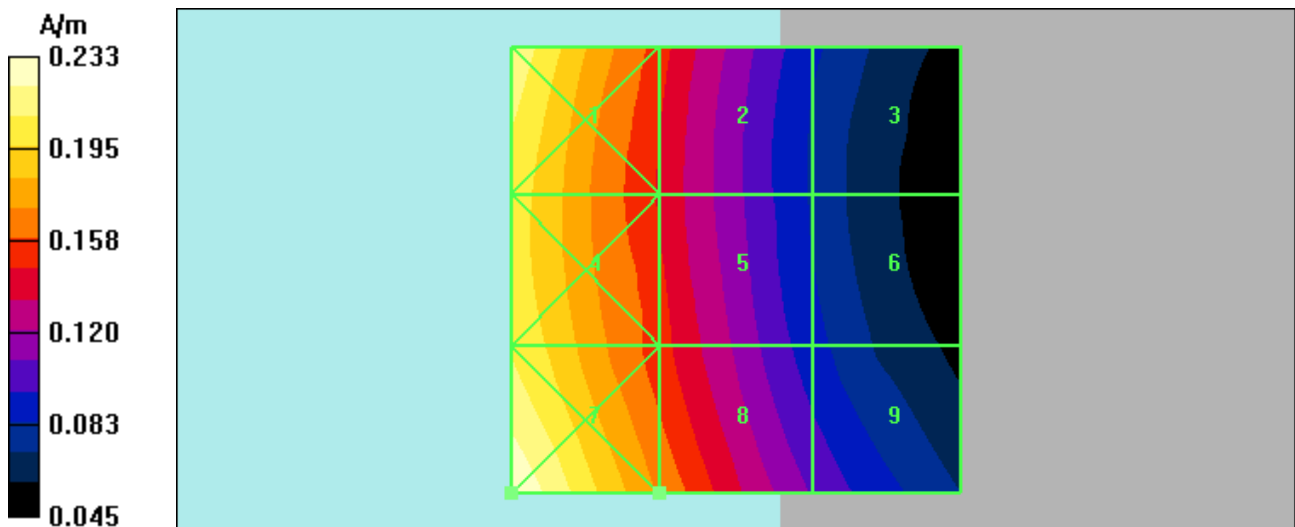

Test Laboratory: Motorola - GSM 1900 H-Field
Serial: LUWV260010; FCC ID: IHDT56PE2

Communication System: GSM 1900; Frequency: 1850.2 MHz; Channel Number: 512; Duty Cycle: 1:8.3
 Medium: Air; Medium parameters used: $\sigma = 0$ mho/m, $\epsilon_r = 1$; $\rho = 0$ kg/m³

DASY4 Configuration:

- Probe: H3DV6 - SN6074; ; Calibrated: 1/11/2013
- Sensor-Surface: (Fix Surface)
- Electronics: DAE3 Sn365; Calibrated: 1/28/2013
- Phantom: R-6, HAC Test Arch (rev.2); Type: SD HAC P01 BA; Serial: 1071; Phantom section: RF Section
- Measurement SW: DASY4, V4.7 Build 80; Postprocessing SW: SEMCAD, V1.8 Build 186

H Scan - Sensor center 15mm above WD, Hearing Aid Compatibility Test (101x101x1):

Measurement grid: dx=5mm, dy=5mm

Maximum value of peak Total field = 0.203 A/m; Probe Modulation Factor = 2.58

Device Reference Point: 0.000, 0.000, -6.30 mm; Reference Value = 0.060 A/m; Power Drift = -0.031 dB

Hearing Aid Near-Field Category: M3 (AWF -5 dB)

Peak H-field in A/m

| | | |
|---------------------------|---------------------------|---------------------------|
| Grid 1 0.216 M3 | Grid 2 0.195 M3 | Grid 3 0.126 M4 |
| Grid 4 0.194 M3 | Grid 5 0.183 M3 | Grid 6 0.131 M4 |
| Grid 7 0.219 M3 | Grid 8 0.203 M3 | Grid 9 0.153 M3 |

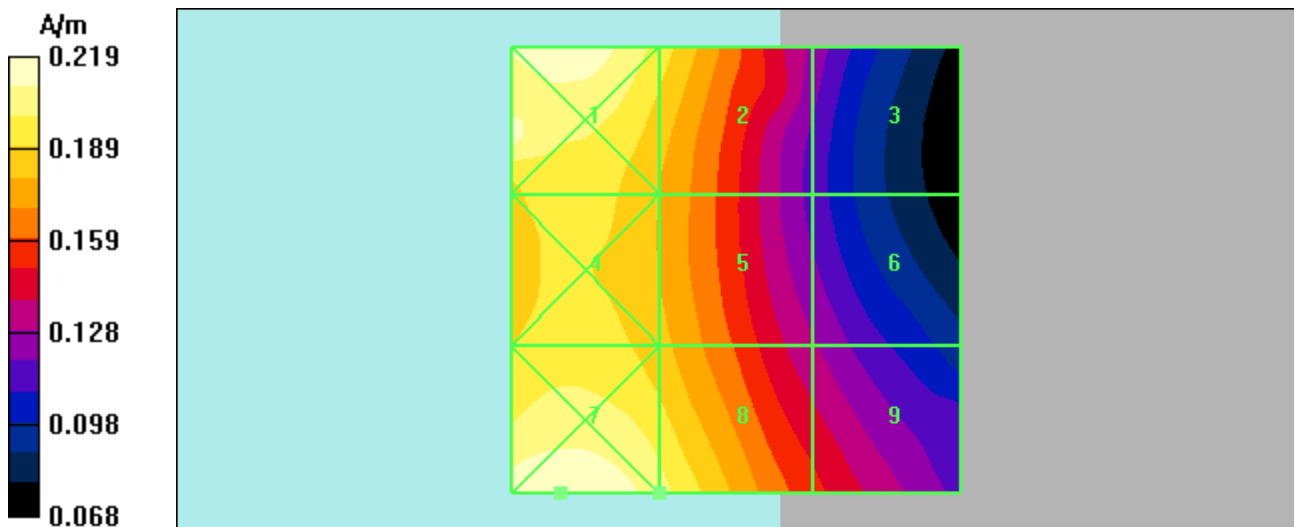

Test Laboratory: Motorola - WCDMA 850 H-Field
Serial: LUWV260010; FCC ID: IHDT56PE2

Communication System: WCDMA 850; Frequency: 836 MHz; Channel Number: 4180; Duty Cycle: 1:1
 Medium: Air; Medium parameters used: $\sigma = 0$ mho/m, $\epsilon_r = 1$; $\rho = 0$ kg/m³

DASY4 Configuration:

- Probe: H3DV6 - SN6074; ; Calibrated: 1/11/2013
- Sensor-Surface: (Fix Surface)
- Electronics: DAE3 Sn365; Calibrated: 1/28/2013
- Phantom: R-6, HAC Test Arch (rev.2); Type: SD HAC P01 BA; Serial: 1071; Phantom section: RF Section
- Measurement SW: DASY4, V4.7 Build 80; Postprocessing SW: SEMCAD, V1.8 Build 186

H Scan - Sensor center 15mm above WD, Hearing Aid Compatibility Test (101x101x1):

Measurement grid: dx=5mm, dy=5mm

Maximum value of peak Total field = 0.067 A/m; Probe Modulation Factor = 0.920

Device Reference Point: 0.000, 0.000, -6.30 mm; Reference Value = 0.051 A/m; Power Drift = 0.054 dB

Hearing Aid Near-Field Category: M4 (AWF 0 dB)

Peak H-field in A/m

| | | |
|---------------------------|---------------------------|---------------------------|
| Grid 1 0.088 M4 | Grid 2 0.062 M4 | Grid 3 0.034 M4 |
| Grid 4 0.081 M4 | Grid 5 0.060 M4 | Grid 6 0.039 M4 |
| Grid 7 0.090 M4 | Grid 8 0.067 M4 | Grid 9 0.045 M4 |

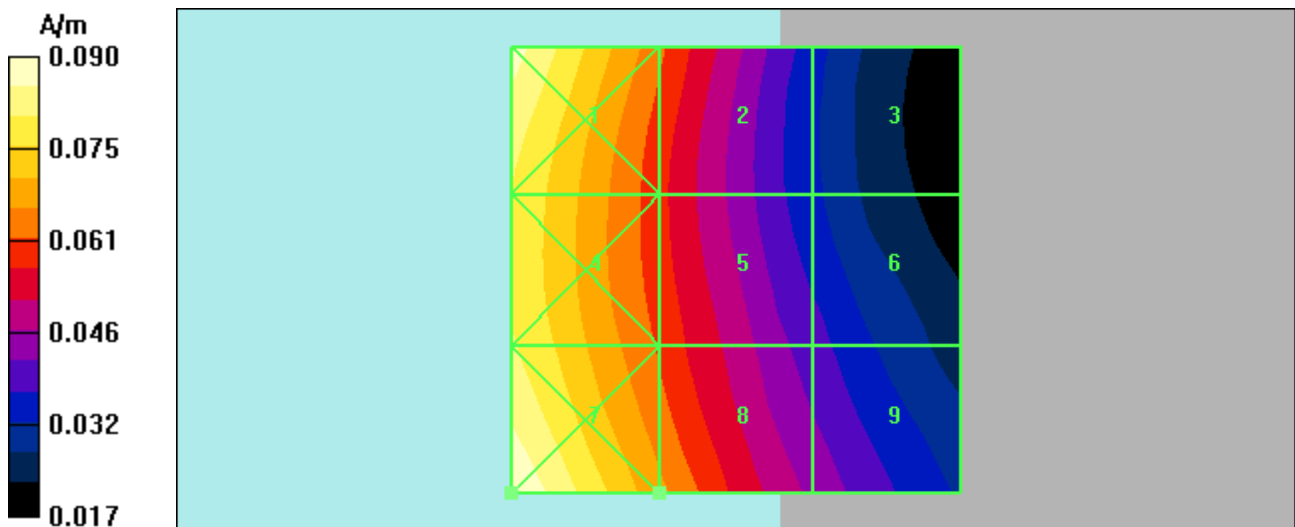

Test Laboratory: Motorola - WCDMA 1900 H-Field
Serial: LUWV260010; FCC ID: IHDT56PE2

Communication System: WCDMA 1900; Frequency: 1852.5 MHz; Channel Number: 9262; Duty Cycle: 1:1
 Medium: Air; Medium parameters used: $\sigma = 0$ mho/m, $\epsilon_r = 1$; $\rho = 0$ kg/m³

DASY4 Configuration:

- Probe: H3DV6 - SN6074; ; Calibrated: 1/11/2013
- Sensor-Surface: (Fix Surface)
- Electronics: DAE3 Sn365; Calibrated: 1/28/2013
- Phantom: R-6, HAC Test Arch (rev.2); Type: SD HAC P01 BA; Serial: 1071; Phantom section: RF Section
- Measurement SW: DASY4, V4.7 Build 80; Postprocessing SW: SEMCAD, V1.8 Build 186

H Scan - Sensor center 15mm above WD, Hearing Aid Compatibility Test (101x101x1):

Measurement grid: dx=5mm, dy=5mm

Maximum value of peak Total field = 0.135 A/m; Probe Modulation Factor = 0.930

Device Reference Point: 0.000, 0.000, -6.30 mm; Reference Value = 0.105 A/m; Power Drift = 0.043 dB

Hearing Aid Near-Field Category: M4 (AWF 0 dB)

Peak H-field in A/m

| | | |
|---------------------------|---------------------------|---------------------------|
| Grid 1 0.140 M4 | Grid 2 0.127 M4 | Grid 3 0.085 M4 |
| Grid 4 0.127 M4 | Grid 5 0.119 M4 | Grid 6 0.087 M4 |
| Grid 7 0.143 M4 | Grid 8 0.135 M4 | Grid 9 0.104 M4 |

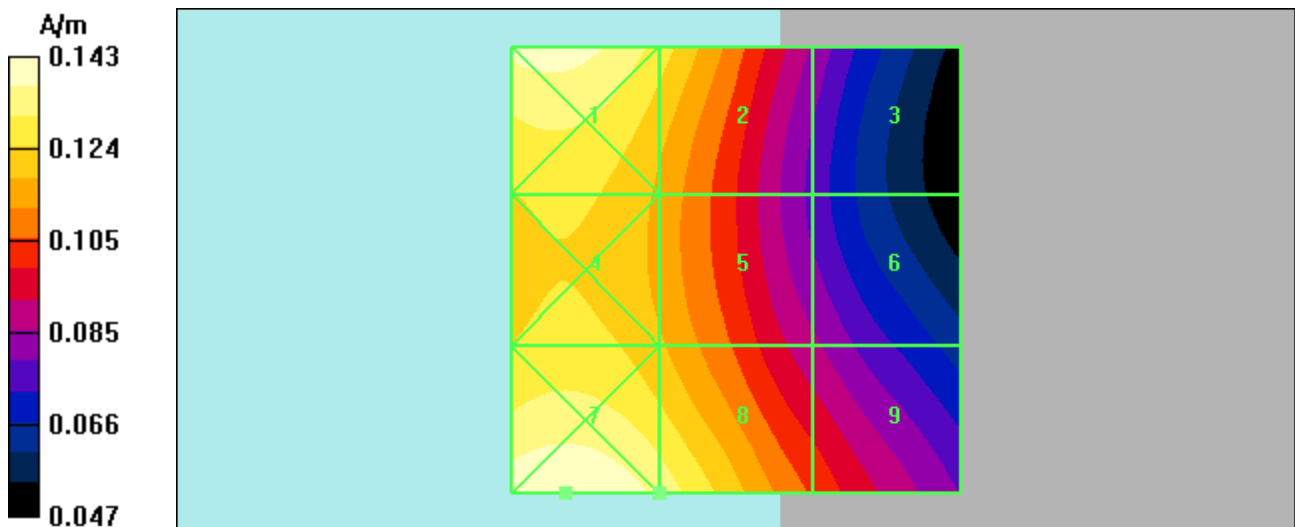

Appendix 4
Measurement Uncertainty Budget

A4.1 Motorola Uncertainty Budget for RF HAC Testing

TABLE A4.1: Motorola Uncertainty Budget

| UNCERTAINTY DESCRIPTION | Uncertainty Value (± %) | Prob. Dist. | Div. | (ci) E | (ci) H | Std. Unc. E | Std. Unc. H |
|---|-------------------------|-------------|--------|--------|--------|-------------|-------------|
| MEASUREMENT SYSTEM | | | | | | | |
| Probe Calibration | 5.1% | N | 1.0000 | 1 | 1 | 5.1% | 5.1% |
| Axial Isotropy | 7.8% | R | 1.7321 | 1 | 0.786 | 4.5% | 3.5% |
| Sensor Displacement | 16.5% | R | 1.7321 | 1 | 0.145 | 9.5% | 1.4% |
| Test Arch | 7.2% | R | 1.7321 | 1 | 0 | 4.2% | 0.0% |
| Linearity | 4.7% | R | 1.7321 | 1 | 1 | 2.7% | 2.7% |
| Scaling to Peak Envelope Power | 2.0% | R | 1.7321 | 1 | 1 | 1.2% | 1.2% |
| System Detection Limit | 1.0% | R | 1.7321 | 1 | 1 | 0.6% | 0.6% |
| Readout Electronics | 0.3% | N | 1.0000 | 1 | 1 | 0.3% | 0.3% |
| Response Time | 0.8% | R | 1.7321 | 1 | 1 | 0.5% | 0.5% |
| Integration Time | 2.6% | R | 1.7321 | 1 | 1 | 1.5% | 1.5% |
| RF Reflections | 5.6% | R | 1.7321 | 1 | 1 | 3.2% | 3.2% |
| Probe Positioner | 1.2% | R | 1.7321 | 1 | 0.67 | 0.7% | 0.5% |
| Probe Positioning | 4.7% | R | 1.7321 | 1 | 0.67 | 2.7% | 1.8% |
| Extrap. & Interpolation | 1.0% | R | 1.7321 | 1 | 1 | 0.6% | 0.6% |
| TEST SAMPLE RELATED | | | | | | | |
| Total Device Positioning | 3.2% | R | 1.7321 | 1 | 1.306 | 1.8% | 2.4% |
| Device Holder & Phantom | 2.4% | R | 1.7321 | 1 | 1 | 1.4% | 1.4% |
| Power Drift | 5.0% | R | 1.7321 | 1 | 1 | 2.9% | 2.9% |
| PHANTOM AND SETUP RELATED | | | | | | | |
| Phantom Thickness | 2.4% | R | 1.7321 | 1 | 0.67 | 1.4% | 0.9% |
| Combined Std.Uncertainty on Power | | | | | | 14.1% | 9.1% |
| Combined Std.Uncertainty on Field | | | | | | 7.1% | 4.6% |
| Expanded Std. Uncertainty on Power | | | | | | 28.3% | 18.2% |
| Expanded Std. Uncertainty on Field | | | | | | 14.1% | 9.1% |

A4.2 Probe Rotation Contributions to Isotropy Error

Probe rotation data was taken “for special focus on spherical isotropicity in measurement uncertainty and perturbation of EM fields.” This data was taken at the interpolated maximum and directly accounted for in the uncertainty budget as “Axial Isotropy.” Thirteen mobile devices were used to determine the probe isotropy uncertainty factors in section A4.1. Based on the resulting 82 E-Field probe rotations and 82 H-Field probe rotations, the upper 95% confidence interval value was calculated for each. These values represent a conservative assessment of the effect of the probe isotropy and have been appropriately included in the respective E- and H-uncertainty budgets.

TABLE A4.2: Probe Rotation Data Summary

| | AVE | ST. DEV | Sample Size (n) | 2σ | (ci) | Standard Uncertainty |
|---------|------------|----------------|------------------------|-----------|-------------|-----------------------------|
| E-field | 4.4% | 1.7% | 82 | 7.8% | 1 | 4.5% |
| H-field | 3.8% | 1.2% | 82 | 6.1% | 0.786 | 3.5% |

Isotropy error measurements were taken for 13 products across the respective frequency bands. The +2σ values of all measurements was used as a worst case value for the uncertainty budget. Any significant differences between bands were also evaluated.

Appendix 5
Pictures of Test Setup

See Exhibit 7D

Appendix 6
Probe Calibration Certificates



Accredited by the Swiss Accreditation Service (SAS)
The Swiss Accreditation Service is one of the signatories to the EA
Multilateral Agreement for the recognition of calibration certificates

Accreditation No.: **SCS 108**

Client **Motorola MDb**

Certificate No: **ER3-2248_Jan13**

CALIBRATION CERTIFICATE

Object **ER3DV6R - SN:2248**

Calibration procedure(s) **QA CAL-02.v6, QA CAL-25.v4
Calibration procedure for E-field probes optimized for close near field
evaluations in air**

Calibration date: **January 11, 2013**

This calibration certificate documents the traceability to national standards, which realize the physical units of measurements (SI).
The measurements and the uncertainties with confidence probability are given on the following pages and are part of the certificate.

All calibrations have been conducted in the closed laboratory facility: environment temperature (22 ± 3)°C and humidity < 70%.

Calibration Equipment used (M&TE critical for calibration)

| Primary Standards | ID | Cal Date (Certificate No.) | Scheduled Calibration |
|----------------------------|-----------------|-----------------------------------|------------------------|
| Power meter E4419B | GB41293874 | 29-Mar-12 (No. 217-01508) | Apr-13 |
| Power sensor E4412A | MY41498087 | 29-Mar-12 (No. 217-01508) | Apr-13 |
| Reference 3 dB Attenuator | SN: S5054 (3c) | 27-Mar-12 (No. 217-01531) | Apr-13 |
| Reference 20 dB Attenuator | SN: S5086 (20b) | 27-Mar-12 (No. 217-01529) | Apr-13 |
| Reference 30 dB Attenuator | SN: S5129 (30b) | 27-Mar-12 (No. 217-01532) | Apr-13 |
| Reference Probe ER3DV6 | SN: 2328 | 12-Oct-12 (No. ER3-2328_Oct12) | Oct-13 |
| DAE4 | SN: 789 | 18-Sep-12 (No. DAE4-789_Sep12) | Sep-13 |
| | | | |
| Secondary Standards | ID | Check Date (in house) | Scheduled Check |
| RF generator HP 8648C | US3642U01700 | 4-Aug-99 (in house check Apr-11) | In house check: Apr-13 |
| Network Analyzer HP 8753E | US37390585 | 18-Oct-01 (in house check Oct-12) | In house check: Oct-13 |

| | Name | Function | Signature |
|----------------|-----------------|-----------------------|-----------|
| Calibrated by: | Claudio Leubler | Laboratory Technician | |
| Approved by: | Katja Pokovic | Technical Manager | |

Issued: January 16, 2013

This calibration certificate shall not be reproduced except in full without written approval of the laboratory.



Accredited by the Swiss Accreditation Service (SAS)

Accreditation No.: **SCS 108**

The Swiss Accreditation Service is one of the signatories to the EA
Multilateral Agreement for the recognition of calibration certificates

Glossary:

| | |
|--------------------------|---|
| NORM _{x,y,z} | sensitivity in free space |
| DCP | diode compression point |
| CF | crest factor (1/duty_cycle) of the RF signal |
| A, B, C, D | modulation dependent linearization parameters |
| Polarization φ | φ rotation around probe axis |
| Polarization ϑ | ϑ rotation around an axis that is in the plane normal to probe axis (at measurement center), i.e., $\vartheta = 0$ is normal to probe axis |
| Connector Angle | information used in DASY system to align probe sensor X to the robot coordinate system |

Calibration is Performed According to the Following Standards:

- IEEE Std 1309-2005, " IEEE Standard for calibration of electromagnetic field sensors and probes, excluding antennas, from 9 kHz to 40 GHz", December 2005
- CTIA Test Plan for Hearing Aid Compatibility, April 2010.

Methods Applied and Interpretation of Parameters:

- NORM_{x,y,z}*: Assessed for E-field polarization $\vartheta = 0$ for XY sensors and $\vartheta = 90$ for Z sensor ($f \leq 900$ MHz in TEM-cell; $f > 1800$ MHz: R22 waveguide).
- NORM(f)_{x,y,z}* = *NORM_{x,y,z}* * *frequency_response* (see Frequency Response Chart).
- DCP_{x,y,z}*: DCP are numerical linearization parameters assessed based on the data of power sweep with CW signal (no uncertainty required). DCP does not depend on frequency nor media.
- PAR*: PAR is the Peak to Average Ratio that is not calibrated but determined based on the signal characteristics
- A_{x,y,z}; B_{x,y,z}; C_{x,y,z}; D_{x,y,z}; VR_{x,y,z}*: A, B, C, D are numerical linearization parameters assessed based on the data of power sweep for specific modulation signal. The parameters do not depend on frequency nor media. VR is the maximum calibration range expressed in RMS voltage across the diode.
- Spherical isotropy (3D deviation from isotropy)*: in a locally homogeneous field realized using an open waveguide setup.
- Sensor Offset*: The sensor offset corresponds to the offset of virtual measurement center from the probe tip (on probe axis). No tolerance required.
- Connector Angle*: The angle is assessed using the information gained by determining the *NORM_x* (no uncertainty required).

Probe ER3DV6R

SN:2248

Manufactured: January 1, 2000
Calibrated: January 11, 2013

Calibrated for DASY/EASY Systems
(Note: non-compatible with DASY2 system!)

DASY/EASY - Parameters of Probe: ER3DV6R - SN:2248

Basic Calibration Parameters

| | Sensor X | Sensor Y | Sensor Z | Unc (k=2) |
|--|----------|----------|----------|---------------|
| Norm ($\mu\text{V}/(\text{V}/\text{m})^2$) | 2.03 | 2.03 | 2.10 | $\pm 10.1 \%$ |
| DCP (mV) ^B | 99.1 | 98.1 | 99.3 | |

Modulation Calibration Parameters

| UID | Communication System Name | | A dB | B dB $\sqrt{\mu\text{V}}$ | C | D dB | VR mV | Unc ^E (k=2) |
|-----|---------------------------|---|---------|------------------------------|-----|---------|----------|---------------------------|
| 0 | CW | X | 0.0 | 0.0 | 1.0 | 0.00 | 185.3 | $\pm 3.5 \%$ |
| | | Y | 0.0 | 0.0 | 1.0 | | 179.6 | |
| | | Z | 0.0 | 0.0 | 1.0 | | 170.1 | |

The reported uncertainty of measurement is stated as the standard uncertainty of measurement multiplied by the coverage factor $k=2$, which for a normal distribution corresponds to a coverage probability of approximately 95%.

^B Numerical linearization parameter: uncertainty not required.

^E Uncertainty is determined using the max. deviation from linear response applying rectangular distribution and is expressed for the square of the field value.

Frequency Response of E-Field (TEM-Cell:ifi110 EXX, Waveguide: R22)

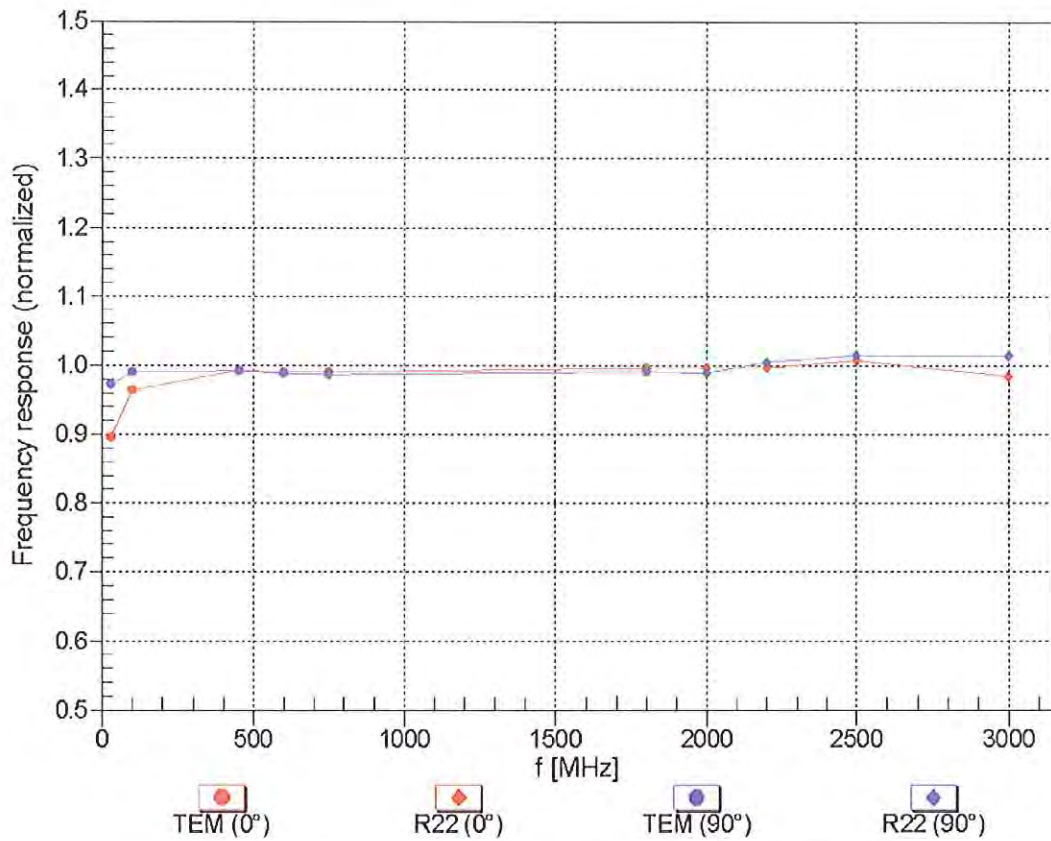

Uncertainty of Frequency Response of E-field: $\pm 6.3\%$ (k=2)

Receiving Pattern (ϕ), $\vartheta = 0^\circ$

f=600 MHz, TEM, 0°

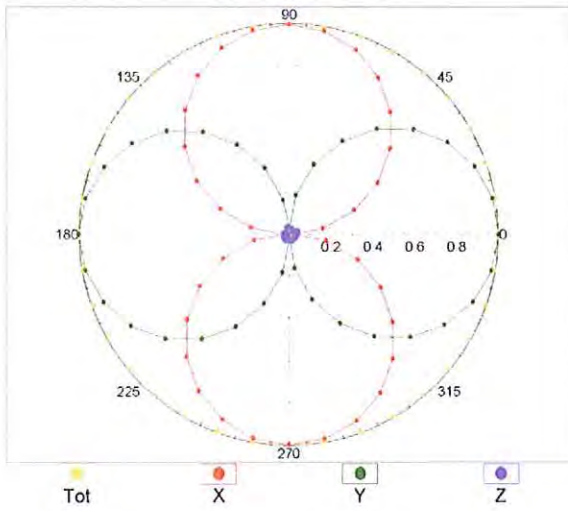

f=2500 MHz, R22, 0°

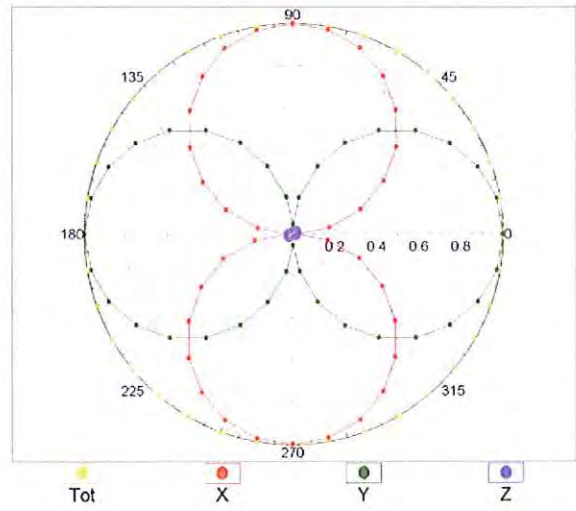

Receiving Pattern (ϕ), $\vartheta = 90^\circ$

f=600 MHz, TEM, 90°

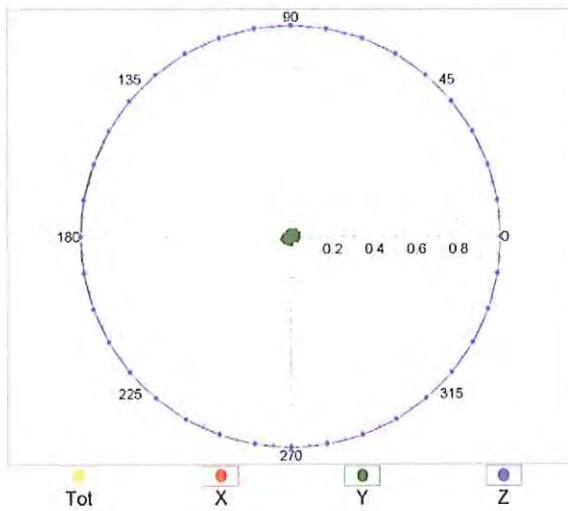

f=2500 MHz, R22, 90°

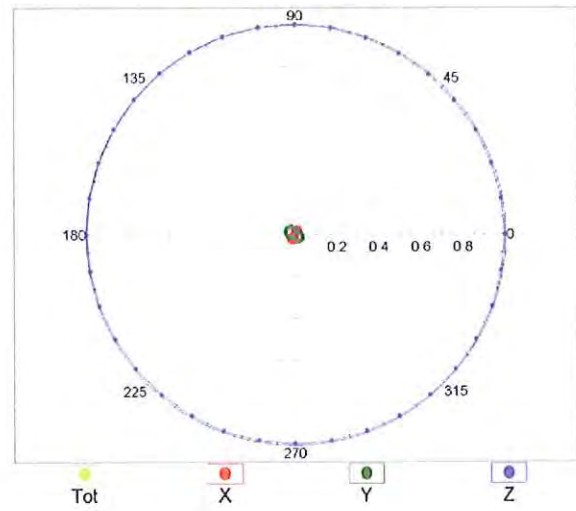

Receiving Pattern (ϕ), $\vartheta = 0^\circ$

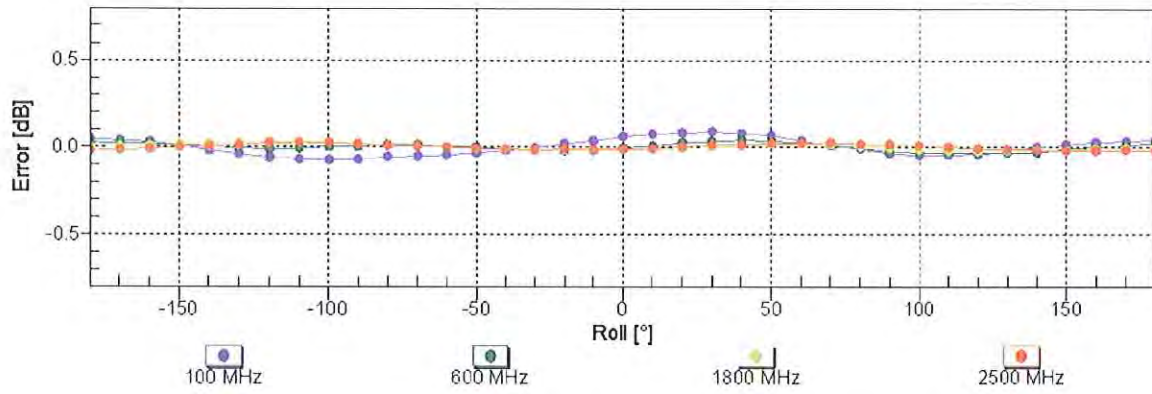

Uncertainty of Axial Isotropy Assessment: $\pm 0.5\%$ ($k=2$)

Receiving Pattern (ϕ), $\vartheta = 90^\circ$

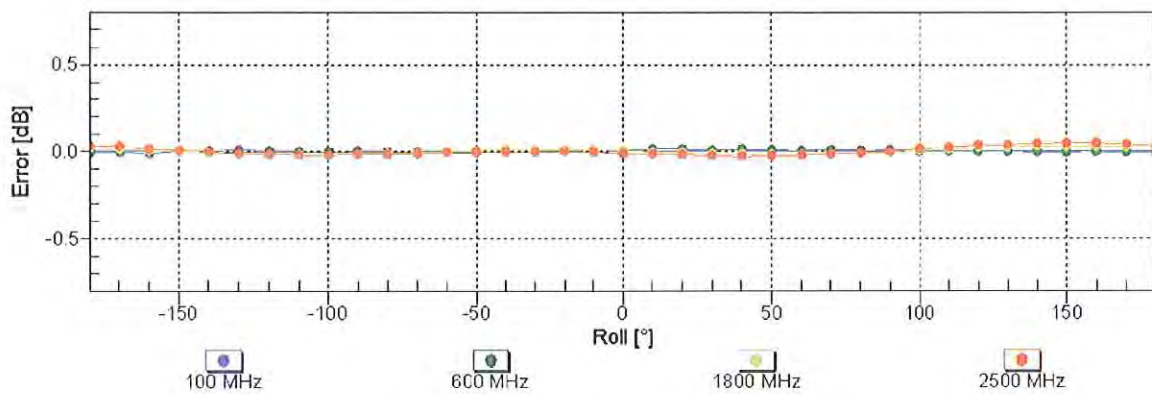

Uncertainty of Axial Isotropy Assessment: $\pm 0.5\%$ ($k=2$)

Dynamic Range f(E-field) (TEM cell , f = 900 MHz)

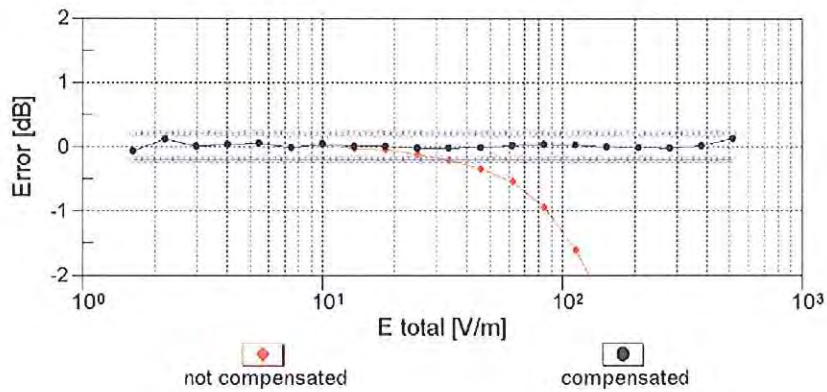
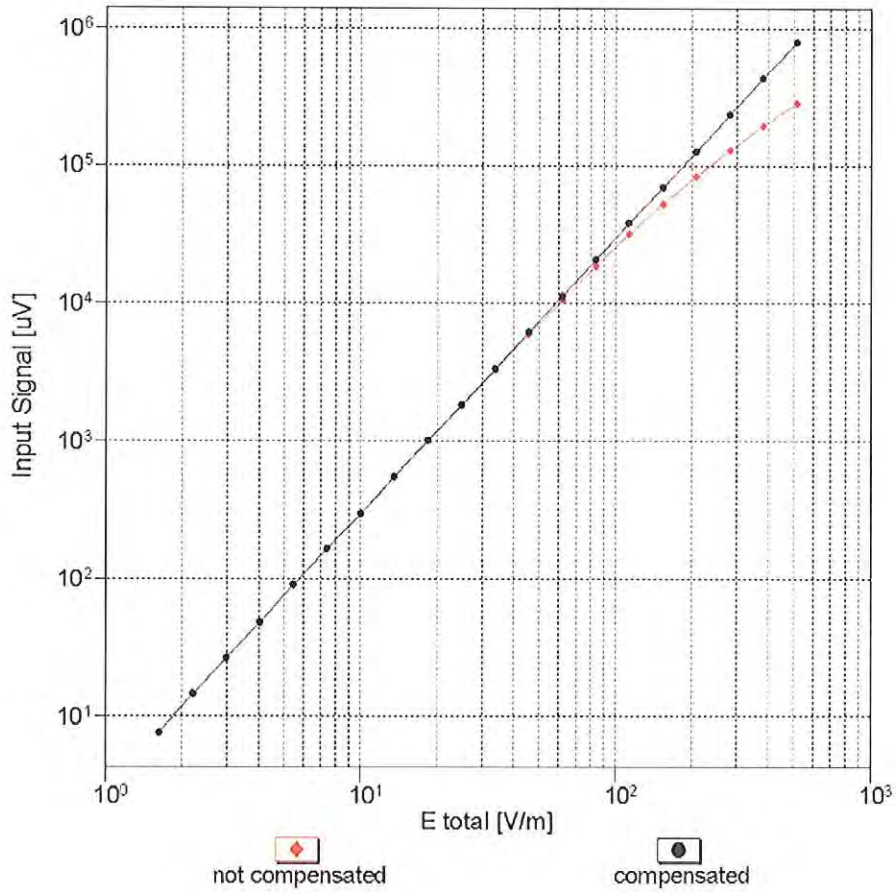

Uncertainty of Linearity Assessment: ± 0.6% (k=2)

Deviation from Isotropy in Air

Error (ϕ , θ), $f = 900$ MHz

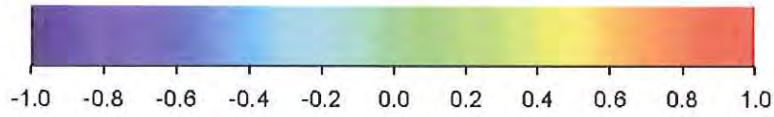
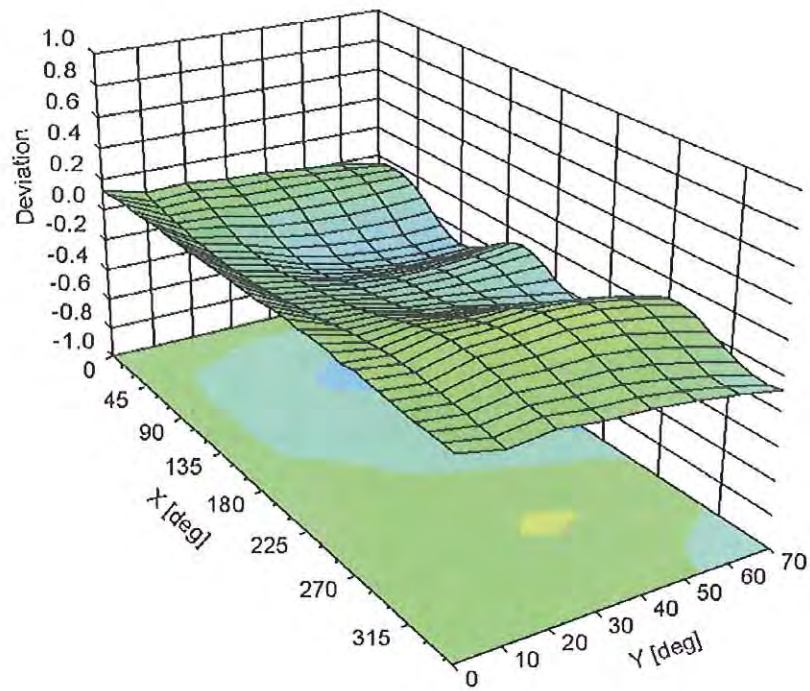

Uncertainty of Spherical Isotropy Assessment: $\pm 2.6\%$ ($k=2$)

DASY/EASY - Parameters of Probe: ER3DV6R - SN:2248

Other Probe Parameters

| | |
|---|-------------|
| Sensor Arrangement | Rectangular |
| Connector Angle (°) | 20.1 |
| Mechanical Surface Detection Mode | enabled |
| Optical Surface Detection Mode | disabled |
| Probe Overall Length | 337 mm |
| Probe Body Diameter | 10 mm |
| Tip Length | 10 mm |
| Tip Diameter | 8 mm |
| Probe Tip to Sensor X Calibration Point | 2.5 mm |
| Probe Tip to Sensor Y Calibration Point | 2.5 mm |
| Probe Tip to Sensor Z Calibration Point | 2.5 mm |



Accredited by the Swiss Accreditation Service (SAS)
The Swiss Accreditation Service is one of the signatories to the EA
Multilateral Agreement for the recognition of calibration certificates

Accreditation No.: **SCS 108**

Client **Motorola MDb**

Certificate No: **H3-6074_Jan13**

CALIBRATION CERTIFICATE

Object **H3DV6 - SN:6074**

Calibration procedure(s) **QA CAL-03.v6, QA CAL-25.v4
Calibration procedure for H-field probes optimized for close near field
evaluations in air**

Calibration date: **January 11, 2013**

This calibration certificate documents the traceability to national standards, which realize the physical units of measurements (SI).
The measurements and the uncertainties with confidence probability are given on the following pages and are part of the certificate.

All calibrations have been conducted in the closed laboratory facility: environment temperature (22 ± 3)°C and humidity < 70%.

Calibration Equipment used (M&TE critical for calibration)

| Primary Standards | ID | Cal Date (Certificate No.) | Scheduled Calibration |
|----------------------------|-----------------|-----------------------------------|------------------------|
| Power meter E4419B | GB41293874 | 29-Mar-12 (No. 217-01508) | Apr-13 |
| Power sensor E4412A | MY41498087 | 29-Mar-12 (No. 217-01508) | Apr-13 |
| Reference 3 dB Attenuator | SN: S5054 (3c) | 27-Mar-12 (No. 217-01531) | Apr-13 |
| Reference 20 dB Attenuator | SN: S5086 (20b) | 27-Mar-12 (No. 217-01529) | Apr-13 |
| Reference 30 dB Attenuator | SN: S5129 (30b) | 27-Mar-12 (No. 217-01532) | Apr-13 |
| Reference Probe H3DV6 | SN: 6182 | 12-Oct-12 (No. H3-6182_Oct12) | Oct-13 |
| DAE4 | SN: 789 | 18-Sep-12 (No. DAE4-789_Sep12) | Sep-13 |
| Secondary Standards | ID | Check Date (in house) | Scheduled Check |
| RF generator HP 8648C | US3642U01700 | 4-Aug-99 (in house check Apr-11) | In house check: Apr-13 |
| Network Analyzer HP 8753E | US37390585 | 18-Oct-01 (in house check Oct-12) | In house check: Oct-13 |

| | | | |
|----------------|--------------------------------|-----------------------------------|--------------------------|
| Calibrated by: | Name Claudio Leubler | Function Laboratory Technician | Signature |
| Approved by: | Katja Pokovic | Technical Manager | |
| | | | Issued: January 16, 2013 |

This calibration certificate shall not be reproduced except in full without written approval of the laboratory.



Accredited by the Swiss Accreditation Service (SAS)

The Swiss Accreditation Service is one of the signatories to the EA
Multilateral Agreement for the recognition of calibration certificates

Accreditation No.: **SCS 108**

Glossary:

| | |
|--------------------------|---|
| NORM _{x,y,z} | sensitivity in free space |
| DCP | diode compression point |
| CF | crest factor (1/duty_cycle) of the RF signal |
| A, B, C, D | modulation dependent linearization parameters |
| Polarization φ | φ rotation around probe axis |
| Polarization ϑ | ϑ rotation around an axis that is in the plane normal to probe axis (at measurement center), i.e., $\vartheta = 0$ is normal to probe axis |
| Connector Angle | information used in DASY system to align probe sensor X to the robot coordinate system |

Calibration is Performed According to the Following Standards:

- IEEE Std 1309-2005, "IEEE Standard for calibration of electromagnetic field sensors and probes, excluding antennas, from 9 kHz to 40 GHz", December 2005.
- CTIA Test Plan for Hearing Aid Compatibility, April 2010.

Methods Applied and Interpretation of Parameters:

- NORM_{x,y,z}**: Assessed for E-field polarization $\vartheta = 0$ for XY sensors and $\vartheta = 90$ for Z sensor ($f \leq 900$ MHz in TEM-cell; $f > 1800$ MHz: R22 waveguide).
- X, Y, Z(f)_a0a1a2** = X, Y, Z_a0a1a2 * frequency_response (see Frequency Response Chart).
- DCP_{x,y,z}**: DCP are numerical linearization parameters assessed based on the data of power sweep with CW signal (no uncertainty required). DCP does not depend on frequency nor media.
- PAR**: PAR is the Peak to Average Ratio that is not calibrated but determined based on the signal characteristics
- A_{x,y,z}; B_{x,y,z}; C_{x,y,z}; D_{x,y,z}; VR_{x,y,z}**: A, B, C, D are numerical linearization parameters assessed based on the data of power sweep for specific modulation signal. The parameters do not depend on frequency nor media. VR is the maximum calibration range expressed in RMS voltage across the diode.
- Spherical isotropy (3D deviation from isotropy)**: in a locally homogeneous field realized using an open waveguide setup.
- Sensor Offset**: The sensor offset corresponds to the offset of virtual measurement center from the probe tip (on probe axis). No tolerance required.
- Connector Angle**: The angle is assessed using the information gained by determining the X_a0a1a2 (no uncertainty required).

Probe H3DV6

SN:6074

Manufactured: October 2, 2000
Calibrated: January 11, 2013

Calibrated for DASY/EASY Systems
(Note: non-compatible with DASY2 system!)

DASY/EASY - Parameters of Probe: H3DV6 - SN:6074

Basic Calibration Parameters

| | | Sensor X | Sensor Y | Sensor Z | Unc (k=2) |
|----------------------------------|----|------------|------------|------------|--------------|
| Norm (A/m / $\sqrt{\text{mV}}$) | a0 | 2.71E-003 | 2.75E-003 | 3.23E-003 | $\pm 5.1 \%$ |
| Norm (A/m / $\sqrt{\text{mV}}$) | a1 | -7.04E-005 | -1.87E-004 | -3.52E-004 | $\pm 5.1 \%$ |
| Norm (A/m / $\sqrt{\text{mV}}$) | a2 | 3.18E-005 | -2.84E-005 | 1.48E-005 | $\pm 5.1 \%$ |
| DCP (mV) ^B | | 90.2 | 92.5 | 92.4 | |

Modulation Calibration Parameters

| UID | Communication System Name | | A dB | B dB $\sqrt{\mu\text{V}}$ | C | D dB | VR mV | Unc ^E (k=2) |
|-----|---------------------------|---|---------|------------------------------|-----|---------|----------|---------------------------|
| 0 | CW | X | 0.0 | 0.0 | 1.0 | 0.00 | 128.8 | $\pm 2.7 \%$ |
| | | Y | 0.0 | 0.0 | 1.0 | | 138.2 | |
| | | Z | 0.0 | 0.0 | 1.0 | | 133.0 | |

The reported uncertainty of measurement is stated as the standard uncertainty of measurement multiplied by the coverage factor $k=2$, which for a normal distribution corresponds to a coverage probability of approximately 95%.

^B Numerical linearization parameter: uncertainty not required.

^E Uncertainty is determined using the max. deviation from linear response applying rectangular distribution and is expressed for the square of the field value.

Frequency Response of H-Field (TEM-Cell:ifi110 EXX, Waveguide: R22)

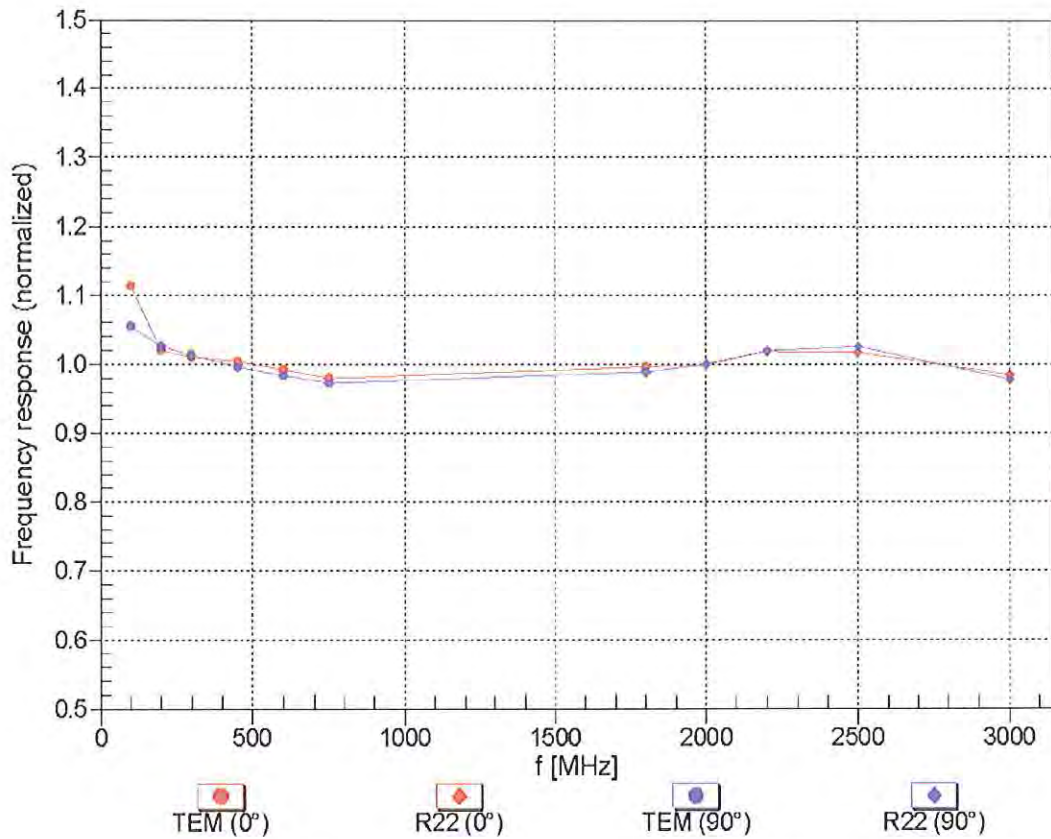

Uncertainty of Frequency Response of H-field: $\pm 6.3\%$ (k=2)

Receiving Pattern (ϕ), $\vartheta = 0^\circ$

f=600 MHz, TEM, 0°

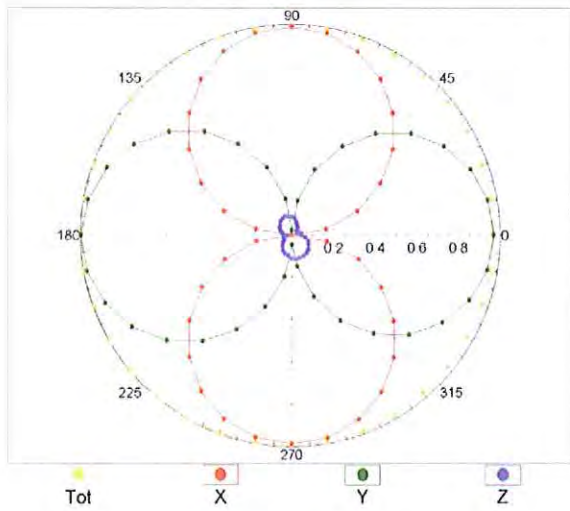

f=2500 MHz, R22, 0°

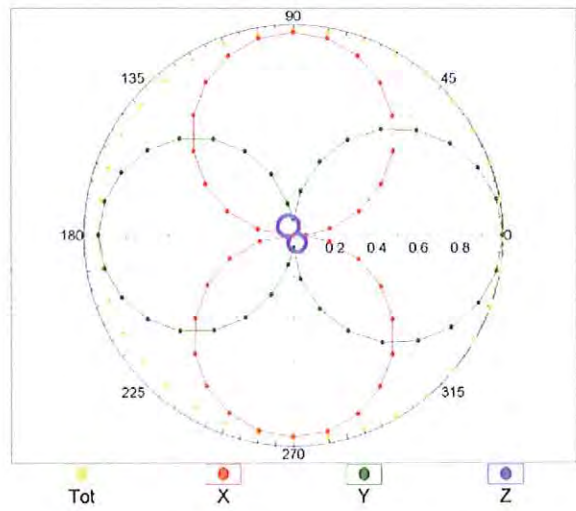

Receiving Pattern (ϕ), $\vartheta = 90^\circ$

f=600 MHz, TEM, 90°

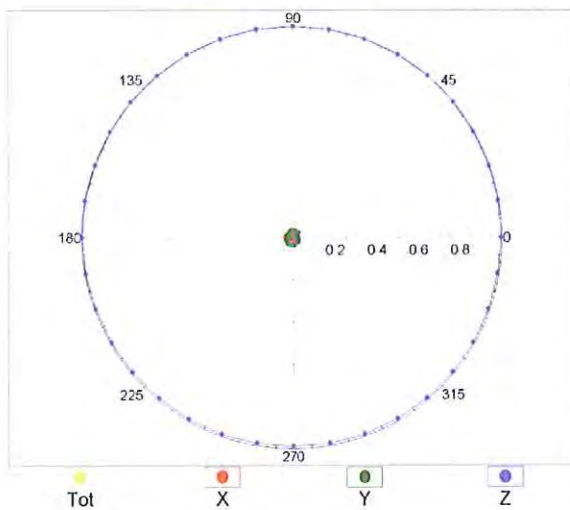

f=2500 MHz, R22, 90°

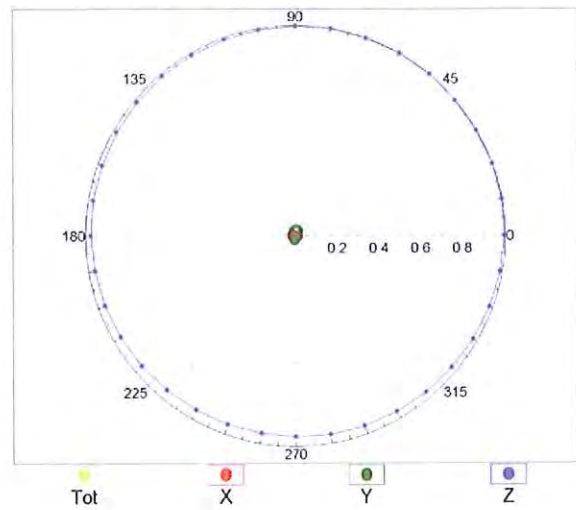

Receiving Pattern (ϕ), $\vartheta = 0^\circ$

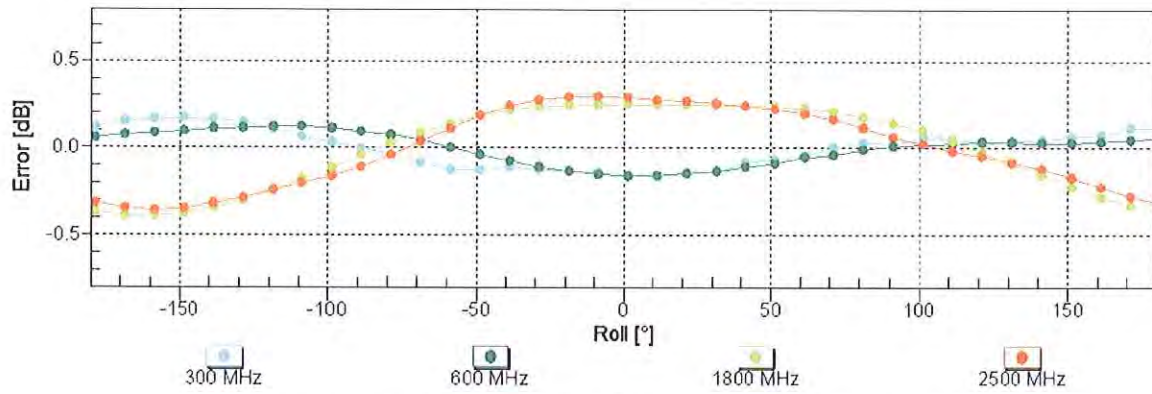

Uncertainty of Axial Isotropy Assessment: $\pm 0.5\%$ ($k=2$)

Receiving Pattern (ϕ), $\vartheta = 90^\circ$

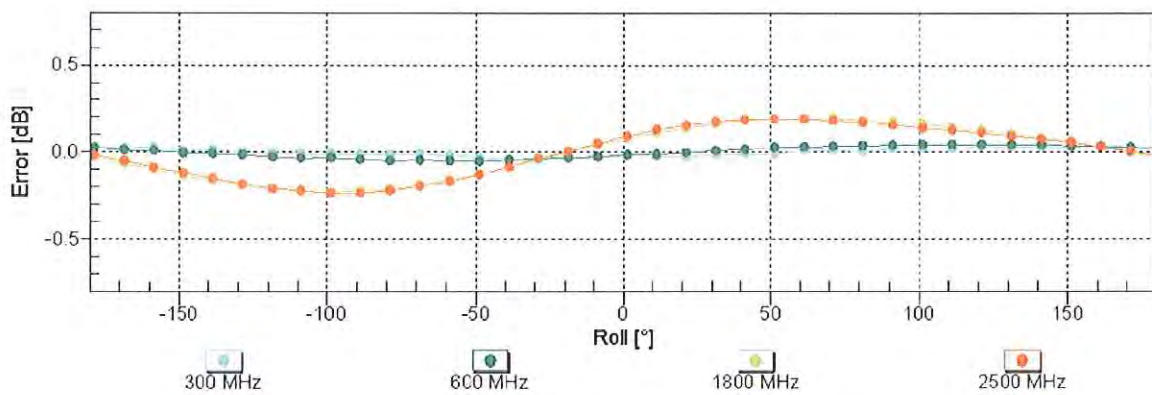

Uncertainty of Axial Isotropy Assessment: $\pm 0.5\%$ ($k=2$)

Dynamic Range f(H-field) (TEM cell, f = 900 MHz)

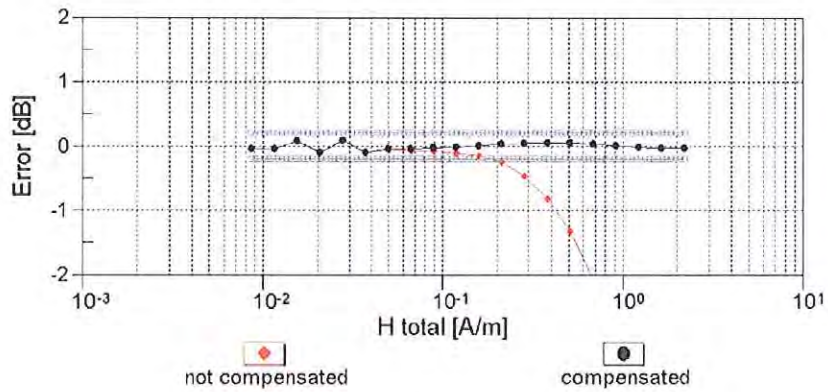
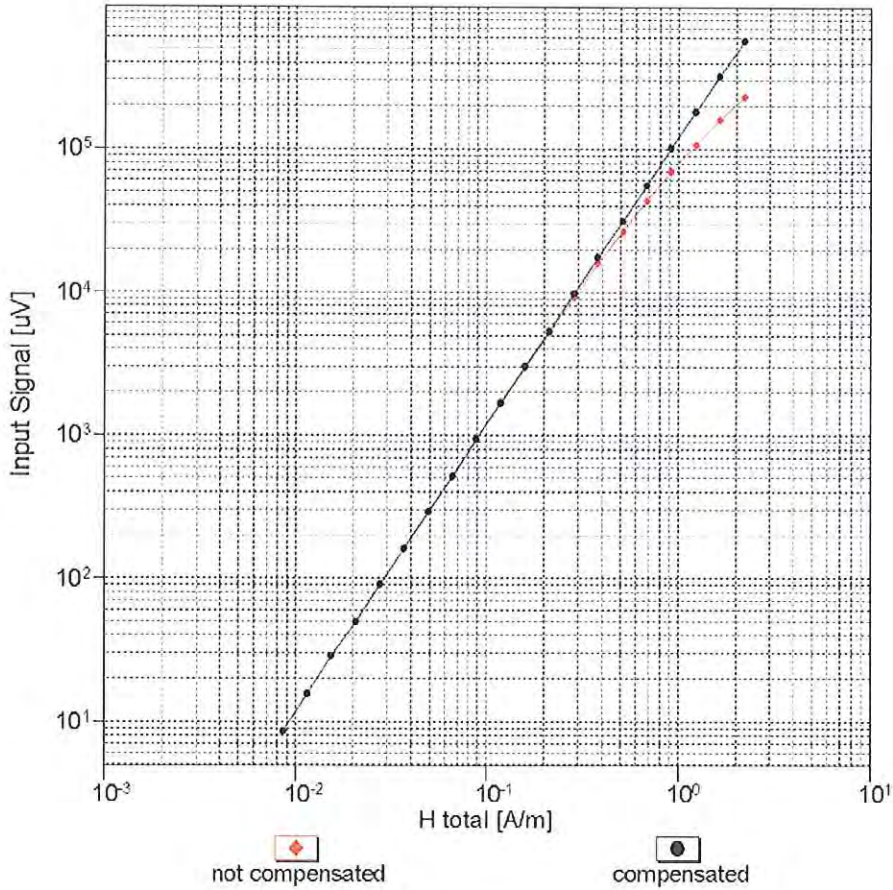

Uncertainty of Linearity Assessment: ± 0.6% (k=2)

Deviation from Isotropy in Air

Error (ϕ , ϑ), $f = 900$ MHz

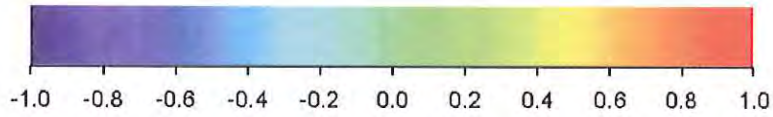
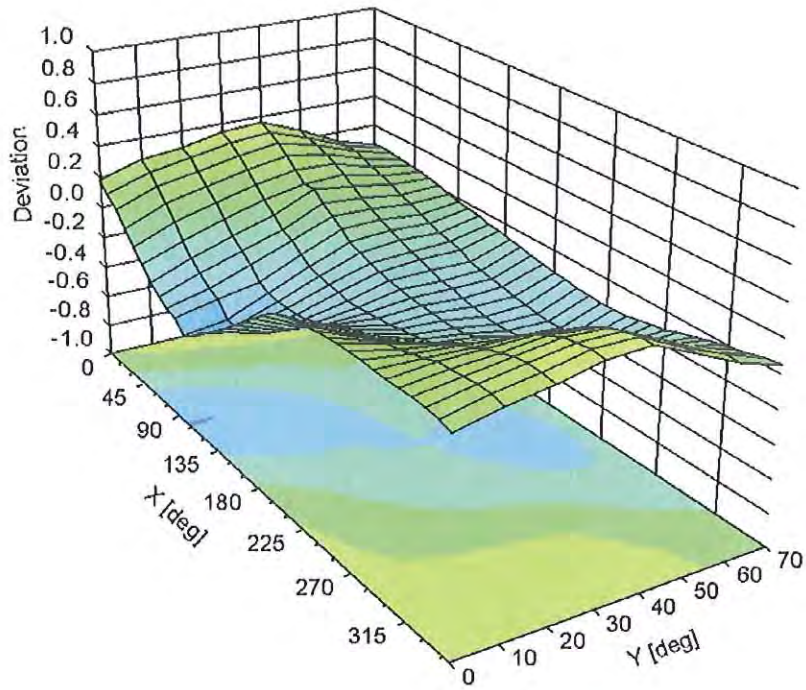

Uncertainty of Spherical Isotropy Assessment: $\pm 2.6\%$ ($k=2$)

DASY/EASY - Parameters of Probe: H3DV6 - SN:6074

Other Probe Parameters

| | |
|---|-------------|
| Sensor Arrangement | Rectangular |
| Connector Angle (°) | 11.3 |
| Mechanical Surface Detection Mode | enabled |
| Optical Surface Detection Mode | disabled |
| Probe Overall Length | 337 mm |
| Probe Body Diameter | 10 mm |
| Tip Length | 20 mm |
| Tip Diameter | 6 mm |
| Probe Tip to Sensor X Calibration Point | 3 mm |
| Probe Tip to Sensor Y Calibration Point | 3 mm |
| Probe Tip to Sensor Z Calibration Point | 3 mm |

Appendix 7

Dipole Characterization Certificates



Accredited by the Swiss Accreditation Service (SAS)
The Swiss Accreditation Service is one of the signatories to the EA
Multilateral Agreement for the recognition of calibration certificates

Accreditation No.: **SCS 108**

Client **Motorola MDb**

Certificate No: **CD835V3-1076_Mar12**

CALIBRATION CERTIFICATE

| | |
|--------------------------|--|
| Object | CD835V3 - SN: 1076 |
| Calibration procedure(s) | QA CAL-20.v6 Calibration procedure for dipoles in air |
| Calibration date: | March 08, 2012 |

This calibration certificate documents the traceability to national standards, which realize the physical units of measurements (SI).
The measurements and the uncertainties with confidence probability are given on the following pages and are part of the certificate.

All calibrations have been conducted in the closed laboratory facility: environment temperature (22 ± 3)°C and humidity < 70%.

Calibration Equipment used (M&TE critical for calibration)

| Primary Standards | ID # | Cal Date (Certificate No.) | Scheduled Calibration |
|-----------------------|------------|--------------------------------|-----------------------|
| Power meter EPM-442A | GB37480704 | 05-Oct-11 (No. 217-01451) | Oct-12 |
| Power sensor HP 8481A | US37292783 | 05-Oct-11 (No. 217-01451) | Oct-12 |
| Probe ER3DV6 | SN: 2336 | 29-Dec-11 (No. ER3-2336_Dec11) | Dec-12 |
| Probe H3DV6 | SN: 6065 | 29-Dec-11 (No. H3-6065_Dec11) | Dec-12 |
| DAE4 | SN: 781 | 20-Apr-11 (No. DAE4-781_Apr11) | Apr-12 |

| Secondary Standards | ID # | Check Date (in house) | Scheduled Check |
|---------------------------|----------------|-----------------------------------|------------------------|
| Power meter Agilent 4419B | SN: GB42420191 | 09-Oct-09 (in house check Oct-11) | In house check: Oct-12 |
| Power sensor HP 8482H | SN: 3318A09450 | 09-Oct-09 (in house check Oct-11) | In house check: Oct-12 |
| Power sensor HP 8482A | SN: US37295597 | 09-Oct-09 (in house check Oct-11) | In house check: Oct-12 |
| Network Analyzer HP 8753E | US37390585 | 18-Oct-01 (in house check Oct-11) | In house check: Oct-12 |
| RF generator E4433B | MY 41000675 | 03-Nov-04 (in house check Oct-11) | In house check: Oct-13 |

| | | | |
|----------------|-----------------|-----------------------|-----------|
| | Name | Function | Signature |
| Calibrated by: | Claudio Leubler | Laboratory Technician | |
| Approved by: | Fin Bomholt | R&D Director | |

Issued: March 8, 2012

This calibration certificate shall not be reproduced except in full without written approval of the laboratory.



Accredited by the Swiss Accreditation Service (SAS)
The Swiss Accreditation Service is one of the signatories to the EA
Multilateral Agreement for the recognition of calibration certificates

Accreditation No.: **SCS 108**

References

- [1] ANSI-C63.19-2007
American National Standard for Methods of Measurement of Compatibility between Wireless Communications Devices and Hearing Aids.

Methods Applied and Interpretation of Parameters:

- **Coordinate System:** y-axis is in the direction of the dipole arms. z-axis is from the basis of the antenna (mounted on the table) towards its feed point between the two dipole arms. x-axis is normal to the other axes. In coincidence with the standards [1], the measurement planes (probe sensor center) are selected to be at a distance of 10 mm above the top edge of the dipole arms.
- **Measurement Conditions:** Further details are available from the hardcopies at the end of the certificate. All figures stated in the certificate are valid at the frequency indicated. The forward power to the dipole connector is set with a calibrated power meter connected and monitored with an auxiliary power meter connected to a directional coupler. While the dipole under test is connected, the forward power is adjusted to the same level.
- **Antenna Positioning:** The dipole is mounted on a HAC Test Arch phantom using the matching dipole positioner with the arms horizontal and the feeding cable coming from the floor. The measurements are performed in a shielded room with absorbers around the setup to reduce the reflections. It is verified before the mounting of the dipole under the Test Arch phantom, that its arms are perfectly in a line. It is installed on the HAC dipole positioner with its arms parallel below the dielectric reference wire and able to move elastically in vertical direction without changing its relative position to the top center of the Test Arch phantom. The vertical distance to the probe is adjusted after dipole mounting with a DASY5 Surface Check job. Before the measurement, the distance between phantom surface and probe tip is verified. The proper measurement distance is selected by choosing the matching section of the HAC Test Arch phantom with the proper device reference point (upper surface of the dipole) and the matching grid reference point (tip of the probe) considering the probe sensor offset. The vertical distance to the probe is essential for the accuracy.
- **Feed Point Impedance and Return Loss:** These parameters are measured using a HP 8753E Vector Network Analyzer. The impedance is specified at the SMA connector of the dipole. The influence of reflections was eliminating by applying the averaging function while moving the dipole in the air, at least 70cm away from any obstacles.
- **E-field distribution:** E field is measured in the x-y-plane with an isotropic ER3D-field probe with 100 mW forward power to the antenna feed point. In accordance with [1], the scan area is 20mm wide, its length exceeds the dipole arm length (180 or 90mm). The sensor center is 10 mm (in z) above the top of the dipole arms. Two 3D maxima are available near the end of the dipole arms. Assuming the dipole arms are perfectly in one line, the average of these two maxima (in subgrid 2 and subgrid 8) is determined to compensate for any non-parallelity to the measurement plane as well as the sensor displacement. The E-field value stated as calibration value represents the maximum of the interpolated 3D-E-field, 10mm above the dipole surface.
- **H-field distribution:** H-field is measured with an isotropic H-field probe with 100mW forward power to the antenna feed point, in the x-y-plane. The scan area and sensor distance is equivalent to the E-field scan. The maximum of the field is available at the center (subgrid 5) above the feed point. The H-field value stated as calibration value represents the maximum of the interpolated H-field, 10mm above the dipole surface at the feed point.

The reported uncertainty of measurement is stated as the standard uncertainty of measurement multiplied by the coverage factor $k=2$, which for a normal distribution corresponds to a coverage probability of approximately 95%.

Measurement Conditions

DASY system configuration, as far as not given on page 1.

| | | |
|---|--|---------|
| DASY Version | DASY5 | V52.8.0 |
| Extrapolation | Advanced Extrapolation | |
| Phantom | HAC Test Arch | |
| Distance Dipole Top - Probe Center | 10mm | |
| Scan resolution | dx, dy = 5 mm | |
| Frequency | 835 MHz \pm 1 MHz 898 MHz \pm 1 MHz | |
| Input power drift | < 0.05 dB | |

Maximum Field values at 835 MHz

| H-field 10 mm above dipole surface | condition | interpolated maximum |
|---|--------------------|---|
| Maximum measured | 100 mW input power | 0.468 A / m \pm 8.2 % (k=2) |

| E-field 10 mm above dipole surface | condition | Interpolated maximum |
|---|--------------------|--|
| Maximum measured above high end | 100 mW input power | 170.7 V / m |
| Maximum measured above low end | 100 mW input power | 169.7 V / m |
| Averaged maximum above arm | 100 mW input power | 170.2 V / m \pm 12.8 % (k=2) |

Maximum Field values at 898 MHz

| H-field 10 mm above dipole surface | condition | interpolated maximum |
|---|--------------------|---|
| Maximum measured | 100 mW input power | 0.433 A / m \pm 8.2 % (k=2) |

| E-field 10 mm above dipole surface | condition | Interpolated maximum |
|---|--------------------|--|
| Maximum measured above high end | 100 mW input power | 163.8 V / m |
| Maximum measured above low end | 100 mW input power | 162.4 V / m |
| Averaged maximum above arm | 100 mW input power | 163.1 V / m \pm 12.8 % (k=2) |

Appendix

Antenna Parameters

Nominal Frequencies

| Frequency | Return Loss | Impedance |
|-----------|-------------|---------------------------------|
| 800 MHz | 16.5 dB | 42.4 Ω - 11.7 j Ω |
| 835 MHz | 25.1 dB | 50.1 Ω + 5.6 j Ω |
| 900 MHz | 16.9 dB | 59.3 Ω - 12.8 j Ω |
| 950 MHz | 19.4 dB | 47.2 Ω + 10.2 j Ω |
| 960 MHz | 14.5 dB | 56.7 Ω + 19.3 j Ω |

Additional Frequencies

| Frequency | Return Loss | Impedance |
|-----------|-------------|---------------------------------|
| 898 MHz | 17.3 dB | 58.8 Ω - 12.0 j Ω |

3.2 Antenna Design and Handling

The calibration dipole has a symmetric geometry with a built-in two stub matching network, which leads to the enhanced bandwidth.

The dipole is built of standard semirigid coaxial cable. The internal matching line is open ended. The antenna is therefore open for DC signals.

Do not apply force to dipole arms, as they are liable to bend. The soldered connections near the feedpoint may be damaged. After excessive mechanical stress or overheating, check the impedance characteristics to ensure that the internal matching network is not affected.

After long term use with 40W radiated power, only a slight warming of the dipole near the feedpoint can be measured.

Impedance Measurement Plot

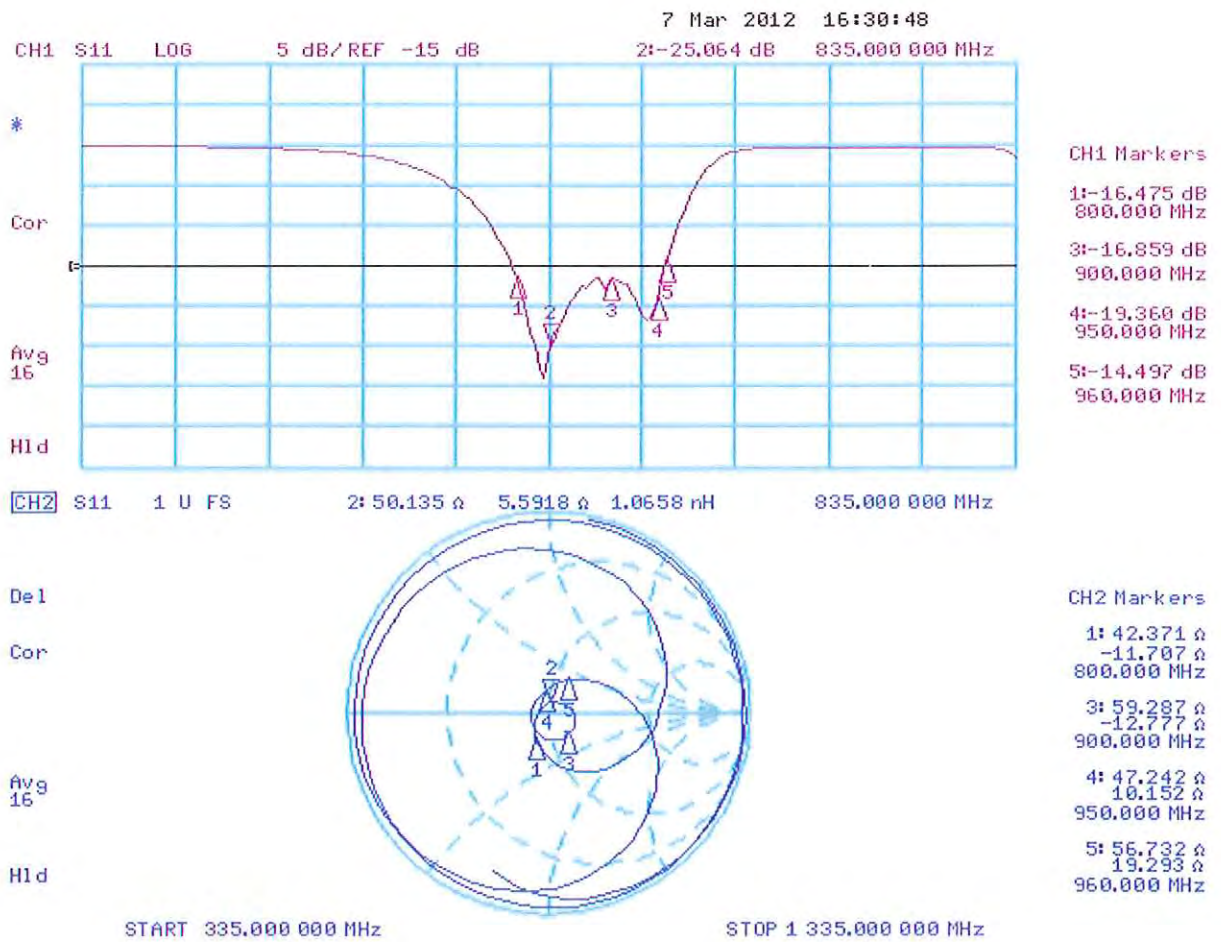

DASY5 H-field Result

Date: 07.03.2012

Test Laboratory: SPEAG Lab2

DUT: HAC-Dipole 835 MHz; Type: CD835V3; Serial: CD835V3 - SN: 1076

Communication System: CW; Frequency: 835 MHz, Frequency: 898 MHz

Medium parameters used: $\sigma = 0$ mho/m, $\epsilon_r = 1$; $\rho = 1$ kg/m³

Phantom section: RF Section

Measurement Standard: DASY5 (IEEE/IEC/ANSI C63.19-2007)

DASY52 Configuration:

- Probe: H3DV6 - SN6065; ; Calibrated: 29.12.2011
- Sensor-Surface: (Fix Surface)
- Electronics: DAE4 Sn781; Calibrated: 20.04.2011
- Phantom: HAC Test Arch with AMCC; Type: SD HAC P01 BA; Serial: 1070
- DASY52 52.8.0(692); SEMCAD X 14.6.4(4989)

Dipole H-Field measurement @ 835MHz/H-Scan - 835MHz d=10mm/Hearing Aid Compatibility Test (41x361x1):

Measurement grid: dx=5mm, dy=5mm

Device Reference Point: 0, 0, -6.3 mm

Reference Value = 0.50 V/m; Power Drift = -0.01 dB

PMR not calibrated. PMF = 1.000 is applied.

H-field emissions = 0.47 A/m

Near-field category: M4 (AWF 0 dB)

PMF scaled H-field

| | | |
|-----------------------|-----------------------|-----------------------|
| Grid 1 M4 0.39 A/m | Grid 2 M4 0.41 A/m | Grid 3 M4 0.39 A/m |
| Grid 4 M4 0.44 A/m | Grid 5 M4 0.47 A/m | Grid 6 M4 0.45 A/m |
| Grid 7 M4 0.39 A/m | Grid 8 M4 0.42 A/m | Grid 9 M4 0.40 A/m |

Dipole H-Field measurement @ 835MHz/H-Scan - 898MHz d=10mm/Hearing Aid Compatibility Test (41x361x1):

Measurement grid: dx=5mm, dy=5mm

Device Reference Point: 0, 0, -6.3 mm

Reference Value = 0.45 V/m; Power Drift = -0.01 dB

PMR not calibrated. PMF = 1.000 is applied.

H-field emissions = 0.43 A/m

Near-field category: M4 (AWF 0 dB)

PMF scaled H-field

| | | |
|-----------------------|-----------------------|-----------------------|
| Grid 1 M4 0.37 A/m | Grid 2 M4 0.40 A/m | Grid 3 M4 0.38 A/m |
| Grid 4 M4 0.41 A/m | Grid 5 M4 0.43 A/m | Grid 6 M4 0.41 A/m |
| Grid 7 M4 0.38 A/m | Grid 8 M4 0.41 A/m | Grid 9 M4 0.39 A/m |

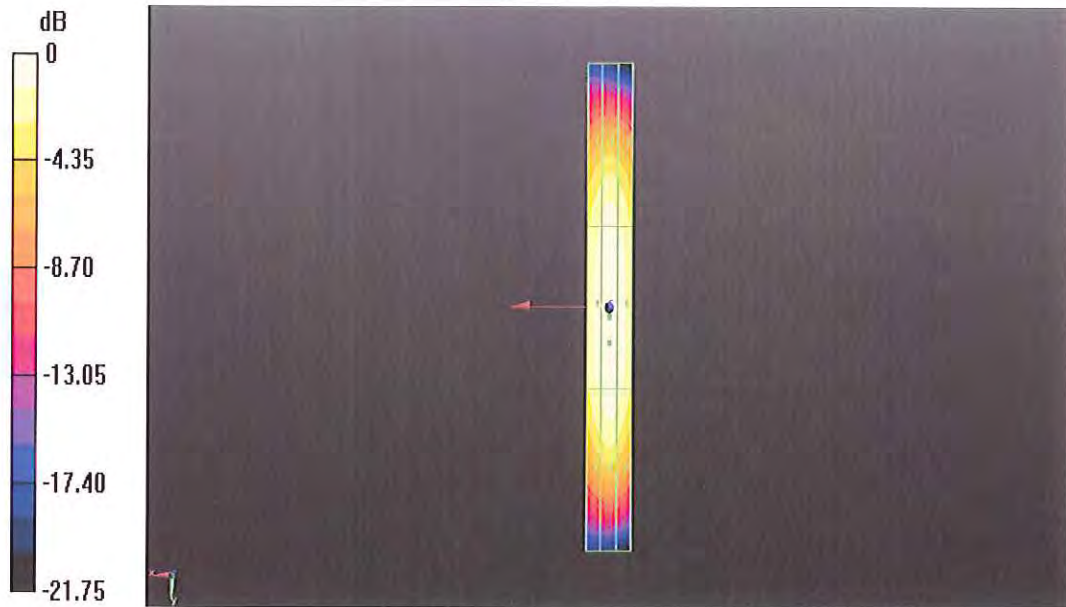

0 dB = 0.47A/m = -6.56 dB A/m

DASY5 E-field Result

Date: 08.03.2012

Test Laboratory: SPEAG Lab2

DUT: HAC-Dipole 835 MHz; Type: CD835V3; Serial: CD835V3 - SN: 1076

Communication System: CW; Frequency: 835 MHz, Frequency: 898 MHz

Medium parameters used: $\sigma = 0$ mho/m, $\epsilon_r = 1$; $\rho = 1000$ kg/m³

Phantom section: RF Section

Measurement Standard: DASY5 (IEEE/IEC/ANSI C63.19-2007)

DASY5 Configuration:

- Probe: ER3DV6 - SN2336; ConvF(1, 1, 1); Calibrated: 29.12.2011
- Sensor-Surface: (Fix Surface)
- Electronics: DAE4 Sn781; Calibrated: 20.04.2011
- Phantom: HAC Test Arch with AMCC; Type: SD HAC P01 BA; Serial: 1070
- DASY52 52.8.0(692); SEMCAD X 14.6.4(4989)

Dipole E-Field measurement @ 835MHz/E-Scan - 835MHz d=10mm/Hearing Aid Compatibility Test (41x361x1):

Measurement grid: dx=5mm, dy=5mm

Device Reference Point: 0, 0, -6.3 mm

Reference Value = 110.4 V/m; Power Drift = -0.02 dB

PMR not calibrated. PMF = 1.000 is applied.

E-field emissions = 170.7 V/m

Near-field category: M4 (AWF 0 dB)

PMF scaled E-field

| | | |
|------------------------|------------------------|------------------------|
| Grid 1 M4 164.2 V/m | Grid 2 M4 170.7 V/m | Grid 3 M4 165.7 V/m |
| Grid 4 M4 89.12 V/m | Grid 5 M4 91.76 V/m | Grid 6 M4 89.42 V/m |
| Grid 7 M4 160.0 V/m | Grid 8 M4 169.7 V/m | Grid 9 M4 167.3 V/m |

Dipole E-Field measurement @ 835MHz/E-Scan - 898MHz d=10mm/Hearing Aid Compatibility Test (41x361x1):

Measurement grid: dx=5mm, dy=5mm

Device Reference Point: 0, 0, -6.3 mm

Reference Value = 97.00 V/m; Power Drift = 0.01 dB

PMR not calibrated. PMF = 1.000 is applied.

E-field emissions = 163.8 V/m

Near-field category: M4 (AWF 0 dB)

PMF scaled E-field

| | | |
|------------------------|------------------------|------------------------|
| Grid 1 M4 156.9 V/m | Grid 2 M4 162.4 V/m | Grid 3 M4 157.8 V/m |
| Grid 4 M4 77.28 V/m | Grid 5 M4 79.49 V/m | Grid 6 M4 77.42 V/m |
| Grid 7 M4 154.4 V/m | Grid 8 M4 163.8 V/m | Grid 9 M4 162.1 V/m |

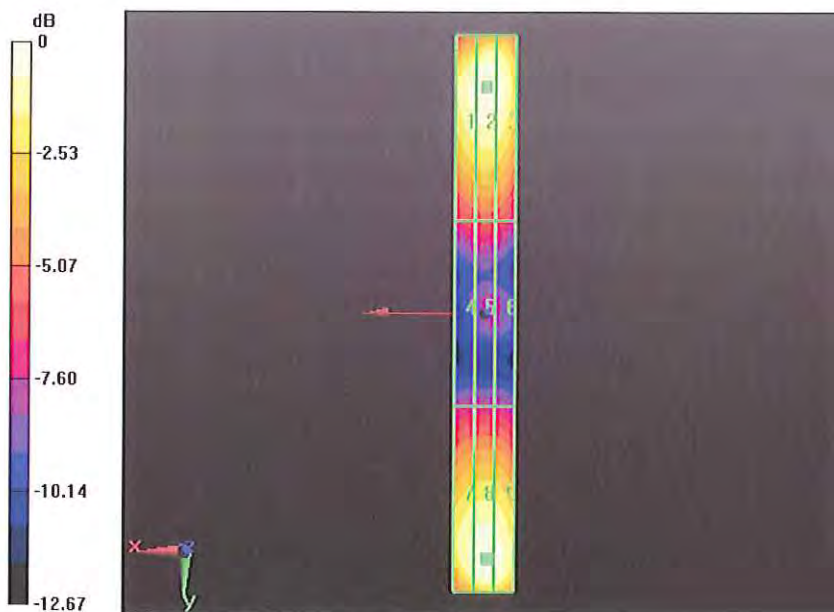

0 dB = 170.7V/m = 44.64 dB V/m



Accredited by the Swiss Accreditation Service (SAS)
The Swiss Accreditation Service is one of the signatories to the EA
Multilateral Agreement for the recognition of calibration certificates

Accreditation No.: **SCS 108**

Client **Motorola MDb**

Certificate No: **CD1880V3-1034_Mar12**

CALIBRATION CERTIFICATE

Object **CD1880V3 - SN: 1034**

Calibration procedure(s) **QA CAL-20.v6
Calibration procedure for dipoles in air**

Calibration date: **March 08, 2012**

This calibration certificate documents the traceability to national standards, which realize the physical units of measurements (SI).
The measurements and the uncertainties with confidence probability are given on the following pages and are part of the certificate.

All calibrations have been conducted in the closed laboratory facility: environment temperature (22 ± 3)°C and humidity < 70%.

Calibration Equipment used (M&TE critical for calibration)

| Primary Standards | ID # | Cal Date (Certificate No.) | Scheduled Calibration |
|---------------------------|----------------|-----------------------------------|------------------------|
| Power meter EPM-442A | GB37480704 | 05-Oct-11 (No. 217-01451) | Oct-12 |
| Power sensor HP 8481A | US37292783 | 05-Oct-11 (No. 217-01451) | Oct-12 |
| Probe ER3DV6 | SN: 2336 | 29-Dec-11 (No. ER3-2336_Dec11) | Dec-12 |
| Probe H3DV6 | SN: 6065 | 29-Dec-11 (No. H3-6065_Dec11) | Dec-12 |
| DAE4 | SN: 781 | 20-Apr-11 (No. DAE4-781_Apr11) | Apr-12 |
| Secondary Standards | ID # | Check Date (in house) | Scheduled Check |
| Power meter Agilent 4419B | SN: GB42420191 | 09-Oct-09 (in house check Oct-11) | In house check: Oct-12 |
| Power sensor HP 8482H | SN: 3318A09450 | 09-Oct-09 (in house check Oct-11) | In house check: Oct-12 |
| Power sensor HP 8482A | SN: US37295597 | 09-Oct-09 (in house check Oct-11) | In house check: Oct-12 |
| Network Analyzer HP 8753E | US37390585 | 18-Oct-01 (in house check Oct-11) | In house check: Oct-12 |
| RF generator E4433B | MY 41000675 | 03-Nov-04 (in house check Oct-11) | In house check: Oct-13 |

| | | | |
|----------------|--------------------------------|-----------------------------------|---------------|
| Calibrated by: | Name Claudio Leubler | Function Laboratory Technician | Signature |
| Approved by: | Name Fin Bornholt | Function R&D Director | |

Issued: March 8, 2012

This calibration certificate shall not be reproduced except in full without written approval of the laboratory.



Accredited by the Swiss Accreditation Service (SAS)
The Swiss Accreditation Service is one of the signatories to the EA
Multilateral Agreement for the recognition of calibration certificates

Accreditation No.: **SCS 108**

References

- [1] ANSI-C63.19-2007
American National Standard for Methods of Measurement of Compatibility between Wireless Communications Devices and Hearing Aids.

Methods Applied and Interpretation of Parameters:

- **Coordinate System:** y-axis is in the direction of the dipole arms. z-axis is from the basis of the antenna (mounted on the table) towards its feed point between the two dipole arms. x-axis is normal to the other axes. In coincidence with the standards [1], the measurement planes (probe sensor center) are selected to be at a distance of 10 mm above the top edge of the dipole arms.
- **Measurement Conditions:** Further details are available from the hardcopies at the end of the certificate. All figures stated in the certificate are valid at the frequency indicated. The forward power to the dipole connector is set with a calibrated power meter connected and monitored with an auxiliary power meter connected to a directional coupler. While the dipole under test is connected, the forward power is adjusted to the same level.
- **Antenna Positioning:** The dipole is mounted on a HAC Test Arch phantom using the matching dipole positioner with the arms horizontal and the feeding cable coming from the floor. The measurements are performed in a shielded room with absorbers around the setup to reduce the reflections. It is verified before the mounting of the dipole under the Test Arch phantom, that its arms are perfectly in a line. It is installed on the HAC dipole positioner with its arms parallel below the dielectric reference wire and able to move elastically in vertical direction without changing its relative position to the top center of the Test Arch phantom. The vertical distance to the probe is adjusted after dipole mounting with a DASY5 Surface Check job. Before the measurement, the distance between phantom surface and probe tip is verified. The proper measurement distance is selected by choosing the matching section of the HAC Test Arch phantom with the proper device reference point (upper surface of the dipole) and the matching grid reference point (tip of the probe) considering the probe sensor offset. The vertical distance to the probe is essential for the accuracy.
- **Feed Point Impedance and Return Loss:** These parameters are measured using a HP 8753E Vector Network Analyzer. The impedance is specified at the SMA connector of the dipole. The influence of reflections was eliminating by applying the averaging function while moving the dipole in the air, at least 70cm away from any obstacles.
- **E-field distribution:** E field is measured in the x-y-plane with an isotropic ER3D-field probe with 100 mW forward power to the antenna feed point. In accordance with [1], the scan area is 20mm wide, its length exceeds the dipole arm length (180 or 90mm). The sensor center is 10 mm (in z) above the top of the dipole arms. Two 3D maxima are available near the end of the dipole arms. Assuming the dipole arms are perfectly in one line, the average of these two maxima (in subgrid 2 and subgrid 8) is determined to compensate for any non-parallelity to the measurement plane as well as the sensor displacement. The E-field value stated as calibration value represents the maximum of the interpolated 3D-E-field, 10mm above the dipole surface.
- **H-field distribution:** H-field is measured with an isotropic H-field probe with 100mW forward power to the antenna feed point, in the x-y-plane. The scan area and sensor distance is equivalent to the E-field scan. The maximum of the field is available at the center (subgrid 5) above the feed point. The H-field value stated as calibration value represents the maximum of the interpolated H-field, 10mm above the dipole surface at the feed point.

The reported uncertainty of measurement is stated as the standard uncertainty of measurement multiplied by the coverage factor $k=2$, which for a normal distribution corresponds to a coverage probability of approximately 95%.

Measurement Conditions

DASY system configuration, as far as not given on page 1.

| | | |
|---|--|---------|
| DASY Version | DASY5 | V52.8.0 |
| Extrapolation | Advanced Extrapolation | |
| Phantom | HAC Test Arch | |
| Distance Dipole Top - Probe Center | 10mm | |
| Scan resolution | dx, dy = 5 mm | |
| Frequency | 1730 MHz \pm 1 MHz 1880 MHz \pm 1 MHz | |
| Input power drift | < 0.05 dB | |

Maximum Field values at 1730 MHz

| H-field 10 mm above dipole surface | condition | interpolated maximum |
|---|--------------------|---|
| Maximum measured | 100 mW input power | 0.489 A / m \pm 8.2 % (k=2) |

| E-field 10 mm above dipole surface | condition | Interpolated maximum |
|---|--------------------|--|
| Maximum measured above high end | 100 mW input power | 154.5 V / m |
| Maximum measured above low end | 100 mW input power | 149.7 V / m |
| Averaged maximum above arm | 100 mW input power | 152.1 V / m \pm 12.8 % (k=2) |

Maximum Field values at 1880 MHz

| H-field 10 mm above dipole surface | condition | interpolated maximum |
|---|--------------------|---|
| Maximum measured | 100 mW input power | 0.464 A / m \pm 8.2 % (k=2) |

| E-field 10 mm above dipole surface | condition | Interpolated maximum |
|---|--------------------|--|
| Maximum measured above high end | 100 mW input power | 142.5 V / m |
| Maximum measured above low end | 100 mW input power | 140.1 V / m |
| Averaged maximum above arm | 100 mW input power | 141.3 V / m \pm 12.8 % (k=2) |

Appendix

Antenna Parameters

Nominal Frequencies

| Frequency | Return Loss | Impedance |
|-----------|-------------|--------------------------------|
| 1730 MHz | 20.9 dB | 48.7 Ω + 8.8 j Ω |
| 1880 MHz | 20.9 dB | 52.2 Ω + 9.0 j Ω |
| 1900 MHz | 21.2 dB | 54.5 Ω + 8.0 j Ω |
| 1950 MHz | 27.3 dB | 53.7 Ω - 2.5 j Ω |
| 2000 MHz | 20.1 dB | 41.0 Ω + 0.8 j Ω |

Additional Frequencies

| Frequency | Return Loss | Impedance |
|-----------|-------------|--------------------------------|
| 1730 MHz | 20.9 dB | 48.7 Ω + 8.8 j Ω |

3.2 Antenna Design and Handling

The calibration dipole has a symmetric geometry with a built-in two stub matching network, which leads to the enhanced bandwidth.

The dipole is built of standard semirigid coaxial cable. The internal matching line is open ended. The antenna is therefore open for DC signals.

Do not apply force to dipole arms, as they are liable to bend. The soldered connections near the feedpoint may be damaged. After excessive mechanical stress or overheating, check the impedance characteristics to ensure that the internal matching network is not affected.

After long term use with 40W radiated power, only a slight warming of the dipole near the feedpoint can be measured.

Impedance Measurement Plot

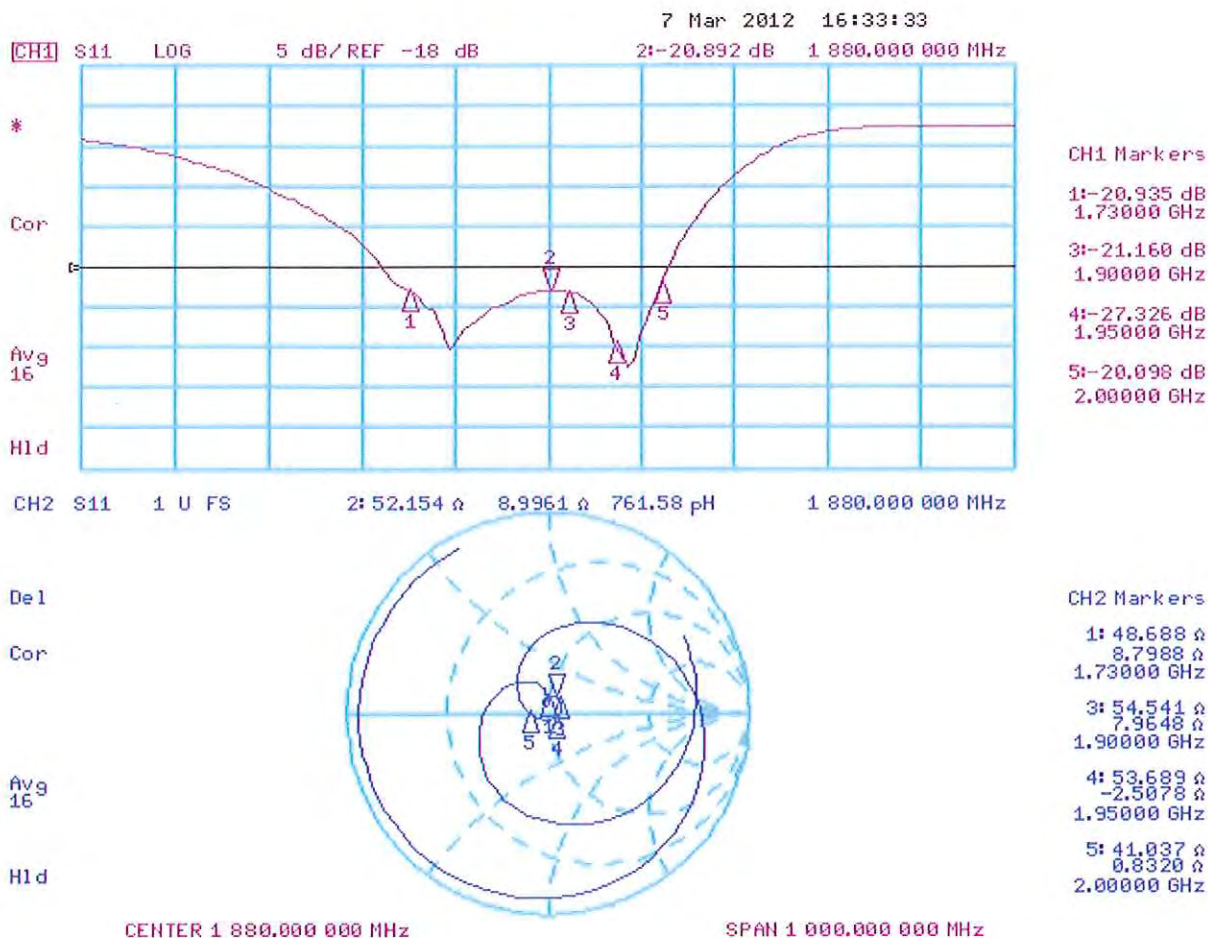

DASY5 H-field Result

Date: 07.03.2012

Test Laboratory: SPEAG Lab2

DUT: HAC Dipole 1880 MHz; Type: CD1880V3; Serial: CD1880V3 - SN: 1034

Communication System: CW; Frequency: 1880 MHz, Frequency: 1730 MHz

Medium parameters used: $\sigma = 0$ mho/m, $\epsilon_r = 1$; $\rho = 1$ kg/m³

Phantom section: RF Section

Measurement Standard: DASY5 (IEEE/IEC/ANSI C63.19-2007)

DASY52 Configuration:

- Probe: H3DV6 - SN6065; ; Calibrated: 29.12.2011
- Sensor-Surface: (Fix Surface)
- Electronics: DAE4 Sn781; Calibrated: 20.04.2011
- Phantom: HAC Test Arch with AMCC; Type: SD HAC P01 BA; Serial: 1070
- DASY52 52.8.0(692); SEMCAD X 14.6.4(4989)

Dipole H-Field measurement @ 1880MHz/H-Scan - 1880MHz d=10mm/Hearing Aid Compatibility Test (41x181x1):

Measurement grid: dx=5mm, dy=5mm

Device Reference Point: 0, 0, -6.3 mm

Reference Value = 0.49 V/m; Power Drift = 0.00 dB

PMR not calibrated. PMF = 1.000 is applied.

H-field emissions = 0.46 A/m

Near-field category: M2 (AWF 0 dB)

PMF scaled H-field

| | | |
|-----------------------|-----------------------|-----------------------|
| Grid 1 M2 0.40 A/m | Grid 2 M2 0.42 A/m | Grid 3 M2 0.41 A/m |
| Grid 4 M2 0.44 A/m | Grid 5 M2 0.46 A/m | Grid 6 M2 0.44 A/m |
| Grid 7 M2 0.40 A/m | Grid 8 M2 0.43 A/m | Grid 9 M2 0.41 A/m |

Dipole H-Field measurement @ 1880MHz/H-Scan - 1730MHz d=10mm/Hearing Aid Compatibility Test (41x181x1):

Measurement grid: dx=5mm, dy=5mm

Device Reference Point: 0, 0, -6.3 mm

Reference Value = 0.52 V/m; Power Drift = 0.01 dB

PMR not calibrated. PMF = 1.000 is applied.

H-field emissions = 0.49 A/m

Near-field category: M2 (AWF 0 dB)

PMF scaled H-field

| | | |
|-----------------------|-----------------------|-----------------------|
| Grid 1 M2 0.40 A/m | Grid 2 M2 0.42 A/m | Grid 3 M2 0.41 A/m |
| Grid 4 M2 0.46 A/m | Grid 5 M2 0.49 A/m | Grid 6 M2 0.47 A/m |
| Grid 7 M2 0.41 A/m | Grid 8 M2 0.43 A/m | Grid 9 M2 0.41 A/m |

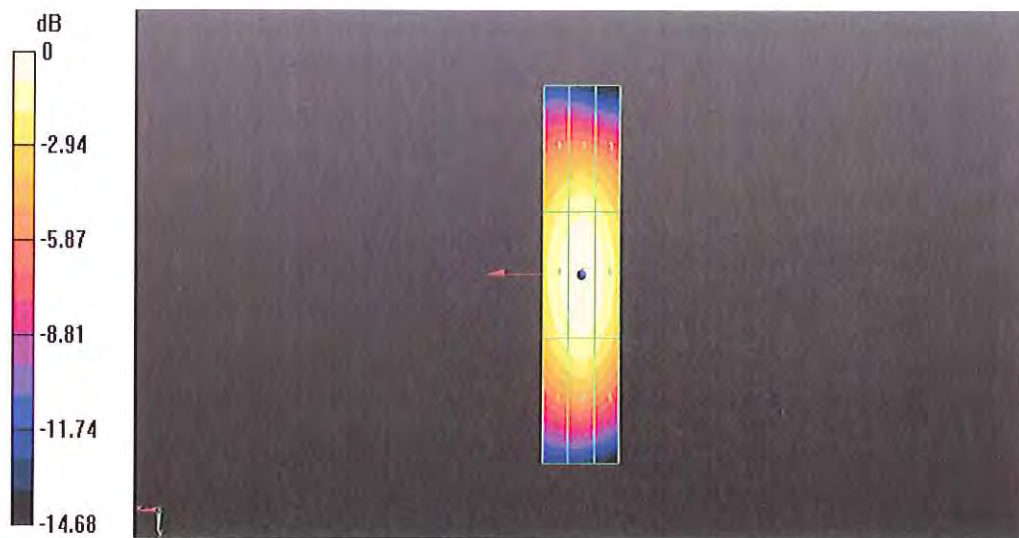

0 dB = 0.46A/m = -6.74 dB A/m

DASY5 E-field Result

Date: 08.03.2012

Test Laboratory: SPEAG Lab2

DUT: HAC Dipole 1880 MHz; Type: CD1880V3; Serial: CD1880V3 - SN: 1034

Communication System: CW; Frequency: 1880 MHz, Frequency: 1730 MHz

Medium parameters used: $\sigma = 0$ mho/m, $\epsilon_r = 1$; $\rho = 1000$ kg/m³

Phantom section: RF Section

Measurement Standard: DASY5 (IEEE/IEC/ANSI C63.19-2007)

DASY5 Configuration:

- Probe: ER3DV6 - SN2336; ConvF(1, 1, 1); Calibrated: 29.12.2011
- Sensor-Surface: (Fix Surface)
- Electronics: DAE4 Sn781; Calibrated: 20.04.2011
- Phantom: HAC Test Arch with AMCC; Type: SD HAC P01 BA; Serial: 1070
- DASY52 52.8.0(692); SEMCAD X 14.6.4(4989)

Dipole E-Field measurement @ 1880MHz/E-Scan - 1880MHz d=10mm/Hearing Aid Compatibility Test (41x181x1):

Measurement grid: dx=5mm, dy=5mm

Device Reference Point: 0, 0, -6.3 mm

Reference Value = 159.2 V/m; Power Drift = 0.01 dB

PMR not calibrated. PMF = 1.000 is applied.

E-field emissions = 142.5 V/m

Near-field category: M2 (AWF 0 dB)

PMF scaled E-field

| | | |
|------------------------|------------------------|------------------------|
| Grid 1 M2 135.9 V/m | Grid 2 M2 140.1 V/m | Grid 3 M2 136.2 V/m |
| Grid 4 M3 90.98 V/m | Grid 5 M3 93.35 V/m | Grid 6 M3 89.57 V/m |
| Grid 7 M2 132.8 V/m | Grid 8 M2 142.5 V/m | Grid 9 M2 140.7 V/m |

Dipole E-Field measurement @ 1880MHz/E-Scan - 1730MHz d=10mm/Hearing Aid Compatibility Test (41x181x1):

Measurement grid: dx=5mm, dy=5mm

Device Reference Point: 0, 0, -6.3 mm

Reference Value = 171.8 V/m; Power Drift = 0.01 dB

PMR not calibrated. PMF = 1.000 is applied.

E-field emissions = 154.5 V/m

Near-field category: M2 (AWF 0 dB)

PMF scaled E-field

| | | |
|-----------|-----------|-----------|
| Grid 1 M2 | Grid 2 M2 | Grid 3 M2 |
| 144.9 V/m | 149.7 V/m | 145.6 V/m |
| Grid 4 M3 | Grid 5 M3 | Grid 6 M3 |
| 102.8 V/m | 105.6 V/m | 101.8 V/m |
| Grid 7 M2 | Grid 8 M2 | Grid 9 M2 |
| 144.4 V/m | 154.5 V/m | 152.7 V/m |

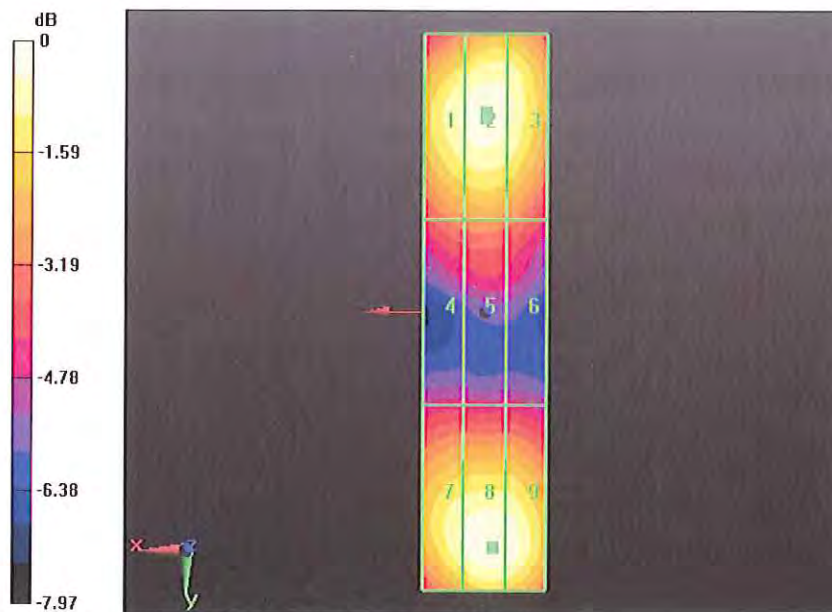

0 dB = 142.5V/m = 43.08 dB V/m

END OF REPORT