



PCTEST ENGINEERING LABORATORY, INC.

7185 Oakland Mills Road, Columbia, MD 21046 USA
Tel. 410.290.6652 / Fax 410.290.6654
http://www.pctestlab.com



MEASUREMENT REPORT FCC PART 15.247 Bluetooth

Applicant Name:
Motorola Mobility LLC
8000 West Sunrise Blvd.
Plantation, FL 33322
United States

Date of Testing:
04/04 - 04/25/2013
Test Site/Location:
PCTEST Lab. Columbia, MD, USA
Test Report Serial No.:
0Y1304010567.IHD-R1

FCC ID:	IHDT56PB1
APPLICANT:	Motorola Mobility LLC

Application Type: Certification
EUT Type: Portable Handset
Max. RF Output Power: 10.728 mW (10.31dBm) Conducted
Frequency Range: 2402 – 2480MHz (Bluetooth for US)
Type of Modulation: GFSK, $\pi/4$ -DQPSK, 8DPSK
FCC Classification: FCC Part 15 Spread Spectrum Transmitter (DSS)
FCC Rule Part(s): Part 15 Subpart C (15.247)
Test Procedure(s): ANSI C63.10-2009, DA 00-705

This equipment has been shown to be capable of compliance with the applicable technical standards as indicated in the measurement report and was tested in accordance with the measurement procedures specified in ANSI C63.10-2009 and DA 00-705. Test results reported herein relate only to the item(s) tested.

***This revised Test Report (S/N: 0Y1304010567.IHD-R1) supersedes and replaces the previously issued test report on the same subject EUT for the same type of testing as indicated. Please discard and destroy the previously issued test report (S/N: 0Y1304010567.IHD) and dispose of it accordingly.**

I attest to the accuracy of data. All measurements reported herein were performed by me or were made under my supervision and are correct to the best of my knowledge and belief. I assume full responsibility for the completeness of these measurements and vouch for the qualifications of all persons taking them.

 Randy Ortanez
 President







FCC ID: IHDT56PB1		FCC Pt. 15.247 BLUETOOTH TEST REPORT (CERTIFICATION)		Reviewed by: Quality Manager
Test Report S/N: 0Y1304010567.IHD-R1	Test Dates: 04/04 - 04/25/2013	EUT Type: Portable Handset	Page 1 of 46	

TABLE OF CONTENTS

FCC PART 15.247 MEASUREMENT REPORT.....		3
1.0 INTRODUCTION.....		4
1.1 SCOPE.....		4
1.2 PCTEST TEST LOCATION.....		4
2.0 PRODUCT INFORMATION.....		5
2.1 EQUIPMENT DESCRIPTION.....		5
2.2 DEVICE CAPABILITIES.....		5
2.3 TEST CONFIGURATION.....		5
2.4 EMI SUPPRESSION DEVICE(S)/MODIFICATIONS.....		5
2.5 LABELING REQUIREMENTS.....		5
3.0 DESCRIPTION OF TEST.....		6
3.1 EVALUATION PROCEDURE.....		6
3.2 AC LINE CONDUCTED EMISSIONS.....		6
3.3 RADIATED EMISSIONS.....		7
4.0 ANTENNA REQUIREMENTS.....		8
5.0 TEST EQUIPMENT CALIBRATION DATA.....		9
6.0 TEST RESULTS.....		10
6.1 SUMMARY.....		10
6.2 20DB BANDWIDTH MEASUREMENT.....		11
6.3 OUTPUT POWER MEASUREMENT.....		17
6.4 BAND EDGE COMPLIANCE.....		27
6.5 CARRIER FREQUENCY SEPARATION.....		30
6.6 TIME OF OCCUPANCY.....		31
6.7 NUMBER OF HOPPING CHANNELS.....		32
6.8 CONDUCTED SPURIOUS EMISSIONS.....		34
6.9 RADIATED SPURIOUS EMISSION MEASUREMENTS.....		38
6.10 RADIATED RESTRICTED BAND EDGE MEASUREMENTS.....		42
6.11 LINE CONDUCTED MEASUREMENT DATA.....		44
7.0 CONCLUSION.....		46

FCC ID: IHDT56PB1	 FCC Pt. 15.247 BLUETOOTH TEST REPORT (CERTIFICATION)		Reviewed by: Quality Manager
Test Report S/N: 0Y1304010567.IHD-R1	Test Dates: 04/04 - 04/25/2013	EUT Type: Portable Handset	Page 2 of 46



MEASUREMENT REPORT

FCC Part 15.247



§ 2.1033 General Information



APPLICANT: Motorola Mobility LLC
APPLICANT ADDRESS: 8000 West Sunrise Blvd.
 Plantation, FL 33322, United States
TEST SITE: PCTEST ENGINEERING LABORATORY, INC.
TEST SITE ADDRESS: 7185 Oakland Mills Road, Columbia, MD 21046 USA
FCC RULE PART(S): Part 15 Subpart C (15.247)
FCC ID: IHDT56PB1
Test Device Serial No.: LXVE110040, LXVE110010 Production Pre-Production Engineering
FCC CLASSIFICATION: FCC Part 15 Spread Spectrum Transmitter (DSS)
Method/System: Frequency Hopping Spread Spectrum (FHSS)
DATE(S) OF TEST: 04/04 - 04/25/2013
TEST REPORT S/N: 0Y1304010567.IHD-R1

Test Facility / Accreditations

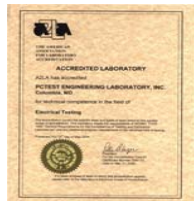
Measurements were performed at PCTEST Engineering Lab located in Columbia, MD 21046, U.S.A.



- PCTEST facility is an FCC registered (PCTEST Reg. No. 159966) test facility with the site description report on file and has met all the requirements specified in Section 2.948 of the FCC Rules and Industry Canada (2451B-1).
- PCTEST Lab is accredited to ISO 17025 by U.S. National Institute of Standards and Technology (NIST) under the National Voluntary Laboratory Accreditation Program (NVLAP Lab code: 100431-0) in EMC, FCC and Telecommunications.
- PCTEST Lab is accredited to ISO 17025-2005 by the American Association for Laboratory Accreditation (A2LA) in Specific Absorption Rate (SAR) testing, Hearing Aid Compatibility (HAC) testing, CTIA Test Plans, and wireless testing for FCC and Industry Canada Rules.
- PCTEST Lab is a recognized U.S. Conformity Assessment Body (CAB) in EMC and R&TTE (n.b. 0982) under the U.S.-EU Mutual Recognition Agreement (MRA).
- PCTEST TCB is a Telecommunication Certification Body (TCB) accredited to ISO/IEC Guide 65 by the American National Standards Institute (ANSI) in all scopes of FCC Rules and Industry Canada Standards (RSS).
- PCTEST facility is an IC registered (2451B-1) test laboratory with the site description on file at Industry Canada.
- PCTEST is a CTIA Authorized Test Laboratory (CATL) for AMPS, CDMA, and EvDO wireless devices and for Over-the-Air (OTA) Antenna Performance testing for AMPS, CDMA, GSM, GPRS, EGPRS, UMTS (W-CDMA), CDMA 1xEVDO, and CDMA 1xRTT.

FCC ID: IHDT56PB1	 FCC Pt. 15.247 BLUETOOTH TEST REPORT (CERTIFICATION)		Reviewed by: Quality Manager
Test Report S/N: 0Y1304010567.IHD-R1	Test Dates: 04/04 - 04/25/2013	EUT Type: Portable Handset	Page 3 of 46

1.0 INTRODUCTION

1.1 Scope

Measurement and determination of electromagnetic emissions (EMC) of radio frequency devices including intentional and/or unintentional radiators for compliance with the technical rules and regulations of the Federal Communications Commission and the Industry Canada Certification and Engineering Bureau.



1.2 PCTEST Test Location

The map below shows the location of the PCTEST LABORATORY, its proximity to the FCC Laboratory, the Columbia vicinity, the Baltimore-Washington Intern't'l (BWI) airport, the city of Baltimore and the Washington, DC area. (See Figure 1-1).

These measurement tests were conducted at the PCTEST Engineering Laboratory, Inc. facility located at 7185 Oakland Mills Road, Columbia, MD 21046. The site coordinates are 39° 10'23" N latitude and 76° 49'50" W longitude. The facility is 0.4 miles North of the FCC laboratory, and the ambient signal and ambient signal strength are approximately equal to those of the FCC laboratory. The detailed description of the measurement facility was found to be in compliance with the requirements of § 2.948 according to ANSI C63.4-2009 on February 15, 2012.



Figure 1-1. Map of the Greater Baltimore and Metropolitan Washington, D.C. area

FCC ID: IHDT56PB1		FCC Pt. 15.247 BLUETOOTH TEST REPORT (CERTIFICATION)		Reviewed by: Quality Manager
Test Report S/N: 0Y1304010567.IHD-R1	Test Dates: 04/04 - 04/25/2013	EUT Type: Portable Handset	Page 4 of 46	

2.0 PRODUCT INFORMATION

2.1 Equipment Description

The Equipment Under Test (EUT) is the **Motorola Portable Handset FCC ID: IHDT56PB1**. The test data contained in this report pertains only to the emissions due to the EUT's Bluetooth transmitter.

- This Bluetooth module has been tested by a Bluetooth Qualification Lab, and we confirm the following:
 - A) The hopping sequence is pseudorandom
 - B) All channels are used equally on average
 - C) The receiver input bandwidth equals the transmit bandwidth
 - D) The receiver hops in sequence with the transmit signal
- 15.247(g): In accordance with the Bluetooth Industry Standard, the system is designed to comply with all of the regulations in Section 15.247 when the transmitter is presented with a continuous data (or information) system.
- 15.247(h): In accordance with the Bluetooth Industry Standard, the system does not coordinate its channels selection/ hopping sequence with other frequency hopping systems for the express purpose of avoiding the simultaneous occupancy of individual hopping frequencies by multiple transmitters.
- 15.247(h): The EUT employs Adaptive Frequency Hopping (AFH) which identifies sources of interference namely devices operating in 802.11 WLAN and excludes them from the list of available channels. The process of re-mapping reduces the number of test channels from 79 channels to a minimum number of 20 channels.

2.2 Device Capabilities

This device contains the following capabilities:

850/1900 CDMA/EvDO Rev0/A (BC0, BC1), 850/1900 GSM/GPRS/EDGE, 850/1900 WCDMA/HSPA, Band 4, 13 LTE, 802.11a/b/g/n/AC WLAN (DTS/NII), Bluetooth (1x,EDR, LE), NFC

2.3 Test Configuration

The Motorola Portable Handset FCC ID: IHDT56PB1 was tested per the guidance of ANSI C63.10-2009 and DA 00-705. See Sections 3.2, 3.3, and 6.1 of this test report for a description of the AC line conducted emissions, radiated emissions, and antenna port conducted emissions test setups, respectively.

2.4 EMI Suppression Device(s)/Modifications



No EMI suppression device(s) were added and no modifications were made during testing.

2.5 Labeling Requirements

Per 15.19; Docket 95-19

The label shall be permanently affixed at a conspicuous location on the device; instruction manual or pamphlet supplied to the user and be readily visible to the purchaser at the time of purchase. However, when the device is so small wherein placement of the label with specified statement is not practical, only the trade name and FCC ID must be displayed on the device per Section 15.19(a)(5).

Please see attachment for FCC ID label and label location.

FCC ID: IHDT56PB1		FCC Pt. 15.247 BLUETOOTH TEST REPORT (CERTIFICATION)		Reviewed by: Quality Manager
Test Report S/N: 0Y1304010567.IHD-R1	Test Dates: 04/04 - 04/25/2013	EUT Type: Portable Handset	Page 5 of 46	

3.0 DESCRIPTION OF TEST

3.1 Evaluation Procedure

The measurement procedure described in the American National Standard for Testing Unlicensed Wireless Devices (ANSI C63.10-2009) and the “Filing and Measurement Guidelines for Frequency Hopping Spread Spectrum Systems” (DA 00-705) were used in the measurement of the **Motorola Portable Handset FCC ID: IHDT56PB1**.

Deviation from measurement procedure.....None



3.2 AC Line Conducted Emissions

The line-conducted facility is located inside a 10'x16'x9' shielded enclosure. The shielded enclosure is manufactured by ETS Lindgren RF Enclosures. The shielding effectiveness of the shielded room is in accordance with MIL-Std-285 or NSA 65-5. A 1m x 1.5m wooden table 80cm high is placed 40cm away from the vertical wall and 80cm away from the sidewall of the shielded room. Two 10kHz-30MHz, 50Ω/50μH Line-Impedance Stabilization Networks (LISNs) are bonded to the shielded room floor. Power to the LISNs is filtered by external high-current high-insertion loss power line filters. The external power line filter is an ETS Lindgren Model LPRX-4X30 (100dB Attenuation, 14kHz-18GHz) and the two EMI/RFI filters are ETS Lindgren Model LRW-2030-S1 (100dB Minimum Insertion Loss, 14kHz – 10GHz). These filters attenuate ambient signal noise from entering the measurement lines. These filters are also bonded to the shielded enclosure.

The EUT is powered from one LISN and the support equipment is powered from the second LISN. If the EUT is a DC-powered device, power will be derived from the source power supply it normally will be powered from and this supply line(s) will be connected to the second LISN. All interconnecting cables more than 1 meter were shortened to a 1 meter length by non-inductive bundling (serpentine fashion) and draped over the back edge of the test table. All cables were at least 40cm above the horizontal reference groundplane. Power cables for support equipment were routed down to the second LISN while ensuring that that cables were not draped over the second LISN.

Sufficient time for the EUT, support equipment, and test equipment was allowed in order for them to warm up to their normal operating condition. The RF output of the LISN was connected to the spectrum analyzer and exploratory measurements were made to determine the frequencies producing the maximum emission from the EUT. The spectrum was scanned from 150kHz to 30MHz with a spectrum analyzer. The detector function was set to peak mode for exploratory measurements while the bandwidth of the analyzer was set to 10kHz. The EUT, support equipment, and interconnecting cables were arranged and manipulated to maximize each emission. Each emission was also maximized by varying: power lines, the mode of operation or resolution, clock or data exchange speed, scrolling H pattern to the EUT and/or support equipment whichever determined the worst-case emission. Once the worst case emissions have been identified, the one EUT cable configuration/arrangement and mode of operation that produced these emissions is used for final measurements on the same test site. The analyzer is set to CISPR quasi-peak and average detectors with a 9kHz resolution bandwidth for final measurements.

Line conducted emissions test results are shown in Section 6.11. Automated test software was used to perform the AC line conducted emissions testing. Automated measurement software utilized is Rohde & Schwarz EMC32, Version 8.51.0.

FCC ID: IHDT56PB1	 FCC Pt. 15.247 BLUETOOTH TEST REPORT (CERTIFICATION) 		Reviewed by: Quality Manager
Test Report S/N: 0Y1304010567.IHD-R1	Test Dates: 04/04 - 04/25/2013	EUT Type: Portable Handset	Page 6 of 46

3.3 Radiated Emissions

The radiated test facilities consisted of an indoor 3 meter semi-anechoic chamber used for final measurements and exploratory measurements, when necessary. The measurement area is contained within the semi-anechoic chamber which is shielded from any ambient interference. For measurements above 1GHz absorbers are arranged on the floor between the turn table and the antenna mast in such a way so as to maximize the reduction of reflections. For measurements below 1GHz, the absorbers are removed. An ETS Lindgren Model 2188 raised turntable is used for radiated measurement. It is a continuously rotatable, remote-controlled, metallic turntable and 2 meters (6.56 ft.) in diameter. The turn table is flush with the raised floor of the chamber in order to maintain its function as a ground plane. A 78cm high PVC support structure is placed on top of the turntable. A ¾" (~1.9cm) sheet of high density polyethylene is used as the table top and is placed on top of the PVC supports to bring the total height of the table to 80cm.

For all measurements, the spectrum was scanned through all EUT azimuths and from 1 to 4 meter receive antenna height using a broadband antenna from 30MHz up to the upper frequency shown in 15.33(b)(1) depending on the highest frequency generated or used in the device or on which the device operates or tunes. For frequencies above 1GHz, linearly polarized double ridge horn antennas were used. For frequencies below 30MHz, a calibrated loop antenna was used. When exploratory measurements were necessary, they were performed at 1 meter test distance inside the semi-anechoic chamber using broadband antennas, broadband amplifiers, and spectrum analyzers to determine the frequencies and modes producing the maximum emissions. Sufficient time for the EUT, support equipment, and test equipment was allowed in order for them to warm up to their normal operating condition. The test set-up was placed on top of the 0.8 meter high, 1 x 1.5 meter table. The EUT, support equipment, and interconnecting cables were arranged and manipulated to maximize each emission. Appropriate precaution was taken to ensure that all emissions from the EUT were maximized and investigated. The system configuration, clock speed, mode of operation or video resolution, if applicable, turntable azimuth, and receive antenna height was noted for each frequency found.

Final measurements were made in the semi-anechoic chamber using calibrated, linearly polarized broadband and horn antennas. The test setup was configured to the setup that produced the worst case emissions. The spectrum analyzer was set to investigate all frequencies required for testing to compare the highest radiated disturbances with respect to the specified limits. The turntable containing the EUT was rotated through 360 degrees and the height of the receive antenna was varied 1 to 4 meters and stopped at the azimuth and height producing the maximum emission. Each emission was maximized by varying: the mode of operation or resolution, clock or data rate, scrolling H pattern to the EUT and/or support equipment, and changing the polarity of the receive antenna, whichever produced the worst-case emissions.

FCC ID: IHDT56PB1		FCC Pt. 15.247 BLUETOOTH TEST REPORT (CERTIFICATION)	Reviewed by: Quality Manager
Test Report S/N: 0Y1304010567.IHD-R1	Test Dates: 04/04 - 04/25/2013	EUT Type: Portable Handset	Page 7 of 46

4.0 ANTENNA REQUIREMENTS

Excerpt from §15.203 of the FCC Rules/Regulations:

“An intentional radiator antenna shall be designed to ensure that no antenna other than that furnished by the responsible party can be used with the device. The use of a permanently attached antenna or of an antenna that uses a unique coupling to the intentional radiator shall be considered sufficient to comply with the provisions of this section.”



- The antennas of the Motorola Portable Handset are **permanently attached**.
- There are no provisions for connection to an external antenna.

Conclusion:

The **Motorola Portable Handset FCC ID: IHDT56PB1** unit complies with the requirement of §15.203.

Ch.	Frequency (MHz)
00	2402
:	:
39	2441
:	:
78	2480

Table 4-1. Frequency/ Channel Operations

FCC ID: IHDT56PB1		FCC Pt. 15.247 BLUETOOTH TEST REPORT (CERTIFICATION)		Reviewed by: Quality Manager
Test Report S/N: 0Y1304010567.IHD-R1	Test Dates: 04/04 - 04/25/2013	EUT Type: Portable Handset	Page 8 of 46	

5.0 TEST EQUIPMENT CALIBRATION DATA



Test Equipment Calibration is traceable to the National Institute of Standards and Technology (NIST).

Manufacturer	Model	Description	Cal Date	Cal Interval	Cal Due	Serial Number
-	BT1	Bluetooth Cable Set	1/17/2013	Annual	1/17/2014	N/A
-	RE1	Radiated Emissions Cable Set (UHF/EHF)	3/29/2013	Annual	3/29/2014	N/A
-	RE2	Radiated Emissions Cable Set (VHF/UHF)	3/29/2013	Annual	3/29/2014	N/A
Agilent	8447D	Broadband Amplifier	5/8/2012	Annual	5/8/2013	2443A01900
Agilent	N9020A	MXA Signal Analyzer	10/9/2012	Annual	10/9/2013	US46470561
Agilent	N4010A	Wireless Connectivity Test Set	N/A			GB46170464
Com-Power	AL-130	9kHz - 30MHz Loop Antenna	5/10/2012	Annual	5/10/2013	121034
ETS Lindgren	3117	1-18 GHz DRG Horn (Medium)	7/22/2011	Biennial	7/22/2013	125518
ETS Lindgren	3160-09	18-26.5 GHz Standard Gain Horn	5/30/2012	Biennial	5/30/2014	135427
Mini-Circuits	VHF-3100+	High Pass Filter	1/17/2013	Annual	1/17/2014	30841
Rohde & Schwarz	CMU200	Base Station Simulator	N/A			836536/0005
Rohde & Schwarz	TS-PR18	1-18 GHz Pre-Amplifier	6/26/2012	Annual	6/26/2013	100071
Rohde & Schwarz	TS-PR26	18-26.5 GHz Pre-Amplifier	5/30/2012	Annual	5/30/2013	100040
Rohde & Schwarz	ESU26	EMI Test Receiver	2/25/2013	Annual	2/25/2014	100342
Solar Electronics	8012-50-R-24-BNC	LISN	6/23/2011	Biennial	6/23/2013	310233
Sunol	JB5	Bi-Log Antenna (30M - 5GHz)	1/26/2012	Biennial	1/26/2014	A051107

Table 5-1. Annual Test Equipment Calibration Schedule

Note:

Equipment used for signaling with a calibration date of "N/A" shown in this list was only used for maintaining a link between the piece of equipment and the EUT. This equipment was not used to make direct calibrated measurements.

FCC ID: IHDT56PB1		FCC Pt. 15.247 BLUETOOTH TEST REPORT (CERTIFICATION)		Reviewed by: Quality Manager
Test Report S/N: 0Y1304010567.IHD-R1	Test Dates: 04/04 - 04/25/2013	EUT Type: Portable Handset	Page 9 of 46	

6.0 TEST RESULTS

6.1 Summary



Company Name: Motorola Mobility LLC
 FCC ID: IHDT56PB1
 Method/System: Frequency Hopping Spread Spectrum (FHSS)
 Number of Channels: 79

FCC Part Section(s)	RSS Section(s)	Test Description	Test Limit	Test Condition	Test Result	Reference
TRANSMITTER MODE (Tx)						
15.247(a)(1)(iii)	RSS-210 [A8.1]	20dB Bandwidth	< 1 MHz only if using less than 15 non-overlapping channels	CONDUCTED	PASS	Section 6.2
15.247(b)(1)	RSS-210 [A8.4(2)]	Peak Transmitter Output Power	< 1 Watt if ≥ 75 non-overlapping channels used		PASS	Section 6.3
15.247(a)(1)	RSS-210 [A8.1(2)]	Channel Separation	> 2/3 of 20 dB BW for systems with Output Power < 125mW		PASS	Section 6.5
15.247(a)(1)(iii)	RSS-210 [A8.1(4)]	Number of Channels	> 15 Channels		PASS	Section 6.7
15.247(a)(1)(iii)	RSS-210 [A8.1(4)]	Time of Occupancy	< 0.4 sec in 31.6 sec period		PASS	Section 6.6
15.247(d)	RSS-210 [A8.5]	Band Edge / Out-of-Band Emissions	Conducted > 20dBc		PASS	Section 6.4, Section 6.8
15.205 15.209	RSS-210 [A8.5]	General Field Strength Limits (Restricted Bands and Radiated Emission Limits)	Emissions in restricted bands must meet the radiated limits detailed in 15.209 (RSS-210 table 3 limits)	RADIATED	PASS	Section 6.9, Section 6.10
15.207	RSS-Gen [7.2.2]	AC Conducted Emissions 150kHz – 30MHz	< FCC 15.207 limits or < RSS-Gen table 2 limits	LINE CONDUCTED	PASS	Section 6.11

Table 6-1. Summary of Test Results

Notes:

- 1) All modes of operation and data rates were investigated. The test results shown in the following sections represent the worst case emissions.
- 2) The analyzer plots shown in this section were all taken with a correction table loaded into the analyzer. The correction table was used to account for the losses of the cables, directional couplers, and attenuators used as part of the system to maintain a link between the call box and the EUT at all frequencies of interest.
- 3) All antenna port conducted emissions testing was performed on a test bench with the antenna port of the EUT connected to the spectrum analyzer through calibrated cables, attenuators, and couplers.
- 4) For conducted spurious emissions, automated test software was used to measure emissions and capture the corresponding plots necessary to show compliance. The measurement software utilized is PCTEST "BT Auto", Version 1.6.

FCC ID: IHDT56PB1		FCC Pt. 15.247 BLUETOOTH TEST REPORT (CERTIFICATION)		Reviewed by: Quality Manager
Test Report S/N: 0Y1304010567.IHD-R1	Test Dates: 04/04 - 04/25/2013	EUT Type: Portable Handset		Page 10 of 46

6.2 20dB Bandwidth Measurement

§15.247 (a)(1)(iii); RSS-210 (A8.1)

The bandwidth at 20dB down from the highest in-band spectral density is measured with a spectrum analyzer connected to the receive antenna while the EUT is operating in transmission mode at the appropriate frequencies. **The maximum permissible 20dB bandwidth is 1 MHz, unless more than 15 non-overlapping channels are employed.**

Frequency [MHz]	Data Rate [Mbps]	Channel No.	20dB Bandwidth Test Results	
			[kHz]	Pass/Fail
2402	1.0	0	965	Pass
2441	1.0	39	954.3	Pass
2480	1.0	78	956.5	Pass
2402	2.0	0	1286	Pass
2441	2.0	39	1284	Pass
2480	2.0	78	1286	Pass
2402	3.0	0	1297	Pass
2441	3.0	39	1286	Pass
2480	3.0	78	1292	Pass

Table 6-2. Conducted 20dB Bandwidth Measurements

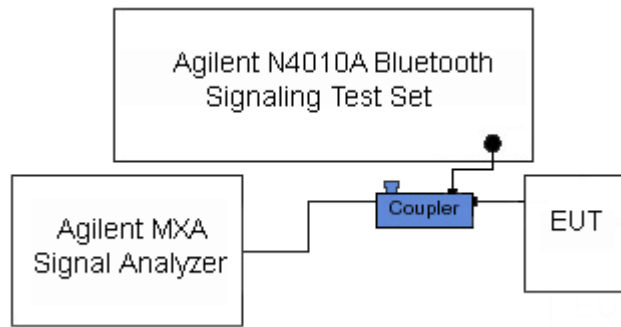

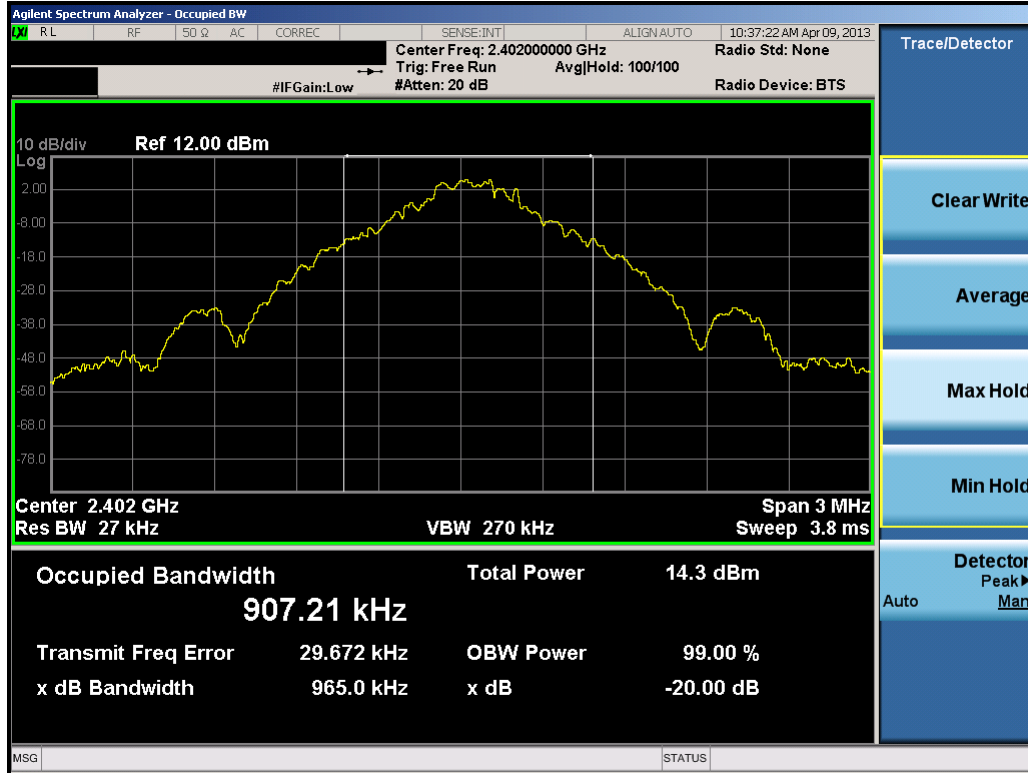
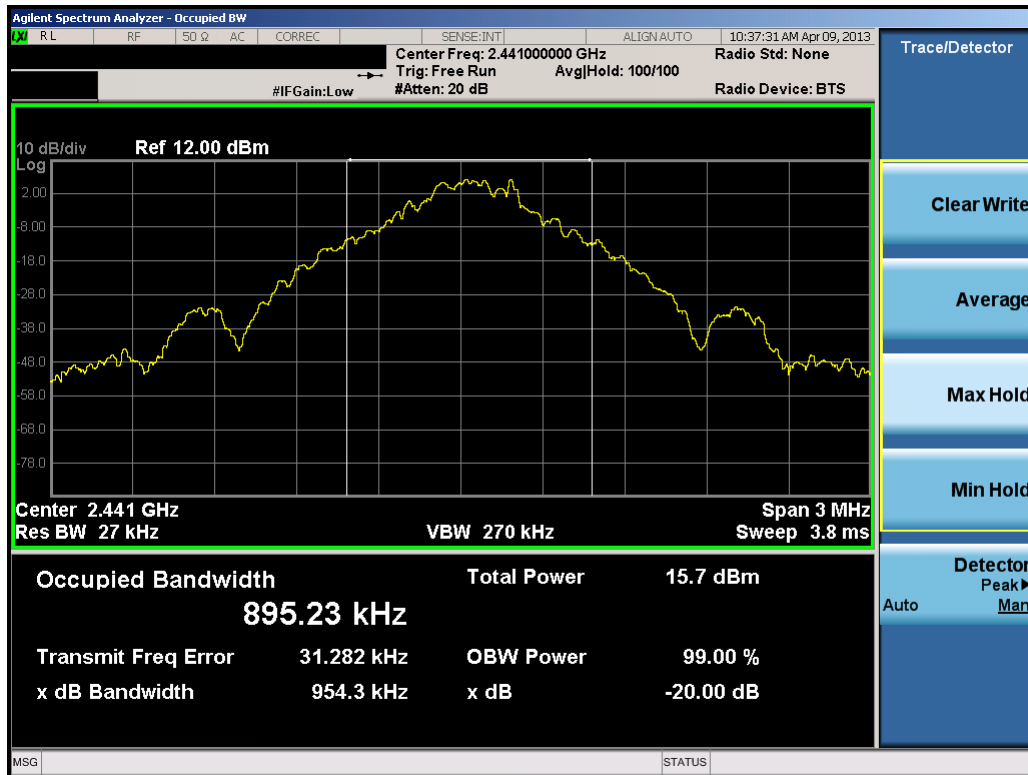

Figure 6-1. Test Instrument & Measurement Setup

FCC ID: IHDT56PB1		FCC Pt. 15.247 BLUETOOTH TEST REPORT (CERTIFICATION)		Reviewed by: Quality Manager
Test Report S/N: 0Y1304010567.IHD-R1	Test Dates: 04/04 - 04/25/2013	EUT Type: Portable Handset		Page 11 of 46



Plot 6-1. 20dB Bandwidth Plot (Bluetooth, 1Mbps – Ch. 0)



Plot 6-2. 20dB Bandwidth Plot (Bluetooth, 1Mbps – Ch. 39)

FCC ID: IHDT56PB1		FCC Pt. 15.247 BLUETOOTH TEST REPORT (CERTIFICATION)		Reviewed by: Quality Manager
Test Report S/N: 0Y1304010567.IHD-R1	Test Dates: 04/04 - 04/25/2013	EUT Type: Portable Handset		Page 12 of 46

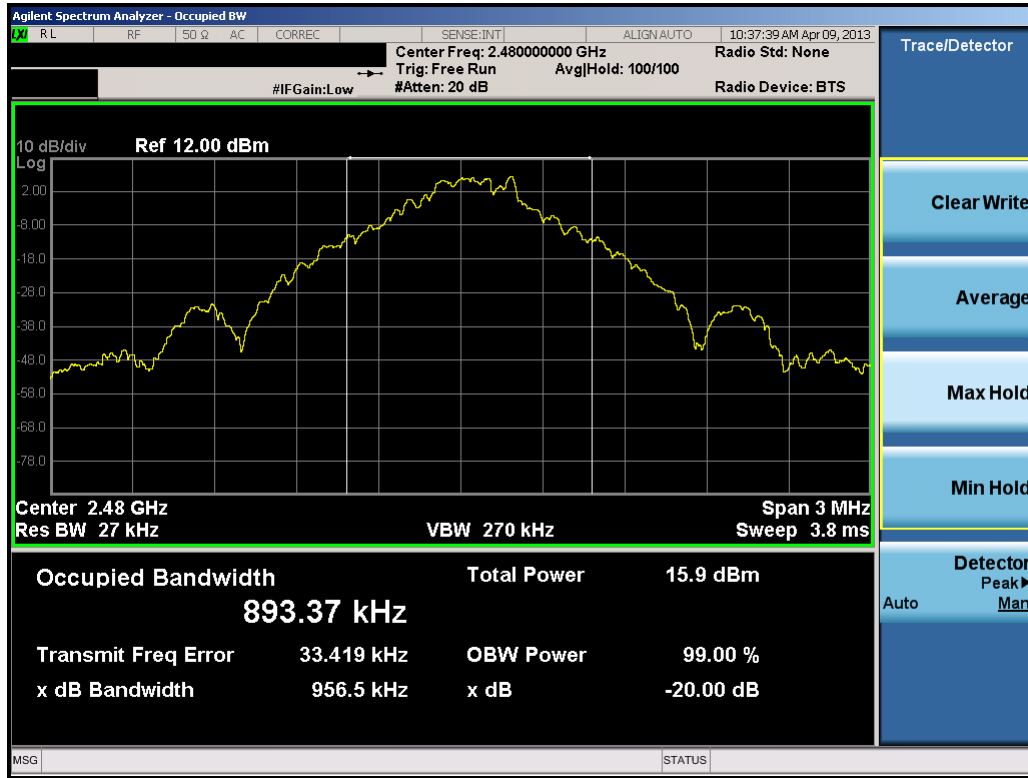

Plot 6-3. 20dB Bandwidth Plot (Bluetooth, 1Mbps – Ch. 78)

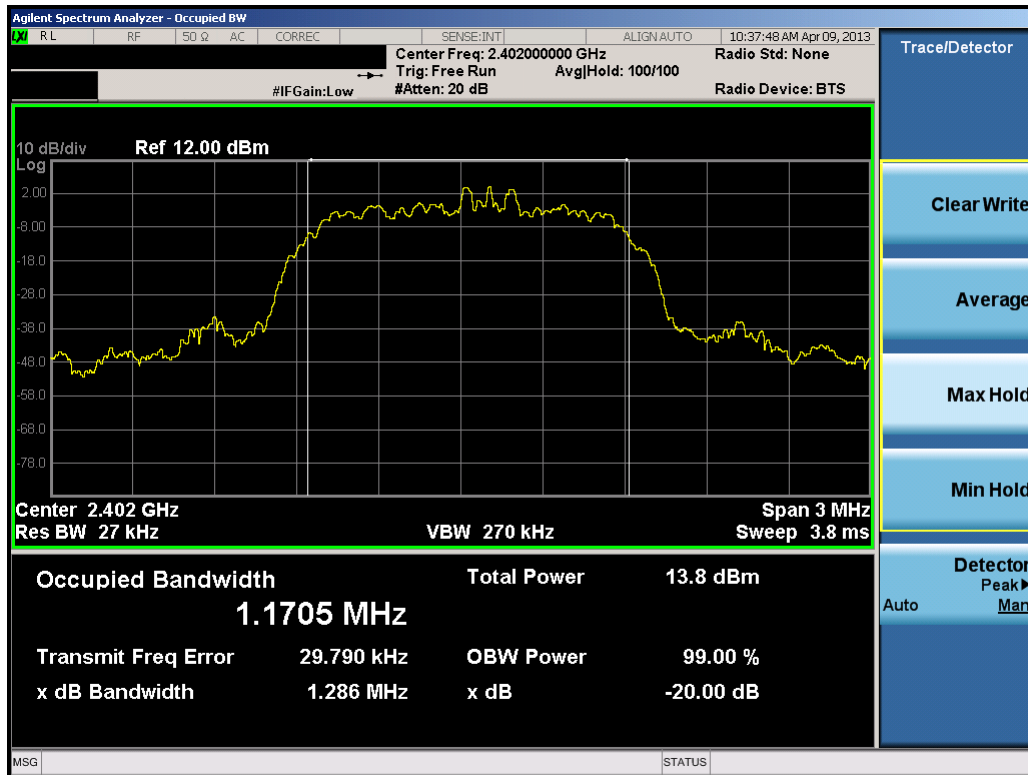

Plot 6-4. 20dB Bandwidth Plot (Bluetooth, 2Mbps – Ch. 0)

FCC ID: IHDT56PB1		FCC Pt. 15.247 BLUETOOTH TEST REPORT (CERTIFICATION)		Reviewed by: Quality Manager
Test Report S/N: 0Y1304010567.IHD-R1	Test Dates: 04/04 - 04/25/2013	EUT Type: Portable Handset		Page 13 of 46

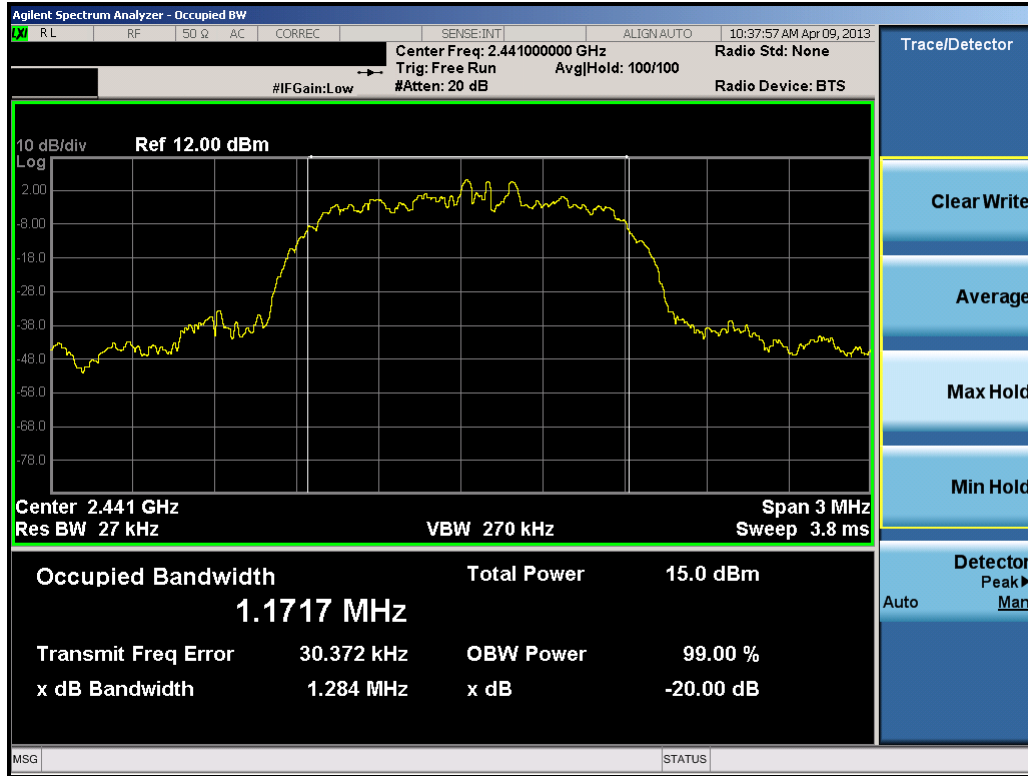

Plot 6-5. 20dB Bandwidth Plot (Bluetooth, 2Mbps – Ch. 39)

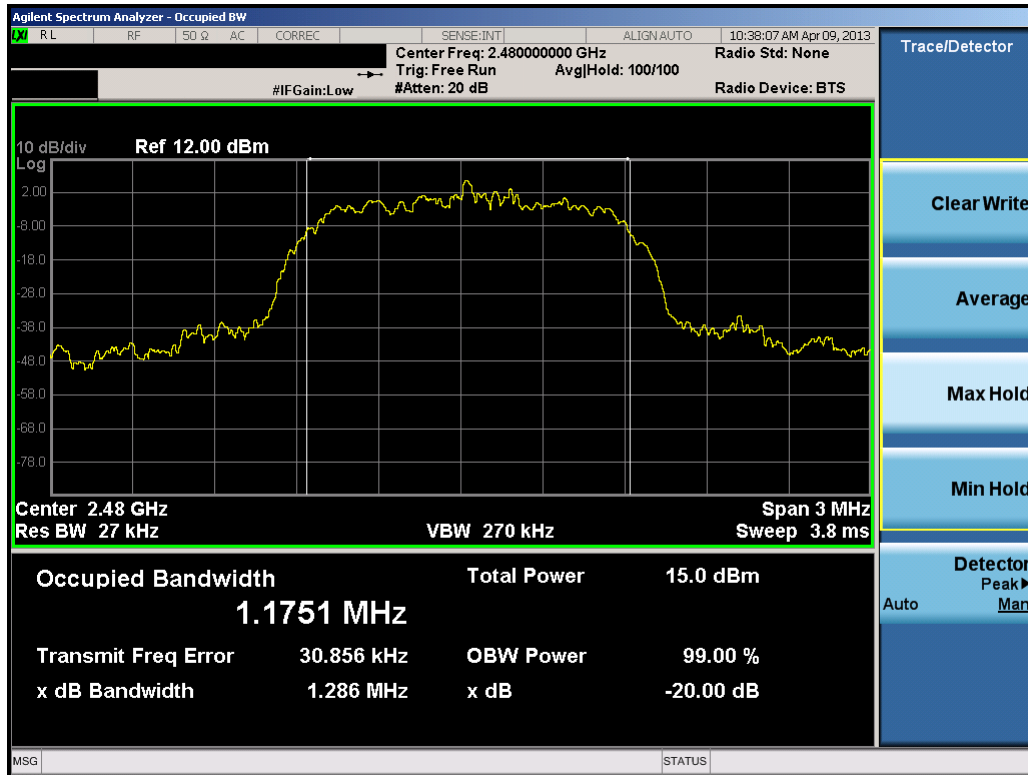

Plot 6-6. 20dB Bandwidth Plot (Bluetooth, 2Mbps – Ch. 78)

FCC ID: IHDT56PB1		FCC Pt. 15.247 BLUETOOTH TEST REPORT (CERTIFICATION)		Reviewed by: Quality Manager
Test Report S/N: 0Y1304010567.IHD-R1	Test Dates: 04/04 - 04/25/2013	EUT Type: Portable Handset		Page 14 of 46

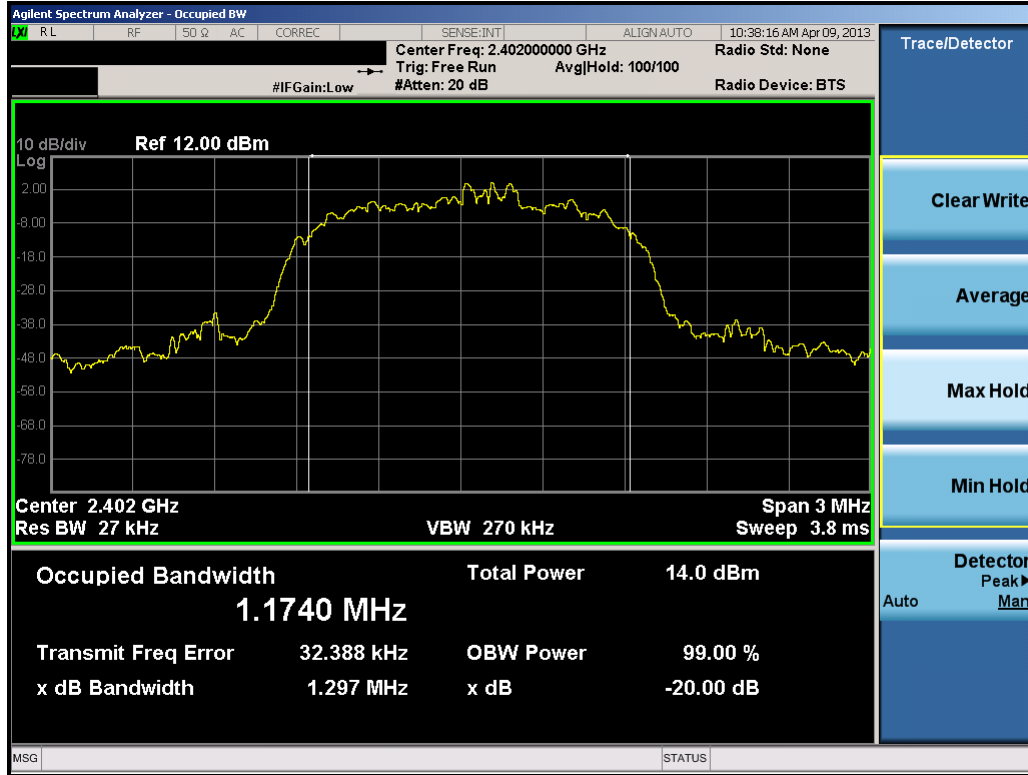

Plot 6-7. 20dB Bandwidth Plot (Bluetooth, 3Mbps – Ch. 0)

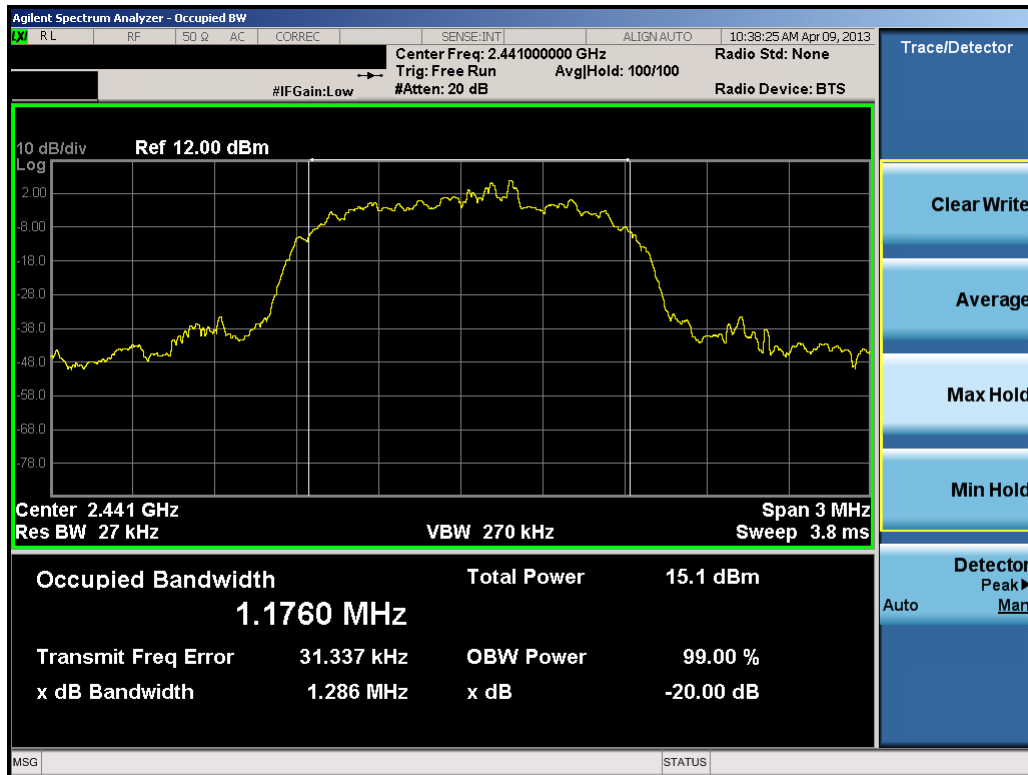

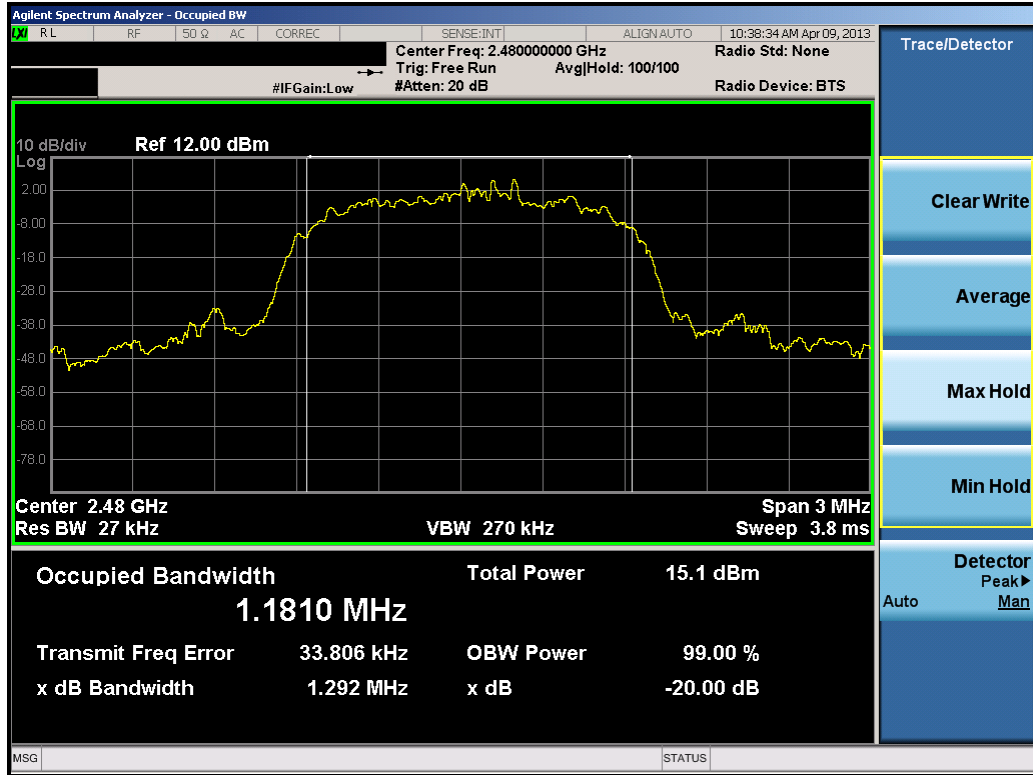

Plot 6-8. 20dB Bandwidth Plot (Bluetooth, 3Mbps – Ch. 39)

FCC ID: IHDT56PB1		FCC Pt. 15.247 BLUETOOTH TEST REPORT (CERTIFICATION)		Reviewed by: Quality Manager
Test Report S/N: 0Y1304010567.IHD-R1	Test Dates: 04/04 - 04/25/2013	EUT Type: Portable Handset		Page 15 of 46



Plot 6-9. 20dB Bandwidth Plot (Bluetooth, 3Mbps – Ch. 78)

FCC ID: IHDT56PB1		FCC Pt. 15.247 BLUETOOTH TEST REPORT (CERTIFICATION)		Reviewed by: Quality Manager
Test Report S/N: 0Y1304010567.IHD-R1	Test Dates: 04/04 - 04/25/2013	EUT Type: Portable Handset		Page 16 of 46

6.3 Output Power Measurement

§15.247 (b)(1); RSS-210 (A8.4 (2))

Measurement is made while the EUT is operating in non-hopping transmission mode. The powers shown below were measured using a spectrum analyzer with a Bluetooth signaling test set (Agilent Model: N4010A) used only to maintain a Bluetooth link with the EUT. Peak power measurements are performed in the analyzers' swept spectrum mode using a peak detector with RBW = 3MHz and VBW ≥ RBW. Average power data is provided to determine the need for Bluetooth SAR testing according to KDB 447498 D01 v05. Average power measurements are performed using the analyzer's "burst power" function with RBW = 3MHz. The burst power function triggers on a single burst set to maximum power and measures the maximum average power over the on-time. **The maximum permissible output power is 1 Watt.**

This unit was tested with all possible data rates and the highest peak power is reported with the unit transmitting at 3Mbps.

Frequency [MHz]	Data Rate [Mbps]	Channel No.	Peak Conducted Power		Avg Conducted Power	
			[dBm]	[mW]	[dBm]	[mW]
2402	1.0	0	7.69	5.879	7.35	5.426
2441	1.0	39	8.84	7.649	8.50	7.080
2480	1.0	78	9.04	8.011	8.72	7.440
2402	2.0	0	8.72	7.451	5.85	3.844
2441	2.0	39	9.87	9.694	7.02	5.033
2480	2.0	78	10.06	10.139	7.22	5.269
2402	3.0	0	8.97	7.881	5.93	3.916
2441	3.0	39	10.11	10.252	7.08	5.108
2480	3.0	78	10.31	10.728	7.30	5.364

Table 6-3. Conducted Output Power Measurements

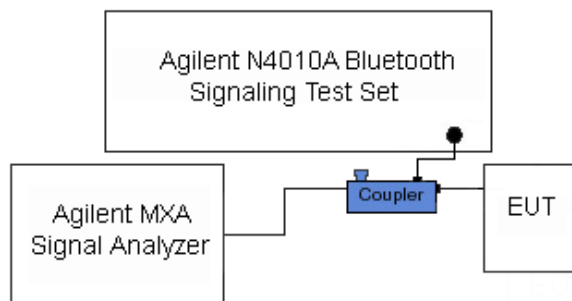



Figure 6-2. Test Instrument & Measurement Setup

Note

Final results were obtained using calibrated couplers, attenuators and cables. The following formula was used:

$$\text{Output Power (dBm)} = \text{Raw Analyzer Level (dBm)} + \text{Cable Loss (dB)} + \text{Loss in Directional Coupler/Insertion Loss (dB)}$$

FCC ID: IHDT56PB1		FCC Pt. 15.247 BLUETOOTH TEST REPORT (CERTIFICATION)		Reviewed by: Quality Manager
Test Report S/N: 0Y1304010567.IHD-R1	Test Dates: 04/04 - 04/25/2013	EUT Type: Portable Handset		Page 17 of 46

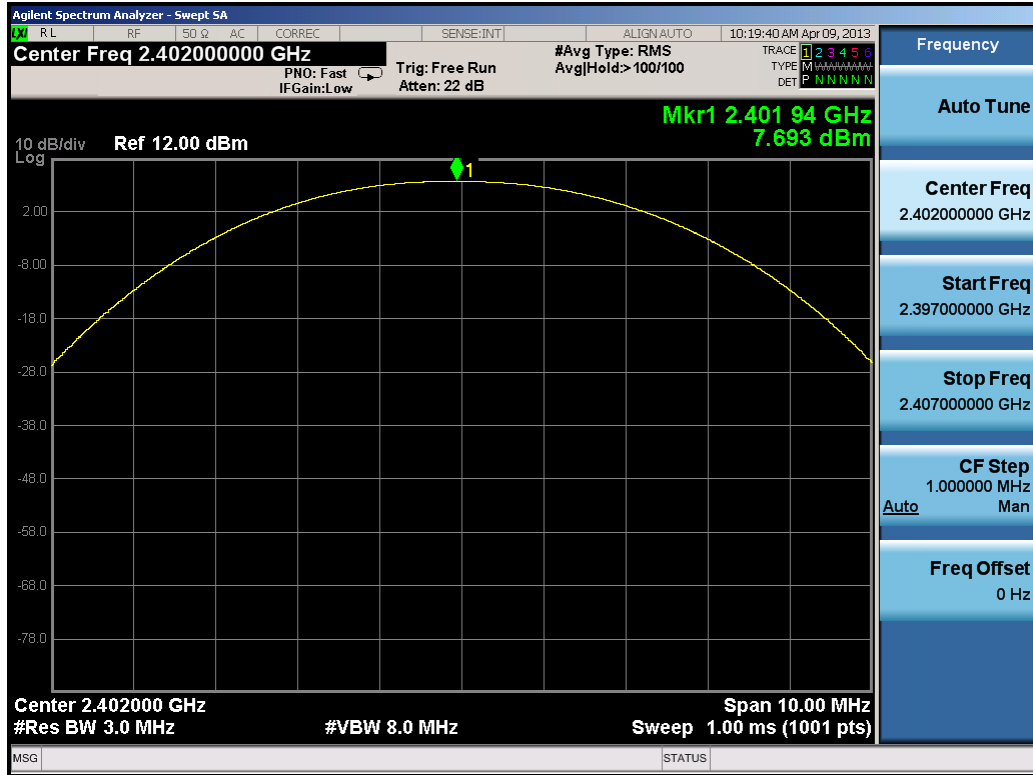

Plot 6-10. Peak Conducted Power (1Mbps – Ch. 0)

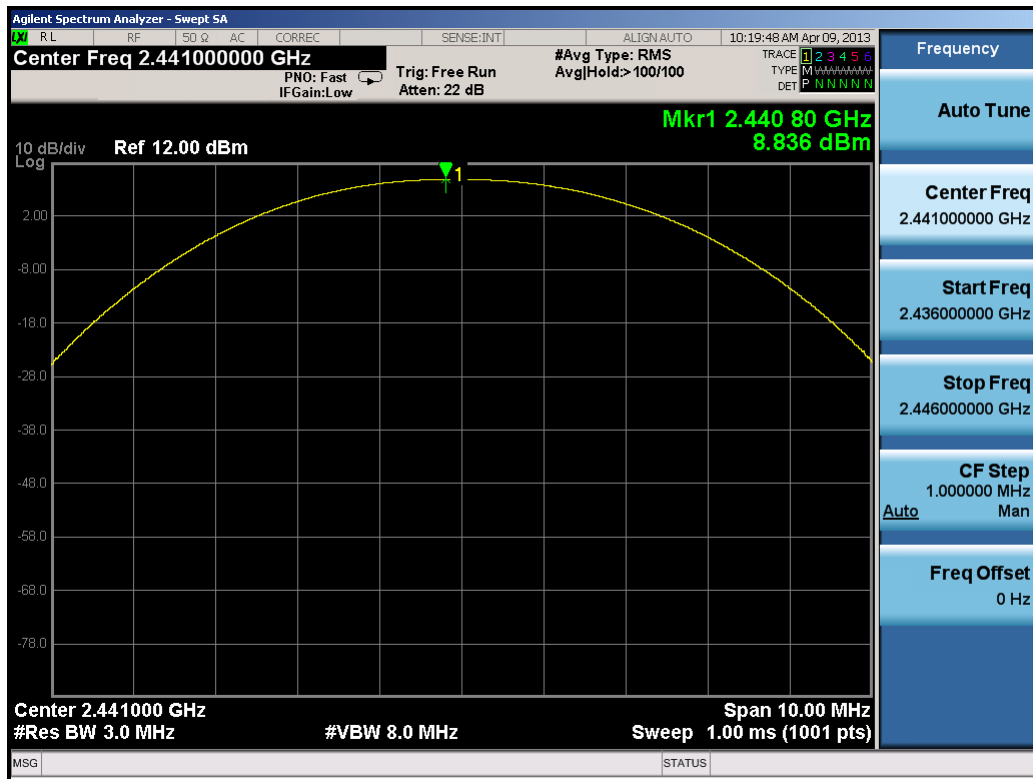

Plot 6-11. Peak Conducted Power (1Mbps – Ch. 39)

FCC ID: IHDT56PB1		FCC Pt. 15.247 BLUETOOTH TEST REPORT (CERTIFICATION)		Reviewed by: Quality Manager
Test Report S/N: 0Y1304010567.IHD-R1	Test Dates: 04/04 - 04/25/2013	EUT Type: Portable Handset		Page 18 of 46

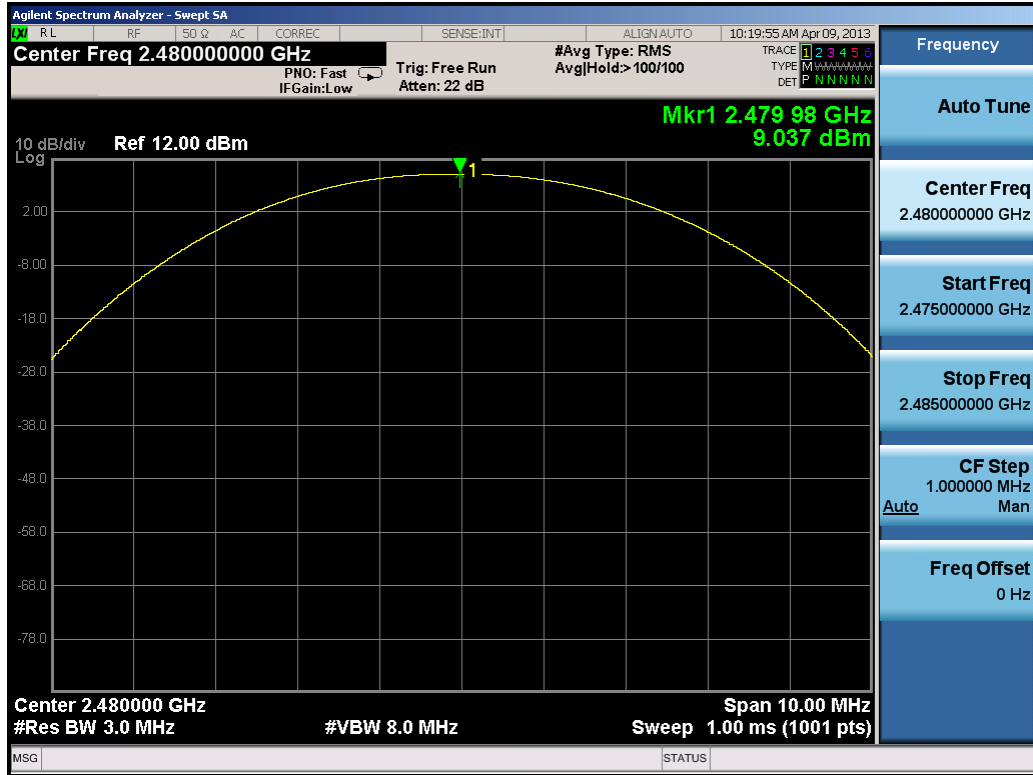

Plot 6-12. Peak Conducted Power (1Mbps – Ch. 78)

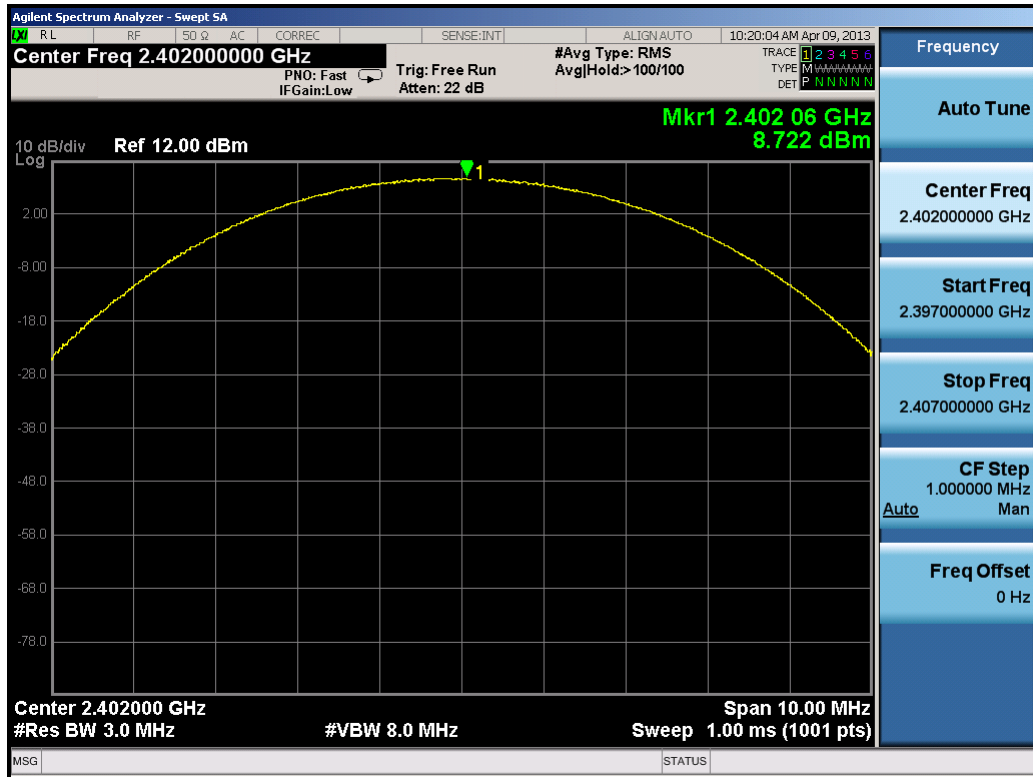

Plot 6-13. Peak Conducted Power (2Mbps – Ch. 0)

FCC ID: IHDT56PB1		FCC Pt. 15.247 BLUETOOTH TEST REPORT (CERTIFICATION)		Reviewed by: Quality Manager
Test Report S/N: 0Y1304010567.IHD-R1	Test Dates: 04/04 - 04/25/2013	EUT Type: Portable Handset		Page 19 of 46

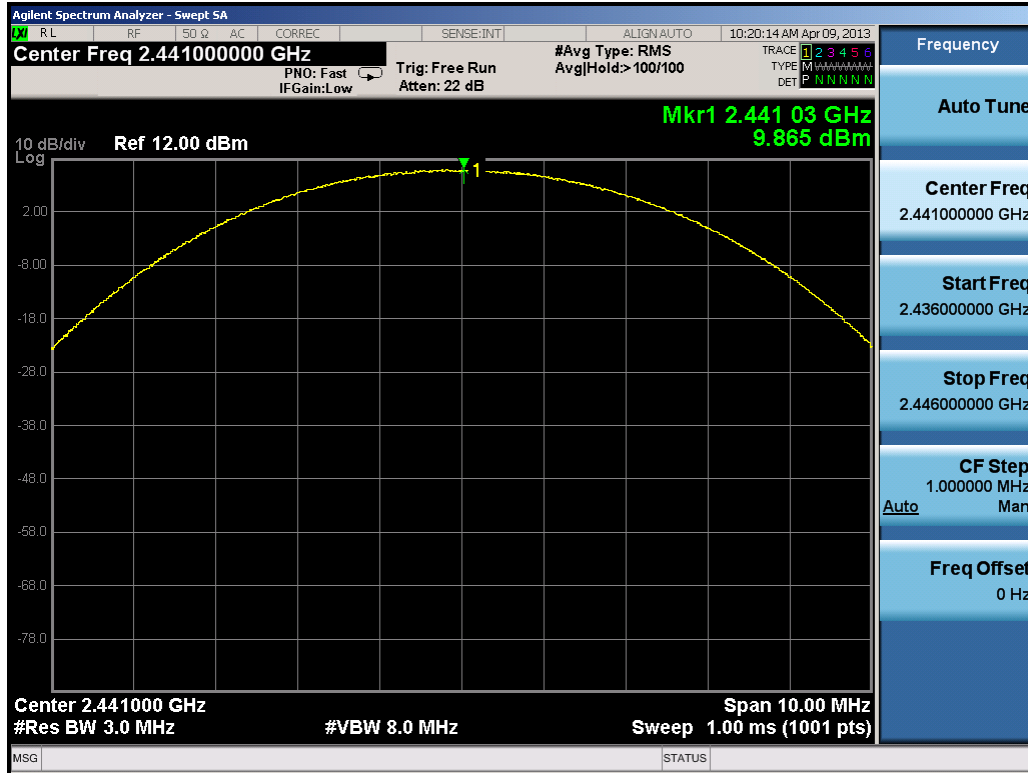

Plot 6-14. Peak Conducted Power (2Mbps – Ch. 39)

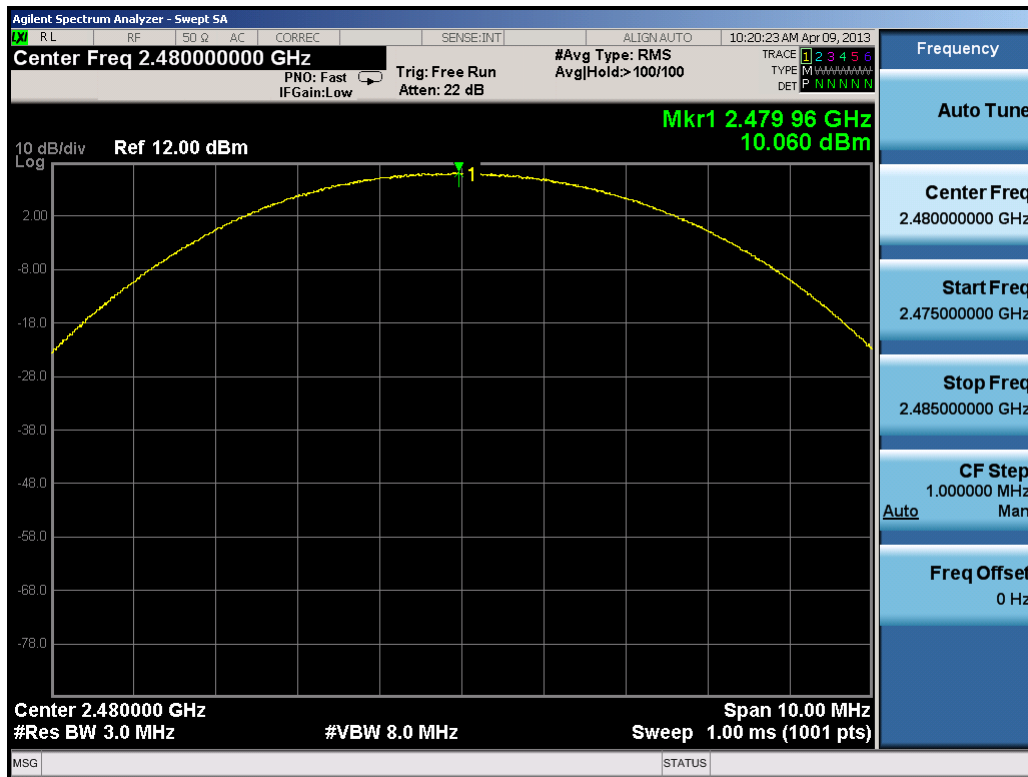

Plot 6-15. Peak Conducted Power (2Mbps – Ch. 78)

FCC ID: IHDT56PB1		FCC Pt. 15.247 BLUETOOTH TEST REPORT (CERTIFICATION)		Reviewed by: Quality Manager
Test Report S/N: 0Y1304010567.IHD-R1	Test Dates: 04/04 - 04/25/2013	EUT Type: Portable Handset		Page 20 of 46

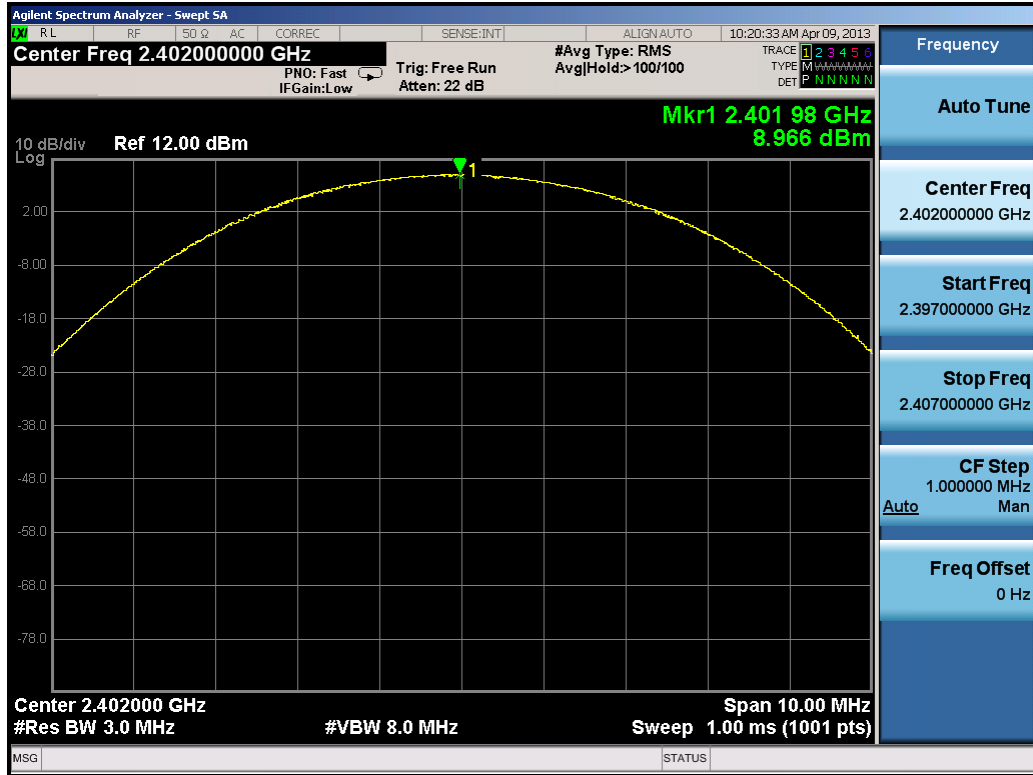

Plot 6-16. Peak Conducted Power (3Mbps – Ch. 0)

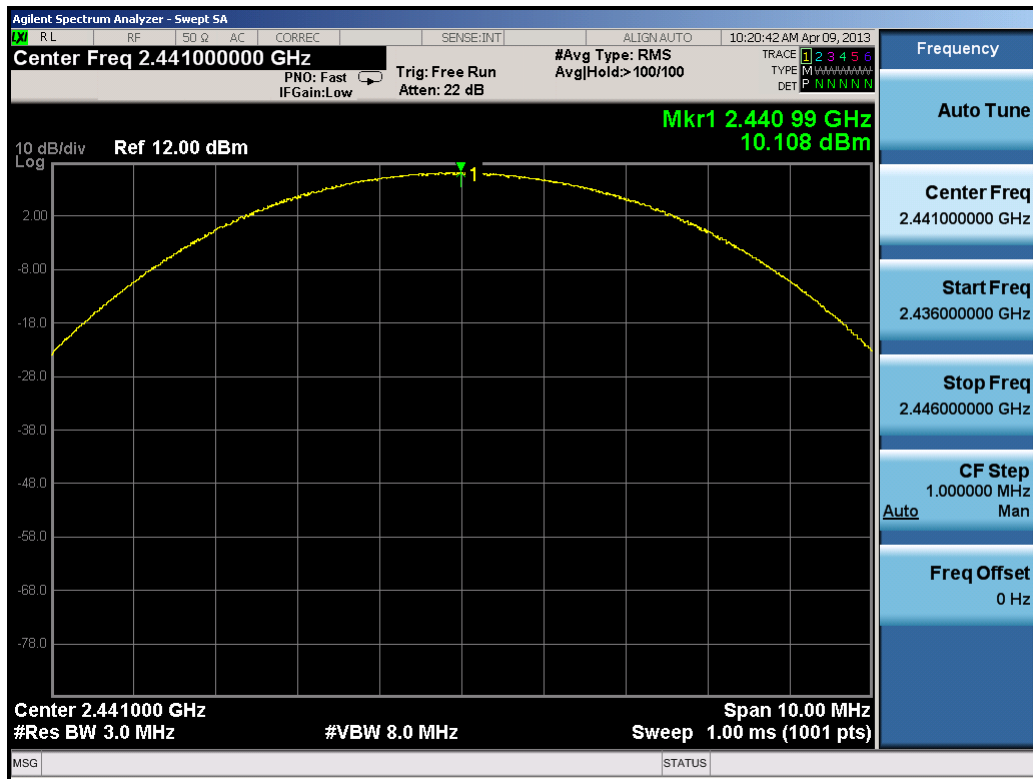

Plot 6-17. Peak Conducted Power (3Mbps – Ch. 39)

FCC ID: IHDT56PB1		FCC Pt. 15.247 BLUETOOTH TEST REPORT (CERTIFICATION)		Reviewed by: Quality Manager
Test Report S/N: 0Y1304010567.IHD-R1	Test Dates: 04/04 - 04/25/2013	EUT Type: Portable Handset		Page 21 of 46

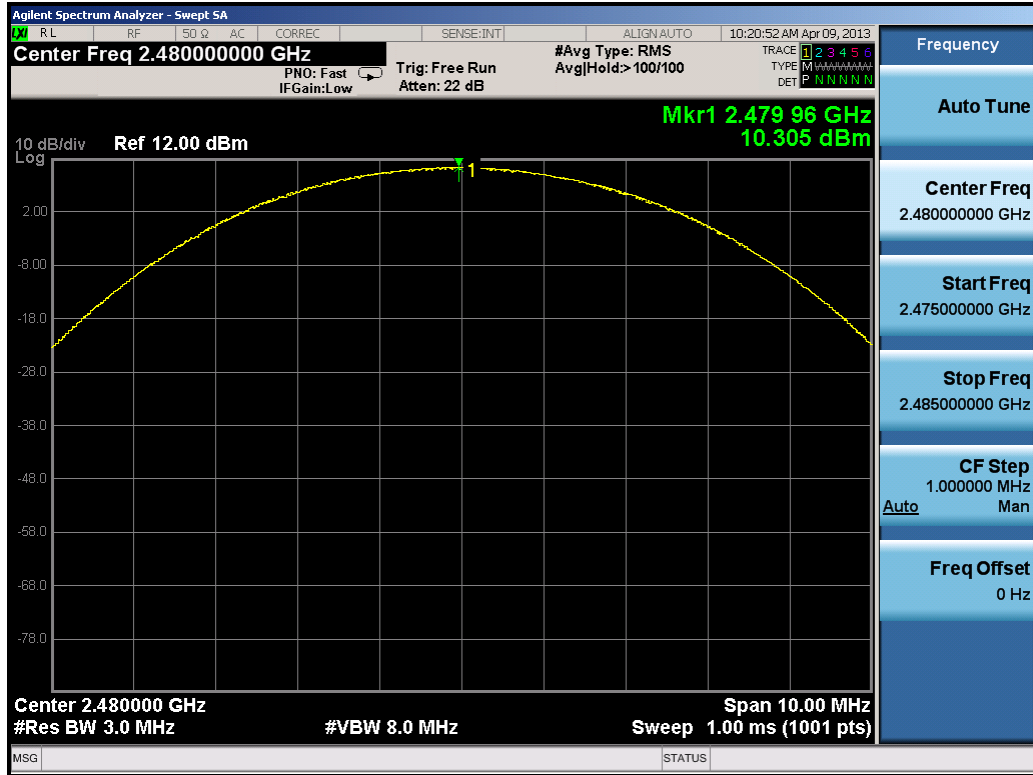

Plot 6-18. Peak Conducted Power (3Mbps – Ch. 78)

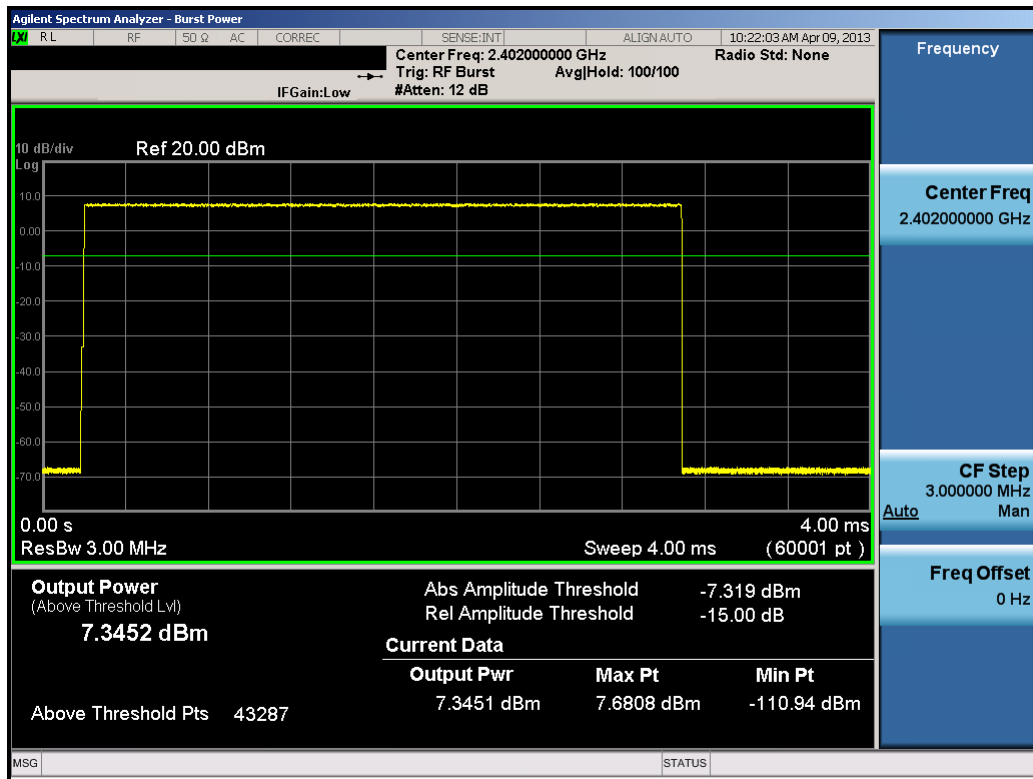

Plot 6-19. Average Conducted Power (1Mbps – Ch. 0)

FCC ID: IHDT56PB1		FCC Pt. 15.247 BLUETOOTH TEST REPORT (CERTIFICATION)		Reviewed by: Quality Manager
Test Report S/N: 0Y1304010567.IHD-R1	Test Dates: 04/04 - 04/25/2013	EUT Type: Portable Handset		Page 22 of 46

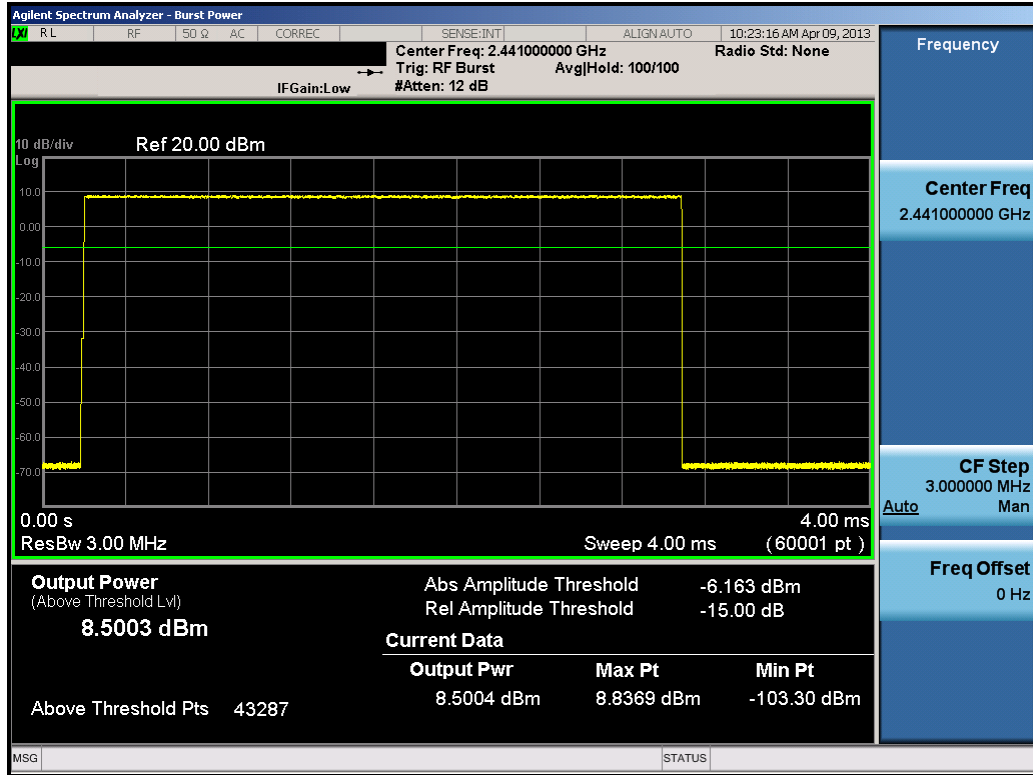

Plot 6-20. Average Conducted Power (1Mbps – Ch. 39)

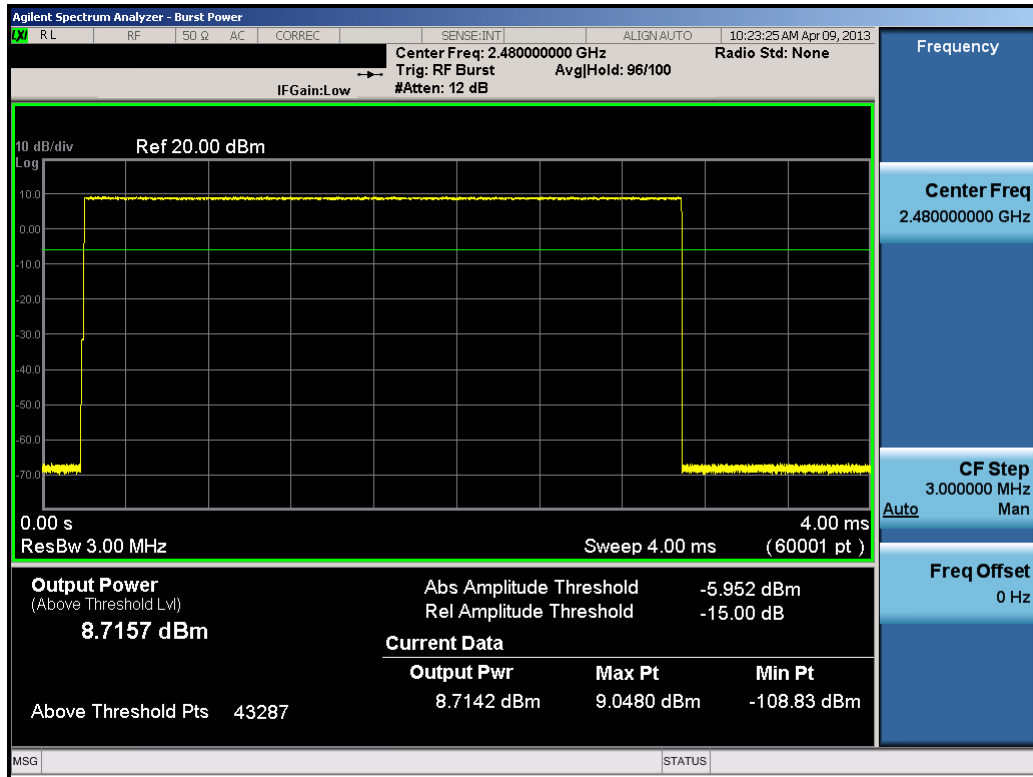

Plot 6-21. Average Conducted Power (1Mbps – Ch. 78)

FCC ID: IHDT56PB1		FCC Pt. 15.247 BLUETOOTH TEST REPORT (CERTIFICATION)		Reviewed by: Quality Manager
Test Report S/N: 0Y1304010567.IHD-R1	Test Dates: 04/04 - 04/25/2013	EUT Type: Portable Handset		Page 23 of 46

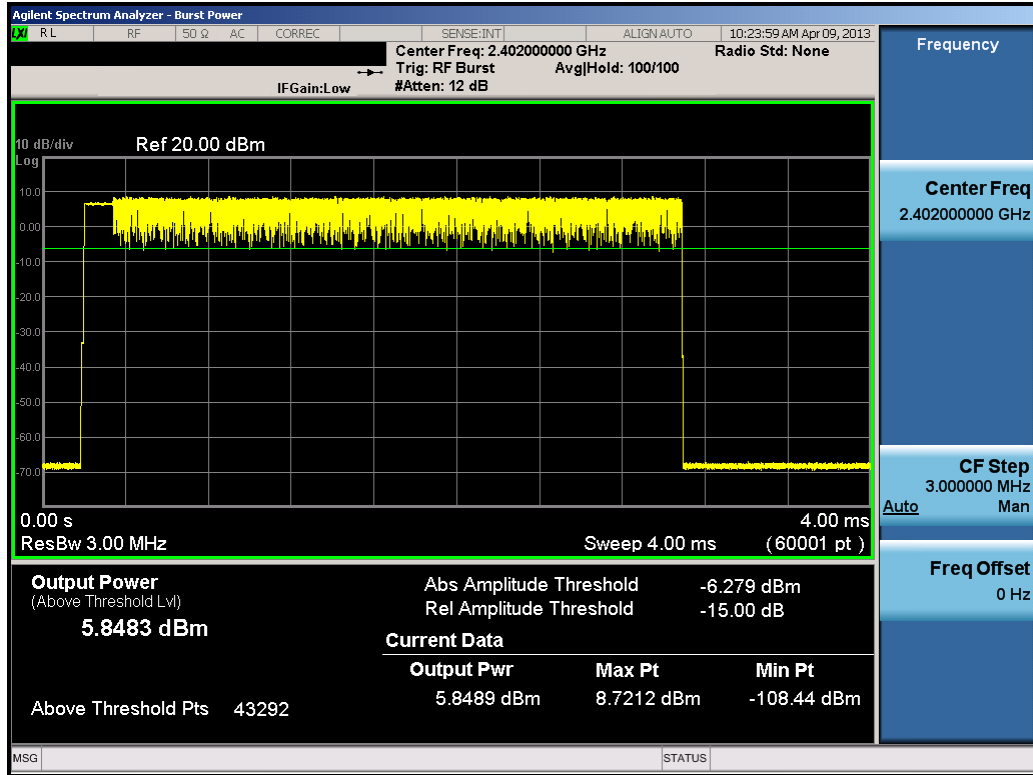

Plot 6-22. Average Conducted Power (2Mbps – Ch. 0)

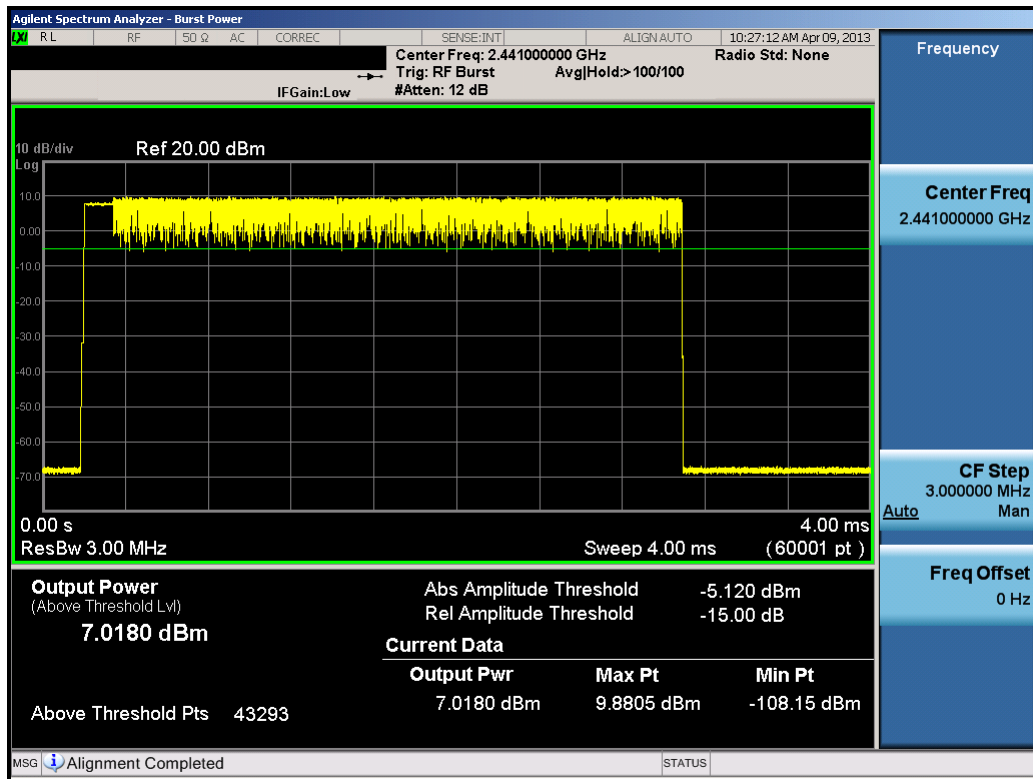

Plot 6-23. Average Conducted Power (2Mbps – Ch. 39)

FCC ID: IHDT56PB1		FCC Pt. 15.247 BLUETOOTH TEST REPORT (CERTIFICATION)		Reviewed by: Quality Manager
Test Report S/N: 0Y1304010567.IHD-R1	Test Dates: 04/04 - 04/25/2013	EUT Type: Portable Handset		Page 24 of 46

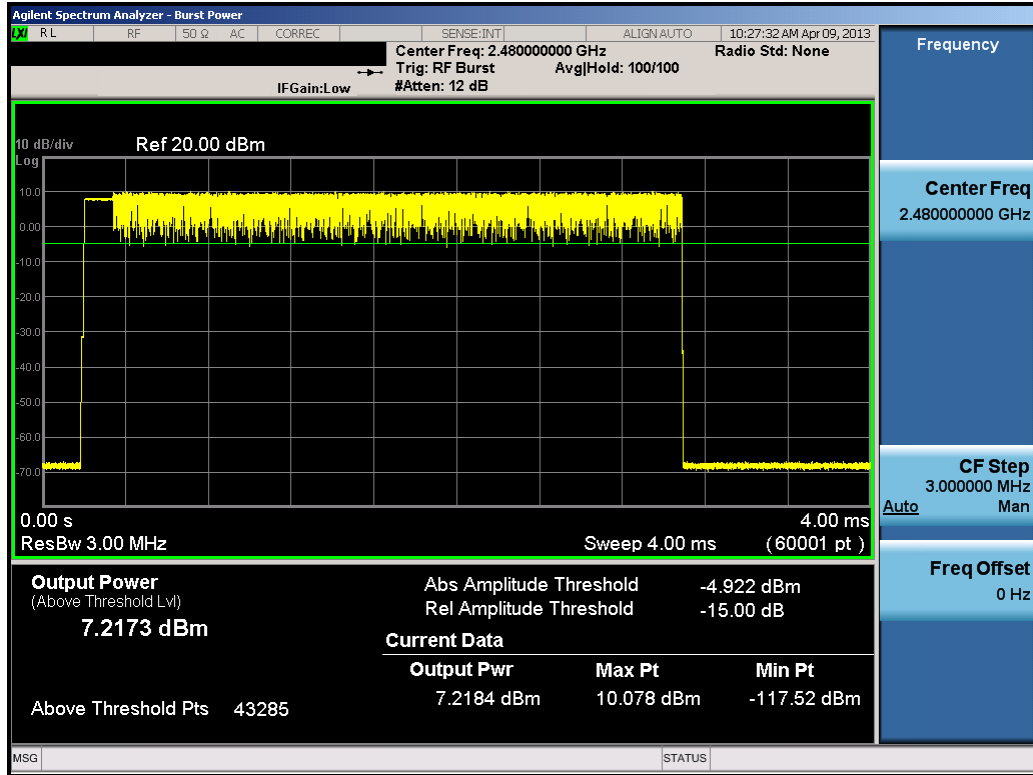

Plot 6-24. Average Conducted Power (2Mbps – Ch. 78)

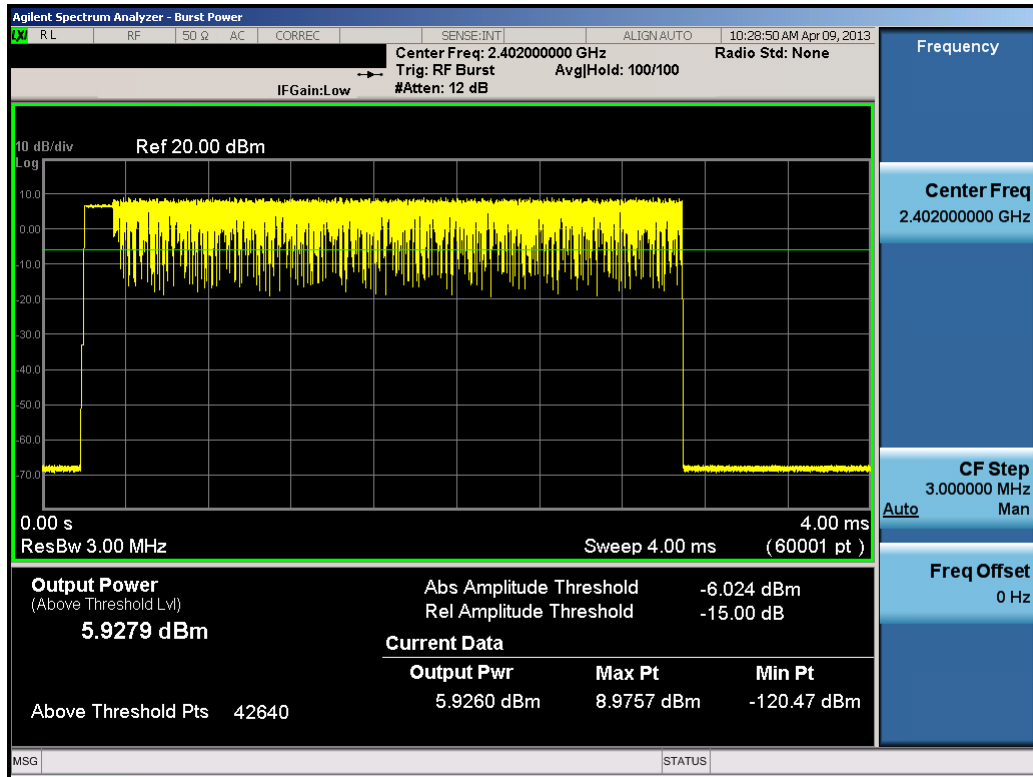

Plot 6-25. Average Conducted Power (3Mbps – Ch. 0)

FCC ID: IHDT56PB1		FCC Pt. 15.247 BLUETOOTH TEST REPORT (CERTIFICATION)		Reviewed by: Quality Manager
Test Report S/N: 0Y1304010567.IHD-R1	Test Dates: 04/04 - 04/25/2013	EUT Type: Portable Handset		Page 25 of 46

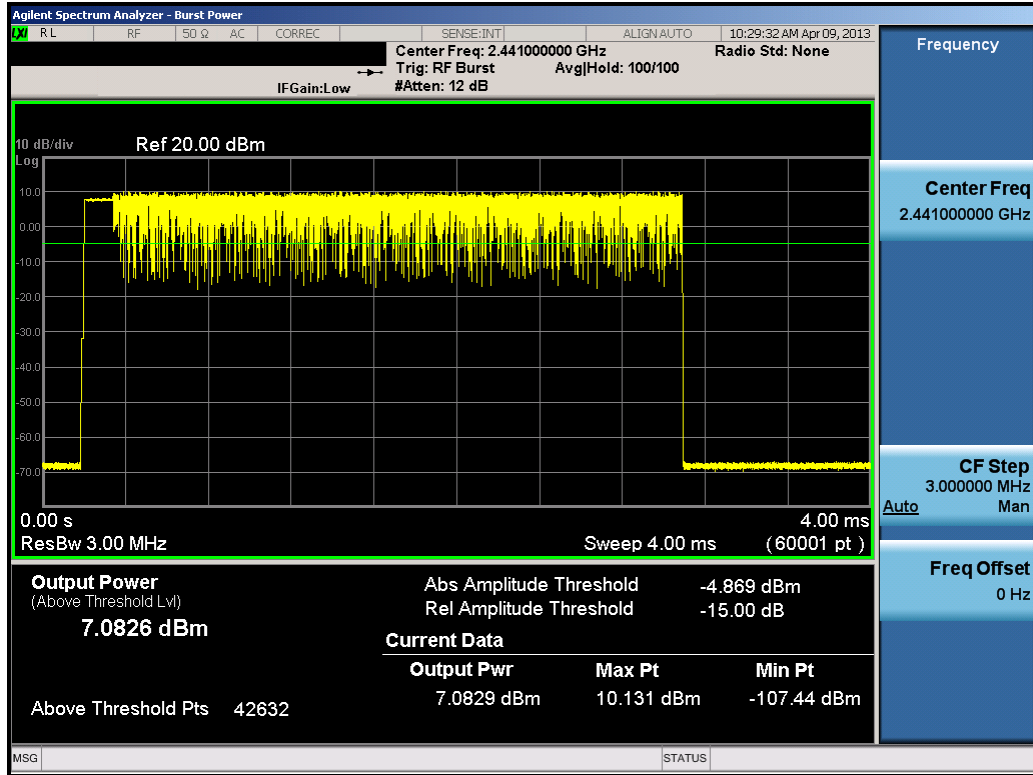

Plot 6-26. Average Conducted Power (3Mbps – Ch. 39)

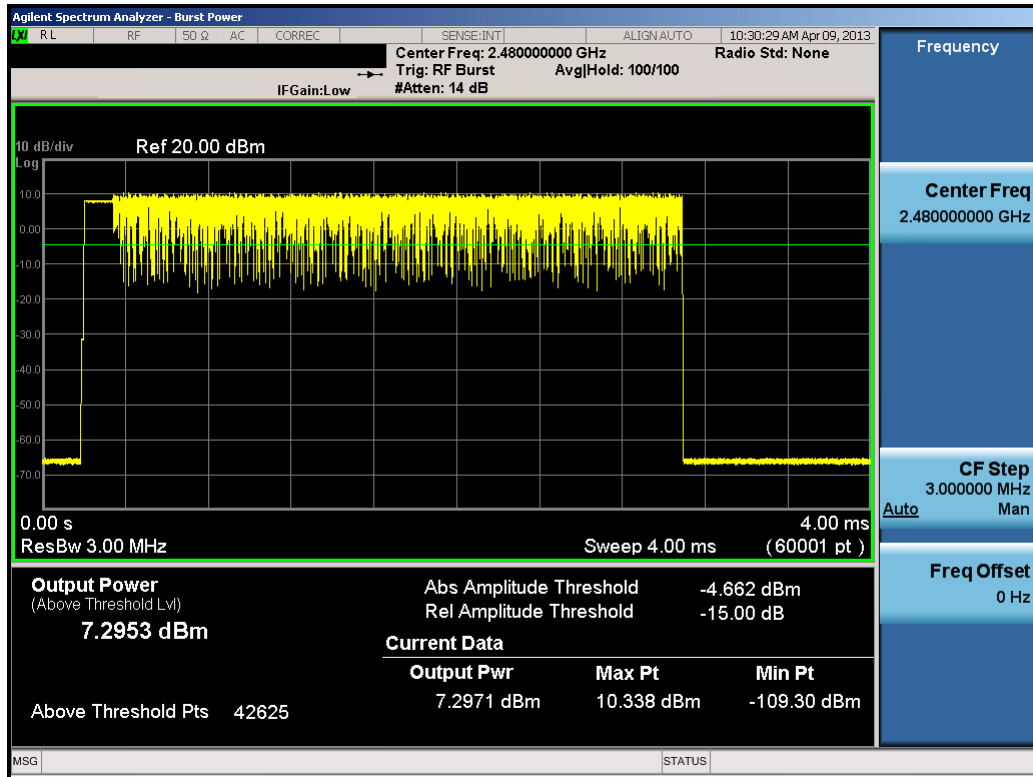

Plot 6-27. Average Conducted Power (3Mbps – Ch. 78)

FCC ID: IHDT56PB1	PCTEST ENGINEERING LABORATORY, INC.	FCC Pt. 15.247 BLUETOOTH TEST REPORT (CERTIFICATION)	MOTOROLA	Reviewed by: Quality Manager
Test Report S/N: 0Y1304010567.IHD-R1	Test Dates: 04/04 - 04/25/2013	EUT Type: Portable Handset		Page 26 of 46

6.4 Band Edge Compliance

§15.247 (d); RSS-210 (A8.5)

Measurement is taken at the highest point located outside of the emission bandwidth. **The maximum permissible emission level is 20 dBc. Any emission lying outside of the emission bandwidth and in a restricted band is subject to a field strength limit specified in Section 15.209 of the Title 47 CFR.**

Out of band conducted spurious emissions at the band edge were investigated for all data rates and the worst case emissions were found with the EUT transmitting at 3Mbps. Band edge emissions were also investigated with the EUT transmitting in all data rates. Plots of the worst case emissions are shown below.

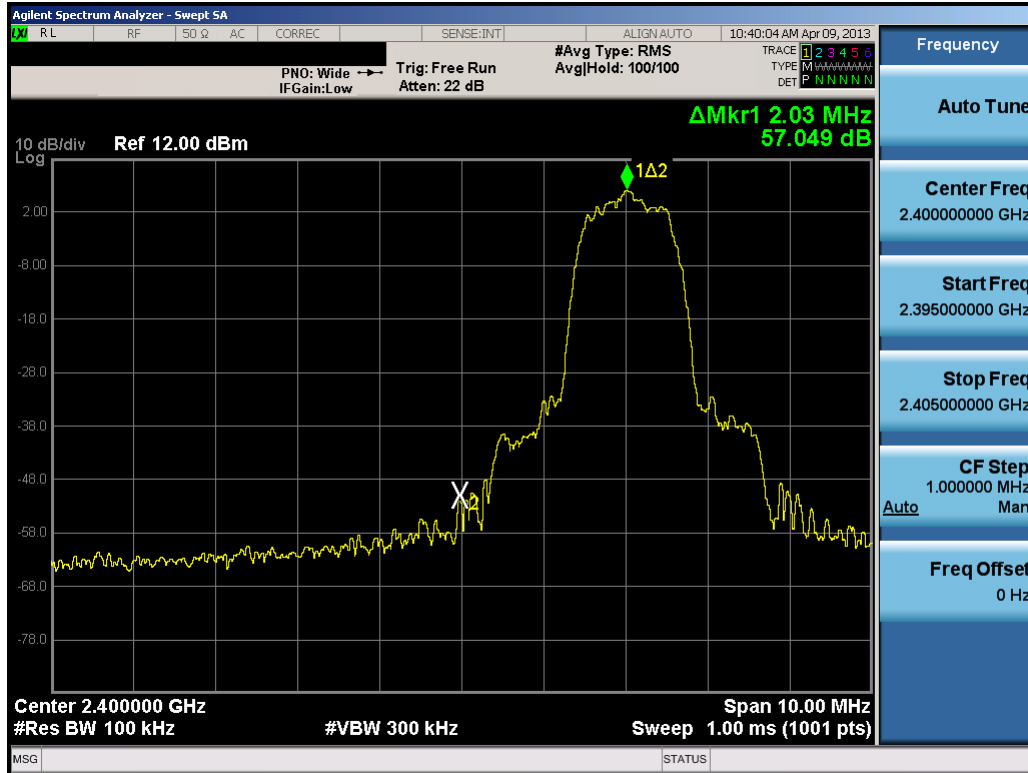

Plot 6-28. Band Edge Plot (Bluetooth with Hopping Disabled, 3Mbps – Ch. 0)

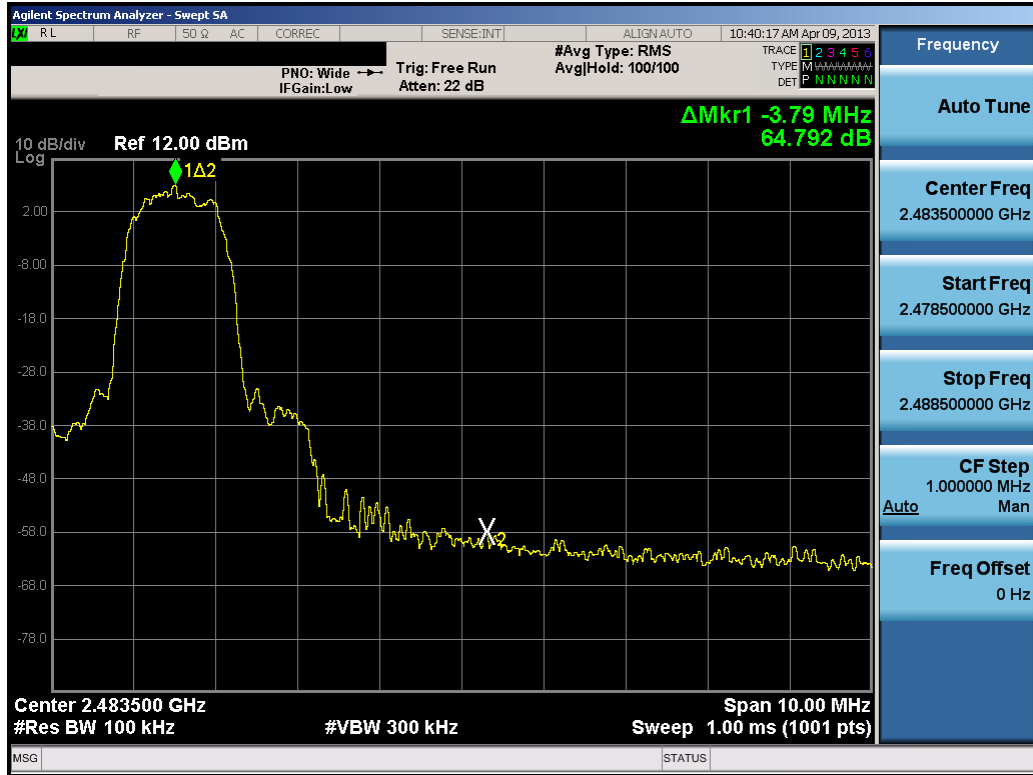

FCC ID: IHDT56PB1		FCC Pt. 15.247 BLUETOOTH TEST REPORT (CERTIFICATION)		Reviewed by: Quality Manager
Test Report S/N: 0Y1304010567.IHD-R1	Test Dates: 04/04 - 04/25/2013	EUT Type: Portable Handset		Page 27 of 46



Plot 6-29. Band Edge Plot (Bluetooth with Hopping Disabled, 3Mbps – Ch. 78)





Plot 6-30. Band Edge Plot (Bluetooth with Hopping Enabled, 3Mbps)

FCC ID: IHDT56PB1		FCC Pt. 15.247 BLUETOOTH TEST REPORT (CERTIFICATION)		Reviewed by: Quality Manager
Test Report S/N: 0Y1304010567.IHD-R1	Test Dates: 04/04 - 04/25/2013	EUT Type: Portable Handset		Page 28 of 46



Plot 6-31. Band Edge Plot (Bluetooth with Hopping Enabled, 3Mbps)

FCC ID: IHDT56PB1		FCC Pt. 15.247 BLUETOOTH TEST REPORT (CERTIFICATION)		Reviewed by: Quality Manager
Test Report S/N: 0Y1304010567.IHD-R1	Test Dates: 04/04 - 04/25/2013	EUT Type: Portable Handset		Page 29 of 46

6.5 Carrier Frequency Separation

§15.247 (a)(1); RSS-210 (A8.1 (2))

Measurement is made with EUT operating in hopping mode. **The minimum permissible channel separation for this system is 2/3 the value of the 20dB BW.**

The EUT complies with the minimum channel separation requirement when it is operating in 1x/EDR mode using 79 channels and when operating in AFH mode using 20 channels.

Frequency [MHz]	Data Rate [Mbps]	Channel No.	Min. Channel Separation [MHz]
2402	1.0	0	0.643
2441	1.0	39	0.636
2480	1.0	78	0.638
2402	2.0	0	0.857
2441	2.0	39	0.856
2480	2.0	78	0.857
2402	3.0	0	0.865
2441	3.0	39	0.857
2480	3.0	78	0.861

Table 6-4. Minimum Channel Separation

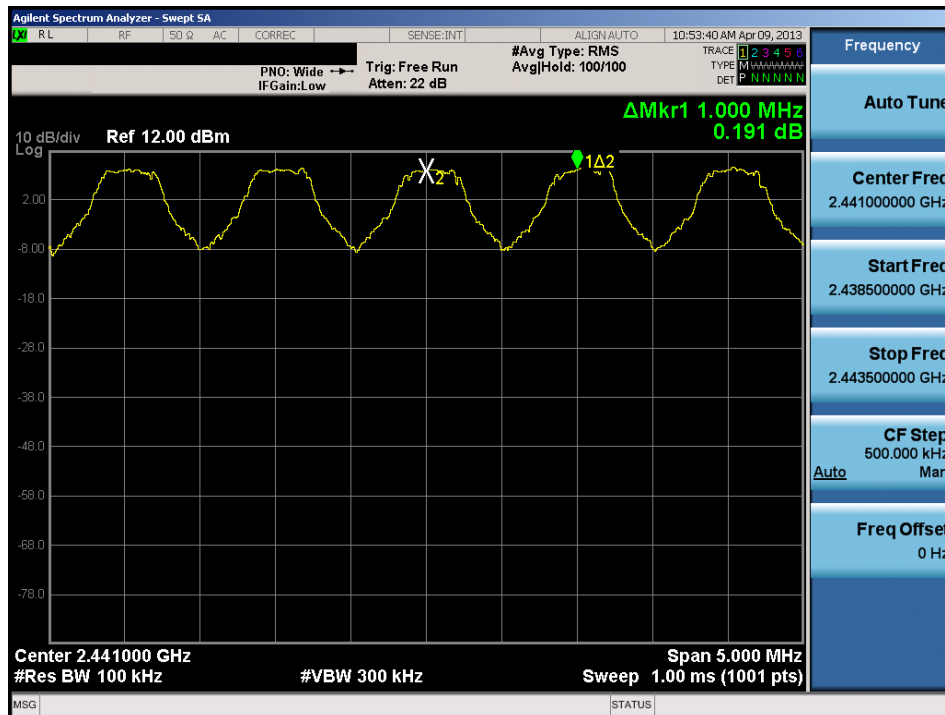

Plot 6-32. Channel Spacing Plot (Bluetooth)

FCC ID: IHDT56PB1		FCC Pt. 15.247 BLUETOOTH TEST REPORT (CERTIFICATION)		Reviewed by: Quality Manager
Test Report S/N: 0Y1304010567.IHD-R1	Test Dates: 04/04 - 04/25/2013	EUT Type: Portable Handset		Page 30 of 46

6.6 Time of Occupancy

§15.247 (a)(1)(iii); RSS-210 (A8.1 (4))

Measurement is made while EUT is operating in hopping mode with the spectrum analyzer set to zero span. **The maximum permissible time of occupancy is 400 ms within a period of 400ms multiplied by the number of hopping channels employed.**

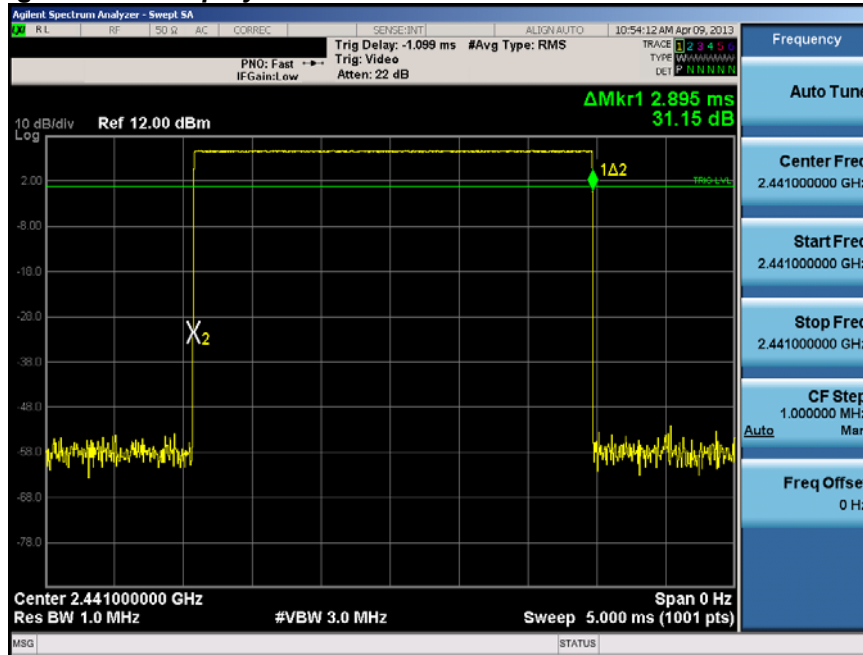

Plot 6-33. Time of Occupancy Plot (Bluetooth)

Bluetooth Time of Occupancy Calculation

Typically, Bluetooth 1x/EDR mode has a channel hopping rate of 1600 hops/s. Since 1x/EDR modes use 5 transmit and 1 receive slot, for a total of 6 slots, the Bluetooth transmitter is actually hopping at a rate of $1600 / 6 = 266.67$ hops/s/slot

- $400\text{ms} \times 79$ hopping channels = 31.6 sec (Time of Occupancy Limit)
- Worst case BT has 266.67 hops/second (for 1x/EDR modes with DH5 operation)
- 266.67 hops/second / 79 channels = 3.38 hops/second (# of hops/second on one channel)
- 3.38 hops/second/channel \times 31.6 seconds = 106.67 hops (# hops over a 31.6 second period)
- 106.67 hops \times 2.895 ms/channel = 308.8ms (worst case dwell time for one channel in 1x/EDR modes)

With AFH, the number of channels is reduced to a minimum of 20 channels and the channel hopping rate is reduced by 50% to 800 hops/s. AFH mode also uses 6 total slots so the Bluetooth transmitter hops at a rate of $800 / 6 = 133.3$ hops/s/slot

- $400\text{ms} \times 20$ hopping channels = 8 sec (Time of Occupancy Limit)
- Worst case BT has 133.3 hops/second/slot (for AFH mode with DH5 operation)
- 133.3 hops/s / 20 channels = 6.67 hops/second (# of hops/second on one channel)
- 6.67 hops/s / channel \times 8 seconds = 53.34 hops (# hops over a 8 second period)
- 53.34 hops \times 2.895 ms/channel = 154.41 ms (worst case dwell time for one channel in AFH mode)

FCC ID: IHDT56PB1		FCC Pt. 15.247 BLUETOOTH TEST REPORT (CERTIFICATION)		Reviewed by: Quality Manager
Test Report S/N: 0Y1304010567.IHD-R1	Test Dates: 04/04 - 04/25/2013	EUT Type: Portable Handset		Page 31 of 46

6.7 Number of Hopping Channels

§15.247 (a)(1)(iii); RSS-210 (A8.1 (4))

Measurement is made while EUT is operating in hopping mode. ***This frequency hopping system must employ a minimum of 15 hopping channels.***

In AFH mode, this device operates using 20 channels so the requirement for minimum number of hopping channels is satisfied.

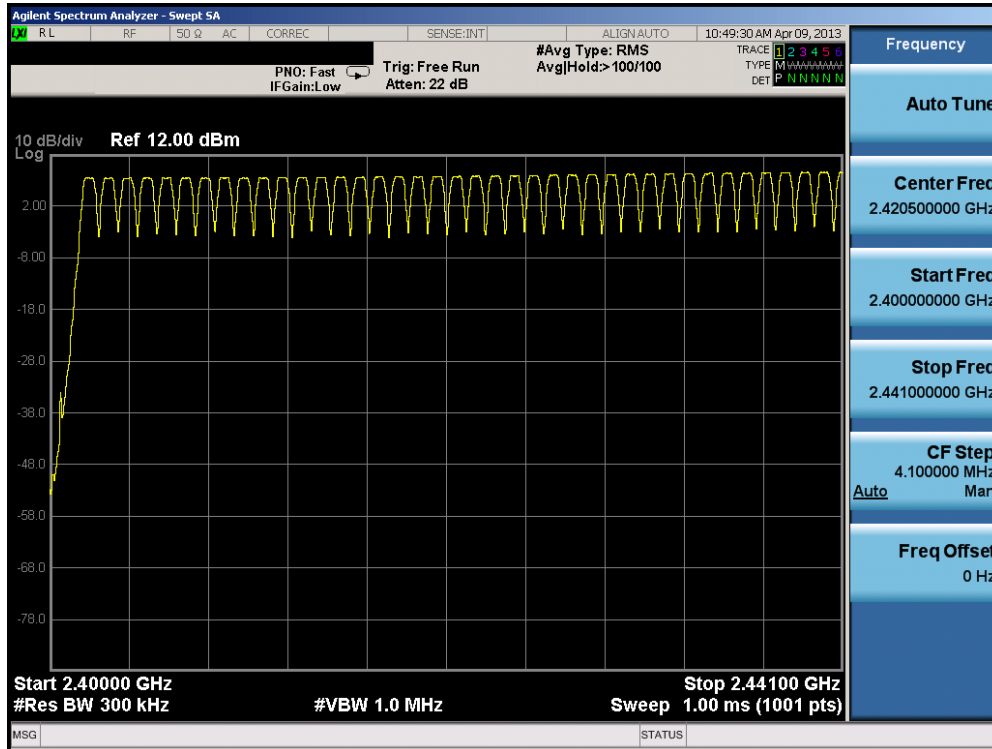

Plot 6-34. Low End Spectrum Channel Hopping Plot (Bluetooth)

FCC ID: IHDT56PB1		FCC Pt. 15.247 BLUETOOTH TEST REPORT (CERTIFICATION)		Reviewed by: Quality Manager
Test Report S/N: 0Y1304010567.IHD-R1	Test Dates: 04/04 - 04/25/2013	EUT Type: Portable Handset		Page 32 of 46

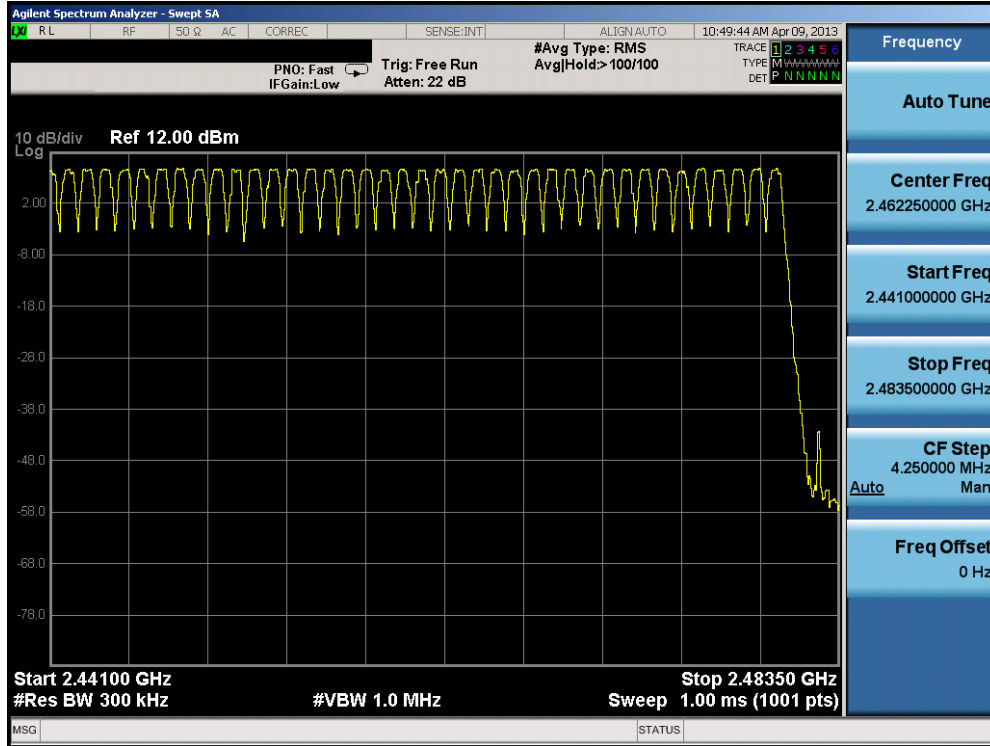

Plot 6-35. High End Spectrum Channel Hopping Plot (Bluetooth)

FCC ID: IHDT56PB1		FCC Pt. 15.247 BLUETOOTH TEST REPORT (CERTIFICATION)	Reviewed by: Quality Manager
Test Report S/N: 0Y1304010567.IHD-R1			

6.8 Conducted Spurious Emissions

\$15.247 (d)

Out of band conducted spurious emissions were investigated for all data rates and the worst case emissions were found with the EUT transmitting at 3Mbps. Plots of the worst case emissions are shown below.

The display line shown in the following plots denotes the limit at 20dB below the fundamental emission level measured in a 100kHz bandwidth. However, since the traces in the following plots are measured with a 1MHz RBW, the display line may not necessarily appear to be 20dB below the level of the fundamental in a 1MHz bandwidth.

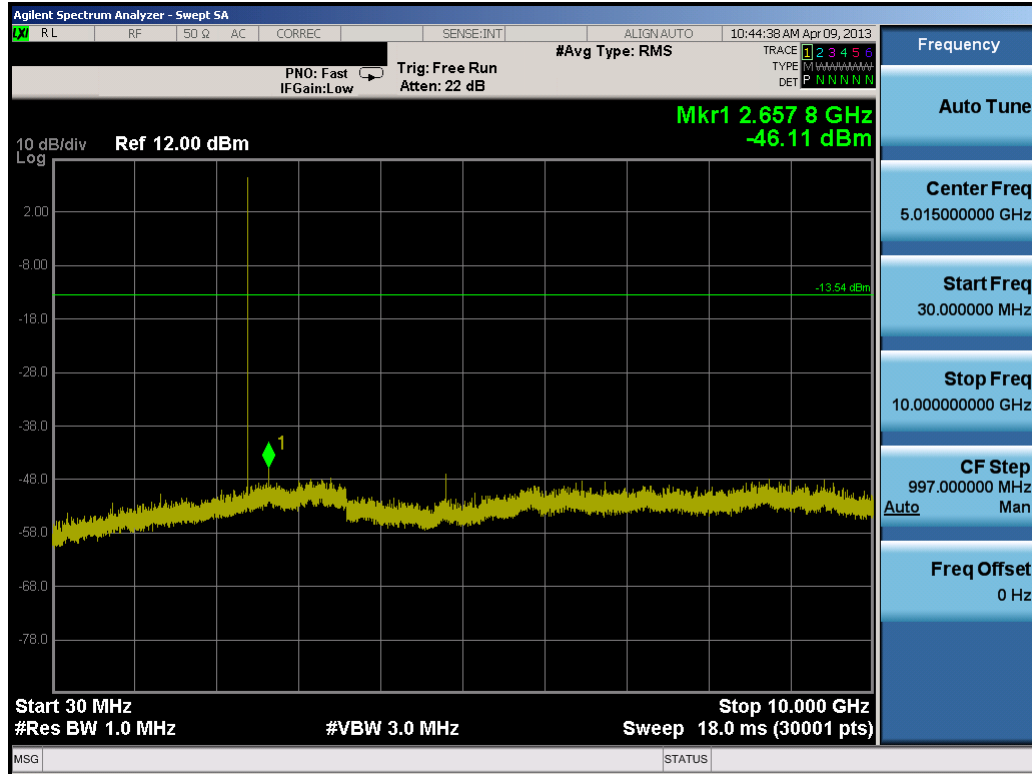

Plot 6-36. Conducted Spurious Plot (Bluetooth, 3Mbps – Ch. 0)

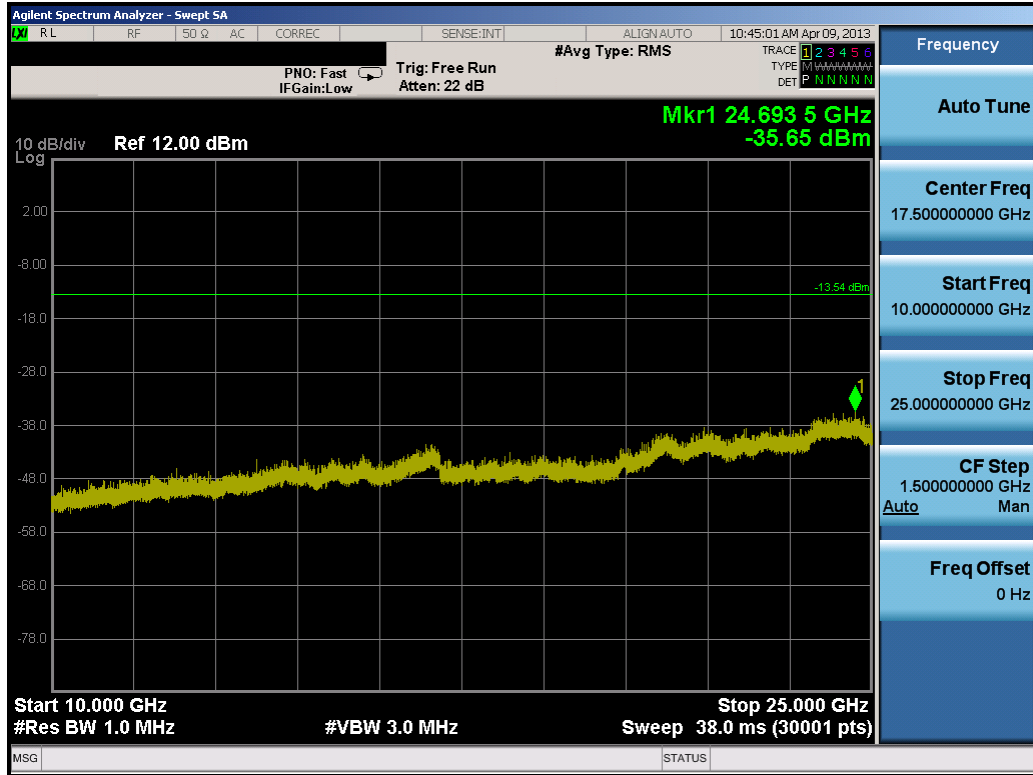

FCC ID: IHDT56PB1		FCC Pt. 15.247 BLUETOOTH TEST REPORT (CERTIFICATION)		Reviewed by: Quality Manager
Test Report S/N: 0Y1304010567.IHD-R1	Test Dates: 04/04 - 04/25/2013	EUT Type: Portable Handset		Page 34 of 46

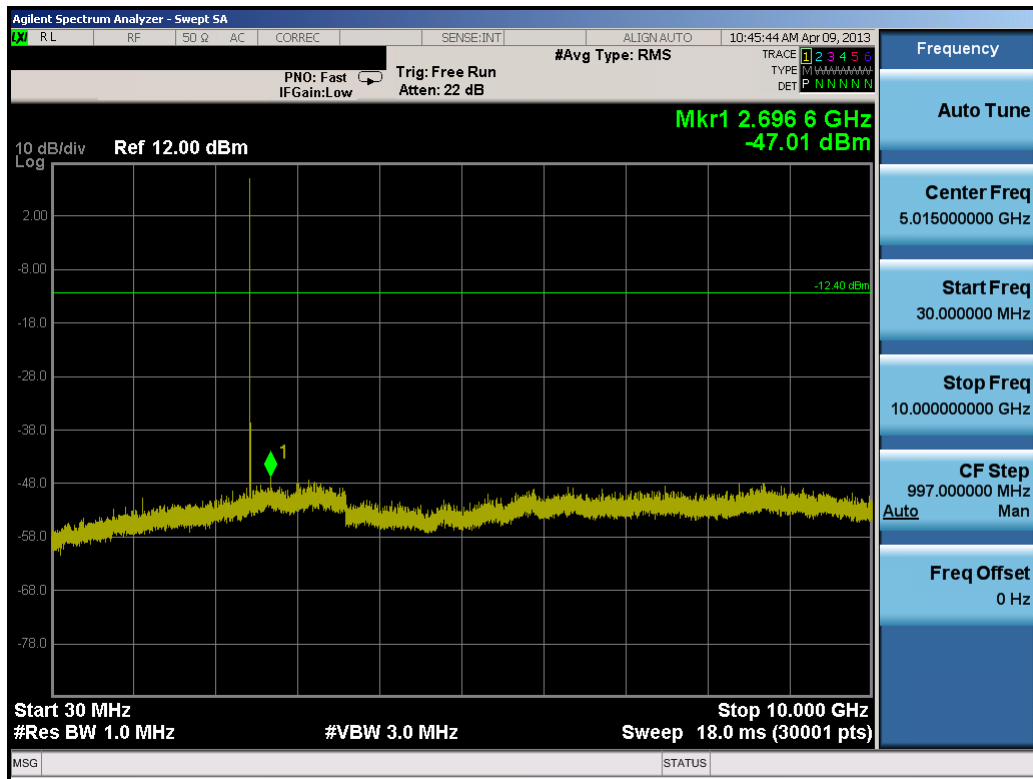

Plot 6-37. Conducted Spurious Plot (Bluetooth, 3Mbps – Ch. 0)



Plot 6-38. Conducted Spurious Plot (Bluetooth, 3Mbps – Ch. 39)

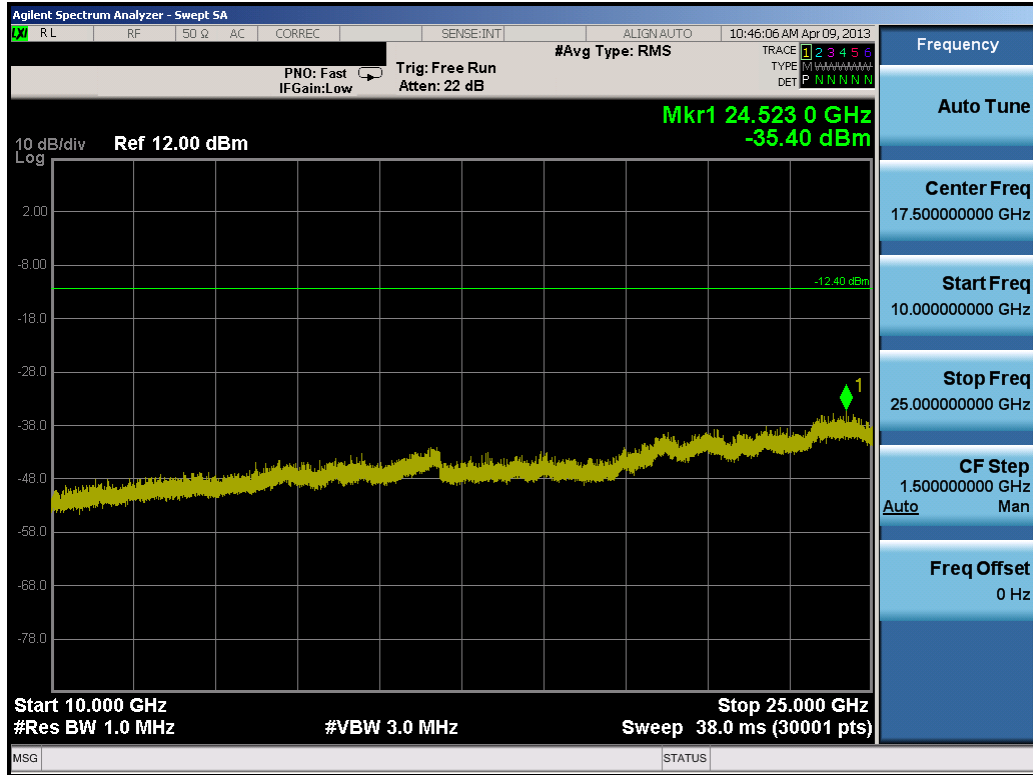

FCC ID: IHDT56PB1		FCC Pt. 15.247 BLUETOOTH TEST REPORT (CERTIFICATION)		Reviewed by: Quality Manager
Test Report S/N: 0Y1304010567.IHD-R1	Test Dates: 04/04 - 04/25/2013	EUT Type: Portable Handset		Page 35 of 46

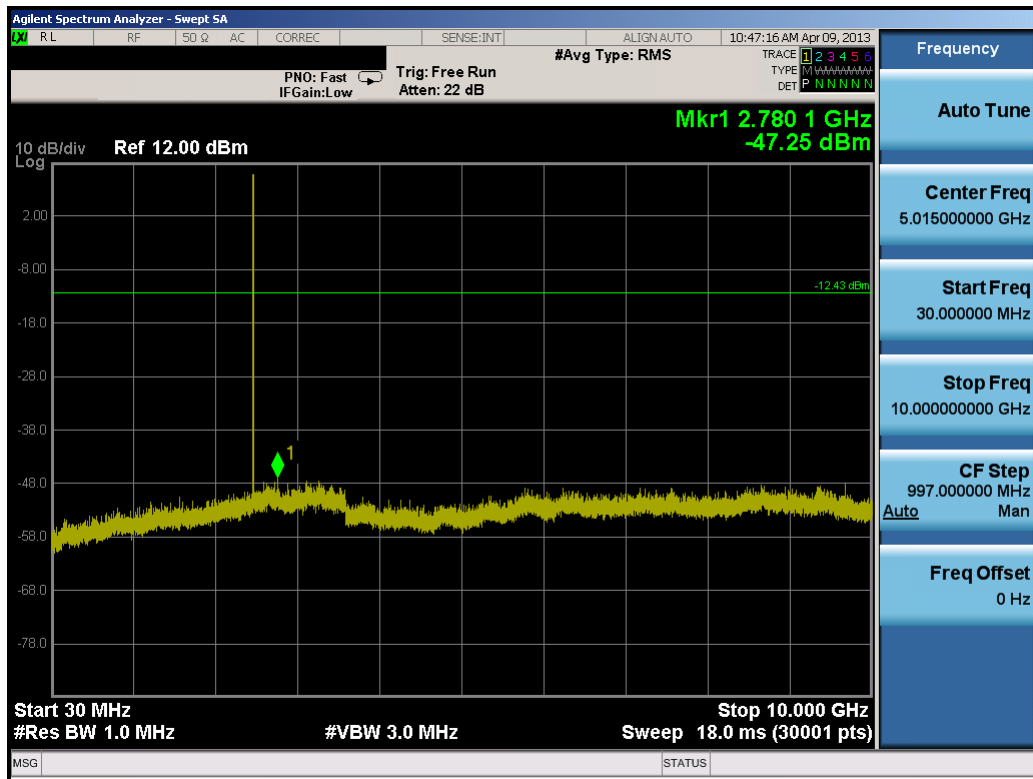

Plot 6-39. Conducted Spurious Plot (Bluetooth, 3Mbps – Ch. 39)



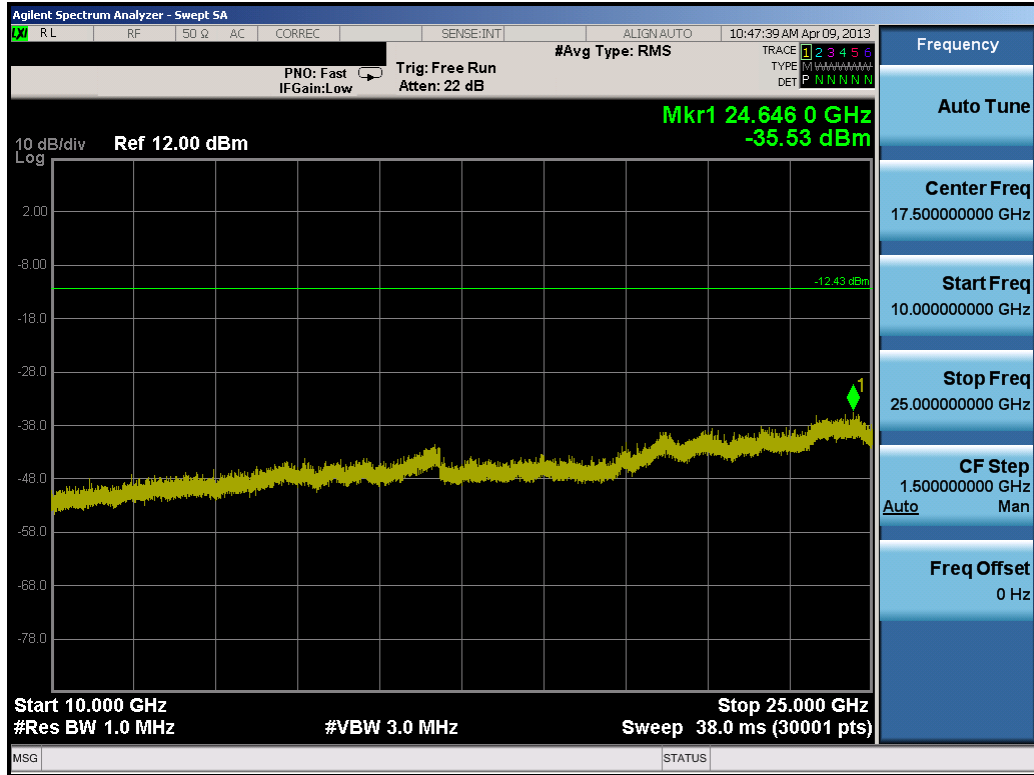

Plot 6-40. Conducted Spurious Plot (Bluetooth, 3Mbps – Ch. 78)

FCC ID: IHDT56PB1		FCC Pt. 15.247 BLUETOOTH TEST REPORT (CERTIFICATION)		Reviewed by: Quality Manager
Test Report S/N: 0Y1304010567.IHD-R1	Test Dates: 04/04 - 04/25/2013	EUT Type: Portable Handset		Page 36 of 46



Plot 6-41. Conducted Spurious Plot (Bluetooth, 3Mbps – Ch. 78)

FCC ID: IHDT56PB1		FCC Pt. 15.247 BLUETOOTH TEST REPORT (CERTIFICATION)		Reviewed by: Quality Manager
Test Report S/N: 0Y1304010567.IHD-R1	Test Dates: 04/04 - 04/25/2013	EUT Type: Portable Handset		Page 37 of 46

6.9 Radiated Spurious Emission Measurements

§15.205 & §15.209, §15.247 (d); RSS-210 (A8.5)

Frequency	Field Strength [$\mu\text{V/m}$]	Measured Distance [Meters]
0.009 – 0.490 MHz	2400/F (kHz)	300
0.490 – 1.705 MHz	24000/F (kHz)	30
1.705 – 30.00 MHz	30	30
30.00 – 88.00 MHz	100	3
88.00 – 216.0 MHz	150	3
216.0 – 960.0 MHz	200	3
Above 960.0 MHz	500	3



Table 6-5. Radiated Limits

Sample Calculation

- Field Strength Level $_{[\text{dB}\mu\text{V/m}]}$ = Analyzer Level $_{[\text{dBm}]}$ + 107 + AFCL $_{[\text{dB/m}]}$ + Duty Cycle Correction $_{[\text{dB}]}$
- AFCL $_{[\text{dB/m}]}$ = Antenna Factor $_{[\text{dB/m}]}$ + Cable Loss $_{[\text{dB}]}$
- Margin $_{[\text{dB}]}$ = Field Strength Level $_{[\text{dB}\mu\text{V/m}]}$ – Limit $_{[\text{dB}\mu\text{V/m}]}$



Duty Cycle Correction Factor Calculation

- Channel hop rate = 800 hops/second (AFH Mode)
- Adjusted channel hop rate for DH5 mode = 133.33 hops/second
- Time per channel hop = $1 / 133.33$ hops/second = 7.5 ms
- Time to cycle through all channels = 7.5×20 channels = 150 ms
- Number of times transmitter hits on one channel = $100 \text{ ms} / 150 \text{ ms} = 1$ time(s)
- Worst case dwell time = 7.5 ms
- Duty cycle correction factor = $20\log_{10}(7.5\text{ms}/100\text{ms}) = -22.5 \text{ dB}$

FCC ID: IHDT56PB1		FCC Pt. 15.247 BLUETOOTH TEST REPORT (CERTIFICATION)		Reviewed by: Quality Manager
Test Report S/N: 0Y1304010567.IHD-R1	Test Dates: 04/04 - 04/25/2013	EUT Type: Portable Handset	Page 38 of 46	

Test Notes

1. All emissions lying in restricted bands specified in §15.205 are below the limit shown in Table 6-5.
2. No significant radiated emissions were found in the 2310 - 2390MHz restricted band.
3. Average measurements > 1GHz using RBW = 1MHz and VBW = 1kHz $\geq 1/\tau$ Hz, where τ = pulse width in seconds. Peak measurements > 1GHz using RBW = 1MHz and VBW = 3MHz. Both average and peak measurements were made using a peak detector.
4. The antenna is manipulated through typical positions, polarity and length during the tests. The EUT is manipulated through three orthogonal planes.
5. The EUT is supplied with nominal AC voltage and/or a new/fully-recharged battery.
6. The spectrum is measured from 9kHz to the 10th harmonic and the worst-case emissions are reported. Emissions whose levels were not within 20dB of the respective limits were not reported.
7. Average levels at -135 dBm and peak levels at -125dBm represent the analyzer noise floor and signify that no emission was detected.

FCC ID: IHDT56PB1	 FCC Pt. 15.247 BLUETOOTH TEST REPORT (CERTIFICATION)		 Reviewed by: Quality Manager
Test Report S/N: 0Y1304010567.IHD-R1	Test Dates: 04/04 - 04/25/2013	EUT Type: Portable Handset	Page 39 of 46

Radiated Spurious Emission Measurements (Cont'd)

§15.205 & §15.209, §15.247 (d); RSS-210 (A8.5)

Worst Case Mode: Bluetooth
 Worst Case Data Rate: 3Mbps
 Measurement Distance: 3 Meters
 Operating Frequency: 2402MHz
 Channel: 0



Frequency [MHz]	Analyzer Level [dBm]	Detector	PoI [H/V]	AFCL [dB]	Duty Cycle Correction [dB]	Field Strength [dB μ V/m]	Limit [dB μ V/m]	Margin [dB]
4804.00	-110.45	Avg	H	41.22	-22.50	15.27	53.98	-38.71
4804.00	-101.28	Peak	H	41.22	0.00	46.94	73.98	-27.04
12010.00	-135.00	Avg	H	52.26	0.00	24.26	53.98	-29.72
12010.00	-125.00	Peak	H	52.26	0.00	34.26	73.98	-39.72

Table 6-6. Radiated Measurements

Worst Case Mode: Bluetooth
 Worst Case Data Rate: 3Mbps
 Measurement Distance: 3 Meters
 Operating Frequency: 2441MHz
 Channel: 39

Frequency [MHz]	Analyzer Level [dBm]	Detector	PoI [H/V]	AFCL [dB]	Duty Cycle Correction [dB]	Field Strength [dB μ V/m]	Limit [dB μ V/m]	Margin [dB]
4882.00	-110.79	Avg	H	41.20	-22.50	14.91	53.98	-39.07
4882.00	-100.56	Peak	H	41.20	0.00	47.63	73.98	-26.35
7323.00	-116.74	Avg	H	44.85	-22.50	12.62	53.98	-41.36
7323.00	-103.24	Peak	H	44.85	0.00	48.62	73.98	-25.36
12205.00	-135.00	Avg	H	52.54	0.00	24.54	53.98	-29.44
12205.00	-125.00	Peak	H	52.54	0.00	34.54	73.98	-39.44

Table 6-7. Radiated Measurements



FCC ID: IHDT56PB1		FCC Pt. 15.247 BLUETOOTH TEST REPORT (CERTIFICATION)		Reviewed by: Quality Manager
Test Report S/N: 0Y1304010567.IHD-R1	Test Dates: 04/04 - 04/25/2013	EUT Type: Portable Handset		Page 40 of 46

Radiated Spurious Emission Measurements (Cont'd)
§15.205 & §15.209, §15.247 (d); RSS-210 (A8.5)

Worst Case Mode: Bluetooth
 Worst Case Data Rate: 3Mbps
 Measurement Distance: 3 Meters
 Operating Frequency: 2480MHz
 Channel: 78

Frequency [MHz]	Analyzer Level [dBm]	Detector	Pol [H/V]	AFCL [dB]	Duty Cycle Correction [dB]	Field Strength [dB μ V/m]	Limit [dB μ V/m]	Margin [dB]
4960.00	-113.35	Avg	H	41.17	-22.50	12.32	53.98	-41.66
4960.00	-102.03	Peak	H	41.17	0.00	46.14	73.98	-27.84
7440.00	-117.20	Avg	H	45.11	-22.50	12.41	53.98	-41.57
7440.00	-103.07	Peak	H	45.11	0.00	49.04	73.98	-24.94
12400.00	-135.00	Avg	H	52.81	0.00	24.81	53.98	-29.17
12400.00	-125.00	Peak	H	52.81	0.00	34.81	73.98	-39.17

Table 6-8. Radiated Measurements

FCC ID: IHDT56PB1		FCC Pt. 15.247 BLUETOOTH TEST REPORT (CERTIFICATION)		Reviewed by: Quality Manager
Test Report S/N: 0Y1304010567.IHD-R1	Test Dates: 04/04 - 04/25/2013	EUT Type: Portable Handset	Page 41 of 46	

6.10 Radiated Restricted Band Edge Measurements

\$15.205 & \$15.209, \$15.247 (d); RSS-210 (A8.5)

The radiated restricted band edge measurements are measured with an EMI test receiver connected to the receive antenna while the EUT is transmitting. Two different amplitude offsets were used depending on whether peak or average measurements were measured. The average measurements use a duty cycle correction factor (DCCF).

The amplitude offset shown in the following plots for average measurements was calculated using the formula:

$$\text{Offset (dB)} = (\text{Antenna Factor} + \text{Cable Loss} + 10 \text{ dB Attenuator}) - \text{Preamplifier Gain} + \text{DCCF}$$

Worst Case Mode: Bluetooth

Worst Case Data Rate: 3Mbps

Measurement Distance: 3 Meters

Operating Frequency: 2480MHz

Channel: 78

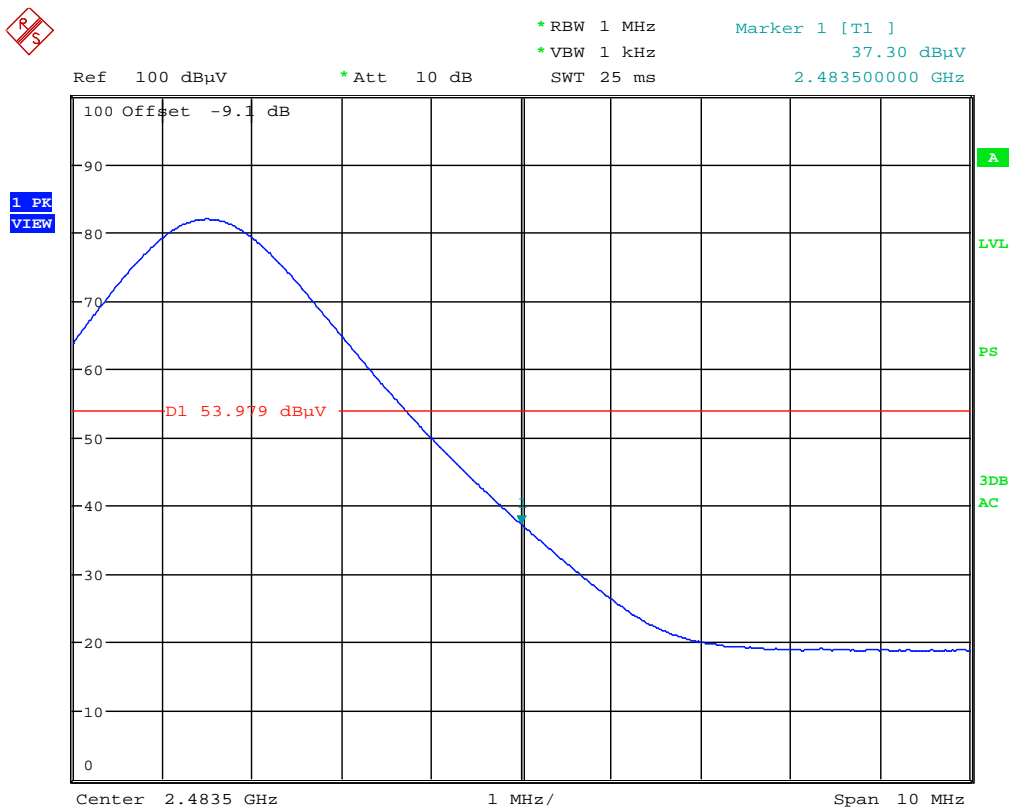

Date: 25.APR.2013 15:12:13

Plot 6-42. Radiated Restricted Upper Band Edge Measurement (Average)

FCC ID: IHDT56PB1			FCC Pt. 15.247 BLUETOOTH TEST REPORT (CERTIFICATION)		Reviewed by: Quality Manager
Test Report S/N: 0Y1304010567.IHD-R1	Test Dates: 04/04 - 04/25/2013	EUT Type: Portable Handset			

Radiated Restricted Band Edge Measurements (Cont'd)

§15.205 & §15.209, §15.247 (d); RSS-210 (A8.5)

The amplitude offset shown in the following plots for peak measurements was calculated using the formula:

$$\text{Offset (dB)} = (\text{Antenna Factor} + \text{Cable Loss} + 10 \text{ dB Attenuator}) - \text{Pre-amplifier Gain}$$

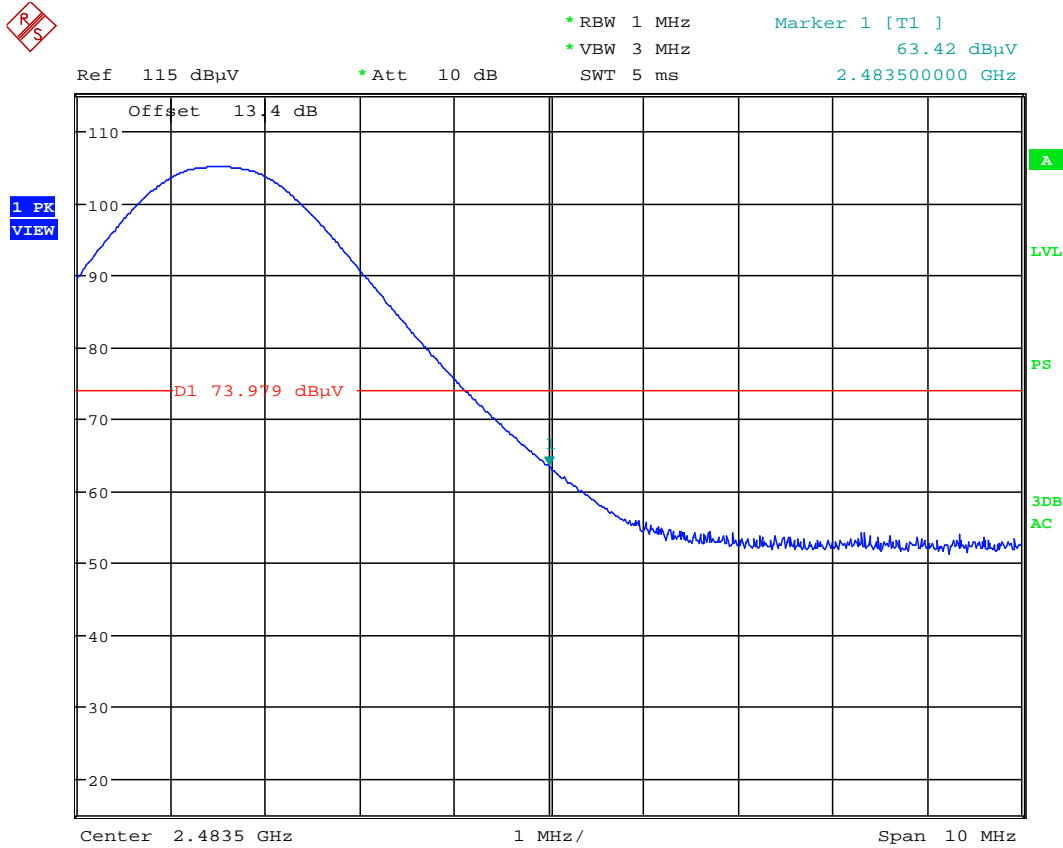

Date: 25.APR.2013 15:13:20

Plot 6-43. Radiated Restricted Upper Band Edge Measurement (Peak)

FCC ID: IHDT56PB1		FCC Pt. 15.247 BLUETOOTH TEST REPORT (CERTIFICATION)		Reviewed by: Quality Manager
Test Report S/N: 0Y1304010567.IHD-R1	Test Dates: 04/04 - 04/25/2013	EUT Type: Portable Handset		Page 43 of 46

6.11 Line Conducted Measurement Data

§15.207; RSS-Gen (7.2.2)

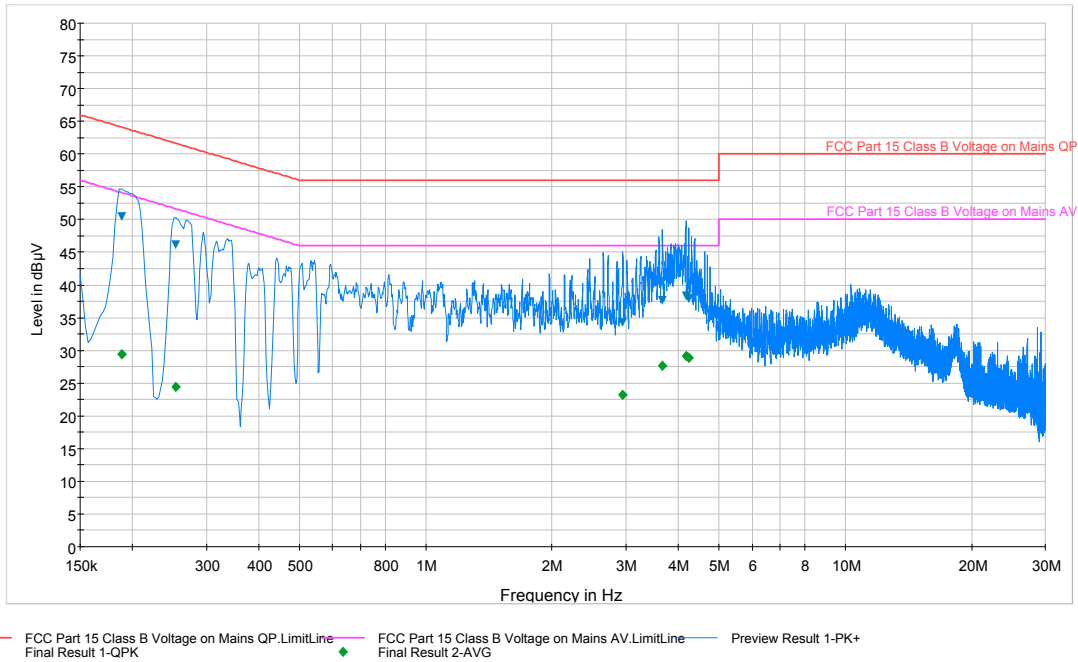

Plot 6-44. Line-Conducted Test Plot (L1)

Frequency MHz	Line	Corr. dB	QuasiPeak dBµV	Limit dBµV	Margin dB	Average dBµV	Limit dBµV	Margin dB
0.188	L1	0.2	50.40	64.10	13.70	29.50	54.10	24.60
0.254	L1	0.1	46.10	61.60	15.50	24.40	51.60	27.20
2.951	L1	0.2	34.30	56.00	21.70	23.20	46.00	22.80
3.669	L1	0.2	37.60	56.00	18.40	27.60	46.00	18.40
4.171	L1	0.2	38.40	56.00	17.60	29.20	46.00	16.80
4.238	L1	0.2	37.90	56.00	18.10	28.90	46.00	17.10

Table 6-9. Line-Conducted Test Data (L1)

Notes:

- All Modes of operation were investigated and the worst-case emissions are reported.
- The limit for an intentional radiator from 150kHz to 30MHz are specified in Section 15.207 of the Title 47 CFR.
- Corr. (dB) = Cable loss (dB) + LISN insertion factor (dB)
- QP/AV Level (dBµV) = QP/AV Analyzer/Receiver Level (dBµV) + Corr. (dB)
- Margin (dB) = QP/AV Limit (dBµV) - QP/AV Level (dBµV)
- Traces shown in plot are made using a peak detector.
- Deviations to the Specifications: None.

FCC ID: IHDT56PB1		FCC Pt. 15.247 BLUETOOTH TEST REPORT (CERTIFICATION)			Reviewed by: Quality Manager
Test Report S/N: 0Y1304010567.IHD-R1	Test Dates: 04/04 - 04/25/2013	EUT Type: Portable Handset			Page 44 of 46

Line Conducted Measurement Data (Cont'd)

§15.207; RSS-Gen (7.2.2)

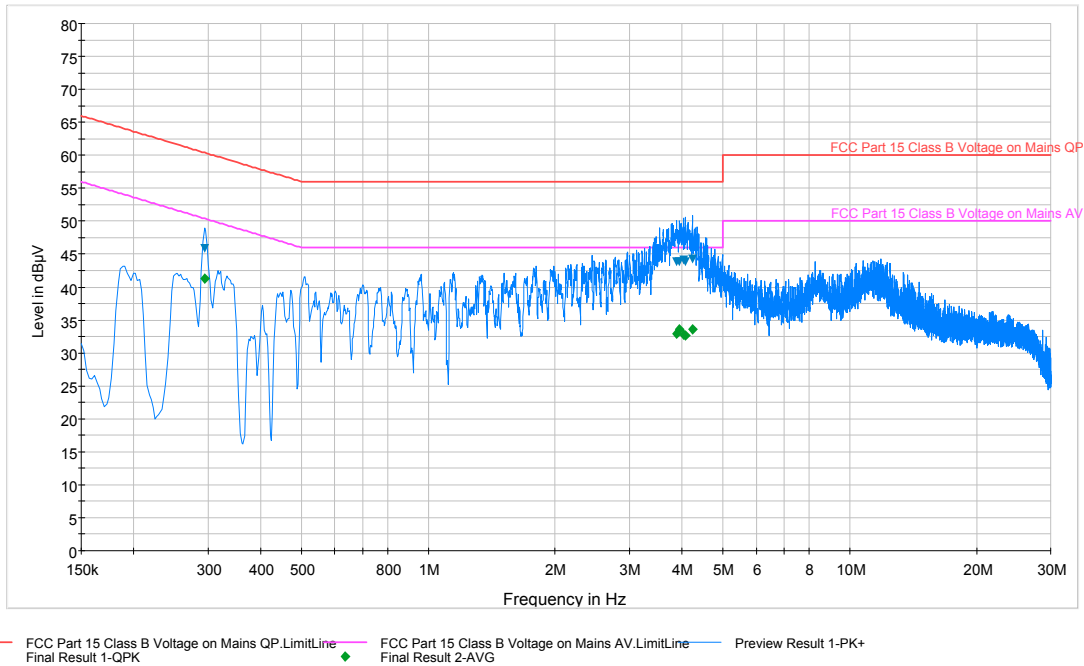

Plot 6-45. Line-Conducted Test Plot (N)

Frequency MHz	Line	Corr. dB	QuasiPeak dBµV	Limit dBµV	Margin dB	Average dBµV	Limit dBµV	Margin dB
0.294	N	0.2	45.80	60.40	14.60	41.30	50.40	9.10
3.881	N	0.2	43.80	56.00	12.20	32.90	46.00	13.10
3.948	N	0.2	43.80	56.00	12.20	33.60	46.00	12.40
4.038	N	0.2	44.20	56.00	11.80	32.80	46.00	13.20
4.079	N	0.2	43.80	56.00	12.20	32.70	46.00	13.30
4.232	N	0.2	44.30	56.00	11.70	33.60	46.00	12.40

Table 6-10. Line-Conducted Test Data (N)



Notes:

- All Modes of operation were investigated and the worst-case emissions are reported.
- The limit for an intentional radiator from 150kHz to 30MHz are specified in Section 15.207 of the Title 47 CFR.
- Corr. (dB) = Cable loss (dB) + LISN insertion factor (dB)
- QP/AV Level (dBµV) = QP/AV Analyzer/Receiver Level (dBµV) + Corr. (dB)
- Margin (dB) = QP/AV Limit (dBµV) - QP/AV Level (dBµV)
- Traces shown in plot are made using a peak detector.
- Deviations to the Specifications: None.

FCC ID: IHDT56PB1		FCC Pt. 15.247 BLUETOOTH TEST REPORT (CERTIFICATION)			Reviewed by: Quality Manager
Test Report S/N: 0Y1304010567.IHD-R1	Test Dates: 04/04 - 04/25/2013	EUT Type: Portable Handset		Page 45 of 46	

7.0 CONCLUSION

The data collected relate only to the item(s) tested and show that the **Motorola Portable Handset FCC ID: IHDT56PB1** is in compliance with Part 15 Subpart C (15.247) of the FCC Rules.

FCC ID: IHDT56PB1		FCC Pt. 15.247 BLUETOOTH TEST REPORT (CERTIFICATION)	 Reviewed by: Quality Manager
Test Report S/N: 0Y1304010567.IHD-R1	Test Dates: 04/04 - 04/25/2013	EUT Type: Portable Handset	Page 46 of 46