

Appendix 1

SAR distribution comparisons for System Accuracy Verifications

System Accuracy Verification Measurements for Head SAR Measurements

Date/Time: 7/2/2012 11:06:52 AM

Test Laboratory: Motorola - 835MHz Head

DUT: Dipole 835 MHz; Serial: D835V2 - SN:425tr; FCC ID:IHDT56NS8

Procedure Notes: 835 MHz System Performance Check; Dipole Sn# 425TR; PM1 Power =200 mW
Sim.Temp@meas =19.3 Sim.Temp@SPC = 19.5 Room Temp @ SPC = 21.2

Communication System: _CW - Dipole; Frequency: 835 MHz;

Communication System Channel Number: 3; Duty Cycle: 1:1

Medium: Validation *HEAD Tissue* ;

Medium parameters used: $f = 835 \text{ MHz}$; $\sigma = 0.93 \text{ mho/m}$; $\epsilon_r = 41.2$; $\rho = 1000 \text{ kg/m}^3$

DASY4 Configuration:

- Probe: ES3DV3 - SN3180; ConvF(6.07, 6.07, 6.07); Calibrated: 1/11/2012
- Sensor-Surface: 4mm (Mechanical Surface Detection)
- Electronics: DAE4 Sn1313; Calibrated: 1/20/2012
- Phantom: R12_ Sugar SAM (extended range), Rev.2 (24-Feb-12); Type: SAM v4.0; Serial: TP-1154;
- ; SEMCAD X Version 14.6.4 (4989)

DASY5, SAM - System Performance Check Template, Rev.2 (12-Sept-11)/Daily SPC Check/Z-Axis Retraction (1x1x31):

Measurement grid: dx=20mm, dy=20mm, dz=5mm

Maximum value of SAR (measured) = 2.173 mW/g

DASY5, SAM - System Performance Check Template, Rev.2 (12-Sept-11)/Daily SPC Check/Dipole Area Scan (5x15x1):

Measurement grid: dx=10mm, dy=15mm

Maximum value of SAR (measured) = 2.160 mW/g

DASY5, SAM - System Performance Check Template, Rev.2 (12-Sept-11)/Daily SPC Check/0-Degree, 5x5x7 Cube (5x5x7)/Cube 0:

Measurement grid: dx=8mm, dy=8mm, dz=5mm

Reference Value = 49.116 V/m; Power Drift = -0.03 dB

Peak SAR (extrapolated) = 2.9270

SAR(1 g) = 2 mW/g; SAR(10 g) = 1.31 mW/g

Maximum value of SAR (measured) = 2.163 mW/g

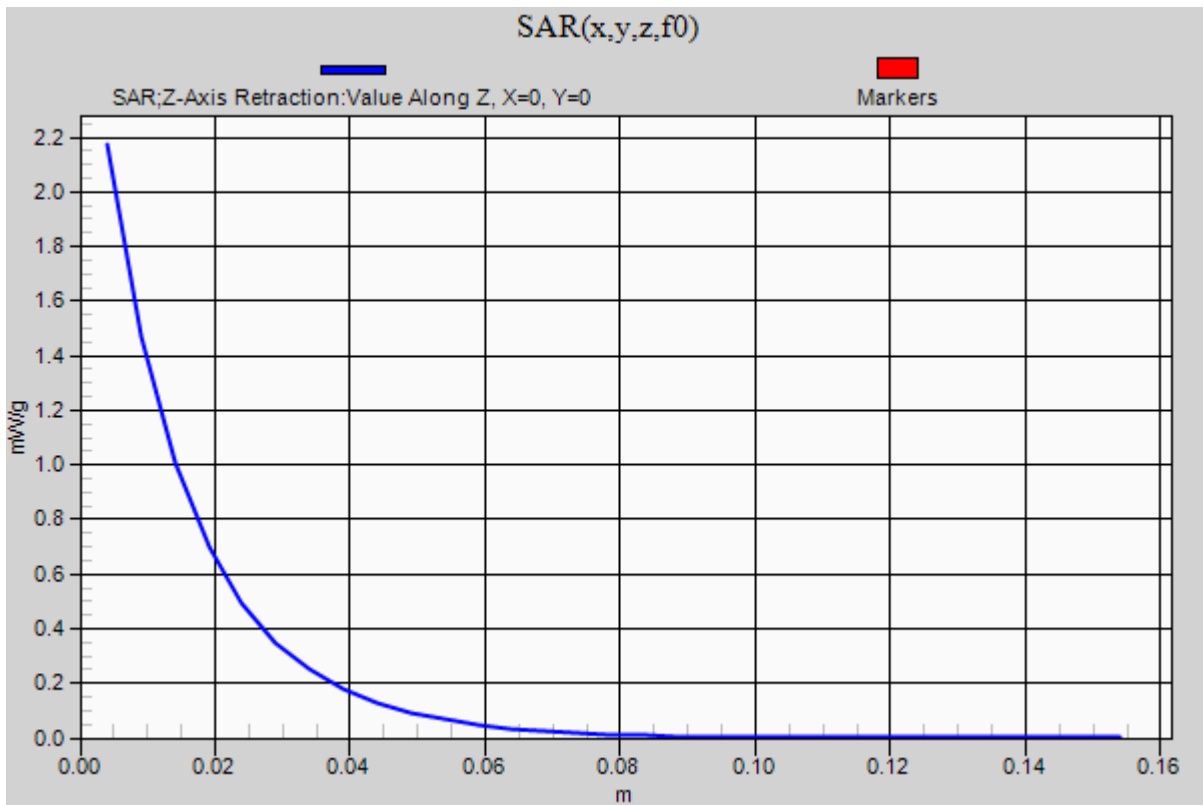
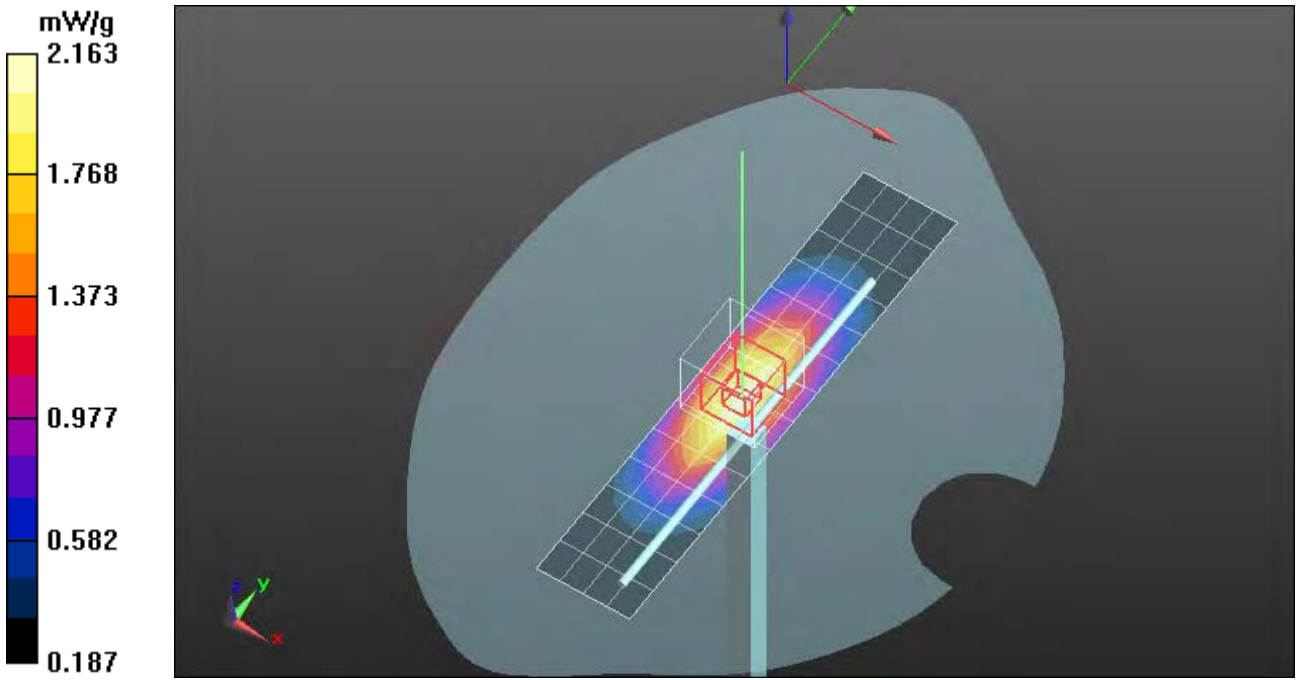

Date/Time: 7/3/2012 9:41:39 AM

Test Laboratory: Motorola - 835MHz Head

DUT: Dipole 835MHz; Serial: D835V2 - SN:425tr; FCC ID:IHDT56NS8

Procedure Notes: 835 MHz System Performance Check; Dipole Sn# 425TR; PM1 Power =200 mW
Sim.Temp@meas =19.1 Sim.Temp@SPC = 19.9 Room Temp @ SPC = 21.4

Communication System: _CW - Dipole; Frequency: 835 MHz;

Communication System Channel Number: 3; Duty Cycle: 1:1

Medium: Validation *HEAD Tissue* ;

Medium parameters used: $f = 835 \text{ MHz}$; $\sigma = 0.93 \text{ mho/m}$; $\epsilon_r = 41.3$; $\rho = 1000 \text{ kg/m}^3$

DASY4 Configuration:

- Probe: ES3DV3 - SN3180; ConvF(6.07, 6.07, 6.07); Calibrated: 1/11/2012
- Sensor-Surface: 4mm (Mechanical Surface Detection)
- Electronics: DAE4 Sn1313; Calibrated: 1/20/2012
- Phantom: R12_ Sugar SAM (extended range), Rev.2 (24-Feb-12); Type: SAM v4.0; Serial: TP-1154;
- ; SEMCAD X Version 14.6.4 (4989)

DASY5, SAM - System Performance Check Template, Rev.2 (12-Sept-11)/Daily SPC Check/Z-Axis Retraction (1x1x31):

Measurement grid: dx=20mm, dy=20mm, dz=5mm

Maximum value of SAR (measured) = 2.162 mW/g

DASY5, SAM - System Performance Check Template, Rev.2 (12-Sept-11)/Daily SPC Check/Dipole Area Scan (5x15x1):

Measurement grid: dx=10mm, dy=15mm

DASY5, SAM - System Performance Check Template, Rev.2 (12-Sept-11)/Daily SPC Check/0-Degree, 5x5x7 Cube (5x5x7)/Cube 0:

Measurement grid: dx=8mm, dy=8mm, dz=5mm

Reference Value = 48.988 V/m; Power Drift = -0.0093 dB

Peak SAR (extrapolated) = 2.9270

SAR(1 g) = 1.99 mW/g; SAR(10 g) = 1.3 mW/g

Maximum value of SAR (measured) = 2.151 mW/g

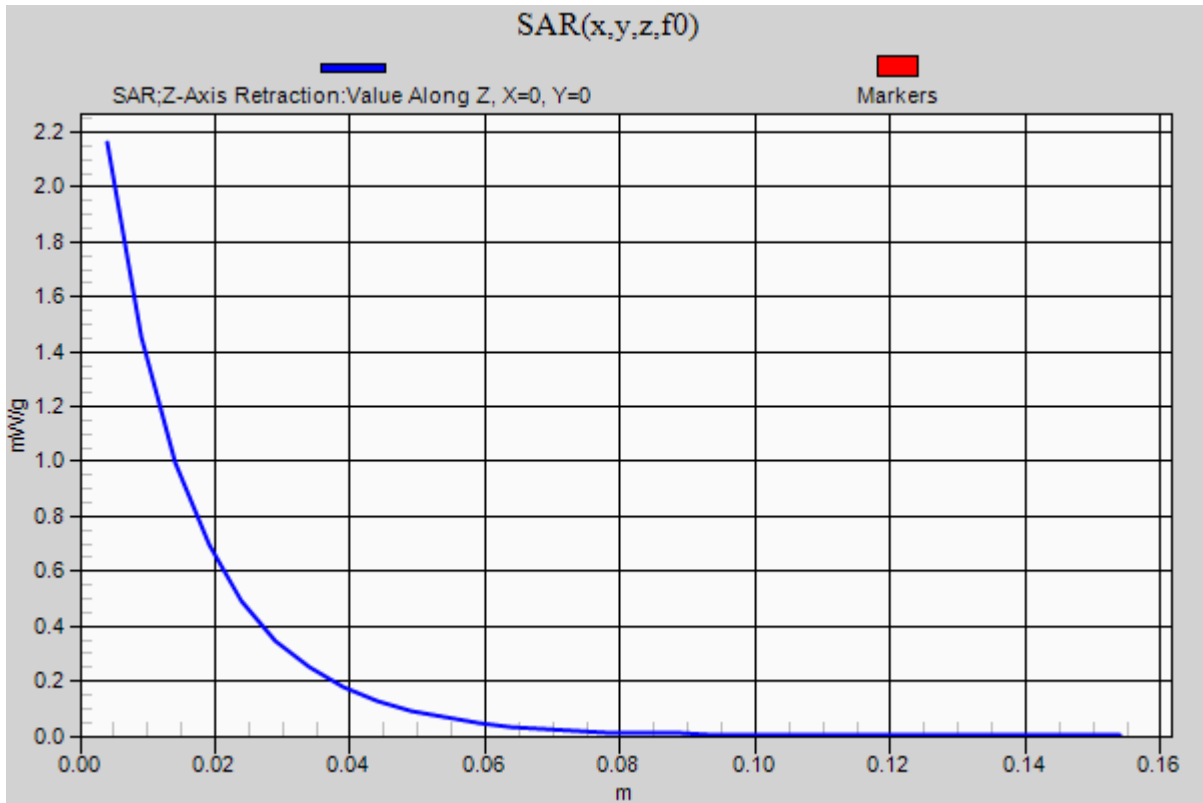
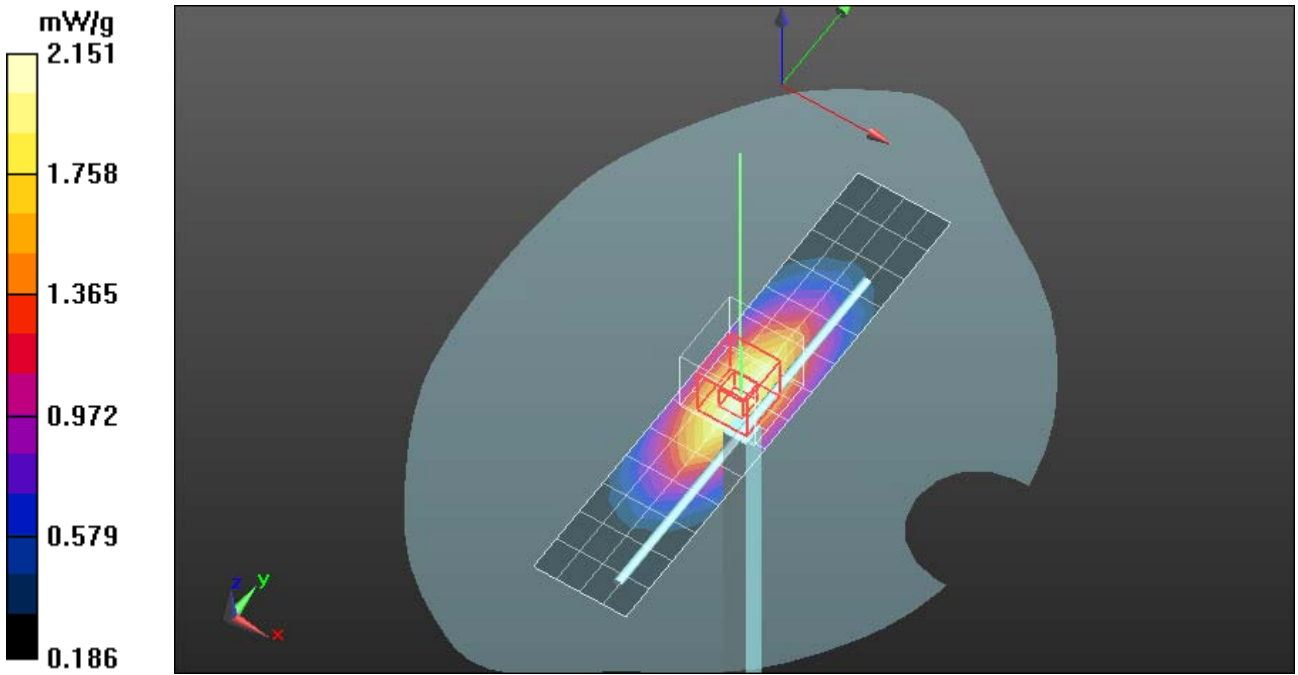

Date/Time: 6/29/2012 12:48:02 PM

Test Laboratory: Motorola - 835MHz Head

DUT: Dipole 835 MHz; Serial: D835V2 - SN:425tr; FCC ID:IHDT56NS8

Procedure Notes: 835 MHz System Performance Check; Dipole Sn# 425TR; PM1 Power =200 mW
Sim.Temp@meas =19.6; Sim.Temp@SPC = 19.8; Room Temp @ SPC = 20.6

Communication System: _CW - Dipole; Frequency: 835 MHz;

Communication System Channel Number: 3; Duty Cycle: 1:1

Medium: Validation *HEAD Tissue* ;

Medium parameters used: $f = 835 \text{ MHz}$; $\sigma = 0.93 \text{ mho/m}$; $\epsilon_r = 41.4$; $\rho = 1000 \text{ kg/m}^3$

DASY4 Configuration:

- Probe: ES3DV3 - SN3180; ConvF(6.07, 6.07, 6.07); Calibrated: 1/11/2012
- Sensor-Surface: 4mm (Mechanical Surface Detection)
- Electronics: DAE4 Sn1313; Calibrated: 1/20/2012
- Phantom: R12_ Sugar SAM (extended range), Rev.2 (24-Feb-12); Type: SAM v4.0; Serial: TP-1154;
- ; SEMCAD X Version 14.6.4 (4989)

DASY5, SAM - System Performance Check Template, Rev.2 (12-Sept-11)/Daily SPC Check/Z-Axis Retraction (1x1x31):

Measurement grid: dx=20mm, dy=20mm, dz=5mm

Maximum value of SAR (measured) = 2.147 mW/g

DASY5, SAM - System Performance Check Template, Rev.2 (12-Sept-11)/Daily SPC Check/Dipole Area Scan (5x15x1):

Measurement grid: dx=10mm, dy=15mm

Maximum value of SAR (measured) = 2.133 mW/g

DASY5, SAM - System Performance Check Template, Rev.2 (12-Sept-11)/Daily SPC Check/0-Degree, 5x5x7 Cube (5x5x7)/Cube 0:

Measurement grid: dx=8mm, dy=8mm, dz=5mm

Reference Value = 48.669 V/m; Power Drift = -0.01 dB

Peak SAR (extrapolated) = 2.9040

SAR(1 g) = 1.98 mW/g; SAR(10 g) = 1.3 mW/g

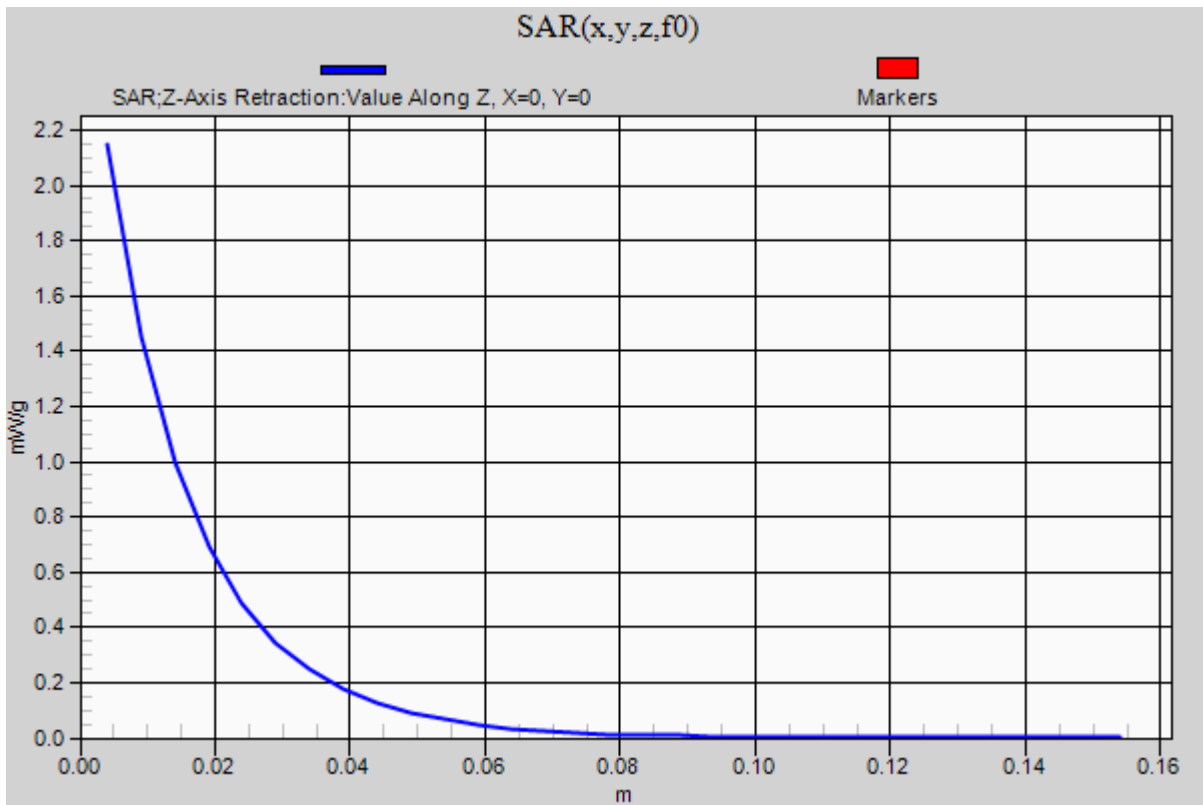
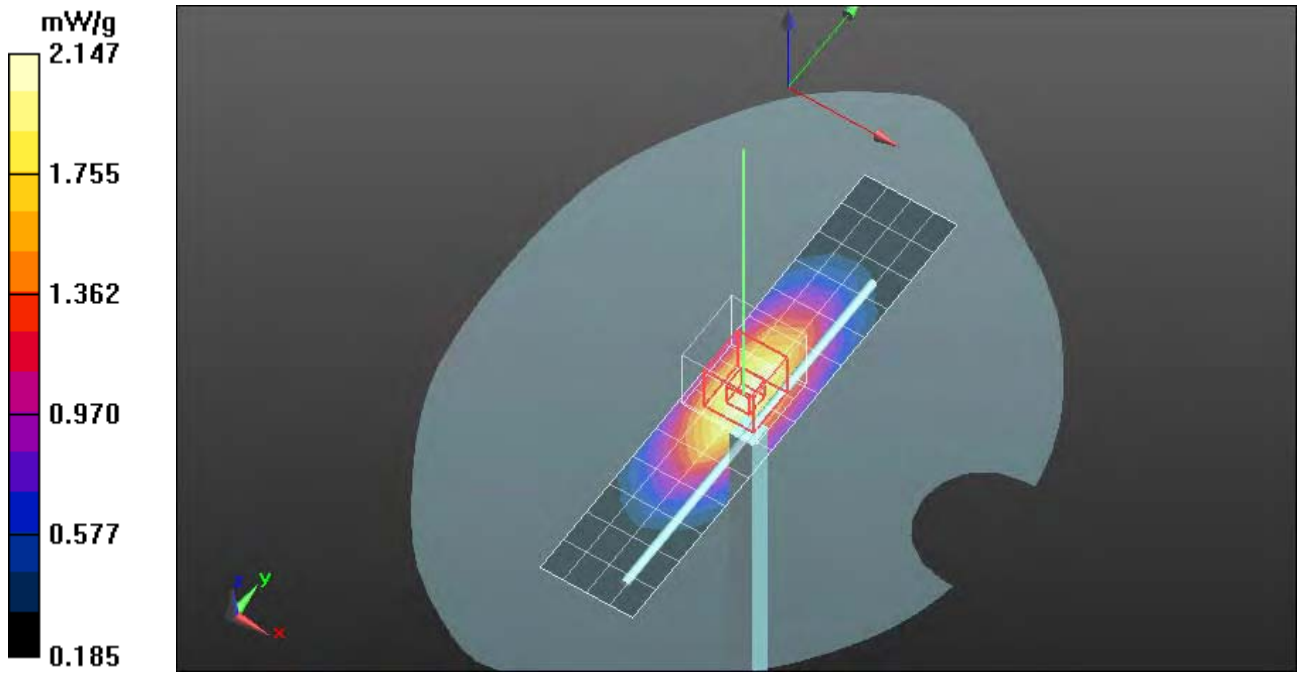

Date/Time: 7/4/2012 9:37:40 AM

Test Laboratory: Motorola - 835MHz Head

DUT: Dipole 835 MHz; Serial: D835V2 - SN:425tr; FCC ID:IHDT56NS8

Procedure Notes: 835 MHz System Performance Check; Dipole Sn# 425TR; PM1 Power =200 mW
Sim.Temp@meas =19.4 Sim.Temp@SPC = 19.9 Room Temp @ SPC = 20.9

Communication System: _CW - Dipole; Frequency: 835 MHz;

Communication System Channel Number: 3; Duty Cycle: 1:1

Medium: Validation *HEAD Tissue* ;

Medium parameters used: $f = 835 \text{ MHz}$; $\sigma = 0.92 \text{ mho/m}$; $\epsilon_r = 40.5$; $\rho = 1000 \text{ kg/m}^3$

DASY4 Configuration:

- Probe: ES3DV3 - SN3180; ConvF(6.07, 6.07, 6.07); Calibrated: 1/11/2012
- Sensor-Surface: 4mm (Mechanical Surface Detection)
- Electronics: DAE4 Sn1313; Calibrated: 1/20/2012
- Phantom: R12_ Sugar SAM (extended range), Rev.2 (24-Feb-12); Type: SAM v4.0; Serial: TP-1154;
- ; SEMCAD X Version 14.6.4 (4989)

DASY5, SAM - System Performance Check Template, Rev.2 (12-Sept-11)/Daily SPC Check/Z-Axis Retraction (1x1x31):

Measurement grid: dx=20mm, dy=20mm, dz=5mm

Maximum value of SAR (measured) = 2.132 mW/g

DASY5, SAM - System Performance Check Template, Rev.2 (12-Sept-11)/Daily SPC Check/Dipole Area Scan (5x15x1):

Measurement grid: dx=10mm, dy=15mm

Maximum value of SAR (measured) = 2.130 mW/g

DASY5, SAM - System Performance Check Template, Rev.2 (12-Sept-11)/Daily SPC Check/0-Degree, 5x5x7 Cube (5x5x7)/Cube 0:

Measurement grid: dx=8mm, dy=8mm, dz=5mm

Reference Value = 49.012 V/m; Power Drift = -0.01 dB

Peak SAR (extrapolated) = 2.9030

SAR(1 g) = 1.97 mW/g; SAR(10 g) = 1.29 mW/g

Maximum value of SAR (measured) = 2.135 mW/g

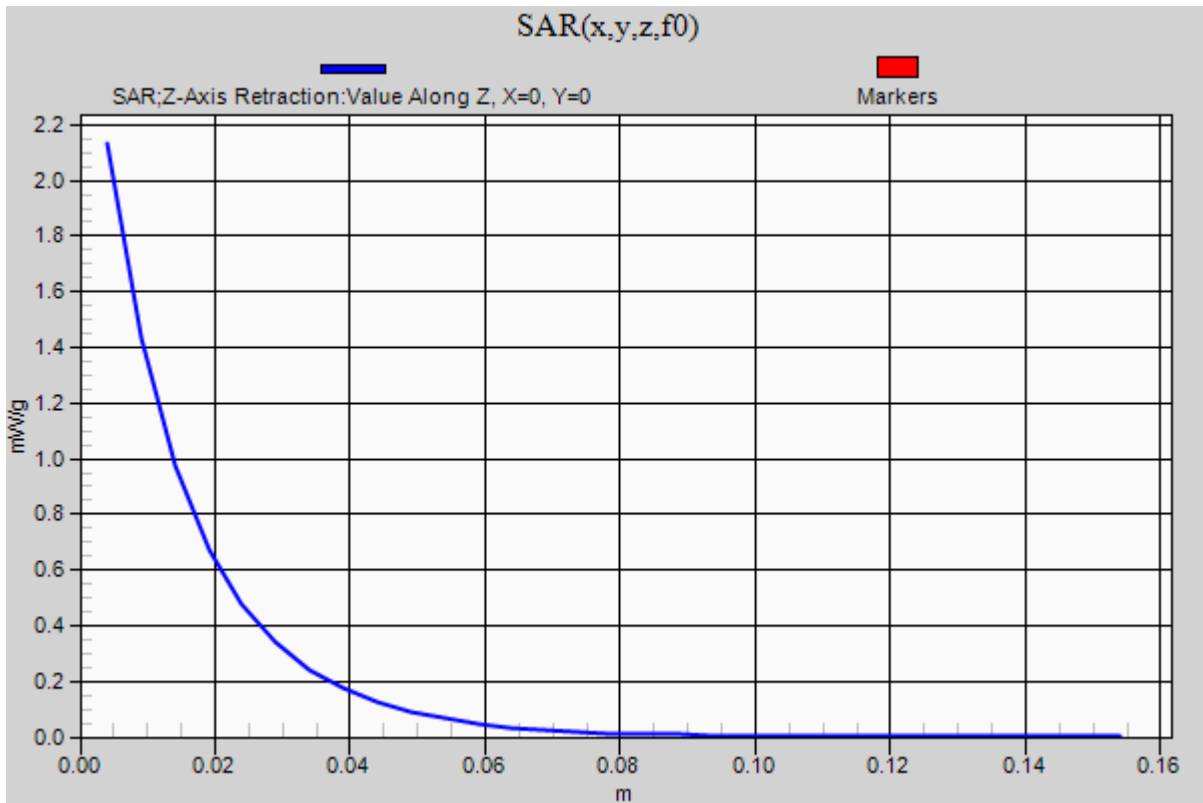
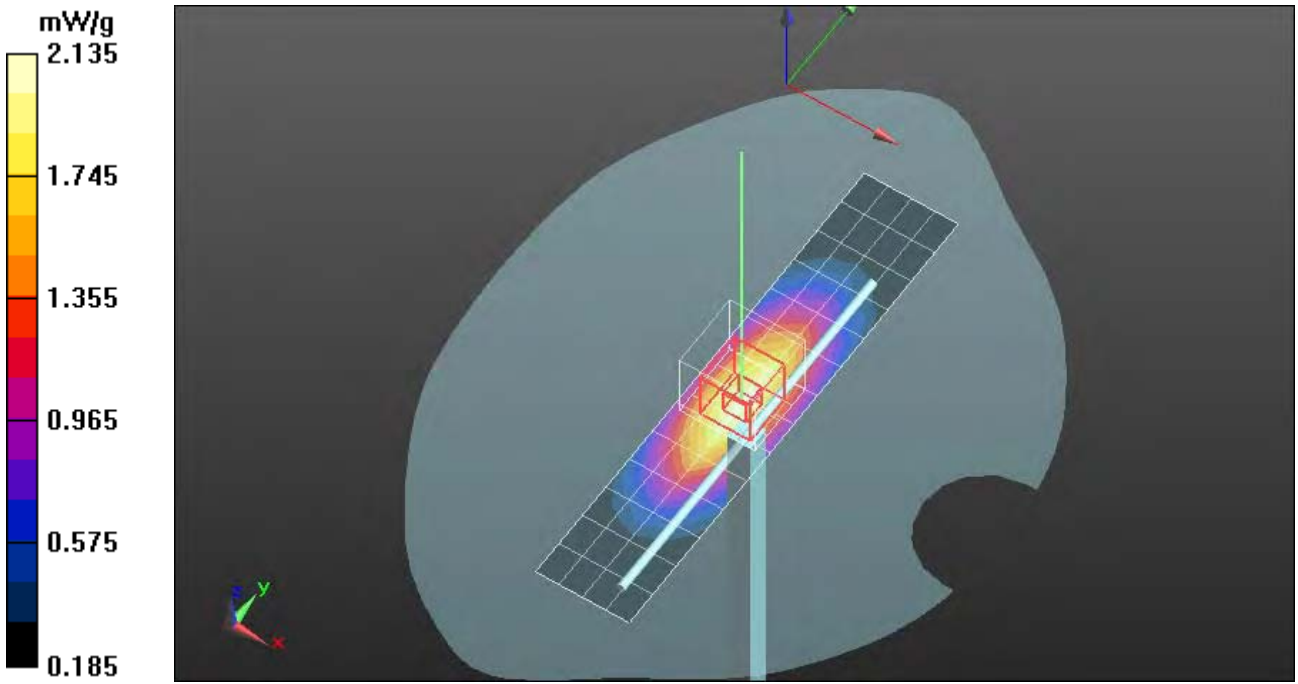

Date/Time: 7/23/2012 2:59:57 PM

Test Laboratory: Motorola - 835MHz Head

DUT: Dipole 835 MHz; Serial: D835V2 - SN:425tr; FCC ID:IHDT56NS8

Procedure Notes: 835 MHz System Performance Check; Dipole Sn# 425TR; PM1 Power =200 mW
Sim.Temp@meas =19.7; Sim.Temp@SPC = 19.8; Room Temp @ SPC = 21.4

Communication System: _CW - Dipole; Frequency: 835 MHz;

Communication System Channel Number: 3; Duty Cycle: 1:1

Medium: Validation *HEAD Tissue* ;

Medium parameters used: $f = 835 \text{ MHz}$; $\sigma = 0.91 \text{ mho/m}$; $\epsilon_r = 40.5$; $\rho = 1000 \text{ kg/m}^3$

DASY4 Configuration:

- Probe: ES3DV3 - SN3180; ConvF(6.07, 6.07, 6.07); Calibrated: 1/11/2012
- Sensor-Surface: 4mm (Mechanical Surface Detection)
- Electronics: DAE4 Sn1313; Calibrated: 1/20/2012
- Phantom: R12_ Sugar SAM (extended range), Rev.2 (24-Feb-12); Type: SAM v4.0; Serial: TP-1154;
- ; SEMCAD X Version 14.6.4 (4989)

DASY5, SAM - System Performance Check Template, Rev.2 (12-Sept-11)/Daily SPC Check/Z-Axis Retraction (1x1x31):

Measurement grid: dx=20mm, dy=20mm, dz=5mm

Maximum value of SAR (measured) = 2.117 mW/g

DASY5, SAM - System Performance Check Template, Rev.2 (12-Sept-11)/Daily SPC Check/Dipole Area Scan (5x15x1):

Measurement grid: dx=10mm, dy=15mm

Maximum value of SAR (measured) = 2.105 mW/g

DASY5, SAM - System Performance Check Template, Rev.2 (12-Sept-11)/Daily SPC Check/0-Degree, 5x5x7 Cube (5x5x7)/Cube 0:

Measurement grid: dx=8mm, dy=8mm, dz=5mm

Reference Value = 49.172 V/m; Power Drift = -0.07 dB

Peak SAR (extrapolated) = 2.9070

SAR(1 g) = 1.97 mW/g; SAR(10 g) = 1.29 mW/g

Maximum value of SAR (measured) = 2.136 mW/g

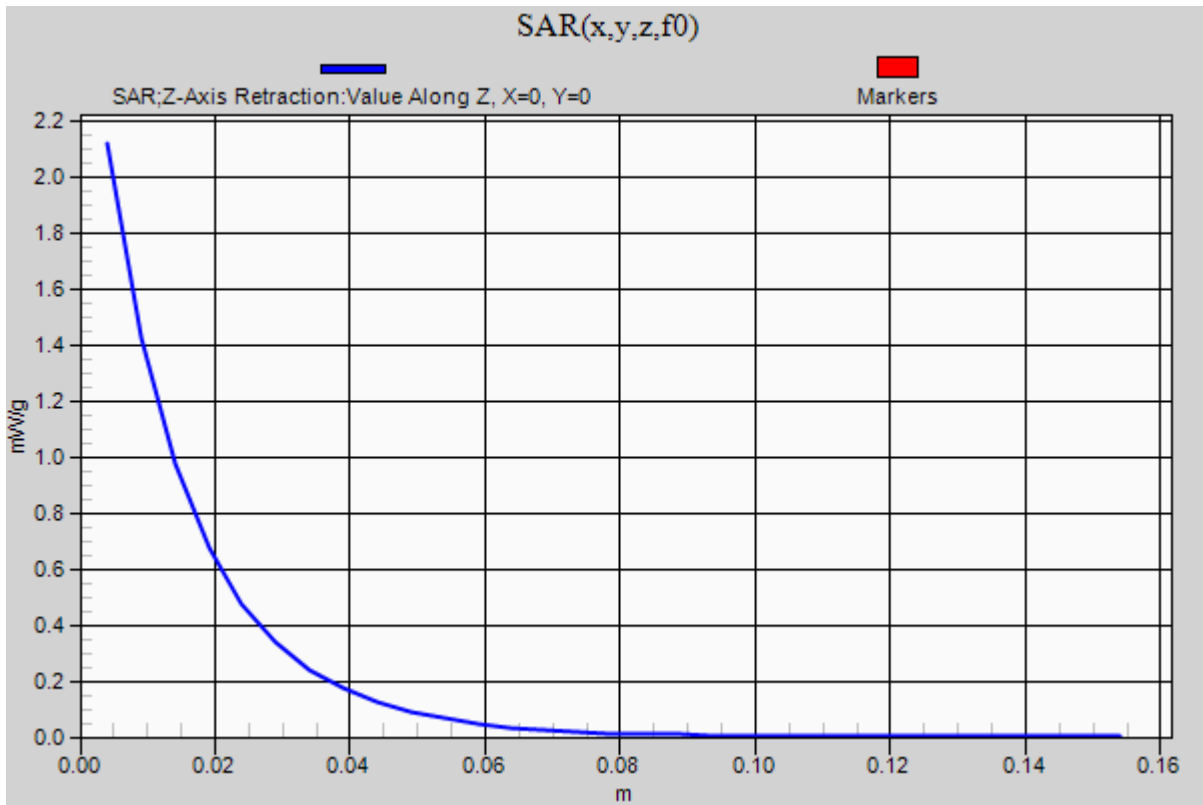
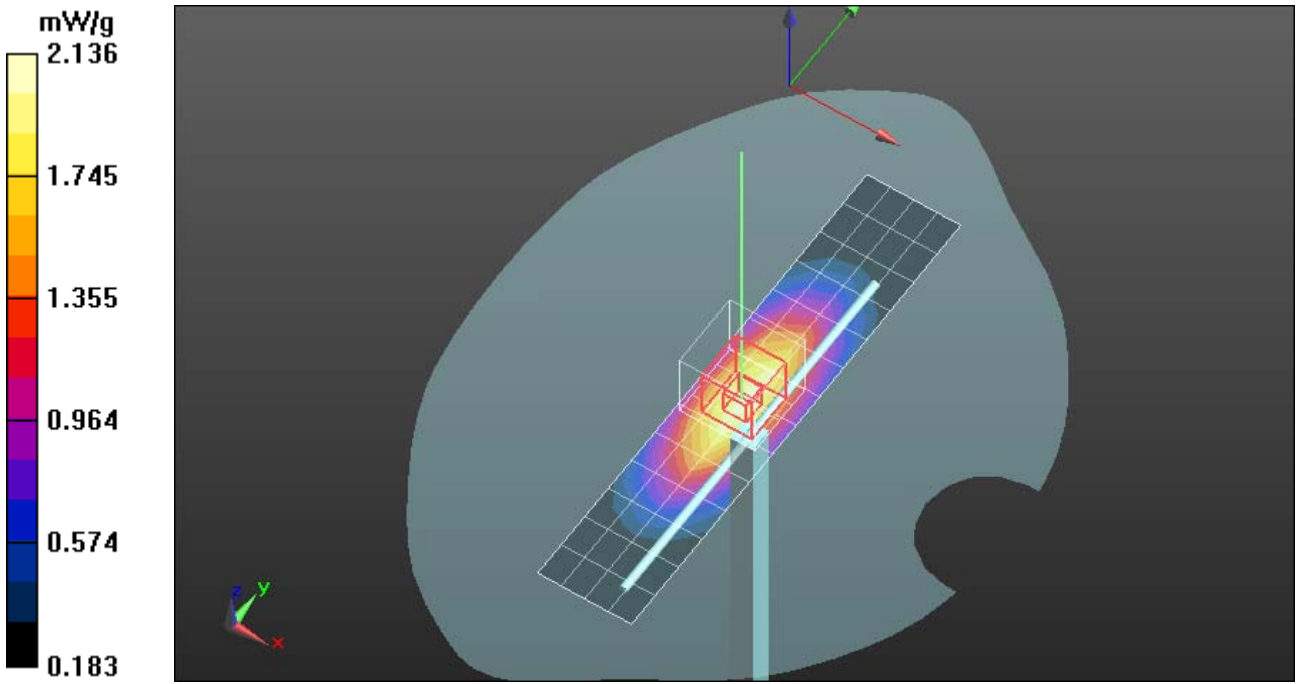

Date/Time: 7/6/2012 2:37:06 PM

Test Laboratory: Motorola - 1800MHz Head

DUT: Dipole 1800 MHz; Serial: D1800V2 - SN:2d129; FCC ID:IHDT56NS8

Procedure Notes: 1800 MHz System Performance Check; Dipole Sn# 2d129; PM1 Power =200 mW

Sim.Temp@meas = 20.4 Sim.Temp@SPC = 20.1 Room Temp @ SPC =20.8

Communication System: _CW - Dipole; Frequency: 1800 MHz;

Communication System Channel Number: 8; Duty Cycle: 1:1

Medium: Validation *HEAD Tissue* ;

Medium parameters used: $f = 1800$ MHz; $\sigma = 1.39$ mho/m; $\epsilon_r = 39.4$; $\rho = 1000$ kg/m³

DASY4 Configuration:

- Probe: ES3DV3 - SN3180; ConvF(5.2, 5.2, 5.2); Calibrated: 1/11/2012
- Sensor-Surface: 4mm (Mechanical Surface Detection)
- Electronics: DAE4 Sn1313; Calibrated: 1/20/2012
- Phantom: R12_ Glycol SAM (extended range), Rev.2 (24-Feb-12); Type: SAM v4.0; Serial: TP-1684;
- ; SEMCAD X Version 14.6.4 (4989)

DASY5, SAM - System Performance Check Template, Rev.2 (12-Sept-11)/Daily SPC Check/Z-Axis Retraction (1x1x31):

Measurement grid: dx=20mm, dy=20mm, dz=5mm

Maximum value of SAR (measured) = 8.210 mW/g

DASY5, SAM - System Performance Check Template, Rev.2 (12-Sept-11)/Daily SPC Check/Dipole Area Scan (5x15x1):

Measurement grid: dx=10mm, dy=15mm

Maximum value of SAR (measured) = 8.077 mW/g

DASY5, SAM - System Performance Check Template, Rev.2 (12-Sept-11)/Daily SPC Check/0-Degree, 5x5x7 Cube (5x5x7)/Cube 0:

Measurement grid: dx=8mm, dy=8mm, dz=5mm

Reference Value = 77.195 V/m; Power Drift = 0.03 dB

Peak SAR (extrapolated) = 13.2260

SAR(1 g) = 7.29 mW/g; SAR(10 g) = 3.83 mW/g

Maximum value of SAR (measured) = 8.173 mW/g

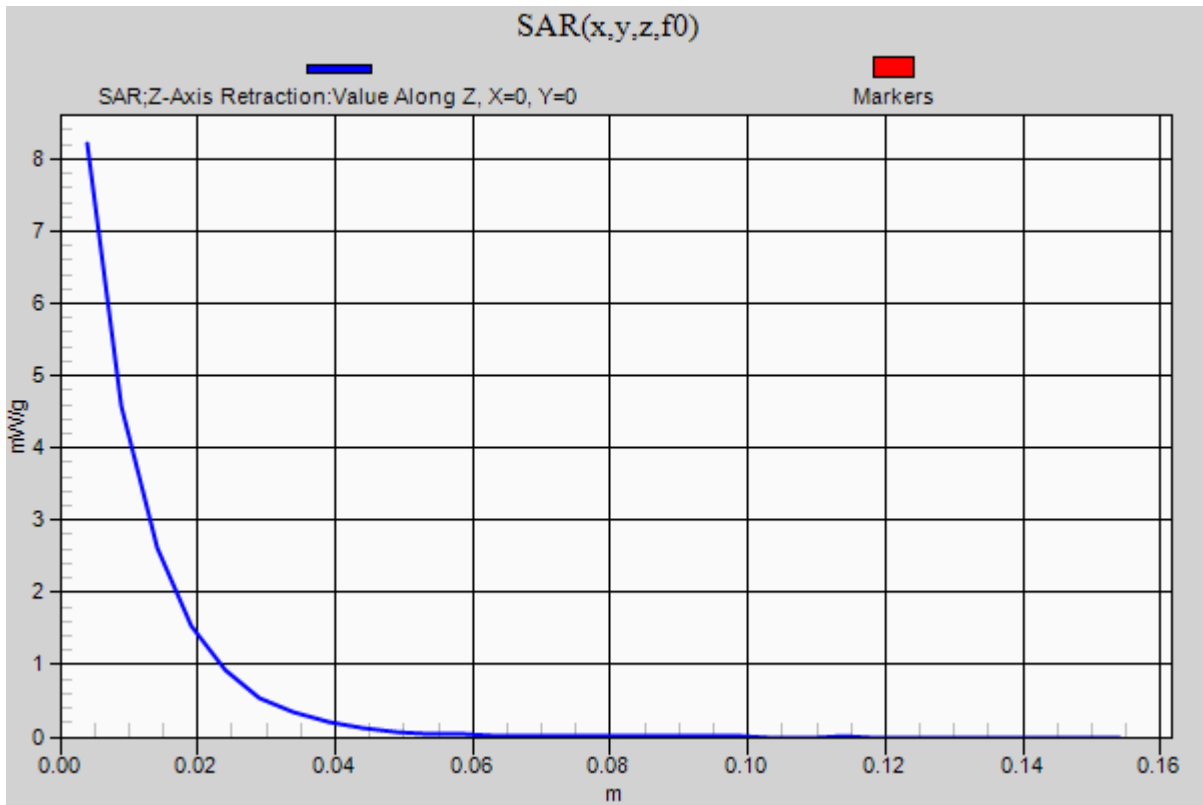
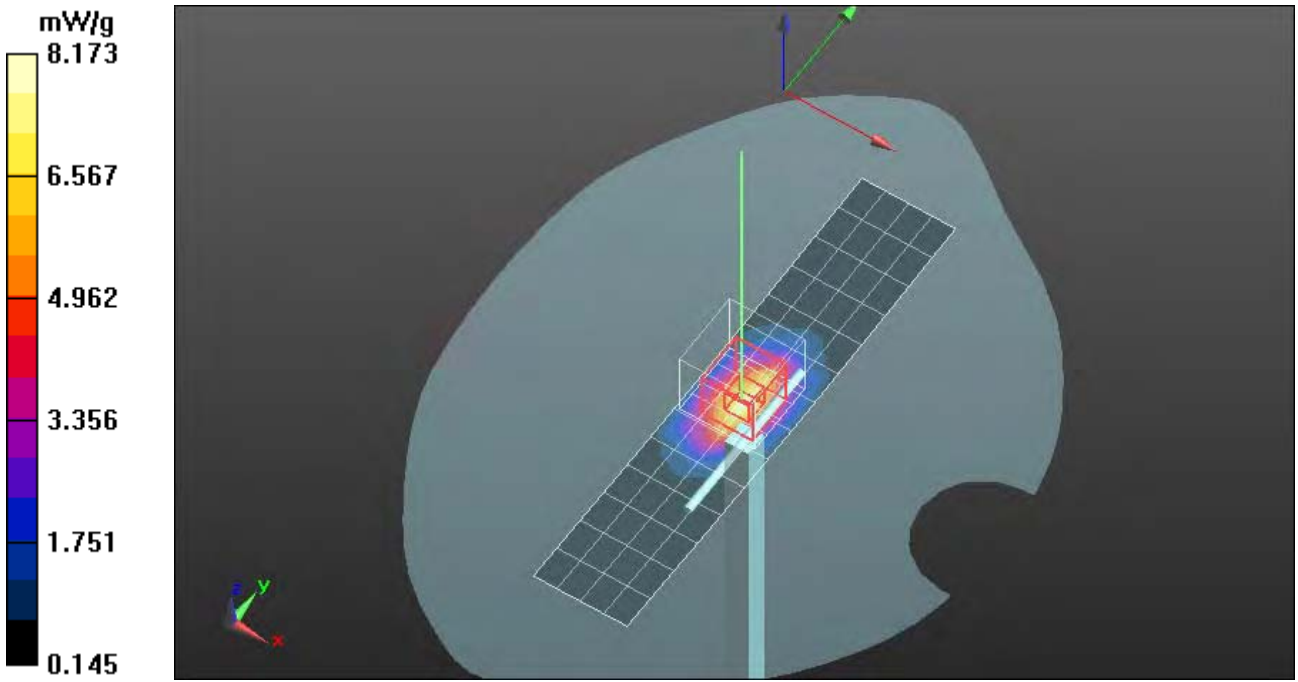

Date/Time: 7/4/2012 1:07:15 PM

Test Laboratory: Motorola - 1800MHz Head

DUT: Dipole 1800 MHz; Serial: D1800V2 - SN:2d129; FCC ID:IHDT56NS8

Procedure Notes: 1800 MHz System Performance Check; Dipole Sn# 2d129; PM1 Power =200 mW

Sim.Temp@meas = 20.4 Sim.Temp@SPC = 20.1 Room Temp @ SPC = 20.9

Communication System: _CW - Dipole; Frequency: 1800 MHz;

Communication System Channel Number: 8; Duty Cycle: 1:1

Medium: Validation *HEAD Tissue* ;

Medium parameters used: $f = 1800$ MHz; $\sigma = 1.39$ mho/m; $\epsilon_r = 39.4$; $\rho = 1000$ kg/m³

DASY4 Configuration:

- Probe: ES3DV3 - SN3180; ConvF(5.2, 5.2, 5.2); Calibrated: 1/11/2012
- Sensor-Surface: 4mm (Mechanical Surface Detection)
- Electronics: DAE4 Sn1313; Calibrated: 1/20/2012
- Phantom: R12_ Glycol SAM (extended range), Rev.2 (24-Feb-12); Type: SAM v4.0; Serial: TP-1684;
- ; SEMCAD X Version 14.6.4 (4989)

DASY5, SAM - System Performance Check Template, Rev.2 (12-Sept-11)/Daily SPC Check/Z-Axis Retraction (1x1x31):

Measurement grid: dx=20mm, dy=20mm, dz=5mm

Maximum value of SAR (measured) = 8.129 mW/g

DASY5, SAM - System Performance Check Template, Rev.2 (12-Sept-11)/Daily SPC Check/Dipole Area Scan (5x15x1):

Measurement grid: dx=10mm, dy=15mm

Maximum value of SAR (measured) = 8.118 mW/g

DASY5, SAM - System Performance Check Template, Rev.2 (12-Sept-11)/Daily SPC Check/0-Degree, 5x5x7 Cube (5x5x7)/Cube 0:

Measurement grid: dx=8mm, dy=8mm, dz=5mm

Reference Value = 76.797 V/m; Power Drift = 0.17 dB

Peak SAR (extrapolated) = 13.1360

SAR(1 g) = 7.22 mW/g; SAR(10 g) = 3.78 mW/g

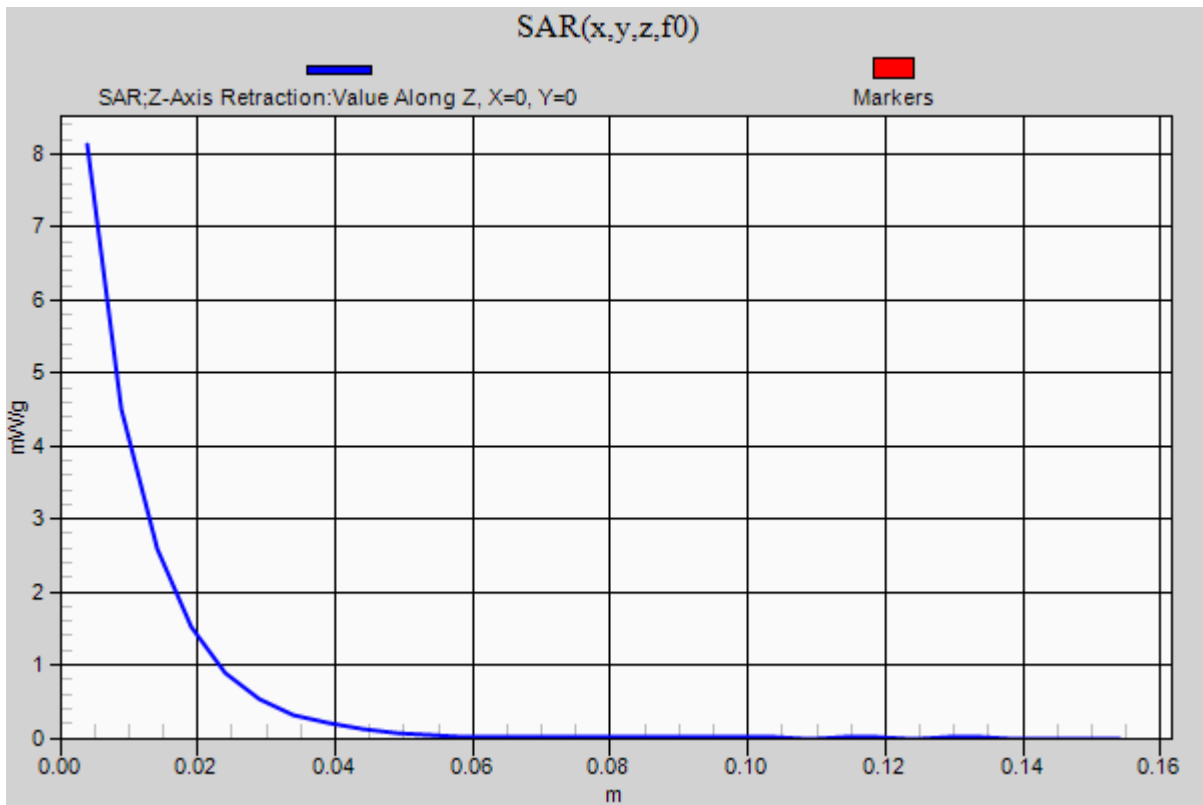
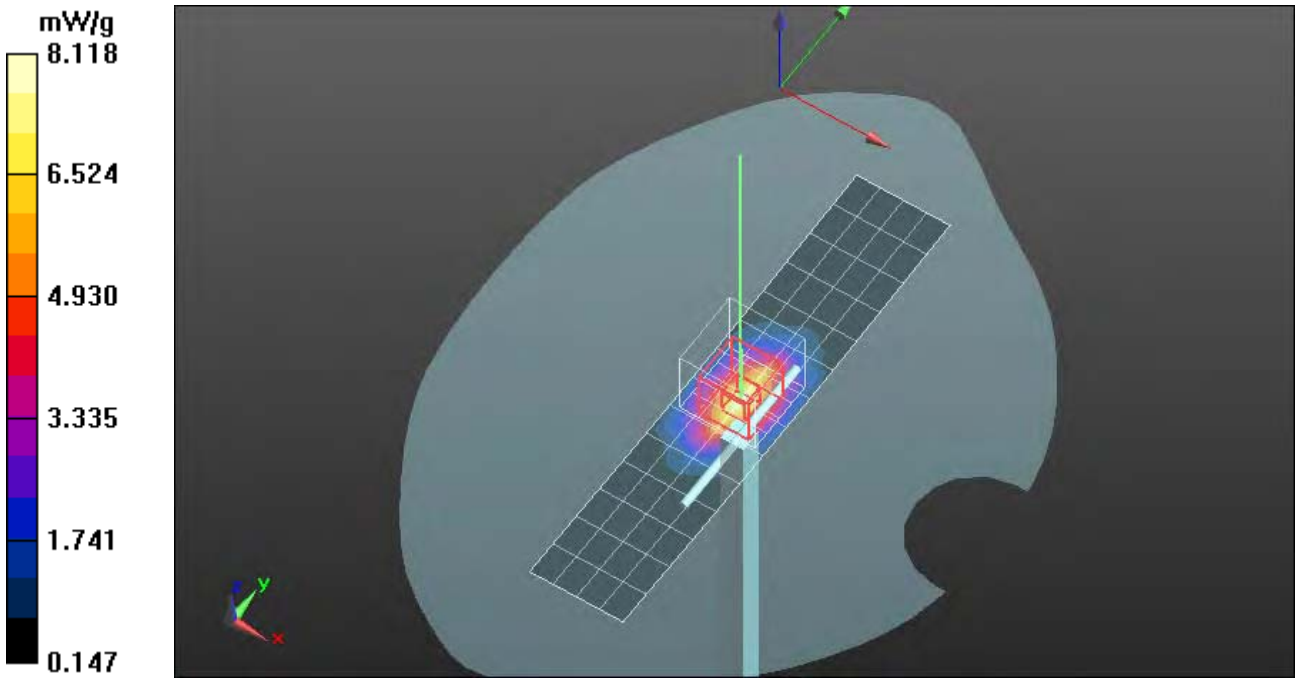

Date/Time: 7/23/2012 5:16:14 PM

Test Laboratory: Motorola - 1800MHz Head

DUT: Dipole 1800 MHz; Serial: D1800V2 - SN:2d129; FCC ID:IHDT56NS8

Procedure Notes: 835 MHz System Performance Check; Dipole Sn# 2d129; PM1 Power =200 mW
Sim.Temp@meas = 20.8 Sim.Temp@SPC = 20.5 Room Temp @ SPC =21.3

Communication System: _CW - Dipole; Frequency: 1800 MHz;

Communication System Channel Number: 8; Duty Cycle: 1:1

Medium: Validation *HEAD Tissue* ;

Medium parameters used: $f = 1800$ MHz; $\sigma = 1.37$ mho/m; $\epsilon_r = 40$; $\rho = 1000$ kg/m³

DASY4 Configuration:

- Probe: ES3DV3 - SN3180; ConvF(5.2, 5.2, 5.2); Calibrated: 1/11/2012
- Sensor-Surface: 4mm (Mechanical Surface Detection)
- Electronics: DAE4 Sn1313; Calibrated: 1/20/2012
- Phantom: R12_ Glycol SAM (extended range), Rev.2 (24-Feb-12); Type: SAM v4.0; Serial: TP-1684;
- ; SEMCAD X Version 14.6.4 (4989)

DASY5, SAM - System Performance Check Template, Rev.2 (12-Sept-11)/Daily SPC Check/Z-Axis Retraction (1x1x31):

Measurement grid: dx=20mm, dy=20mm, dz=5mm

Maximum value of SAR (measured) = 8.063 mW/g

DASY5, SAM - System Performance Check Template, Rev.2 (12-Sept-11)/Daily SPC Check/Dipole Area Scan (5x15x1):

Measurement grid: dx=10mm, dy=15mm

Maximum value of SAR (measured) = 7.898 mW/g

DASY5, SAM - System Performance Check Template, Rev.2 (12-Sept-11)/Daily SPC Check/0-Degree, 5x5x7 Cube (5x5x7)/Cube 0:

Measurement grid: dx=8mm, dy=8mm, dz=5mm

Reference Value = 77.187 V/m; Power Drift = -0.01 dB

Peak SAR (extrapolated) = 13.0530

SAR(1 g) = 7.18 mW/g; SAR(10 g) = 3.77 mW/g

Maximum value of SAR (measured) = 8.082 mW/g

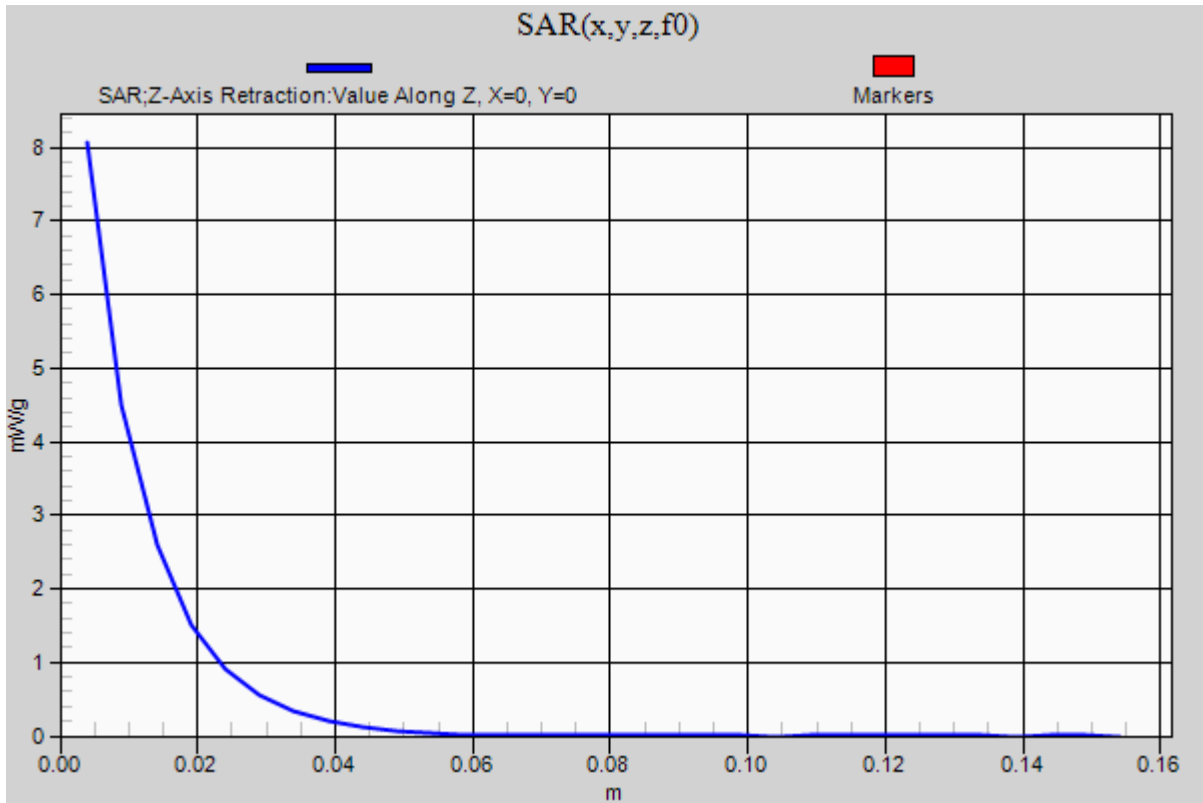
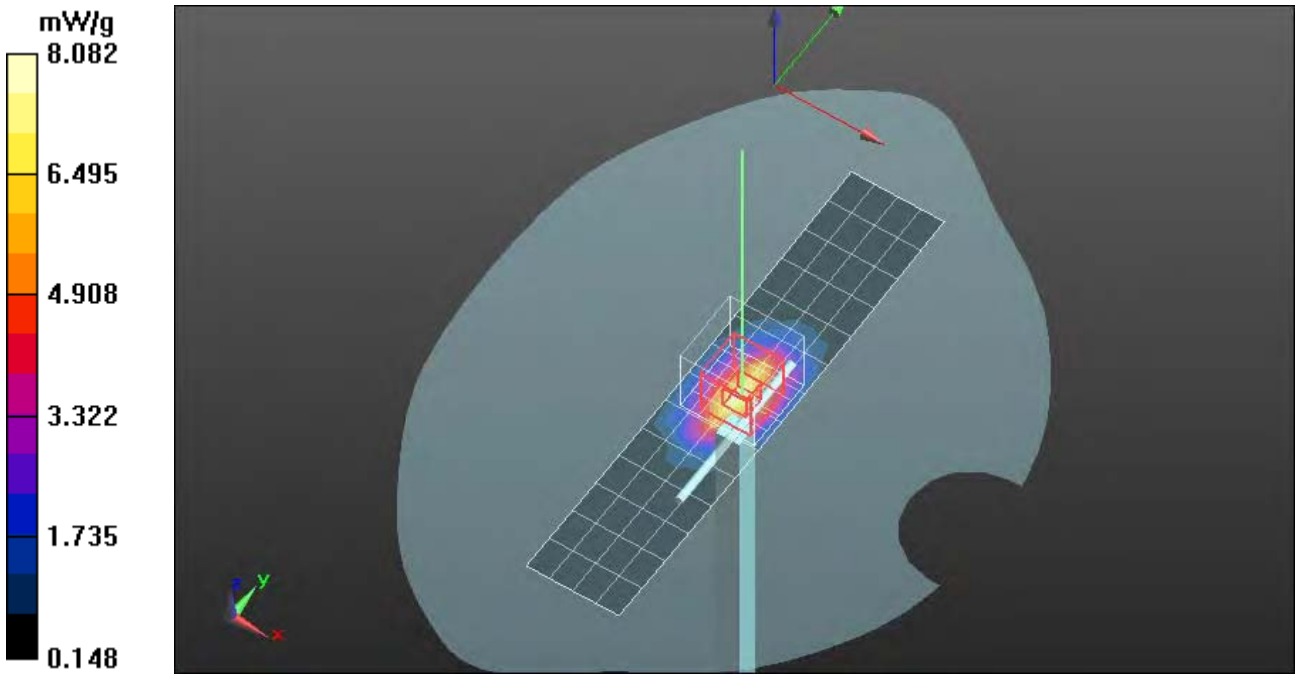

Date/Time: 7/16/2012 5:16:34 PM

Test Laboratory: Motorola - 2450MHz Head

DUT: Dipole 2450 MHz; Serial: D2450V2 - SN:788; FCC ID:IHDT56NS8

Procedure Notes: 2450 MHz System Performance Check; Dipole Sn# 788; PM1 Power = 200 mW
Sim.Temp@meas = 19.3 Sim.Temp@SPC = 19.8 Room Temp @ SPC = 21.4

Communication System: _CW - Dipole; Frequency: 2450 MHz;

Communication System Channel Number: 11; Duty Cycle: 1:1

Medium: Validation *HEAD Tissue* ;

Medium parameters used: $f = 2450$ MHz; $\sigma = 1.88$ mho/m; $\epsilon_r = 37.4$; $\rho = 1000$ kg/m³

DASY4 Configuration:

- Probe: ES3DV3 - SN3180; ConvF(4.51, 4.51, 4.51); Calibrated: 1/11/2012
- Sensor-Surface: 4mm (Mechanical Surface Detection)
- Electronics: DAE4 Sn1313; Calibrated: 1/20/2012
- Phantom: R12_ Glycol SAM (extended range), Rev.2 (24-Feb-12); Type: SAM v4.0; Serial: TP-1684;
- ; SEMCAD X Version 14.6.4 (4989)

DASY5, SAM - System Performance Check Template, Rev.2 (12-Sept-11)/Daily SPC Check/Z-Axis Retraction (1x1x31):

Measurement grid: dx=20mm, dy=20mm, dz=5mm

Maximum value of SAR (measured) = 12.504 mW/g

DASY5, SAM - System Performance Check Template, Rev.2 (12-Sept-11)/Daily SPC Check/Dipole Area Scan (5x15x1):

Measurement grid: dx=10mm, dy=15mm

Maximum value of SAR (measured) = 12.336 mW/g

DASY5, SAM - System Performance Check Template, Rev.2 (12-Sept-11)/Daily SPC Check/0-Degree, 5x5x7 Cube (5x5x7)/Cube 0:

Measurement grid: dx=8mm, dy=8mm, dz=5mm

Reference Value = 82.898 V/m; Power Drift = -0.0033 dB

Peak SAR (extrapolated) = 23.7740

SAR(1 g) = 11 mW/g; SAR(10 g) = 5.02 mW/g

Maximum value of SAR (measured) = 12.050 mW/g

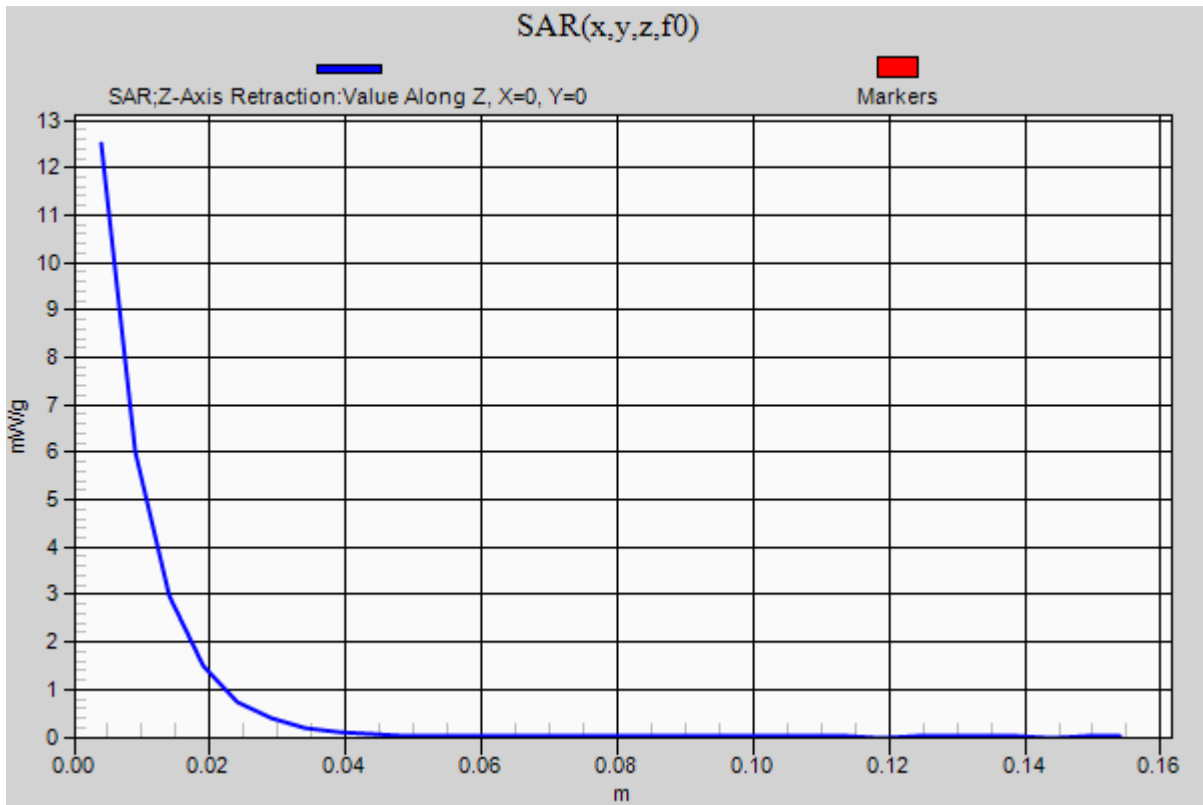
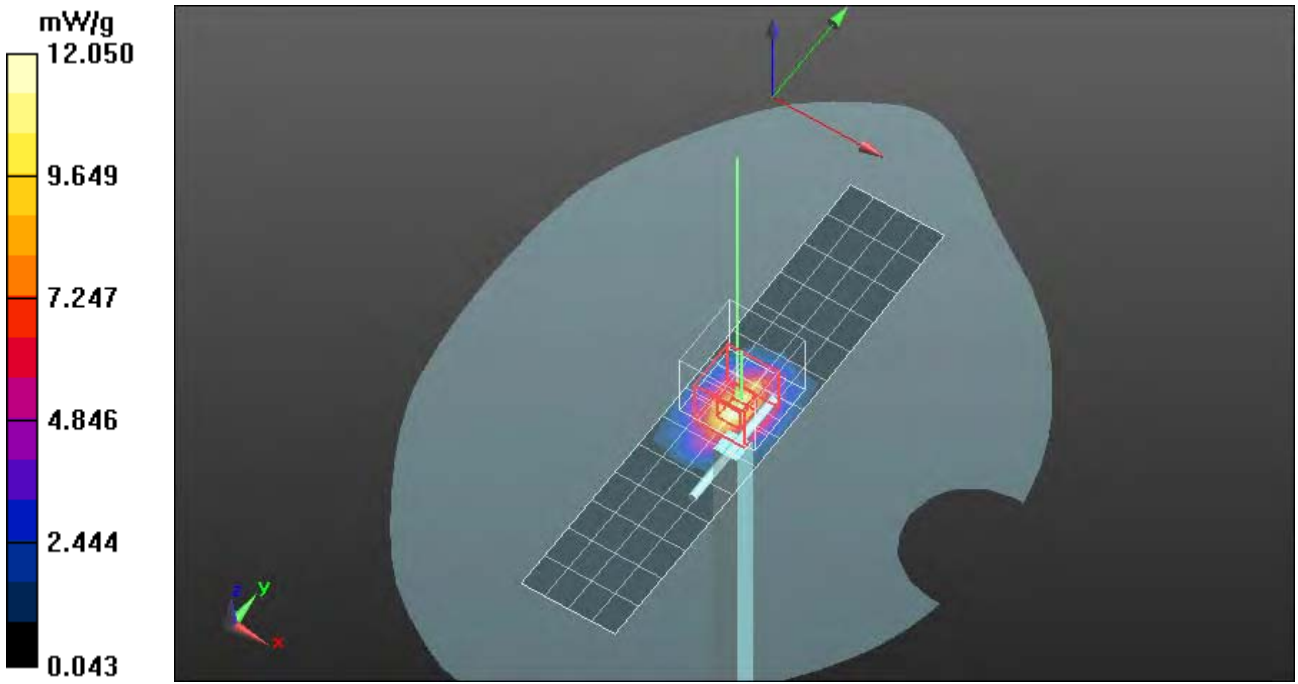

System Accuracy Verification Measurements for Body SAR Measurements

Date/Time: 7/5/2012 9:27:44 AM

Test Laboratory: Motorola - 835MHz Body

DUT: Dipole 835 MHz; Serial: D835V2 - SN:425tr; FCC ID:IHDT56NS8

Procedure Notes: 835 MHz System Performance Check / Dipole Sn# 425tr PM1 Power = 200 mW
Sim.Temp@SPC = 19.8 Room Temp @ SPC = 20.8

Communication System: _CW - Dipole; Frequency: 835 MHz;

Communication System Channel Number: 3; Duty Cycle: 1:1

Medium: Validation *BODY Tissue* ;

Medium parameters used: $f = 835 \text{ MHz}$; $\sigma = 1 \text{ mho/m}$; $\epsilon_r = 53.6$; $\rho = 1000 \text{ kg/m}^3$

DASY4 Configuration:

- Probe: ES3DV3 - SN3180; ConvF(5.97, 5.97, 5.97); Calibrated: 1/11/2012
- Sensor-Surface: 4mm (Mechanical Surface Detection)
- Electronics: DAE4 Sn1313; Calibrated: 1/20/2012
- Phantom: R#-12, Triple Flat Phantom 5.1C (Rev.3); Type: QD 000 P51 CA; Serial: n/a;
- ; SEMCAD X Version 14.6.4 (4989)

DASY5, Triple Flat System Performance Check Template - Rev.3 (19-Sept-11)/Daily SPC Check/Z-Axis Retraction (1x1x31):

Measurement grid: dx=20mm, dy=20mm, dz=5mm

Maximum value of SAR (measured) = 2.128 mW/g

DASY5, Triple Flat System Performance Check Template - Rev.3 (19-Sept-11)/Daily SPC Check/Dipole Area Scan (4x15x1):

Measurement grid: dx=15mm, dy=15mm

Maximum value of SAR (measured) = 1.984 mW/g

DASY5, Triple Flat System Performance Check Template - Rev.3 (19-Sept-11)/Daily SPC Check/0-Degree 5x5x7 Cube (5x5x7)/Cube 0:

Measurement grid: dx=8mm, dy=8mm, dz=5mm

Reference Value = 46.498 V/m; Power Drift = -0.0049 dB

Peak SAR (extrapolated) = 2.8440

SAR(1 g) = 1.96 mW/g; SAR(10 g) = 1.29 mW/g

Maximum value of SAR (measured) = 2.120 mW/g

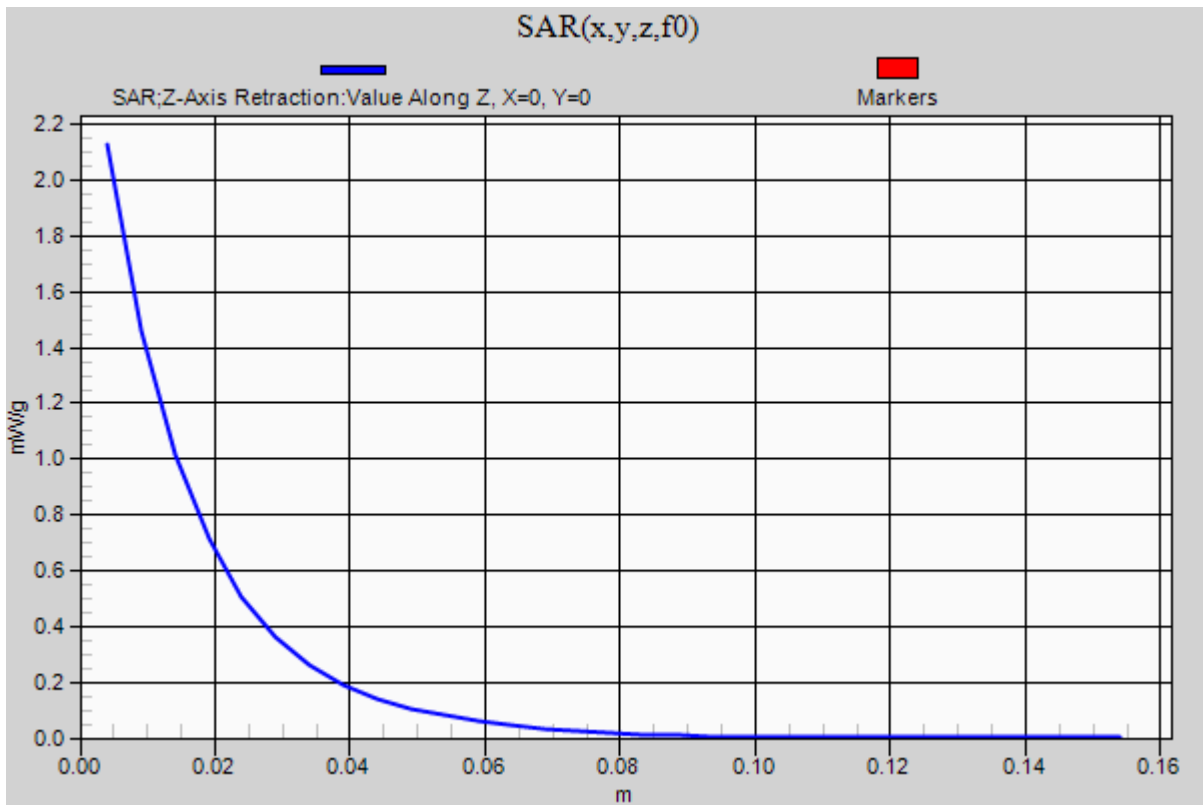
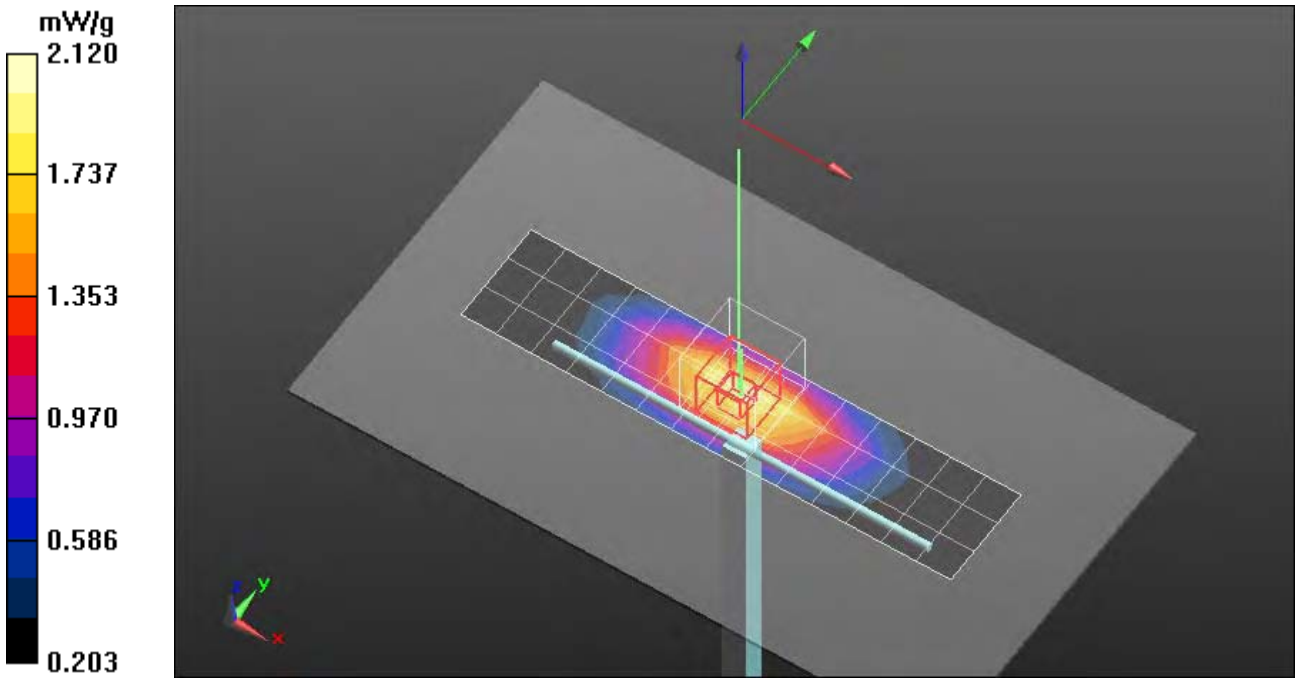

Date/Time: 7/7/2012 12:51:40 PM

Test Laboratory: Motorola - 1800MHz Body

DUT: Dipole 1800 MHz; Serial: D1800V2 - SN: 2d129; FCC ID:IHDT56NS8

Procedure Notes: 1800 MHz System Performance Check / Dipole Sn# 2d129 PM1 Power = 200 mW Sim.Temp@meas = 19.4 Sim.Temp@SPC = 19.8 Room Temp @ SPC =21.0

Communication System: _CW - Dipole; Frequency: 1800 MHz;

Communication System Channel Number: 8; Duty Cycle: 1:1

Medium: Validation *BODY Tissue* ;

Medium parameters used: $f = 1800$ MHz; $\sigma = 1.46$ mho/m; $\epsilon_r = 51.2$; $\rho = 1000$ kg/m³

DASY4 Configuration:

- Probe: ES3DV3 - SN3180; ConvF(5.09, 5.09, 5.09); Calibrated: 1/11/2012
- Sensor-Surface: 4mm (Mechanical Surface Detection)
- Electronics: DAE4 Sn1313; Calibrated: 1/20/2012
- Phantom: R#-12, Triple Flat Phantom 5.1C (Rev.3); Type: QD 000 P51 CA; Serial: n/a;
- ; SEMCAD X Version 14.6.4 (4989)

DASY5, Triple Flat System Performance Check Template - Rev.3 (19-Sept-11)/Daily SPC Check/Z-Axis Retraction (1x1x31):

Measurement grid: dx=20mm, dy=20mm, dz=5mm

Maximum value of SAR (measured) = 7.979 mW/g

DASY5, Triple Flat System Performance Check Template - Rev.3 (19-Sept-11)/Daily SPC Check/Dipole Area Scan (4x15x1):

Measurement grid: dx=15mm, dy=15mm

Maximum value of SAR (measured) = 6.424 mW/g

DASY5, Triple Flat System Performance Check Template - Rev.3 (19-Sept-11)/Daily SPC Check/0-Degree 5x5x7 Cube (5x5x7)/Cube 0:

Measurement grid: dx=8mm, dy=8mm, dz=5mm

Reference Value = 75.542 V/m; Power Drift = -0.08 dB

Peak SAR (extrapolated) = 12.1210

SAR(1 g) = 7.06 mW/g; SAR(10 g) = 3.77 mW/g

Maximum value of SAR (measured) = 7.960 mW/g

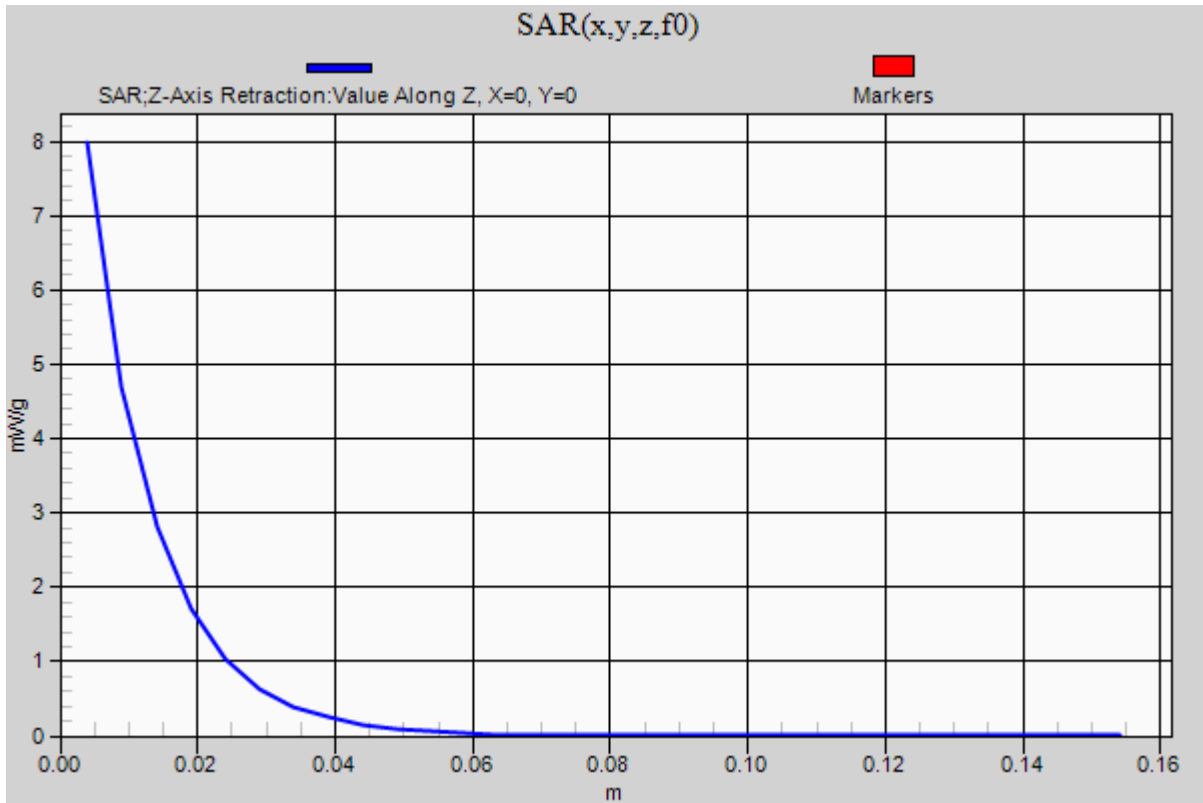
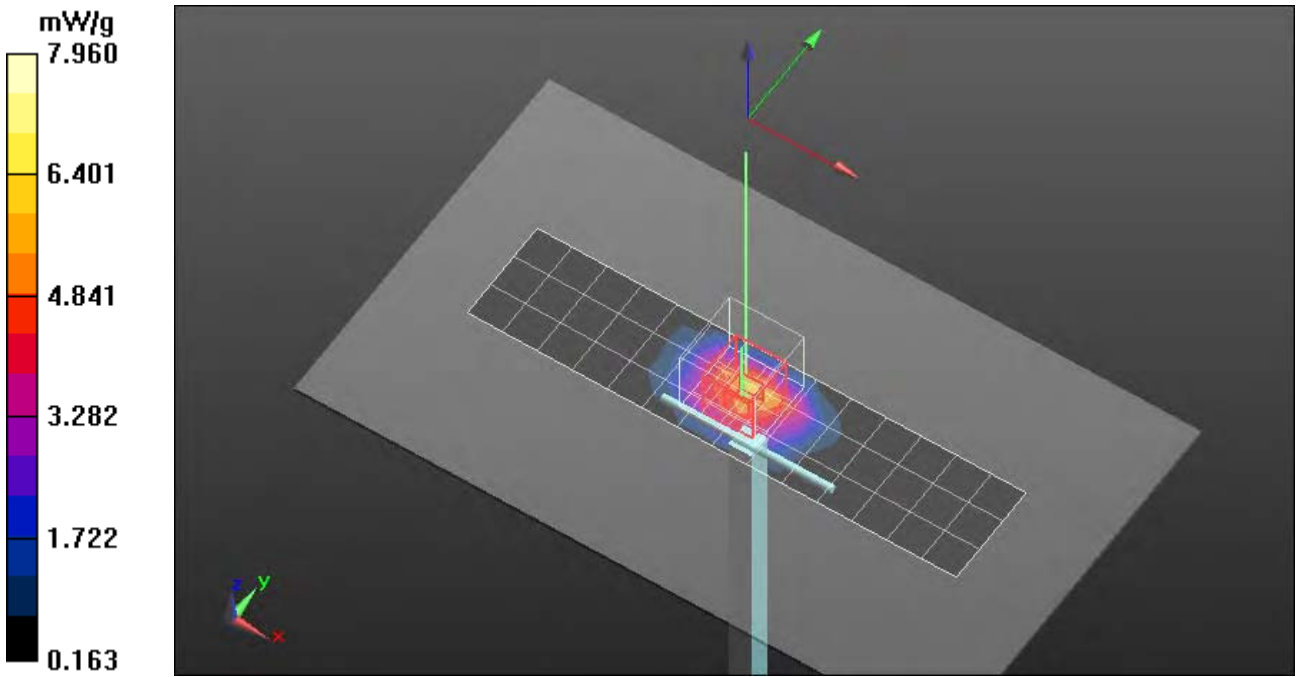

Date/Time: 7/10/2012 5:43:25 PM

Test Laboratory: Motorola - 1800MHz Body

DUT: Dipole 1800 MHz; Serial: D1800V2 - SN:2d129; FCC ID:IHDT56NS8

Procedure Notes: 1800 MHz System Performance Check; Dipole Sn# 2d129; PM1 Power =200 mW

Sim.Temp@meas = 20.8 Sim.Temp@SPC = 20.7 Room Temp @ SPC =21.0

Communication System: _CW - Dipole; Frequency: 1800 MHz;

Communication System Channel Number: 8; Duty Cycle: 1:1

Medium: Validation *BODY Tissue* ;

Medium parameters used: $f = 1800 \text{ MHz}$; $\sigma = 1.5 \text{ mho/m}$; $\epsilon_r = 51.2$; $\rho = 1000 \text{ kg/m}^3$

DASY4 Configuration:

- Probe: ES3DV3 - SN3180; ConvF(5.09, 5.09, 5.09); Calibrated: 1/11/2012
- Sensor-Surface: 4mm (Mechanical Surface Detection)
- Electronics: DAE4 Sn1313; Calibrated: 1/20/2012
- Phantom: R#-12, Triple Flat Phantom 5.1C (Rev.3); Type: QD 000 P51 CA; Serial: n/a;
- ; SEMCAD X Version 14.6.4 (4989)

DASY5, Triple Flat System Performance Check Template - Rev.3 (19-Sept-11)/Daily SPC Check/Z-Axis Retraction (1x1x31):

Measurement grid: dx=20mm, dy=20mm, dz=5mm

Maximum value of SAR (measured) = 8.021 mW/g

DASY5, Triple Flat System Performance Check Template - Rev.3 (19-Sept-11)/Daily SPC Check/Dipole Area Scan (4x15x1):

Measurement grid: dx=15mm, dy=15mm

Maximum value of SAR (measured) = 6.138 mW/g

DASY5, Triple Flat System Performance Check Template - Rev.3 (19-Sept-11)/Daily SPC Check/0-Degree 5x5x7 Cube (5x5x7)/Cube 0:

Measurement grid: dx=8mm, dy=8mm, dz=5mm

Reference Value = 74.153 V/m; Power Drift = 0.0032 dB

Peak SAR (extrapolated) = 12.2080

SAR(1 g) = 7.08 mW/g; SAR(10 g) = 3.78 mW/g

Maximum value of SAR (measured) = 7.987 mW/g

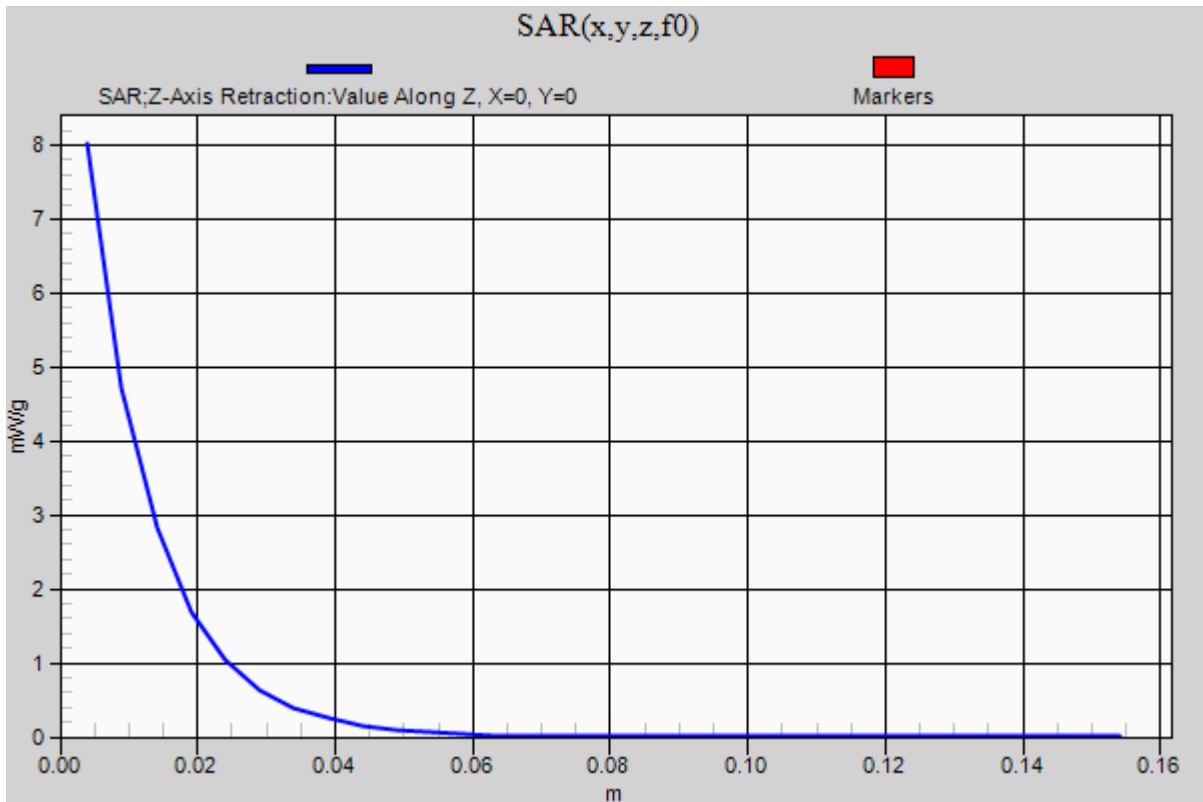
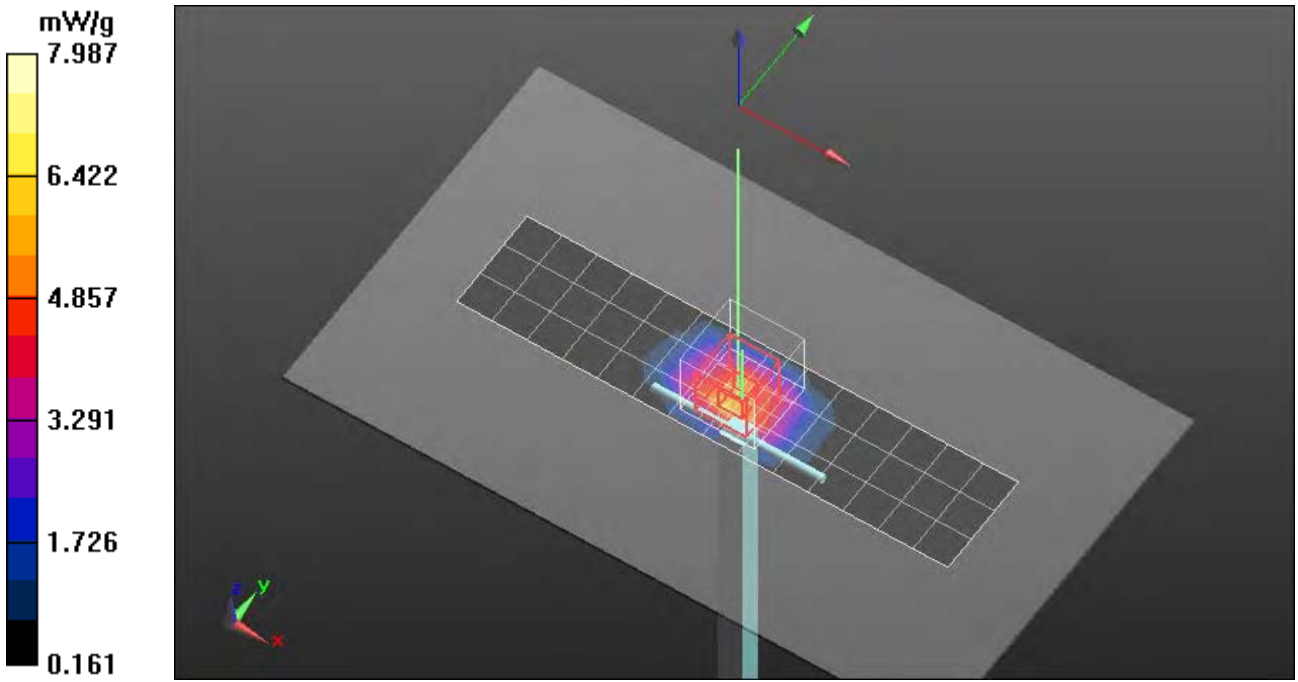

Date/Time: 7/18/2012 5:31:08 PM

Test Laboratory: Motorola - 2450MHz Body

DUT: Dipole 2450 MHz; Serial: D2450V2 - SN:788; FCC ID:IHDT56NS8

Procedure Notes: 2450 MHz System Performance Check / Dipole Sn# 788 PM1 Power = 200 mW

Sim.Temp@meas = 19.2 Sim.Temp@SPC = 19.6 Room Temp @ SPC = 21.1

Communication System: _CW - Dipole; Frequency: 2450 MHz;

Communication System Channel Number: 11; Duty Cycle: 1:1

Medium: Validation *BODY Tissue* ;

Medium parameters used: $f = 2450 \text{ MHz}$; $\sigma = 2.02 \text{ mho/m}$; $\epsilon_r = 51.5$; $\rho = 1000 \text{ kg/m}^3$

DASY4 Configuration:

- Probe: ES3DV3 - SN3180; ConvF(4.46, 4.46, 4.46); Calibrated: 1/11/2012
- Sensor-Surface: 4mm (Mechanical Surface Detection)
- Electronics: DAE4 Sn1313; Calibrated: 1/20/2012
- Phantom: R#-12, Triple Flat Phantom 5.1C (Rev.3); Type: QD 000 P51 CA; Serial: n/a;
- ; SEMCAD X Version 14.6.4 (4989)

DASY5, Triple Flat System Performance Check Template - Rev.3 (19-Sept-11)/Daily SPC Check/Z-Axis Retraction (1x1x31):

Measurement grid: dx=20mm, dy=20mm, dz=5mm

Maximum value of SAR (measured) = 11.585 mW/g

DASY5, Triple Flat System Performance Check Template - Rev.3 (19-Sept-11)/Daily SPC Check/Dipole Area Scan (4x15x1):

Measurement grid: dx=15mm, dy=15mm

Maximum value of SAR (measured) = 9.584 mW/g

DASY5, Triple Flat System Performance Check Template - Rev.3 (19-Sept-11)/Daily SPC Check/0-Degree 5x5x7 Cube (5x5x7)/Cube 0:

Measurement grid: dx=8mm, dy=8mm, dz=5mm

Reference Value = 75.217 V/m; Power Drift = -0.01 dB

Peak SAR (extrapolated) = 20.8970

SAR(1 g) = 10.1 mW/g; SAR(10 g) = 4.66 mW/g

Maximum value of SAR (measured) = 11.538 mW/g

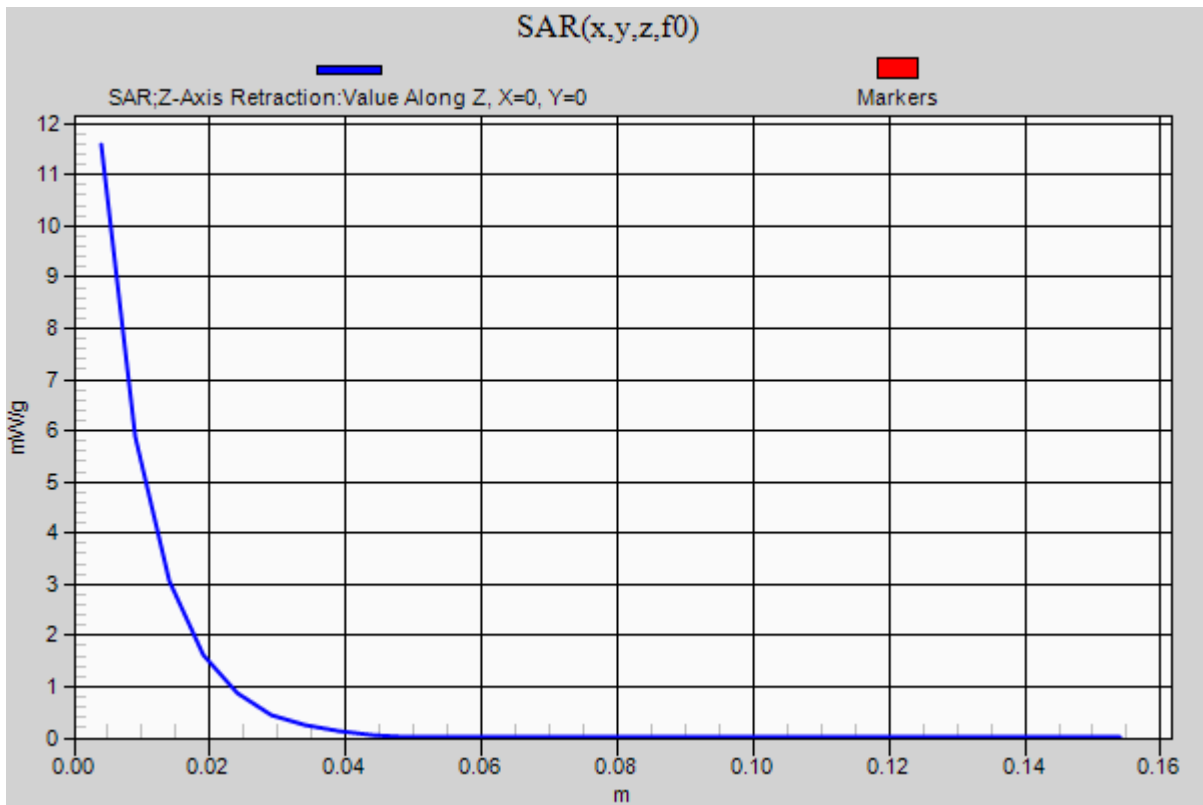
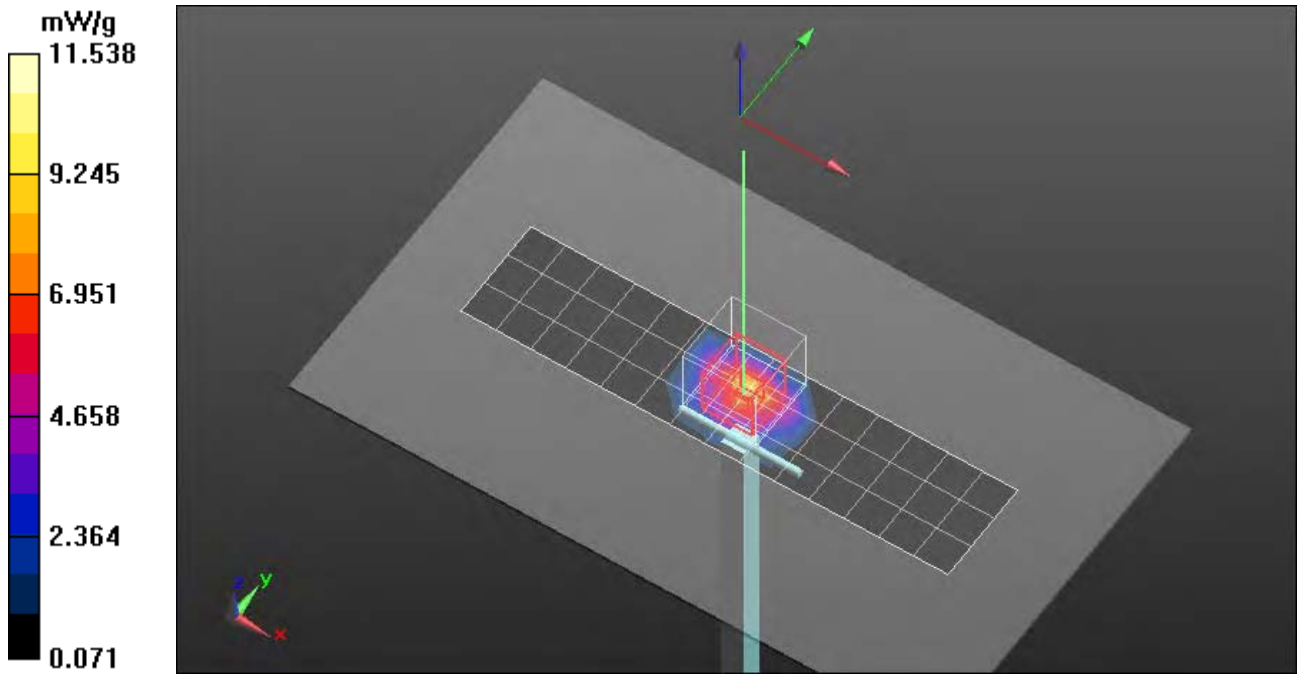

Appendix 2

SAR distribution plots for Head Adjacent Test Results

Date/Time: 7/23/2012 3:26:00 PM

Test Laboratory: Motorola - GPRS850 Cheek

Serial: LSJE260037; FCC ID:IHDT56NS8

Procedure Notes: Pwr Step: 05 Antenna Position: internal; Battery Model #: internal

DEVICE POSITION: cheek

Communication System: _GPRS Class 10; Frequency: 836.6 MHz;

Communication System Channel Number: 190; Duty Cycle: 1:4.14954

Medium: Low Freq Head;

Medium parameters used: $f = 835$ MHz; $\sigma = 0.91$ mho/m; $\epsilon_r = 40.5$; $\rho = 1000$ kg/m³

DASY4 Configuration:

- Probe: ES3DV3 - SN3180; ConvF(6.07, 6.07, 6.07); Calibrated: 1/11/2012
- Sensor-Surface: 4mm (Mechanical Surface Detection)
- Electronics: DAE4 Sn1313; Calibrated: 1/20/2012
- Phantom: R12_Sugar SAM (extended range), Rev.2 (24-Feb-12); Type: SAM v4.0; Serial: TP-1154;
- ; SEMCAD X Version 14.6.4 (4989)

DASY5, SAM - Phone against RIGHT head template - Rev.2 (29-Sept-11)/Right Head Template/Area Scan - Normal (15mm) (7x17x1): Measurement grid: dx=15mm, dy=15mm

Maximum value of SAR (measured) = 0.332 mW/g

DASY5, SAM - Phone against RIGHT head template - Rev.2 (29-Sept-11)/Right Head Template/5x5x7 Zoom Scan (<=3GHz) (5x5x7)/Cube 0: Measurement grid:

dx=8mm, dy=8mm, dz=5mm

Reference Value = 19.209 V/m; Power Drift = -0.20 dB

Peak SAR (extrapolated) = 0.3900

SAR(1 g) = 0.312 mW/g; SAR(10 g) = 0.235 mW/g

Maximum value of SAR (measured) = 0.327 mW/g

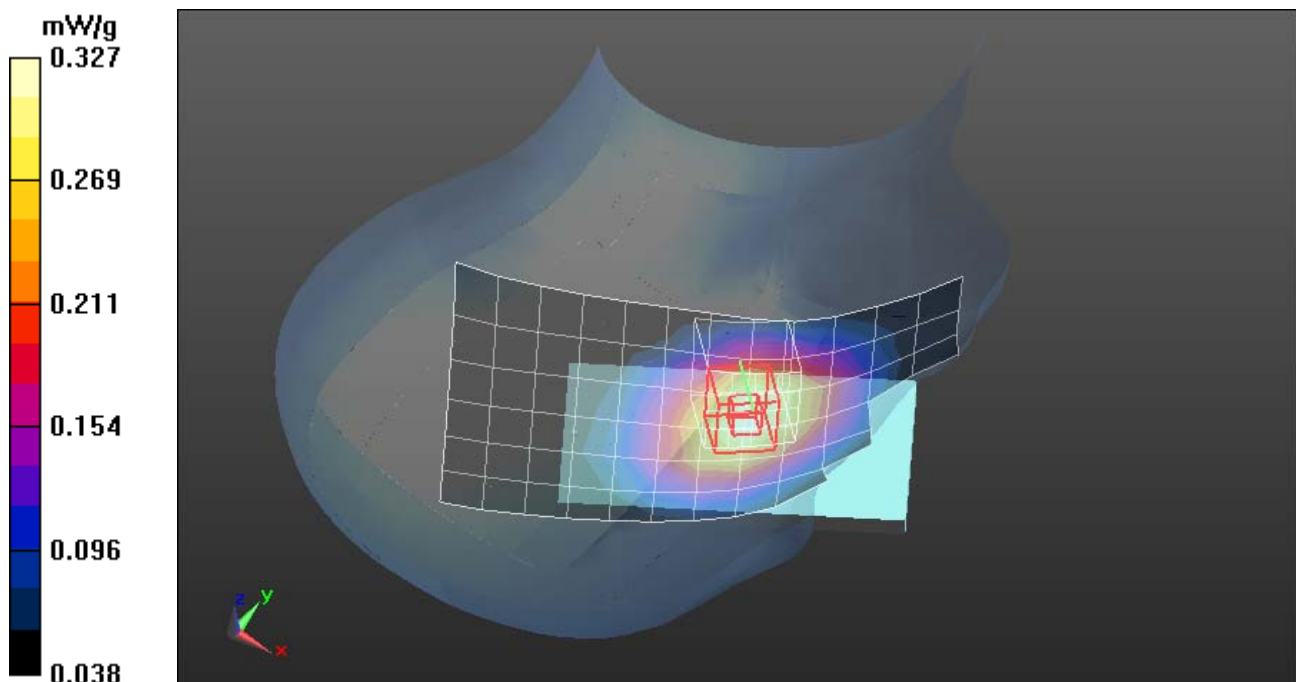

Date/Time: 7/24/2012 1:45:36 PM

Test Laboratory: Motorola - GPRS1900 Cheek

Serial: LSJE260037; FCC ID:IHDT56NS8

Procedure Notes: Pwr Step: 00 Antenna Position: internal; Battery Model #: internal

DEVICE POSITION: CHEEK

Communication System: _GPRS Class 10; Frequency: 1850.2 MHz;

Communication System Channel Number: 512; Duty Cycle: 1:4.14954

Medium: Regular Glycol Head 1750/1880;

Medium parameters used: $f = 1880$ MHz; $\sigma = 1.45$ mho/m; $\epsilon_r = 39.5$; $\rho = 1000$ kg/m³

DASY4 Configuration:

- Probe: ES3DV3 - SN3180; ConvF(5.2, 5.2, 5.2); Calibrated: 1/11/2012
- Sensor-Surface: 4mm (Mechanical Surface Detection)
- Electronics: DAE4 Sn1313; Calibrated: 1/20/2012
- Phantom: R12_Glycol SAM (extended range), Rev.2 (24-Feb-12); Type: SAM v4.0; Serial: TP-1684;
- ; SEMCAD X Version 14.6.4 (4989)

DASY5, SAM - Phone against Left Head Template, Rev.4 (20-July-12)/Left Head Template/Area Scan - Normal (15mm) (7x17x1): Measurement grid: dx=15mm, dy=15mm
Maximum value of SAR (measured) = 0.959 mW/g

DASY5, SAM - Phone against Left Head Template, Rev.4 (20-July-12)/Left Head Template/5x5x7 Zoom Scan (<=3GHz) (5x5x7)/Cube 0: Measurement grid: dx=8mm, dy=8mm, dz=5mm

Reference Value = 24.607 V/m; Power Drift = -0.33 dB

Peak SAR (extrapolated) = 1.5890

SAR(1 g) = 0.973 mW/g; SAR(10 g) = 0.577 mW/g

Maximum value of SAR (measured) = 1.023 mW/g

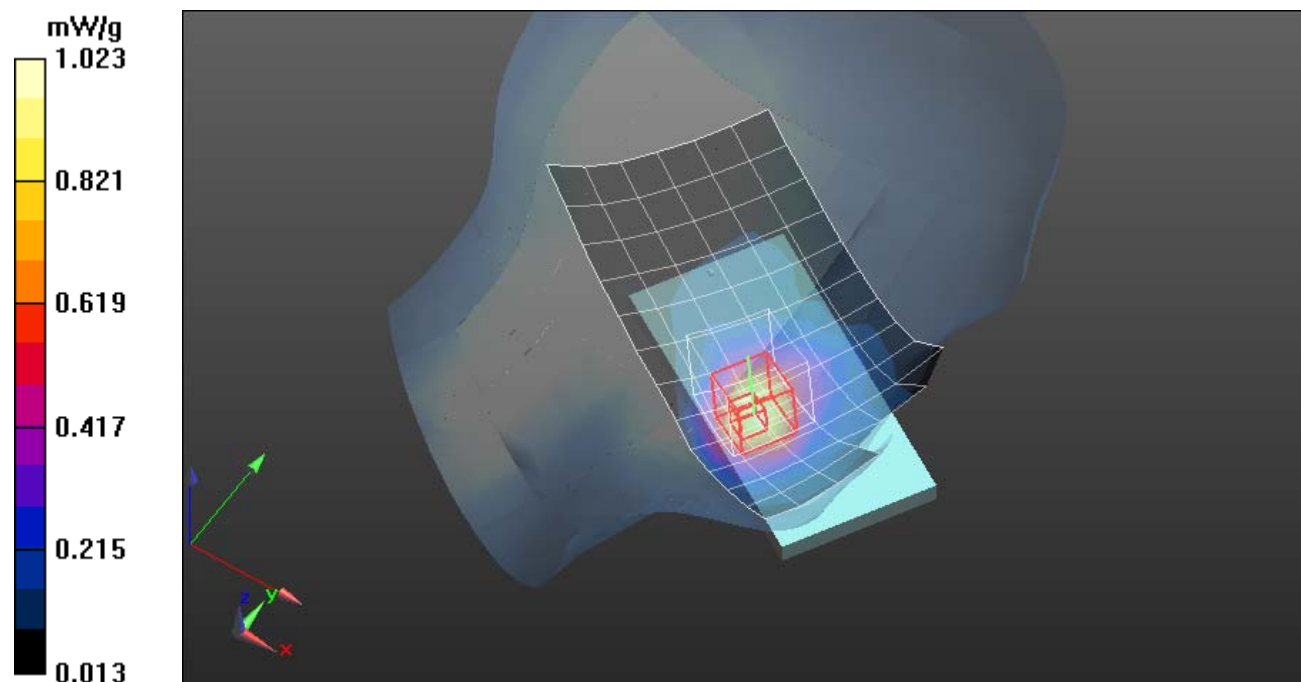

Date/Time: 7/2/2012 11:51:18 AM

Test Laboratory: Motorola - WCDMA800 Cheek

Serial: LSJE260037; FCC ID: IHDT56NS8

Procedure Notes: Pwr Step: All Up Antenna Position: internal; Battery Model #: internal

DEVICE POSITION: cheek

Communication System: _WCDMA; Frequency: 836 MHz;

Communication System Channel Number: 4180; Duty Cycle: 1:1

Medium: Low Freq Head;

Medium parameters used: $f = 835$ MHz; $\sigma = 0.93$ mho/m; $\epsilon_r = 41.2$; $\rho = 1000$ kg/m³

DASY4 Configuration:

- Probe: ES3DV3 - SN3180; ConvF(6.07, 6.07, 6.07); Calibrated: 1/11/2012
- Sensor-Surface: 4mm (Mechanical Surface Detection)
- Electronics: DAE4 Sn1313; Calibrated: 1/20/2012
- Phantom: R12_Sugar SAM (extended range), Rev.2 (24-Feb-12); Type: SAM v4.0; Serial: TP-1154;
- ; SEMCAD X Version 14.6.4 (4989)

DASY5, SAM - Phone against Left Head Template, Rev.3 (29-Sept-11)/Left Head Template/Area Scan - Normal (15mm) (7x17x1): Measurement grid: dx=15mm, dy=15mm
Maximum value of SAR (measured) = 0.262 mW/g

DASY5, SAM - Phone against Left Head Template, Rev.3 (29-Sept-11)/Left Head Template/5x5x7 Zoom Scan (<=3GHz) (5x5x7)/Cube 0: Measurement grid: dx=8mm, dy=8mm, dz=5mm

Reference Value = 17.414 V/m; Power Drift = -0.18 dB

Peak SAR (extrapolated) = 0.3080

SAR(1 g) = 0.247 mW/g; SAR(10 g) = 0.184 mW/g

Maximum value of SAR (measured) = 0.260 mW/g

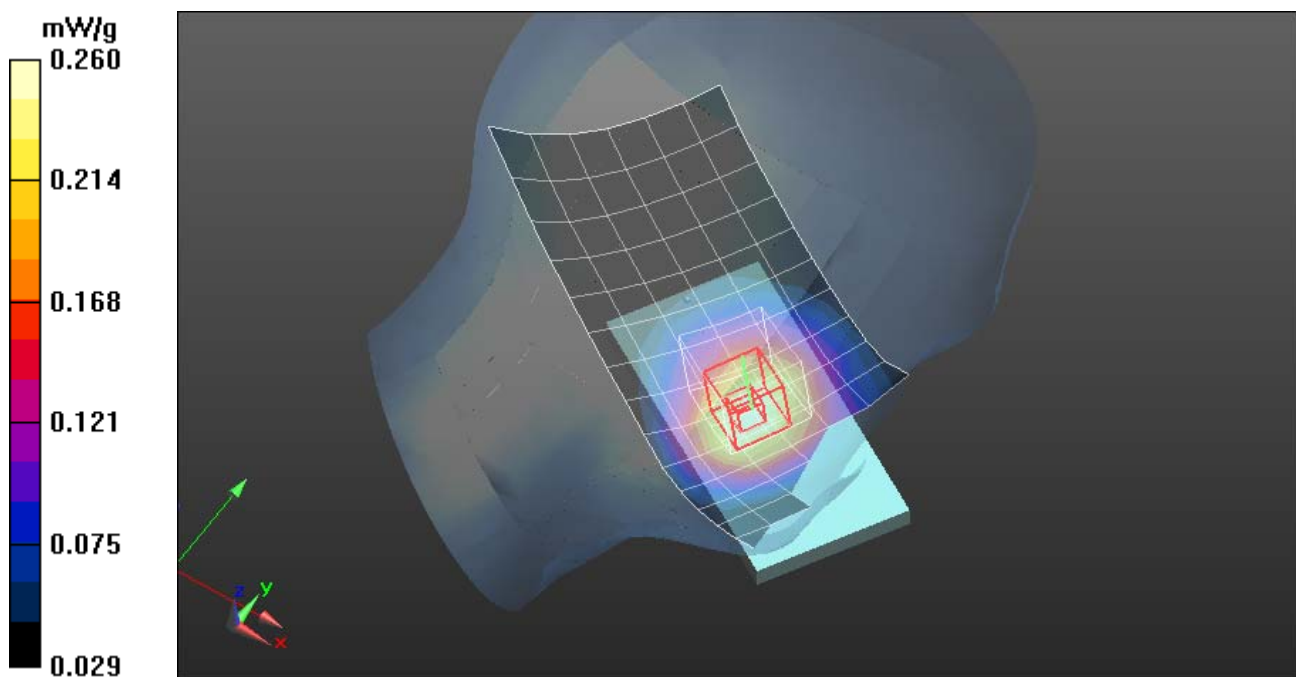

Date/Time: 7/6/2012 4:12:39 PM

Test Laboratory: Motorola - WCDMA1900 Cheek

Serial: LSJE260037; FCC ID: IHDT56NS8

Procedure Notes: Pwr Step: All up Antenna Position: internal; Battery Model #: internal
DEVICE POSITION: cheek

Communication System: _WCDMA; Frequency: 1852.4 MHz;

Communication System Channel Number: 9262; Duty Cycle: 1:1

Medium: Regular Glycol Head 1750/1880;

Medium parameters used: $f = 1880$ MHz; $\sigma = 1.47$ mho/m; $\epsilon_r = 39$; $\rho = 1000$ kg/m³

DASY4 Configuration:

- Probe: ES3DV3 - SN3180; ConvF(5.2, 5.2, 5.2); Calibrated: 1/11/2012
- Sensor-Surface: 4mm (Mechanical Surface Detection)
- Electronics: DAE4 Sn1313; Calibrated: 1/20/2012
- Phantom: R12_Glycol SAM (extended range), Rev.2 (24-Feb-12); Type: SAM v4.0; Serial: TP-1684;
- ; SEMCAD X Version 14.6.4 (4989)

DASY5, SAM - Phone against Left Head Template, Rev.3 (29-Sept-11)/Left Head Template/Area Scan - Normal (15mm) (7x17x1): Measurement grid: dx=15mm, dy=15mm
Maximum value of SAR (measured) = 1.384 mW/g

DASY5, SAM - Phone against Left Head Template, Rev.3 (29-Sept-11)/Left Head Template/5x5x7 Zoom Scan (<=3GHz) (5x5x7)/Cube 0: Measurement grid: dx=8mm, dy=8mm, dz=5mm

Reference Value = 29.138 V/m; Power Drift = -0.04 dB

Peak SAR (extrapolated) = 2.1790

SAR(1 g) = 1.38 mW/g; SAR(10 g) = 0.825 mW/g

Maximum value of SAR (measured) = 1.499 mW/g

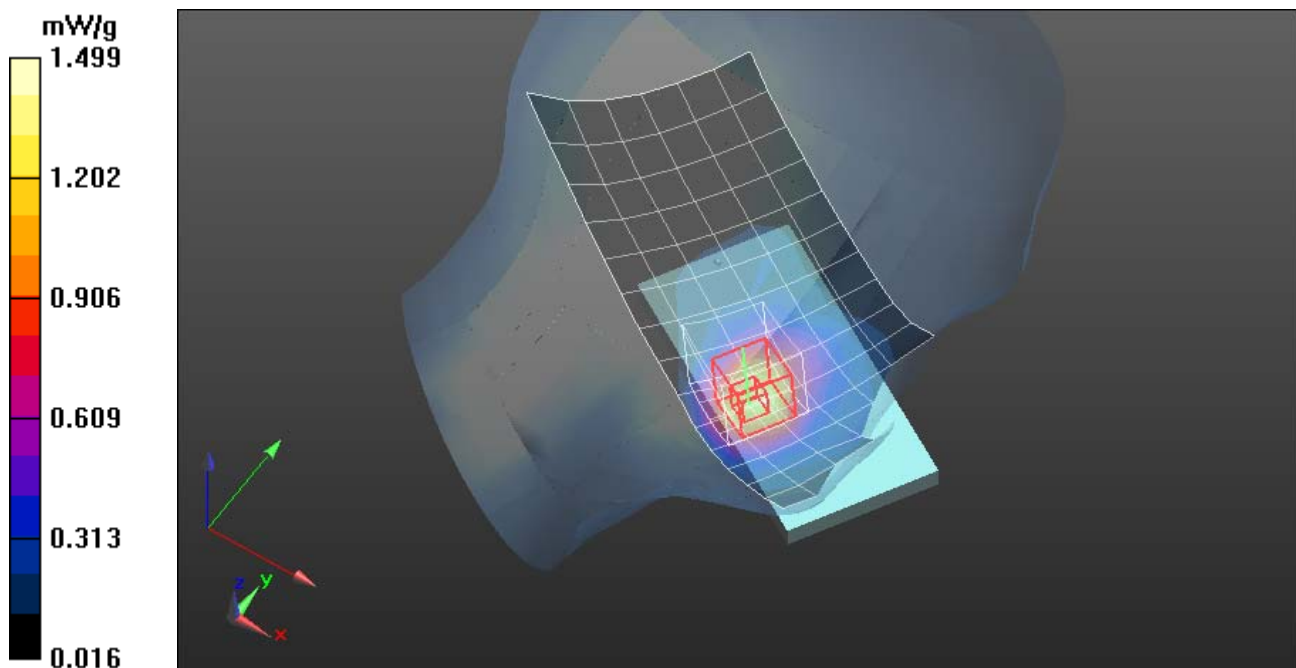

Date/Time: 7/17/2012 4:32:29 PM

Test Laboratory: Motorola - WiFi2450 Cheek

Serial: LSJE260037; FCC ID:IHDT56NS8

Procedure Notes: Pwr Step:802.11b 5.5 Mbps; Antenna Position: internal; Battery Model #: internal
DEVICE POSITION: cheek

Communication System: _Wi-Fi 2450MHz; Frequency: 2462 MHz;

Communication System Channel Number: 11; Duty Cycle: 1:1

Medium: 2450 Diacetin Head;

Medium parameters used: $f = 2450$ MHz; $\sigma = 1.88$ mho/m; $\epsilon_r = 37.4$; $\rho = 1000$ kg/m³

DASY4 Configuration:

- Probe: ES3DV3 - SN3180; ConvF(4.51, 4.51, 4.51); Calibrated: 1/11/2012
- Sensor-Surface: 4mm (Mechanical Surface Detection)
- Electronics: DAE4 Sn1313; Calibrated: 1/20/2012
- Phantom: R12_Glycol SAM (extended range), Rev.2 (24-Feb-12); Type: SAM v4.0; Serial: TP-1684;
- ; SEMCAD X Version 14.6.4 (4989)

DASY5, SAM - Phone against RIGHT head template - Rev.2 (29-Sept-11)/Right Head Template/Area Scan - Normal (15mm) (7x17x1): Measurement grid: dx=15mm, dy=15mm

Maximum value of SAR (measured) = 0.517 mW/g

DASY5, SAM - Phone against RIGHT head template - Rev.2 (29-Sept-11)/Right Head Template/5x5x7 Zoom Scan (<=3GHz) (5x5x7)/Cube 0: Measurement grid:

dx=8mm, dy=8mm, dz=5mm

Reference Value = 8.465 V/m; Power Drift = 0.13 dB

Peak SAR (extrapolated) = 1.2600

SAR(1 g) = 0.504 mW/g; SAR(10 g) = 0.203 mW/g

Maximum value of SAR (measured) = 0.593 mW/g

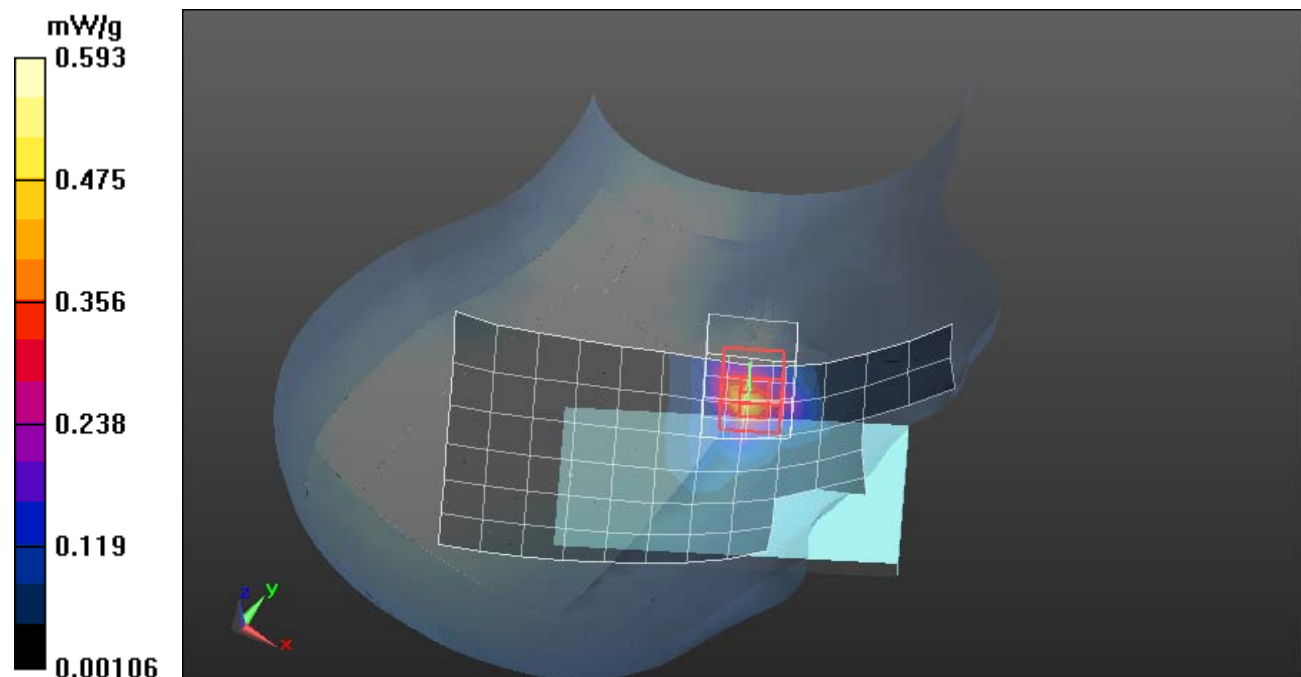

Date/Time: 7/3/2012 3:50:29 PM

Test Laboratory: Motorola - GSM850 Tilt

Serial: LSJE260037; FCC ID:IHDT56NS8

Procedure Notes: Pwr Step: 05 Antenna Position: inrernal; Battery Model #: inrernal;
DEVICE POSITION: tilted

Communication System: _GSM; Frequency: 836.6 MHz;

Communication System Channel Number: 190; Duty Cycle: 1:8.30042

Medium: Low Freq Head;

Medium parameters used: $f = 835$ MHz; $\sigma = 0.93$ mho/m; $\epsilon_r = 41.3$; $\rho = 1000$ kg/m³

DASY4 Configuration:

- Probe: ES3DV3 - SN3180; ConvF(6.07, 6.07, 6.07); Calibrated: 1/11/2012
- Sensor-Surface: 4mm (Mechanical Surface Detection)
- Electronics: DAE4 Sn1313; Calibrated: 1/20/2012
- Phantom: R12_ Sugar SAM (extended range), Rev.2 (24-Feb-12); Type: SAM v4.0; Serial: TP-1154;
- ; SEMCAD X Version 14.6.4 (4989)

DASY5, SAM - Phone against RIGHT head template - Rev.2 (29-Sept-11)/Right Head Template/Area Scan - Normal (15mm) (7x17x1):

Measurement grid: dx=15mm, dy=15mm

Maximum value of SAR (measured) = 0.116 mW/g

DASY5, SAM - Phone against RIGHT head template - Rev.2 (29-Sept-11)/Right Head Template/5x5x7 Zoom Scan (<=3GHz) (5x5x7)/Cube 0:

Measurement grid: dx=8mm, dy=8mm, dz=5mm

Reference Value = 11.312 V/m; Power Drift = -0.01 dB

Peak SAR (extrapolated) = 0.1360

SAR(1 g) = 0.112 mW/g; SAR(10 g) = 0.086 mW/g

Maximum value of SAR (measured) = 0.118 mW/g

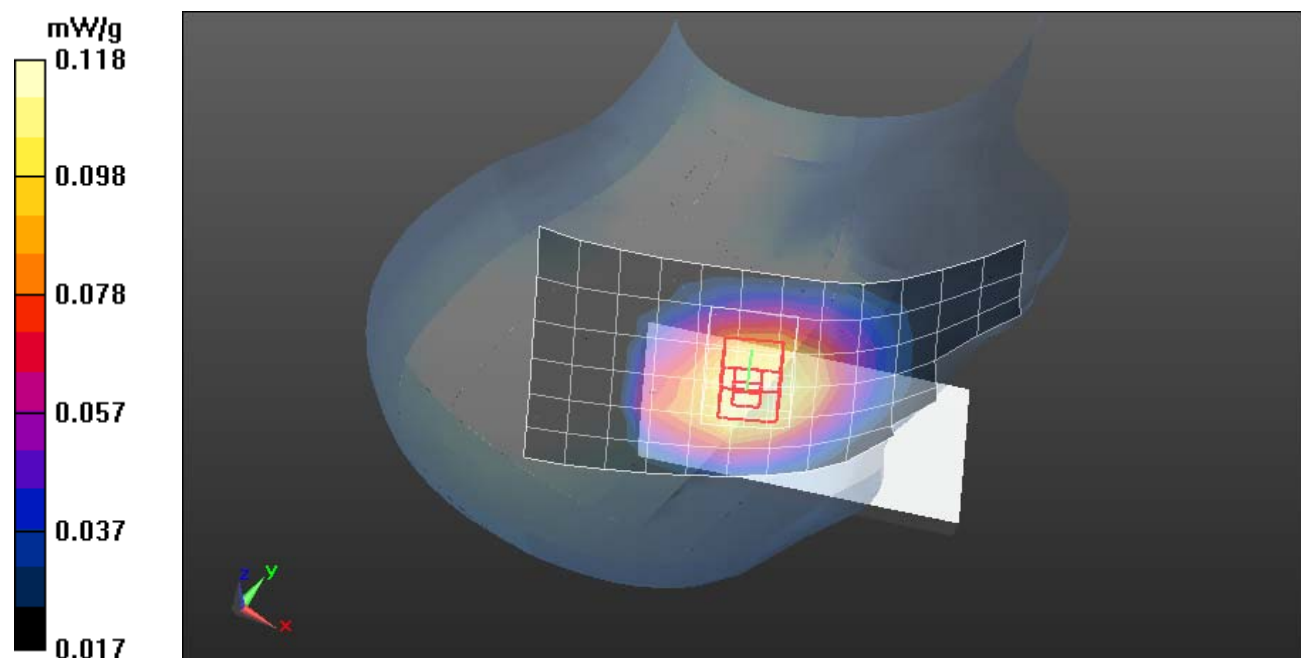

Date/Time: 7/6/2012 7:56:06 PM

Test Laboratory: Motorola - GSM1900 Tilt

Serial: LSJE260037; FCC ID: IHDT56NS8

Procedure Notes: Pwr Step:00 Antenna Position: internal; Battery Model #: internal

DEVICE POSITION (cheek or rotated): TILTED TESTER INITIALS: ZW

Communication System: GSM; Frequency: 1880 MHz;

Communication System Channel Number: 661; Duty Cycle: 1:8.30042

Medium: Regular Glycol Head 1750/1880;

Medium parameters used: $f = 1880$ MHz; $\sigma = 1.47$ mho/m; $\epsilon_r = 39$; $\rho = 1000$ kg/m³

DASY4 Configuration:

- Probe: ES3DV3 - SN3180; ConvF(5.2, 5.2, 5.2); Calibrated: 1/11/2012
- Sensor-Surface: 4mm (Mechanical Surface Detection)
- Electronics: DAE4 Sn1313; Calibrated: 1/20/2012
- Phantom: R12_Glycol SAM (extended range), Rev.2 (24-Feb-12); Type: SAM v4.0; Serial: TP-1684;
- ; SEMCAD X Version 14.6.4 (4989)

DASY5, SAM - Phone against RIGHT head template - Rev.2 (29-Sept-11)/Right Head Template/Area Scan - Normal (15mm) (7x17x1): Measurement grid: dx=15mm, dy=15mm

Maximum value of SAR (measured) = 0.355 mW/g

DASY5, SAM - Phone against RIGHT head template - Rev.2 (29-Sept-11)/Right Head Template/5x5x7 Zoom Scan (<=3GHz) (5x5x7)/Cube 0: Measurement grid:

dx=8mm, dy=8mm, dz=5mm

Reference Value = 15.369 V/m; Power Drift = 0.02 dB

Peak SAR (extrapolated) = 0.6280

SAR(1 g) = 0.376 mW/g; SAR(10 g) = 0.217 mW/g

Maximum value of SAR (measured) = 0.402 mW/g

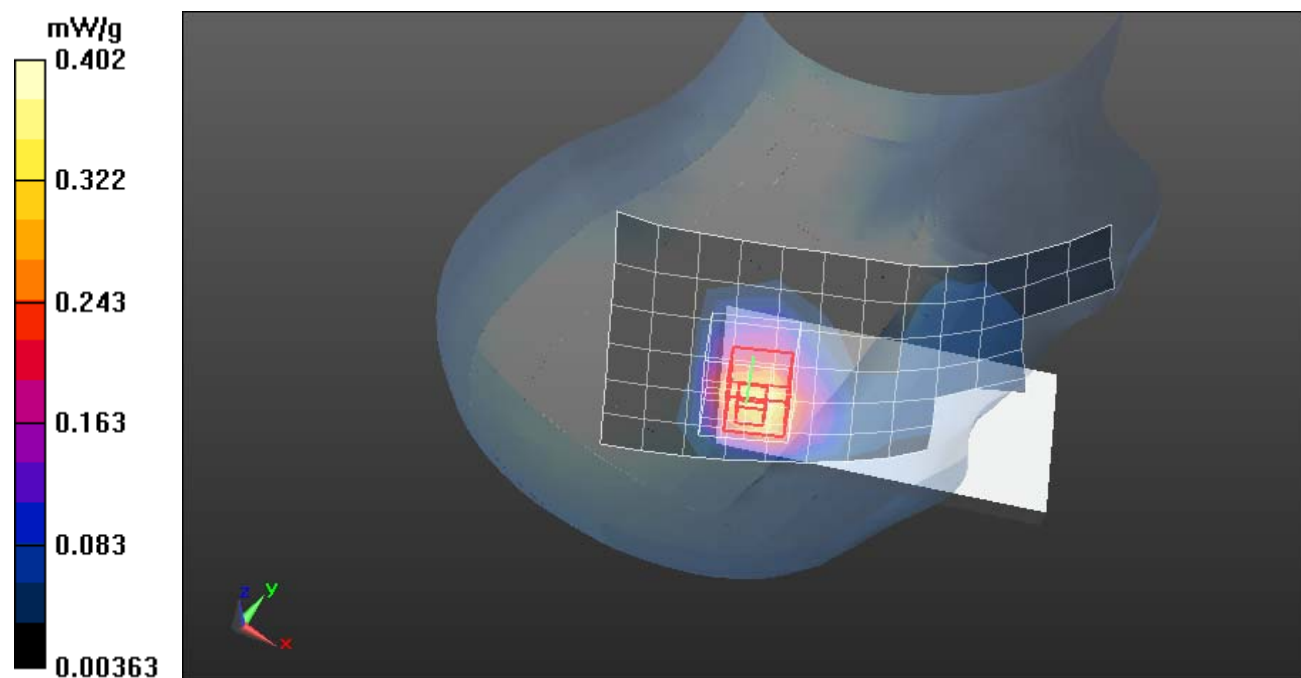

Date/Time: 7/2/2012 12:25:13 PM

Test Laboratory: Motorola - WCDMA800 Tilt

Serial: LSJE260037; FCC ID: IHDT56NS8

Procedure Notes: Pwr Step: All Up Antenna Position: internal; Battery Model #: internal

DEVICE POSITION: Tilted

Communication System: _WCDMA; Frequency: 836 MHz;

Communication System Channel Number: 4180; Duty Cycle: 1:1

Medium: Low Freq Head;

Medium parameters used: $f = 835$ MHz; $\sigma = 0.93$ mho/m; $\epsilon_r = 41.2$; $\rho = 1000$ kg/m³

DASY4 Configuration:

- Probe: ES3DV3 - SN3180; ConvF(6.07, 6.07, 6.07); Calibrated: 1/11/2012
- Sensor-Surface: 4mm (Mechanical Surface Detection)
- Electronics: DAE4 Sn1313; Calibrated: 1/20/2012
- Phantom: R12_Sugar SAM (extended range), Rev.2 (24-Feb-12); Type: SAM v4.0; Serial: TP-1154;
- ; SEMCAD X Version 14.6.4 (4989)

DASY5, SAM - Phone against Left Head Template, Rev.3 (29-Sept-11)/Left Head Template/Area Scan - Normal (15mm) (7x17x1): Measurement grid: dx=15mm, dy=15mm
Maximum value of SAR (measured) = 0.194 mW/g

DASY5, SAM - Phone against Left Head Template, Rev.3 (29-Sept-11)/Left Head Template/5x5x7 Zoom Scan (<=3GHz) (5x5x7)/Cube 0: Measurement grid: dx=8mm, dy=8mm, dz=5mm

Reference Value = 14.288 V/m; Power Drift = 0.16 dB

Peak SAR (extrapolated) = 0.2320

SAR(1 g) = 0.189 mW/g; SAR(10 g) = 0.144 mW/g

Maximum value of SAR (measured) = 0.200 mW/g

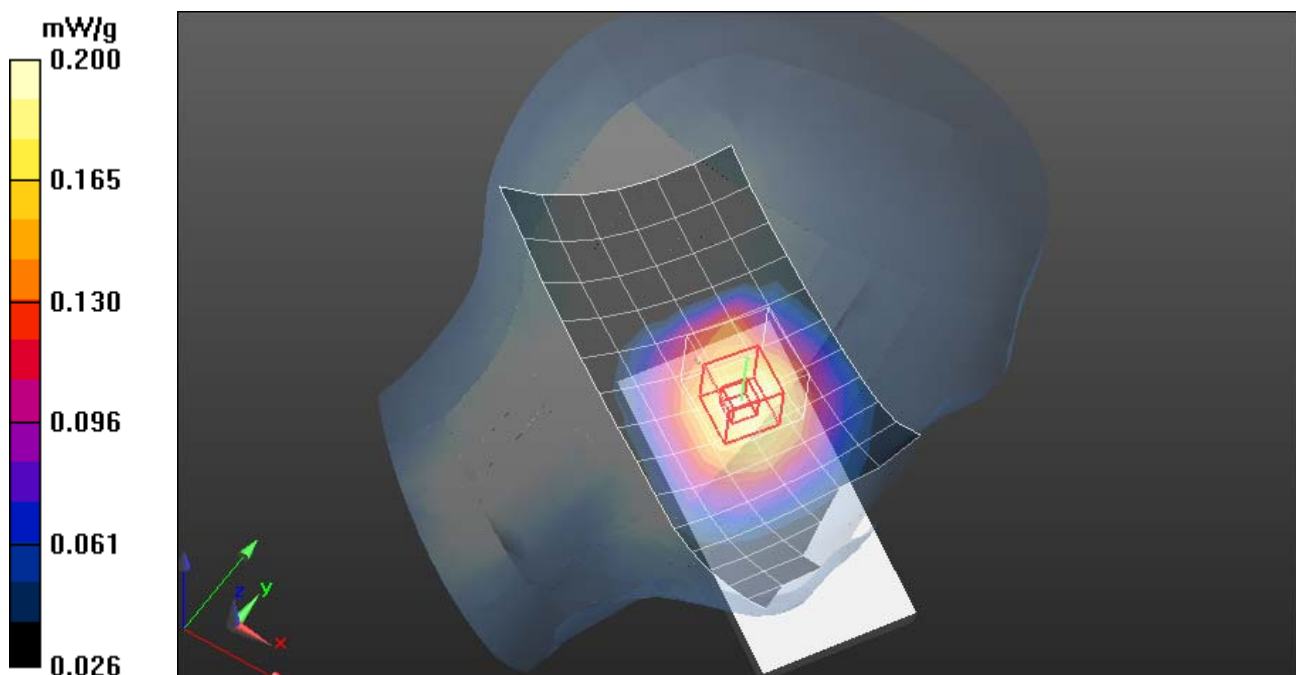

Date/Time: 7/6/2012 7:00:33 PM

Test Laboratory: Motorola - WCDMA1900 Tilt

Serial: LSJE260037; FCC ID:IHDT56NS8

Procedure Notes: Pwr Step:Alll Up Antenna Position: internal; Battery Model #: internal
DEVICE POSITION:TILTED

Communication System: _WCDMA; Frequency: 1880 MHz;

Communication System Channel Number: 9400; Duty Cycle: 1:1

Medium: Regular Glycol Head 1750/1880;

Medium parameters used: $f = 1880$ MHz; $\sigma = 1.47$ mho/m; $\epsilon_r = 39$; $\rho = 1000$ kg/m³

DASY4 Configuration:

- Probe: ES3DV3 - SN3180; ConvF(5.2, 5.2, 5.2); Calibrated: 1/11/2012
- Sensor-Surface: 4mm (Mechanical Surface Detection)
- Electronics: DAE4 Sn1313; Calibrated: 1/20/2012
- Phantom: R12_ Glycol SAM (extended range), Rev.2 (24-Feb-12); Type: SAM v4.0; Serial: TP-1684;
- ; SEMCAD X Version 14.6.4 (4989)

DASY5, SAM - Phone against RIGHT head template - Rev.2 (29-Sept-11)/Right Head Template/Area Scan - Normal (15mm) (7x17x1): Measurement grid: dx=15mm, dy=15mm

Maximum value of SAR (measured) = 0.657 mW/g

DASY5, SAM - Phone against RIGHT head template - Rev.2 (29-Sept-11)/Right Head Template/5x5x7 Zoom Scan (<=3GHz) (5x5x7)/Cube 0: Measurement grid: dx=8mm, dy=8mm, dz=5mm

Reference Value = 20.634 V/m; Power Drift = -0.06 dB

Peak SAR (extrapolated) = 1.0990

SAR(1 g) = 0.667 mW/g; SAR(10 g) = 0.390 mW/g

Maximum value of SAR (measured) = 0.708 mW/g

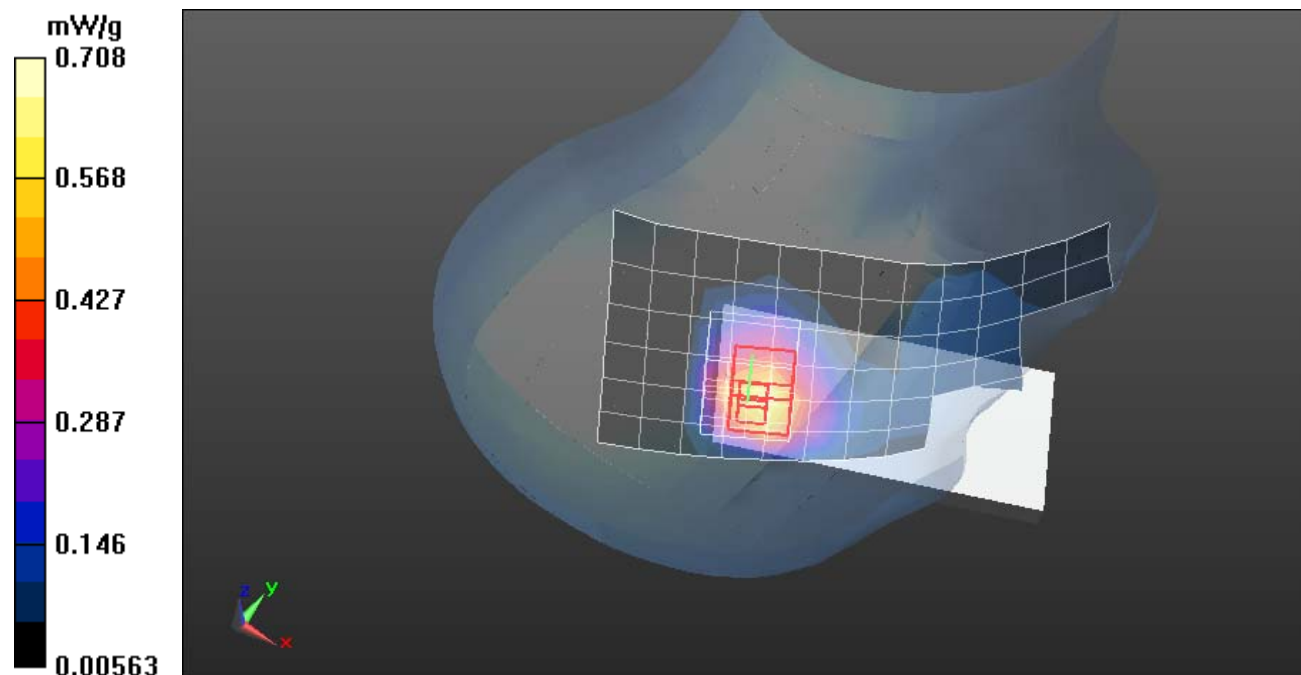

Date/Time: 7/17/2012 11:25:25 AM

Test Laboratory: Motorola - WiFi2450 Tilt

Serial: LSJE260037; FCC ID:IHDT56NS8

Procedure Notes: Pwr Step: 802.11b 1 Mbps; Antenna Position: internal; Battery Model #: internal
DEVICE POSITION: tilted

Communication System: _Wi-Fi 2450MHz; Frequency: 2462 MHz;

Communication System Channel Number: 11; Duty Cycle: 1:1

Medium: 2450 Diacetin Head;

Medium parameters used: $f = 2450$ MHz; $\sigma = 1.88$ mho/m; $\epsilon_r = 37.4$; $\rho = 1000$ kg/m³

DASY4 Configuration:

- Probe: ES3DV3 - SN3180; ConvF(4.51, 4.51, 4.51); Calibrated: 1/11/2012
- Sensor-Surface: 4mm (Mechanical Surface Detection)
- Electronics: DAE4 Sn1313; Calibrated: 1/20/2012
- Phantom: R12_Glycol SAM (extended range), Rev.2 (24-Feb-12); Type: SAM v4.0; Serial: TP-1684;
- ; SEMCAD X Version 14.6.4 (4989)

DASY5, SAM - Phone against Left Head Template, Rev.3 (29-Sept-11)/Left Head Template/Area Scan - Normal (15mm) (7x17x1): Measurement grid: dx=15mm, dy=15mm
Maximum value of SAR (measured) = 0.091 mW/g

DASY5, SAM - Phone against Left Head Template, Rev.3 (29-Sept-11)/Left Head Template/5x5x7 Zoom Scan (<=3GHz) (6x6x7)/Cube 0: Measurement grid: dx=8mm, dy=8mm, dz=5mm

Reference Value = 7.860 V/m; Power Drift = 0.10 dB

Peak SAR (extrapolated) = 0.1830

SAR(1 g) = 0.093 mW/g; SAR(10 g) = 0.045 mW/g

Maximum value of SAR (measured) = 0.106 mW/g

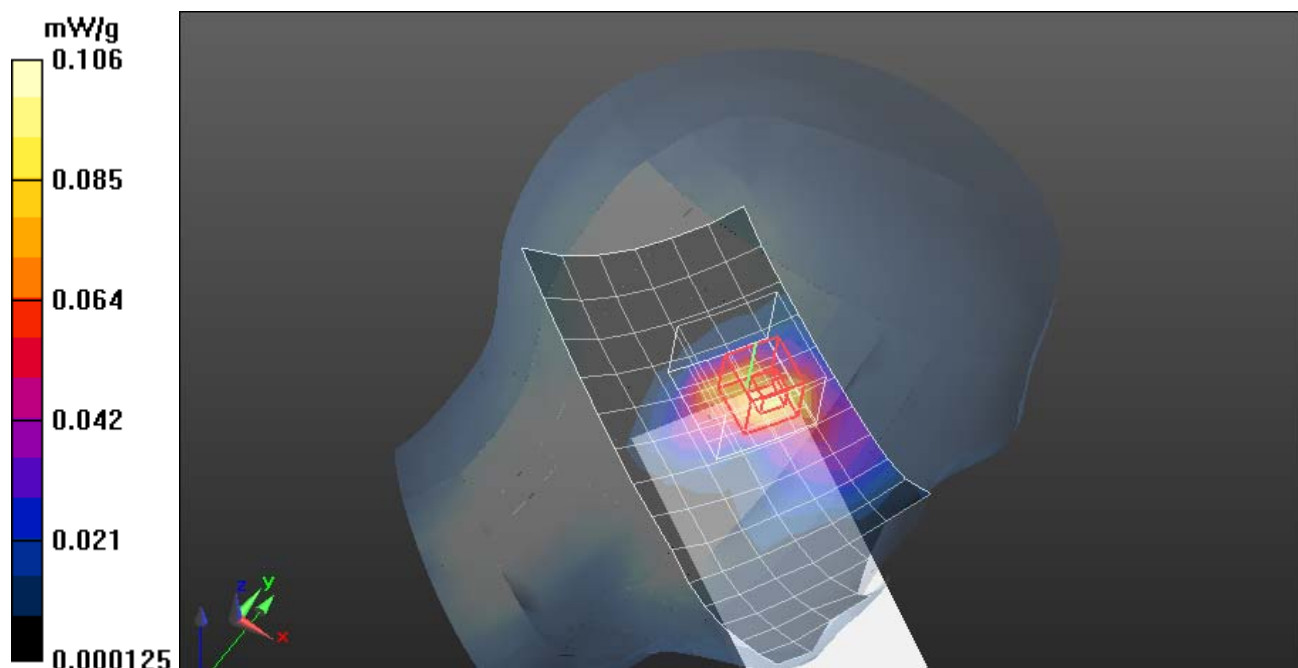

Appendix 3

SAR distribution plots for Body Worn Test Results

Date/Time: 7/5/2012 10:54:49 AM

Test Laboratory: Motorola - GPRS850 Body

Serial: LSJE260037; FCC ID:IHDT56NS8

Procedure Notes: Pwr Step: 05 Antenna Position: internal; Battery Model #: internal
 DEVICE POSITION: BODY WORN BACK OF PHONE 25MM FROM PHANTOM

Communication System: _GPRS Class 10; Frequency: 836.6 MHz;

Communication System Channel Number: 190; Duty Cycle: 1:4.14954

Medium: Low Freq Body;

Medium parameters used: $f = 835 \text{ MHz}$; $\sigma = 1 \text{ mho/m}$; $\epsilon_r = 53.6$; $\rho = 1000 \text{ kg/m}^3$

DASY4 Configuration:

- Probe: ES3DV3 - SN3180; ConvF(5.97, 5.97, 5.97); Calibrated: 1/11/2012
- Sensor-Surface: 4mm (Mechanical Surface Detection)
- Electronics: DAE4 Sn1313; Calibrated: 1/20/2012
- Phantom: R#-12, Triple Flat Phantom 5.1C (Rev.3); Type: QD 000 P51 CA; Serial: n/a;
- ; SEMCAD X Version 14.6.4 (4989)

DASY5, Triple Flat Phone Template - Rev.5 (6-April-12)/Triple Flat Phone Template/Area Scan - Normal Body (15mm) (14x8x1): Measurement grid: dx=15mm, dy=15mm

Maximum value of SAR (measured) = 0.399 mW/g

DASY5, Triple Flat Phone Template - Rev.5 (6-April-12)/Triple Flat Phone Template/5x5x7 Zoom Scan ($\leq 3\text{GHz}$) (5x5x7)/Cube 0: Measurement grid: dx=8mm, dy=8mm, dz=5mm

Reference Value = 19.830 V/m; Power Drift = 0.12 dB

Peak SAR (extrapolated) = 0.4980

SAR(1 g) = 0.392 mW/g; SAR(10 g) = 0.292 mW/g

Maximum value of SAR (measured) = 0.416 mW/g

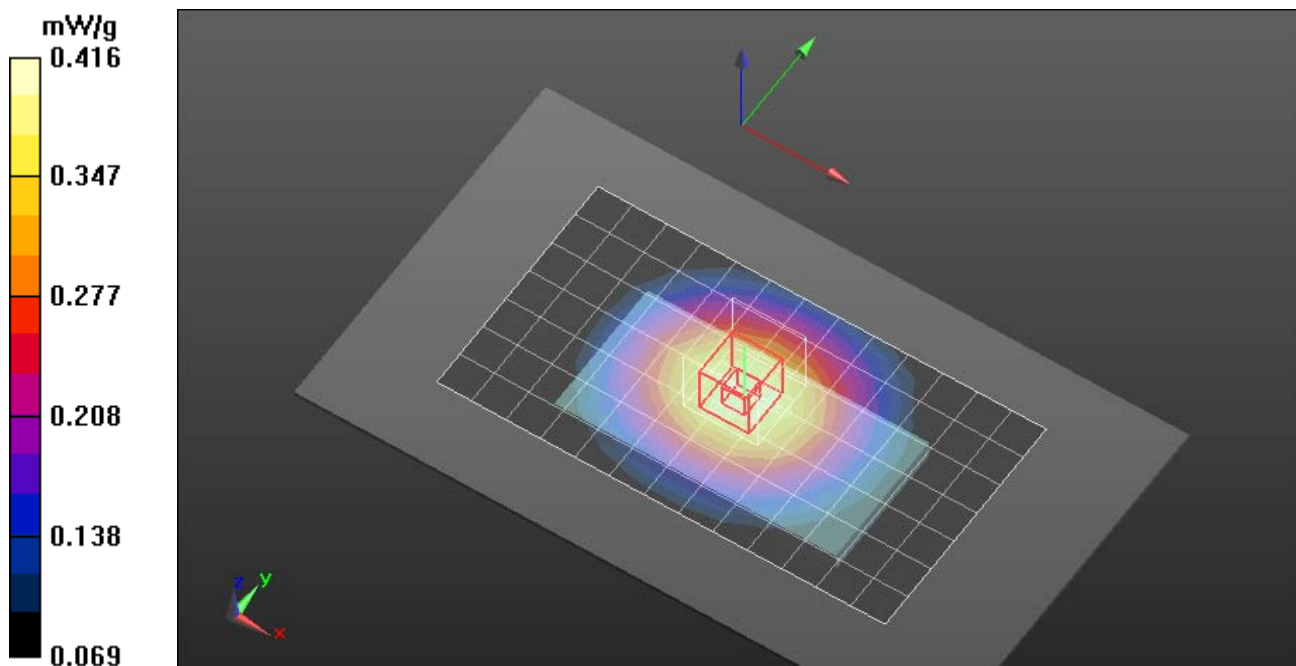

Date/Time: 7/7/2012 2:49:37 PM

Test Laboratory: Motorola - GPRS1900 Body

Serial: LSJE260037; FCC ID: IHDT56NS8

Procedure Notes: Pwr Step: 00 Antenna Position: internal; Battery Model #: internal

DEVICE POSITION: BACK OF PHONE 25MM FROM PHANTOM

Communication System: GPRS Class 10; Frequency: 1880 MHz;

Communication System Channel Number: 661; Duty Cycle: 1:4.14954

Medium: Regular Glycol Body 1750/1880;

Medium parameters used: $f = 1880$ MHz; $\sigma = 1.56$ mho/m; $\epsilon_r = 50.9$; $\rho = 1000$ kg/m³

DASY4 Configuration:

- Probe: ES3DV3 - SN3180; ConvF(5.09, 5.09, 5.09); Calibrated: 1/11/2012
- Sensor-Surface: 4mm (Mechanical Surface Detection)
- Electronics: DAE4 Sn1313; Calibrated: 1/20/2012
- Phantom: R#-12, Triple Flat Phantom 5.1C (Rev.3); Type: QD 000 P51 CA; Serial: n/a;
- ; SEMCAD X Version 14.6.4 (4989)

DASY5, Triple Flat Phone Template - Rev.5 (6-April-12)/Triple Flat Phone Template/Area Scan - Normal Body (15mm) (14x8x1): Measurement grid: dx=15mm, dy=15mm

Maximum value of SAR (measured) = 0.201 mW/g

DASY5, Triple Flat Phone Template - Rev.5 (6-April-12)/Triple Flat Phone Template/5x5x7 Zoom Scan (<=3GHz) (5x5x7)/Cube 0: Measurement grid: dx=8mm, dy=8mm, dz=5mm

Reference Value = 10.754 V/m; Power Drift = 0.02 dB

Peak SAR (extrapolated) = 0.2930

SAR(1 g) = 0.191 mW/g; SAR(10 g) = 0.117 mW/g

Maximum value of SAR (measured) = 0.208 mW/g

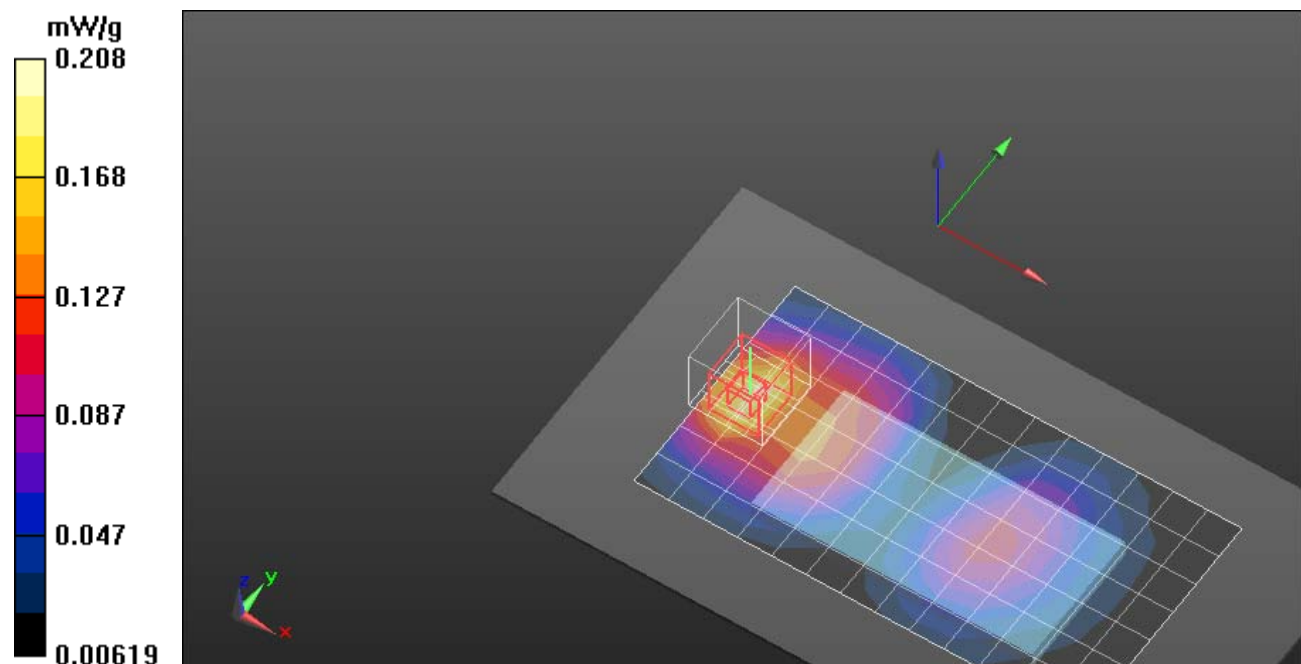

Date/Time: 7/5/2012 12:14:02 PM

Test Laboratory: Motorola - WCDMA800 Body

Serial: LSJE260037; FCC ID: IHDT56NS8

Procedure Notes: Pwr Step: All Up Antenna Position: internal; Battery Model #: internal

DEVICE POSITION: BACK OF PHONE 25MM FROM PHANTOM

Communication System: WCDMA; Frequency: 836 MHz;

Communication System Channel Number: 4180; Duty Cycle: 1:1

Medium: Low Freq Body;

Medium parameters used: $f = 835 \text{ MHz}$; $\sigma = 1 \text{ mho/m}$; $\epsilon_r = 53.6$; $\rho = 1000 \text{ kg/m}^3$

DASY4 Configuration:

- Probe: ES3DV3 - SN3180; ConvF(5.97, 5.97, 5.97); Calibrated: 1/11/2012
- Sensor-Surface: 4mm (Mechanical Surface Detection)
- Electronics: DAE4 Sn1313; Calibrated: 1/20/2012
- Phantom: R#-12, Triple Flat Phantom 5.1C (Rev.3); Type: QD 000 P51 CA; Serial: n/a;
- ; SEMCAD X Version 14.6.4 (4989)

DASY5, Triple Flat Phone Template - Rev.5 (6-April-12)/Triple Flat Phone Template/Area Scan - Normal Body (15mm) (14x8x1): Measurement grid: dx=15mm, dy=15mm

Maximum value of SAR (measured) = 0.260 mW/g

DASY5, Triple Flat Phone Template - Rev.5 (6-April-12)/Triple Flat Phone Template/5x5x7 Zoom Scan ($\leq 3\text{GHz}$) (5x5x7)/Cube 0: Measurement grid: dx=8mm, dy=8mm, dz=5mm

Reference Value = 16.224 V/m; Power Drift = -0.01 dB

Peak SAR (extrapolated) = 0.3210

SAR(1 g) = 0.253 mW/g; SAR(10 g) = 0.189 mW/g

Maximum value of SAR (measured) = 0.265 mW/g

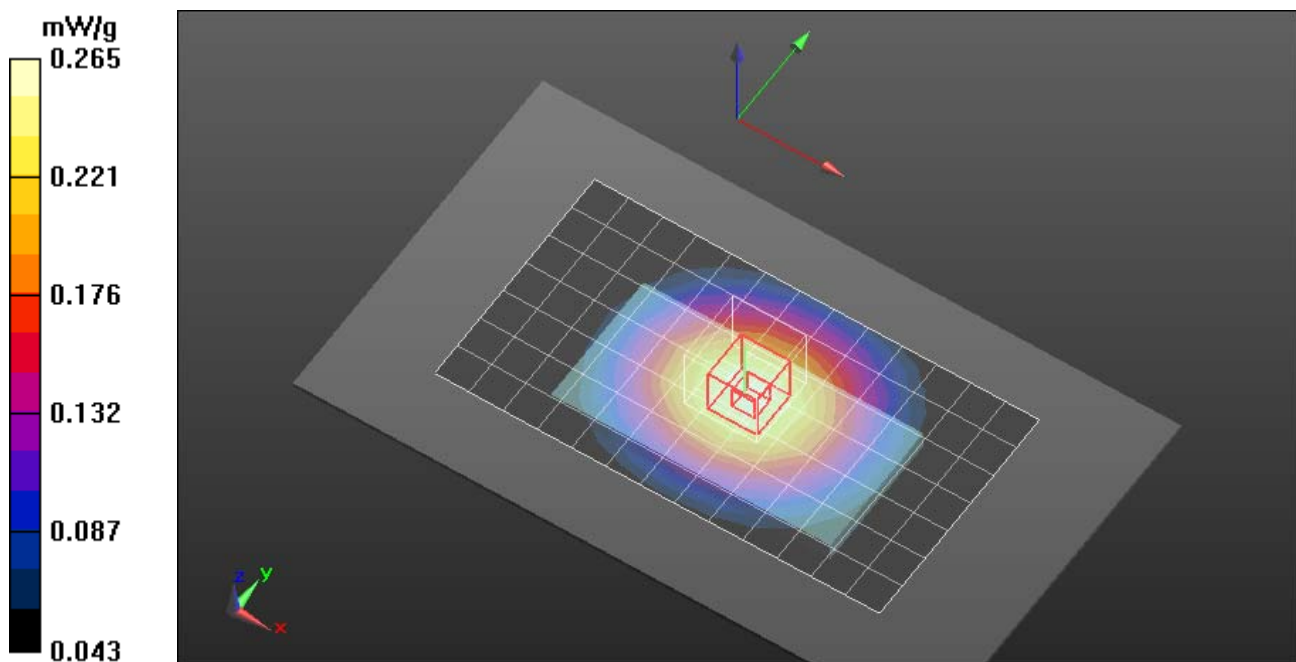

Date/Time: 7/7/2012 3:37:10 PM

Test Laboratory: Motorola - WCDMA1900 Body

Serial: LSJE260037; FCC ID: IHDT56NS8

Procedure Notes: Pwr Step: All up; Antenna Position: internal; Battery Model #: internal

DEVICE POSITION: BACK OF PHONE 25MM FROM PHANTOM

Communication System: _WCDMA; Frequency: 1880 MHz;

Communication System Channel Number: 9400; Duty Cycle: 1:1

Medium: Regular Glycol Body 1750/1880;

Medium parameters used: $f = 1880$ MHz; $\sigma = 1.56$ mho/m; $\epsilon_r = 50.9$; $\rho = 1000$ kg/m³

DASY4 Configuration:

- Probe: ES3DV3 - SN3180; ConvF(5.09, 5.09, 5.09); Calibrated: 1/11/2012
- Sensor-Surface: 4mm (Mechanical Surface Detection)
- Electronics: DAE4 Sn1313; Calibrated: 1/20/2012
- Phantom: R#-12, Triple Flat Phantom 5.1C (Rev.3); Type: QD 000 P51 CA; Serial: n/a;
- ; SEMCAD X Version 14.6.4 (4989)

DASY5, Triple Flat Phone Template - Rev.5 (6-April-12)/Triple Flat Phone Template/Area Scan - Normal Body (15mm) (14x8x1): Measurement grid: dx=15mm, dy=15mm

Maximum value of SAR (measured) = 0.222 mW/g

DASY5, Triple Flat Phone Template - Rev.5 (6-April-12)/Triple Flat Phone Template/5x5x7 Zoom Scan (<=3GHz) (5x5x7)/Cube 0: Measurement grid: dx=8mm, dy=8mm, dz=5mm

Reference Value = 12.762 V/m; Power Drift = 0.08 dB

Peak SAR (extrapolated) = 0.3490

SAR(1 g) = 0.226 mW/g; SAR(10 g) = 0.140 mW/g

Maximum value of SAR (measured) = 0.245 mW/g

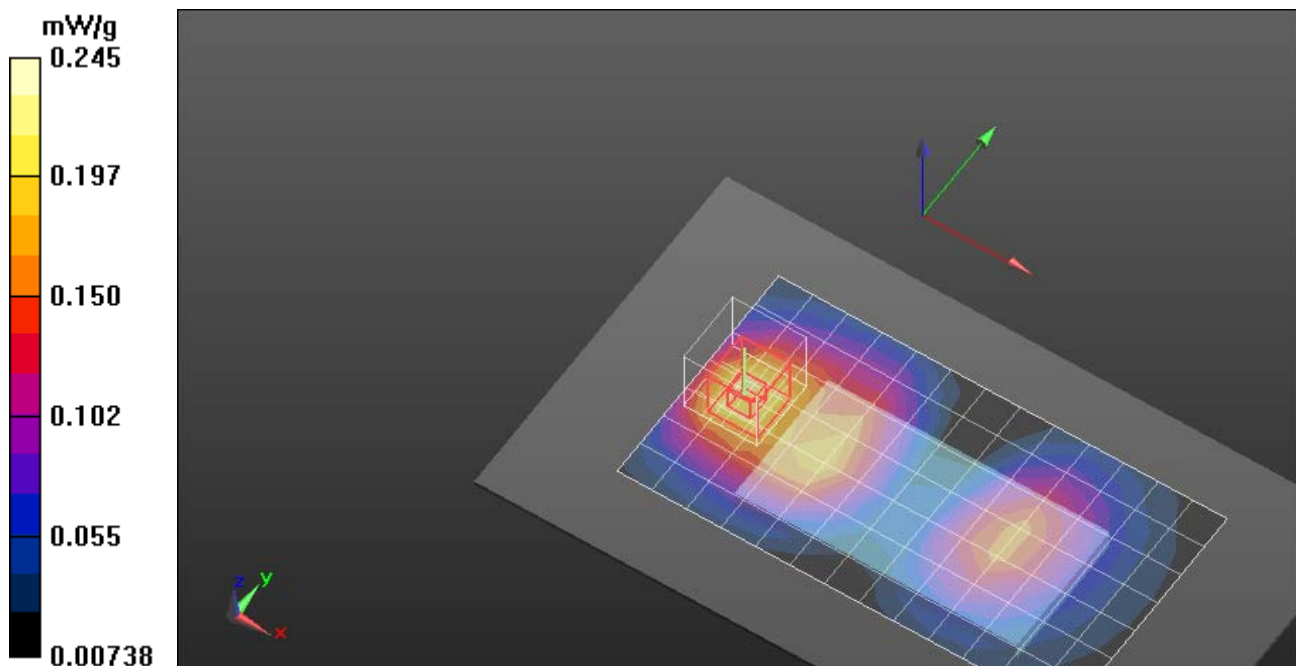

Date/Time: 7/19/2012 9:31:33 AM

Test Laboratory: Motorola - WiFi2450 Body

Serial: LSJE260037; FCC ID:IHDT56NS8

Procedure Notes: Pwr Step: 802.11b 5.5 Mbps; Antenna Position: internal; Battery Model #:internal
 DEVICE POSITION: BACK OF PHONE 25MM FROM PHONE

Communication System: _Wi-Fi 2450MHz; Frequency: 2462 MHz;

Communication System Channel Number: 11; Duty Cycle: 1:1

Medium: 2450 Diacetin Body;

Medium parameters used: $f = 2450$ MHz; $\sigma = 2.02$ mho/m; $\epsilon_r = 51.5$; $\rho = 1000$ kg/m³

DASY4 Configuration:

- Probe: ES3DV3 - SN3180; ConvF(4.46, 4.46, 4.46); Calibrated: 1/11/2012
- Sensor-Surface: 4mm (Mechanical Surface Detection)
- Electronics: DAE4 Sn1313; Calibrated: 1/20/2012
- Phantom: R#-12, Triple Flat Phantom 5.1C (Rev.3); Type: QD 000 P51 CA; Serial: n/a;
- ; SEMCAD X Version 14.6.4 (4989)

DASY5, Triple Flat Phone Template - Rev.5 (6-April-12)/Triple Flat Phone Template/Area Scan - Normal Body (15mm) (14x8x1): Measurement grid: dx=15mm, dy=15mm

Maximum value of SAR (measured) = 0.047 mW/g

DASY5, Triple Flat Phone Template - Rev.5 (6-April-12)/Triple Flat Phone Template/5x5x7 Zoom Scan (<=3GHz) (5x5x7)/Cube 0: Measurement grid: dx=8mm, dy=8mm, dz=5mm

Reference Value = 4.562 V/m; Power Drift = 0.18 dB

Peak SAR (extrapolated) = 0.0730

SAR(1 g) = 0.043 mW/g; SAR(10 g) = 0.025 mW/g

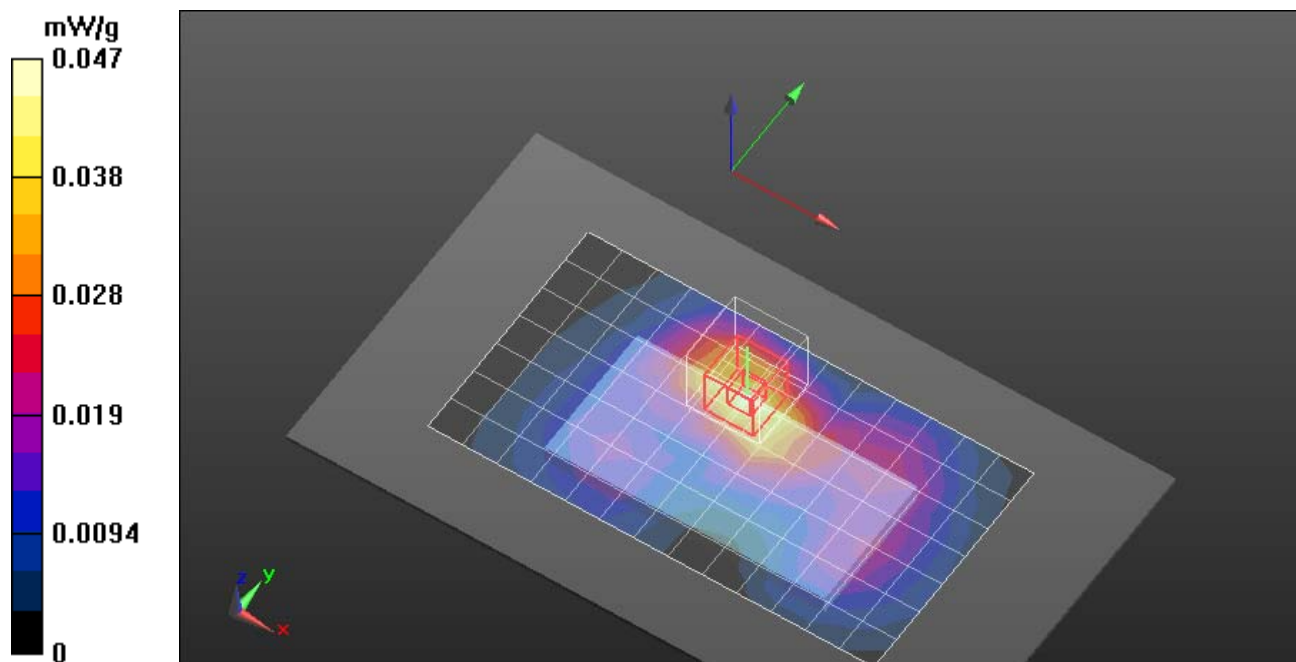

Appendix 4

SAR distribution plots for Mobile Hotspot Test Results

Date/Time: 7/5/2012 5:08:27 PM

Test Laboratory: Motorola - GPRS850 Hotspot Body back

Serial: LSJE260037; FCC ID:IHDT56NS8

Procedure Notes: Pwr Step:05 Antenna Position: internal; Battery Model #: internal

DEVICE POSITION: Back of Phone 10mm from Phantom

Communication System: GPRS Class 10; Frequency: 836.6 MHz;

Communication System Channel Number: 190; Duty Cycle: 1:4.14954

Medium: Low Freq Body;

Medium parameters used: $f = 835$ MHz; $\sigma = 1$ mho/m; $\epsilon_r = 53.6$; $\rho = 1000$ kg/m³

DASY4 Configuration:

- Probe: ES3DV3 - SN3180; ConvF(5.97, 5.97, 5.97); Calibrated: 1/11/2012
- Sensor-Surface: 4mm (Mechanical Surface Detection)
- Electronics: DAE4 Sn1313; Calibrated: 1/20/2012
- Phantom: R#-12, Triple Flat Phantom 5.1C (Rev.3); Type: QD 000 P51 CA; Serial: n/a;
- ; SEMCAD X Version 14.6.4 (4989)

DASY5, Triple Flat Phone Template - Rev.5 (6-April-12)/Triple Flat Phone Template/Area Scan - Normal Body (15mm) (14x8x1): Measurement grid: dx=15mm, dy=15mm

Maximum value of SAR (measured) = 0.425 mW/g

DASY5, Triple Flat Phone Template - Rev.5 (6-April-12)/Triple Flat Phone Template/5x5x7 Zoom Scan (<=3GHz) (5x5x7)/Cube 0: Measurement grid: dx=8mm, dy=8mm, dz=5mm

Reference Value = 20.768 V/m; Power Drift = 0.01 dB

Peak SAR (extrapolated) = 0.5110

SAR(1 g) = 0.409 mW/g; SAR(10 g) = 0.308 mW/g

Maximum value of SAR (measured) = 0.429 mW/g

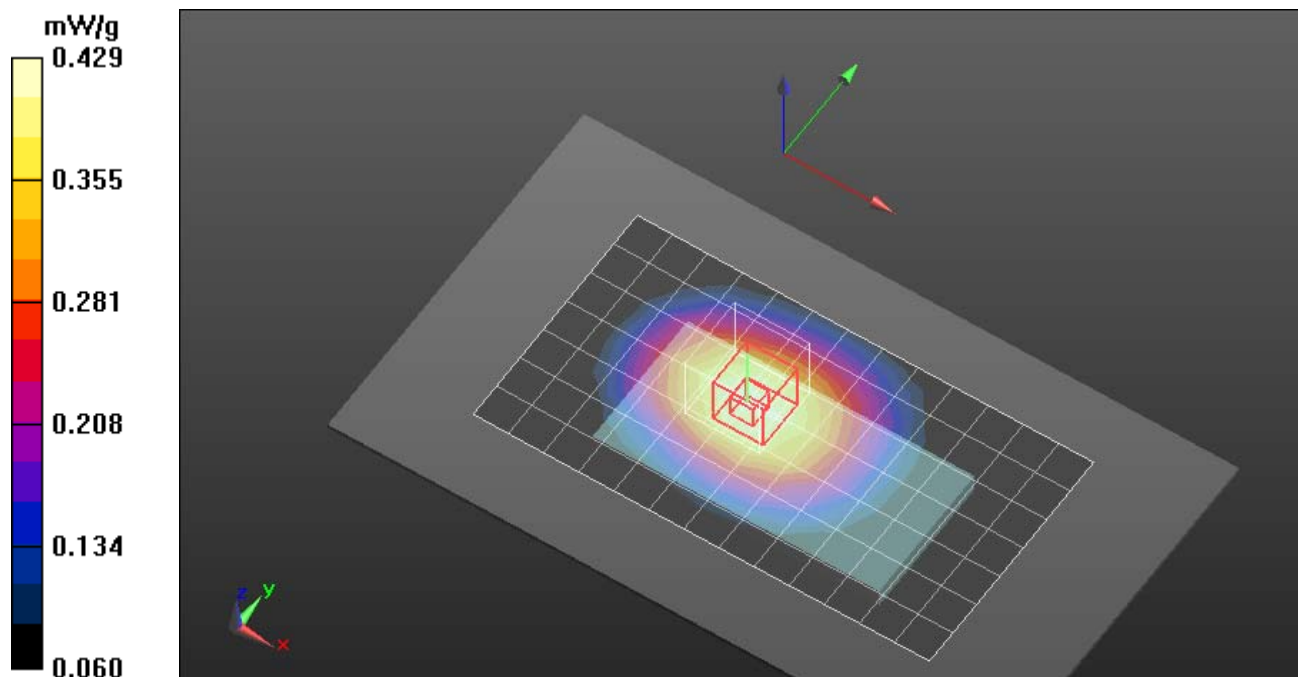

Date/Time: 7/11/2012 12:57:37 PM

Test Laboratory: Motorola - GPRS1900 Hotspot Bottom edge

Serial: LSJE260037; FCC ID:IHDT56NS8

Procedure Notes: Pwr Step: 00 Antenna Position: internal; Battery Model #: internal

DEVICE POSITION: Bottom Edge of Phone 10mm from Phantom

Communication System: _GPRS Class 10; Frequency: 1909.8 MHz;

Communication System Channel Number: 810; Duty Cycle: 1:4.14954

Medium: Regular Glycol Body 1750/1880;

Medium parameters used: $f = 1880$ MHz; $\sigma = 1.59$ mho/m; $\epsilon_r = 50.9$; $\rho = 1000$ kg/m³

DASY4 Configuration:

- Probe: ES3DV3 - SN3180; ConvF(5.09, 5.09, 5.09); Calibrated: 1/11/2012
- Sensor-Surface: 4mm (Mechanical Surface Detection)
- Electronics: DAE4 Sn1313; Calibrated: 1/20/2012
- Phantom: R#-12, Triple Flat Phantom 5.1C (Rev.3); Type: QD 000 P51 CA; Serial: n/a;
- ; SEMCAD X Version 14.6.4 (4989)

DASY5, Triple Flat Phone Template - Rev.5 (6-April-12)/Triple Flat Phone Template/Area Scan - Normal Body (15mm) (14x8x1): Measurement grid: dx=15mm, dy=15mm

Maximum value of SAR (measured) = 0.940 mW/g

DASY5, Triple Flat Phone Template - Rev.5 (6-April-12)/Triple Flat Phone Template/5x5x7 Zoom Scan (<=3GHz) (5x5x7)/Cube 0: Measurement grid: dx=8mm, dy=8mm, dz=5mm

Reference Value = 28.540 V/m; Power Drift = -0.06 dB

Peak SAR (extrapolated) = 2.5080

SAR(1 g) = 1.31 mW/g; SAR(10 g) = 0.614 mW/g

Maximum value of SAR (measured) = 1.467 mW/g

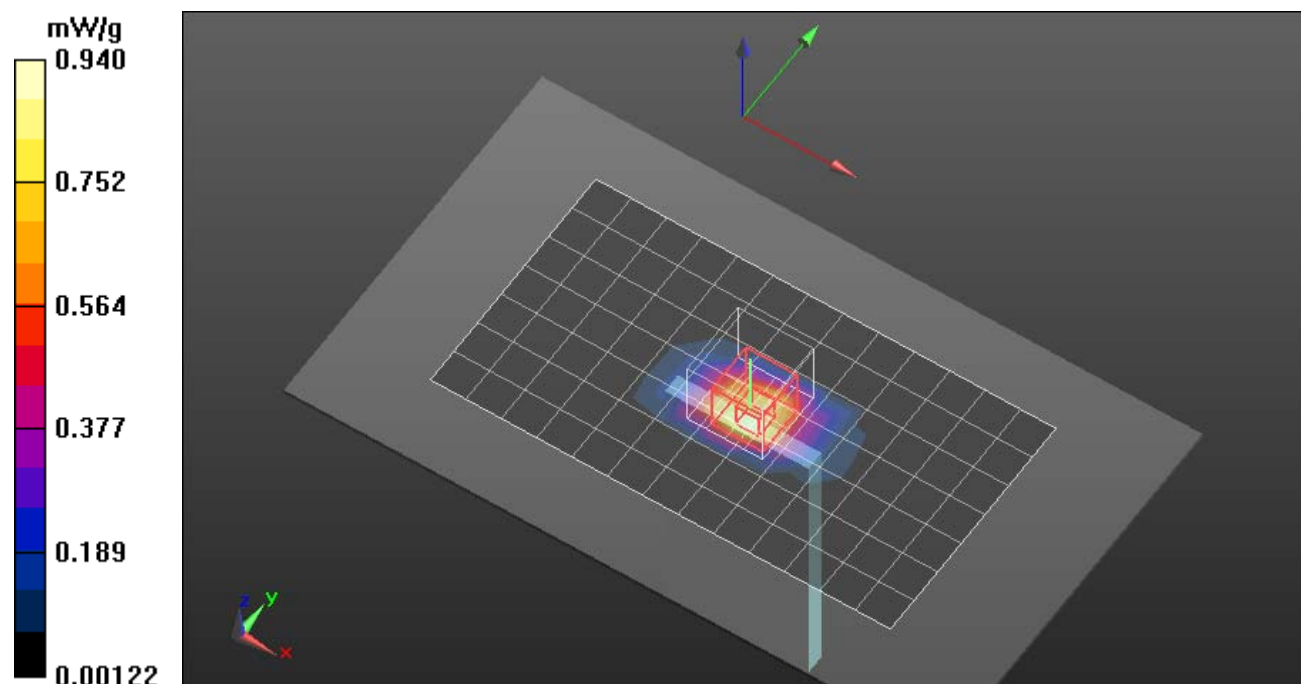

Date/Time: 7/6/2012 12:40:14 PM

Test Laboratory: Motorola - WCDMA800 Hotspot Body back

Serial: LSJE260037; FCC ID: IHDT56NS8

Procedure Notes: Pwr Step: All Up Antenna Position: internal; Battery Model #: internal

DEVICE POSITION: Back of Phone 10mm from Phantom

Communication System: WCDMA; Frequency: 836 MHz;

Communication System Channel Number: 4180; Duty Cycle: 1:1

Medium: Low Freq Body;

Medium parameters used: $f = 835$ MHz; $\sigma = 0.99$ mho/m; $\epsilon_r = 53.4$; $\rho = 1000$ kg/m³

DASY4 Configuration:

- Probe: ES3DV3 - SN3180; ConvF(5.97, 5.97, 5.97); Calibrated: 1/11/2012
- Sensor-Surface: 4mm (Mechanical Surface Detection)
- Electronics: DAE4 Sn1313; Calibrated: 1/20/2012
- Phantom: R#-12, Triple Flat Phantom 5.1C (Rev.3); Type: QD 000 P51 CA; Serial: n/a;
- ; SEMCAD X Version 14.6.4 (4989)

DASY5, Triple Flat Phone Template - Rev.5 (6-April-12)/Triple Flat Phone Template/Area Scan - Normal Body (15mm) (14x8x1): Measurement grid: dx=15mm, dy=15mm

Maximum value of SAR (measured) = 0.425 mW/g

DASY5, Triple Flat Phone Template - Rev.5 (6-April-12)/Triple Flat Phone Template/5x5x7 Zoom Scan (<=3GHz) (5x5x7)/Cube 0: Measurement grid: dx=8mm, dy=8mm, dz=5mm

Reference Value = 21.247 V/m; Power Drift = 0.009 dB

Peak SAR (extrapolated) = 0.5120

SAR(1 g) = 0.414 mW/g; SAR(10 g) = 0.312 mW/g

Maximum value of SAR (measured) = 0.434 mW/g

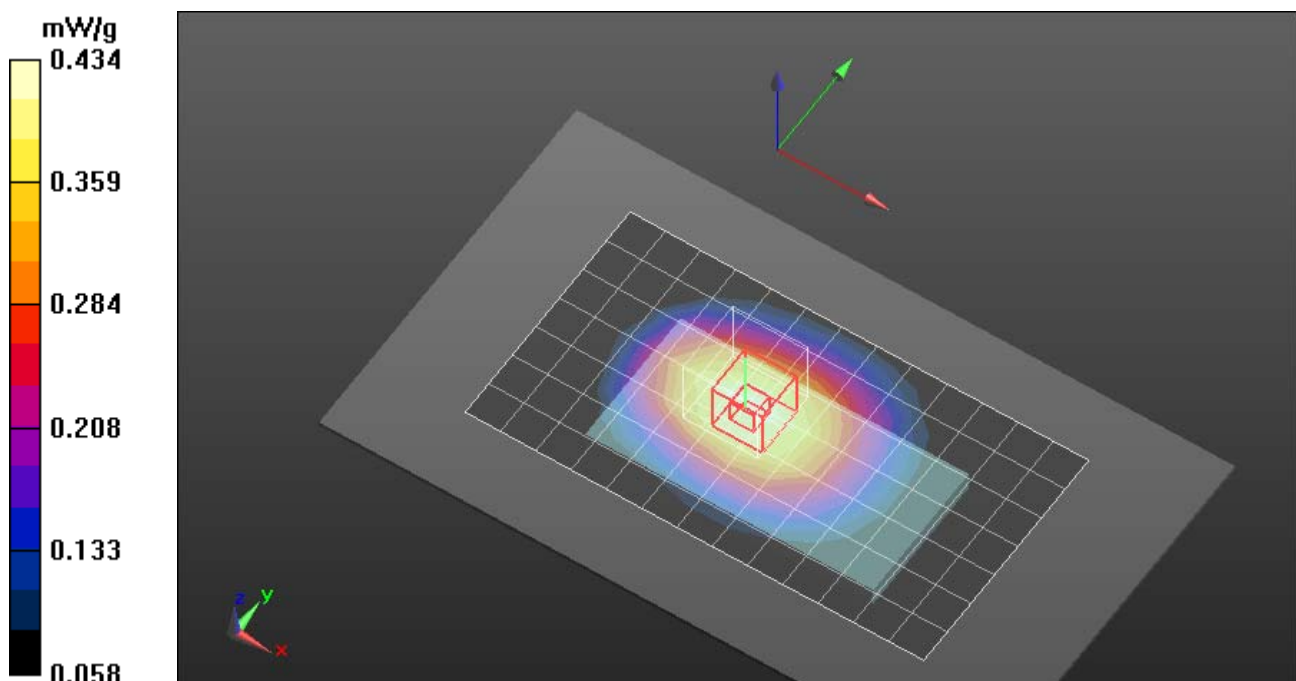

Date/Time: 7/7/2012 6:03:15 PM

Test Laboratory: Motorola - WCDMA1900 Hotspot Bottom edge

Serial: LSJE260037; FCC ID: IHDT56NS8

Procedure Notes: Pwr Step: All up Antenna Position: internal; Battery Model #: internal

DEVICE POSITION: Bottom Edge of Phone 10mm from Phantom

Communication System: WCDMA; Frequency: 1907.6 MHz;

Communication System Channel Number: 9538; Duty Cycle: 1:1

Medium: Regular Glycol Body 1750/1880;

Medium parameters used: $f = 1880$ MHz; $\sigma = 1.56$ mho/m; $\epsilon_r = 50.9$; $\rho = 1000$ kg/m³

DASY4 Configuration:

- Probe: ES3DV3 - SN3180; ConvF(5.09, 5.09, 5.09); Calibrated: 1/11/2012
- Sensor-Surface: 4mm (Mechanical Surface Detection)
- Electronics: DAE4 Sn1313; Calibrated: 1/20/2012
- Phantom: R#-12, Triple Flat Phantom 5.1C (Rev.3); Type: QD 000 P51 CA; Serial: n/a;
- ; SEMCAD X Version 14.6.4 (4989)

DASY5, Triple Flat Phone Template - Rev.5 (6-April-12)/Triple Flat Phone Template/Area Scan - Normal Body (15mm) (14x8x1): Measurement grid: dx=15mm, dy=15mm

Maximum value of SAR (measured) = 1.525 mW/g

DASY5, Triple Flat Phone Template - Rev.5 (6-April-12)/Triple Flat Phone Template/5x5x7 Zoom Scan (<=3GHz) (5x5x7)/Cube 0: Measurement grid: dx=8mm, dy=8mm, dz=5mm

Reference Value = 22.476 V/m; Power Drift = -0.03 dB

Peak SAR (extrapolated) = 2.6430

SAR(1 g) = 1.39 mW/g; SAR(10 g) = 0.656 mW/g

Maximum value of SAR (measured) = 1.618 mW/g

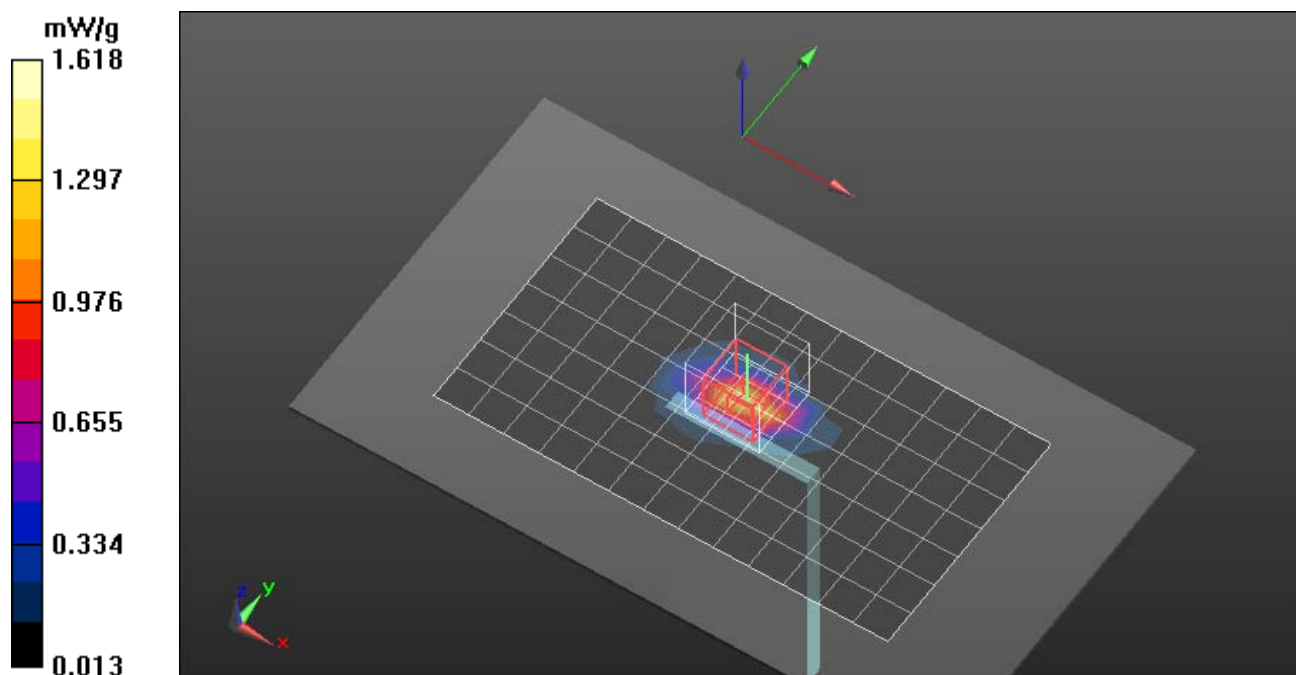

Date/Time: 7/19/2012 3:02:21 PM

Test Laboratory: Motorola - WiFi2450 Hotspot back

Serial: LSJE260037; FCC ID:IHDT56NS8

Procedure Notes: Pwr Step: 802.11b, 1 Mbps; Antenna Position: internal; Battery Model #:internal

DEVICE POSITION: Back of Phone 10mm from Phantom

Communication System: _Wi-Fi 2450MHz; Frequency: 2462 MHz;

Communication System Channel Number: 11; Duty Cycle: 1:1

Medium: 2450 Diacetin Body;

Medium parameters used: $f = 2450$ MHz; $\sigma = 2.02$ mho/m; $\epsilon_r = 51.5$; $\rho = 1000$ kg/m³

DASY4 Configuration:

- Probe: ES3DV3 - SN3180; ConvF(4.46, 4.46, 4.46); Calibrated: 1/11/2012
- Sensor-Surface: 4mm (Mechanical Surface Detection)
- Electronics: DAE4 Sn1313; Calibrated: 1/20/2012
- Phantom: R#-12, Triple Flat Phantom 5.1C (Rev.3); Type: QD 000 P51 CA; Serial: n/a;
- ; SEMCAD X Version 14.6.4 (4989)

DASY5, Triple Flat Phone Template - Rev.5 (6-April-12)/Triple Flat Phone Template/Area Scan - Normal Body (15mm) (14x8x1): Measurement grid: dx=15mm, dy=15mm

Maximum value of SAR (measured) = 0.304 mW/g

DASY5, Triple Flat Phone Template - Rev.5 (6-April-12)/Triple Flat Phone Template/5x5x7 Zoom Scan (<=3GHz) (5x5x7)/Cube 0: Measurement grid: dx=8mm, dy=8mm, dz=5mm

Reference Value = 10.852 V/m; Power Drift = 0.42 dB

Peak SAR (extrapolated) = 0.6560

SAR(1 g) = 0.326 mW/g; SAR(10 g) = 0.164 mW/g

Maximum value of SAR (measured) = 0.361 mW/g

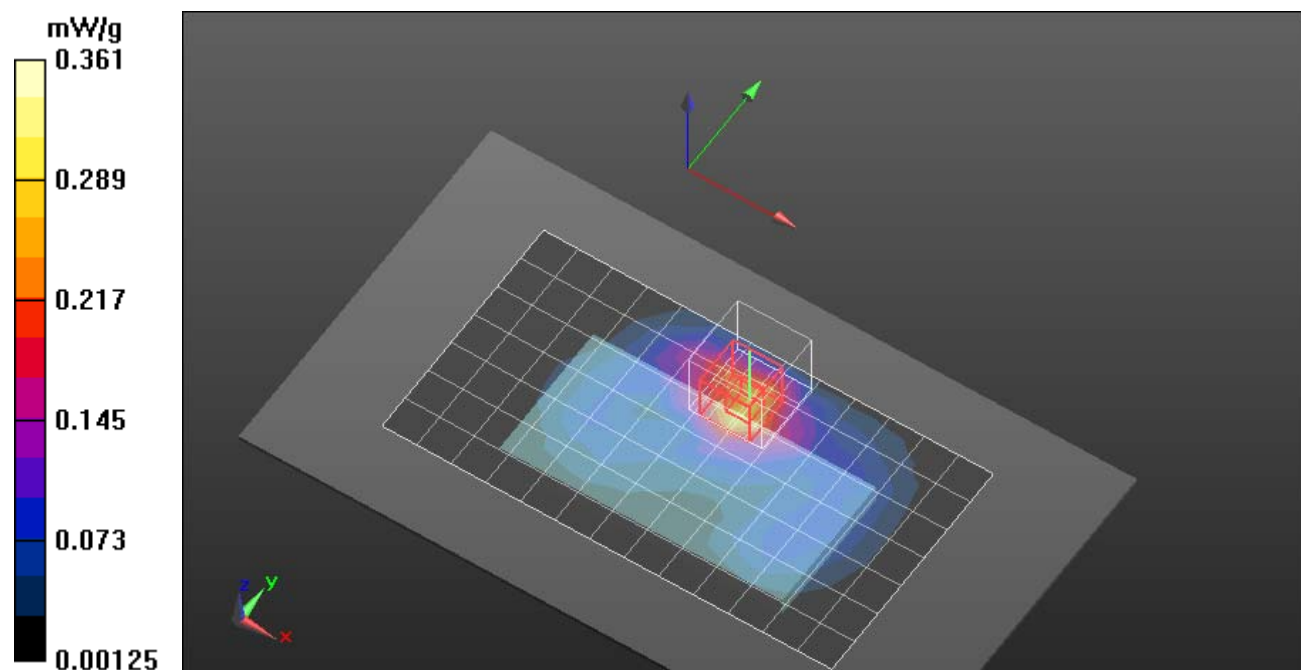

Appendix 5

Measurement Uncertainty Budget

Uncertainty Budget for Device Under Test, for 735 MHz to 3 GHz

<i>a</i>	<i>b</i>	<i>c</i>	<i>d</i>	<i>e = f(d,k)</i>	<i>f</i>	<i>g</i>	<i>h = c x f / e</i>	<i>i = c x g / e</i>	<i>k</i>
Uncertainty Component	Description IEEE1528(2003) / IEC62209-1(2005)	Tol. (± %)	Prob Dist	Div.	<i>c_i</i> (1 g)	<i>c_i</i> (10 g)	1 g <i>u_i</i> (±%)	10 g <i>u_i</i> (±%)	<i>v_i</i>
Measurement System									
Probe Calibration [ES3DV3]	E.2.1 / 7.2.1	6.0	N	1.00	1	1	6.0	6.0	∞
Axial Isotropy	E.2.2 / 7.2.1.2	4.7	R	1.73	0.707	0.707	1.9	1.9	∞
Hemispherical Isotropy	E.2.2 / 7.2.1.2	9.6	R	1.73	0.707	0.707	3.9	3.9	∞
Boundary Effect	E.2.3 / 7.2.1.5	1.0	R	1.73	1	1	0.6	0.6	∞
Linearity	E.2.4 / 7.2.1.3	4.7	R	1.73	1	1	2.7	2.7	∞
System Detection Limits	E.2.5 / 7.2.1.4	1.0	R	1.73	1	1	0.6	0.6	∞
Readout Electronics	E.2.6 / 7.2.1.6	0.3	N	1.00	1	1	0.3	0.3	∞
Response Time	E.2.7 / 7.2.1.7	1.1	R	1.73	1	1	0.6	0.6	∞
Integration Time	E.2.8 / 7.2.1.8	1.1	R	1.73	1	1	0.6	0.6	∞
RF Ambient Conditions - Noise	E.6.1 / 7.2.3.6	3.0	R	1.73	1	1	1.7	1.7	∞
RF Ambient Conditions - Reflections	E.6.1 / 7.2.3.6	3.0	R	1.73	1	1	1.7	1.7	∞
Probe Positioner Mech. Tolerance	E.6.2 / 7.2.2.1	0.4	R	1.73	1	1	0.2	0.2	∞
Probe Positioning w.r.t Phantom	E.6.3 / 7.2.2.3	1.4	R	1.73	1	1	0.8	0.8	∞
Max. SAR Evaluation (ext., int., avg.)	E.5 / 7.2.4	3.4	R	1.73	1	1	2.0	2.0	∞
Test sample Related									
Test Sample Positioning	E.4.2 / 7.2.2.4	3.4	N	1.00	1	1	3.4	3.4	79
Device Holder Uncertainty	E.4.1 / 7.2.2.4.2	4.5	N	1.00	1	1	4.5	4.5	11
SAR drift	6.6.2 / 7.2.3.5	0.0	R	1.73	1	1	0.0	0.0	∞
Phantom and Tissue Parameters									
Phantom Uncertainty	E.3.1 / 7.2.2.2	4.0	R	1.73	1	1	2.3	2.3	∞
Liquid Conductivity (target)	E.3.2 / 7.2.3.3	5.0	R	1.73	0.64	0.43	1.8	1.2	∞
Liquid Conductivity (measurement)	E.3.3 / 7.2.3.3	2.5	N	1.00	0.64	0.43	1.6	1.1	6
Liquid Permittivity (target)	E.3.2 / 7.2.3.4	5.0	R	1.73	0.6	0.49	1.7	1.4	∞
Liquid Permittivity (measurement)	E.3.2 / 7.2.3.4	2.3	N	1.00	0.6	0.49	1.4	1.1	6
Combined Standard Uncertainty			RSS				11	11	372
Expanded Uncertainty (95% CONFIDENCE LEVEL)			<i>k</i> =2				22	22	

Appendix 6

Probe Calibration Certificate



Accredited by the Swiss Accreditation Service (SAS)
The Swiss Accreditation Service is one of the signatories to the EA
Multilateral Agreement for the recognition of calibration certificates

Accreditation No.: **SCS 108**

Client **Motorola Beijing**

Certificate No: **ES3-3180_Jan12**

CALIBRATION CERTIFICATE

Object **ES3DV3 - SN:3180**

Calibration procedure(s) **QA CAL-01.v8, QA CAL-23.v4, QA CAL-25.v4
Calibration procedure for dosimetric E-field probes**

Calibration date: **January 11, 2012**

This calibration certificate documents the traceability to national standards, which realize the physical units of measurements (SI).
The measurements and the uncertainties with confidence probability are given on the following pages and are part of the certificate.

All calibrations have been conducted in the closed laboratory facility: environment temperature (22 ± 3)°C and humidity < 70%.

Calibration Equipment used (M&TE critical for calibration)

Primary Standards	ID	Cal Date (Certificate No.)	Scheduled Calibration
Power meter E4419B	GB41293874	31-Mar-11 (No. 217-01372)	Apr-12
Power sensor E4412A	MY41498087	31-Mar-11 (No. 217-01372)	Apr-12
Reference 3 dB Attenuator	SN: S5054 (3c)	29-Mar-11 (No. 217-01369)	Apr-12
Reference 20 dB Attenuator	SN: S5086 (20b)	29-Mar-11 (No. 217-01367)	Apr-12
Reference 30 dB Attenuator	SN: S5129 (30b)	29-Mar-11 (No. 217-01370)	Apr-12
Reference Probe ES3DV2	SN: 3013	29-Dec-11 (No. ES3-3013_Dec11)	Dec-12
DAE4	SN: 654	3-May-11 (No. DAE4-654_May11)	May-12
Secondary Standards	ID	Check Date (in house)	Scheduled Check
RF generator HP 8648C	US3642U01700	4-Aug-99 (in house check Apr-11)	In house check: Apr-13
Network Analyzer HP 8753E	US37390585	18-Oct-01 (in house check Oct-11)	In house check: Oct-12

	Name	Function	Signature
Calibrated by:	Jeton Kastrati	Laboratory Technician	
Approved by:	Katja Pokovic	Technical Manager	

Issued: January 13, 2012

This calibration certificate shall not be reproduced except in full without written approval of the laboratory.



Accredited by the Swiss Accreditation Service (SAS)

Accreditation No.: **SCS 108**

The Swiss Accreditation Service is one of the signatories to the EA
Multilateral Agreement for the recognition of calibration certificates

Glossary:

TSL	tissue simulating liquid
NORM _{x,y,z}	sensitivity in free space
ConvF	sensitivity in TSL / NORM _{x,y,z}
DCP	diode compression point
CF	crest factor (1/duty_cycle) of the RF signal
A, B, C	modulation dependent linearization parameters
Polarization φ	φ rotation around probe axis
Polarization ϑ	ϑ rotation around an axis that is in the plane normal to probe axis (at measurement center), i.e., $\vartheta = 0$ is normal to probe axis

Calibration is Performed According to the Following Standards:

- IEEE Std 1528-2003, "IEEE Recommended Practice for Determining the Peak Spatial-Averaged Specific Absorption Rate (SAR) in the Human Head from Wireless Communications Devices: Measurement Techniques", December 2003
- IEC 62209-1, "Procedure to measure the Specific Absorption Rate (SAR) for hand-held devices used in close proximity to the ear (frequency range of 300 MHz to 3 GHz)", February 2005

Methods Applied and Interpretation of Parameters:

- NORM_{x,y,z}**: Assessed for E-field polarization $\vartheta = 0$ ($f \leq 900$ MHz in TEM-cell; $f > 1800$ MHz: R22 waveguide). NORM_{x,y,z} are only intermediate values, i.e., the uncertainties of NORM_{x,y,z} does not affect the E^2 -field uncertainty inside TSL (see below ConvF).
- NORM(f)_{x,y,z}** = NORM_{x,y,z} * frequency_response (see Frequency Response Chart). This linearization is implemented in DASY4 software versions later than 4.2. The uncertainty of the frequency response is included in the stated uncertainty of ConvF.
- DCP_{x,y,z}**: DCP are numerical linearization parameters assessed based on the data of power sweep with CW signal (no uncertainty required). DCP does not depend on frequency nor media.
- PAR**: PAR is the Peak to Average Ratio that is not calibrated but determined based on the signal characteristics
- A_{x,y,z}; B_{x,y,z}; C_{x,y,z}; VR_{x,y,z}**: A, B, C are numerical linearization parameters assessed based on the data of power sweep for specific modulation signal. The parameters do not depend on frequency nor media. VR is the maximum calibration range expressed in RMS voltage across the diode.
- ConvF and Boundary Effect Parameters**: Assessed in flat phantom using E-field (or Temperature Transfer Standard for $f \leq 800$ MHz) and inside waveguide using analytical field distributions based on power measurements for $f > 800$ MHz. The same setups are used for assessment of the parameters applied for boundary compensation (alpha, depth) of which typical uncertainty values are given. These parameters are used in DASY4 software to improve probe accuracy close to the boundary. The sensitivity in TSL corresponds to NORM_{x,y,z} * ConvF whereby the uncertainty corresponds to that given for ConvF. A frequency dependent ConvF is used in DASY version 4.4 and higher which allows extending the validity from ± 50 MHz to ± 100 MHz.
- Spherical isotropy (3D deviation from isotropy)**: in a field of low gradients realized using a flat phantom exposed by a patch antenna.
- Sensor Offset**: The sensor offset corresponds to the offset of virtual measurement center from the probe tip (on probe axis). No tolerance required.

Probe ES3DV3

SN:3180

Manufactured: March 25, 2008
Calibrated: January 11, 2012

Calibrated for DASY/EASY Systems
(Note: non-compatible with DASY2 system!)

DASY/EASY - Parameters of Probe: ES3DV3 - SN:3180

Basic Calibration Parameters

	Sensor X	Sensor Y	Sensor Z	Unc (k=2)
Norm ($\mu\text{V}/(\text{V}/\text{m})^2$) ^A	1.21	1.05	1.01	$\pm 10.1 \%$
DCP (mV) ^B	101.4	103.7	103.5	

Modulation Calibration Parameters

UID	Communication System Name	PAR		A dB	B dB	C dB	VR mV	Unc ^E (k=2)
10000	CW	0.00	X	0.00	0.00	1.00	107.7	$\pm 3.0 \%$
			Y	0.00	0.00	1.00	103.4	
			Z	0.00	0.00	1.00	92.6	

The reported uncertainty of measurement is stated as the standard uncertainty of measurement multiplied by the coverage factor $k=2$, which for a normal distribution corresponds to a coverage probability of approximately 95%.

^A The uncertainties of NormX,Y,Z do not affect the E^2 -field uncertainty inside TSL (see Pages 5 and 6).

^B Numerical linearization parameter: uncertainty not required.

^E Uncertainty is determined using the max. deviation from linear response applying rectangular distribution and is expressed for the square of the field value.

DASY/EASY - Parameters of Probe: ES3DV3 - SN:3180

Calibration Parameter Determined in Head Tissue Simulating Media

f (MHz) ^C	Relative Permittivity ^F	Conductivity (S/m) ^F	ConvF X	ConvF Y	ConvF Z	Alpha	Depth (mm)	Unct. (k=2)
750	41.9	0.89	6.30	6.30	6.30	0.26	1.99	± 12.0 %
835	41.5	0.90	6.07	6.07	6.07	0.41	1.56	± 12.0 %
1810	40.0	1.40	5.20	5.20	5.20	0.43	1.56	± 12.0 %
1950	40.0	1.40	4.97	4.97	4.97	0.72	1.23	± 12.0 %
2450	39.2	1.80	4.51	4.51	4.51	0.77	1.33	± 12.0 %

^C Frequency validity of ± 100 MHz only applies for DASY v4.4 and higher (see Page 2), else it is restricted to ± 50 MHz. The uncertainty is the RSS of the ConvF uncertainty at calibration frequency and the uncertainty for the indicated frequency band.

^F At frequencies below 3 GHz, the validity of tissue parameters (ϵ and σ) can be relaxed to ± 10% if liquid compensation formula is applied to measured SAR values. At frequencies above 3 GHz, the validity of tissue parameters (ϵ and σ) is restricted to ± 5%. The uncertainty is the RSS of the ConvF uncertainty for indicated target tissue parameters.

DASY/EASY - Parameters of Probe: ES3DV3 - SN:3180

Calibration Parameter Determined in Body Tissue Simulating Media

f (MHz) ^C	Relative Permittivity ^F	Conductivity (S/m) ^F	ConvF X	ConvF Y	ConvF Z	Alpha	Depth (mm)	Unct. (k=2)
750	55.5	0.96	6.06	6.06	6.06	0.35	1.71	± 12.0 %
835	55.2	0.97	5.97	5.97	5.97	0.52	1.36	± 12.0 %
1810	53.3	1.52	5.09	5.09	5.09	0.65	1.58	± 12.0 %
1950	53.3	1.52	5.03	5.03	5.03	0.64	1.52	± 12.0 %
2450	52.7	1.95	4.46	4.46	4.46	0.80	1.21	± 12.0 %

^C Frequency validity of ± 100 MHz only applies for DASY v4.4 and higher (see Page 2), else it is restricted to ± 50 MHz. The uncertainty is the RSS of the ConvF uncertainty at calibration frequency and the uncertainty for the indicated frequency band.

^F At frequencies below 3 GHz, the validity of tissue parameters (ϵ and σ) can be relaxed to ± 10% if liquid compensation formula is applied to measured SAR values. At frequencies above 3 GHz, the validity of tissue parameters (ϵ and σ) is restricted to ± 5%. The uncertainty is the RSS of the ConvF uncertainty for indicated target tissue parameters.

Frequency Response of E-Field

(TEM-Cell:ifi110 EXX, Waveguide: R22)

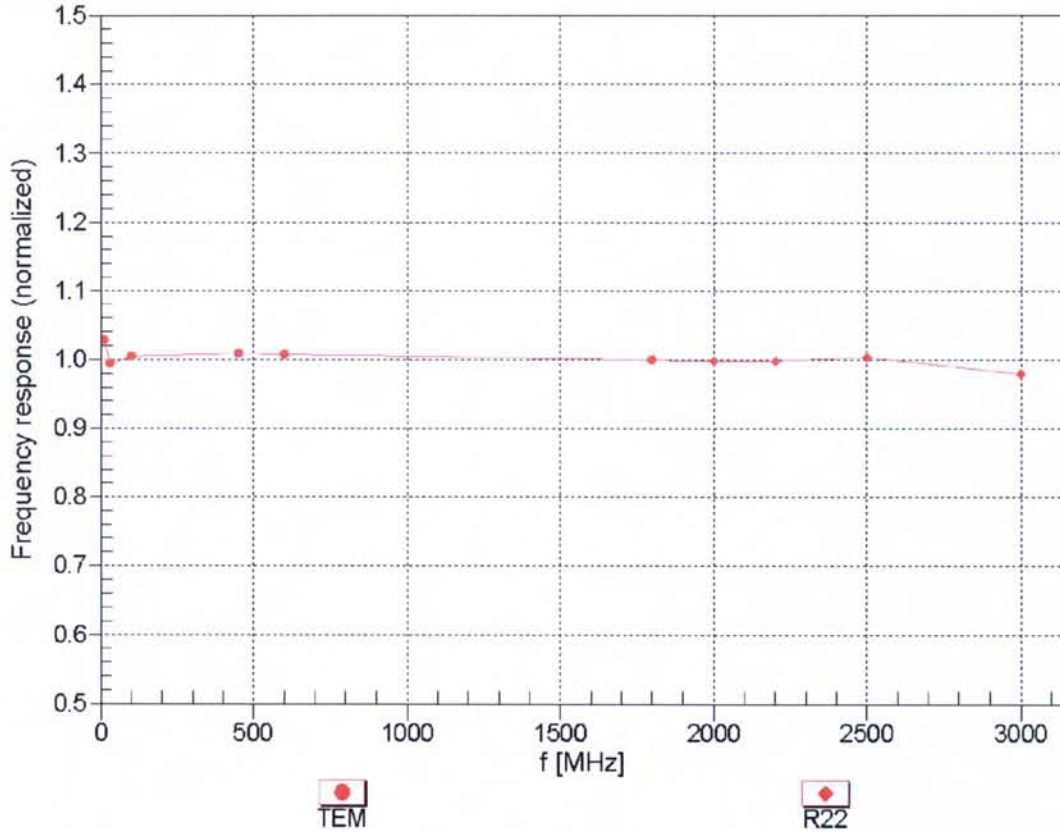

Uncertainty of Frequency Response of E-field: $\pm 6.3\%$ (k=2)

Receiving Pattern (ϕ), $\theta = 0^\circ$

f=600 MHz,TEM

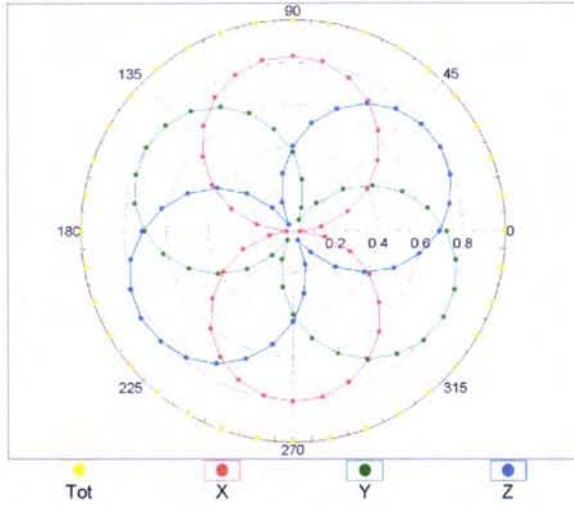

f=1800 MHz,R22

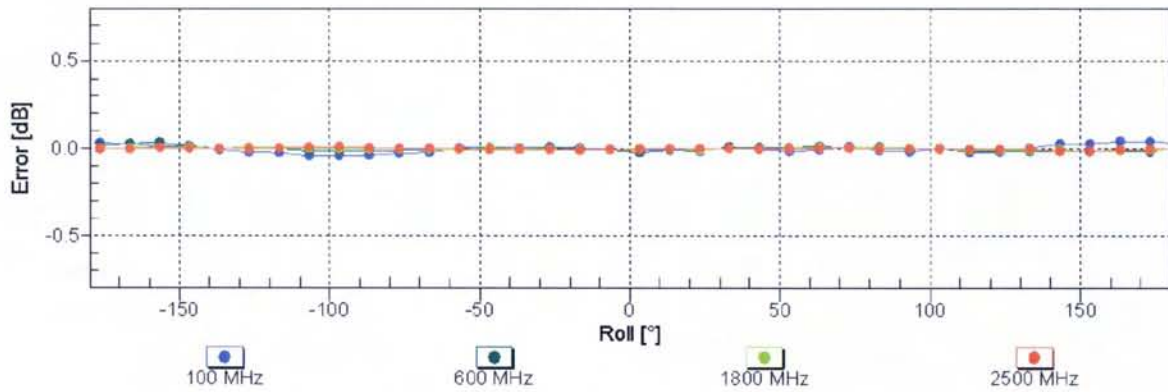
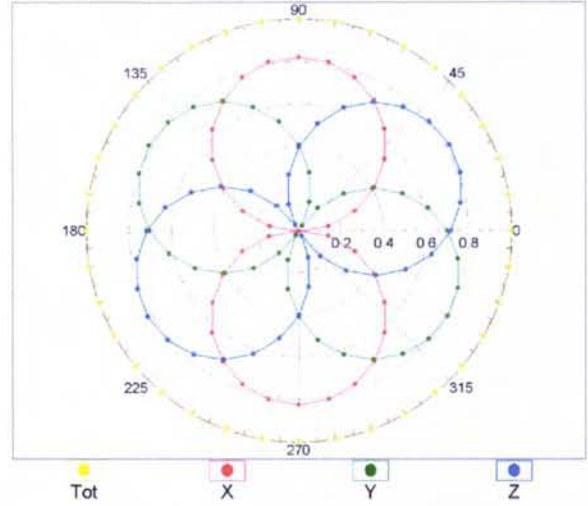

Uncertainty of Axial Isotropy Assessment: $\pm 0.5\%$ (k=2)

Dynamic Range $f(\text{SAR}_{\text{head}})$ (TEM cell , $f = 900 \text{ MHz}$)

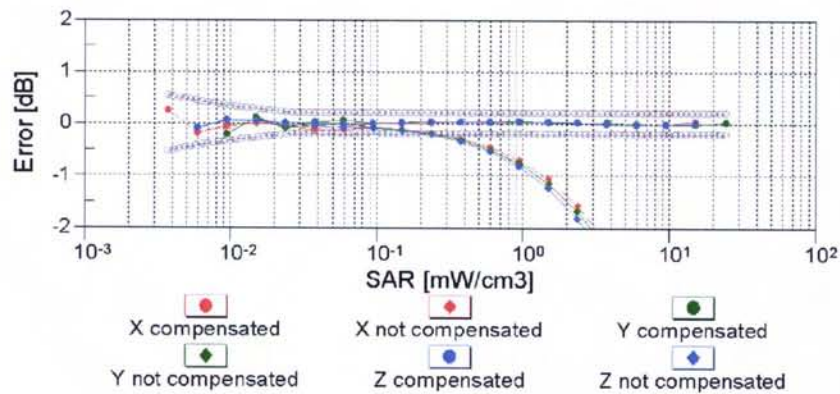
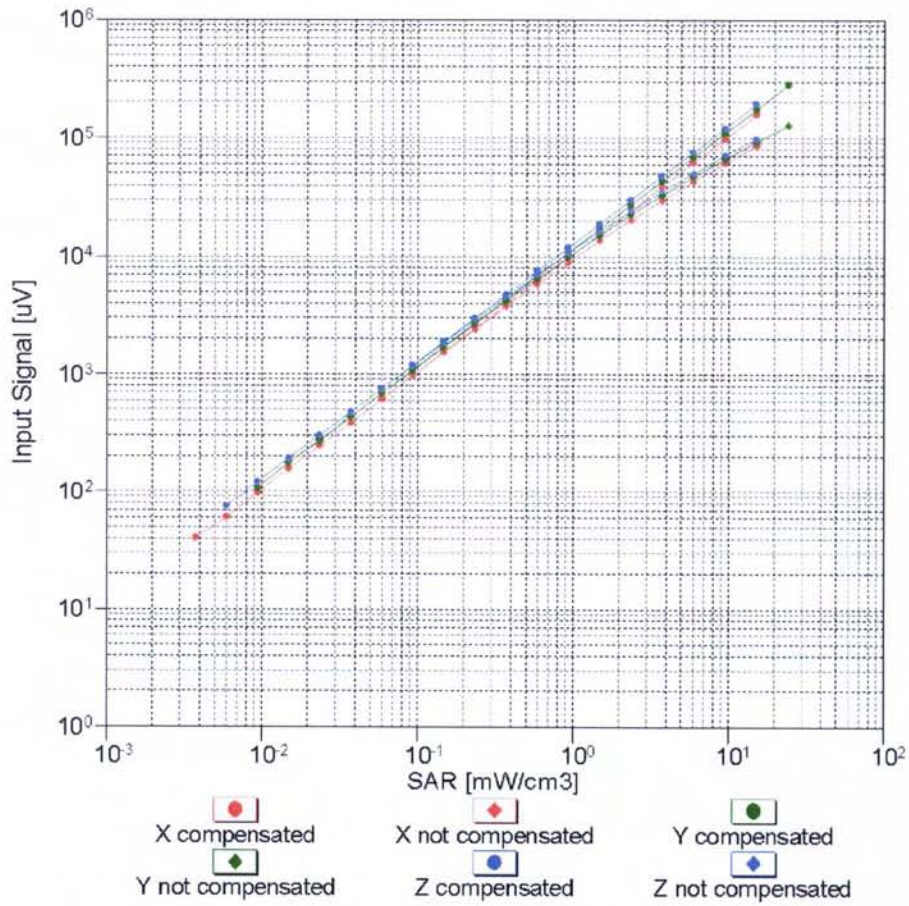

Uncertainty of Linearity Assessment: $\pm 0.6\%$ ($k=2$)

Conversion Factor Assessment

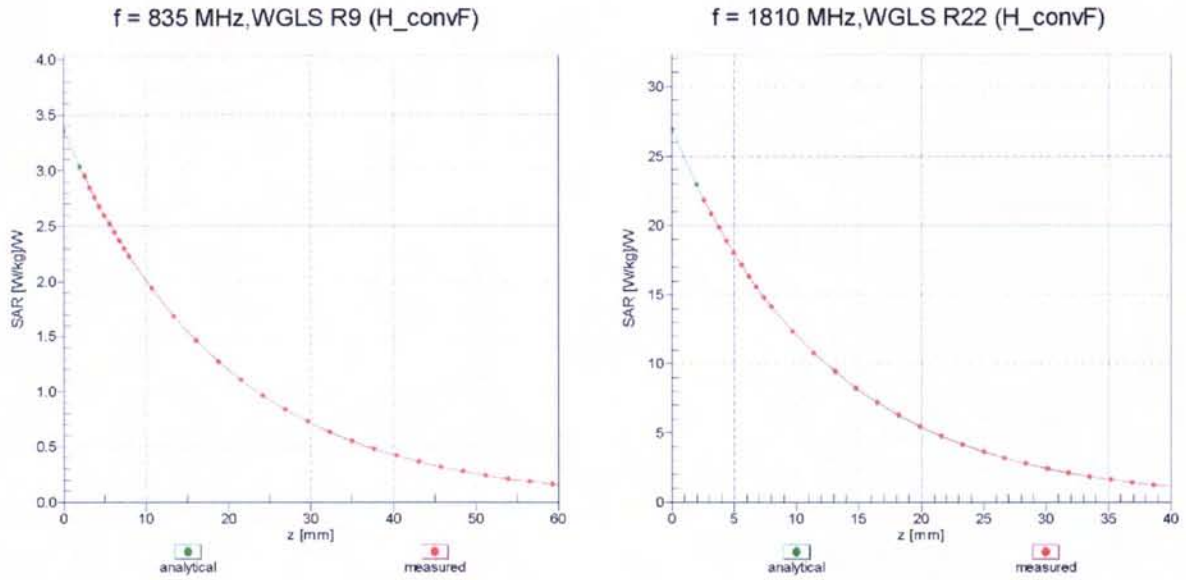

Deviation from Isotropy in Liquid Error (ϕ, ϑ), f = 900 MHz

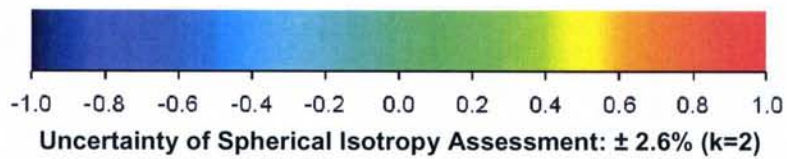
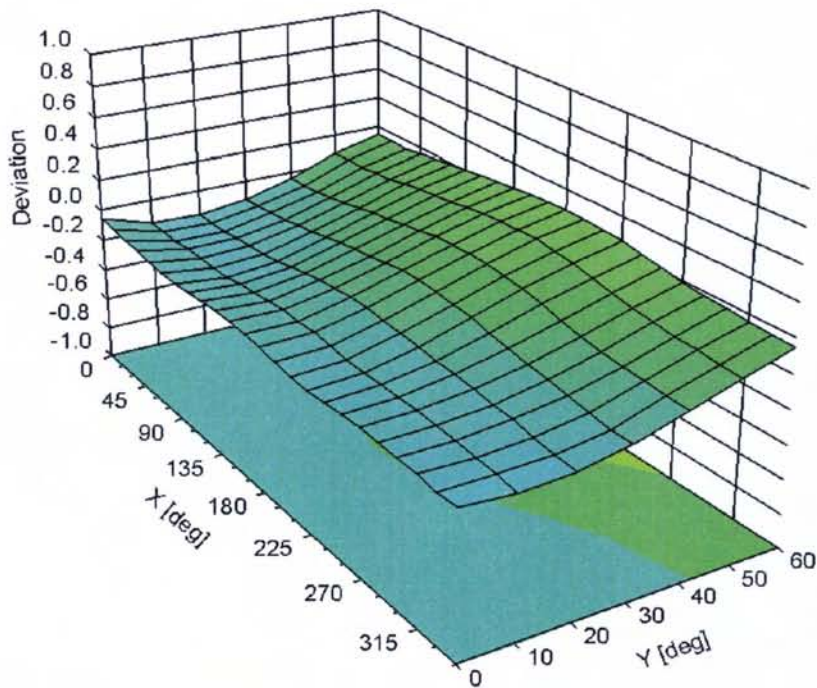

DASY/EASY - Parameters of Probe: ES3DV3 - SN:3180

Other Probe Parameters

Sensor Arrangement	Triangular
Connector Angle (°)	Not applicable
Mechanical Surface Detection Mode	enabled
Optical Surface Detection Mode	disabled
Probe Overall Length	337 mm
Probe Body Diameter	10 mm
Tip Length	10 mm
Tip Diameter	4 mm
Probe Tip to Sensor X Calibration Point	2 mm
Probe Tip to Sensor Y Calibration Point	2 mm
Probe Tip to Sensor Z Calibration Point	2 mm
Recommended Measurement Distance from Surface	3 mm

Appendix 6

Dipole Characterization Certificate



Accredited by the Swiss Accreditation Service (SAS)
The Swiss Accreditation Service is one of the signatories to the EA
Multilateral Agreement for the recognition of calibration certificates

Accreditation No.: **SCS 108**

Client **Motorola MDb**

Certificate No: **D835V2-425_Jul11**

CALIBRATION CERTIFICATE

Object **D835V2 - SN: 425**

Calibration procedure(s) **QA CAL-05.v8
Calibration procedure for dipole validation kits above 700 MHz**

Calibration date: **July 08, 2011**

This calibration certificate documents the traceability to national standards, which realize the physical units of measurements (SI).
The measurements and the uncertainties with confidence probability are given on the following pages and are part of the certificate.

All calibrations have been conducted in the closed laboratory facility: environment temperature $(22 \pm 3)^\circ\text{C}$ and humidity $< 70\%$.

Calibration Equipment used (M&TE critical for calibration)

Primary Standards	ID #	Cal Date (Certificate No.)	Scheduled Calibration
Power meter EPM-442A	GB37480704	06-Oct-10 (No. 217-01266)	Oct-11
Power sensor HP 8481A	US37292783	06-Oct-10 (No. 217-01266)	Oct-11
Reference 20 dB Attenuator	SN: S5086 (20b)	29-Mar-11 (No. 217-01367)	Apr-12
Type-N mismatch combination	SN: 5047.2 / 06327	29-Mar-11 (No. 217-01371)	Apr-12
Reference Probe ES3DV3	SN: 3205	29-Apr-11 (No. ES3-3205_Apr11)	Apr-12
DAE4	SN: 601	04-Jul-11 (No. DAE4-601_Jul11)	Jul-12
Secondary Standards	ID #	Check Date (in house)	Scheduled Check
Power sensor HP 8481A	MY41092317	18-Oct-02 (in house check Oct-09)	In house check: Oct-11
RF generator R&S SMT-06	100005	04-Aug-99 (in house check Oct-09)	In house check: Oct-11
Network Analyzer HP 8753E	US37390585 S4206	18-Oct-01 (in house check Oct-10)	In house check: Oct-11

Calibrated by: **Jeton Kastrati** **Laboratory Technician**

Signature

Approved by: **Katja Pokovic** **Technical Manager**

Issued: July 12, 2011

This calibration certificate shall not be reproduced except in full without written approval of the laboratory.



Accredited by the Swiss Accreditation Service (SAS)
The Swiss Accreditation Service is one of the signatories to the EA
Multilateral Agreement for the recognition of calibration certificates

Accreditation No.: **SCS 108**

Glossary:

TSL	tissue simulating liquid
ConvF	sensitivity in TSL / NORM x,y,z
N/A	not applicable or not measured

Calibration is Performed According to the Following Standards:

- IEEE Std 1528-2003, "IEEE Recommended Practice for Determining the Peak Spatial-Averaged Specific Absorption Rate (SAR) in the Human Head from Wireless Communications Devices: Measurement Techniques", December 2003
- IEC 62209-1, "Procedure to measure the Specific Absorption Rate (SAR) for hand-held devices used in close proximity to the ear (frequency range of 300 MHz to 3 GHz)", February 2005
- Federal Communications Commission Office of Engineering & Technology (FCC OET), "Evaluating Compliance with FCC Guidelines for Human Exposure to Radiofrequency Electromagnetic Fields; Additional Information for Evaluating Compliance of Mobile and Portable Devices with FCC Limits for Human Exposure to Radiofrequency Emissions", Supplement C (Edition 01-01) to Bulletin 65

Additional Documentation:

- DASY4/5 System Handbook

Methods Applied and Interpretation of Parameters:

- Measurement Conditions:** Further details are available from the Validation Report at the end of the certificate. All figures stated in the certificate are valid at the frequency indicated.
- Antenna Parameters with TSL:** The dipole is mounted with the spacer to position its feed point exactly below the center marking of the flat phantom section, with the arms oriented parallel to the body axis.
- Feed Point Impedance and Return Loss:** These parameters are measured with the dipole positioned under the liquid filled phantom. The impedance stated is transformed from the measurement at the SMA connector to the feed point. The Return Loss ensures low reflected power. No uncertainty required.
- Electrical Delay:** One-way delay between the SMA connector and the antenna feed point. No uncertainty required.
- SAR measured:** SAR measured at the stated antenna input power.
- SAR normalized:** SAR as measured, normalized to an input power of 1 W at the antenna connector.
- SAR for nominal TSL parameters:** The measured TSL parameters are used to calculate the nominal SAR result.

Measurement Conditions

DASY system configuration, as far as not given on page 1.

DASY Version	DASY5	V52.6.2
Extrapolation	Advanced Extrapolation	
Phantom	Modular Flat Phantom	
Distance Dipole Center - TSL	15 mm	with Spacer
Zoom Scan Resolution	dx, dy, dz = 5 mm	
Frequency	835 MHz \pm 1 MHz	

Head TSL parameters

The following parameters and calculations were applied.

	Temperature	Permittivity	Conductivity
Nominal Head TSL parameters	22.0 °C	41.5	0.90 mho/m
Measured Head TSL parameters	(22.0 \pm 0.2) °C	41.0 \pm 6 %	0.88 mho/m \pm 6 %
Head TSL temperature change during test	< 0.5 °C	----	----

SAR result with Head TSL

SAR averaged over 1 cm³ (1 g) of Head TSL	Condition	
SAR measured	250 mW input power	2.25 mW / g
SAR for nominal Head TSL parameters	normalized to 1W	9.13 mW / g \pm 17.0 % (k=2)

SAR averaged over 10 cm³ (10 g) of Head TSL	condition	
SAR measured	250 mW input power	1.47 mW / g
SAR for nominal Head TSL parameters	normalized to 1W	5.94 mW / g \pm 16.5 % (k=2)

Body TSL parameters

The following parameters and calculations were applied.

	Temperature	Permittivity	Conductivity
Nominal Body TSL parameters	22.0 °C	55.2	0.97 mho/m
Measured Body TSL parameters	(22.0 \pm 0.2) °C	53.8 \pm 6 %	0.98 mho/m \pm 6 %
Body TSL temperature change during test	< 0.5 °C	----	----

SAR result with Body TSL

SAR averaged over 1 cm³ (1 g) of Body TSL	Condition	
SAR measured	250 mW input power	2.37 mW / g
SAR for nominal Body TSL parameters	normalized to 1W	9.35 mW / g \pm 17.0 % (k=2)

SAR averaged over 10 cm³ (10 g) of Body TSL	condition	
SAR measured	250 mW input power	1.56 mW / g
SAR for nominal Body TSL parameters	normalized to 1W	6.18 mW / g \pm 16.5 % (k=2)

Appendix

Antenna Parameters with Head TSL

Impedance, transformed to feed point	53.0 Ω + 2.7 j Ω
Return Loss	- 28.2 dB

Antenna Parameters with Body TSL

Impedance, transformed to feed point	49.1 Ω + 2.2 j Ω
Return Loss	- 32.4 dB

General Antenna Parameters and Design

Electrical Delay (one direction)	1.401 ns
----------------------------------	----------

After long term use with 100W radiated power, only a slight warming of the dipole near the feedpoint can be measured.

The dipole is made of standard semirigid coaxial cable. The center conductor of the feeding line is directly connected to the second arm of the dipole. The antenna is therefore short-circuited for DC-signals.

No excessive force must be applied to the dipole arms, because they might bend or the soldered connections near the feedpoint may be damaged.

Design Modification by End User

The dipole has been modified with Teflon Rings (TR) placed within identified markings close to the end of each dipole arm. Calibration has been performed with TR attached to the dipole

Additional EUT Data

Manufactured by	SPEAG
Manufactured on	August 24, 2000

DASY5 Validation Report for Head TSL

Date: 08.07.2011

Test Laboratory: SPEAG, Zurich, Switzerland

DUT: Dipole 835 MHz; Type: D835V2; Serial: D835V2 - SN: 425

Communication System: CW; Frequency: 835 MHz

Medium parameters used: $f = 835 \text{ MHz}$; $\sigma = 0.88 \text{ mho/m}$; $\epsilon_r = 41$; $\rho = 1000 \text{ kg/m}^3$

Phantom section: Flat Section

Measurement Standard: DASY5 (IEEE/IEC/ANSI C63.19-2007)

DASY52 Configuration:

- Probe: ES3DV3 - SN3205; ConvF(6.07, 6.07, 6.07); Calibrated: 29.04.2011
- Sensor-Surface: 3mm (Mechanical Surface Detection)
- Electronics: DAE4 Sn601; Calibrated: 04.07.2011
- Phantom: Flat Phantom 4.9L; Type: QD000P49AA; Serial: 1001
- DASY52 52.6.2(482); SEMCAD X 14.4.5(3634)

Dipole Calibration for Head Tissue/Pin=250 mW, $d=15\text{mm}$ /Zoom Scan (7x7x7)/Cube 0:

Measurement grid: $dx=5\text{mm}$, $dy=5\text{mm}$, $dz=5\text{mm}$

Reference Value = 56.396 V/m; Power Drift = 0.004 dB

Peak SAR (extrapolated) = 3.296 W/kg

SAR(1 g) = 2.25 mW/g; SAR(10 g) = 1.47 mW/g

Maximum value of SAR (measured) = 2.624 mW/g

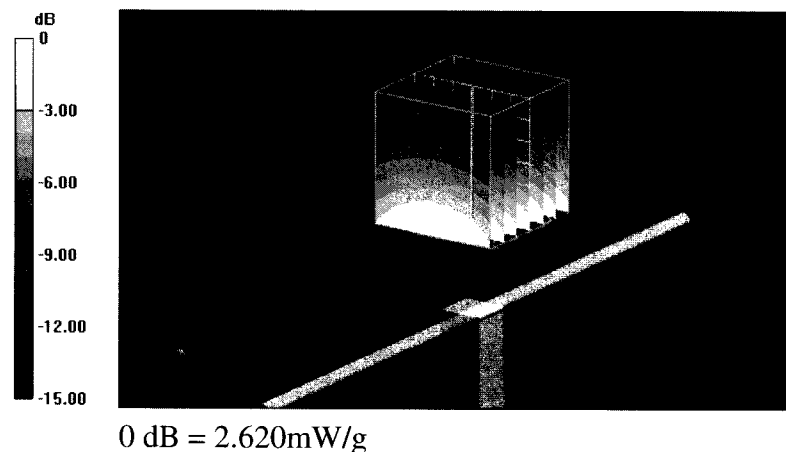

Impedance Measurement Plot for Head TSL

8 Jul 2011 10:15:06

CH1 S11 1 U FS 1: 52.982 Ω 2.7031 Ω 515.23 pF 835.000 000 MHz

*

De1

Cor

Avg
16

H1 d

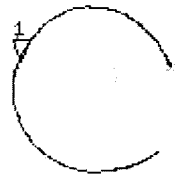

CH2 S11 LOG 5 dB/REF -20 dB 1: -28.166 dB 835.000 000 MHz

Cor

Avg
16

H1 d

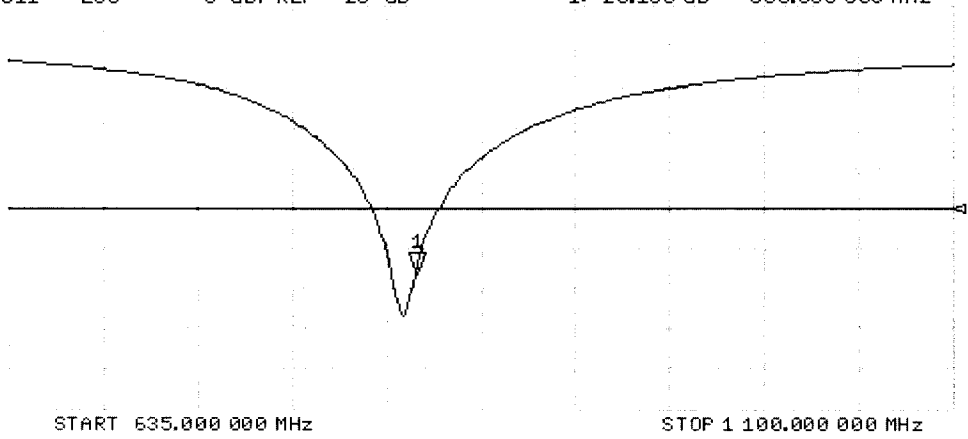

DASY5 Validation Report for Body TSL

Date: 08.07.2011

Test Laboratory: SPEAG, Zurich, Switzerland

DUT: Dipole 835 MHz; Type: D835V2; Serial: D835V2 - SN: 425

Communication System: CW; Frequency: 835 MHz

Medium parameters used: $f = 835$ MHz; $\sigma = 0.98$ mho/m; $\epsilon_r = 53.8$; $\rho = 1000$ kg/m³

Phantom section: Flat Section

Measurement Standard: DASY5 (IEEE/IEC/ANSI C63.19-2007)

DASY52 Configuration:

- Probe: ES3DV3 - SN3205; ConvF(6.02, 6.02, 6.02); Calibrated: 29.04.2011
- Sensor-Surface: 3mm (Mechanical Surface Detection)
- Electronics: DAE4 Sn601; Calibrated: 04.07.2011
- Phantom: Flat Phantom 4.9L; Type: QD000P49AA; Serial: 1001
- DASY52 52.6.2(482); SEMCAD X 14.4.5(3634)

Dipole Calibration for Body Tissue/Pin=250 mW, d=15mm/Zoom Scan (7x7x7)/Cube 0:

Measurement grid: dx=5mm, dy=5mm, dz=5mm

Reference Value = 55.024 V/m; Power Drift = 0.02 dB

Peak SAR (extrapolated) = 3.431 W/kg

SAR(1 g) = 2.37 mW/g; SAR(10 g) = 1.56 mW/g

Maximum value of SAR (measured) = 2.759 mW/g

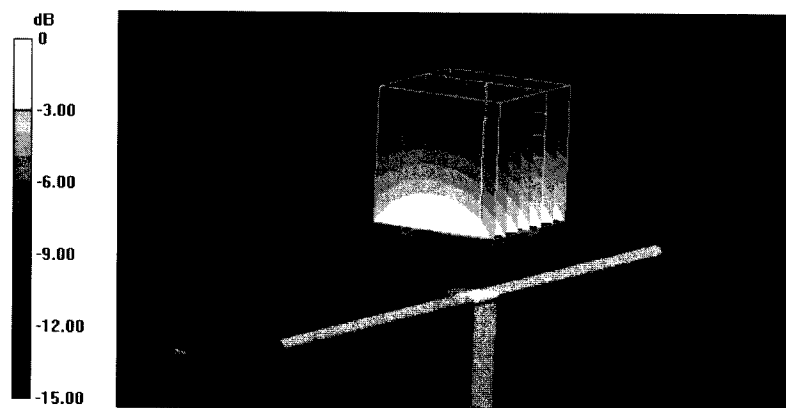

0 dB = 2.760mW/g

Impedance Measurement Plot for Body TSL

8 Jul 2011 14:29:23

[CH1] S11 1 U FS 1: 49.143 Ω 2: 2.2227 Ω 423.65 μH 835.000 000 MHz

*

Del

Cor

Avg
16

H1 d



CH1 Markers

1: 61.988 Ω
2: 37.531 Ω
900.000 MHz

CH2 S11 LOG 5 dB/REF -20 dB 1: -32.392 dB 835.000 000 MHz

Cor

Avg
16

H1 d

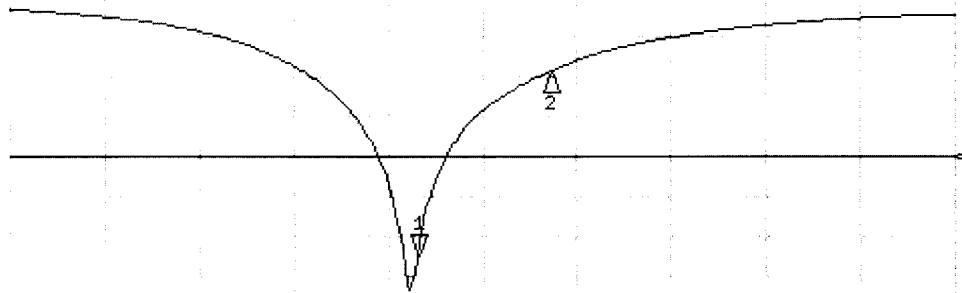

CH2 Markers

1: -9.5360 dB
2: -9.5360 dB
900.000 MHz

START 635.000 000 MHz

STOP 1 100.000 000 MHz



Accredited by the Swiss Accreditation Service (SAS)
The Swiss Accreditation Service is one of the signatories to the EA
Multilateral Agreement for the recognition of calibration certificates

Accreditation No.: **SCS 108**

Client **Motorola Beijing**

Certificate No: **D1800V2-2d129_Jul11**

CALIBRATION CERTIFICATE

Object **D1800V2 - SN: 2d129**

Calibration procedure(s) **QA CAL-05.v8
Calibration procedure for dipole validation kits above 700 MHz**

Calibration date: **July 22, 2011**

This calibration certificate documents the traceability to national standards, which realize the physical units of measurements (SI).
The measurements and the uncertainties with confidence probability are given on the following pages and are part of the certificate.

All calibrations have been conducted in the closed laboratory facility: environment temperature (22 ± 3)°C and humidity < 70%.

Calibration Equipment used (M&TE critical for calibration)

Primary Standards	ID #	Cal Date (Certificate No.)	Scheduled Calibration
Power meter EPM-442A	GB37480704	06-Oct-10 (No. 217-01266)	Oct-11
Power sensor HP 8481A	US37292783	06-Oct-10 (No. 217-01266)	Oct-11
Reference 20 dB Attenuator	SN: S5086 (20b)	29-Mar-11 (No. 217-01367)	Apr-12
Type-N mismatch combination	SN: 5047.2 / 06327	29-Mar-11 (No. 217-01371)	Apr-12
Reference Probe ES3DV3	SN: 3205	29-Apr-11 (No. ES3-3205_Apr11)	Apr-12
DAE4	SN: 601	04-Jul-11 (No. DAE4-601_Jul11)	Jul-12
Secondary Standards	ID #	Check Date (in house)	Scheduled Check
Power sensor HP 8481A	MY41092317	18-Oct-02 (in house check Oct-09)	In house check: Oct-11
RF generator R&S SMT-06	100005	04-Aug-99 (in house check Oct-09)	In house check: Oct-11
Network Analyzer HP 8753E	US37390585 S4206	18-Oct-01 (in house check Oct-10)	In house check: Oct-11

Calibrated by:	Name Dimce Iliev	Function Laboratory Technician	Signature
Approved by:	Name Katja Pokovic	Function Technical Manager	Signature

Issued: July 22, 2011

This calibration certificate shall not be reproduced except in full without written approval of the laboratory.



Accredited by the Swiss Accreditation Service (SAS)

The Swiss Accreditation Service is one of the signatories to the EA
Multilateral Agreement for the recognition of calibration certificates

Accreditation No.: **SCS 108**

Glossary:

TSL	tissue simulating liquid
ConvF	sensitivity in TSL / NORM x,y,z
N/A	not applicable or not measured

Calibration is Performed According to the Following Standards:

- IEEE Std 1528-2003, "IEEE Recommended Practice for Determining the Peak Spatial-Averaged Specific Absorption Rate (SAR) in the Human Head from Wireless Communications Devices: Measurement Techniques", December 2003
- IEC 62209-1, "Procedure to measure the Specific Absorption Rate (SAR) for hand-held devices used in close proximity to the ear (frequency range of 300 MHz to 3 GHz)", February 2005
- Federal Communications Commission Office of Engineering & Technology (FCC OET), "Evaluating Compliance with FCC Guidelines for Human Exposure to Radiofrequency Electromagnetic Fields; Additional Information for Evaluating Compliance of Mobile and Portable Devices with FCC Limits for Human Exposure to Radiofrequency Emissions", Supplement C (Edition 01-01) to Bulletin 65

Additional Documentation:

- DASY4/5 System Handbook

Methods Applied and Interpretation of Parameters:

- Measurement Conditions:** Further details are available from the Validation Report at the end of the certificate. All figures stated in the certificate are valid at the frequency indicated.
- Antenna Parameters with TSL:** The dipole is mounted with the spacer to position its feed point exactly below the center marking of the flat phantom section, with the arms oriented parallel to the body axis.
- Feed Point Impedance and Return Loss:** These parameters are measured with the dipole positioned under the liquid filled phantom. The impedance stated is transformed from the measurement at the SMA connector to the feed point. The Return Loss ensures low reflected power. No uncertainty required.
- Electrical Delay:** One-way delay between the SMA connector and the antenna feed point. No uncertainty required.
- SAR measured:** SAR measured at the stated antenna input power.
- SAR normalized:** SAR as measured, normalized to an input power of 1 W at the antenna connector.
- SAR for nominal TSL parameters:** The measured TSL parameters are used to calculate the nominal SAR result.

Measurement Conditions

DASY system configuration, as far as not given on page 1.

DASY Version	DASY5	V52.6.2
Extrapolation	Advanced Extrapolation	
Phantom	Modular Flat Phantom	
Distance Dipole Center - TSL	10 mm	with Spacer
Zoom Scan Resolution	dx, dy, dz = 5 mm	
Frequency	1800 MHz \pm 1 MHz	

Head TSL parameters

The following parameters and calculations were applied.

	Temperature	Permittivity	Conductivity
Nominal Head TSL parameters	22.0 °C	40.0	1.40 mho/m
Measured Head TSL parameters	(22.0 \pm 0.2) °C	39.2 \pm 6 %	1.37 mho/m \pm 6 %
Head TSL temperature change during test	< 0.5 °C	----	----

SAR result with Head TSL

SAR averaged over 1 cm³ (1 g) of Head TSL	Condition	
SAR measured	250 mW input power	9.55 mW / g
SAR for nominal Head TSL parameters	normalized to 1W	38.5 mW / g \pm 17.0 % (k=2)

SAR averaged over 10 cm³ (10 g) of Head TSL	condition	
SAR measured	250 mW input power	5.04 mW / g
SAR for nominal Head TSL parameters	normalized to 1W	20.2 mW / g \pm 16.5 % (k=2)

Body TSL parameters

The following parameters and calculations were applied.

	Temperature	Permittivity	Conductivity
Nominal Body TSL parameters	22.0 °C	53.3	1.52 mho/m
Measured Body TSL parameters	(22.0 \pm 0.2) °C	52.2 \pm 6 %	1.50 mho/m \pm 6 %
Body TSL temperature change during test	< 0.5 °C	----	----

SAR result with Body TSL

SAR averaged over 1 cm³ (1 g) of Body TSL	Condition	
SAR measured	250 mW input power	9.67 mW / g
SAR for nominal Body TSL parameters	normalized to 1W	38.8 mW / g \pm 17.0 % (k=2)

SAR averaged over 10 cm³ (10 g) of Body TSL	condition	
SAR measured	250 mW input power	5.14 mW / g
SAR for nominal Body TSL parameters	normalized to 1W	20.6 mW / g \pm 16.5 % (k=2)

Appendix

Antenna Parameters with Head TSL

Impedance, transformed to feed point	48.4 Ω - 2.3 j Ω
Return Loss	- 31.0 dB

Antenna Parameters with Body TSL

Impedance, transformed to feed point	43.8 Ω - 2.8 j Ω
Return Loss	- 22.8 dB

General Antenna Parameters and Design

Electrical Delay (one direction)	1.209 ns
----------------------------------	----------

After long term use with 100W radiated power, only a slight warming of the dipole near the feedpoint can be measured.

The dipole is made of standard semirigid coaxial cable. The center conductor of the feeding line is directly connected to the second arm of the dipole. The antenna is therefore short-circuited for DC-signals.

No excessive force must be applied to the dipole arms, because they might bend or the soldered connections near the feedpoint may be damaged.

Additional EUT Data

Manufactured by	SPEAG
Manufactured on	July 27, 2005

DASY5 Validation Report for Head TSL

Date: 20.07.2011

Test Laboratory: SPEAG, Zurich, Switzerland

DUT: Dipole 1800 MHz; Type: D1800V2; Serial: D1800V2 - SN: 2d129

Communication System: CW; Frequency: 1800 MHz

Medium parameters used: $f = 1800$ MHz; $\sigma = 1.37$ mho/m; $\epsilon_r = 39.2$; $\rho = 1000$ kg/m³

Phantom section: Flat Section

Measurement Standard: DASY5 (IEEE/IEC/ANSI C63.19-2007)

DASY52 Configuration:

- Probe: ES3DV3 - SN3205; ConvF(5.07, 5.07, 5.07); Calibrated: 29.04.2011
- Sensor-Surface: 3mm (Mechanical Surface Detection)
- Electronics: DAE4 Sn601; Calibrated: 04.07.2011
- Phantom: Flat Phantom 5.0 (front); Type: QD000P50AA; Serial: 1001
- DASY52 52.6.2(482); SEMCAD X 14.4.5(3634)

Dipole Calibration for Head Tissue/Pin=250 mW, d=10mm/Zoom Scan (7x7x7)/Cube 0:

Measurement grid: dx=5mm, dy=5mm, dz=5mm

Reference Value = 97.826 V/m; Power Drift = 0.02 dB

Peak SAR (extrapolated) = 17.101 W/kg

SAR(1 g) = 9.55 mW/g; SAR(10 g) = 5.04 mW/g

Maximum value of SAR (measured) = 12.040 mW/g

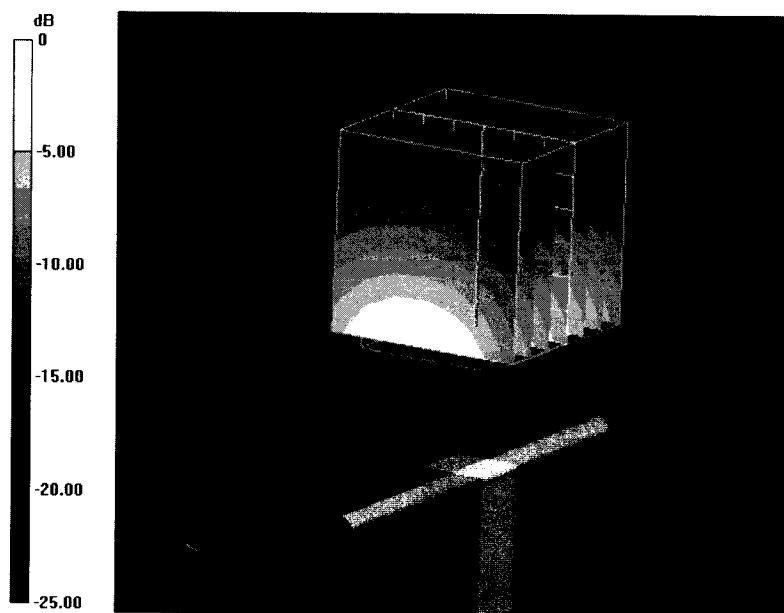

0 dB = 12.040mW/g

Impedance Measurement Plot for Head TSL

20 Jul 2011 09:33:37

CH1 S11 1 U FS 1: 48.383 Ω -2.2656 Ω 39.027 pF 1 800.000 000 MHz

*

Del

Cor

Avg
16

H1 d

CH1 Markers

2: 58.375 Ω
16.438 Ω
1.90000 GHz

CH2 S11 LOG 5 dB/REF -20 dB 1: -30.954 dB 1 800.000 000 MHz

Cor

Avg
16

H1 d

CH2 Markers

2: -15.478 dB
1.90000 GHz

START 1 600.000 000 MHz

STOP 2 100.000 000 MHz

DASY5 Validation Report for Body TSL

Date: 22.07.2011

Test Laboratory: SPEAG, Zurich, Switzerland

DUT: Dipole 1800 MHz; Type: D1800V2; Serial: D1800V2 - SN: 2d129

Communication System: CW; Frequency: 1800 MHz

Medium parameters used: $f = 1800 \text{ MHz}$; $\sigma = 1.5 \text{ mho/m}$; $\epsilon_r = 52.2$; $\rho = 1000 \text{ kg/m}^3$

Phantom section: Flat Section

Measurement Standard: DASY5 (IEEE/IEC/ANSI C63.19-2007)

DASY52 Configuration:

- Probe: ES3DV3 - SN3205; ConvF(4.74, 4.74, 4.74); Calibrated: 29.04.2011
- Sensor-Surface: 3mm (Mechanical Surface Detection)
- Electronics: DAE4 Sn601; Calibrated: 04.07.2011
- Phantom: Flat Phantom 5.0 (back); Type: QD000P50AA; Serial: 1002
- DASY52 52.6.2(482); SEMCAD X 14.4.5(3634)

Dipole Calibration for Body Tissue/Pin=250 mW, d=10mm/Zoom Scan (7x7x7)/Cube 0:

Measurement grid: $dx=5\text{mm}$, $dy=5\text{mm}$, $dz=5\text{mm}$

Reference Value = 94.128 V/m; Power Drift = -0.03 dB

Peak SAR (extrapolated) = 16.950 W/kg

SAR(1 g) = 9.67 mW/g; SAR(10 g) = 5.14 mW/g

Maximum value of SAR (measured) = 12.225 mW/g

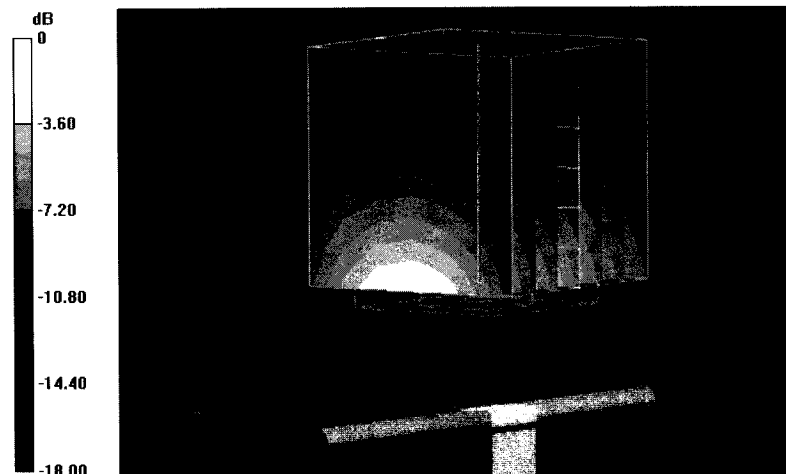

0 dB = 12.220mW/g

Impedance Measurement Plot for Body TSL

22 Jul 2011 09:31:45

CH1 S11 1 U FS 1: 43.779 Ω -2.7537 Ω 31.993 pF 1 800.000 000 MHz

*

Del

Cor

Avg
15

H1 d

CH2 S11 LOG 5 dB/REF -20 dB 1:-22.790 dB 1 800.000 000 MHz

Cor

Avg
15

H1 d

START 1 600.000 000 MHz

STOP 2 100.000 000 MHz

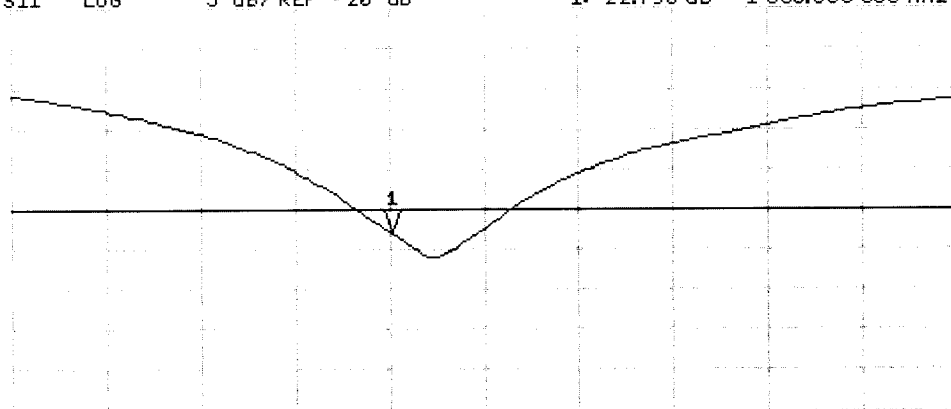



Accredited by the Swiss Accreditation Service (SAS)
The Swiss Accreditation Service is one of the signatories to the EA
Multilateral Agreement for the recognition of calibration certificates

Accreditation No.: **SCS 108**

Client **Motorola Beijing**

Certificate No: **D2450V2-788_Jul11**

CALIBRATION CERTIFICATE

Object **D2450V2 - SN: 788**

Calibration procedure(s) **QA CAL-05.v8
Calibration procedure for dipole validation kits above 700 MHz**

Calibration date: **July 12, 2011**

This calibration certificate documents the traceability to national standards, which realize the physical units of measurements (SI).
The measurements and the uncertainties with confidence probability are given on the following pages and are part of the certificate.

All calibrations have been conducted in the closed laboratory facility: environment temperature (22 ± 3)°C and humidity < 70%.

Calibration Equipment used (M&TE critical for calibration)

Primary Standards	ID #	Cal Date (Certificate No.)	Scheduled Calibration
Power meter EPM-442A	GB37480704	06-Oct-10 (No. 217-01266)	Oct-11
Power sensor HP 8481A	US37292783	06-Oct-10 (No. 217-01266)	Oct-11
Reference 20 dB Attenuator	SN: S5086 (20b)	29-Mar-11 (No. 217-01367)	Apr-12
Type-N mismatch combination	SN: 5047.2 / 06327	29-Mar-11 (No. 217-01371)	Apr-12
Reference Probe ES3DV3	SN: 3205	29-Apr-11 (No. ES3-3205_Apr11)	Apr-12
DAE4	SN: 601	04-Jul-11 (No. DAE4-601_Jul11)	Jul-12
Secondary Standards	ID #	Check Date (in house)	Scheduled Check
Power sensor HP 8481A	MY41092317	18-Oct-02 (in house check Oct-09)	In house check: Oct-11
RF generator R&S SMT-06	100005	04-Aug-99 (in house check Oct-09)	In house check: Oct-11
Network Analyzer HP 8753E	US37390585 S4206	18-Oct-01 (in house check Oct-10)	In house check: Oct-11

Calibrated by: **Dimce Iliev** (Name) / **Laboratory Technician** (Function) / *[Signature]* (Signature)

Approved by: **Katja Pokovic** (Name) / **Technical Manager** (Function) / *[Signature]* (Signature)

Issued: July 12, 2011

This calibration certificate shall not be reproduced except in full without written approval of the laboratory.



Accredited by the Swiss Accreditation Service (SAS)

Accreditation No.: **SCS 108**

The Swiss Accreditation Service is one of the signatories to the EA
Multilateral Agreement for the recognition of calibration certificates

Glossary:

TSL	tissue simulating liquid
ConvF	sensitivity in TSL / NORM x,y,z
N/A	not applicable or not measured

Calibration is Performed According to the Following Standards:

- IEEE Std 1528-2003, "IEEE Recommended Practice for Determining the Peak Spatial-Averaged Specific Absorption Rate (SAR) in the Human Head from Wireless Communications Devices: Measurement Techniques", December 2003
- IEC 62209-1, "Procedure to measure the Specific Absorption Rate (SAR) for hand-held devices used in close proximity to the ear (frequency range of 300 MHz to 3 GHz)", February 2005
- Federal Communications Commission Office of Engineering & Technology (FCC OET), "Evaluating Compliance with FCC Guidelines for Human Exposure to Radiofrequency Electromagnetic Fields; Additional Information for Evaluating Compliance of Mobile and Portable Devices with FCC Limits for Human Exposure to Radiofrequency Emissions", Supplement C (Edition 01-01) to Bulletin 65

Additional Documentation:

- DASY4/5 System Handbook

Methods Applied and Interpretation of Parameters:

- Measurement Conditions:** Further details are available from the Validation Report at the end of the certificate. All figures stated in the certificate are valid at the frequency indicated.
- Antenna Parameters with TSL:** The dipole is mounted with the spacer to position its feed point exactly below the center marking of the flat phantom section, with the arms oriented parallel to the body axis.
- Feed Point Impedance and Return Loss:** These parameters are measured with the dipole positioned under the liquid filled phantom. The impedance stated is transformed from the measurement at the SMA connector to the feed point. The Return Loss ensures low reflected power. No uncertainty required.
- Electrical Delay:** One-way delay between the SMA connector and the antenna feed point. No uncertainty required.
- SAR measured:** SAR measured at the stated antenna input power.
- SAR normalized:** SAR as measured, normalized to an input power of 1 W at the antenna connector.
- SAR for nominal TSL parameters:** The measured TSL parameters are used to calculate the nominal SAR result.

Measurement Conditions

DASY system configuration, as far as not given on page 1.

DASY Version	DASY5	V52.6.2
Extrapolation	Advanced Extrapolation	
Phantom	Modular Flat Phantom	
Distance Dipole Center - TSL	10 mm	with Spacer
Zoom Scan Resolution	dx, dy, dz = 5 mm	
Frequency	2450 MHz ± 1 MHz	

Head TSL parameters

The following parameters and calculations were applied.

	Temperature	Permittivity	Conductivity
Nominal Head TSL parameters	22.0 °C	39.2	1.80 mho/m
Measured Head TSL parameters	(22.0 ± 0.2) °C	38.9 ± 6 %	1.85 mho/m ± 6 %
Head TSL temperature change during test	< 0.5 °C	----	----

SAR result with Head TSL

SAR averaged over 1 cm³ (1 g) of Head TSL	Condition	
SAR measured	250 mW input power	14.0 mW / g
SAR for nominal Head TSL parameters	normalized to 1W	55.2 mW / g ± 17.0 % (k=2)

SAR averaged over 10 cm³ (10 g) of Head TSL	condition	
SAR measured	250 mW input power	6.49 mW / g
SAR for nominal Head TSL parameters	normalized to 1W	25.8 mW / g ± 16.5 % (k=2)

Body TSL parameters

The following parameters and calculations were applied.

	Temperature	Permittivity	Conductivity
Nominal Body TSL parameters	22.0 °C	52.7	1.95 mho/m
Measured Body TSL parameters	(22.0 ± 0.2) °C	51.7 ± 6 %	2.00 mho/m ± 6 %
Body TSL temperature change during test	< 0.5 °C	----	----

SAR result with Body TSL

SAR averaged over 1 cm³ (1 g) of Body TSL	Condition	
SAR measured	250 mW input power	13.0 mW / g
SAR for nominal Body TSL parameters	normalized to 1W	51.2 mW / g ± 17.0 % (k=2)

SAR averaged over 10 cm³ (10 g) of Body TSL	condition	
SAR measured	250 mW input power	6.02 mW / g
SAR for nominal Body TSL parameters	normalized to 1W	23.9 mW / g ± 16.5 % (k=2)

Appendix

Antenna Parameters with Head TSL

Impedance, transformed to feed point	55.0 Ω + 4.3 j Ω
Return Loss	- 24.1 dB

Antenna Parameters with Body TSL

Impedance, transformed to feed point	49.9 Ω + 5.6 j Ω
Return Loss	- 25.0 dB

General Antenna Parameters and Design

Electrical Delay (one direction)	1.155 ns
----------------------------------	----------

After long term use with 100W radiated power, only a slight warming of the dipole near the feedpoint can be measured.

The dipole is made of standard semirigid coaxial cable. The center conductor of the feeding line is directly connected to the second arm of the dipole. The antenna is therefore short-circuited for DC-signals.

No excessive force must be applied to the dipole arms, because they might bend or the soldered connections near the feedpoint may be damaged.

Additional EUT Data

Manufactured by	SPEAG
Manufactured on	January 24, 2006

DASY5 Validation Report for Head TSL

Date: 7/12/2011

Test Laboratory: SPEAG

DUT: Dipole 2450 MHz; Type: D2450V2; Serial: D2450V2 - SN: 788

Communication System: CW; Frequency: 2450 MHz; Duty Cycle: 1:1

Medium: HBBL 1900-3800V3

Medium parameters used: $f = 2450$ MHz; $\sigma = 1.85$ mho/m; $\epsilon_r = 38.9$; $\rho = 1000$ kg/m³

Phantom section: Flat Section

Measurement Standard: DASY5 (IEEE/IEC/ANSI C63.19-2007)

DASY5 Configuration:

- Probe: ES3DV3 - SN3205; ConvF(4.45, 4.45, 4.45); Calibrated: 4/29/2011
- Sensor-Surface: 3mm (Mechanical Surface Detection)
- Electronics: DAE4 Sn601; Calibrated: 7/4/2011
- Phantom: Flat Phantom 5.0 (front); Type: QD000P50AA; Serial: 1001
- Measurement SW: DASY52, Version 52.6 (2)
- SEMCAD X Version 14.4.5 (3634)

Dipole Calibration for Head Tissue/Pin=250 mW, d=10mm/Zoom Scan (7x7x7)/Cube 0:

Measurement grid: dx=5mm, dy=5mm, dz=5mm

Reference Value = 102.3 V/m; Power Drift = 0.04 dB

Peak SAR (extrapolated) = 28.847 W/kg

SAR(1 g) = 14 mW/g; SAR(10 g) = 6.49 mW/g

Maximum value of SAR (measured) = 17.898 mW/g

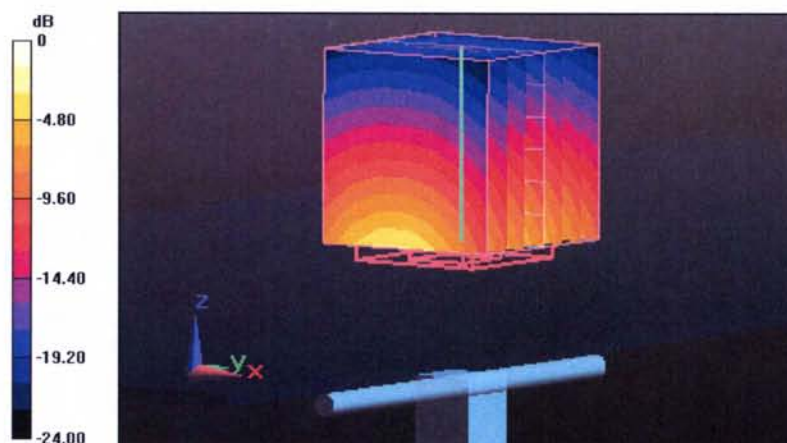

0 dB = 17.900mW/g

Impedance Measurement Plot for Head TSL

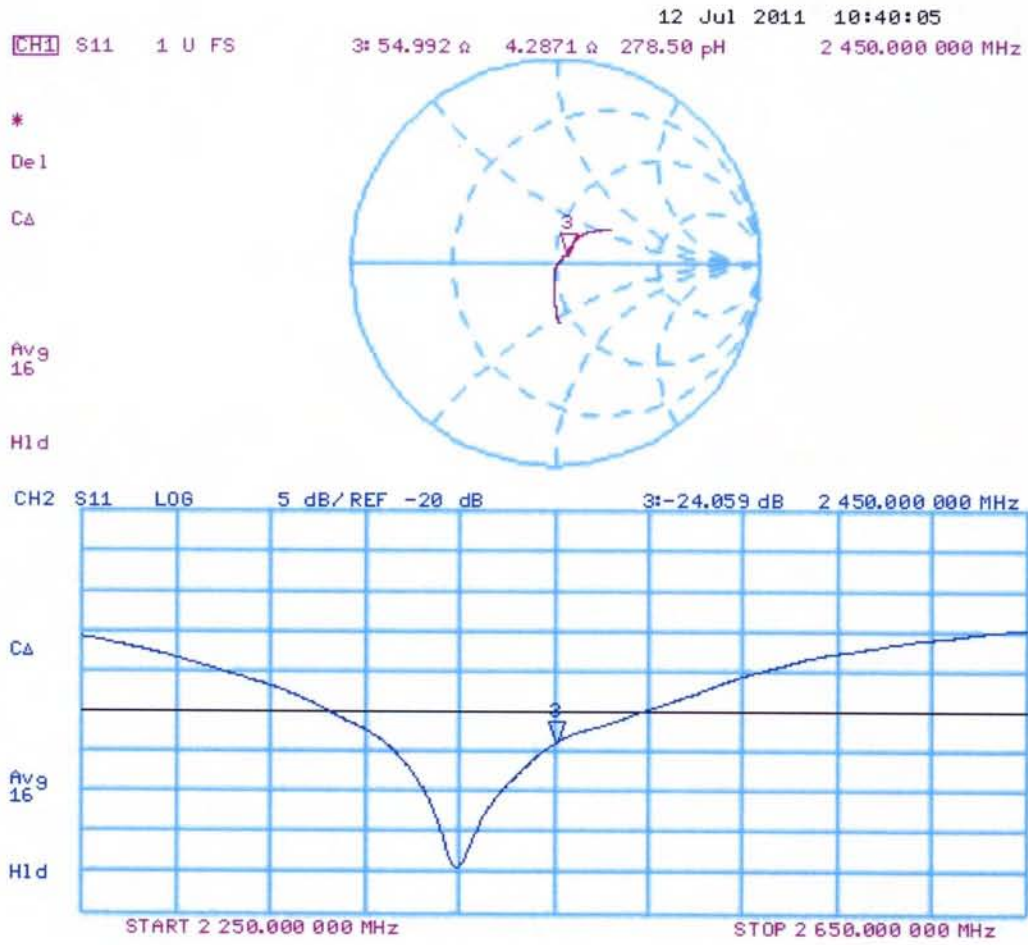

DASY5 Validation Report for Body TSL

Date: 12.07.2011

Test Laboratory: SPEAG, Zurich, Switzerland

DUT: Dipole 2450 MHz; Type: D2450V2; Serial: D2450V2 - SN: 788

Communication System: CW; Frequency: 2450 MHz

Medium parameters used: $f = 2450$ MHz; $\sigma = 2$ mho/m; $\epsilon_r = 51.7$; $\rho = 1000$ kg/m³

Phantom section: Flat Section

Measurement Standard: DASY5 (IEEE/IEC/ANSI C63.19-2007)

DASY52 Configuration:

- Probe: ES3DV3 - SN3205; ConvF(4.26, 4.26, 4.26); Calibrated: 29.04.2011
- Sensor-Surface: 3mm (Mechanical Surface Detection)
- Electronics: DAE4 Sn601; Calibrated: 04.07.2011
- Phantom: Flat Phantom 5.0 (back); Type: QD000P50AA; Serial: 1002
- DASY52 52.6.2(482); SEMCAD X 14.4.5(3634)

Dipole Calibration for Body Tissue/Pin=250 mW, d=10mm/Zoom Scan (7x7x7)/Cube 0:

Measurement grid: dx=5mm, dy=5mm, dz=5mm

Reference Value = 96.028 V/m; Power Drift = 0.01 dB

Peak SAR (extrapolated) = 26.823 W/kg

SAR(1 g) = 13 mW/g; SAR(10 g) = 6.02 mW/g

Maximum value of SAR (measured) = 17.108 mW/g

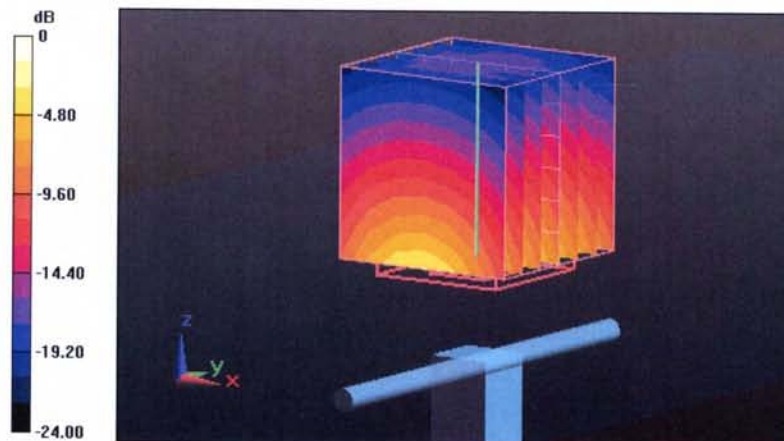

0 dB = 17.110mW/g

Impedance Measurement Plot for Body TSL

12 Jul 2011 10:42:18

[CH1] S11 1 U FS 3: 49.928 Ω 5.6094 Ω 364.39 pF 2 450.000 000 MHz

*

De l

CA

Avg
0

H1 d

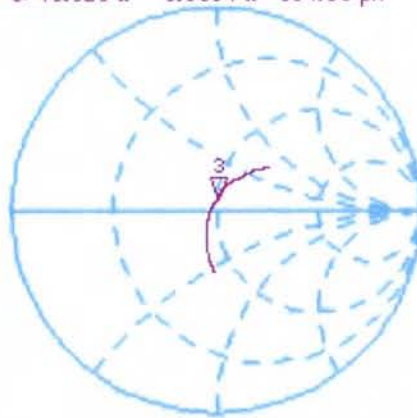

CH2 S11 LOG 5 dB/REF -20 dB 3:-25.025 dB 2 450.000 000 MHz

CA

Avg
0

H1 d



START 2 250.000 000 MHz

STOP 2 650.000 000 MHz

END OF REPORT