

# FCC CERTIFICATION REPORT

Test Report No.: EI/2012/70001

Applicant : Motorola Mobility Inc.

Address of Applicant : 9 F., No.9, Songgao Rd., Taipei 110, Taiwan, R.O.C.

Equipment Under Test (EUT) :

Product Name: ARGON MINI

Marketing Name: MOTOSMART

Brand Name : Motorola

Model No. : XT389 (GPPD : 3345\_VodaFone)

FCC ID: IHDT56NN7

Added Model(s) : N/A

Standards : FCC Part 15:2010, Subpart B, Class B

Date of Receipt : Jul. 02, 2012

Date of Test : Jul. 02 ~ 21, 2012

Date of Issue : Jul. 23, 2012

Test Result :	PASS
---------------	------

In the configuration tested, the EUT complied with the standards specified above.

**Remarks :**

This report details the results of the testing carried out on one sample, the results contained in this test report do not relate to other samples of the same product. The manufacturer should ensure that all products in series production are in conformity with the product sample detailed in this report.

This report shall not be reproduced except in full, without the written approval of the laboratory. If the product in this report is used in any configuration other than that detailed in the report, the manufacturer must ensure the new system complies with all relevant standards.

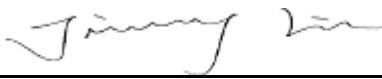
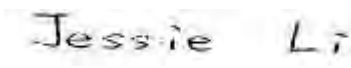
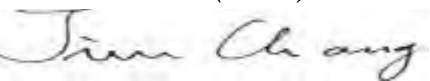
<i>Test By:</i>	 <hr/> <b>Jimmy Liu / Engineer</b>	<i>Date</i>	Jul. 23, 2012
<i>Prepared By:</i>	 <hr/> <b>Jessie Li (Clerk)</b>	<i>Date</i>	Jul. 23, 2012
<i>Approved By</i>	 <hr/> <b>Jim Chang / Supervisor</b>	<i>Date</i>	Jul. 23, 2012

Unless otherwise stated the results shown in this test report refer only to the sample(s) tested and such sample(s) are retained for 90 days only.

除非另有說明，此報告結果僅對測試之樣品負責，同時此樣品僅保留 90 天。本報告未經本公司書面許可，不可部份複製。

This document is issued by the Company subject to its General Conditions of Service printed overleaf, available on request or accessible at [www.sgs.com/terms\\_and\\_conditions.htm](http://www.sgs.com/terms_and_conditions.htm) and, for electronic format documents, subject to Terms and Conditions for Electronic Documents at [www.sgs.com/terms\\_e-document.htm](http://www.sgs.com/terms_e-document.htm). Attention is drawn to the limitation of liability, indemnification and jurisdiction issues defined therein. Any holder of this document is advised that information contained hereon reflects the Company's findings at the time of its intervention only and within the limits of Client's instructions, if any. The Company's sole responsibility is to its Client and this document does not exonerate parties to a transaction from exercising all their rights and obligations under the transaction documents. This document cannot be reproduced except in full, without prior written approval of the Company. Any unauthorized alteration, forgery or falsification of the content or appearance of this document is unlawful and offenders may be prosecuted to the fullest extent of the law.

### Version

Version No.	Description	Date
00	Original report	Jul. 23, 2012

Unless otherwise stated the results shown in this test report refer only to the sample(s) tested and such sample(s) are retained for 90 days only.

除非另有說明，此報告結果僅對測試之樣品負責，同時此樣品僅保留 90 天。本報告未經本公司書面許可，不可部份複製。

This document is issued by the Company subject to its General Conditions of Service printed overleaf, available on request or accessible at [www.sgs.com/terms\\_and\\_conditions.htm](http://www.sgs.com/terms_and_conditions.htm) and, for electronic format documents, subject to Terms and Conditions for Electronic Documents at [www.sgs.com/terms\\_e-document.htm](http://www.sgs.com/terms_e-document.htm). Attention is drawn to the limitation of liability, indemnification and jurisdiction issues defined therein. Any holder of this document is advised that information contained hereon reflects the Company's findings at the time of its intervention only and within the limits of Client's instructions, if any. The Company's sole responsibility is to its Client and this document does not exonerate parties to a transaction from exercising all their rights and obligations under the transaction documents. This document cannot be reproduced except in full, without prior written approval of the Company. Any unauthorized alteration, forgery or falsification of the content or appearance of this document is unlawful and offenders may be prosecuted to the fullest extent of the law.

SGS Taiwan Ltd. No.134, Wu Kung Road, Wuku Industrial Zone, Taipei County, Taiwan / 台北縣五股工業區五工路 134 號

台灣檢驗科技股份有限公司 t (886-2) 2299-3279 f (886-2) 2298-0488 www.tw.sgs.com

# Contents

<b>1. GENERAL INFORMATION .....</b>	<b>5</b>
1.1 APPLICANT & MANUFACTURER INFORMATION .....	5
1.2 GENERAL DESCRIPTION OF EUT.....	5
1.3 DETAILS OF EUT.....	7
1.4 OPERATION PROCEDURE .....	8
1.5 DESCRIPTION OF SUPPORT UNITS .....	8
1.6 MODIFICATION LIST.....	8
1.7 CABLE LIST.....	8
1.8 TEST SET-UP CONFIGURATION .....	9
1.9 MEASUREMENT PROCEDURE .....	11
1.10 STANDARDS APPLICABLE FOR TESTING.....	11
1.11 SUMMARY OF RESULTS.....	11
<b>2. RADIO DISTURBANCE .....</b>	<b>12</b>
2.1 TEST RESULTS.....	12
2.2 FREQUENCY RANGE .....	12
2.3 LIMITS OF CONDUCTED AND RADIATED EMISSION.....	12
2.3.1 LIMIT OF CONDUCTED EMISSION OF FCC PART 15, SUBPART B/CISPR 22.....	12
2.3.2 LIMIT OF RADIATED EMISSIONS OF FCC PART 15, SUBPART B/CISPR 22.....	13
2.4. TEST OF CONDUCTED EMISSION .....	14
2.4.1 TEST EQUIPMENTS.....	14
2.4.2 TEST SITE .....	14
2.4.3 OPERATING ENVIRONMENT .....	14
2.4.3.1 UNCERTAINTY OF CONDUCTED EMISSION.....	14
2.4.3.2 MEASUREMENT LEVEL AND FACTOR CALCULATE METHOD .....	14
2.4.4 MEASUREMENT DATA .....	15
2.5 TEST OF RADIATED EMISSION .....	33
2.5.1 TEST INSTRUMENTS .....	33
2.5.2 TEST SITE .....	34
2.5.3 OPERATING ENVIRONMENT .....	34
2.5.3.1 UNCERTAINTY OF RADIATED EMISSION .....	34
2.5.3.2 MEASUREMENT LEVEL AND FACTOR CALCULATE METHOD .....	34

Unless otherwise stated the results shown in this test report refer only to the sample(s) tested and such sample(s) are retained for 90 days only.

除非另有說明，此報告結果僅對測試之樣品負責，同時此樣品僅保留 90 天。本報告未經本公司書面許可，不可部份複製。

This document is issued by the Company subject to its General Conditions of Service printed overleaf, available on request or accessible at [www.sgs.com/terms\\_and\\_conditions.htm](http://www.sgs.com/terms_and_conditions.htm) and, for electronic format documents, subject to Terms and Conditions for Electronic Documents at [www.sgs.com/terms\\_e-document.htm](http://www.sgs.com/terms_e-document.htm). Attention is drawn to the limitation of liability, indemnification and jurisdiction issues defined therein. Any holder of this document is advised that information contained hereon reflects the Company's findings at the time of its intervention only and within the limits of Client's instructions, if any. The Company's sole responsibility is to its Client and this document does not exonerate parties to a transaction from exercising all their rights and obligations under the transaction documents. This document cannot be reproduced except in full, without prior written approval of the Company. Any unauthorized alteration, forgery or falsification of the content or appearance of this document is unlawful and offenders may be prosecuted to the fullest extent of the law.

SGS Taiwan Ltd.No.134, Wu Kung Road, Wuku Industrial Zone, Taipei County, Taiwan /台北縣五股工業區五工路 134 號

台灣檢驗科技股份有限公司 t (886-2) 2299-3279 f (886-2) 2298-0488 www.tw.sgs.com

## Contents

2.5.4 MEASUREMENT DATA .....	35
<b>3. PHOTOGRAPHS OF TEST .....</b>	<b>錯誤! 尚未定義書籤。</b>
<b>4. PHOTOGRAPHS OF PRODUCT.....</b>	<b>錯誤! 尚未定義書籤。</b>

Unless otherwise stated the results shown in this test report refer only to the sample(s) tested and such sample(s) are retained for 90 days only.

除非另有說明，此報告結果僅對測試之樣品負責，同時此樣品僅保留 90 天。本報告未經本公司書面許可，不可部份複製。

This document is issued by the Company subject to its General Conditions of Service printed overleaf, available on request or accessible at [www.sgs.com/terms\\_and\\_conditions.htm](http://www.sgs.com/terms_and_conditions.htm) and, for electronic format documents, subject to Terms and Conditions for Electronic Documents at [www.sgs.com/terms\\_e-document.htm](http://www.sgs.com/terms_e-document.htm). Attention is drawn to the limitation of liability, indemnification and jurisdiction issues defined therein. Any holder of this document is advised that information contained hereon reflects the Company's findings at the time of its intervention only and within the limits of Client's instructions, if any. The Company's sole responsibility is to its Client and this document does not exonerate parties to a transaction from exercising all their rights and obligations under the transaction documents. This document cannot be reproduced except in full, without prior written approval of the Company. Any unauthorized alteration, forgery or falsification of the content or appearance of this document is unlawful and offenders may be prosecuted to the fullest extent of the law.

SGS Taiwan Ltd.No.134, Wu Kung Road, Wuku Industrial Zone, Taipei County, Taiwan /台北縣五股工業區五工路 134 號

台灣檢驗科技股份有限公司

t (886-2) 2299-3279

f (886-2) 2298-0488

[www.tw.sgs.com](http://www.tw.sgs.com)

# 1. General Information

## 1.1 Applicant & Manufacturer Information

Applicant : Motorola Mobility Inc.

Address of Applicant : 9 F., No.9, Songgao Rd., Taipei 110, Taiwan, R.O.C.

## 1.2 General Description of EUT

Product Name: ARGON MINI

Marketing Name: MOTOSMART

Brand Name : Motorola

Model No. : XT389 (GPPD : 3345\_VodaFone)

FCC ID: IHDT56NN7

Added Model(s) : N/A

Model Difference : N/A

Filing Type : Certification

### Bluetooth:

Frequency Range:	2402 – 2480MHz
Bluetooth Version:	V3.0 +HS
Channel number:	79 channels
Modulation type:	GFSK+π /4DQPSK+8DPSK
Transmit Power:	7.78 dBm (Peak)
Dwell Time:	<= 0.4s
Operating Mode:	Point-to-Point
Antenna Designation:	Embedded inverted-F antenna, -0.40dBi

This test report applies for Bluetooth function.

Unless otherwise stated the results shown in this test report refer only to the sample(s) tested and such sample(s) are retained for 90 days only.

除非另有說明，此報告結果僅對測試之樣品負責，同時此樣品僅保留 90 天。本報告未經本公司書面許可，不可部份複製。

This document is issued by the Company subject to its General Conditions of Service printed overleaf, available on request or accessible at [www.sgs.com/terms\\_and\\_conditions.htm](http://www.sgs.com/terms_and_conditions.htm) and, for electronic format documents, subject to Terms and Conditions for Electronic Documents at [www.sgs.com/terms\\_e-document.htm](http://www.sgs.com/terms_e-document.htm). Attention is drawn to the limitation of liability, indemnification and jurisdiction issues defined therein. Any holder of this document is advised that information contained hereon reflects the Company's findings at the time of its intervention only and within the limits of Client's instructions, if any. The Company's sole responsibility is to its Client and this document does not exonerate parties to a transaction from exercising all their rights and obligations under the transaction documents. This document cannot be reproduced except in full, without prior written approval of the Company. Any unauthorized alteration, forgery or falsification of the content or appearance of this document is unlawful and offenders may be prosecuted to the fullest extent of the law.

SGS Taiwan Ltd.No.134, Wu Kung Road, Wuku Industrial Zone, Taipei County, Taiwan /台北縣五股工業區五工路 134 號

台灣檢驗科技股份有限公司 t (886-2) 2299-3279 f (886-2) 2298-0488 www.tw.sgs.com

GSM:

Cellular Phone Standards Frequency Range and Power:	Operating Frequency		Rated Power
	GSM/GPRS 850, Class 10	824.2 MHz– 848.8 MHz	32.5dBm
	GSM/GPRS 1900, Class 10	1850.2MHz – 1909.8MHz	29.5dBm
Type of Emission:	GSM850: 248KGXW, GSM1900: 248KGXW GPRS850: 243KGXW, GPRS1900: 247KGXW		
Hardware Version:	PCR		
Software Version:	ARGONM_W_0B.0E.00R_S		

WLAN: 802.11 b/g/n

Frequency Range& Channel Number	802.11 b/g: 2412-2462MHz, 11 channels 802.11 n_20MHz: 2412-2462MHz, 11 channels
Rated Power	802.11 b: 21.23dBm (Peak) 802.11 g: 17.64dBm (Peak) 802.11 n_20MHz: 15.26dBm (Peak)
Modulation type	CCK, DQPSK, DBPSK for DSSS 64QAM, 16QAM, QPSK, BPSK for OFDM
Transition Rate:	802.11 b: 1/2/5.5/11 Mbps; 802.11 g: 6/9/12/18/24/36/48/54 Mbps 802.11 n_20MHz: 6.5-72.2Mbps
Antenna Designation	Embedded inverted-F antenna, -0.40dBi

The EUT is compliance with IEEE 802.11 b/g/nStandard.

This report applies for frequency bands: 2412MHz – 2462MHz.

Unless otherwise stated the results shown in this test report refer only to the sample(s) tested and such sample(s) are retained for 90 days only.

除非另有說明，此報告結果僅對測試之樣品負責，同時此樣品僅保留 90 天。本報告未經本公司書面許可，不可部份複製。

This document is issued by the Company subject to its General Conditions of Service printed overleaf, available on request or accessible at [www.sgs.com/terms\\_and\\_conditions.htm](http://www.sgs.com/terms_and_conditions.htm) and, for electronic format documents, subject to Terms and Conditions for Electronic Documents at [www.sgs.com/terms\\_e-document.htm](http://www.sgs.com/terms_e-document.htm). Attention is drawn to the limitation of liability, indemnification and jurisdiction issues defined therein. Any holder of this document is advised that information contained hereon reflects the Company's findings at the time of its intervention only and within the limits of Client's instructions, if any. The Company's sole responsibility is to its Client and this document does not exonerate parties to a transaction from exercising all their rights and obligations under the transaction documents. This document cannot be reproduced except in full, without prior written approval of the Company. Any unauthorized alteration, forgery or falsification of the content or appearance of this document is unlawful and offenders may be prosecuted to the fullest extent of the law.

SGS Taiwan Ltd.No.134, Wu Kung Road, Wuku Industrial Zone, Taipei County, Taiwan /台北縣五股工業區五工路 134 號

台灣檢驗科技股份有限公司 t (886-2) 2299-3279 f (886-2) 2298-0488 www.tw.sgs.com

**1.3 Details of EUT**

Simple Hands-Free:	M/N: SJYN0760A, Supplier: Motorola	
Data Cable:	M/N: SKN6378A, Supplier: Motorola	
Hardware Version:	PCR	
Software Version:	ARGONM_W_0B.0E.00R_S	
Power Supply:	3.7Vdc from rechargeable battery or 5.1Vdc from adapter	
	Adaptor:	M/N: FMP5727A, Supplier: Motorola
	Battery:	M/N: BP6X, Supplier: Motorola

<b>ARGON MINI</b>					
		<i>Config 1</i>	<i>Config 2</i>	<i>Config 3</i>	<i>Config 4</i>
	Applicable standard (FCC )	<b>Part 15B</b>			
	Accessories	UE + Battery + AC Adaptor +USB Cable + SHF	UE + Battery +USB Cable + SHF	UE + Battery + AC Adaptor +USB Cable + SHF	UE + Battery + AC Adaptor +USB Cable + SHF
	Main Function	<b>Speech</b>	<b>Data link</b>	<b>Camera</b>	<b>FM MODE</b>
	Additional Function	BT+WIFI+GPS	Data link	FULL SYSTEM	FM MODE
	<b>Description</b>				
	radiated emission	GSM850/1900	Data link	Recording&Play Recording&MP3	FM 87.6 & FM98.0 & FM107.9
	conducted emission (DC Power)	NA	N/A	N/A	N/A
	conducted emission (AC Power)	GSM850/1900	Data link	Recording&Play Recording&MP3	FM 87.6 & FM98.0 & FM107.9

\*Worst case mode:Config 4 FM Mode for Conducted Emission.

Worst case mode:Config 4 FM Mode for Radiated Emission.

Unless otherwise stated the results shown in this test report refer only to the sample(s) tested and such sample(s) are retained for 90 days only.

除非另有說明，此報告結果僅對測試之樣品負責，同時此樣品僅保留 90 天。本報告未經本公司書面許可，不可部份複製。

This document is issued by the Company subject to its General Conditions of Service printed overleaf, available on request or accessible at [www.sgs.com/terms\\_and\\_conditions.htm](http://www.sgs.com/terms_and_conditions.htm) and, for electronic format documents, subject to Terms and Conditions for Electronic Documents at [www.sgs.com/terms\\_e-document.htm](http://www.sgs.com/terms_e-document.htm). Attention is drawn to the limitation of liability, indemnification and jurisdiction issues defined therein. Any holder of this document is advised that information contained hereon reflects the Company's findings at the time of its intervention only and within the limits of Client's instructions, if any. The Company's sole responsibility is to its Client and this document does not exonerate parties to a transaction from exercising all their rights and obligations under the transaction documents. This document cannot be reproduced except in full, without prior written approval of the Company. Any unauthorized alteration, forgery or falsification of the content or appearance of this document is unlawful and offenders may be prosecuted to the fullest extent of the law.

SGS Taiwan Ltd.No.134, Wu Kung Road, Wuku Industrial Zone, Taipei County, Taiwan /台北縣五股工業區五工路 134 號

台灣檢驗科技股份有限公司

t (886-2) 2299-3279

f (886-2) 2298-0488

www.tw.sgs.com

### 1.4 Operation Procedure

1. Set down EUT with support units and turn on the power of all equipment.
2. Pre-test the EUT in all modes by each model, then figure the worst case out.
3. Tests under the normal operation pattern.

### 1.5 Description of Support Units

PRODUCT	MANUFACTURER	MODEL NO.	SERIAL NO.
NOTEBOOK	IBM	L412	LR-ZYMYD
Radio Communication Analyzer	R&S	CMU200	N/A
GPS Signal Generator	MP9100	MP9100-090021	N/A
Mouse	HP	M-UAE96	390938-001
Printer	HP	DJ3820	CN34L181B1
Signal Generator (FM)	Levear	VP-8194D	N/A
Wireless AP	BUFFALO	WHR-HP-G54	14062514623437
BT Drive	Creative	D200	N/A

### 1.6 Modification List

No modification by SGS Taiwan Electronics & Communication Laboratory.

### 1.7 Cable List

Cable Type	Length	Shield
USB cable	1m	Non-shielding

Unless otherwise stated the results shown in this test report refer only to the sample(s) tested and such sample(s) are retained for 90 days only.

除非另有說明，此報告結果僅對測試之樣品負責，同時此樣品僅保留 90 天。本報告未經本公司書面許可，不可部份複製。

This document is issued by the Company subject to its General Conditions of Service printed overleaf, available on request or accessible at [www.sgs.com/terms\\_and\\_conditions.htm](http://www.sgs.com/terms_and_conditions.htm) and, for electronic format documents, subject to Terms and Conditions for Electronic Documents at [www.sgs.com/terms\\_e-document.htm](http://www.sgs.com/terms_e-document.htm). Attention is drawn to the limitation of liability, indemnification and jurisdiction issues defined therein. Any holder of this document is advised that information contained hereon reflects the Company's findings at the time of its intervention only and within the limits of Client's instructions, if any. The Company's sole responsibility is to its Client and this document does not exonerate parties to a transaction from exercising all their rights and obligations under the transaction documents. This document cannot be reproduced except in full, without prior written approval of the Company. Any unauthorized alteration, forgery or falsification of the content or appearance of this document is unlawful and offenders may be prosecuted to the fullest extent of the law.

SGS Taiwan Ltd. No.134, Wu Kung Road, Wuku Industrial Zone, Taipei County, Taiwan / 台北縣五股工業區五工路 134 號

台灣檢驗科技股份有限公司 t (886-2) 2299-3279 f (886-2) 2298-0488 www.tw.sgs.com

### 1.8 Test Set-Up Configuration

Config1

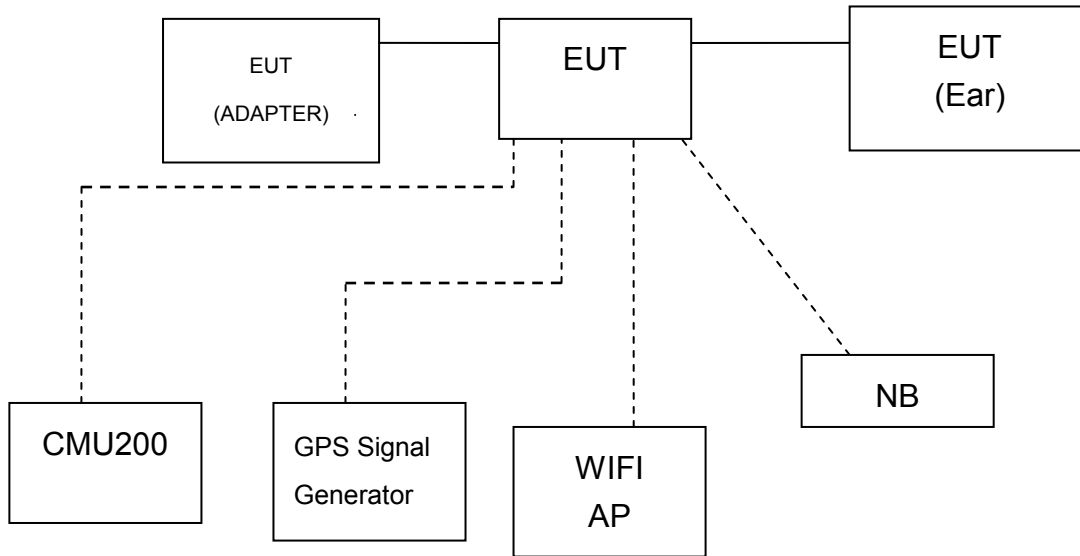

Config2

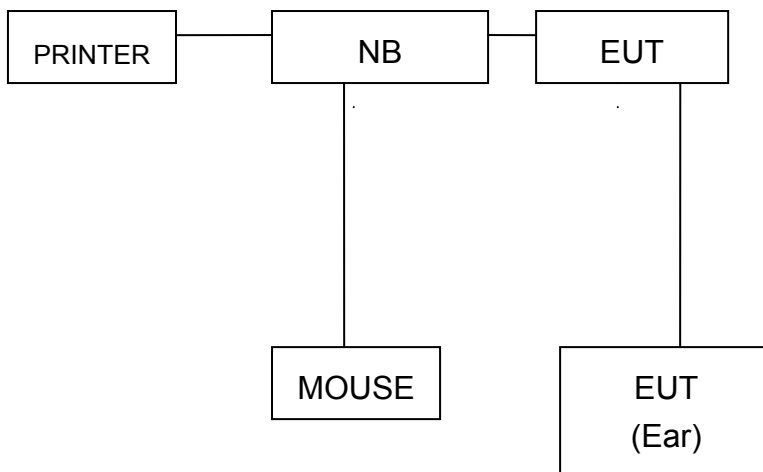

Unless otherwise stated the results shown in this test report refer only to the sample(s) tested and such sample(s) are retained for 90 days only.  
 除非另有說明，此報告結果僅對測試之樣品負責，同時此樣品僅保留 90 天。本報告未經本公司書面許可，不可部份複製。

This document is issued by the Company subject to its General Conditions of Service printed overleaf, available on request or accessible at [www.sgs.com/terms\\_and\\_conditions.htm](http://www.sgs.com/terms_and_conditions.htm) and, for electronic format documents, subject to Terms and Conditions for Electronic Documents at [www.sgs.com/terms\\_e-document.htm](http://www.sgs.com/terms_e-document.htm). Attention is drawn to the limitation of liability, indemnification and jurisdiction issues defined therein. Any holder of this document is advised that information contained hereon reflects the Company's findings at the time of its intervention only and within the limits of Client's instructions, if any. The Company's sole responsibility is to its Client and this document does not exonerate parties to a transaction from exercising all their rights and obligations under the transaction documents. This document cannot be reproduced except in full, without prior written approval of the Company. Any unauthorized alteration, forgery or falsification of the content or appearance of this document is unlawful and offenders may be prosecuted to the fullest extent of the law.

Config3

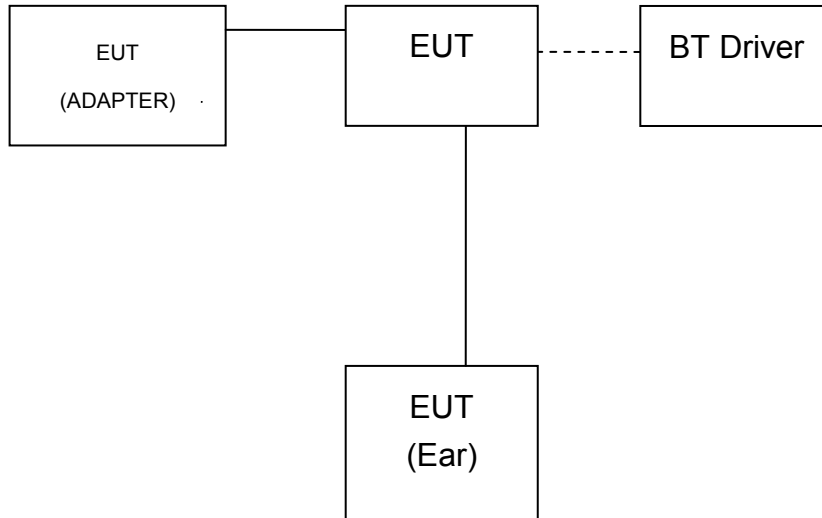

Config4

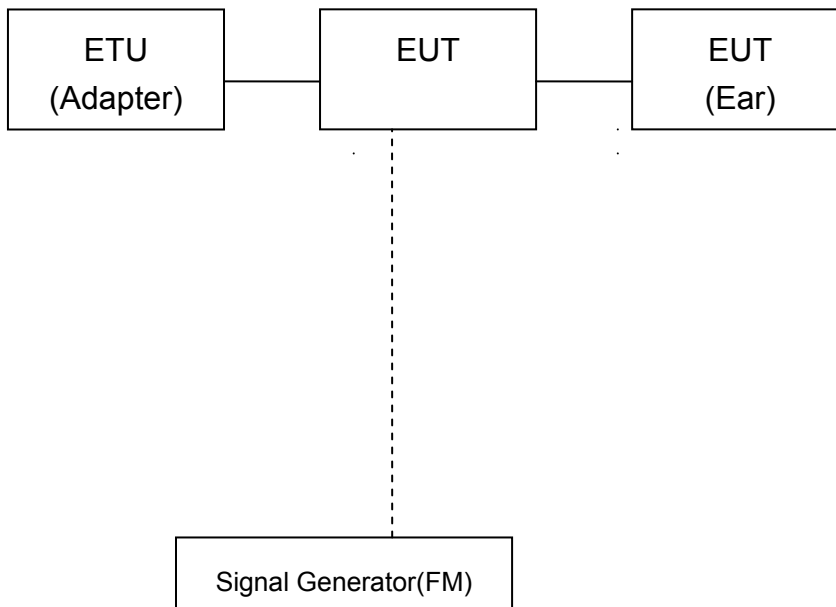

Unless otherwise stated the results shown in this test report refer only to the sample(s) tested and such sample(s) are retained for 90 days only.  
 除非另有說明，此報告結果僅對測試之樣品負責，同時此樣品僅保留 90 天。本報告未經本公司書面許可，不可部份複製。

This document is issued by the Company subject to its General Conditions of Service printed overleaf, available on request or accessible at [www.sgs.com/terms\\_and\\_conditions.htm](http://www.sgs.com/terms_and_conditions.htm) and, for electronic format documents, subject to Terms and Conditions for Electronic Documents at [www.sgs.com/terms\\_e-document.htm](http://www.sgs.com/terms_e-document.htm). Attention is drawn to the limitation of liability, indemnification and jurisdiction issues defined therein. Any holder of this document is advised that information contained hereon reflects the Company's findings at the time of its intervention only and within the limits of Client's instructions, if any. The Company's sole responsibility is to its Client and this document does not exonerate parties to a transaction from exercising all their rights and obligations under the transaction documents. This document cannot be reproduced except in full, without prior written approval of the Company. Any unauthorized alteration, forgery or falsification of the content or appearance of this document is unlawful and offenders may be prosecuted to the fullest extent of the law.

SGS Taiwan Ltd.No.134, Wu Kung Road, Wuku Industrial Zone, Taipei County, Taiwan /台北縣五股工業區五工路 134 號

台灣檢驗科技股份有限公司 t (886-2) 2299-3279 f (886-2) 2298-0488 www.tw.sgs.com

### 1.9 Measurement Procedure

Conducted Emission Testing was performed according ANSI C63.4:2003 in a shielded room with peripherals placed on a table, 0.8m high over a metal floor. It was located more than required distance away from the shielded room wall.

Radiated Emission Testing was performed according to ANSI C63.4:2003 at the 9\*6\*6 3m Semi-Anechoic chamber test site. The EUT was placed in a 0.8m high table along with the peripherals. The turn table was separated from the antenna distance 3meters. Cables were placed in a position to produce maximum emissions as determined by experimentation, and operation mode was selected for maximum. The frequencies and amplitudes of maximum emission were measured at varying azimuths, antenna heights and antenna polarities. Reported are maximized emission levels.

### 1.10 Standards Applicable for Testing

Table of tests to be carried out under FCC Part 15, Subpart B

Test Standards	Status
FCC Part 15, Subpart B	Applicable
Deviation from Standard	No Deviation

### 1.11 Summary of Results

Highest Emission					
Standard	Test Type	Result	Phase/Polar.	Frequency (MHz)	Margin(dB)
FCC Part 15 Subpart B Class B/CISPR 22	Conducted Emission	PASS	Line	1.6495	-8.26(QP)
			Neutral	1.4892	-8.09(AVG)
	Radiated Emission	PASS	Ver.	30.0000	-5.50(QP)

Unless otherwise stated the results shown in this test report refer only to the sample(s) tested and such sample(s) are retained for 90 days only.

除非另有說明，此報告結果僅對測試之樣品負責，同時此樣品僅保留 90 天。本報告未經本公司書面許可，不可部份複製。

This document is issued by the Company subject to its General Conditions of Service printed overleaf, available on request or accessible at [www.sgs.com/terms\\_and\\_conditions.htm](http://www.sgs.com/terms_and_conditions.htm) and, for electronic format documents, subject to Terms and Conditions for Electronic Documents at [www.sgs.com/terms\\_e-document.htm](http://www.sgs.com/terms_e-document.htm). Attention is drawn to the limitation of liability, indemnification and jurisdiction issues defined therein. Any holder of this document is advised that information contained hereon reflects the Company's findings at the time of its intervention only and within the limits of Client's instructions, if any. The Company's sole responsibility is to its Client and this document does not exonerate parties to a transaction from exercising all their rights and obligations under the transaction documents. This document cannot be reproduced except in full, without prior written approval of the Company. Any unauthorized alteration, forgery or falsification of the content or appearance of this document is unlawful and offenders may be prosecuted to the fullest extent of the law.

SGS Taiwan Ltd.No.134, Wu Kung Road, Wuku Industrial Zone, Taipei County, Taiwan /台北縣五股工業區五工路 134 號

台灣檢驗科技股份有限公司 t (886-2) 2299-3279 f (886-2) 2298-0488 www.tw.sgs.com

**2. Radio Disturbance**

**2.1 Test Results**

	Results
Conducted Emission	Pass
Radiated Emission	Pass

**2.2 Frequency Range**

Conducted Emission : 150 kHz - 30 MHz

Radiated Emission : See below table

Highest frequency generated or used in the device or on which the device operates or tunes (MHz)	Upper frequency of measurement range (MHz)
Below 1.705	30
1.705 - 108	1000
108 - 500	2000
500 - 1000	5000
Above 1000	5th harmonic of the highest frequency or 40 GHz, whichever is lower

**2.3 Limits Of Conducted And Radiated Emission**

**2.3.1 Limit Of Conducted Emission Of FCC Part 15, Subpart B/CISPR 22**

FREQUENCY (MHz)	Class A (dBuV)		Class B (dBuV)	
	Quasi - peak	Average	Quasi - peak	Average
0.15 - 0.5	79	66	66 - 56	56 - 46
0.50 - 5.0	73	60	56	46
5.0 - 30.0	73	60	60	50

- Note : (1) The lower limit shall apply at the transition frequencies.  
 (2) The limit decreases linearly with the logarithm of the frequency in the range 0.15 to 0.50 MHz.  
 (3) All emanation from a class A/B digital device or system, including any network of conductors and apparatus connected there to, shall not exceed the level of field strengths specified above.

Unless otherwise stated the results shown in this test report refer only to the sample(s) tested and such sample(s) are retained for 90 days only.  
 除非另有說明，此報告結果僅對測試之樣品負責，同時此樣品僅保留 90 天。本報告未經本公司書面許可，不可部份複製。  
 This document is issued by the Company subject to its General Conditions of Service printed overleaf, available on request or accessible at [www.sgs.com/terms\\_and\\_conditions.htm](http://www.sgs.com/terms_and_conditions.htm) and, for electronic format documents, subject to Terms and Conditions for Electronic Documents at [www.sgs.com/terms\\_e-document.htm](http://www.sgs.com/terms_e-document.htm). Attention is drawn to the limitation of liability, indemnification and jurisdiction issues defined therein. Any holder of this document is advised that information contained hereon reflects the Company's findings at the time of its intervention only and within the limits of Client's instructions, if any. The Company's sole responsibility is to its Client and this document does not exonerate parties to a transaction from exercising all their rights and obligations under the transaction documents. This document cannot be reproduced except in full, without prior written approval of the Company. Any unauthorized alteration, forgery or falsification of the content or appearance of this document is unlawful and offenders may be prosecuted to the fullest extent of the law.

### 2.3.2 Limit Of Radiated Emissions Of FCC Part 15, Subpart B/CISPR 22

**FCC Limit:**

- Detector Function : Quasi – Peak

FREQUENCY (MHz)	Class A (at 10m)	Class B (at 3m)
	dBuV/m	dBuV/m
30~88	39	40
88~216	43.5	43.5
216~960	46.44	46
Above 960	49.54	54

- Detector Function : Peak , Average

FREQUENCY (MHz)	Class A (dBuV) (at 3m)		Class B (dBuV) (at 3m)	
	Peak	Average	Peak	Average
Above 1000	79.3	59.3	73.9	53.9

**CISPR Limit:**

- Detector Function : Quasi – Peak

FREQUENCY (MHz)	Class A (at 10m)	Class B (at 10m)
	dBuV/m	dBuV/m
30-230	40	30
230-1000	47	37

- Detector Function : Peak , Average – Class A

Frequency range GHz	Average Limit dB(µV/m)	Peak Limit dB(µV/m)
1 to 3	56	76
3 to 6	60	80

- Detector Function : Peak , Average – Class B

Frequency range GHz	Average Limit dB(µV/m)	Peak Limit dB(µV/m)
1 to 3	50	70
3 to 6	54	74

Note : The lower limit applies at the transition frequency.

Unless otherwise stated the results shown in this test report refer only to the sample(s) tested and such sample(s) are retained for 90 days only.

除非另有說明，此報告結果僅對測試之樣品負責，同時此樣品僅保留 90 天。本報告未經本公司書面許可，不可部份複製。

This document is issued by the Company subject to its General Conditions of Service printed overleaf, available on request or accessible at [www.sgs.com/terms\\_and\\_conditions.htm](http://www.sgs.com/terms_and_conditions.htm) and, for electronic format documents, subject to Terms and Conditions for Electronic Documents at [www.sgs.com/terms\\_e-document.htm](http://www.sgs.com/terms_e-document.htm). Attention is drawn to the limitation of liability, indemnification and jurisdiction issues defined therein. Any holder of this document is advised that information contained hereon reflects the Company's findings at the time of its intervention only and within the limits of Client's instructions, if any. The Company's sole responsibility is to its Client and this document does not exonerate parties to a transaction from exercising all their rights and obligations under the transaction documents. This document cannot be reproduced except in full, without prior written approval of the Company. Any unauthorized alteration, forgery or falsification of the content or appearance of this document is unlawful and offenders may be prosecuted to the fullest extent of the law.

## 2.4. Test of Conducted Emission

### 2.4.1 Test Equipments

Description	Manufacturer	Model No.	Serial No.	Last Calibration Date	Next Calibration Date
EMI Test Receiver	ROHDE&SCHWARZ	ESCS 30	828985/004	Sep. 23, 2011	Sep. 22, 2012
Coaxial Cables	N/A	WK CE Cable	N/A	Jan. 04, 2012	Jan. 03, 2013
L.I.S.N	Rolf-Heine	NNB-2/16Z	99012	Mar. 23, 2012	Mar. 22, 2013
L.I.S.N	FCC	FCC-LISN-50/250-25-2-01	04034	Mar. 23, 2012	Mar. 22, 2013
Software	Farad	EZ-EMC-VER2A1.1(USB)	N/A	N/A	N/A

### 2.4.2 Test Site

SGS Taiwan LTD. Electronics & Communication Laboratory  
 No.134, Wu Kung Road. Wuku Industrial Zone, Taipei County 248, Taiwan (R.O.C.)

### 2.4.3 Operating Environment

Temperature : 26 degree C                      Humidity : 60 %RH  
 Atmospheric Pressure : 996 mBar

#### 2.4.3.1 Uncertainty of Conducted Emission

Expanded uncertainty (k=2) of Conducted Emission measurement is 0.98dB.

#### 2.4.3.2 Measurement level and Factor calculate method

Factor = LISN insertion loss + Cable loss  
 Measurement Level = Reading Level + Factor

Unless otherwise stated the results shown in this test report refer only to the sample(s) tested and such sample(s) are retained for 90 days only.

除非另有說明，此報告結果僅對測試之樣品負責，同時此樣品僅保留 90 天。本報告未經本公司書面許可，不可部份複製。

This document is issued by the Company subject to its General Conditions of Service printed overleaf, available on request or accessible at [www.sgs.com/terms\\_and\\_conditions.htm](http://www.sgs.com/terms_and_conditions.htm) and, for electronic format documents, subject to Terms and Conditions for Electronic Documents at [www.sgs.com/terms\\_e-document.htm](http://www.sgs.com/terms_e-document.htm). Attention is drawn to the limitation of liability, indemnification and jurisdiction issues defined therein. Any holder of this document is advised that information contained hereon reflects the Company's findings at the time of its intervention only and within the limits of Client's instructions, if any. The Company's sole responsibility is to its Client and this document does not exonerate parties to a transaction from exercising all their rights and obligations under the transaction documents. This document cannot be reproduced except in full, without prior written approval of the Company. Any unauthorized alteration, forgery or falsification of the content or appearance of this document is unlawful and offenders may be prosecuted to the fullest extent of the law.

SGS Taiwan Ltd. No.134, Wu Kung Road, Wuku Industrial Zone, Taipei County, Taiwan / 台北縣五股工業區五工路 134 號

台灣檢驗科技股份有限公司      t (886-2) 2299-3279      f (886-2) 2298-0488      www.tw.sgs.com

## 2.4.4 Measurement Data

### Config 1:GSM850

L



Unless otherwise stated the results shown in this test report refer only to the sample(s) tested and such sample(s) are retained for 90 days only.

除非另有說明，此報告結果僅對測試之樣品負責，同時此樣品僅保留 90 天。本報告未經本公司書面許可，不可部份複製。

This document is issued by the Company subject to its General Conditions of Service printed overleaf, available on request or accessible at [www.sgs.com/terms\\_and\\_conditions.htm](http://www.sgs.com/terms_and_conditions.htm) and, for electronic format documents, subject to Terms and Conditions for Electronic Documents at [www.sgs.com/terms\\_e-document.htm](http://www.sgs.com/terms_e-document.htm). Attention is drawn to the limitation of liability, indemnification and jurisdiction issues defined therein. Any holder of this document is advised that information contained hereon reflects the Company's findings at the time of its intervention only and within the limits of Client's instructions, if any. The Company's sole responsibility is to its Client and this document does not exonerate parties to a transaction from exercising all their rights and obligations under the transaction documents. This document cannot be reproduced except in full, without prior written approval of the Company. Any unauthorized alteration, forgery or falsification of the content or appearance of this document is unlawful and offenders may be prosecuted to the fullest extent of the law.

SGS Taiwan Ltd.No.134, Wu Kung Road, Wuku Industrial Zone, Taipei County, Taiwan /台北縣五股工業區五工路 134 號

台灣檢驗科技股份有限公司 t (886-2) 2299-3279 f (886-2) 2298-0488 www.tw.sgs.com

N

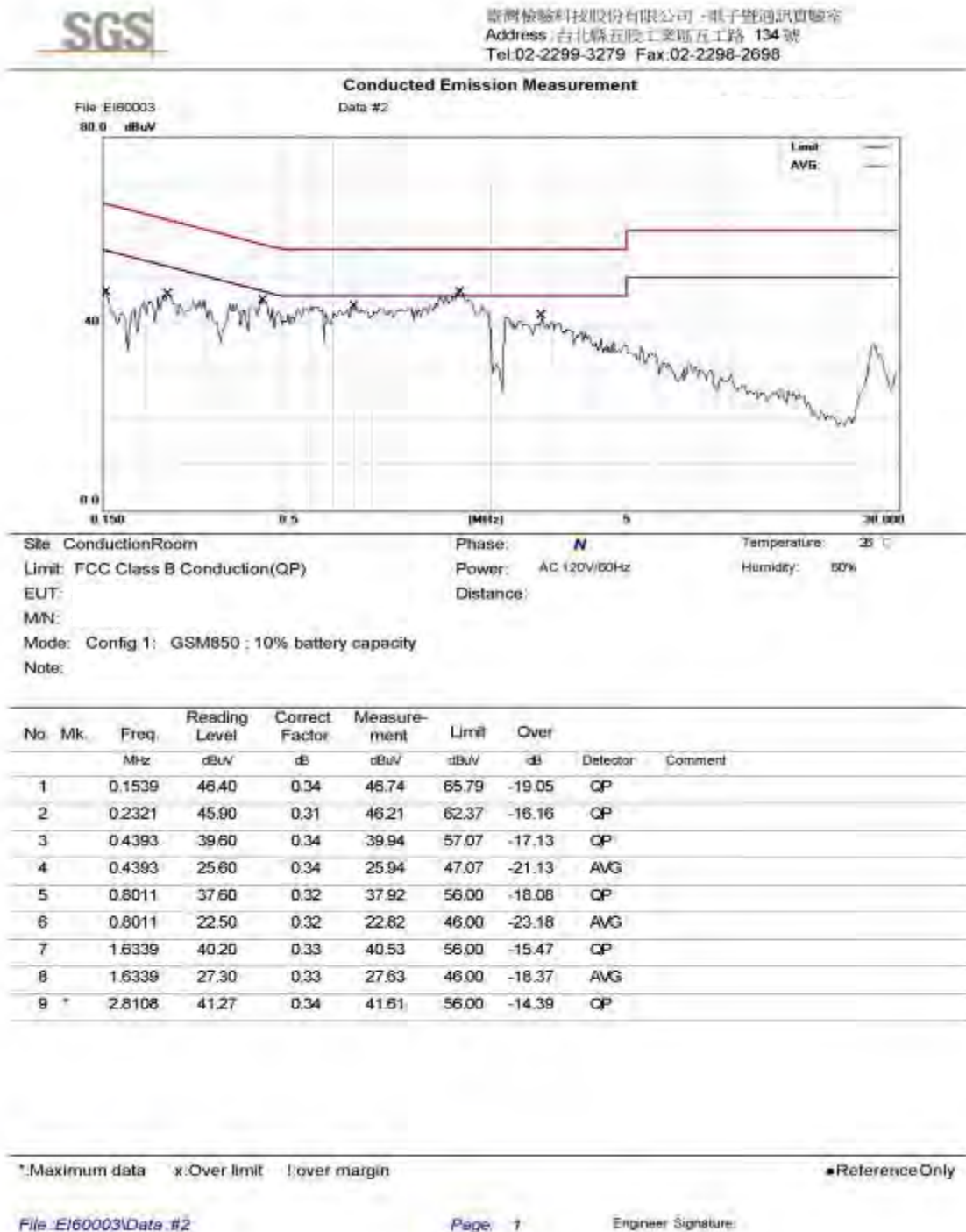

Unless otherwise stated the results shown in this test report refer only to the sample(s) tested and such sample(s) are retained for 90 days only.

除非另有說明，此報告結果僅對測試之樣品負責，同時此樣品僅保留 90 天。本報告未經本公司書面許可，不可部份複製。

This document is issued by the Company subject to its General Conditions of Service printed overleaf, available on request or accessible at [www.sgs.com/terms\\_and\\_conditions.htm](http://www.sgs.com/terms_and_conditions.htm) and, for electronic format documents, subject to Terms and Conditions for Electronic Documents at [www.sgs.com/terms\\_e-document.htm](http://www.sgs.com/terms_e-document.htm). Attention is drawn to the limitation of liability, indemnification and jurisdiction issues defined therein. Any holder of this document is advised that information contained hereon reflects the Company's findings at the time of its intervention only and within the limits of Client's instructions, if any. The Company's sole responsibility is to its Client and this document does not exonerate parties to a transaction from exercising all their rights and obligations under the transaction documents. This document cannot be reproduced except in full, without prior written approval of the Company. Any unauthorized alteration, forgery or falsification of the content or appearance of this document is unlawful and offenders may be prosecuted to the fullest extent of the law.

SGS Taiwan Ltd. No.134, Wu Kung Road, Wuku Industrial Zone, Taipei County, Taiwan / 台北縣五股工業區五工路 134 號

台灣檢驗科技股份有限公司    t (886-2) 2299-3279    f (886-2) 2298-0488    www.tw.sgs.com

Config 1:GSM1900

L

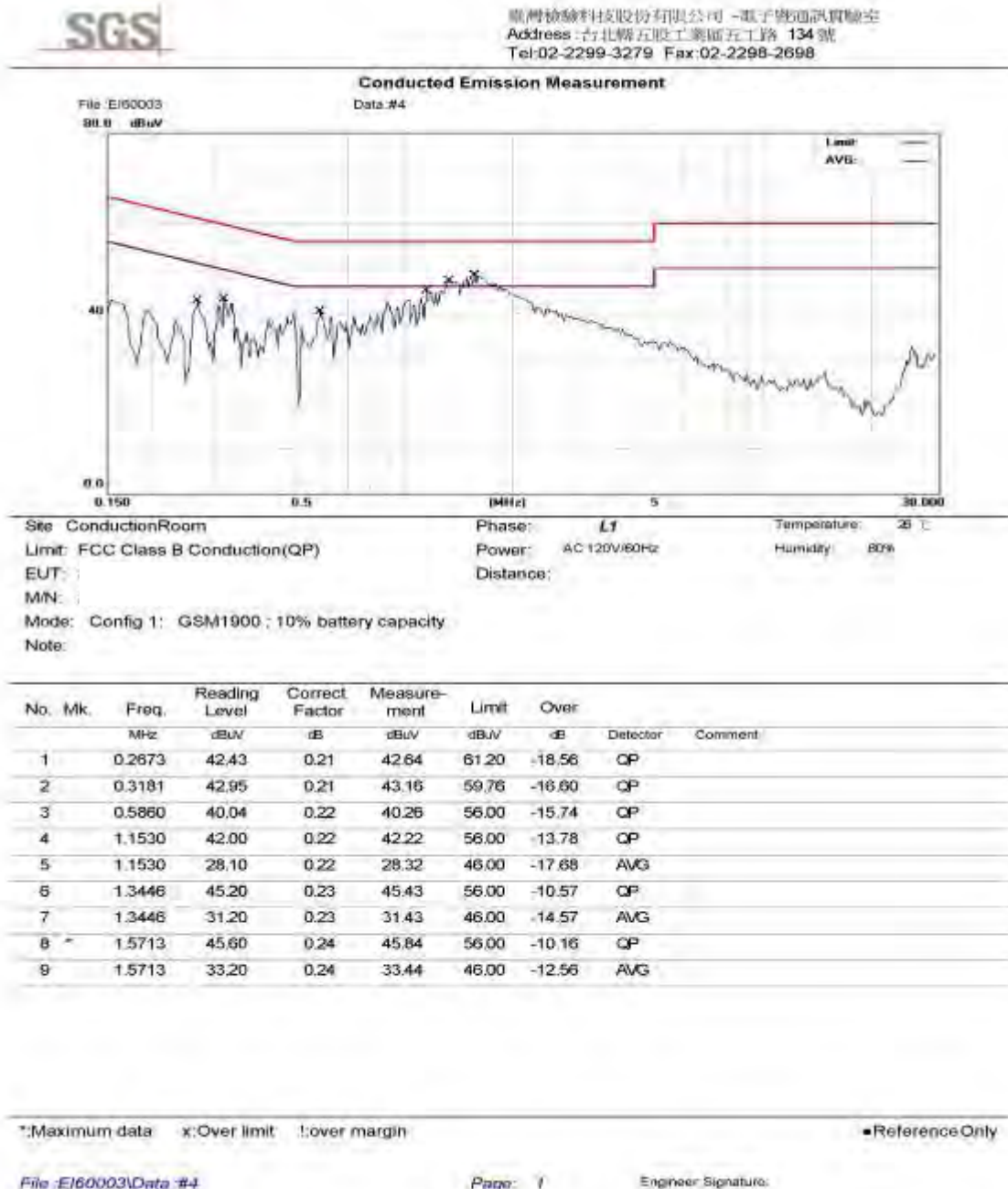

Unless otherwise stated the results shown in this test report refer only to the sample(s) tested and such sample(s) are retained for 90 days only.

除非另有說明，此報告結果僅對測試之樣品負責，同時此樣品僅保留 90 天。本報告未經本公司書面許可，不可部份複製。

This document is issued by the Company subject to its General Conditions of Service printed overleaf, available on request or accessible at [www.sgs.com/terms\\_and\\_conditions.htm](http://www.sgs.com/terms_and_conditions.htm) and, for electronic format documents, subject to Terms and Conditions for Electronic Documents at [www.sgs.com/terms\\_e-document.htm](http://www.sgs.com/terms_e-document.htm). Attention is drawn to the limitation of liability, indemnification and jurisdiction issues defined therein. Any holder of this document is advised that information contained hereon reflects the Company's findings at the time of its intervention only and within the limits of Client's instructions, if any. The Company's sole responsibility is to its Client and this document does not exonerate parties to a transaction from exercising all their rights and obligations under the transaction documents. This document cannot be reproduced except in full, without prior written approval of the Company. Any unauthorized alteration, forgery or falsification of the content or appearance of this document is unlawful and offenders may be prosecuted to the fullest extent of the law.

SGS Taiwan Ltd.No.134, Wu Kung Road, Wuku Industrial Zone, Taipei County, Taiwan /台北縣五股工業區五工路 134 號

台灣檢驗科技股份有限公司 t (886-2) 2299-3279 f (886-2) 2298-0488 www.tw.sgs.com

N

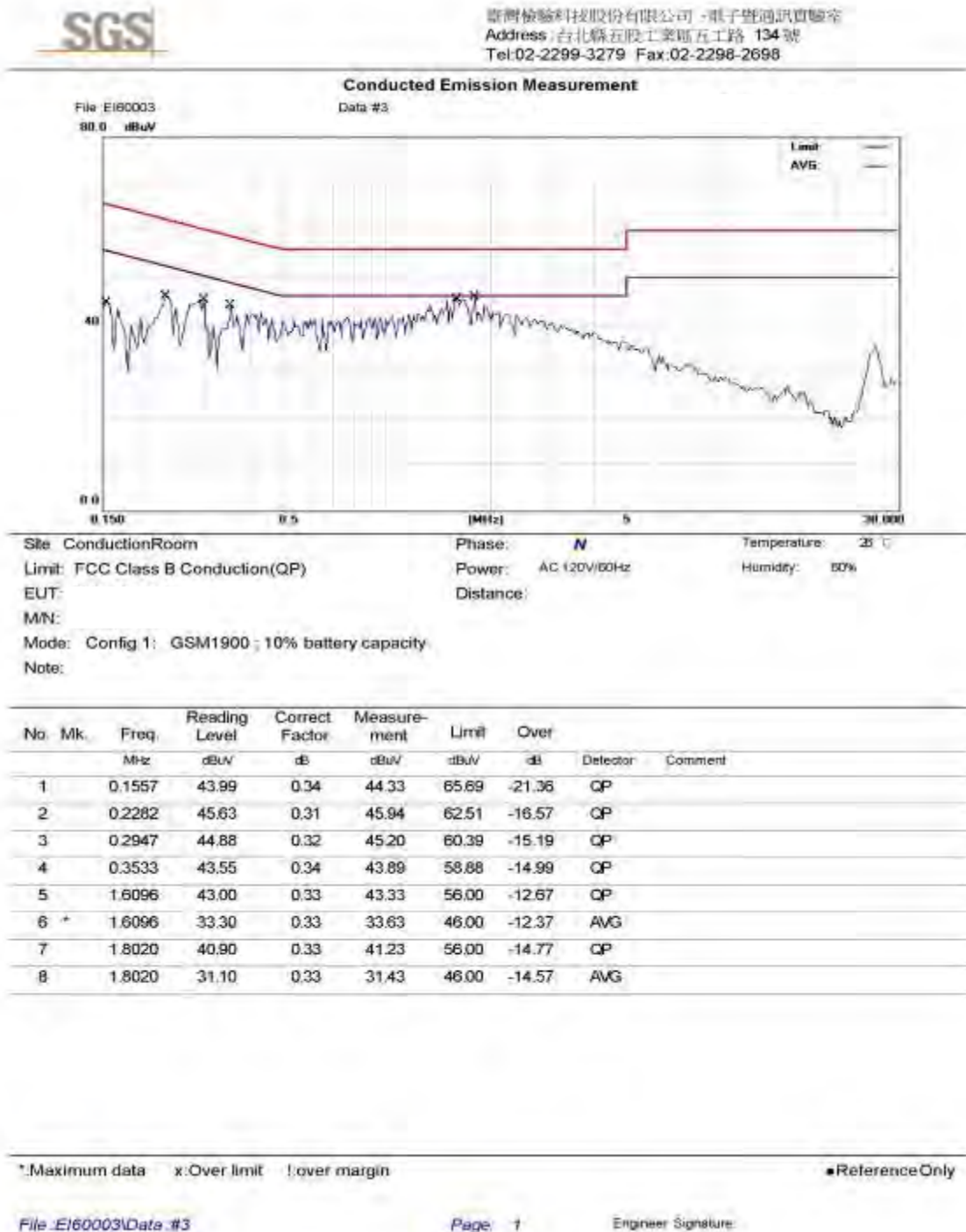

Unless otherwise stated the results shown in this test report refer only to the sample(s) tested and such sample(s) are retained for 90 days only.

除非另有說明，此報告結果僅對測試之樣品負責，同時此樣品僅保留 90 天。本報告未經本公司書面許可，不可部份複製。

This document is issued by the Company subject to its General Conditions of Service printed overleaf, available on request or accessible at [www.sgs.com/terms\\_and\\_conditions.htm](http://www.sgs.com/terms_and_conditions.htm) and, for electronic format documents, subject to Terms and Conditions for Electronic Documents at [www.sgs.com/terms\\_e-document.htm](http://www.sgs.com/terms_e-document.htm). Attention is drawn to the limitation of liability, indemnification and jurisdiction issues defined therein. Any holder of this document is advised that information contained hereon reflects the Company's findings at the time of its intervention only and within the limits of Client's instructions, if any. The Company's sole responsibility is to its Client and this document does not exonerate parties to a transaction from exercising all their rights and obligations under the transaction documents. This document cannot be reproduced except in full, without prior written approval of the Company. Any unauthorized alteration, forgery or falsification of the content or appearance of this document is unlawful and offenders may be prosecuted to the fullest extent of the law.

SGS Taiwan Ltd. No.134, Wu Kung Road, Wuku Industrial Zone, Taipei County, Taiwan / 台北縣五股工業區五工路 134 號

台灣檢驗科技股份有限公司      t (886-2) 2299-3279      f (886-2) 2298-0488      www.tw.sgs.com

## Config 2:Data Link

L

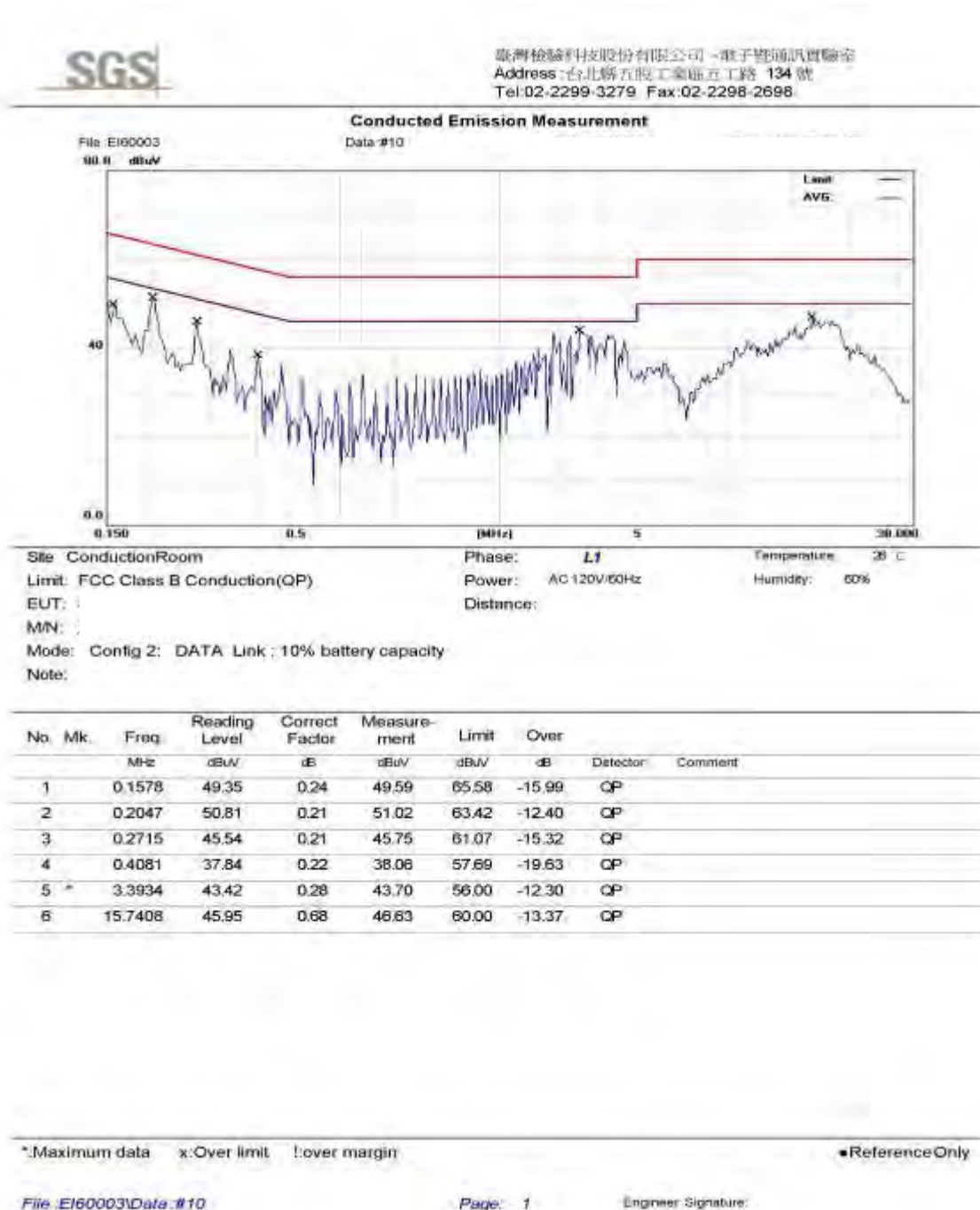

Unless otherwise stated the results shown in this test report refer only to the sample(s) tested and such sample(s) are retained for 90 days only.

除非另有說明，此報告結果僅對測試之樣品負責，同時此樣品僅保留 90 天。本報告未經本公司書面許可，不可部份複製。

This document is issued by the Company subject to its General Conditions of Service printed overleaf, available on request or accessible at [www.sgs.com/terms\\_and\\_conditions.htm](http://www.sgs.com/terms_and_conditions.htm) and, for electronic format documents, subject to Terms and Conditions for Electronic Documents at [www.sgs.com/terms\\_e-document.htm](http://www.sgs.com/terms_e-document.htm). Attention is drawn to the limitation of liability, indemnification and jurisdiction issues defined therein. Any holder of this document is advised that information contained hereon reflects the Company's findings at the time of its intervention only and within the limits of Client's instructions, if any. The Company's sole responsibility is to its Client and this document does not exonerate parties to a transaction from exercising all their rights and obligations under the transaction documents. This document cannot be reproduced except in full, without prior written approval of the Company. Any unauthorized alteration, forgery or falsification of the content or appearance of this document is unlawful and offenders may be prosecuted to the fullest extent of the law.

SGS Taiwan Ltd.No.134, Wu Kung Road, Wuku Industrial Zone, Taipei County, Taiwan /台北縣五股工業區五工路 134 號

台灣檢驗科技股份有限公司 t (886-2) 2299-3279 f (886-2) 2298-0488 www.tw.sgs.com

N

SGS  
 臺灣檢驗科技股份有限公司 - 電子暨通訊實驗室  
 Address: 台北縣五股工業區五工路 134 號  
 Tel: 02-2299-3279 Fax: 02-2298-2698

Conducted Emission Measurement

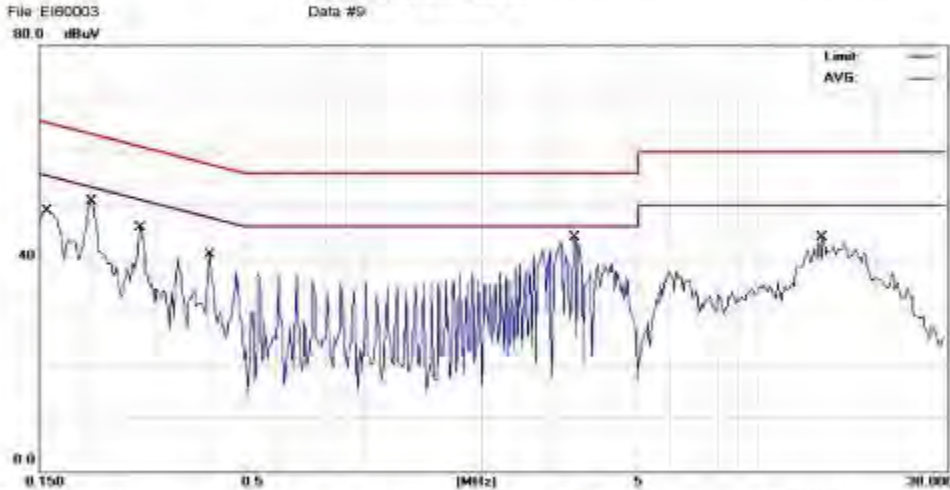

Site: ConductionRoom Phase: N Temperature: 25 C  
 Limit: FCC Class B Conduction(QP) Power: AC (20V/60Hz) Humidity: 50%  
 EUT: Distance:  
 MN:  
 Mode: Config 2: DATA Link ; 10% battery capacity  
 Note:

No.	Mk.	Freq. (MHz)	Reading Level (dBuV)	Correct Factor (dB)	Measurement (dBuV)	Limit (dBuV)	Over (dB)	Detector	Comment
1		0.1578	48.52	0.34	48.86	65.58	-16.72	QP	
2		0.2047	50.35	0.31	50.66	63.42	-12.76	QP	
3		0.2712	45.37	0.32	45.69	61.08	-15.39	QP	
4		0.4081	40.36	0.34	40.70	57.69	-16.99	QP	
5	*	3.4520	43.63	0.34	43.97	56.00	-12.03	QP	
6		14.7046	43.30	0.60	43.90	60.00	-16.10	QP	

\*Maximum data x:Over limit !:over margin ■Reference Only

File :EI60003\Data :#9

Page : 1

Engineer Signature:

Unless otherwise stated the results shown in this test report refer only to the sample(s) tested and such sample(s) are retained for 90 days only.

除非另有說明，此報告結果僅對測試之樣品負責，同時此樣品僅保留 90 天。本報告未經本公司書面許可，不可部份複製。

This document is issued by the Company subject to its General Conditions of Service printed overleaf, available on request or accessible at [www.sgs.com/terms\\_and\\_conditions.htm](http://www.sgs.com/terms_and_conditions.htm) and, for electronic format documents, subject to Terms and Conditions for Electronic Documents at [www.sgs.com/terms\\_e-document.htm](http://www.sgs.com/terms_e-document.htm). Attention is drawn to the limitation of liability, indemnification and jurisdiction issues defined therein. Any holder of this document is advised that information contained hereon reflects the Company's findings at the time of its intervention only and within the limits of Client's instructions, if any. The Company's sole responsibility is to its Client and this document does not exonerate parties to a transaction from exercising all their rights and obligations under the transaction documents. This document cannot be reproduced except in full, without prior written approval of the Company. Any unauthorized alteration, forgery or falsification of the content or appearance of this document is unlawful and offenders may be prosecuted to the fullest extent of the law.

SGS Taiwan Ltd.No.134, Wu Kung Road, Wuku Industrial Zone, Taipei County, Taiwan /台北縣五股工業區五工路 134 號

台灣檢驗科技股份有限公司 t (886-2) 2299-3279 f (886-2) 2298-0488 www.tw.sgs.com

## Config 3:Recording L

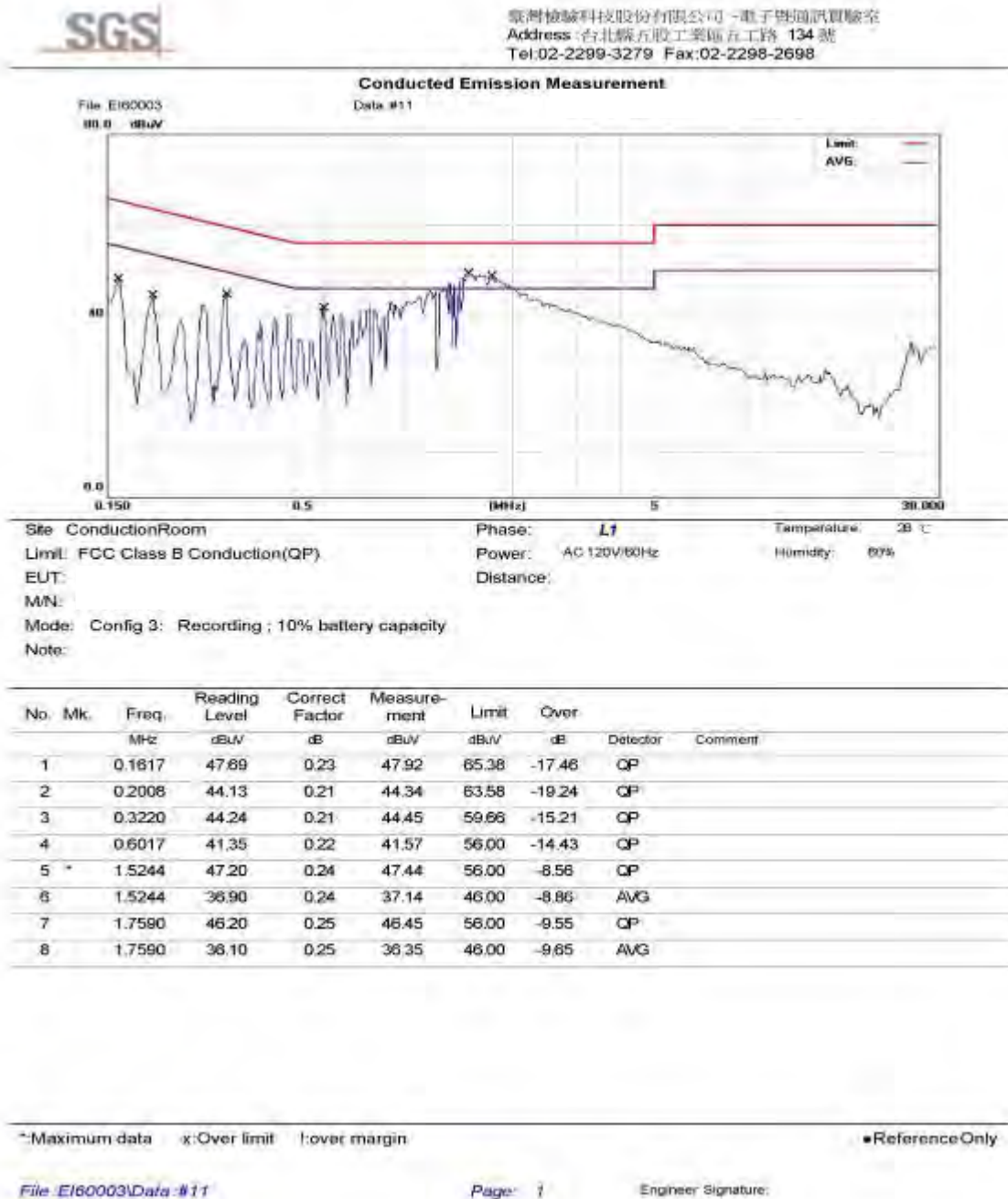

Unless otherwise stated the results shown in this test report refer only to the sample(s) tested and such sample(s) are retained for 90 days only.

除非另有說明，此報告結果僅對測試之樣品負責，同時此樣品僅保留 90 天。本報告未經本公司書面許可，不可部份複製。

This document is issued by the Company subject to its General Conditions of Service printed overleaf, available on request or accessible at [www.sgs.com/terms\\_and\\_conditions.htm](http://www.sgs.com/terms_and_conditions.htm) and, for electronic format documents, subject to Terms and Conditions for Electronic Documents at [www.sgs.com/terms\\_e-document.htm](http://www.sgs.com/terms_e-document.htm). Attention is drawn to the limitation of liability, indemnification and jurisdiction issues defined therein. Any holder of this document is advised that information contained hereon reflects the Company's findings at the time of its intervention only and within the limits of Client's instructions, if any. The Company's sole responsibility is to its Client and this document does not exonerate parties to a transaction from exercising all their rights and obligations under the transaction documents. This document cannot be reproduced except in full, without prior written approval of the Company. Any unauthorized alteration, forgery or falsification of the content or appearance of this document is unlawful and offenders may be prosecuted to the fullest extent of the law.

SGS Taiwan Ltd.No.134, Wu Kung Road, Wuku Industrial Zone, Taipei County, Taiwan /台北縣五股工業區五工路 134 號

台灣檢驗科技股份有限公司 t (886-2) 2299-3279 f (886-2) 2298-0488 www.tw.sgs.com

N

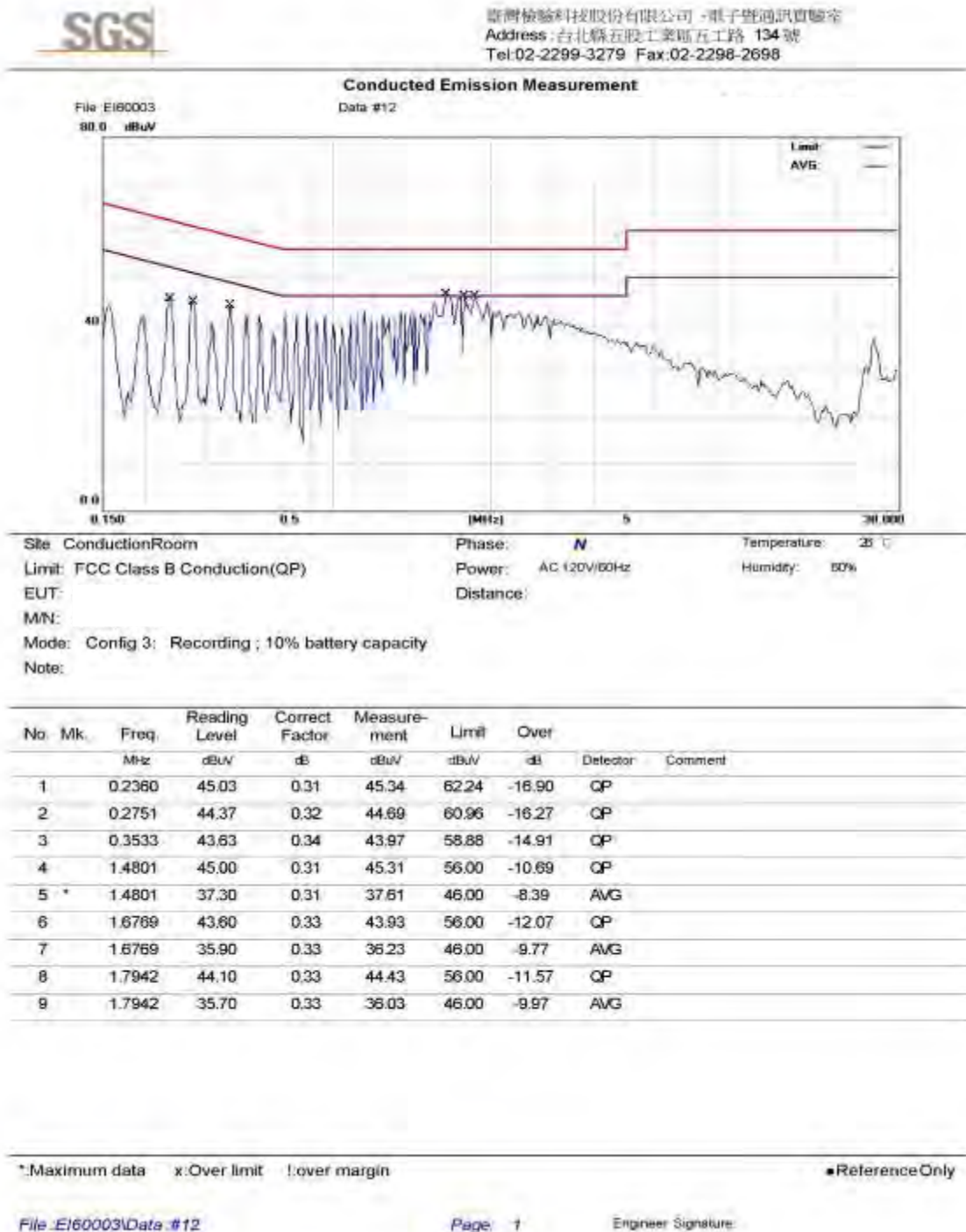

Unless otherwise stated the results shown in this test report refer only to the sample(s) tested and such sample(s) are retained for 90 days only.

除非另有說明，此報告結果僅對測試之樣品負責，同時此樣品僅保留 90 天。本報告未經本公司書面許可，不可部份複製。

This document is issued by the Company subject to its General Conditions of Service printed overleaf, available on request or accessible at [www.sgs.com/terms\\_and\\_conditions.htm](http://www.sgs.com/terms_and_conditions.htm) and, for electronic format documents, subject to Terms and Conditions for Electronic Documents at [www.sgs.com/terms\\_e-document.htm](http://www.sgs.com/terms_e-document.htm). Attention is drawn to the limitation of liability, indemnification and jurisdiction issues defined therein. Any holder of this document is advised that information contained hereon reflects the Company's findings at the time of its intervention only and within the limits of Client's instructions, if any. The Company's sole responsibility is to its Client and this document does not exonerate parties to a transaction from exercising all their rights and obligations under the transaction documents. This document cannot be reproduced except in full, without prior written approval of the Company. Any unauthorized alteration, forgery or falsification of the content or appearance of this document is unlawful and offenders may be prosecuted to the fullest extent of the law.

SGS Taiwan Ltd. No.134, Wu Kung Road, Wuku Industrial Zone, Taipei County, Taiwan / 台北縣五股工業區五工路 134 號

台灣檢驗科技股份有限公司 t (886-2) 2299-3279 f (886-2) 2298-0488 www.tw.sgs.com

## Config 3: Play Recording

L

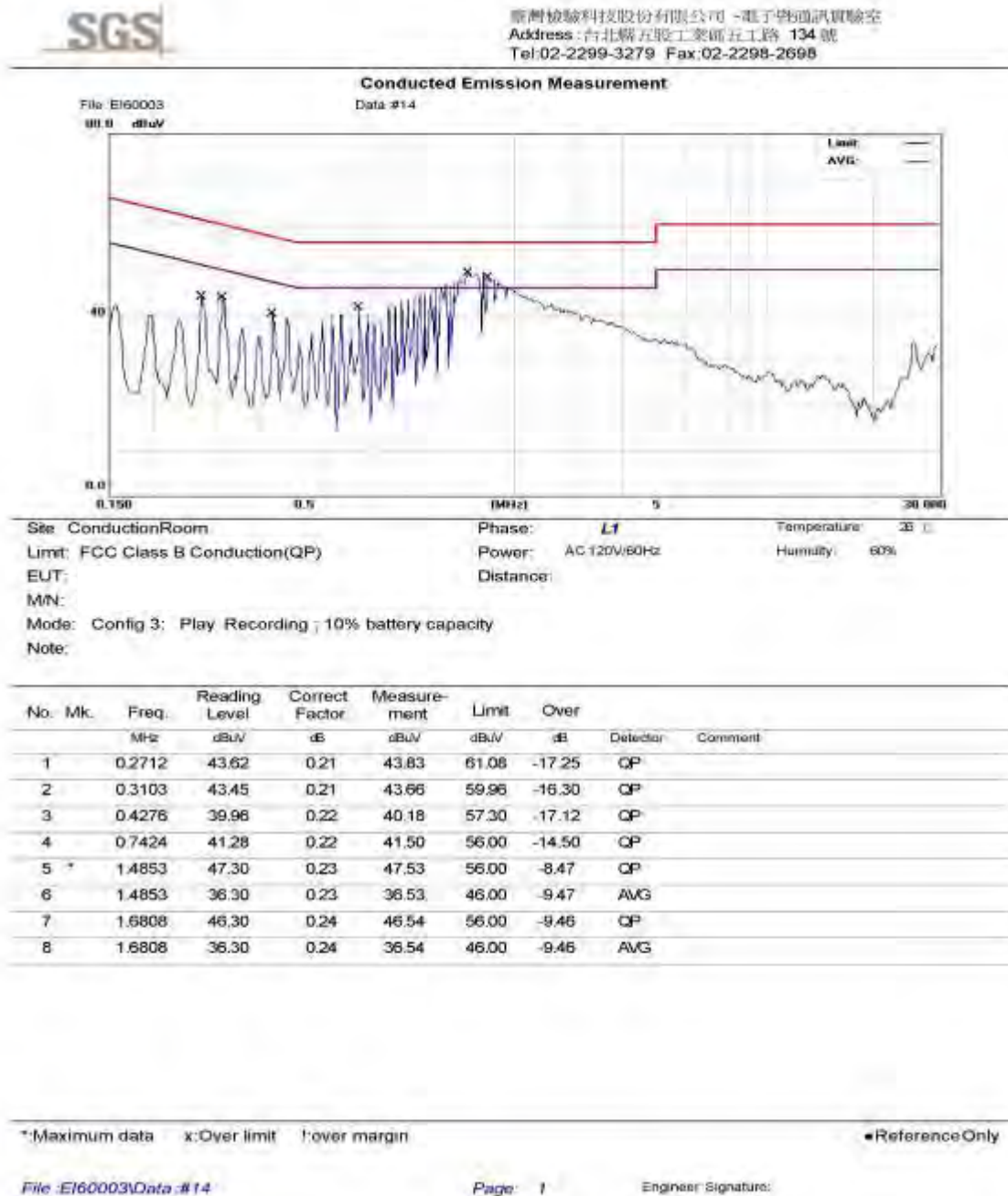

Unless otherwise stated the results shown in this test report refer only to the sample(s) tested and such sample(s) are retained for 90 days only.

除非另有說明，此報告結果僅對測試之樣品負責，同時此樣品僅保留 90 天。本報告未經本公司書面許可，不可部份複製。

This document is issued by the Company subject to its General Conditions of Service printed overleaf, available on request or accessible at [www.sgs.com/terms\\_and\\_conditions.htm](http://www.sgs.com/terms_and_conditions.htm) and, for electronic format documents, subject to Terms and Conditions for Electronic Documents at [www.sgs.com/terms\\_e-document.htm](http://www.sgs.com/terms_e-document.htm). Attention is drawn to the limitation of liability, indemnification and jurisdiction issues defined therein. Any holder of this document is advised that information contained hereon reflects the Company's findings at the time of its intervention only and within the limits of Client's instructions, if any. The Company's sole responsibility is to its Client and this document does not exonerate parties to a transaction from exercising all their rights and obligations under the transaction documents. This document cannot be reproduced except in full, without prior written approval of the Company. Any unauthorized alteration, forgery or falsification of the content or appearance of this document is unlawful and offenders may be prosecuted to the fullest extent of the law.

SGS Taiwan Ltd.No.134, Wu Kung Road, Wuku Industrial Zone, Taipei County, Taiwan /台北縣五股工業區五工路 134 號

台灣檢驗科技股份有限公司 t (886-2) 2299-3279 f (886-2) 2298-0488 www.tw.sgs.com

N

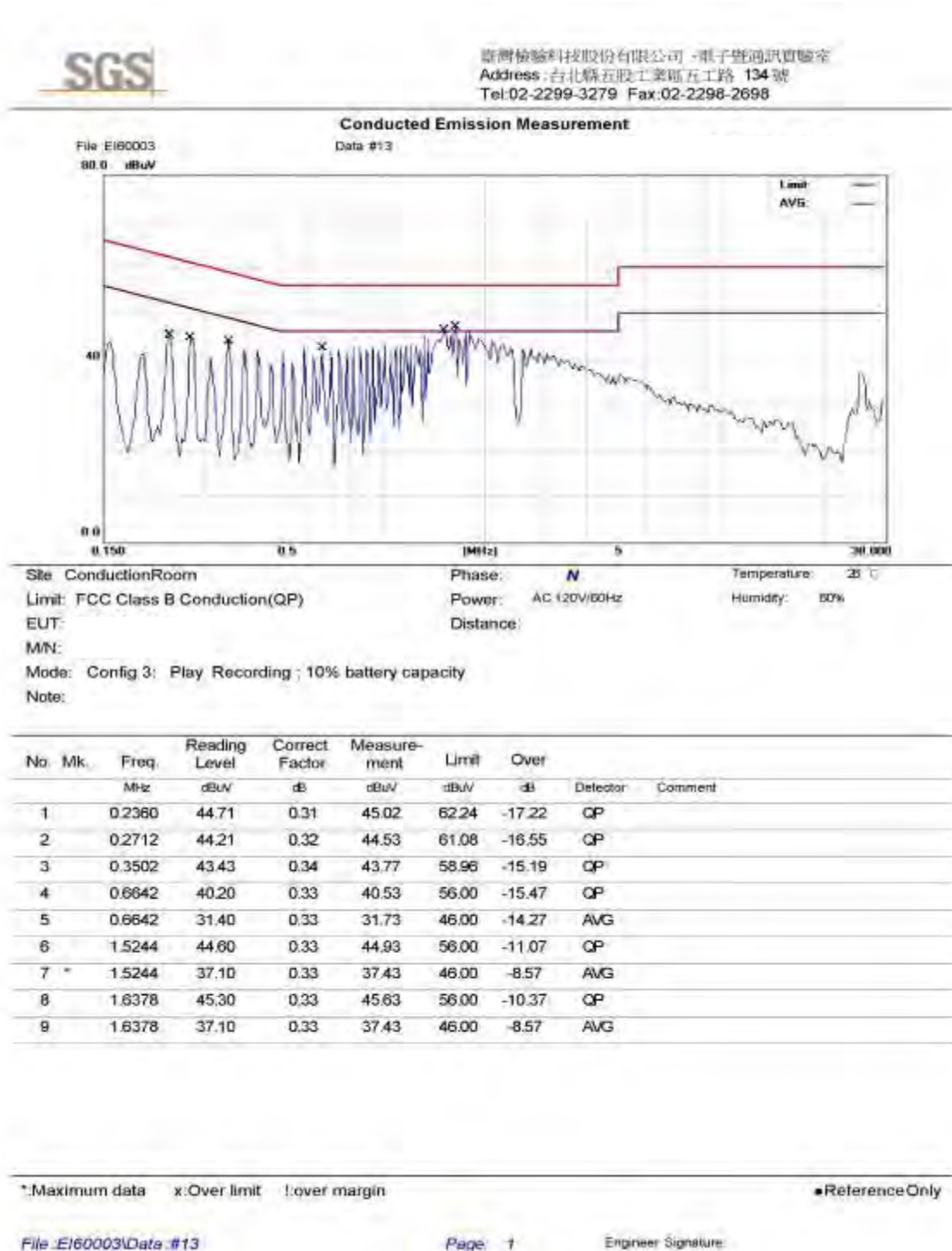

Unless otherwise stated the results shown in this test report refer only to the sample(s) tested and such sample(s) are retained for 90 days only.

除非另有說明，此報告結果僅對測試之樣品負責，同時此樣品僅保留 90 天。本報告未經本公司書面許可，不可部份複製。

This document is issued by the Company subject to its General Conditions of Service printed overleaf, available on request or accessible at [www.sgs.com/terms\\_and\\_conditions.htm](http://www.sgs.com/terms_and_conditions.htm) and, for electronic format documents, subject to Terms and Conditions for Electronic Documents at [www.sgs.com/terms\\_e-document.htm](http://www.sgs.com/terms_e-document.htm). Attention is drawn to the limitation of liability, indemnification and jurisdiction issues defined therein. Any holder of this document is advised that information contained hereon reflects the Company's findings at the time of its intervention only and within the limits of Client's instructions, if any. The Company's sole responsibility is to its Client and this document does not exonerate parties to a transaction from exercising all their rights and obligations under the transaction documents. This document cannot be reproduced except in full, without prior written approval of the Company. Any unauthorized alteration, forgery or falsification of the content or appearance of this document is unlawful and offenders may be prosecuted to the fullest extent of the law.

SGS Taiwan Ltd.No.134, Wu Kung Road, Wuku Industrial Zone, Taipei County, Taiwan /台北縣五股工業區五工路 134 號

台灣檢驗科技股份有限公司 t (886-2) 2299-3279 f (886-2) 2298-0488 www.tw.sgs.com

Config 3:MP3

L

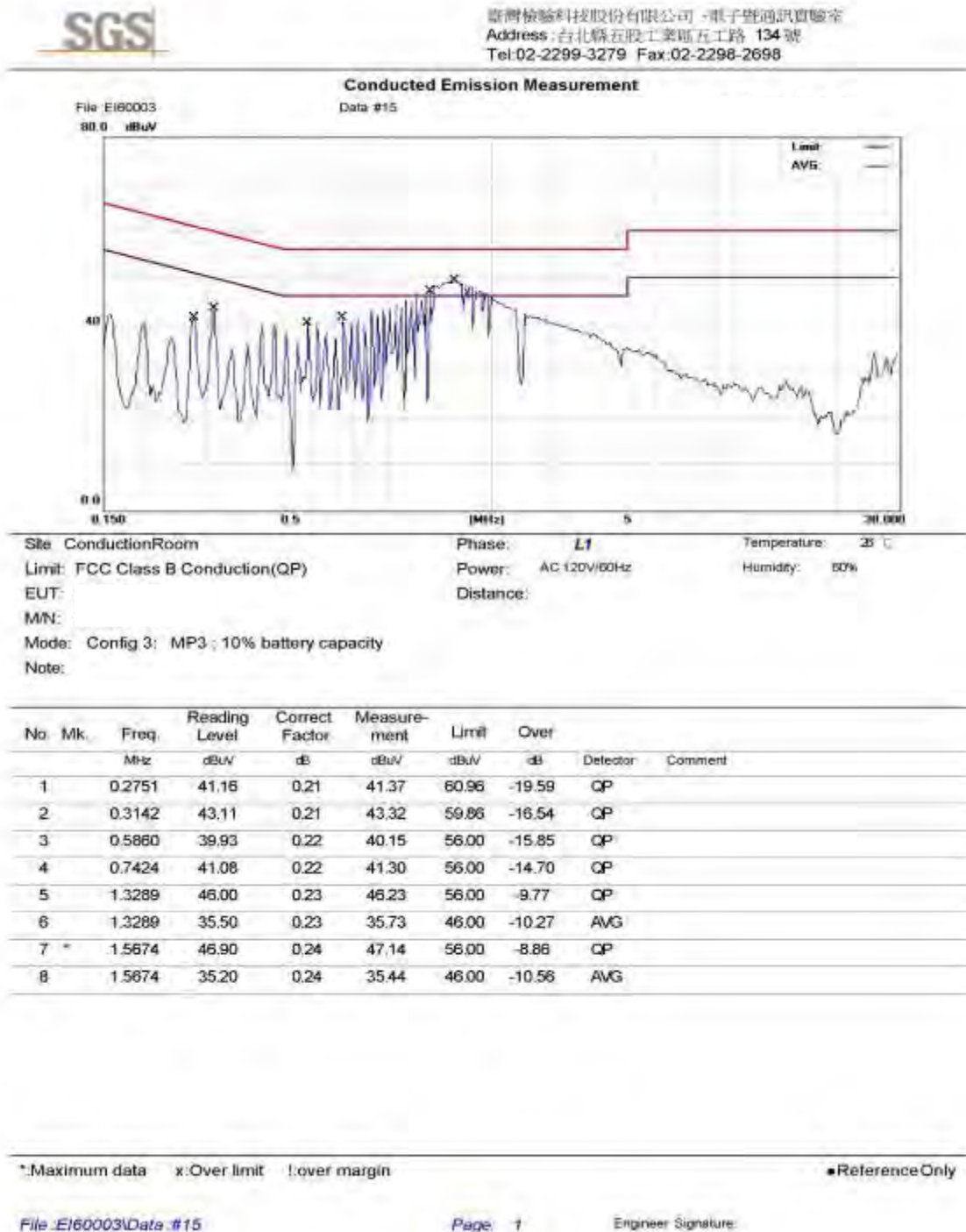

Unless otherwise stated the results shown in this test report refer only to the sample(s) tested and such sample(s) are retained for 90 days only.

除非另有說明，此報告結果僅對測試之樣品負責，同時此樣品僅保留 90 天。本報告未經本公司書面許可，不可部份複製。

This document is issued by the Company subject to its General Conditions of Service printed overleaf, available on request or accessible at [www.sgs.com/terms\\_and\\_conditions.htm](http://www.sgs.com/terms_and_conditions.htm) and, for electronic format documents, subject to Terms and Conditions for Electronic Documents at [www.sgs.com/terms\\_e-document.htm](http://www.sgs.com/terms_e-document.htm). Attention is drawn to the limitation of liability, indemnification and jurisdiction issues defined therein. Any holder of this document is advised that information contained hereon reflects the Company's findings at the time of its intervention only and within the limits of Client's instructions, if any. The Company's sole responsibility is to its Client and this document does not exonerate parties to a transaction from exercising all their rights and obligations under the transaction documents. This document cannot be reproduced except in full, without prior written approval of the Company. Any unauthorized alteration, forgery or falsification of the content or appearance of this document is unlawful and offenders may be prosecuted to the fullest extent of the law.

SGS Taiwan Ltd.No.134, Wu Kung Road, Wuku Industrial Zone, Taipei County, Taiwan /台北縣五股工業區五工路 134 號

台灣檢驗科技股份有限公司 t (886-2) 2299-3279 f (886-2) 2298-0488 www.tw.sgs.com

N

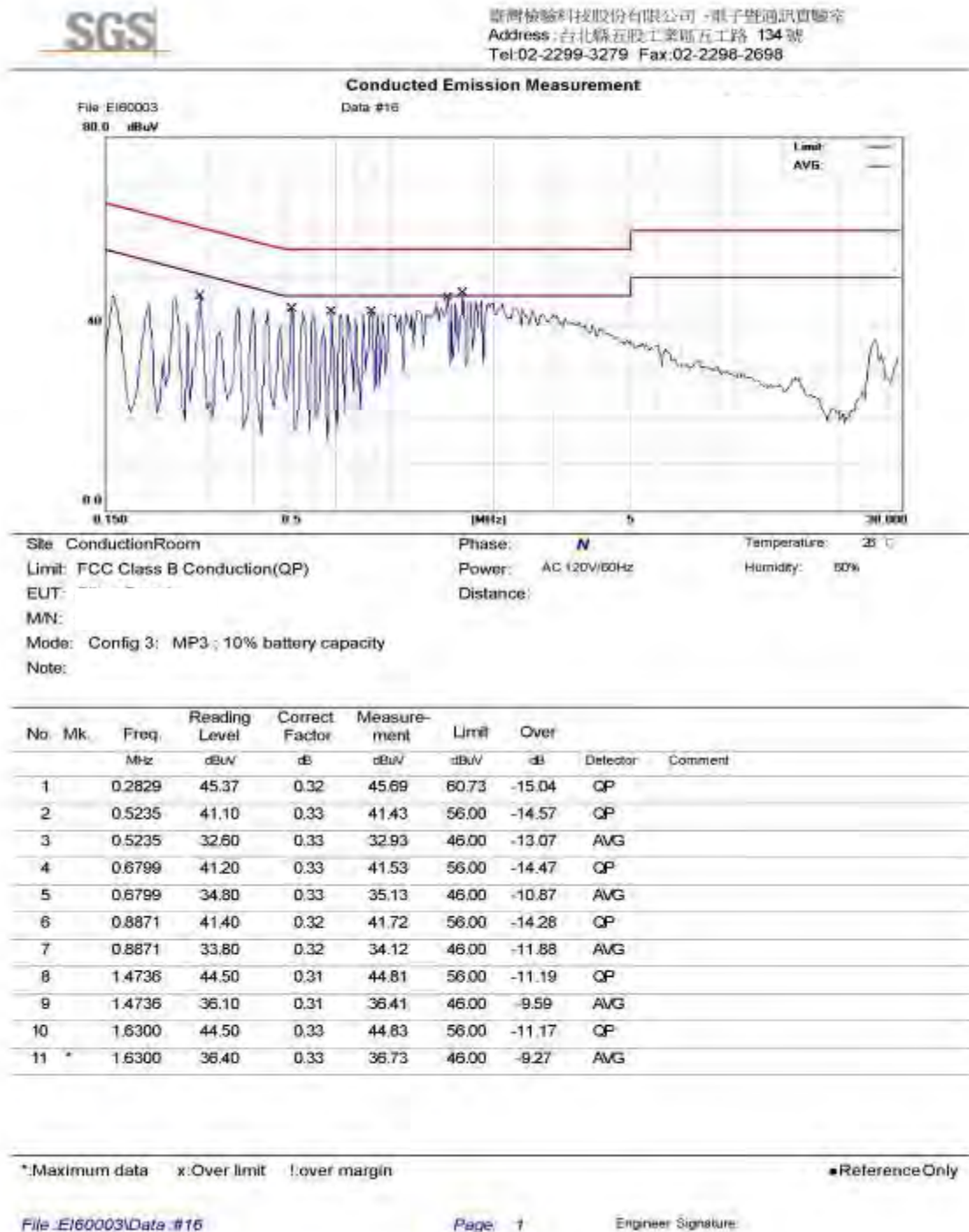

Unless otherwise stated the results shown in this test report refer only to the sample(s) tested and such sample(s) are retained for 90 days only.

除非另有說明，此報告結果僅對測試之樣品負責，同時此樣品僅保留 90 天。本報告未經本公司書面許可，不可部份複製。

This document is issued by the Company subject to its General Conditions of Service printed overleaf, available on request or accessible at [www.sgs.com/terms\\_and\\_conditions.htm](http://www.sgs.com/terms_and_conditions.htm) and, for electronic format documents, subject to Terms and Conditions for Electronic Documents at [www.sgs.com/terms\\_e-document.htm](http://www.sgs.com/terms_e-document.htm). Attention is drawn to the limitation of liability, indemnification and jurisdiction issues defined therein. Any holder of this document is advised that information contained hereon reflects the Company's findings at the time of its intervention only and within the limits of Client's instructions, if any. The Company's sole responsibility is to its Client and this document does not exonerate parties to a transaction from exercising all their rights and obligations under the transaction documents. This document cannot be reproduced except in full, without prior written approval of the Company. Any unauthorized alteration, forgery or falsification of the content or appearance of this document is unlawful and offenders may be prosecuted to the fullest extent of the law.

SGS Taiwan Ltd. No.134, Wu Kung Road, Wuku Industrial Zone, Taipei County, Taiwan / 台北縣五股工業區五工路 134 號

台灣檢驗科技股份有限公司      t (886-2) 2299-3279      f (886-2) 2298-0488      www.tw.sgs.com

Config 4:FM 87.6

L

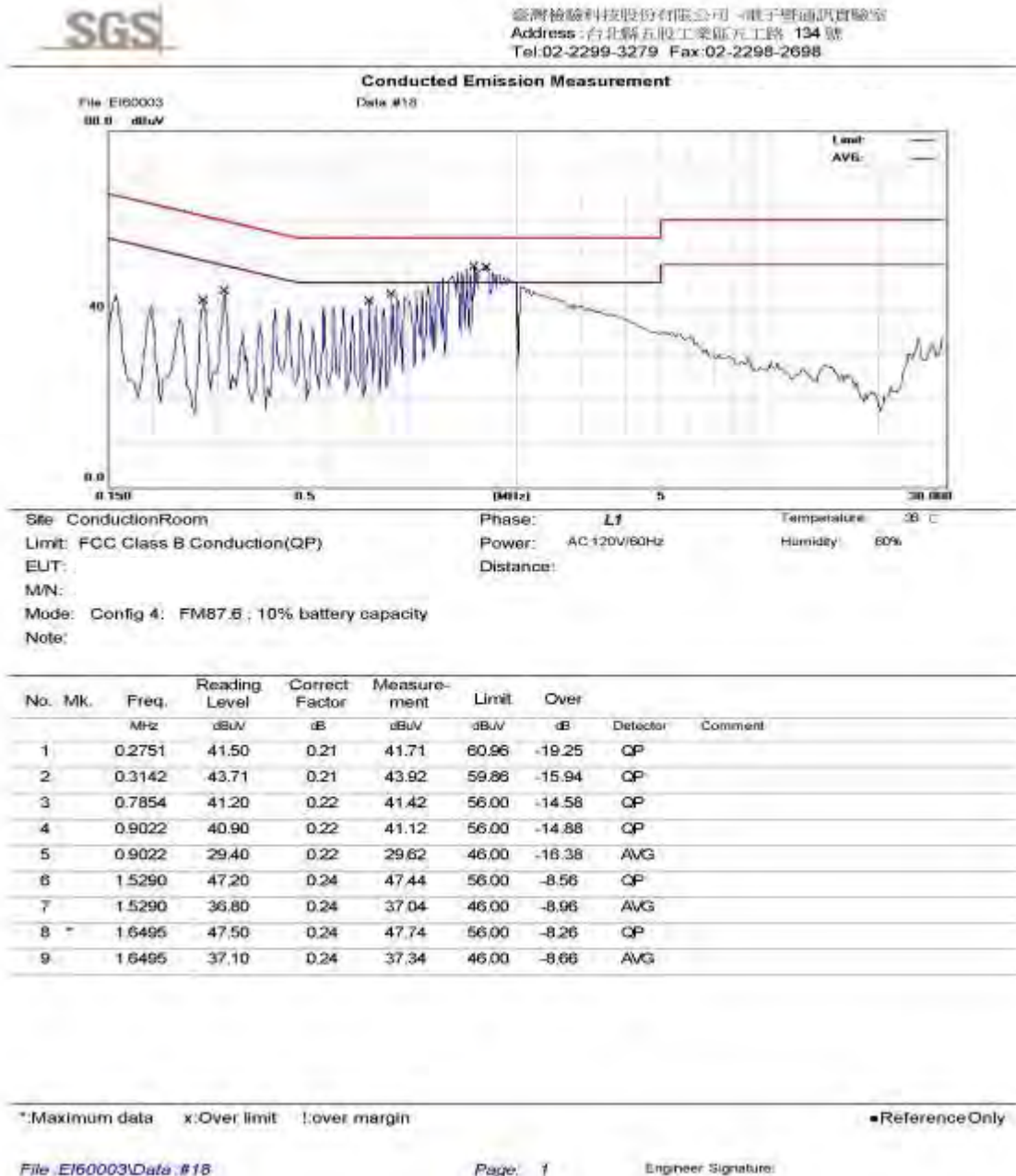

Unless otherwise stated the results shown in this test report refer only to the sample(s) tested and such sample(s) are retained for 90 days only.

除非另有說明，此報告結果僅對測試之樣品負責，同時此樣品僅保留 90 天。本報告未經本公司書面許可，不可部份複製。

This document is issued by the Company subject to its General Conditions of Service printed overleaf, available on request or accessible at [www.sgs.com/terms\\_and\\_conditions.htm](http://www.sgs.com/terms_and_conditions.htm) and, for electronic format documents, subject to Terms and Conditions for Electronic Documents at [www.sgs.com/terms\\_e-document.htm](http://www.sgs.com/terms_e-document.htm). Attention is drawn to the limitation of liability, indemnification and jurisdiction issues defined therein. Any holder of this document is advised that information contained hereon reflects the Company's findings at the time of its intervention only and within the limits of Client's instructions, if any. The Company's sole responsibility is to its Client and this document does not exonerate parties to a transaction from exercising all their rights and obligations under the transaction documents. This document cannot be reproduced except in full, without prior written approval of the Company. Any unauthorized alteration, forgery or falsification of the content or appearance of this document is unlawful and offenders may be prosecuted to the fullest extent of the law.

SGS Taiwan Ltd.No.134, Wu Kung Road, Wuku Industrial Zone, Taipei County, Taiwan /台北縣五股工業區五工路 134 號

台灣檢驗科技股份有限公司 t (886-2) 2299-3279 f (886-2) 2298-0488 www.tw.sgs.com

N

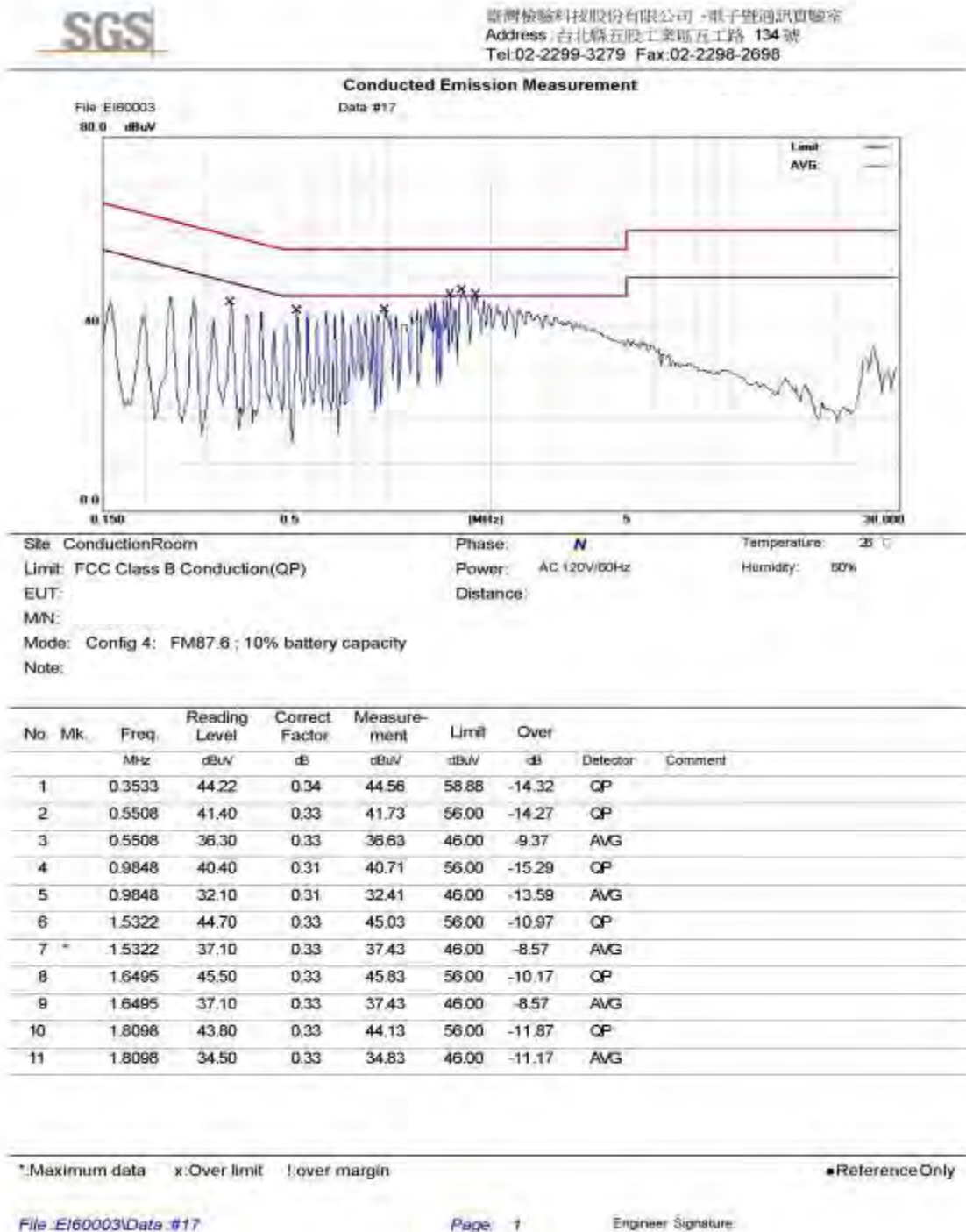

Unless otherwise stated the results shown in this test report refer only to the sample(s) tested and such sample(s) are retained for 90 days only.

除非另有說明，此報告結果僅對測試之樣品負責，同時此樣品僅保留 90 天。本報告未經本公司書面許可，不可部份複製。

This document is issued by the Company subject to its General Conditions of Service printed overleaf, available on request or accessible at [www.sgs.com/terms\\_and\\_conditions.htm](http://www.sgs.com/terms_and_conditions.htm) and, for electronic format documents, subject to Terms and Conditions for Electronic Documents at [www.sgs.com/terms\\_e-document.htm](http://www.sgs.com/terms_e-document.htm). Attention is drawn to the limitation of liability, indemnification and jurisdiction issues defined therein. Any holder of this document is advised that information contained hereon reflects the Company's findings at the time of its intervention only and within the limits of Client's instructions, if any. The Company's sole responsibility is to its Client and this document does not exonerate parties to a transaction from exercising all their rights and obligations under the transaction documents. This document cannot be reproduced except in full, without prior written approval of the Company. Any unauthorized alteration, forgery or falsification of the content or appearance of this document is unlawful and offenders may be prosecuted to the fullest extent of the law.

SGS Taiwan Ltd. No.134, Wu Kung Road, Wuku Industrial Zone, Taipei County, Taiwan / 台北縣五股工業區五工路 134 號

台灣檢驗科技股份有限公司 t (886-2) 2299-3279 f (886-2) 2298-0488 www.tw.sgs.com

Config 4:FM 98.0

L

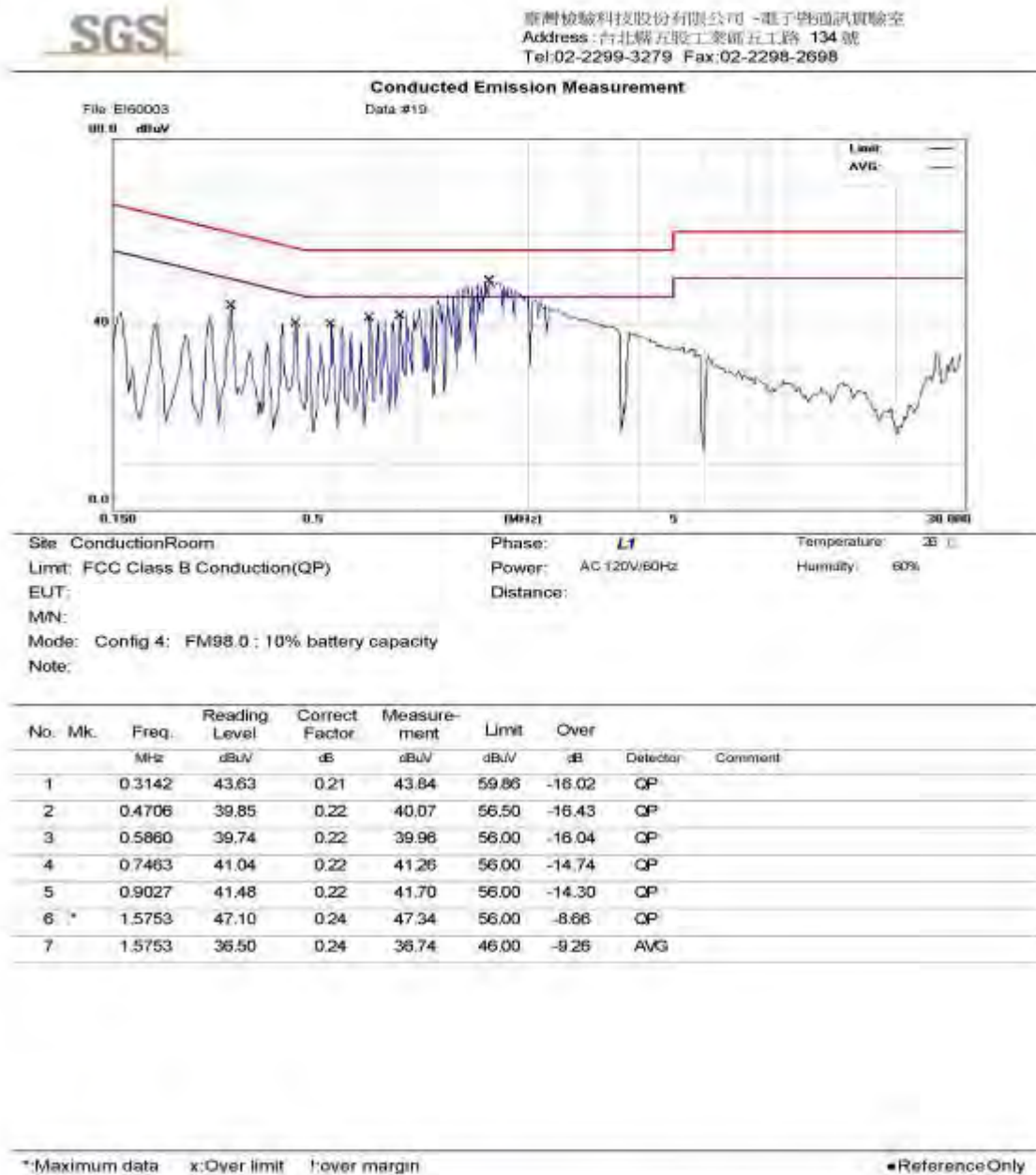

File: EI60003\Data:#19

Page: 1

Engineer Signature:

Unless otherwise stated the results shown in this test report refer only to the sample(s) tested and such sample(s) are retained for 90 days only.

除非另有說明，此報告結果僅對測試之樣品負責，同時此樣品僅保留 90 天。本報告未經本公司書面許可，不可部份複製。

This document is issued by the Company subject to its General Conditions of Service printed overleaf, available on request or accessible at [www.sgs.com/terms\\_and\\_conditions.htm](http://www.sgs.com/terms_and_conditions.htm) and, for electronic format documents, subject to Terms and Conditions for Electronic Documents at [www.sgs.com/terms\\_e-document.htm](http://www.sgs.com/terms_e-document.htm). Attention is drawn to the limitation of liability, indemnification and jurisdiction issues defined therein. Any holder of this document is advised that information contained hereon reflects the Company's findings at the time of its intervention only and within the limits of Client's instructions, if any. The Company's sole responsibility is to its Client and this document does not exonerate parties to a transaction from exercising all their rights and obligations under the transaction documents. This document cannot be reproduced except in full, without prior written approval of the Company. Any unauthorized alteration, forgery or falsification of the content or appearance of this document is unlawful and offenders may be prosecuted to the fullest extent of the law.

SGS Taiwan Ltd.No.134, Wu Kung Road, Wuku Industrial Zone, Taipei County, Taiwan /台北縣五股工業區五工路 134 號

台灣檢驗科技股份有限公司 t (886-2) 2299-3279 f (886-2) 2298-0488 www.tw.sgs.com

N

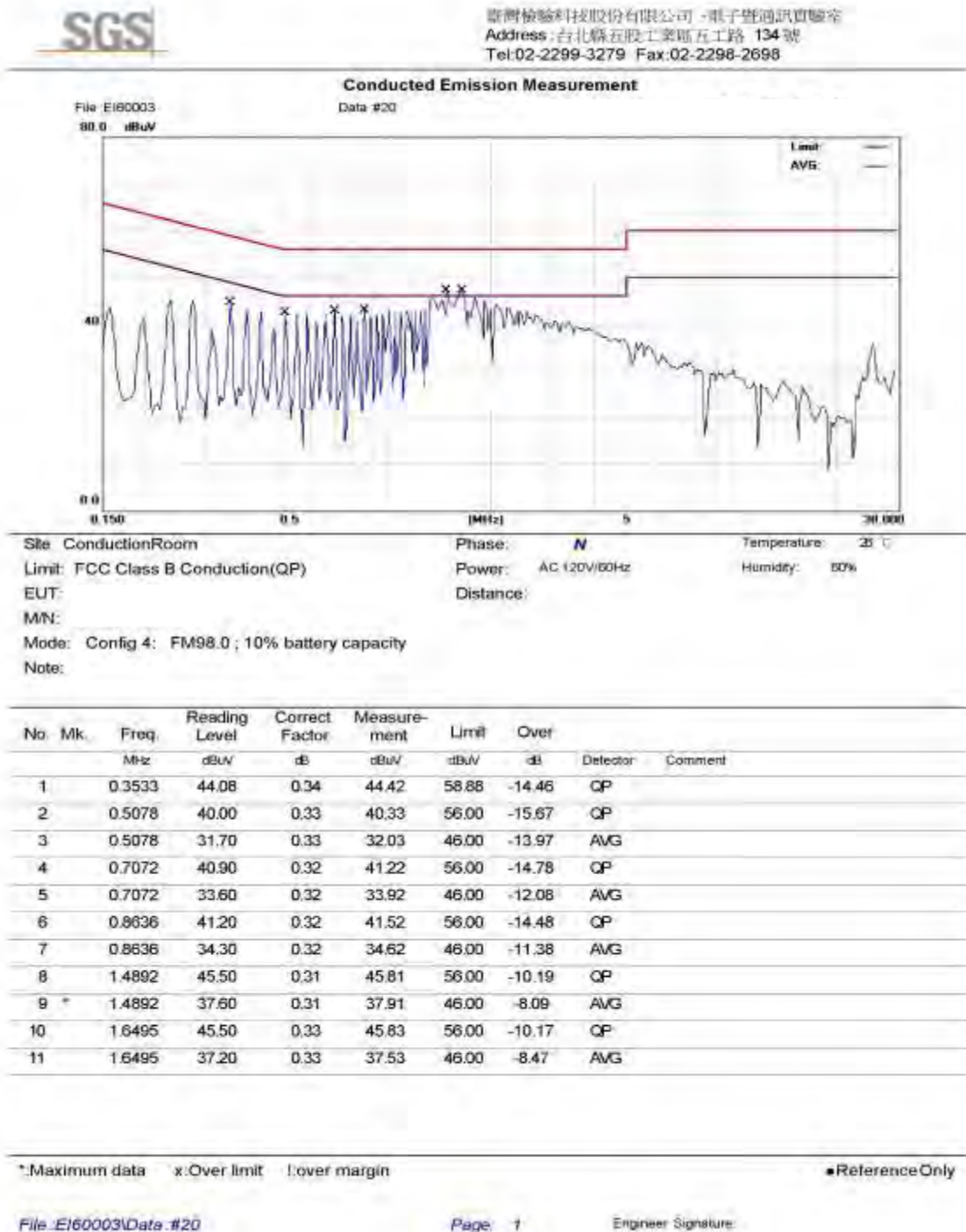

Unless otherwise stated the results shown in this test report refer only to the sample(s) tested and such sample(s) are retained for 90 days only.

除非另有說明，此報告結果僅對測試之樣品負責，同時此樣品僅保留 90 天。本報告未經本公司書面許可，不可部份複製。

This document is issued by the Company subject to its General Conditions of Service printed overleaf, available on request or accessible at [www.sgs.com/terms\\_and\\_conditions.htm](http://www.sgs.com/terms_and_conditions.htm) and, for electronic format documents, subject to Terms and Conditions for Electronic Documents at [www.sgs.com/terms\\_e-document.htm](http://www.sgs.com/terms_e-document.htm). Attention is drawn to the limitation of liability, indemnification and jurisdiction issues defined therein. Any holder of this document is advised that information contained hereon reflects the Company's findings at the time of its intervention only and within the limits of Client's instructions, if any. The Company's sole responsibility is to its Client and this document does not exonerate parties to a transaction from exercising all their rights and obligations under the transaction documents. This document cannot be reproduced except in full, without prior written approval of the Company. Any unauthorized alteration, forgery or falsification of the content or appearance of this document is unlawful and offenders may be prosecuted to the fullest extent of the law.

SGS Taiwan Ltd. No.134, Wu Kung Road, Wuku Industrial Zone, Taipei County, Taiwan / 台北縣五股工業區五工路 134 號

台灣檢驗科技股份有限公司 t (886-2) 2299-3279 f (886-2) 2298-0488 www.tw.sgs.com

## Config 4:FM 107.9

L

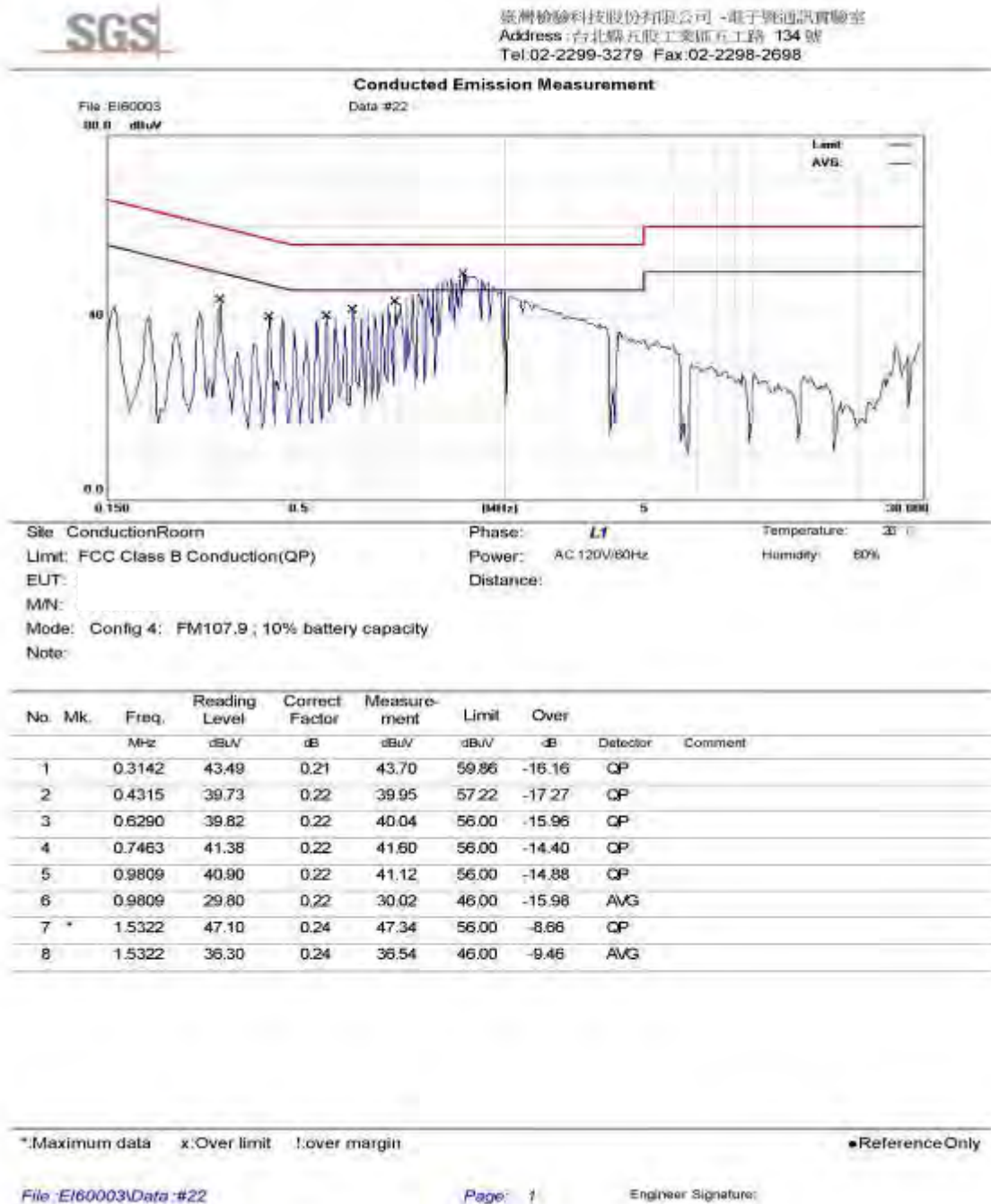

Unless otherwise stated the results shown in this test report refer only to the sample(s) tested and such sample(s) are retained for 90 days only.

除非另有說明，此報告結果僅對測試之樣品負責，同時此樣品僅保留 90 天。本報告未經本公司書面許可，不可部份複製。

This document is issued by the Company subject to its General Conditions of Service printed overleaf, available on request or accessible at [www.sgs.com/terms\\_and\\_conditions.htm](http://www.sgs.com/terms_and_conditions.htm) and, for electronic format documents, subject to Terms and Conditions for Electronic Documents at [www.sgs.com/terms\\_e-document.htm](http://www.sgs.com/terms_e-document.htm). Attention is drawn to the limitation of liability, indemnification and jurisdiction issues defined therein. Any holder of this document is advised that information contained hereon reflects the Company's findings at the time of its intervention only and within the limits of Client's instructions, if any. The Company's sole responsibility is to its Client and this document does not exonerate parties to a transaction from exercising all their rights and obligations under the transaction documents. This document cannot be reproduced except in full, without prior written approval of the Company. Any unauthorized alteration, forgery or falsification of the content or appearance of this document is unlawful and offenders may be prosecuted to the fullest extent of the law.

SGS Taiwan Ltd.No.134, Wu Kung Road, Wuku Industrial Zone, Taipei County, Taiwan /台北縣五股工業區五工路 134 號

台灣檢驗科技股份有限公司 t (886-2) 2299-3279 f (886-2) 2298-0488 www.tw.sgs.com

N

 臺灣檢驗科技股份有限公司 - 電子電訊訊實驗室  
 Address : 台北縣五股工業區五工路 134 號  
 Tel: 02-2299-3279 Fax: 02-2298-2698

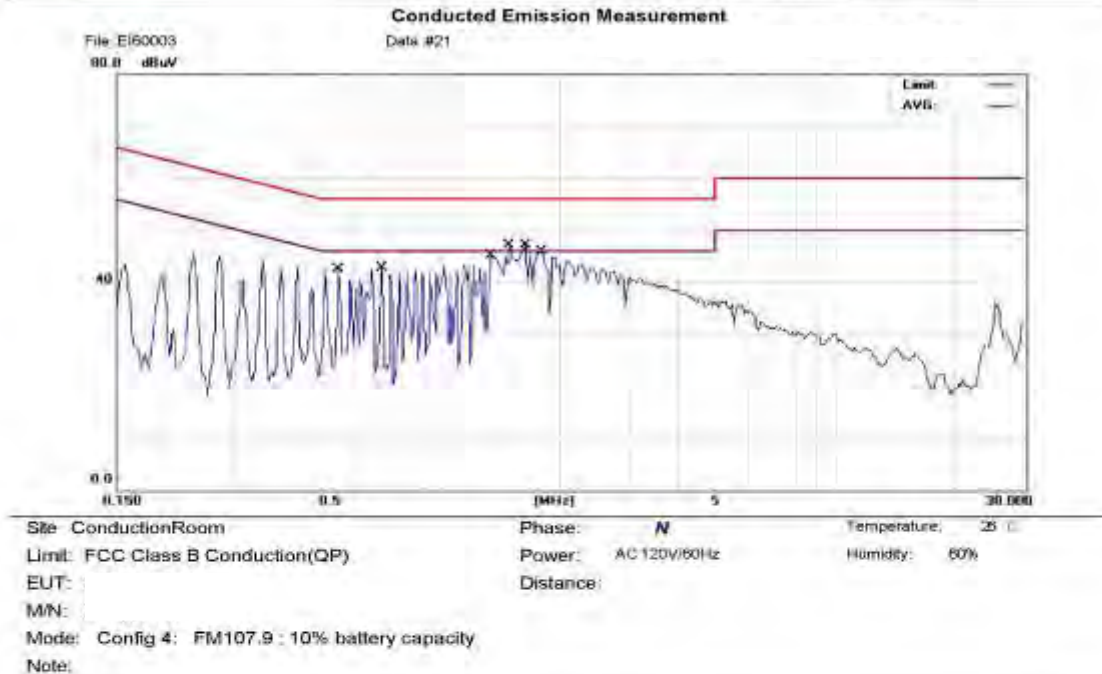

No.	Mk.	Freq. MHz	Reading Level dBµV	Correct Factor dB	Measure- ment dBµV	Limit dBµV	Over dB	Detector	Comment
1		0.5508	41.30	0.33	41.63	56.00	-14.37	QP	
2		0.5508	35.80	0.33	36.13	46.00	-9.87	AVG	
3		0.7072	41.10	0.32	41.42	56.00	-14.58	QP	
4		0.7072	34.10	0.32	34.42	46.00	-11.58	AVG	
5		1.3367	43.80	0.31	44.11	56.00	-11.89	QP	
6		1.3367	36.40	0.31	36.71	46.00	-9.29	AVG	
7		1.4892	45.40	0.31	45.71	56.00	-10.29	QP	
8	*	1.4892	37.10	0.31	37.41	46.00	-8.59	AVG	
9		1.6417	45.30	0.33	45.63	56.00	-10.37	QP	
10		1.6417	37.00	0.33	37.33	46.00	-8.67	AVG	
11		1.7981	43.90	0.33	44.23	56.00	-11.77	QP	
12		1.7981	35.60	0.33	35.93	46.00	-10.07	AVG	

\*:Maximum data x:Over limit | :over margin ●Reference Only

File: EI60003>Data: #21 Page: 1 Engineer Signature

Unless otherwise stated the results shown in this test report refer only to the sample(s) tested and such sample(s) are retained for 90 days only.  
 除非另有說明，此報告結果僅對測試之樣品負責，同時此樣品僅保留 90 天。本報告未經本公司書面許可，不可部份複製。  
 This document is issued by the Company subject to its General Conditions of Service printed overleaf, available on request or accessible at [www.sgs.com/terms\\_and\\_conditions.htm](http://www.sgs.com/terms_and_conditions.htm) and, for electronic format documents, subject to Terms and Conditions for Electronic Documents at [www.sgs.com/terms\\_e-document.htm](http://www.sgs.com/terms_e-document.htm). Attention is drawn to the limitation of liability, indemnification and jurisdiction issues defined therein. Any holder of this document is advised that information contained hereon reflects the Company's findings at the time of its intervention only and within the limits of Client's instructions, if any. The Company's sole responsibility is to its Client and this document does not exonerate parties to a transaction from exercising all their rights and obligations under the transaction documents. This document cannot be reproduced except in full, without prior written approval of the Company. Any unauthorized alteration, forgery or falsification of the content or appearance of this document is unlawful and offenders may be prosecuted to the fullest extent of the law.

## 2.5 Test of Radiated Emission

### 2.5.1 Test Instruments

#### Below 1G & Above 1G

Description	Manufacturer	Model No.	Serial No.	Last Calibration Date	Next Calibration Date
Site NSA	Chamost	966II Chamber	N/A	Dec. 30, 2011	Dec. 29, 2012
Site VSWR	Chamost	966II Chamber	N/A	Dec. 30, 2011	Dec. 29, 2012
EMI Test Receiver	ROHDE&SCHWARZ	ESCI 7	1166.5950K07 -100760-GK	May 25, 2012	May 24, 2013
Spectrum Analyzer	Agilent	E4440A	MY45304525	Mar. 17, 2012	Mar. 16, 2014
RF-Amplifier (0.1-1300MHz)	HP	8447D	1937A02774	Nov. 26, 2011	Nov. 25, 2012
RF-Amplifier (1-26.5GHz)	HP	8449B	3008A00578	Dec. 27, 2011	Dec. 26, 2012
RF-Amplifier (26-40GHz)	EM Electronics Corp.	EM26400	N/A	Dec. 28, 2011	Dec. 27, 2012
Coaxial Cables (For 9kHz~26.5GHz)	SUCOFLEX	104PEA	N/A	Dec. 28, 2011	Dec. 27, 2012
Re Cables (966II) (For 1~40GHz)	HUBER SUHNER	SUCCOFLEX 102	22962/2	Dec. 28, 2011	Dec. 27, 2012
Re Cables (966II) (For 1~40GHz)	HUBER SUHNER	SUCCOFLEX 102	23051/2	Dec. 28, 2011	Dec. 27, 2012
Antenna Master	MF.	N/A	N/A	N/A	N/A
Turn Table	MF.	N/A	N/A	N/A	N/A
Controller	MF.	3000	MF780208153	N/A	N/A
Antenna	SCHWAZBECK	VULB9160	3068	Nov. 01, 2011	Oct. 31, 2012
Horn Antenna (For 1~18G )	ETS-Lindgren	3117	00135200	Oct. 06, 2011	Oct. 05, 2012
Horn Antenna (For 18~40G )	SCHWAZBECK	BBHA 9170	BBHA9170185	Jul. 11, 2011	Jul. 10, 2013
Software	Farad	EZ-EMC- VER2A1.1(USB)	N/A	N/A	N/A

Unless otherwise stated the results shown in this test report refer only to the sample(s) tested and such sample(s) are retained for 90 days only.

除非另有說明，此報告結果僅對測試之樣品負責，同時此樣品僅保留 90 天。本報告未經本公司書面許可，不可部份複製。

This document is issued by the Company subject to its General Conditions of Service printed overleaf, available on request or accessible at [www.sgs.com/terms\\_and\\_conditions.htm](http://www.sgs.com/terms_and_conditions.htm) and, for electronic format documents, subject to Terms and Conditions for Electronic Documents at [www.sgs.com/terms\\_e-document.htm](http://www.sgs.com/terms_e-document.htm). Attention is drawn to the limitation of liability, indemnification and jurisdiction issues defined therein. Any holder of this document is advised that information contained hereon reflects the Company's findings at the time of its intervention only and within the limits of Client's instructions, if any. The Company's sole responsibility is to its Client and this document does not exonerate parties to a transaction from exercising all their rights and obligations under the transaction documents. This document cannot be reproduced except in full, without prior written approval of the Company. Any unauthorized alteration, forgery or falsification of the content or appearance of this document is unlawful and offenders may be prosecuted to the fullest extent of the law.

SGS Taiwan Ltd. No.134, Wu Kung Road, Wuku Industrial Zone, Taipei County, Taiwan / 台北縣五股工業區五工路 134 號

台灣檢驗科技股份有限公司 t (886-2) 2299-3279 f (886-2) 2298-0488 www.tw.sgs.com

## 2.5.2 Test Site

SGS Taiwan LTD. Electronics & Communication Laboratory  
No.134, Wu Kung Road. Wuku Industrial Zone, Taipei County 248, Taiwan (R.O.C.)

## 2.5.3 Operating Environment

Temperature : 25 degree C                      Humidity : 60 %RH  
Atmospheric Pressure : 996 mBar

### 2.5.3.1 Uncertainty of Radiated Emission

Expanded uncertainty (k=2) of radiated emission measurement is 3.70dB.(30-1000MHz)  
Expanded uncertainty (k=2) of radiated emission measurement is 5.63dB.(1-40GHz)

### 2.5.3.2 Measurement level and Factor calculate method

Factor = Antenna loss + Cable loss + Amplifier Compensate  
Measurement Level = Reading Level + Factor

Unless otherwise stated the results shown in this test report refer only to the sample(s) tested and such sample(s) are retained for 90 days only.  
除非另有說明，此報告結果僅對測試之樣品負責，同時此樣品僅保留 90 天。本報告未經本公司書面許可，不可部份複製。

This document is issued by the Company subject to its General Conditions of Service printed overleaf, available on request or accessible at [www.sgs.com/terms\\_and\\_conditions.htm](http://www.sgs.com/terms_and_conditions.htm) and, for electronic format documents, subject to Terms and Conditions for Electronic Documents at [www.sgs.com/terms\\_e-document.htm](http://www.sgs.com/terms_e-document.htm). Attention is drawn to the limitation of liability, indemnification and jurisdiction issues defined therein. Any holder of this document is advised that information contained hereon reflects the Company's findings at the time of its intervention only and within the limits of Client's instructions, if any. The Company's sole responsibility is to its Client and this document does not exonerate parties to a transaction from exercising all their rights and obligations under the transaction documents. This document cannot be reproduced except in full, without prior written approval of the Company. Any unauthorized alteration, forgery or falsification of the content or appearance of this document is unlawful and offenders may be prosecuted to the fullest extent of the law.

SGS Taiwan Ltd.No.134, Wu Kung Road, Wuku Industrial Zone, Taipei County, Taiwan /台北縣五股工業區五工路 134 號

台灣檢驗科技股份有限公司      t (886-2) 2299-3279      f (886-2) 2298-0488      www.tw.sgs.com

## 2.5.4 Measurement Data

Below 1G

Config 1:GSM850

H

臺灣檢驗科技股份有限公司-電子暨通訊實驗室  
Address :台北縣五股工業區五工路 134 號  
Tel:02-2299-3279 Fax:02-2298-2698

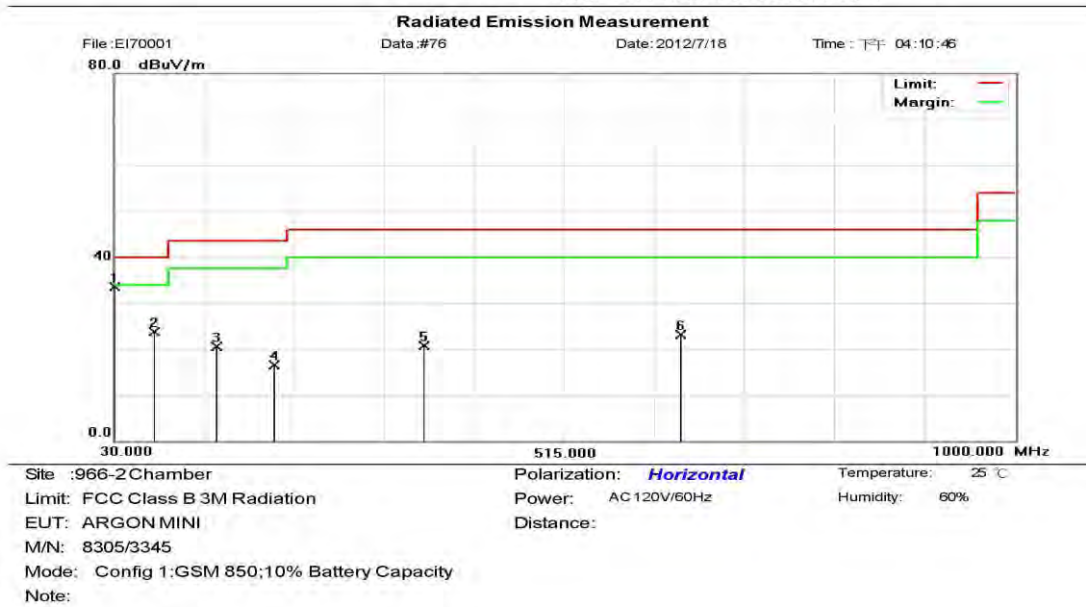

No.	Mk.	Freq. MHz	Reading Level dBuV	Correct Factor dB	Measure- ment dBuV/m	Limit dBuV/m	Over dB	Detector	Comment
1	*	30.0000	48.07	-14.63	33.44	40.00	-6.56	QP	
2		72.6800	40.59	-16.95	23.64	40.00	-16.36	QP	
3		140.5800	34.26	-13.69	20.57	43.50	-22.93	QP	
4		202.6600	32.06	-15.64	16.42	43.50	-27.08	QP	
5		363.6800	31.30	-10.53	20.77	46.00	-25.23	QP	
6		641.1000	27.97	-4.82	23.15	46.00	-22.85	QP	

\*:Maximum data    x:Over limit    !:over margin      ●ReferenceOnly

File :EI70001\Data :#76

Page: 7

Engineer Signature:

Printed with FinePrint - purchase at www.fineprint.com

Unless otherwise stated the results shown in this test report refer only to the sample(s) tested and such sample(s) are retained for 90 days only.

除非另有說明，此報告結果僅對測試之樣品負責，同時此樣品僅保留 90 天。本報告未經本公司書面許可，不可部份複製。

This document is issued by the Company subject to its General Conditions of Service printed overleaf, available on request or accessible at [www.sgs.com/terms\\_and\\_conditions.htm](http://www.sgs.com/terms_and_conditions.htm) and, for electronic format documents, subject to Terms and Conditions for Electronic Documents at [www.sgs.com/terms\\_e-document.htm](http://www.sgs.com/terms_e-document.htm). Attention is drawn to the limitation of liability, indemnification and jurisdiction issues defined therein. Any holder of this document is advised that information contained hereon reflects the Company's findings at the time of its intervention only and within the limits of Client's instructions, if any. The Company's sole responsibility is to its Client and this document does not exonerate parties to a transaction from exercising all their rights and obligations under the transaction documents. This document cannot be reproduced except in full, without prior written approval of the Company. Any unauthorized alteration, forgery or falsification of the content or appearance of this document is unlawful and offenders may be prosecuted to the fullest extent of the law.

SGS Taiwan Ltd.No.134, Wu Kung Road, Wuku Industrial Zone, Taipei County, Taiwan /台北縣五股工業區五工路 134 號

臺灣檢驗科技股份有限公司    t (886-2) 2299-3279    f (886-2) 2298-0488    www.tw.sgs.com

V

臺灣檢驗科技股份有限公司 - 電子電訊實驗室  
 Address : 台北縣五股工業區五工路 134 號  
 Tel: 02-2299-3279 Fax: 02-2298-2698

**Radiated Emission Measurement**



File : EI70001 Data #75 Date: 2012/7/18 Time : 下午 04:07:44

Site : 966-2 Chamber Polarization: **Vertical** Temperature: 25 °C  
 Limit: FCC Class B 3M Radiation Power: AC 120V/60Hz Humidity: 60%  
 EUT: ARGON MINI Distance:  
 M/N: 8305/3345  
 Mode: Config 1: GSM 850; 10% Battery Capacity  
 Note:

No.	Mk.	Freq. MHz	Reading Level dBuV	Correct Factor dB	Measure- ment dBuV/m	Limit dBuV/m	Over dB	Detector	Comment
1	*	30.0000	48.23	-14.63	33.60	40.00	-6.40	QP	
2		47.4600	34.70	-14.17	20.53	40.00	-19.47	QP	
3		59.1000	32.29	-14.69	17.60	40.00	-22.40	QP	
4		72.6800	34.86	-16.95	17.91	40.00	-22.09	QP	
5		130.8800	34.92	-14.03	20.89	43.50	-22.61	QP	
6		181.3200	35.71	-14.23	21.48	43.50	-22.02	QP	

\*: Maximum data x: Over limit !: over margin ■: Reference Only

File : EI70001\Data : #75

Page : 1

Engineer Signature:

Printed with FinePrint - purchase at [www.fineprint.com](http://www.fineprint.com)

Unless otherwise stated the results shown in this test report refer only to the sample(s) tested and such sample(s) are retained for 90 days only.

除非另有說明，此報告結果僅對測試之樣品負責，同時此樣品僅保留 90 天。本報告未經本公司書面許可，不可部份複製。

This document is issued by the Company subject to its General Conditions of Service printed overleaf, available on request or accessible at [www.sgs.com/terms\\_and\\_conditions.htm](http://www.sgs.com/terms_and_conditions.htm) and, for electronic format documents, subject to Terms and Conditions for Electronic Documents at [www.sgs.com/terms\\_e-document.htm](http://www.sgs.com/terms_e-document.htm). Attention is drawn to the limitation of liability, indemnification and jurisdiction issues defined therein. Any holder of this document is advised that information contained hereon reflects the Company's findings at the time of its intervention only and within the limits of Client's instructions, if any. The Company's sole responsibility is to its Client and this document does not exonerate parties to a transaction from exercising all their rights and obligations under the transaction documents. This document cannot be reproduced except in full, without prior written approval of the Company. Any unauthorized alteration, forgery or falsification of the content or appearance of this document is unlawful and offenders may be prosecuted to the fullest extent of the law.

SGS Taiwan Ltd. No.134, Wu Kung Road, Wuku Industrial Zone, Taipei County, Taiwan / 台北縣五股工業區五工路 134 號

台灣檢驗科技股份有限公司 t (886-2) 2299-3279 f (886-2) 2298-0488 [www.tw.sgs.com](http://www.tw.sgs.com)

Config 1:GSM1900

H

臺灣檢驗科技股份有限公司 - 電子騾通訊實驗室  
 Address : 台北縣五股工業區五工路 134 號  
 Tel:02-2299-3279 Fax:02-2298-2698

Radiated Emission Measurement



File:EI70001 Data:#78 Date:2012/7/18 Time:下午 04:19:09  
 Site :966-2Chamber Polarization: **Horizontal** Temperature: 25 C  
 Limit: FCC Class B 3M Radiation Power: AC 120V/60Hz Humidity: 60%  
 EUT: ARGON MINI Distance:  
 MN: 8305/3345  
 Mode: Config 1:GSM 1900;10% Battery Capacity  
 Note:

No.	Mk.	Freq.	Reading Level	Correct Factor	Measurement	Limit	Over	Detector	Comment
		MHz	dBuV	dB	dBuV/m	dBuV/m	dB		
1	*	30.0000	47.71	-14.63	33.08	40.00	-6.92	QP	
2		72.6800	38.08	-16.95	21.13	40.00	-18.87	QP	
3		130.8800	46.72	-14.03	32.69	43.50	-10.81	QP	
4		204.6000	32.41	-15.66	16.75	43.50	-26.75	QP	
5		363.6800	33.03	-10.53	22.50	46.00	-23.50	QP	
6		526.6400	37.34	-6.82	30.52	46.00	-15.48	QP	

\*:Maximum data x:Over limit !:over margin ●ReferenceOnly

File:EI70001>Data:#78

Page: 1

Engineer Signature:

Printed with FilePrint - purchase at www.fileprint.com

Unless otherwise stated the results shown in this test report refer only to the sample(s) tested and such sample(s) are retained for 90 days only.

除非另有說明，此報告結果僅對測試之樣品負責，同時此樣品僅保留 90 天。本報告未經本公司書面許可，不可部份複製。

This document is issued by the Company subject to its General Conditions of Service printed overleaf, available on request or accessible at [www.sgs.com/terms\\_and\\_conditions.htm](http://www.sgs.com/terms_and_conditions.htm) and, for electronic format documents, subject to Terms and Conditions for Electronic Documents at [www.sgs.com/terms\\_e-document.htm](http://www.sgs.com/terms_e-document.htm). Attention is drawn to the limitation of liability, indemnification and jurisdiction issues defined therein. Any holder of this document is advised that information contained hereon reflects the Company's findings at the time of its intervention only and within the limits of Client's instructions, if any. The Company's sole responsibility is to its Client and this document does not exonerate parties to a transaction from exercising all their rights and obligations under the transaction documents. This document cannot be reproduced except in full, without prior written approval of the Company. Any unauthorized alteration, forgery or falsification of the content or appearance of this document is unlawful and offenders may be prosecuted to the fullest extent of the law.

SGS Taiwan Ltd.No.134, Wu Kung Road, Wuku Industrial Zone, Taipei County, Taiwan /台北縣五股工業區五工路 134 號

台灣檢驗科技股份有限公司 t (886-2) 2299-3279 f (886-2) 2298-0488 www.tw.sgs.com

V

臺灣檢驗科技股份有限公司 - 電子暨通訊實驗室  
 Address : 台北縣五股工業區五工路 134 號  
 Tel:02-2299-3279 Fax:02-2298-2698

**Radiated Emission Measurement**



File : EI70001 Data : #77 Date : 2012/7/18 Time : 下午 04:16:05

Site : 966-2 Chamber Polarization: **Vertical** Temperature: 25 °C  
 Limit: FCC Class B 3M Radiation Power: AC 120V/60Hz Humidity: 60%  
 EUT: ARGON MINI Distance:  
 M/N: 8305/3345  
 Mode: Config 1:GSM 1900;10% Battery Capacity  
 Note:

No.	Mk.	Freq.	Reading Level	Correct Factor	Measurement	Limit	Over	Detector	Comment
		MHz	dBuV	dB	dBuV/m	dBuV/m	dB		
1	*	30.0000	49.12	-14.63	34.49	40.00	-5.51	QP	
2		59.1000	34.05	-14.69	19.36	40.00	-20.64	QP	
3		72.6800	35.94	-16.95	18.99	40.00	-21.01	QP	
4		109.5400	34.22	-15.87	18.35	43.50	-25.15	QP	
5		130.8800	45.57	-14.03	31.54	43.50	-11.96	QP	
6		392.7800	32.69	-10.04	22.65	46.00	-23.35	QP	

\*:Maximum data x:Over limit !:over margin ●ReferenceOnly

File : EI70001\Data : #77

Page : 1

Engineer Signature:

Printed with FinePrint - purchase at [www.fineprint.com](http://www.fineprint.com)

Unless otherwise stated the results shown in this test report refer only to the sample(s) tested and such sample(s) are retained for 90 days only.

除非另有說明，此報告結果僅對測試之樣品負責，同時此樣品僅保留 90 天。本報告未經本公司書面許可，不可部份複製。

This document is issued by the Company subject to its General Conditions of Service printed overleaf, available on request or accessible at [www.sgs.com/terms\\_and\\_conditions.htm](http://www.sgs.com/terms_and_conditions.htm) and, for electronic format documents, subject to Terms and Conditions for Electronic Documents at [www.sgs.com/terms\\_e-document.htm](http://www.sgs.com/terms_e-document.htm). Attention is drawn to the limitation of liability, indemnification and jurisdiction issues defined therein. Any holder of this document is advised that information contained hereon reflects the Company's findings at the time of its intervention only and within the limits of Client's instructions, if any. The Company's sole responsibility is to its Client and this document does not exonerate parties to a transaction from exercising all their rights and obligations under the transaction documents. This document cannot be reproduced except in full, without prior written approval of the Company. Any unauthorized alteration, forgery or falsification of the content or appearance of this document is unlawful and offenders may be prosecuted to the fullest extent of the law.

SGS Taiwan Ltd. No.134, Wu Kung Road, Wuku Industrial Zone, Taipei County, Taiwan / 台北縣五股工業區五工路 134 號

台灣檢驗科技股份有限公司 t (886-2) 2299-3279 f (886-2) 2298-0488 [www.tw.sgs.com](http://www.tw.sgs.com)

## Config 2:Data Link H

臺灣檢驗科技股份有限公司-電子暨通訊實驗室  
Address: 台北縣五股工業區五工路 134 號  
Tel:02-2299-3279 Fax:02-2298-2698

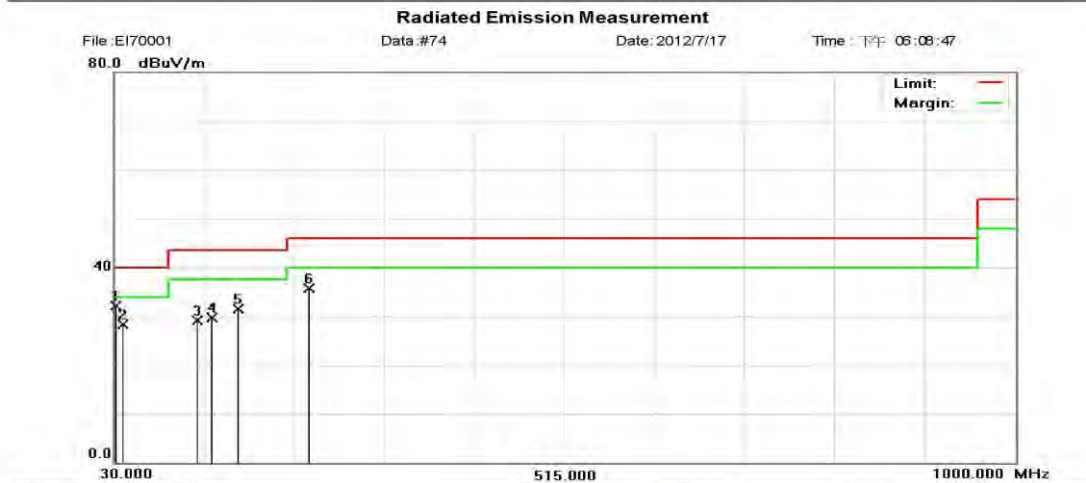

File: EI70001 Data: #74 Date: 2012/7/17 Time: 下午 06:08:47

Site: 966-2 Chamber Polarization: **Horizontal** Temperature: 25 °C  
Limit: FCC Class B 3M Radiation Power: AC 120V/60Hz Humidity: 60%  
EUT: ARGON MINI Distance:  
M/N: 8305/3345  
Mode: Config 2:Data Link;10% Battery Capacity  
Note:

No.	Mk.	Freq. MHz	Reading Level dBuV	Correct Factor dB	Measure- ment dBuV/m	Limit dBuV/m	Over dB	Detector	Comment
1	*	31.9400	46.82	-14.66	32.16	40.00	-7.84	QP	
2		39.7000	42.64	-14.32	28.32	40.00	-11.68	QP	
3		119.2400	43.87	-14.78	29.09	43.50	-14.41	QP	
4		134.7600	43.61	-13.89	29.72	43.50	-13.78	QP	
5		163.8600	44.90	-13.31	31.59	43.50	-11.91	QP	
6		239.5200	50.19	-14.40	35.79	46.00	-10.21	QP	

\*:Maximum data x:Over limit !:over margin

■ReferenceOnly

File:EI70001\Data:#74

Page: 1

Engineer Signature:

Printed with FinePrint - purchase at www.fineprint.com

Unless otherwise stated the results shown in this test report refer only to the sample(s) tested and such sample(s) are retained for 90 days only.

除非另有說明，此報告結果僅對測試之樣品負責，同時此樣品僅保留 90 天。本報告未經本公司書面許可，不可部份複製。

This document is issued by the Company subject to its General Conditions of Service printed overleaf, available on request or accessible at [www.sgs.com/terms\\_and\\_conditions.htm](http://www.sgs.com/terms_and_conditions.htm) and, for electronic format documents, subject to Terms and Conditions for Electronic Documents at [www.sgs.com/terms\\_e-document.htm](http://www.sgs.com/terms_e-document.htm). Attention is drawn to the limitation of liability, indemnification and jurisdiction issues defined therein. Any holder of this document is advised that information contained hereon reflects the Company's findings at the time of its intervention only and within the limits of Client's instructions, if any. The Company's sole responsibility is to its Client and this document does not exonerate parties to a transaction from exercising all their rights and obligations under the transaction documents. This document cannot be reproduced except in full, without prior written approval of the Company. Any unauthorized alteration, forgery or falsification of the content or appearance of this document is unlawful and offenders may be prosecuted to the fullest extent of the law.

SGS Taiwan Ltd.No.134, Wu Kung Road, Wuku Industrial Zone, Taipei County, Taiwan /台北縣五股工業區五工路 134 號

台灣檢驗科技股份有限公司 t (886-2) 2299-3279 f (886-2) 2298-0488 www.tw.sgs.com

V

臺灣檢驗科技股份有限公司 - 電子暨通訊實驗室  
 Address : 台北縣五股工業區五工路 134 號  
 Tel:02-2299-3279 Fax:02-2298-2698

**Radiated Emission Measurement**



File : EI70001 Data #73 Date: 2012/7/17 Time : 下午 05:05:45  
 Site : 966-2 Chamber Polarization: **Vertical** Temperature: 25 °C  
 Limit: FCC Class B 3M Radiation Power: AC 120V/60Hz Humidity: 60%  
 EUT: ARGON MINI Distance:  
 M/N: 8305/3345  
 Mode: Config 2:Data Link;10% Battery Capacity  
 Note:

No.	Mk.	Freq. MHz	Reading Level dBuV	Correct Factor dB	Measurement dBuV/m	Limit dBuV/m	Over dB	Detector	Comment
1	*	31.9400	47.64	-14.66	32.98	40.00	-7.02	QP	
2		41.6400	44.28	-14.25	30.03	40.00	-9.97	QP	
3		61.0400	37.52	-14.93	22.59	40.00	-17.41	QP	
4		119.2400	48.20	-14.78	33.42	43.50	-10.08	QP	
5		163.8600	44.43	-13.31	31.12	43.50	-12.38	QP	
6		239.5200	50.49	-14.40	36.09	46.00	-9.91	QP	

\*:Maximum data x:Over limit !:over margin ■ReferenceOnly

File : EI70001\Data : #73

Page : 1

Engineer Signature:

Printed with FilePrint - purchase at [www.fileprint.com](http://www.fileprint.com)

Unless otherwise stated the results shown in this test report refer only to the sample(s) tested and such sample(s) are retained for 90 days only.

除非另有說明，此報告結果僅對測試之樣品負責，同時此樣品僅保留 90 天。本報告未經本公司書面許可，不可部份複製。

This document is issued by the Company subject to its General Conditions of Service printed overleaf, available on request or accessible at [www.sgs.com/terms\\_and\\_conditions.htm](http://www.sgs.com/terms_and_conditions.htm) and, for electronic format documents, subject to Terms and Conditions for Electronic Documents at [www.sgs.com/terms\\_e-document.htm](http://www.sgs.com/terms_e-document.htm). Attention is drawn to the limitation of liability, indemnification and jurisdiction issues defined therein. Any holder of this document is advised that information contained hereon reflects the Company's findings at the time of its intervention only and within the limits of Client's instructions, if any. The Company's sole responsibility is to its Client and this document does not exonerate parties to a transaction from exercising all their rights and obligations under the transaction documents. This document cannot be reproduced except in full, without prior written approval of the Company. Any unauthorized alteration, forgery or falsification of the content or appearance of this document is unlawful and offenders may be prosecuted to the fullest extent of the law.

SGS Taiwan Ltd.No.134, Wu Kung Road, Wuku Industrial Zone, Taipei County, Taiwan / 台北縣五股工業區五工路 134 號

台灣檢驗科技股份有限公司 t (886-2) 2299-3279 f (886-2) 2298-0488 [www.tw.sgs.com](http://www.tw.sgs.com)

**Config 3: Recording**  
**H**

臺灣檢驗科技股份有限公司 - 電子暨通訊實驗室  
Address: 台北縣五股工業區五工路 134 號  
Tel: 02-2299-3279 Fax: 02-2298-2698

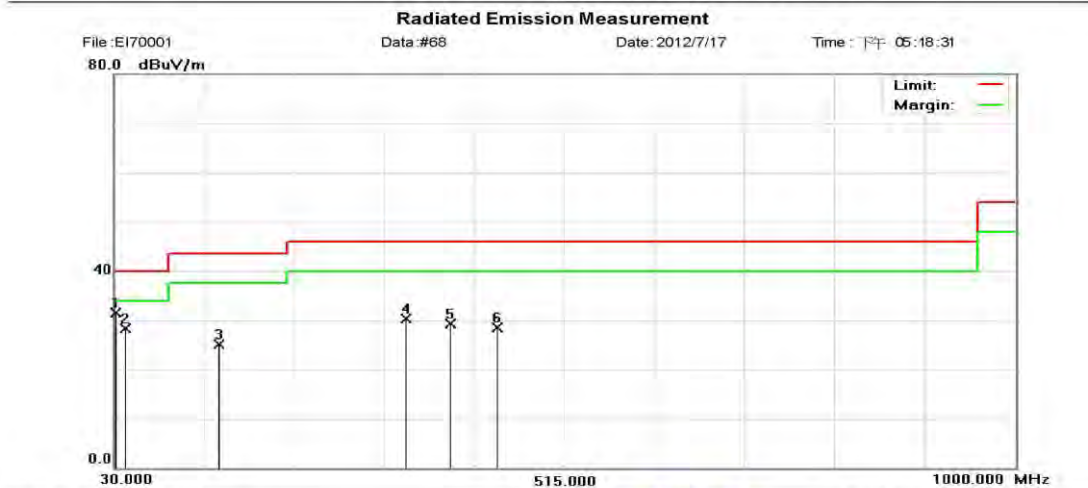

File: EI70001 Data: #68 Date: 2012/7/17 Time: 下午 05:18:31

Site: 966-2 Chamber Polarization: **Horizontal** Temperature: 25 °C  
Limit: FCC Class B 3M Radiation Power: AC 120V/60Hz Humidity: 60%  
EUT: ARGON MINI Distance:  
M/N: 8305/3345  
Mode: Config 3:Recording;10% Battery Capacity  
Note:

No.	Mk.	Freq. MHz	Reading Level dBuV	Correct Factor dB	Measure- ment dBuV/m	Limit dBuV/m	Over dB	Detector	Comment
1	*	31.9400	46.23	-14.66	31.57	40.00	-8.43	QP	
2		41.6400	42.62	-14.25	28.37	40.00	-11.63	QP	
3		142.5200	38.75	-13.60	25.15	43.50	-18.35	QP	
4		344.2800	41.88	-11.48	30.40	46.00	-15.60	QP	
5		392.7800	39.32	-10.04	29.28	46.00	-16.72	QP	
6		443.2200	36.90	-8.49	28.41	46.00	-17.59	QP	

\*:Maximum data x:Over limit !:over margin ●ReferenceOnly

File: EI70001>Data: #68

Page: 1

Engineer Signature:

Printed with FinePrint - purchase at www.fineprint.com

Unless otherwise stated the results shown in this test report refer only to the sample(s) tested and such sample(s) are retained for 90 days only.

除非另有說明，此報告結果僅對測試之樣品負責，同時此樣品僅保留 90 天。本報告未經本公司書面許可，不可部份複製。

This document is issued by the Company subject to its General Conditions of Service printed overleaf, available on request or accessible at [www.sgs.com/terms\\_and\\_conditions.htm](http://www.sgs.com/terms_and_conditions.htm) and, for electronic format documents, subject to Terms and Conditions for Electronic Documents at [www.sgs.com/terms\\_e-document.htm](http://www.sgs.com/terms_e-document.htm). Attention is drawn to the limitation of liability, indemnification and jurisdiction issues defined therein. Any holder of this document is advised that information contained hereon reflects the Company's findings at the time of its intervention only and within the limits of Client's instructions, if any. The Company's sole responsibility is to its Client and this document does not exonerate parties to a transaction from exercising all their rights and obligations under the transaction documents. This document cannot be reproduced except in full, without prior written approval of the Company. Any unauthorized alteration, forgery or falsification of the content or appearance of this document is unlawful and offenders may be prosecuted to the fullest extent of the law.

SGS Taiwan Ltd.No.134, Wu Kung Road, Wuku Industrial Zone, Taipei County, Taiwan /台北縣五股工業區五工路 134 號

台灣檢驗科技股份有限公司 t (886-2) 2299-3279 f (886-2) 2298-0488 www.tw.sgs.com

V

臺灣檢驗科技股份有限公司 - 電子暨通訊實驗室  
 Address : 台北縣五股工業區五工路 134 號  
 Tel:02-2299-3279 Fax:02-2298-2698

**Radiated Emission Measurement**



File: EI70001 Data: #67 Date: 2012/7/17 Time: 下午 05:15:28

Site :966-2 Chamber Polarization: **Vertical** Temperature: 25 °C  
 Limit: FCC Class B 3M Radiation Power: AC 120V/60Hz Humidity: 60%  
 EUT: ARGON MINI Distance:  
 M/N: 8305/3345  
 Mode: Config 3:Recording;10% Battery Capacity  
 Note:

No.	Mk.	Freq.	Reading Level	Correct Factor	Measurement	Limit	Over	Detector	Comment
		MHz	dBuV	dB	dBuV/m	dBuV/m	dB		
1	*	31.9400	47.52	-14.66	32.86	40.00	-7.14	QP	
2		41.6400	44.32	-14.25	30.07	40.00	-9.93	QP	
3		80.4400	39.67	-17.84	21.83	40.00	-18.17	QP	
4		123.1200	36.10	-14.50	21.60	43.50	-21.90	QP	
5		183.2600	39.88	-14.41	25.47	43.50	-18.03	QP	
6		534.4000	32.54	-6.73	25.81	46.00	-20.19	QP	

\*:Maximum data x:Over limit !:over margin ●ReferenceOnly

File:EI70001\Data:#67

Page: 1

Engineer Signature:

Printed with FinePrint - purchase at [www.fineprint.com](http://www.fineprint.com)

Unless otherwise stated the results shown in this test report refer only to the sample(s) tested and such sample(s) are retained for 90 days only.

除非另有說明，此報告結果僅對測試之樣品負責，同時此樣品僅保留 90 天。本報告未經本公司書面許可，不可部份複製。

This document is issued by the Company subject to its General Conditions of Service printed overleaf, available on request or accessible at [www.sgs.com/terms\\_and\\_conditions.htm](http://www.sgs.com/terms_and_conditions.htm) and, for electronic format documents, subject to Terms and Conditions for Electronic Documents at [www.sgs.com/terms\\_e-document.htm](http://www.sgs.com/terms_e-document.htm). Attention is drawn to the limitation of liability, indemnification and jurisdiction issues defined therein. Any holder of this document is advised that information contained hereon reflects the Company's findings at the time of its intervention only and within the limits of Client's instructions, if any. The Company's sole responsibility is to its Client and this document does not exonerate parties to a transaction from exercising all their rights and obligations under the transaction documents. This document cannot be reproduced except in full, without prior written approval of the Company. Any unauthorized alteration, forgery or falsification of the content or appearance of this document is unlawful and offenders may be prosecuted to the fullest extent of the law.

SGS Taiwan Ltd.No.134, Wu Kung Road, Wuku Industrial Zone, Taipei County, Taiwan /台北縣五股工業區五工路 134 號

台灣檢驗科技股份有限公司 t (886-2) 2299-3279 f (886-2) 2298-0488 [www.tw.sgs.com](http://www.tw.sgs.com)

## Config 3:Play Recording H

臺灣檢驗科技股份有限公司-電子暨通訊實驗室  
Address:台北縣五股工業區五工路 134 號  
Tel:02-2299-3279 Fax:02-2298-2698

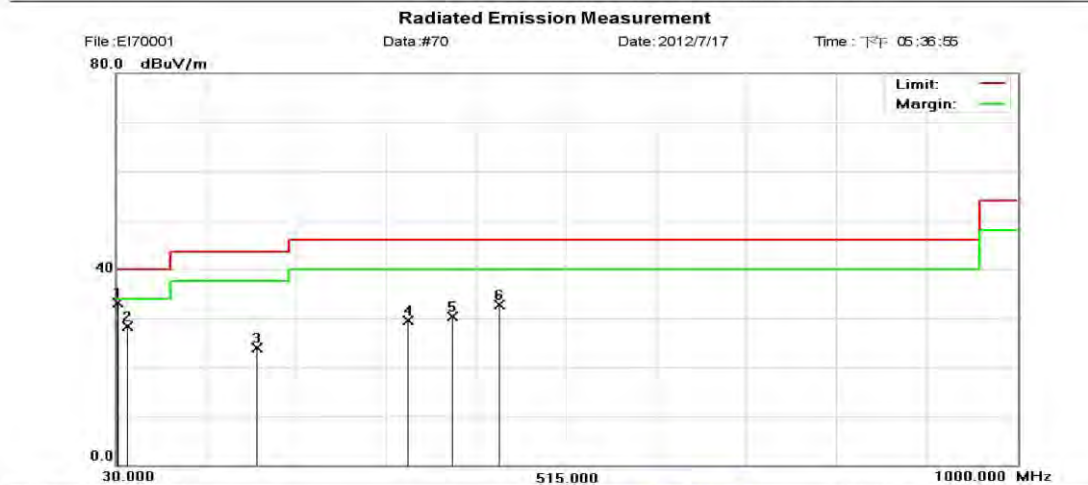

File: EI70001 Data: #70 Date: 2012/7/17 Time: 下午 05:36:55

Site: 966-2 Chamber Polarization: **Horizontal** Temperature: 25 °C  
Limit: FCC Class B 3M Radiation Power: AC 120V/60Hz Humidity: 60%  
EUT: ARGON MINI Distance:  
M/N: 8305/3345  
Mode: Config 3:Play Recording;10% Battery Capacity  
Note:

No.	Mk.	Freq.	Reading Level	Correct Factor	Measurement	Limit	Over	Detector	Comment
		MHz	dBuV	dB	dBuV/m	dBuV/m	dB		
1	*	31.9400	47.68	-14.66	33.02	40.00	-6.98	QP	
2		41.6400	42.60	-14.25	28.35	40.00	-11.65	QP	
3		181.3200	38.23	-14.23	24.00	43.50	-19.50	QP	
4		344.2800	40.89	-11.48	29.41	46.00	-16.59	QP	
5		392.7800	40.36	-10.04	30.32	46.00	-15.68	QP	
6		443.2200	41.13	-8.49	32.64	46.00	-13.36	QP	

\*:Maximum data x:Over limit !:over margin

●ReferenceOnly

File:EI70001Data:#70

Page: 1

Engineer Signature:

Printed with FinePrint - purchase at www.fineprint.com

Unless otherwise stated the results shown in this test report refer only to the sample(s) tested and such sample(s) are retained for 90 days only.

除非另有說明，此報告結果僅對測試之樣品負責，同時此樣品僅保留 90 天。本報告未經本公司書面許可，不可部份複製。

This document is issued by the Company subject to its General Conditions of Service printed overleaf, available on request or accessible at [www.sgs.com/terms\\_and\\_conditions.htm](http://www.sgs.com/terms_and_conditions.htm) and, for electronic format documents, subject to Terms and Conditions for Electronic Documents at [www.sgs.com/terms\\_e-document.htm](http://www.sgs.com/terms_e-document.htm). Attention is drawn to the limitation of liability, indemnification and jurisdiction issues defined therein. Any holder of this document is advised that information contained hereon reflects the Company's findings at the time of its intervention only and within the limits of Client's instructions, if any. The Company's sole responsibility is to its Client and this document does not exonerate parties to a transaction from exercising all their rights and obligations under the transaction documents. This document cannot be reproduced except in full, without prior written approval of the Company. Any unauthorized alteration, forgery or falsification of the content or appearance of this document is unlawful and offenders may be prosecuted to the fullest extent of the law.

SGS Taiwan Ltd.No.134, Wu Kung Road, Wuku Industrial Zone, Taipei County, Taiwan /台北縣五股工業區五工路 134 號

台灣檢驗科技股份有限公司 t (886-2) 2299-3279 f (886-2) 2298-0488 www.tw.sgs.com

V

臺灣檢驗科技股份有限公司 - 電子暨通訊實驗室  
 Address : 台北縣五股工業區五工路 134 號  
 Tel:02-2299-3279 Fax:02-2298-2698

**Radiated Emission Measurement**



File :EI70001 Data #97 Date:2012/7/17 Time : 下午 05:33:53  
 Site :966-2Chamber Polarization: **Vertical** Temperature: 25 °C  
 Limit: FCC Class B 3M Radiation Power: AC 120V/60Hz Humidity: 60%  
 EUT: ARGON MINI Distance:  
 M/N: 8305/3345  
 Mode: Config 3:Play Recording;10% Battery Capacity  
 Note:

No.	Mk.	Freq. MHz	Reading Level dBuV	Correct Factor dB	Measurement dBuV/m	Limit dBuV/m	Over dB	Detector	Comment
1	*	31.9400	48.05	-14.66	33.39	40.00	-6.61	QP	
2		39.7000	44.86	-14.32	30.54	40.00	-9.46	QP	
3		123.1200	36.21	-14.50	21.71	43.50	-21.79	QP	
4		183.2600	38.95	-14.41	24.54	43.50	-18.96	QP	
5		344.2800	36.94	-11.48	25.46	46.00	-20.54	QP	
6		443.2200	34.98	-8.49	26.49	46.00	-19.51	QP	

\*:Maximum data x:Over limit !:over margin ■ReferenceOnly

File :EI70001\Data :#97

Page: 1

Engineer Signature:

Printed with FilePrint - purchase at www.fileprint.com

Unless otherwise stated the results shown in this test report refer only to the sample(s) tested and such sample(s) are retained for 90 days only.

除非另有說明，此報告結果僅對測試之樣品負責，同時此樣品僅保留 90 天。本報告未經本公司書面許可，不可部份複製。

This document is issued by the Company subject to its General Conditions of Service printed overleaf, available on request or accessible at [www.sgs.com/terms\\_and\\_conditions.htm](http://www.sgs.com/terms_and_conditions.htm) and, for electronic format documents, subject to Terms and Conditions for Electronic Documents at [www.sgs.com/terms\\_e-document.htm](http://www.sgs.com/terms_e-document.htm). Attention is drawn to the limitation of liability, indemnification and jurisdiction issues defined therein. Any holder of this document is advised that information contained hereon reflects the Company's findings at the time of its intervention only and within the limits of Client's instructions, if any. The Company's sole responsibility is to its Client and this document does not exonerate parties to a transaction from exercising all their rights and obligations under the transaction documents. This document cannot be reproduced except in full, without prior written approval of the Company. Any unauthorized alteration, forgery or falsification of the content or appearance of this document is unlawful and offenders may be prosecuted to the fullest extent of the law.

SGS Taiwan Ltd.No.134, Wu Kung Road, Wuku Industrial Zone, Taipei County, Taiwan /台北縣五股工業區五工路 134 號

台灣檢驗科技股份有限公司 t (886-2) 2299-3279 f (886-2) 2298-0488 www.tw.sgs.com

**Config 3:MP3**  
**H**

臺灣檢驗科技股份有限公司 - 電子暨通訊實驗室  
Address: 台北縣五股工業區五工路 134 號  
Tel:02-2299-3279 Fax:02-2298-2698

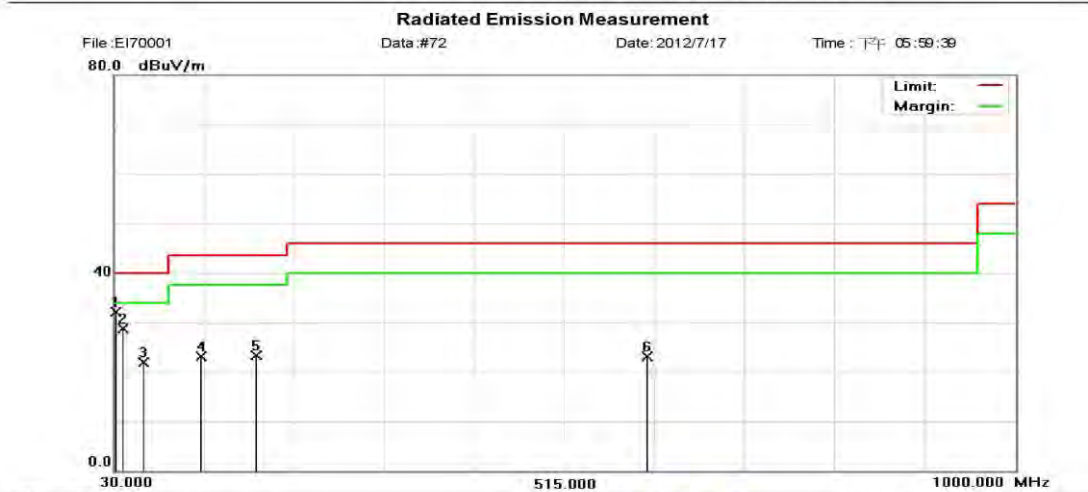

File: EI70001 Data: #72 Date: 2012/7/17 Time: 下午 05:59:39

Site :966-2Chamber Polarization: **Horizontal** Temperature: 25 °C  
Limit: FCC Class B 3M Radiation Power: AC 120V/60Hz Humidity: 60%  
EUT: ARGON MINI Distance:  
MN: 8305/3345  
Mode: Config 3:MP3;10% Battery Capacity  
Note:

No.	Mk.	Freq. MHz	Reading Level dBuV	Correct Factor dB	Measure- ment dBuV/m	Limit dBuV/m	Over dB	Detector	Comment
1	*	31.9400	46.79	-14.66	32.13	40.00	-7.87	QP	
2		39.7000	42.95	-14.32	28.63	40.00	-11.37	QP	
3		61.0400	36.77	-14.93	21.84	40.00	-18.16	QP	
4		123.1200	37.53	-14.50	23.03	43.50	-20.47	QP	
5		183.2600	37.62	-14.41	23.21	43.50	-20.29	QP	
6		604.2400	27.97	-4.93	23.04	46.00	-22.96	QP	

\*:Maximum data x:Over limit !:over margin ●ReferenceOnly

File: EI70001\Data :#72

Page: 1

Engineer Signature:

Printed with FinePrint - purchase at www.fineprint.com

Unless otherwise stated the results shown in this test report refer only to the sample(s) tested and such sample(s) are retained for 90 days only.

除非另有說明，此報告結果僅對測試之樣品負責，同時此樣品僅保留 90 天。本報告未經本公司書面許可，不可部份複製。

This document is issued by the Company subject to its General Conditions of Service printed overleaf, available on request or accessible at [www.sgs.com/terms\\_and\\_conditions.htm](http://www.sgs.com/terms_and_conditions.htm) and, for electronic format documents, subject to Terms and Conditions for Electronic Documents at [www.sgs.com/terms\\_e-document.htm](http://www.sgs.com/terms_e-document.htm). Attention is drawn to the limitation of liability, indemnification and jurisdiction issues defined therein. Any holder of this document is advised that information contained hereon reflects the Company's findings at the time of its intervention only and within the limits of Client's instructions, if any. The Company's sole responsibility is to its Client and this document does not exonerate parties to a transaction from exercising all their rights and obligations under the transaction documents. This document cannot be reproduced except in full, without prior written approval of the Company. Any unauthorized alteration, forgery or falsification of the content or appearance of this document is unlawful and offenders may be prosecuted to the fullest extent of the law.

SGS Taiwan Ltd.No.134, Wu Kung Road, Wuku Industrial Zone, Taipei County, Taiwan /台北縣五股工業區五工路 134 號

台灣檢驗科技股份有限公司 t (886-2) 2299-3279 f (886-2) 2298-0488 www.tw.sgs.com

V

臺灣檢驗科技股份有限公司 - 電子暨通訊實驗室  
 Address : 台北縣五股工業區五工路 134 號  
 Tel:02-2299-3279 Fax:02-2298-2698

**Radiated Emission Measurement**



File :EI70001 Data #71 Date:2012/7/17 Time : 下午 05:56:37  
 Site :966-2Chamber Polarization: **Vertical** Temperature: 25 °C  
 Limit: FCC Class B 3M Radiation Power: AC 120V/60Hz Humidity: 60%  
 EUT: ARGON MINI Distance:  
 M/N: 8305/3345  
 Mode: Config 3:MP3;10% Battery Capacity  
 Note:

No.	Mk.	Freq. MHz	Reading Level dBuV	Correct Factor dB	Measurement dBuV/m	Limit dBuV/m	Over dB	Detector	Comment
1	*	31.9400	46.44	-14.66	31.78	40.00	-8.22	QP	
2		39.7000	44.13	-14.32	29.81	40.00	-10.19	QP	
3		61.0400	36.91	-14.93	21.98	40.00	-18.02	QP	
4		121.1800	35.04	-14.63	20.41	43.50	-23.09	QP	
5		183.2600	38.50	-14.41	24.09	43.50	-19.41	QP	
6		363.6800	32.07	-10.53	21.54	46.00	-24.46	QP	

\*:Maximum data x:Over limit !:over margin ■:ReferenceOnly

File :EI70001\Data :#71

Page: 1

Engineer Signature:

Printed with FilePrint - purchase at www.fileprint.com

Unless otherwise stated the results shown in this test report refer only to the sample(s) tested and such sample(s) are retained for 90 days only.

除非另有說明，此報告結果僅對測試之樣品負責，同時此樣品僅保留 90 天。本報告未經本公司書面許可，不可部份複製。

This document is issued by the Company subject to its General Conditions of Service printed overleaf, available on request or accessible at [www.sgs.com/terms\\_and\\_conditions.htm](http://www.sgs.com/terms_and_conditions.htm) and, for electronic format documents, subject to Terms and Conditions for Electronic Documents at [www.sgs.com/terms\\_e-document.htm](http://www.sgs.com/terms_e-document.htm). Attention is drawn to the limitation of liability, indemnification and jurisdiction issues defined therein. Any holder of this document is advised that information contained hereon reflects the Company's findings at the time of its intervention only and within the limits of Client's instructions, if any. The Company's sole responsibility is to its Client and this document does not exonerate parties to a transaction from exercising all their rights and obligations under the transaction documents. This document cannot be reproduced except in full, without prior written approval of the Company. Any unauthorized alteration, forgery or falsification of the content or appearance of this document is unlawful and offenders may be prosecuted to the fullest extent of the law.

SGS Taiwan Ltd.No.134, Wu Kung Road, Wuku Industrial Zone, Taipei County, Taiwan /台北縣五股工業區五工路 134 號

台灣檢驗科技股份有限公司 t (886-2) 2299-3279 f (886-2) 2298-0488 www.tw.sgs.com

## Config 4:FM 87.6

H

臺灣檢驗科技股份有限公司 - 電子暨通訊實驗室  
 Address: 台北縣五股工業區五工路 134 號  
 Tel:02-2299-3279 Fax:02-2298-2698

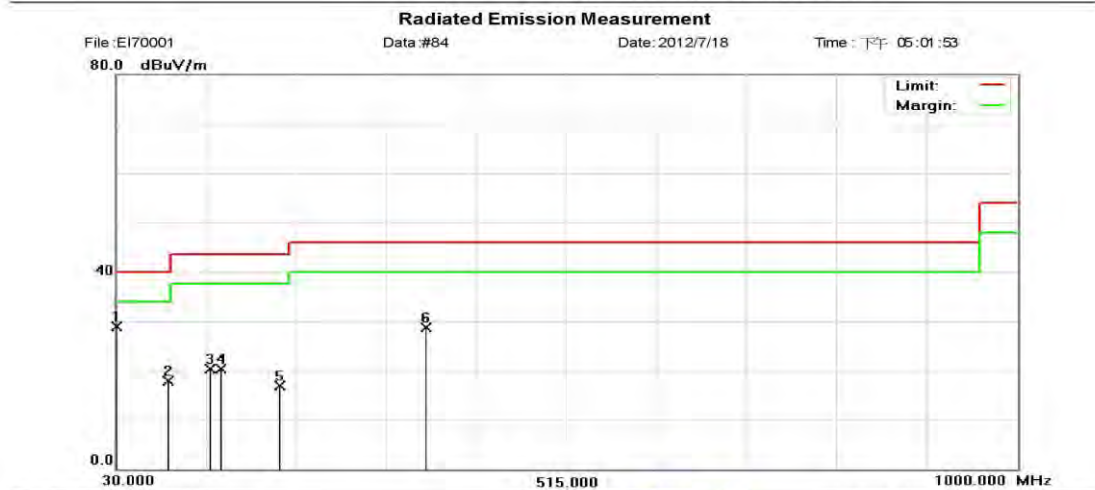

File: EI70001 Data: #84 Date: 2012/7/18 Time: 下午 05:01:53

Site: 966-2 Chamber Polarization: **Horizontal** Temperature: 25 °C  
 Limit: FCC Class B 3M Radiation Power: AC 120V/60Hz Humidity: 60%  
 EUT: ARGON MINI Distance:  
 M/N: 8305/3345  
 Mode: Config 4:FM 87.6;10% Battery Capacity  
 Note:

No.	Mk.	Freq. MHz	Reading Level dBuV	Correct Factor dB	Measure- ment dBuV/m	Limit dBuV/m	Over dB	Detector	Comment
1	*	30.0000	43.51	-14.63	28.88	40.00	-11.12	QP	
2		86.2600	36.36	-18.43	17.93	40.00	-22.07	QP	
3		130.8800	34.38	-14.03	20.35	43.50	-23.15	QP	
4		142.5200	33.81	-13.60	20.21	43.50	-23.29	QP	
5		206.5400	32.59	-15.66	16.93	43.50	-26.57	QP	
6		363.6800	39.32	-10.53	28.79	46.00	-17.21	QP	

\*:Maximum data x:Over limit !:over margin ●ReferenceOnly

File: EI70001>Data: #84

Page: 1

Engineer Signature:

Printed with FinePrint - purchase at [www.fineprint.com](http://www.fineprint.com)

Unless otherwise stated the results shown in this test report refer only to the sample(s) tested and such sample(s) are retained for 90 days only.

除非另有說明，此報告結果僅對測試之樣品負責，同時此樣品僅保留 90 天。本報告未經本公司書面許可，不可部份複製。

This document is issued by the Company subject to its General Conditions of Service printed overleaf, available on request or accessible at [www.sgs.com/terms\\_and\\_conditions.htm](http://www.sgs.com/terms_and_conditions.htm) and, for electronic format documents, subject to Terms and Conditions for Electronic Documents at [www.sgs.com/terms\\_e-document.htm](http://www.sgs.com/terms_e-document.htm). Attention is drawn to the limitation of liability, indemnification and jurisdiction issues defined therein. Any holder of this document is advised that information contained hereon reflects the Company's findings at the time of its intervention only and within the limits of Client's instructions, if any. The Company's sole responsibility is to its Client and this document does not exonerate parties to a transaction from exercising all their rights and obligations under the transaction documents. This document cannot be reproduced except in full, without prior written approval of the Company. Any unauthorized alteration, forgery or falsification of the content or appearance of this document is unlawful and offenders may be prosecuted to the fullest extent of the law.

SGS Taiwan Ltd. No.134, Wu Kung Road, Wuku Industrial Zone, Taipei County, Taiwan / 台北縣五股工業區五工路 134 號

台灣檢驗科技股份有限公司 t (886-2) 2299-3279 f (886-2) 2298-0488 www.tw.sgs.com

V

臺灣檢驗科技股份有限公司 - 電子暨通訊實驗室  
 Address : 台北縣五股工業區五工路 134 號  
 Tel:02-2299-3279 Fax:02-2298-2698

**Radiated Emission Measurement**



File:EI70001 Data:#83 Date:2012/7/18 Time:下午 04:58:51  
 Site :966-2Chamber Polarization: **Vertical** Temperature: 25 °C  
 Limit: FCC Class B 3M Radiation Power: AC 120V/60Hz Humidity: 60%  
 EUT: ARGON MINI Distance:  
 M/N: 8305/3345  
 Mode: Config 4:FM 87.6;10% Battery Capacity  
 Note:

No.	Mk.	Freq. MHz	Reading Level dBuV	Correct Factor dB	Measurement dBuV/m	Limit dBuV/m	Over dB	Detector	Comment
1	*	30.0000	48.71	-14.63	34.08	40.00	-5.92	QP	
2		62.9800	34.74	-15.30	19.44	40.00	-20.56	QP	
3		86.2600	47.72	-18.43	29.29	40.00	-10.71	QP	
4		132.8200	36.15	-13.96	22.19	43.50	-21.31	QP	
5		206.5400	33.22	-15.66	17.56	43.50	-25.94	QP	
6		449.0400	30.55	-8.17	22.38	46.00	-23.62	QP	

\*:Maximum data x:Over limit !:over margin ReferenceOnly

File:EI70001\Data:#83

Page: 1

Engineer Signature:

Printed with FilePrint - purchase at www.fileprint.com

Unless otherwise stated the results shown in this test report refer only to the sample(s) tested and such sample(s) are retained for 90 days only.

除非另有說明，此報告結果僅對測試之樣品負責，同時此樣品僅保留 90 天。本報告未經本公司書面許可，不可部份複製。

This document is issued by the Company subject to its General Conditions of Service printed overleaf, available on request or accessible at [www.sgs.com/terms\\_and\\_conditions.htm](http://www.sgs.com/terms_and_conditions.htm) and, for electronic format documents, subject to Terms and Conditions for Electronic Documents at [www.sgs.com/terms\\_e-document.htm](http://www.sgs.com/terms_e-document.htm). Attention is drawn to the limitation of liability, indemnification and jurisdiction issues defined therein. Any holder of this document is advised that information contained hereon reflects the Company's findings at the time of its intervention only and within the limits of Client's instructions, if any. The Company's sole responsibility is to its Client and this document does not exonerate parties to a transaction from exercising all their rights and obligations under the transaction documents. This document cannot be reproduced except in full, without prior written approval of the Company. Any unauthorized alteration, forgery or falsification of the content or appearance of this document is unlawful and offenders may be prosecuted to the fullest extent of the law.

SGS Taiwan Ltd.No.134, Wu Kung Road, Wuku Industrial Zone, Taipei County, Taiwan /台北縣五股工業區五工路 134 號

台灣檢驗科技股份有限公司 t (886-2) 2299-3279 f (886-2) 2298-0488 www.tw.sgs.com

## Config 4:FM 98.0

H

臺灣檢驗科技股份有限公司-電子暨通訊實驗室  
 Address: 台北縣五股工業區五工路 134 號  
 Tel:02-2299-3279 Fax:02-2298-2698

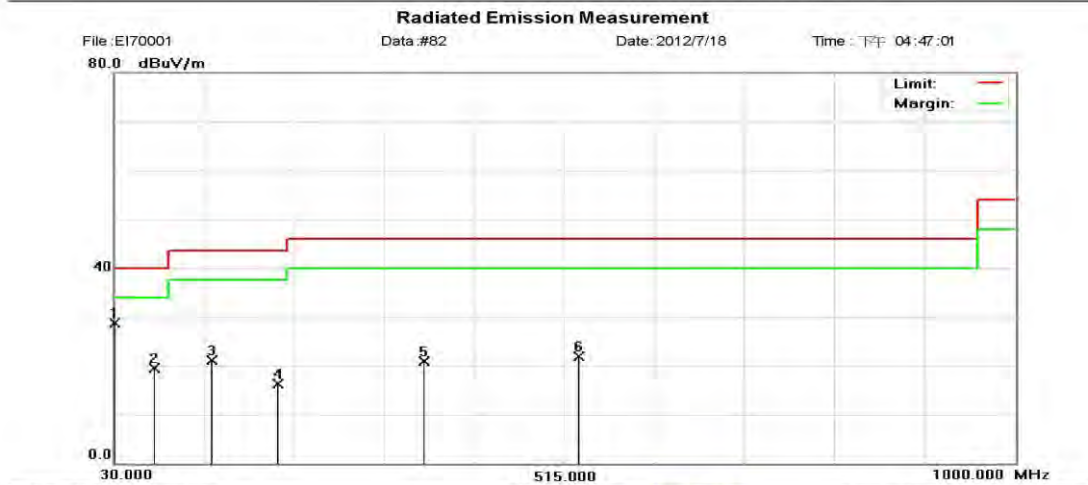

File: EI70001 Data: #82 Date: 2012/7/18 Time: 下午 04:47:01

Site: 966-2 Chamber Polarization: **Horizontal** Temperature: 25 °C  
 Limit: FCC Class B 3M Radiation Power: AC 120V/60Hz Humidity: 60%  
 EUT: ARGON MINI Distance:  
 M/N: 8305/3345  
 Mode: Config 4:FM 98.0;10% Battery Capacity  
 Note:

No.	Mk.	Freq.	Reading Level	Correct Factor	Measurement	Limit	Over	Detector	Comment
		MHz	dBuV	dB	dBuV/m	dBuV/m	dB		
1	*	30.0000	43.25	-14.63	28.62	40.00	-11.38	QP	
2		72.6800	36.41	-16.95	19.46	40.00	-20.54	QP	
3		134.7600	35.01	-13.89	21.12	43.50	-22.38	QP	
4		206.5400	32.03	-15.66	16.37	43.50	-27.13	QP	
5		363.6800	31.52	-10.53	20.99	46.00	-25.01	QP	
6		530.5200	28.66	-6.82	21.84	46.00	-24.16	QP	

\*:Maximum data x:Over limit !:over margin ReferenceOnly

File:EI70001\Data:#82

Page: 7

Engineer Signature:

Printed with FinePrint - purchase at www.fineprint.com

Unless otherwise stated the results shown in this test report refer only to the sample(s) tested and such sample(s) are retained for 90 days only.

除非另有說明，此報告結果僅對測試之樣品負責，同時此樣品僅保留 90 天。本報告未經本公司書面許可，不可部份複製。

This document is issued by the Company subject to its General Conditions of Service printed overleaf, available on request or accessible at [www.sgs.com/terms\\_and\\_conditions.htm](http://www.sgs.com/terms_and_conditions.htm) and, for electronic format documents, subject to Terms and Conditions for Electronic Documents at [www.sgs.com/terms\\_e-document.htm](http://www.sgs.com/terms_e-document.htm). Attention is drawn to the limitation of liability, indemnification and jurisdiction issues defined therein. Any holder of this document is advised that information contained hereon reflects the Company's findings at the time of its intervention only and within the limits of Client's instructions, if any. The Company's sole responsibility is to its Client and this document does not exonerate parties to a transaction from exercising all their rights and obligations under the transaction documents. This document cannot be reproduced except in full, without prior written approval of the Company. Any unauthorized alteration, forgery or falsification of the content or appearance of this document is unlawful and offenders may be prosecuted to the fullest extent of the law.

SGS Taiwan Ltd.No.134, Wu Kung Road, Wuku Industrial Zone, Taipei County, Taiwan /台北縣五股工業區五工路 134 號

台灣檢驗科技股份有限公司 t (886-2) 2299-3279 f (886-2) 2298-0488 www.tw.sgs.com

V

臺灣檢驗科技股份有限公司 - 電子暨通訊實驗室  
 Address : 台北縣五股工業區五工路 134 號  
 Tel:02-2299-3279 Fax:02-2298-2698

**Radiated Emission Measurement**

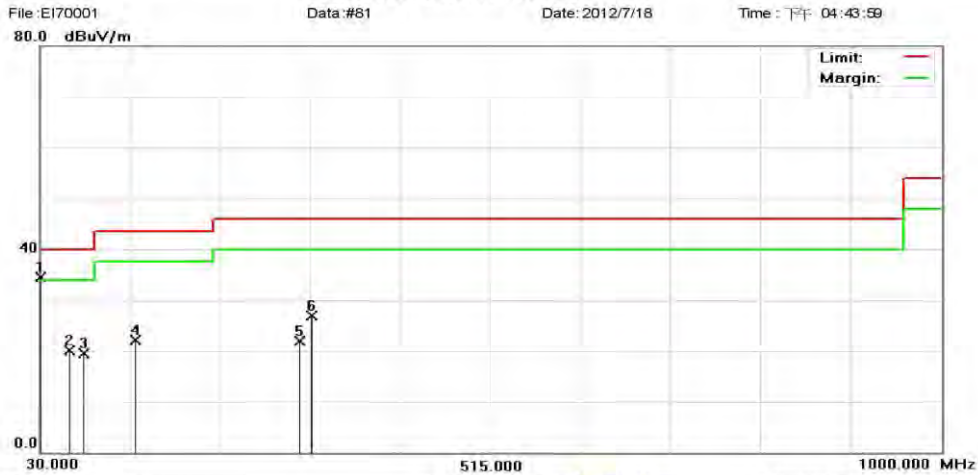

File: EI70001 Data: #81 Date: 2012/7/18 Time: 下午 04:43:59

Site : 966-2 Chamber Polarization: **Vertical** Temperature: 25 °C  
 Limit: FCC Class B 3M Radiation Power: AC 120V/60Hz Humidity: 60%  
 EUT: ARGON MINI Distance:  
 M/N: 8305/3345  
 Mode: Config 4:FM 98.0;10% Battery Capacity  
 Note:

No.	Mk.	Freq. MHz	Reading Level dBuV	Correct Factor dB	Measure- ment dBuV/m	Limit dBuV/m	Over dB	Detector	Comment
1	*	30.0000	49.10	-14.63	34.47	40.00	-5.53	QP	
2		61.0400	35.11	-14.93	20.18	40.00	-19.82	QP	
3		76.5600	36.98	-17.40	19.58	40.00	-20.42	QP	
4		132.8200	36.16	-13.96	22.20	43.50	-21.30	QP	
5		309.3600	33.88	-11.95	21.93	46.00	-24.07	QP	
6		322.9400	38.79	-11.95	26.84	46.00	-19.16	QP	

\*:Maximum data x:Over limit !:over margin ■ReferenceOnly

File:EI70001\Data:#81

Page: 1

Engineer Signature:

Printed with FinePrint - purchase at [www.fineprint.com](http://www.fineprint.com)

Unless otherwise stated the results shown in this test report refer only to the sample(s) tested and such sample(s) are retained for 90 days only.

除非另有說明，此報告結果僅對測試之樣品負責，同時此樣品僅保留 90 天。本報告未經本公司書面許可，不可部份複製。

This document is issued by the Company subject to its General Conditions of Service printed overleaf, available on request or accessible at [www.sgs.com/terms\\_and\\_conditions.htm](http://www.sgs.com/terms_and_conditions.htm) and, for electronic format documents, subject to Terms and Conditions for Electronic Documents at [www.sgs.com/terms\\_e-document.htm](http://www.sgs.com/terms_e-document.htm). Attention is drawn to the limitation of liability, indemnification and jurisdiction issues defined therein. Any holder of this document is advised that information contained hereon reflects the Company's findings at the time of its intervention only and within the limits of Client's instructions, if any. The Company's sole responsibility is to its Client and this document does not exonerate parties to a transaction from exercising all their rights and obligations under the transaction documents. This document cannot be reproduced except in full, without prior written approval of the Company. Any unauthorized alteration, forgery or falsification of the content or appearance of this document is unlawful and offenders may be prosecuted to the fullest extent of the law.

SGS Taiwan Ltd.No.134, Wu Kung Road, Wuku Industrial Zone, Taipei County, Taiwan /台北縣五股工業區五工路 134 號

台灣檢驗科技股份有限公司 t (886-2) 2299-3279 f (886-2) 2298-0488 [www.tw.sgs.com](http://www.tw.sgs.com)

## Config 4:FM 107.9

H

臺灣檢驗科技股份有限公司-電子暨通訊實驗室  
 Address :台北縣五股工業區五工路 134 號  
 Tel:02-2299-3279 Fax:02-2298-2698

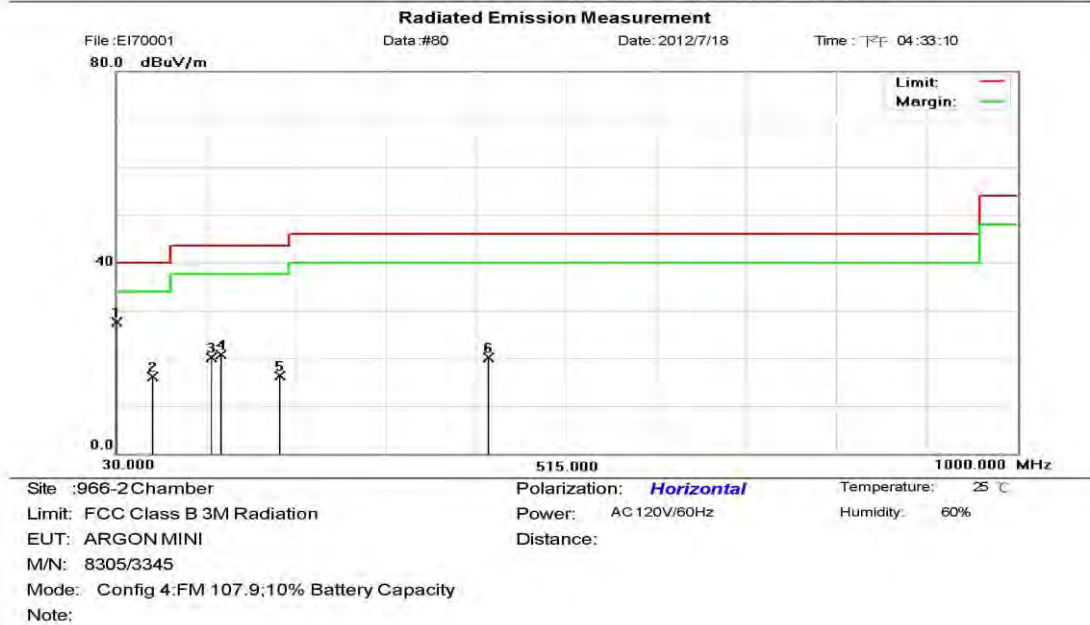

No.	Mk.	Freq. MHz	Reading Level dBuV	Correct Factor dB	Measure- ment dBuV/m	Limit dBuV/m	Over dB	Detector	Comment
1	*	30.0000	42.23	-14.63	27.60	40.00	-12.40	QP	
2		68.8000	32.48	-16.41	16.07	40.00	-23.93	QP	
3		132.8200	33.98	-13.96	20.02	43.50	-23.48	QP	
4		142.5200	34.23	-13.60	20.63	43.50	-22.87	QP	
5		206.5400	31.89	-15.66	16.23	43.50	-27.27	QP	
6		431.5800	29.13	-9.04	20.09	46.00	-25.91	QP	

\*:Maximum data    x:Over limit    !:over margin      ■:ReferenceOnly

File:EI70001\Data:#80

Page: 1

Engineer Signature:

Printed with FinePrint - purchase at [www.fineprint.com](http://www.fineprint.com)

Unless otherwise stated the results shown in this test report refer only to the sample(s) tested and such sample(s) are retained for 90 days only.

除非另有說明，此報告結果僅對測試之樣品負責，同時此樣品僅保留 90 天。本報告未經本公司書面許可，不可部份複製。

This document is issued by the Company subject to its General Conditions of Service printed overleaf, available on request or accessible at [www.sgs.com/terms\\_and\\_conditions.htm](http://www.sgs.com/terms_and_conditions.htm) and, for electronic format documents, subject to Terms and Conditions for Electronic Documents at [www.sgs.com/terms\\_e-document.htm](http://www.sgs.com/terms_e-document.htm). Attention is drawn to the limitation of liability, indemnification and jurisdiction issues defined therein. Any holder of this document is advised that information contained hereon reflects the Company's findings at the time of its intervention only and within the limits of Client's instructions, if any. The Company's sole responsibility is to its Client and this document does not exonerate parties to a transaction from exercising all their rights and obligations under the transaction documents. This document cannot be reproduced except in full, without prior written approval of the Company. Any unauthorized alteration, forgery or falsification of the content or appearance of this document is unlawful and offenders may be prosecuted to the fullest extent of the law.

SGS Taiwan Ltd.No.134, Wu Kung Road, Wuku Industrial Zone, Taipei County, Taiwan /台北縣五股工業區五工路 134 號

台灣檢驗科技股份有限公司    t (886-2) 2299-3279    f (886-2) 2298-0488    www.tw.sgs.com

V

臺灣檢驗科技股份有限公司 - 電子騾通訊實驗室  
 Address : 台北縣五股工業區五工路 134 號  
 Tel:02-2299-3279 Fax:02-2298-2698

**Radiated Emission Measurement**

File : EI70001 Data #79 Date : 2012/7/18 Time : 下午 04:30:07

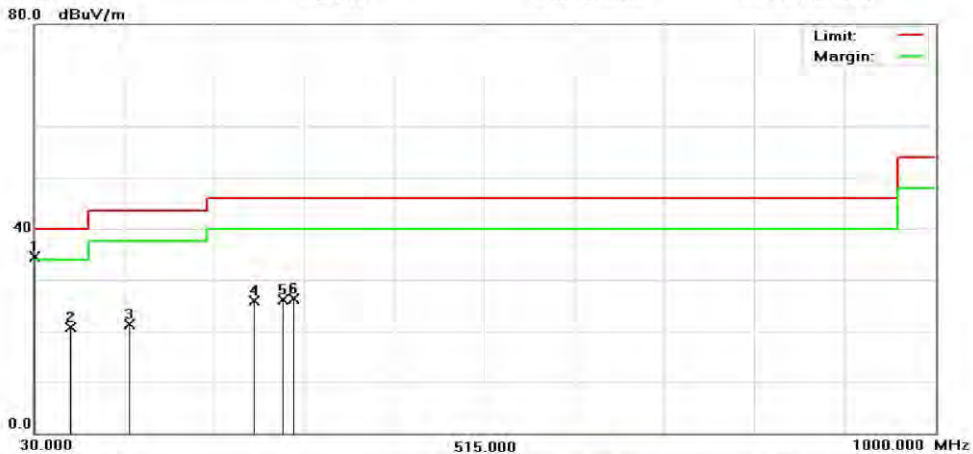

Site : 966-2 Chamber Polarization: **Vertical** Temperature: 25 °C  
 Limit: FCC Class B 3M Radiation Power: AC 120V/60Hz Humidity: 60%  
 EUT: ARGON MINI Distance:  
 M/N: 8305/3345  
 Mode: Config 4:FM 107.9;10% Battery Capacity  
 Note:

No.	Mk.	Freq.	Reading Level	Correct Factor	Measurement	Limit	Over	Detector	Comment
		MHz	dBuV	dB	dBuV/m	dBuV/m	dB		
1	*	30.0000	49.13	-14.63	34.50	40.00	-5.50	QP	
2		68.8000	37.11	-16.41	20.70	40.00	-19.30	QP	
3		132.8200	35.29	-13.96	21.33	43.50	-22.17	QP	
4		266.6800	39.39	-13.48	25.91	46.00	-20.09	QP	
5		297.7200	38.56	-12.43	26.13	46.00	-19.87	QP	
6		309.3600	38.34	-11.95	26.39	46.00	-19.61	QP	

\*:Maximum data x:Over limit !:over margin ■ReferenceOnly

File : EI70001\Data : #79

Page: 1

Engineer Signature:

Printed with FilePrint - purchase at www.fileprint.com

Unless otherwise stated the results shown in this test report refer only to the sample(s) tested and such sample(s) are retained for 90 days only.

除非另有說明，此報告結果僅對測試之樣品負責，同時此樣品僅保留 90 天。本報告未經本公司書面許可，不可部份複製。

This document is issued by the Company subject to its General Conditions of Service printed overleaf, available on request or accessible at [www.sgs.com/terms\\_and\\_conditions.htm](http://www.sgs.com/terms_and_conditions.htm) and, for electronic format documents, subject to Terms and Conditions for Electronic Documents at [www.sgs.com/terms\\_e-document.htm](http://www.sgs.com/terms_e-document.htm). Attention is drawn to the limitation of liability, indemnification and jurisdiction issues defined therein. Any holder of this document is advised that information contained hereon reflects the Company's findings at the time of its intervention only and within the limits of Client's instructions, if any. The Company's sole responsibility is to its Client and this document does not exonerate parties to a transaction from exercising all their rights and obligations under the transaction documents. This document cannot be reproduced except in full, without prior written approval of the Company. Any unauthorized alteration, forgery or falsification of the content or appearance of this document is unlawful and offenders may be prosecuted to the fullest extent of the law.

SGS Taiwan Ltd.No.134, Wu Kung Road, Wuku Industrial Zone, Taipei County, Taiwan /台北縣五股工業區五工路 134 號

台灣檢驗科技股份有限公司 t (886-2) 2299-3279 f (886-2) 2298-0488 www.tw.sgs.com

**Above 1G  
Config 1:GSM850  
H**

臺灣檢驗科技股份有限公司-電子騾通訊實驗室  
Address:台北縣五股工業區五工路 134 號  
Tel:02-2299-3279 Fax:02-2298-2698

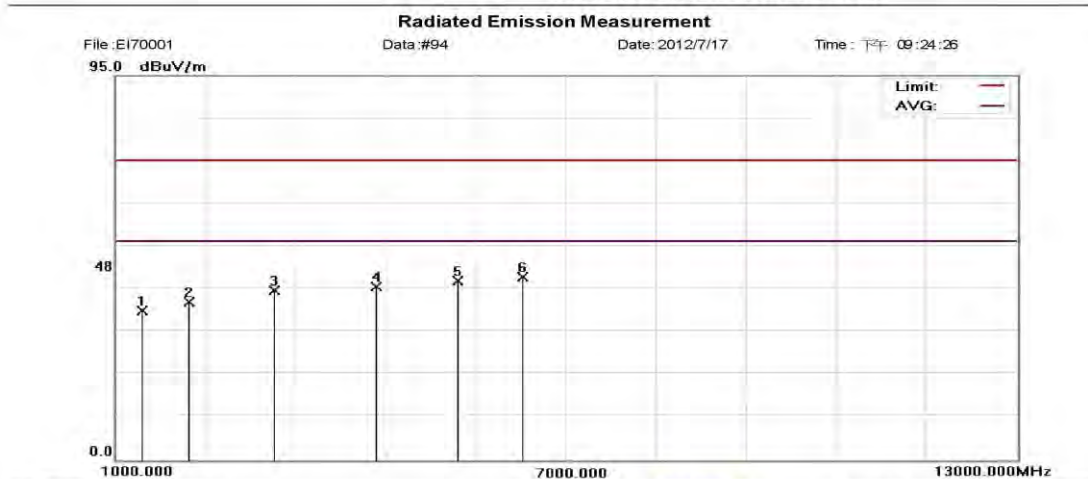

Site :966-2 Chamber Polarization: **Horizontal** Temperature: 25 °C  
Limit: FCC Class B 3M Radiation(1G-40G)(Pea Power: AC 120V/60Hz Humidity: 60%  
EUT: ARGON MINI Distance:  
M/N: 8305/3345  
Mode: Config 1:GSM 850;10% Battery Capacity  
Note:

No.	Mk.	Freq. MHz	Reading Level dBuV	Correct Factor dB	Measure- ment dBuV/m	Limit dBuV/m	Over dB	Detector	Comment
1		1360.000	39.69	-2.75	36.94	74.00	-37.06	peak	
2		1984.000	38.18	0.98	39.16	74.00	-34.84	peak	
3		3112.000	38.31	3.53	41.84	74.00	-32.16	peak	
4		4480.000	36.99	5.95	42.94	74.00	-31.06	peak	
5		5560.000	36.86	7.55	44.41	74.00	-29.59	peak	
6	*	6424.000	36.32	8.91	45.23	74.00	-28.77	peak	

\*:Maximum data x:Over limit !:over margin ●ReferenceOnly

File:EI70001\Data:#94

Page: 1

Engineer Signature:

Printed with FinePrint - purchase at www.fineprint.com

Unless otherwise stated the results shown in this test report refer only to the sample(s) tested and such sample(s) are retained for 90 days only.

除非另有說明，此報告結果僅對測試之樣品負責，同時此樣品僅保留 90 天。本報告未經本公司書面許可，不可部份複製。

This document is issued by the Company subject to its General Conditions of Service printed overleaf, available on request or accessible at [www.sgs.com/terms\\_and\\_conditions.htm](http://www.sgs.com/terms_and_conditions.htm) and, for electronic format documents, subject to Terms and Conditions for Electronic Documents at [www.sgs.com/terms\\_e-document.htm](http://www.sgs.com/terms_e-document.htm). Attention is drawn to the limitation of liability, indemnification and jurisdiction issues defined therein. Any holder of this document is advised that information contained hereon reflects the Company's findings at the time of its intervention only and within the limits of Client's instructions, if any. The Company's sole responsibility is to its Client and this document does not exonerate parties to a transaction from exercising all their rights and obligations under the transaction documents. This document cannot be reproduced except in full, without prior written approval of the Company. Any unauthorized alteration, forgery or falsification of the content or appearance of this document is unlawful and offenders may be prosecuted to the fullest extent of the law.

SGS Taiwan Ltd.No.134, Wu Kung Road, Wuku Industrial Zone, Taipei County, Taiwan /台北縣五股工業區五工路 134 號

台灣檢驗科技股份有限公司 t (886-2) 2299-3279 f (886-2) 2298-0488 www.tw.sgs.com

V

臺灣檢驗科技股份有限公司-電子暨通訊實驗室  
 Address : 台北縣五股工業區五工路 134 號  
 Tel:02-2299-3279 Fax:02-2298-2698

**Radiated Emission Measurement**

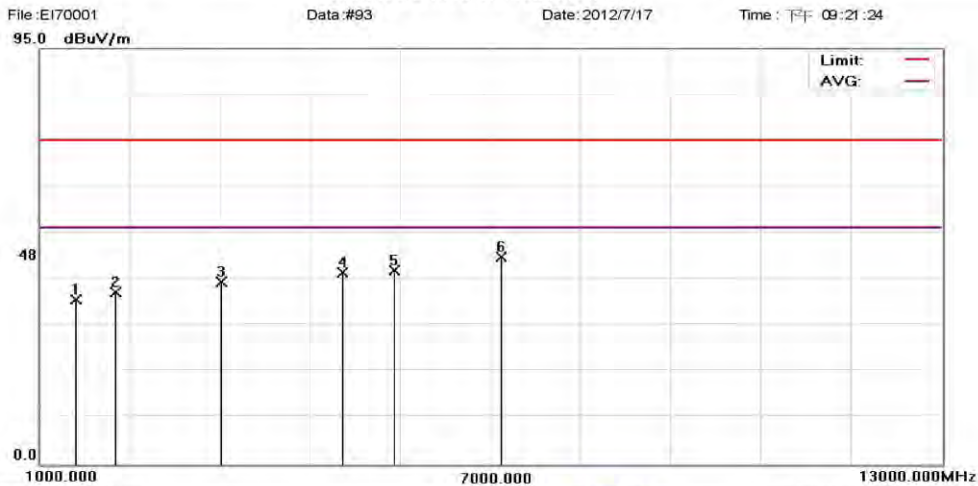

File :EI70001 Data :#93 Date :2012/7/17 Time : 下午 09:21:24  
 Site :966-2 Chamber Polarization: **Vertical** Temperature: 25 °C  
 Limit: FCC Class B 3M Radiation(1G-40G)(Pea Power: AC 120V/60Hz Humidity: 60%  
 EUT: ARGON MINI Distance:  
 M/N: 8305/3345  
 Mode: Config 1 :GSM 850;10% Battery Capacity  
 Note:

No.	Mk.	Freq. MHz	Reading Level dBuV	Correct Factor dB	Measure- ment dBuV/m	Limit dBuV/m	Over dB	Detector	Comment
1		1480.000	40.14	-2.54	37.60	74.00	-36.40	peak	
2		2008.000	38.18	1.14	39.32	74.00	-34.68	peak	
3		3424.000	37.59	4.08	41.67	74.00	-32.33	peak	
4		5032.000	36.95	6.78	43.73	74.00	-30.27	peak	
5		5728.000	36.45	7.78	44.23	74.00	-29.77	peak	
6	*	7144.000	38.03	9.38	47.41	74.00	-26.59	peak	

\*:Maximum data x:Over limit !:over margin ●ReferenceOnly

File :EI70001\Data :#93

Page: 1

Engineer Signature:

Printed with FinePrint - purchase at www.fineprint.com

Unless otherwise stated the results shown in this test report refer only to the sample(s) tested and such sample(s) are retained for 90 days only.

除非另有說明，此報告結果僅對測試之樣品負責，同時此樣品僅保留 90 天。本報告未經本公司書面許可，不可部份複製。

This document is issued by the Company subject to its General Conditions of Service printed overleaf, available on request or accessible at [www.sgs.com/terms\\_and\\_conditions.htm](http://www.sgs.com/terms_and_conditions.htm) and, for electronic format documents, subject to Terms and Conditions for Electronic Documents at [www.sgs.com/terms\\_e-document.htm](http://www.sgs.com/terms_e-document.htm). Attention is drawn to the limitation of liability, indemnification and jurisdiction issues defined therein. Any holder of this document is advised that information contained hereon reflects the Company's findings at the time of its intervention only and within the limits of Client's instructions, if any. The Company's sole responsibility is to its Client and this document does not exonerate parties to a transaction from exercising all their rights and obligations under the transaction documents. This document cannot be reproduced except in full, without prior written approval of the Company. Any unauthorized alteration, forgery or falsification of the content or appearance of this document is unlawful and offenders may be prosecuted to the fullest extent of the law.

SGS Taiwan Ltd.No.134, Wu Kung Road, Wuku Industrial Zone, Taipei County, Taiwan /台北縣五股工業區五工路 134 號

台灣檢驗科技股份有限公司 t (886-2) 2299-3279 f (886-2) 2298-0488 www.tw.sgs.com

## Config 1:GSM1900

H

臺灣檢驗科技股份有限公司-電子暨通訊實驗室  
 Address:台北縣五股工業區五工路 134 號  
 Tel:02-2299-3279 Fax:02-2298-2698

### Radiated Emission Measurement

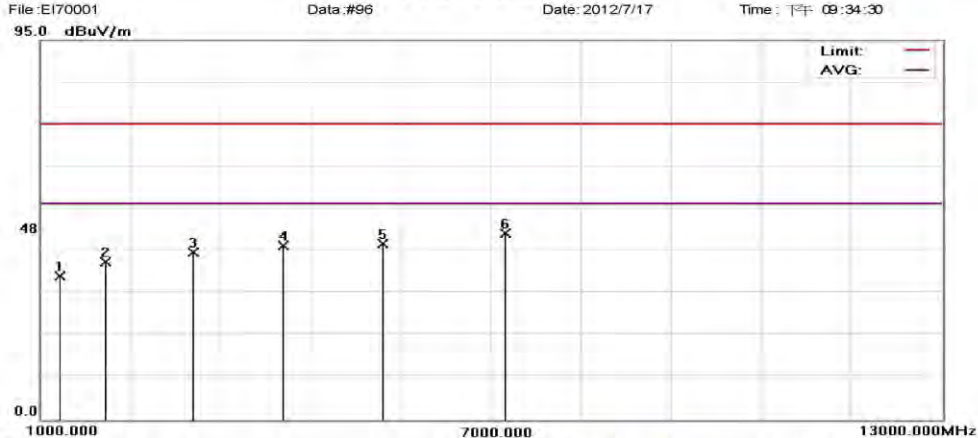

File:EI70001 Data:#96 Date:2012/7/17 Time:下午 09:34:30

Site :966-2 Chamber Polarization: **Horizontal** Temperature: 25 °C  
 Limit: FCC Class B 3M Radiation(1G-40G)(Pea Power: AC120V/60Hz Humidity: 60%  
 EUT: ARGON MINI Distance:  
 M/N: 8305/3345  
 Mode: Config 1:GSM 1900;10% Battery Capacity  
 Note:

No.	Mk.	Freq. MHz	Reading Level dBuV	Correct Factor dB	Measure- ment dBuV/m	Limit dBuV/m	Over dB	Detector	Comment
1		1264.000	38.83	-2.93	35.90	74.00	-38.10	peak	
2		1864.000	39.50	-0.02	39.48	74.00	-34.52	peak	
3		3040.000	38.49	3.41	41.90	74.00	-32.10	peak	
4		4240.000	38.10	5.40	43.50	74.00	-30.50	peak	
5		5560.000	36.44	7.55	43.99	74.00	-30.01	peak	
6	*	7192.000	37.35	9.40	46.75	74.00	-27.25	peak	

\*:Maximum data x:Over limit !:over margin ●ReferenceOnly

File:EI70001\Data:#96

Page: 1

Engineer Signature:

Printed with FinePrint - purchase at [www.fineprint.com](http://www.fineprint.com).

Unless otherwise stated the results shown in this test report refer only to the sample(s) tested and such sample(s) are retained for 90 days only.

除非另有說明，此報告結果僅對測試之樣品負責，同時此樣品僅保留 90 天。本報告未經本公司書面許可，不可部份複製。

This document is issued by the Company subject to its General Conditions of Service printed overleaf, available on request or accessible at [www.sgs.com/terms\\_and\\_conditions.htm](http://www.sgs.com/terms_and_conditions.htm) and, for electronic format documents, subject to Terms and Conditions for Electronic Documents at [www.sgs.com/terms\\_e-document.htm](http://www.sgs.com/terms_e-document.htm). Attention is drawn to the limitation of liability, indemnification and jurisdiction issues defined therein. Any holder of this document is advised that information contained hereon reflects the Company's findings at the time of its intervention only and within the limits of Client's instructions, if any. The Company's sole responsibility is to its Client and this document does not exonerate parties to a transaction from exercising all their rights and obligations under the transaction documents. This document cannot be reproduced except in full, without prior written approval of the Company. Any unauthorized alteration, forgery or falsification of the content or appearance of this document is unlawful and offenders may be prosecuted to the fullest extent of the law.

SGS Taiwan Ltd.No.134, Wu Kung Road, Wuku Industrial Zone, Taipei County, Taiwan /台北縣五股工業區五工路 134 號

台灣檢驗科技股份有限公司 t (886-2) 2299-3279 f (886-2) 2298-0488 [www.tw.sgs.com](http://www.tw.sgs.com)

V

臺灣檢驗科技股份有限公司 - 電子暨通訊實驗室  
 Address : 台北縣五股工業區五工路 134 號  
 Tel:02-2299-3279 Fax:02-2298-2698

**Radiated Emission Measurement**

File : EI70001 Data : #95 Date : 2012/7/17 Time : 下午 09:31:28

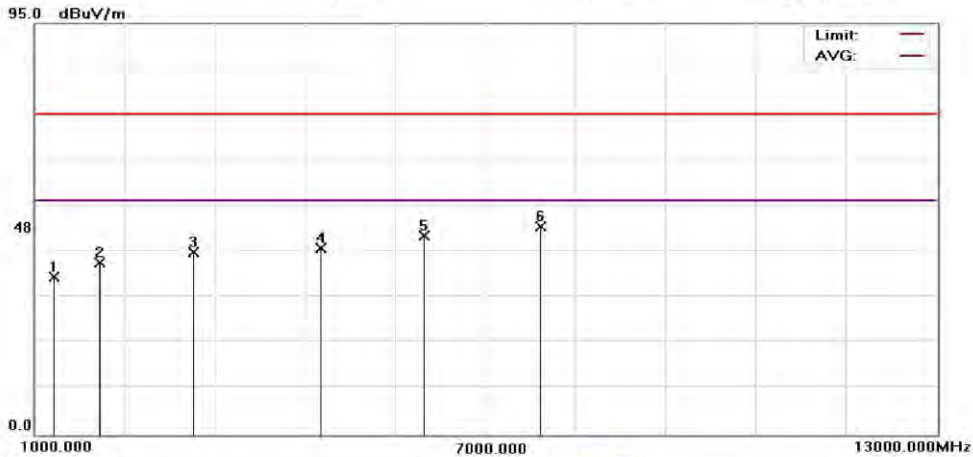

Site : 966-2 Chamber Polarization: **Vertical** Temperature: 25 °C  
 Limit: FCC Class B 3M Radiation(1G-40G)(Pea Power: AC 120V/60Hz Humidity: 60%  
 EUT: ARGON MINI Distance:  
 M/N: 8305/3345  
 Mode: Config 1:GSM 1900;10% Battery Capacity  
 Note:

No.	Mk.	Freq. MHz	Reading Level dBuV	Correct Factor dB	Measure- ment dBuV/m	Limit dBuV/m	Over dB	Detector	Comment
1		1264.000	39.49	-2.93	36.56	74.00	-37.44	peak	
2		1864.000	39.72	-0.02	39.70	74.00	-34.30	peak	
3		3112.000	38.52	3.53	42.05	74.00	-31.95	peak	
4		4816.000	36.63	6.53	43.16	74.00	-30.84	peak	
5		6184.000	37.32	8.70	46.02	74.00	-27.98	peak	
6	*	7744.000	38.13	9.97	48.10	74.00	-25.90	peak	

\*:Maximum data x:Over limit !:over margin

●ReferenceOnly

File : EI70001\Data : #95

Page: 1

Engineer Signature:

Printed with FilePrint - purchase at www.fileprint.com

Unless otherwise stated the results shown in this test report refer only to the sample(s) tested and such sample(s) are retained for 90 days only.

除非另有說明，此報告結果僅對測試之樣品負責，同時此樣品僅保留 90 天。本報告未經本公司書面許可，不可部份複製。

This document is issued by the Company subject to its General Conditions of Service printed overleaf, available on request or accessible at [www.sgs.com/terms\\_and\\_conditions.htm](http://www.sgs.com/terms_and_conditions.htm) and, for electronic format documents, subject to Terms and Conditions for Electronic Documents at [www.sgs.com/terms\\_e-document.htm](http://www.sgs.com/terms_e-document.htm). Attention is drawn to the limitation of liability, indemnification and jurisdiction issues defined therein. Any holder of this document is advised that information contained hereon reflects the Company's findings at the time of its intervention only and within the limits of Client's instructions, if any. The Company's sole responsibility is to its Client and this document does not exonerate parties to a transaction from exercising all their rights and obligations under the transaction documents. This document cannot be reproduced except in full, without prior written approval of the Company. Any unauthorized alteration, forgery or falsification of the content or appearance of this document is unlawful and offenders may be prosecuted to the fullest extent of the law.

SGS Taiwan Ltd. No.134, Wu Kung Road, Wuku Industrial Zone, Taipei County, Taiwan / 台北縣五股工業區五工路 134 號

台灣檢驗科技股份有限公司 t (886-2) 2299-3279 f (886-2) 2298-0488 www.tw.sgs.com

## Config 2:Data Link H

臺灣檢驗科技股份有限公司-電子暨通訊實驗室  
Address:台北縣五股工業區五工路 134 號  
Tel:02-2299-3279 Fax:02-2298-2698

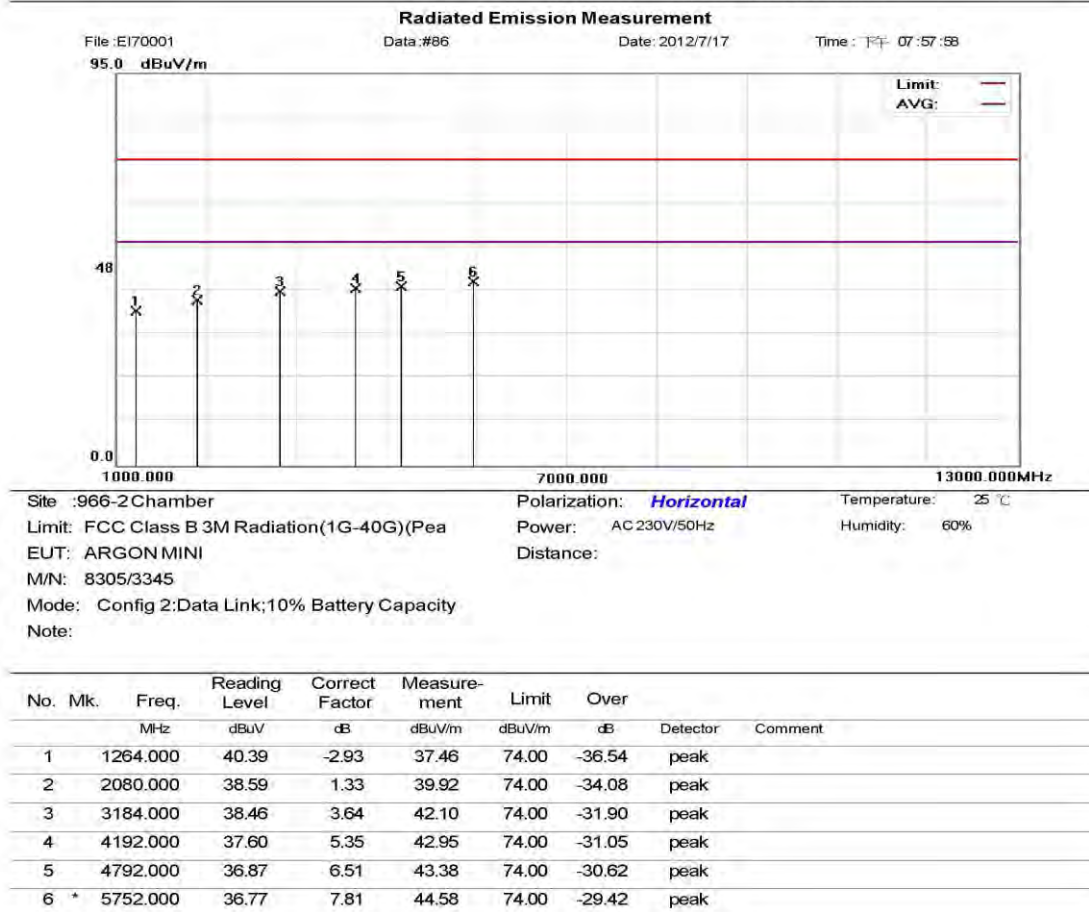

\*:Maximum data    x:Over limit    !:over margin

●ReferenceOnly

File:EI70001\Data:#86

Page: 1

Engineer Signature:

Printed with FilePrint - purchase at [www.fileprint.com](http://www.fileprint.com)

Unless otherwise stated the results shown in this test report refer only to the sample(s) tested and such sample(s) are retained for 90 days only.

除非另有說明，此報告結果僅對測試之樣品負責，同時此樣品僅保留 90 天。本報告未經本公司書面許可，不可部份複製。

This document is issued by the Company subject to its General Conditions of Service printed overleaf, available on request or accessible at [www.sgs.com/terms\\_and\\_conditions.htm](http://www.sgs.com/terms_and_conditions.htm) and, for electronic format documents, subject to Terms and Conditions for Electronic Documents at [www.sgs.com/terms\\_e-document.htm](http://www.sgs.com/terms_e-document.htm). Attention is drawn to the limitation of liability, indemnification and jurisdiction issues defined therein. Any holder of this document is advised that information contained hereon reflects the Company's findings at the time of its intervention only and within the limits of Client's instructions, if any. The Company's sole responsibility is to its Client and this document does not exonerate parties to a transaction from exercising all their rights and obligations under the transaction documents. This document cannot be reproduced except in full, without prior written approval of the Company. Any unauthorized alteration, forgery or falsification of the content or appearance of this document is unlawful and offenders may be prosecuted to the fullest extent of the law.

SGS Taiwan Ltd.No.134, Wu Kung Road, Wuku Industrial Zone, Taipei County, Taiwan /台北縣五股工業區五工路 134 號

台灣檢驗科技股份有限公司    t (886-2) 2299-3279    f (886-2) 2298-0488    www.tw.sgs.com

V

臺灣檢驗科技股份有限公司 - 電子暨通訊實驗室  
 Address : 台北縣五股工業區五工路 134 號  
 Tel:02-2299-3279 Fax:02-2298-2698

**Radiated Emission Measurement**

File : EI70001 Data : #85 Date : 2012/7/17 Time : 下午 07:54:55

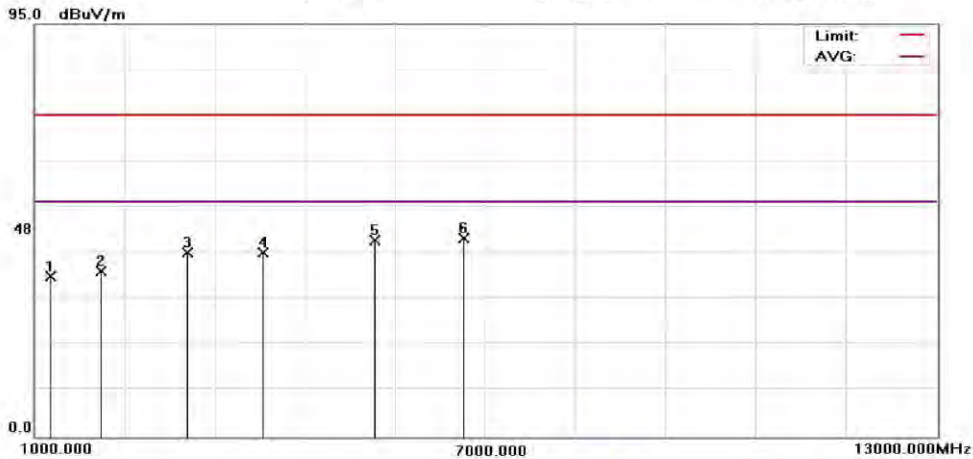

Site : 966-2 Chamber Polarization: **Vertical** Temperature: 25 °C  
 Limit: FCC Class B 3M Radiation(1G-40G)(Pea Power: AC230V/50Hz Humidity: 60%  
 EUT: ARGON MINI Distance:  
 M/N: 8305/3345  
 Mode: Config 2:Data Link;10% Battery Capacity  
 Note:

No.	Mk.	Freq. MHz	Reading Level dBuV	Correct Factor dB	Measure-ment dBuV/m	Limit dBuV/m	Over dB	Detector	Comment
1		1216.000	40.10	-3.11	36.99	74.00	-37.01	peak	
2		1888.000	38.05	0.17	38.22	74.00	-35.78	peak	
3		3040.000	38.94	3.41	42.35	74.00	-31.65	peak	
4		4048.000	37.32	5.17	42.49	74.00	-31.51	peak	
5		5536.000	37.72	7.52	45.24	74.00	-28.76	peak	
6	*	6712.000	36.71	9.08	45.79	74.00	-28.21	peak	

\*:Maximum data x:Over limit !:over margin

●ReferenceOnly

File : EI70001\Data : #85

Page : 1

Engineer Signature:

Printed with FinePrint - purchase at: www.fineprint.com

Unless otherwise stated the results shown in this test report refer only to the sample(s) tested and such sample(s) are retained for 90 days only.

除非另有說明，此報告結果僅對測試之樣品負責，同時此樣品僅保留 90 天。本報告未經本公司書面許可，不可部份複製。

This document is issued by the Company subject to its General Conditions of Service printed overleaf, available on request or accessible at [www.sgs.com/terms\\_and\\_conditions.htm](http://www.sgs.com/terms_and_conditions.htm) and, for electronic format documents, subject to Terms and Conditions for Electronic Documents at [www.sgs.com/terms\\_e-document.htm](http://www.sgs.com/terms_e-document.htm). Attention is drawn to the limitation of liability, indemnification and jurisdiction issues defined therein. Any holder of this document is advised that information contained hereon reflects the Company's findings at the time of its intervention only and within the limits of Client's instructions, if any. The Company's sole responsibility is to its Client and this document does not exonerate parties to a transaction from exercising all their rights and obligations under the transaction documents. This document cannot be reproduced except in full, without prior written approval of the Company. Any unauthorized alteration, forgery or falsification of the content or appearance of this document is unlawful and offenders may be prosecuted to the fullest extent of the law.

SGS Taiwan Ltd.No.134, Wu Kung Road, Wuku Industrial Zone, Taipei County, Taiwan /台北縣五股工業區五工路 134 號

台灣檢驗科技股份有限公司 t (886-2) 2299-3279 f (886-2) 2298-0488 www.tw.sgs.com

Config 3: Recording  
H

臺灣檢驗科技股份有限公司-電子暨通訊實驗室  
Address: 台北縣五股工業區五工路 134 號  
Tel: 02-2299-3279 Fax: 02-2298-2698

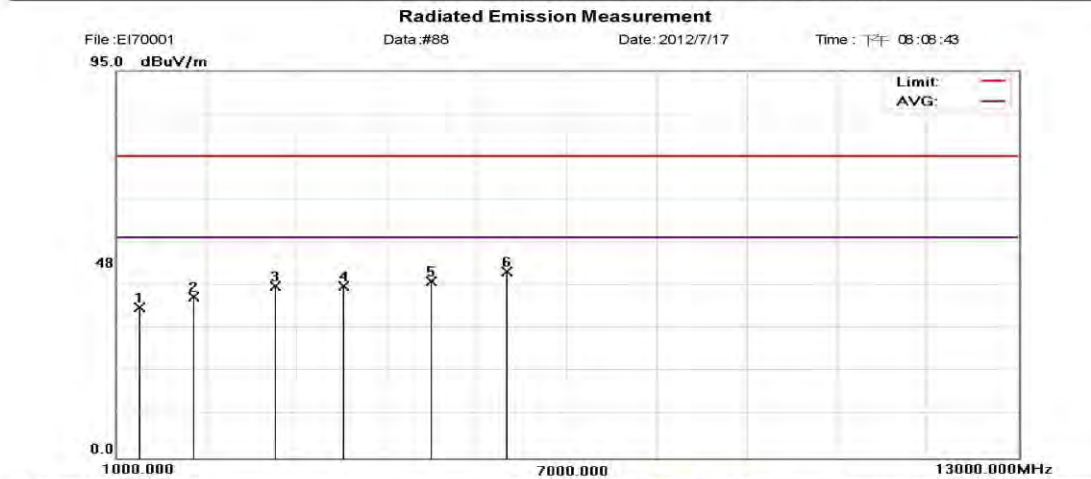

File: EI70001 Data: #88 Date: 2012/7/17 Time: 下午 08:08:43  
Site: 966-2 Chamber Polarization: **Horizontal** Temperature: 25 °C  
Limit: FCC Class B 3M Radiation(1G-40G)(Pea Power: AC230V/50Hz Humidity: 60%  
EUT: ARGON MINI Distance:  
MN: 8305/3345  
Mode: Config 3:Recording;10% Battery Capacity  
Note:

No.	Mk.	Freq. MHz	Reading Level dBuV	Correct Factor dB	Measure- ment dBuV/m	Limit dBuV/m	Over dB	Detector	Comment
1		1312.000	39.83	-2.84	36.99	74.00	-37.01	peak	
2		2032.000	38.24	1.20	39.44	74.00	-34.56	peak	
3		3112.000	38.74	3.53	42.27	74.00	-31.73	peak	
4		4024.000	36.91	5.15	42.06	74.00	-31.94	peak	
5		5200.000	36.38	7.03	43.41	74.00	-30.59	peak	
6	*	6208.000	36.96	8.73	45.69	74.00	-28.31	peak	

\*:Maximum data x:Over limit !:over margin ●ReferenceOnly

File: EI70001\Data: #88

Page: 1

Engineer Signature:

Printed with FinePrint - purchase at www.fineprint.com

Unless otherwise stated the results shown in this test report refer only to the sample(s) tested and such sample(s) are retained for 90 days only.

除非另有說明，此報告結果僅對測試之樣品負責，同時此樣品僅保留 90 天。本報告未經本公司書面許可，不可部份複製。

This document is issued by the Company subject to its General Conditions of Service printed overleaf, available on request or accessible at [www.sgs.com/terms\\_and\\_conditions.htm](http://www.sgs.com/terms_and_conditions.htm) and, for electronic format documents, subject to Terms and Conditions for Electronic Documents at [www.sgs.com/terms\\_e-document.htm](http://www.sgs.com/terms_e-document.htm). Attention is drawn to the limitation of liability, indemnification and jurisdiction issues defined therein. Any holder of this document is advised that information contained hereon reflects the Company's findings at the time of its intervention only and within the limits of Client's instructions, if any. The Company's sole responsibility is to its Client and this document does not exonerate parties to a transaction from exercising all their rights and obligations under the transaction documents. This document cannot be reproduced except in full, without prior written approval of the Company. Any unauthorized alteration, forgery or falsification of the content or appearance of this document is unlawful and offenders may be prosecuted to the fullest extent of the law.

SGS Taiwan Ltd. No.134, Wu Kung Road, Wuku Industrial Zone, Taipei County, Taiwan / 台北縣五股工業區五工路 134 號

台灣檢驗科技股份有限公司 t (886-2) 2299-3279 f (886-2) 2298-0488 www.tw.sgs.com

V

臺灣檢驗科技股份有限公司 - 電子電訊實驗室  
 Address : 台北縣五股工業區五工路 134 號  
 Tel:02-2299-3279 Fax:02-2298-2698

**Radiated Emission Measurement**

File: EI70001 Data: #87 Date: 2012/7/17 Time: 下午 08:06:41

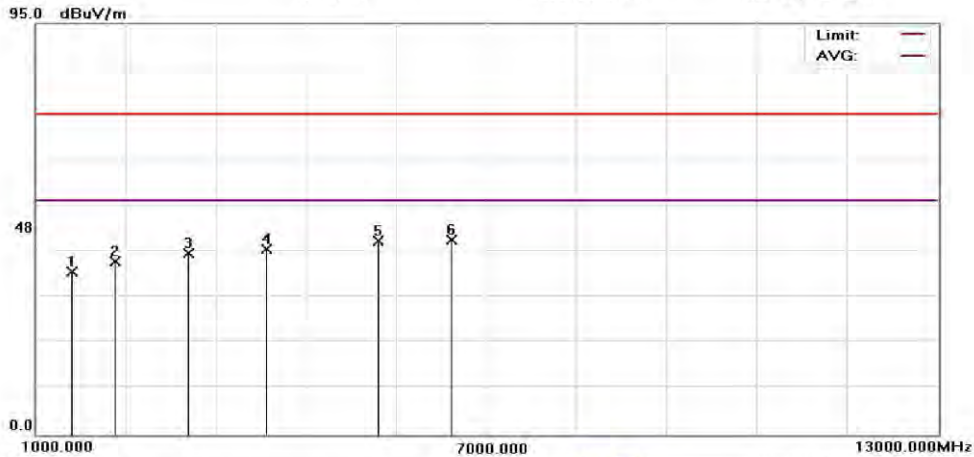

Site :966-2 Chamber Polarization: **Vertical** Temperature: 25 °C  
 Limit: FCC Class B 3M Radiation(1G-40G)(Pea Power: AC230V/50Hz Humidity: 60%  
 EUT: ARGON MINI Distance:  
 M/N: 8305/3345  
 Mode: Config 3:Recording:10% Battery Capacity  
 Note:

No.	Mk.	Freq. MHz	Reading Level dBuV	Correct Factor dB	Measure- ment dBuV/m	Limit dBuV/m	Over dB	Detector	Comment
1		1480.000	40.20	-2.54	37.66	74.00	-36.34	peak	
2		2056.000	38.64	1.27	39.91	74.00	-34.09	peak	
3		3040.000	38.62	3.41	42.03	74.00	-31.97	peak	
4		4072.000	37.68	5.21	42.89	74.00	-31.11	peak	
5		5560.000	37.22	7.55	44.77	74.00	-29.23	peak	
6	*	6544.000	36.06	8.97	45.03	74.00	-28.97	peak	

\*:Maximum data x:Over limit !:over margin

●ReferenceOnly

File:EI70001\Data:#87

Page: 1

Engineer Signature:

Printed with FilePrint - purchase at [www.fileprint.com](http://www.fileprint.com)

Unless otherwise stated the results shown in this test report refer only to the sample(s) tested and such sample(s) are retained for 90 days only.

除非另有說明，此報告結果僅對測試之樣品負責，同時此樣品僅保留 90 天。本報告未經本公司書面許可，不可部份複製。

This document is issued by the Company subject to its General Conditions of Service printed overleaf, available on request or accessible at [www.sgs.com/terms\\_and\\_conditions.htm](http://www.sgs.com/terms_and_conditions.htm) and, for electronic format documents, subject to Terms and Conditions for Electronic Documents at [www.sgs.com/terms\\_e-document.htm](http://www.sgs.com/terms_e-document.htm). Attention is drawn to the limitation of liability, indemnification and jurisdiction issues defined therein. Any holder of this document is advised that information contained hereon reflects the Company's findings at the time of its intervention only and within the limits of Client's instructions, if any. The Company's sole responsibility is to its Client and this document does not exonerate parties to a transaction from exercising all their rights and obligations under the transaction documents. This document cannot be reproduced except in full, without prior written approval of the Company. Any unauthorized alteration, forgery or falsification of the content or appearance of this document is unlawful and offenders may be prosecuted to the fullest extent of the law.

SGS Taiwan Ltd.No.134, Wu Kung Road, Wuku Industrial Zone, Taipei County, Taiwan /台北縣五股工業區五工路 134 號

台灣檢驗科技股份有限公司 t (886-2) 2299-3279 f (886-2) 2298-0488 [www.tw.sgs.com](http://www.tw.sgs.com)

## Config 3:Play Recording H

臺灣檢驗科技股份有限公司-電子暨通訊實驗室  
Address:台北縣五股工業區五工路 134 號  
Tel:02-2299-3279 Fax:02-2298-2698

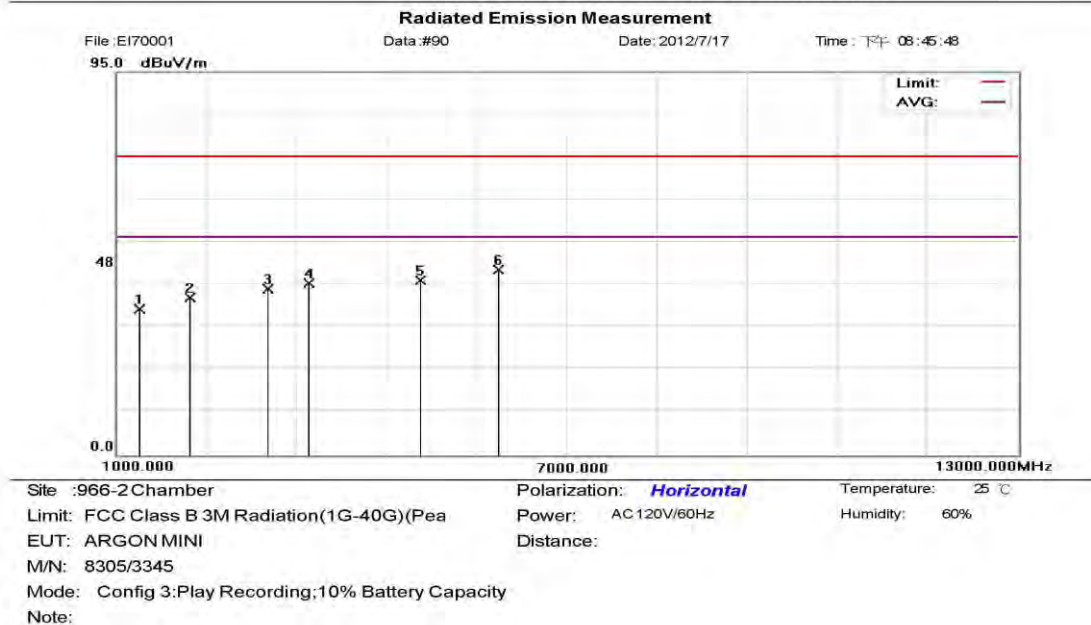

No.	Mk.	Freq. MHz	Reading Level dBuV	Correct Factor dB	Measurement dBuV/m	Limit dBuV/m	Over dB	Detector	Comment
1		1312.000	39.00	-2.84	36.16	74.00	-37.84	peak	
2		1984.000	38.01	0.98	38.99	74.00	-35.01	peak	
3		3016.000	37.91	3.38	41.29	74.00	-32.71	peak	
4		3568.000	38.17	4.38	42.55	74.00	-31.45	peak	
5		5056.000	36.48	6.81	43.29	74.00	-30.71	peak	
6	*	6088.000	37.33	8.56	45.89	74.00	-28.11	peak	

\*:Maximum data    x:Over limit    !:over margin      ●ReferenceOnly

File:EI70001\Data:#90

Page: 1

Engineer Signature:

Printed with FilePrint - purchase at [www.fileprint.com](http://www.fileprint.com)

Unless otherwise stated the results shown in this test report refer only to the sample(s) tested and such sample(s) are retained for 90 days only.

除非另有說明，此報告結果僅對測試之樣品負責，同時此樣品僅保留 90 天。本報告未經本公司書面許可，不可部份複製。

This document is issued by the Company subject to its General Conditions of Service printed overleaf, available on request or accessible at [www.sgs.com/terms\\_and\\_conditions.htm](http://www.sgs.com/terms_and_conditions.htm) and, for electronic format documents, subject to Terms and Conditions for Electronic Documents at [www.sgs.com/terms\\_e-document.htm](http://www.sgs.com/terms_e-document.htm). Attention is drawn to the limitation of liability, indemnification and jurisdiction issues defined therein. Any holder of this document is advised that information contained hereon reflects the Company's findings at the time of its intervention only and within the limits of Client's instructions, if any. The Company's sole responsibility is to its Client and this document does not exonerate parties to a transaction from exercising all their rights and obligations under the transaction documents. This document cannot be reproduced except in full, without prior written approval of the Company. Any unauthorized alteration, forgery or falsification of the content or appearance of this document is unlawful and offenders may be prosecuted to the fullest extent of the law.

SGS Taiwan Ltd.No.134, Wu Kung Road, Wuku Industrial Zone, Taipei County, Taiwan /台北縣五股工業區五工路 134 號

台灣檢驗科技股份有限公司    t (886-2) 2299-3279    f (886-2) 2298-0488    www.tw.sgs.com

V

臺灣檢驗科技股份有限公司 - 電子暨通訊實驗室  
 Address : 台北縣五股工業區五工路 134 號  
 Tel:02-2299-3279 Fax:02-2298-2698

**Radiated Emission Measurement**

File:EI70001 Data:#89 Date:2012/7/17 Time:下午 08:42:46

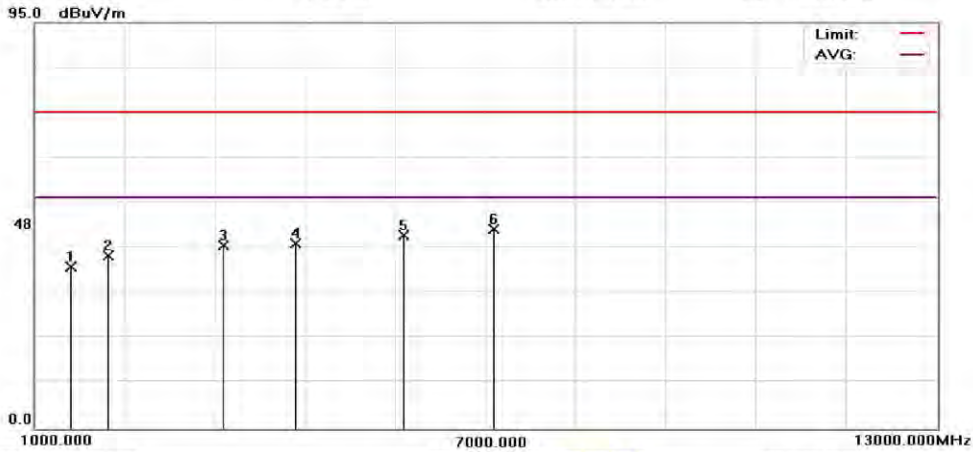

Site :966-2 Chamber Polarization: **Vertical** Temperature: 25 °C  
 Limit: FCC Class B 3M Radiation(1G-40G)(Pea Power: AC 120V/60Hz Humidity: 60%  
 EUT: ARGON MINI Distance:  
 M/N: 8305/3345  
 Mode: Config 3:Play Recording;10% Battery Capacity  
 Note:

No.	Mk.	Freq. MHz	Reading Level dBuV	Correct Factor dB	Measure- ment dBuV/m	Limit dBuV/m	Over dB	Detector	Comment
1		1480.000	40.51	-2.54	37.97	74.00	-36.03	peak	
2		1984.000	39.40	0.98	40.38	74.00	-33.62	peak	
3		3520.000	38.53	4.27	42.80	74.00	-31.20	peak	
4		4480.000	37.50	5.95	43.45	74.00	-30.55	peak	
5		5920.000	37.09	8.23	45.32	74.00	-28.68	peak	
6	*	7120.000	37.21	9.38	46.59	74.00	-27.41	peak	

\*:Maximum data x:Over limit !:over margin

●ReferenceOnly

File:EI70001\Data:#89

Page: 1

Engineer Signature:

Printed with FinePrint - purchase at www.fineprint.com

Unless otherwise stated the results shown in this test report refer only to the sample(s) tested and such sample(s) are retained for 90 days only.

除非另有說明，此報告結果僅對測試之樣品負責，同時此樣品僅保留 90 天。本報告未經本公司書面許可，不可部份複製。

This document is issued by the Company subject to its General Conditions of Service printed overleaf, available on request or accessible at [www.sgs.com/terms\\_and\\_conditions.htm](http://www.sgs.com/terms_and_conditions.htm) and, for electronic format documents, subject to Terms and Conditions for Electronic Documents at [www.sgs.com/terms\\_e-document.htm](http://www.sgs.com/terms_e-document.htm). Attention is drawn to the limitation of liability, indemnification and jurisdiction issues defined therein. Any holder of this document is advised that information contained hereon reflects the Company's findings at the time of its intervention only and within the limits of Client's instructions, if any. The Company's sole responsibility is to its Client and this document does not exonerate parties to a transaction from exercising all their rights and obligations under the transaction documents. This document cannot be reproduced except in full, without prior written approval of the Company. Any unauthorized alteration, forgery or falsification of the content or appearance of this document is unlawful and offenders may be prosecuted to the fullest extent of the law.

SGS Taiwan Ltd.No.134, Wu Kung Road, Wuku Industrial Zone, Taipei County, Taiwan /台北縣五股工業區五工路 134 號

台灣檢驗科技股份有限公司 t (886-2) 2299-3279 f (886-2) 2298-0488 www.tw.sgs.com

Config 3:MP3

H

臺灣檢驗科技股份有限公司 - 電子暨通訊實驗室  
 Address : 台北縣五股工業區五工路 134 號  
 Tel:02-2299-3279 Fax:02-2298-2698

**Radiated Emission Measurement**

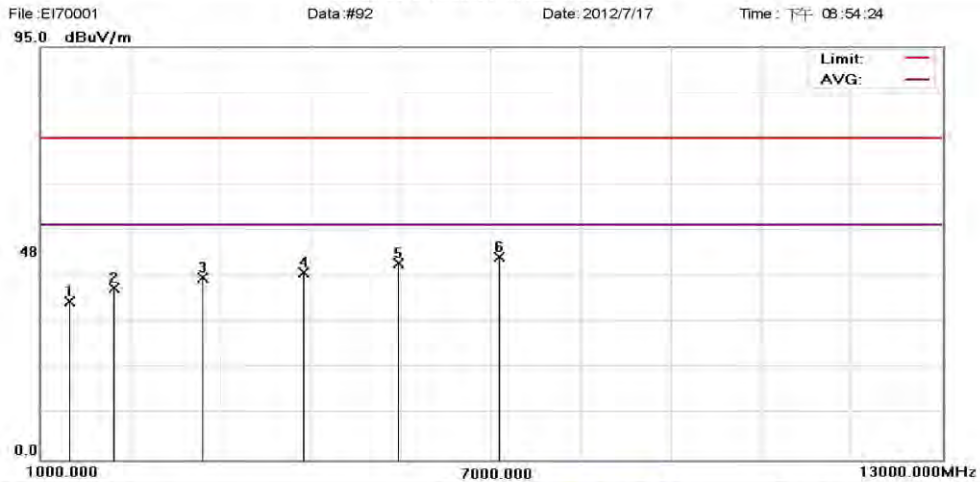

File : EI70001 Data : #92 Date : 2012/7/17 Time : 下午 08:54:24  
 Site : 966-2 Chamber Polarization: **Horizontal** Temperature: 25 °C  
 Limit: FCC Class B 3M Radiation(1G-40G)(Pea Power: AC 120V/60Hz Humidity: 60%  
 EUT: ARGON MINI Distance:  
 M/N: 8305/3345  
 Mode: Config 3:MP3;10% Battery Capacity  
 Note:

No.	Mk.	Freq. MHz	Reading Level dBuV	Correct Factor dB	Measure- ment dBuV/m	Limit dBuV/m	Over dB	Detector	Comment
1		1384.000	39.05	-2.71	36.34	74.00	-37.66	peak	
2		1984.000	38.64	0.98	39.62	74.00	-34.38	peak	
3		3160.000	38.26	3.60	41.86	74.00	-32.14	peak	
4		4504.000	37.05	6.00	43.05	74.00	-30.95	peak	
5		5776.000	37.42	7.87	45.29	74.00	-28.71	peak	
6	*	7120.000	37.30	9.38	46.68	74.00	-27.32	peak	

\*:Maximum data x:Over limit !:over margin

●ReferenceOnly

File : EI70001 \ Data : #92

Page : 1

Engineer Signature:

Printed with FinePrint - purchase at www.fineprint.com

Unless otherwise stated the results shown in this test report refer only to the sample(s) tested and such sample(s) are retained for 90 days only.

除非另有說明，此報告結果僅對測試之樣品負責，同時此樣品僅保留 90 天。本報告未經本公司書面許可，不可部份複製。

This document is issued by the Company subject to its General Conditions of Service printed overleaf, available on request or accessible at [www.sgs.com/terms\\_and\\_conditions.htm](http://www.sgs.com/terms_and_conditions.htm) and, for electronic format documents, subject to Terms and Conditions for Electronic Documents at [www.sgs.com/terms\\_e-document.htm](http://www.sgs.com/terms_e-document.htm). Attention is drawn to the limitation of liability, indemnification and jurisdiction issues defined therein. Any holder of this document is advised that information contained hereon reflects the Company's findings at the time of its intervention only and within the limits of Client's instructions, if any. The Company's sole responsibility is to its Client and this document does not exonerate parties to a transaction from exercising all their rights and obligations under the transaction documents. This document cannot be reproduced except in full, without prior written approval of the Company. Any unauthorized alteration, forgery or falsification of the content or appearance of this document is unlawful and offenders may be prosecuted to the fullest extent of the law.

SGS Taiwan Ltd. No.134, Wu Kung Road, Wuku Industrial Zone, Taipei County, Taiwan / 台北縣五股工業區五工路 134 號

台灣檢驗科技股份有限公司 t (886-2) 2299-3279 f (886-2) 2298-0488 www.tw.sgs.com

V

臺灣檢驗科技股份有限公司-電子暨通訊實驗室  
 Address: 台北縣五股工業區五工路 134 號  
 Tel: 02-2299-3279 Fax: 02-2298-2698

**Radiated Emission Measurement**

File: EI70001 Data: #91 Date: 2012/7/17 Time: 下午 08:51:22

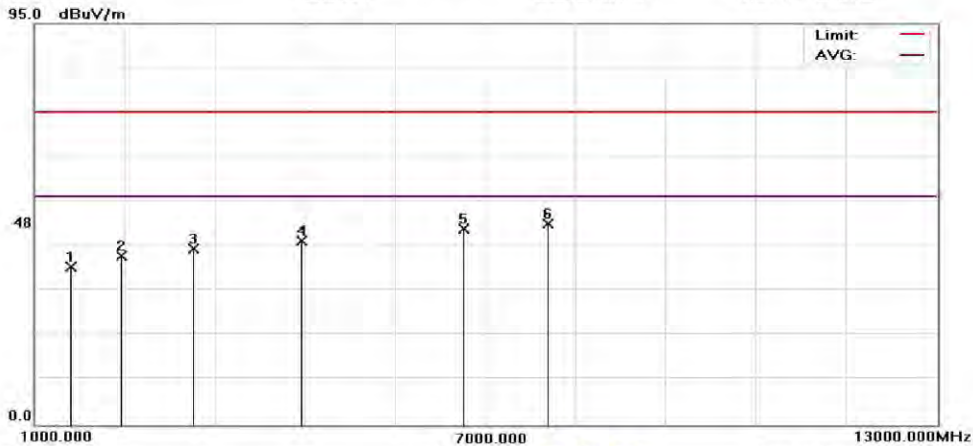

Site : 966-2 Chamber Polarization: **Vertical** Temperature: 25 °C  
 Limit: FCC Class B 3M Radiation(1G-40G)(Pea Power: AC 120V/60Hz Humidity: 60%  
 EUT: ARGON MINI Distance:  
 M/N: 8305/3345  
 Mode: Config 3:MP3;10% Battery Capacity  
 Note:

No.	Mk.	Freq. MHz	Reading Level dBuV	Correct Factor dB	Measure- ment dBuV/m	Limit dBuV/m	Over dB	Detector	Comment
1		1480.000	39.86	-2.54	37.32	74.00	-36.68	peak	
2		2152.000	38.61	1.51	40.12	74.00	-33.88	peak	
3		3112.000	38.24	3.53	41.77	74.00	-32.23	peak	
4		4552.000	37.44	6.10	43.54	74.00	-30.46	peak	
5		6712.000	37.31	9.08	46.39	74.00	-27.61	peak	
6	*	7840.000	37.57	10.09	47.66	74.00	-26.34	peak	

\*:Maximum data x:Over limit !:over margin ●ReferenceOnly

File: EI70001\Data: #91

Page: 1

Engineer Signature:

Printed with FinePrint - purchase at www.fineprint.com

**\*\* End of Report \*\***

Unless otherwise stated the results shown in this test report refer only to the sample(s) tested and such sample(s) are retained for 90 days only.

除非另有說明，此報告結果僅對測試之樣品負責，同時此樣品僅保留 90 天。本報告未經本公司書面許可，不可部份複製。

This document is issued by the Company subject to its General Conditions of Service printed overleaf, available on request or accessible at [www.sgs.com/terms\\_and\\_conditions.htm](http://www.sgs.com/terms_and_conditions.htm) and, for electronic format documents, subject to Terms and Conditions for Electronic Documents at [www.sgs.com/terms\\_e-document.htm](http://www.sgs.com/terms_e-document.htm). Attention is drawn to the limitation of liability, indemnification and jurisdiction issues defined therein. Any holder of this document is advised that information contained hereon reflects the Company's findings at the time of its intervention only and within the limits of Client's instructions, if any. The Company's sole responsibility is to its Client and this document does not exonerate parties to a transaction from exercising all their rights and obligations under the transaction documents. This document cannot be reproduced except in full, without prior written approval of the Company. Any unauthorized alteration, forgery or falsification of the content or appearance of this document is unlawful and offenders may be prosecuted to the fullest extent of the law.

SGS Taiwan Ltd.No.134, Wu Kung Road, Wuku Industrial Zone, Taipei County, Taiwan /台北縣五股工業區五工路 134 號

台灣檢驗科技股份有限公司 t (886-2) 2299-3279 f (886-2) 2298-0488 www.tw.sgs.com