

## APPENDIX

### 10. Photographs of Test Setup

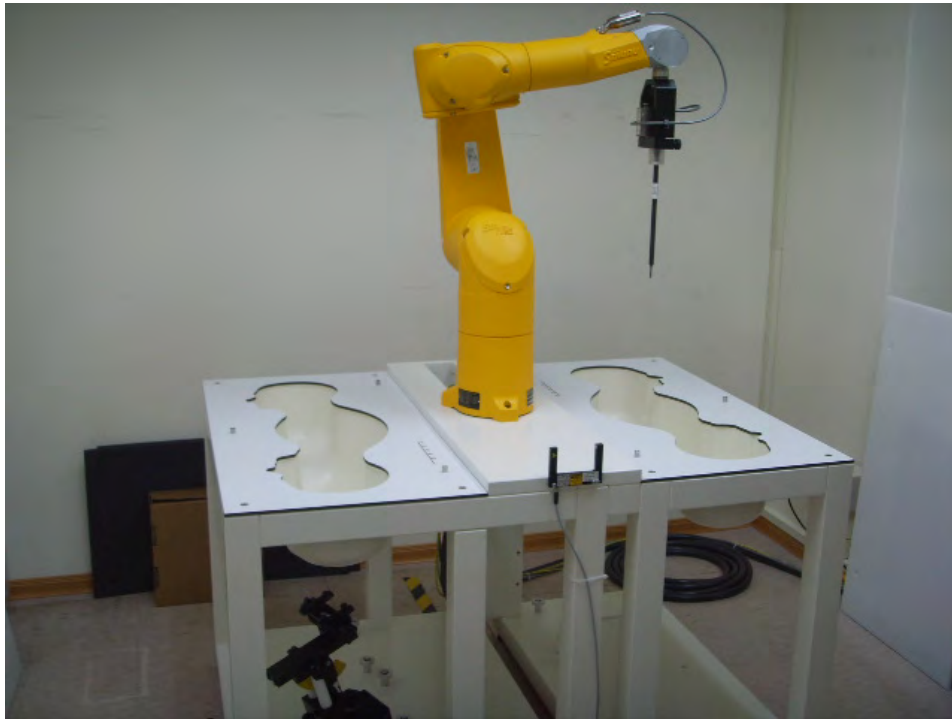
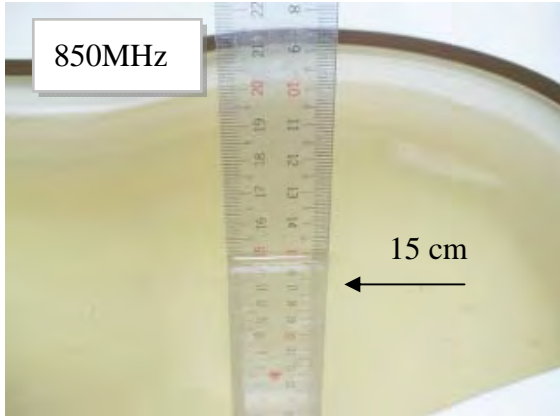

Fig.1 Photograph of the SAR measurement System

This document is issued by the Company subject to its General Conditions of Service printed overleaf or available on request and accessible at [www.sgs.com](http://www.sgs.com). Attention is drawn to the limitations of liability, indemnification, and Jurisdictional issued defined therein. Unless otherwise stated, the results shown in this test report refer only to the sample(s) tested. This document cannot be reproduced except in full, without prior approval of Company. Any unauthorized alteration, forgery or falsification of the content or appearance of this report is unlawful and offenders may be prosecuted to the fullest extent of the law. 此報告是遵循本公司訂定之通用服務條款所製作發放，請注意此條款列印於背面，亦可在[www.sgs.com](http://www.sgs.com)中查閱。將本公司之義務，免責，管轄權皆明確規範之。除非另有說明，此報告結果僅對檢驗之樣品負責。本報告未經本公司書面許可，不可部份複製。對本報告內容或外觀之任何未經授權之變更、偽造、竄改皆屬非法，違犯者將會被依法追訴。

**Photograph of the Tissue Simulant Fluid liquid depth 15cm**



**Fig.2.1 Left-head Side**

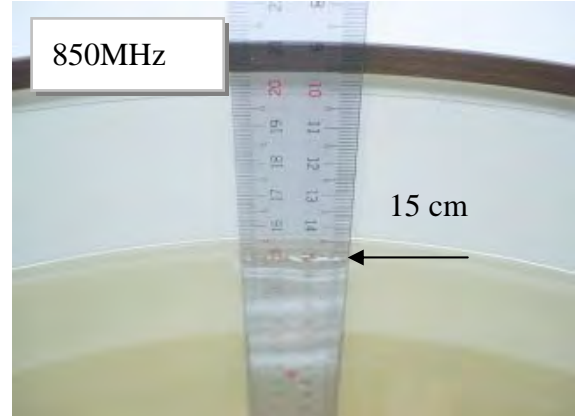

**Fig.2.2 Flat (Body)**

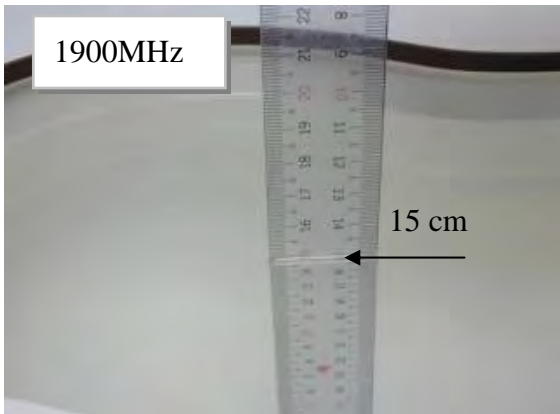

**Fig.2.3 Flat (Body)**

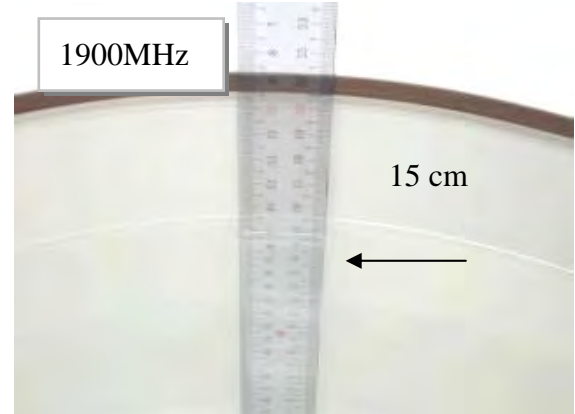

**Fig.2.4 Flat (Body)**

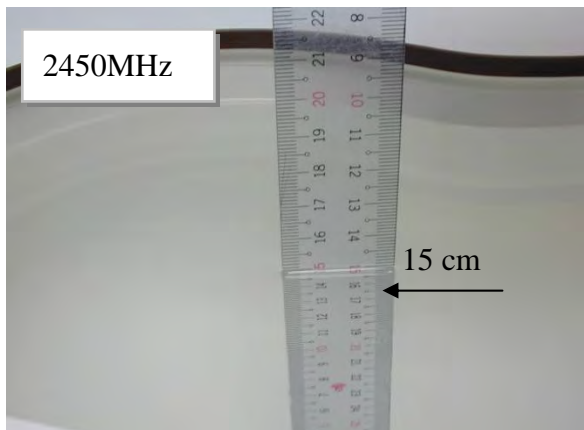

**Fig.2.5 Right-head Side**

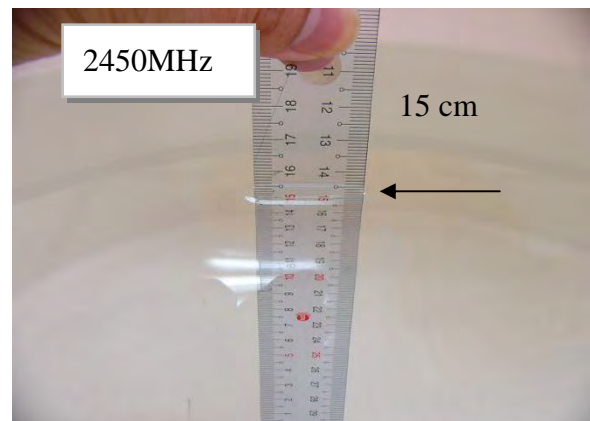

**Fig.2.6 Flat (Body)**

This document is issued by the Company subject to its General Conditions of Service printed overleaf or available on request and accessible at [www.sgs.com](http://www.sgs.com). Attention is drawn to the limitations of liability, indemnification, and Jurisdictional issued defined therein. Unless otherwise stated, the results shown in this test report refer only to the sample(s) tested. This document cannot be reproduced except in full, without prior approval of Company. Any unauthorized alteration, forgery or falsification of the content or appearance of this report is unlawful and offenders may be prosecuted to the fullest extent of the law. 此報告是遵循本公司訂定之通用服務條款所製作發放，請注意此條款列印於背面，亦可在[www.sgs.com](http://www.sgs.com)中查閱。將本公司之義務，免責，管轄權皆明確規範之。除非另有說明，此報告結果僅對檢驗之樣品負責。本報告未經本公司書面許可，不可部份複製。對本報告內容或外觀之任何未經授權之變更、偽造、竄改皆屬非法，違犯者將會被依法追訴。

### Head Mode

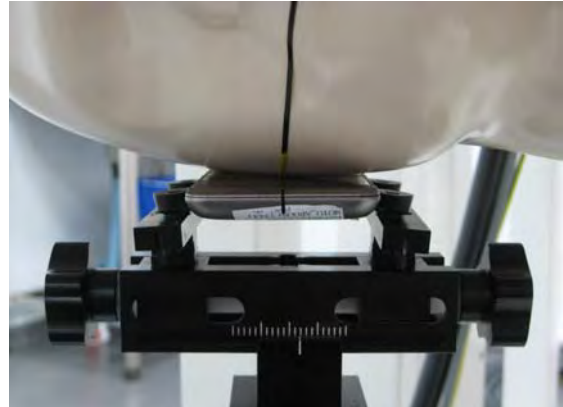
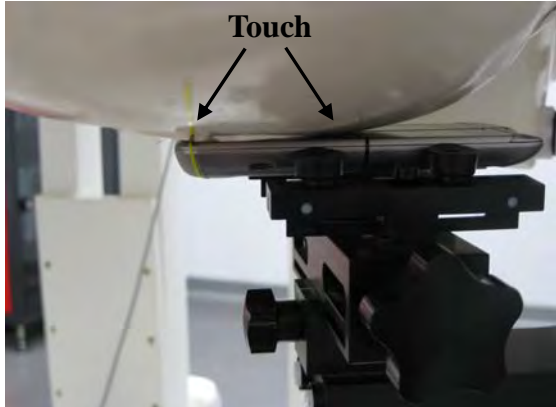

Fig.3 Right Head Section / Cheek-Touch Position

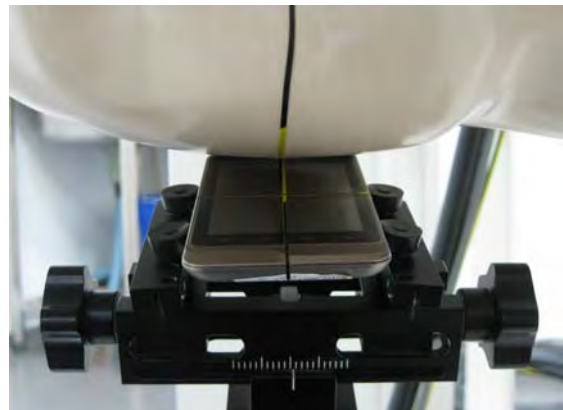
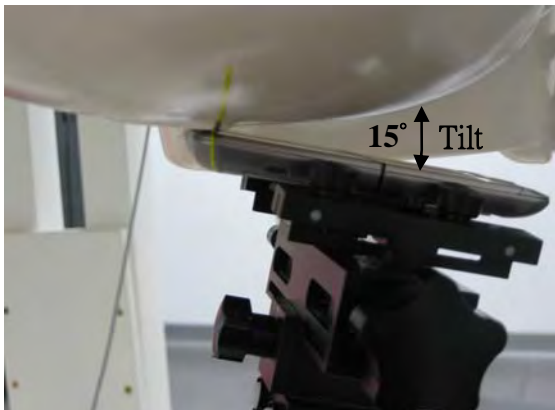

Fig.4 Right Head Section / Ear-Tilt Position(15°)

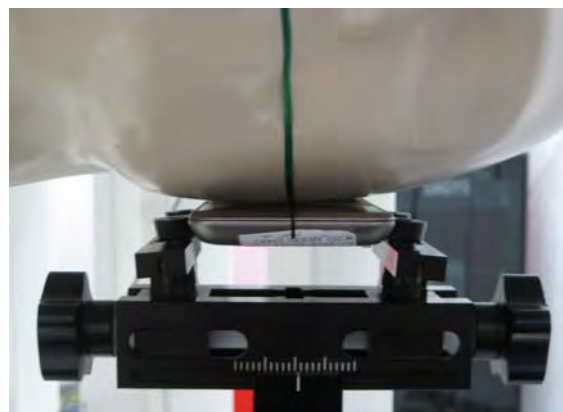
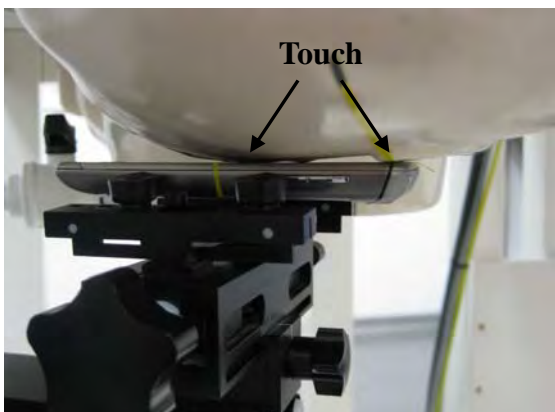

Fig.5 Left Head Section / Cheek-Touch Position

This document is issued by the Company subject to its General Conditions of Service printed overleaf or available on request and accessible at [www.sgs.com](http://www.sgs.com). Attention is drawn to the limitations of liability, indemnification, and Jurisdictional issued defined therein. Unless otherwise stated, the results shown in this test report refer only to the sample(s) tested. This document cannot be reproduced except in full, without prior approval of Company. Any unauthorized alteration, forgery or falsification of the content or appearance of this report is unlawful and offenders may be prosecuted to the fullest extent of the law. 此報告是遵循本公司訂定之通用服務條款所製作發放，請注意此條款列印於背面，亦可在[www.sgs.com](http://www.sgs.com)中查閱。將本公司之義務，免責，管轄權皆明確規範之。除非另有說明，此報告結果僅對檢驗之樣品負責。本報告未經本公司書面許可，不可部份複製。對本報告內容或外觀之任何未經授權之變更、偽造、竄改皆屬非法，違犯者將會被依法追訴。

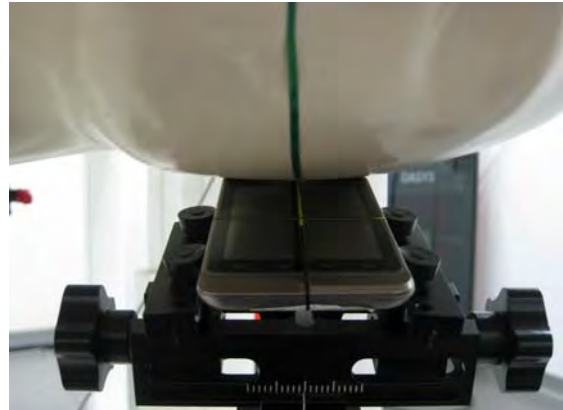
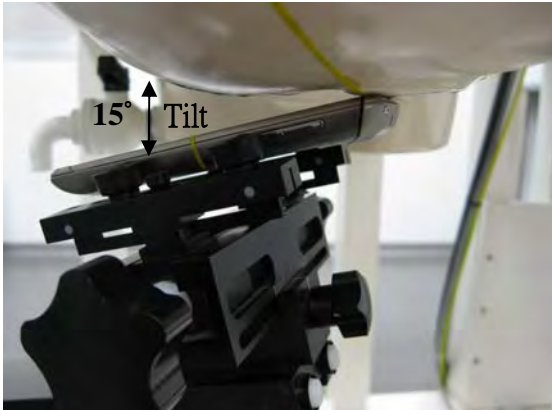

Fig.6 Left Head Section / Ear-Tilt Position(15°)

This document is issued by the Company subject to its General Conditions of Service printed overleaf or available on request and accessible at [www.sgs.com](http://www.sgs.com). Attention is drawn to the limitations of liability, indemnification, and Jurisdictional issued defined therein. Unless otherwise stated, the results shown in this test report refer only to the sample(s) tested. This document cannot be reproduced except in full, without prior approval of Company. Any unauthorized alteration, forgery or falsification of the content or appearance of this report is unlawful and offenders may be prosecuted to the fullest extent of the law. 此報告是遵循本公司訂定之通用服務條款所製作發放，請注意此條款列印於背面，亦可在[www.sgs.com](http://www.sgs.com)中查閱。將本公司之義務，免責，管轄權皆明確規範之。除非另有說明，此報告結果僅對檢驗之樣品負責。本報告未經本公司書面許可，不可部份複製。對本報告內容或外觀之任何未經授權之變更、偽造、竄改皆屬非法，違犯者將會被依法追訴。

**Hotspotmode - distance between flat phantom and mobile phone is 1 cm**



**Fig.7 EUT front to flat phantom**

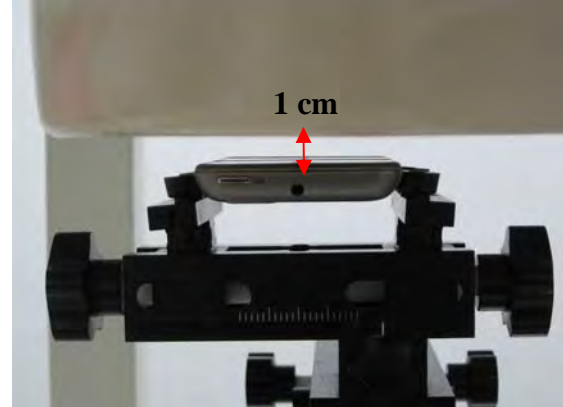

**Fig.8 EUT back to flat phantom**

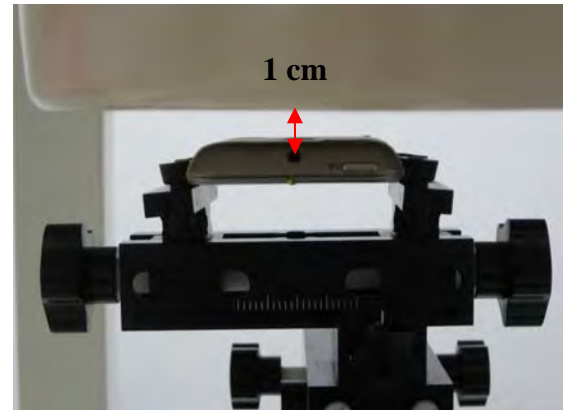

**Fig.9 EUT back side with Headset to flat phantom**

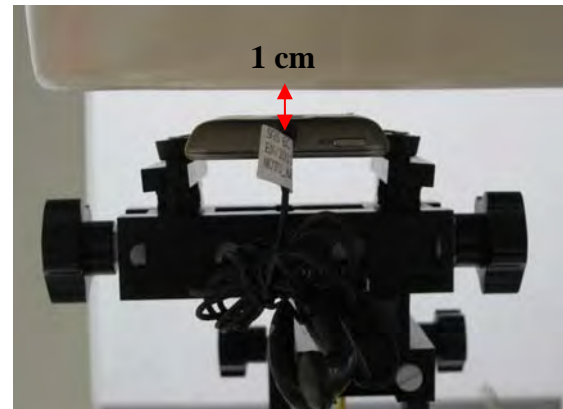

This document is issued by the Company subject to its General Conditions of Service printed overleaf or available on request and accessible at [www.sgs.com](http://www.sgs.com). Attention is drawn to the limitations of liability, indemnification, and Jurisdictional issued defined therein. Unless otherwise stated, the results shown in this test report refer only to the sample(s) tested. This document cannot be reproduced except in full, without prior approval of Company. Any unauthorized alteration, forgery or falsification of the content or appearance of this report is unlawful and offenders may be prosecuted to the fullest extent of the law. 此報告是遵循本公司訂定之通用服務條款所製作發放，請注意此條款列印於背面，亦可在[www.sgs.com](http://www.sgs.com)中查閱。將本公司之義務，免責，管轄權皆明確規範之。除非另有說明，此報告結果僅對檢驗之樣品負責。本報告未經本公司書面許可，不可部份複製。對本報告內容或外觀之任何未經授權之變更、偽造、竄改皆屬非法，違犯者將會被依法追訴。

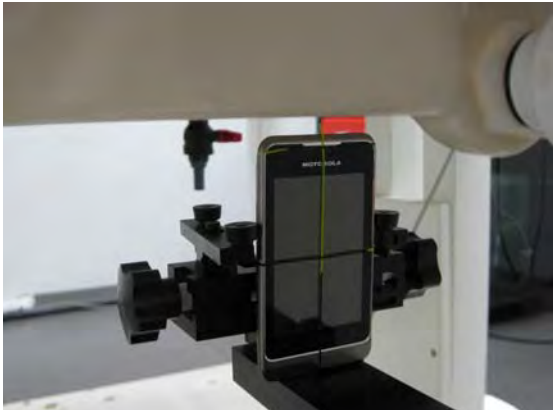

Fig.10 EUT Top to flat phantom

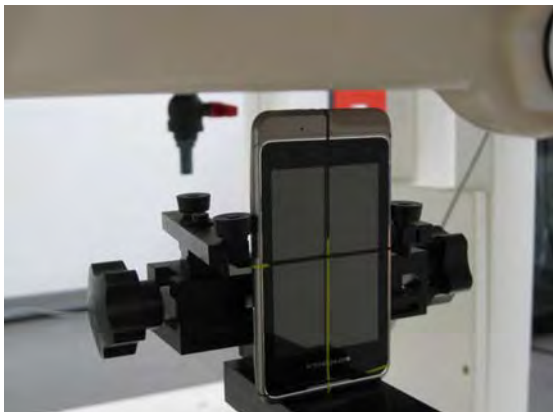
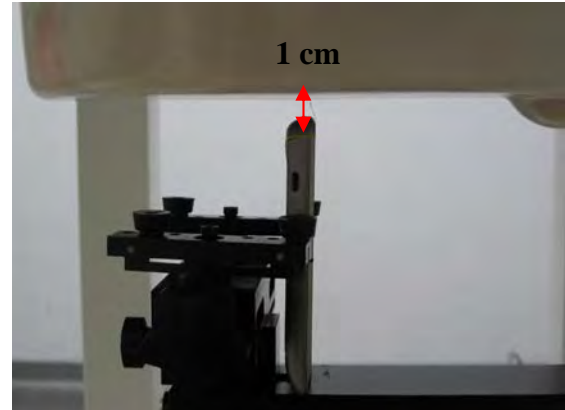

Fig.11 EUT Bottom to flat phantom

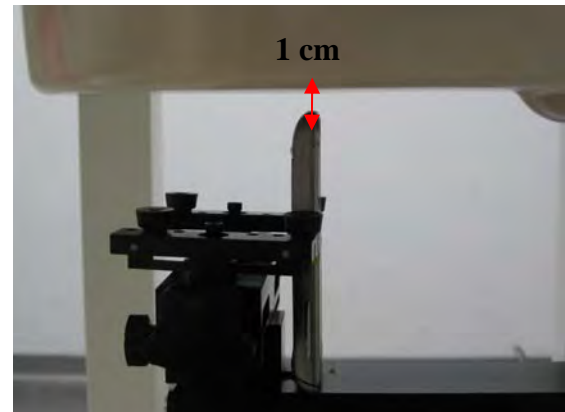
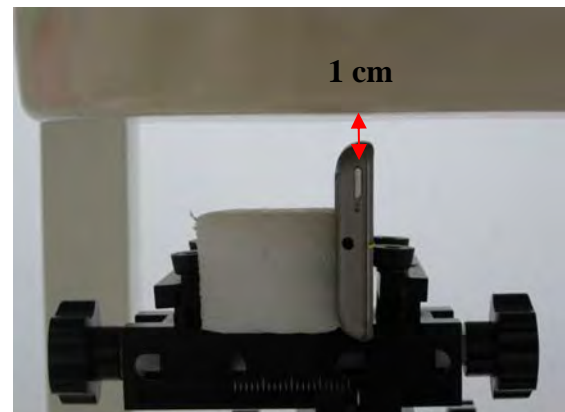

Fig.12 EUT Right to flat phantom



This document is issued by the Company subject to its General Conditions of Service printed overleaf or available on request and accessible at [www.sgs.com](http://www.sgs.com). Attention is drawn to the limitations of liability, indemnification, and Jurisdictional issued defined therein. Unless otherwise stated, the results shown in this test report refer only to the sample(s) tested. This document cannot be reproduced except in full, without prior approval of Company. Any unauthorized alteration, forgery or falsification of the content or appearance of this report is unlawful and offenders may be prosecuted to the fullest extent of the law. 此報告是遵循本公司訂定之通用服務條款所製作發放，請注意此條款列印於背面，亦可在[www.sgs.com](http://www.sgs.com)中查閱。將本公司之義務，免責，管轄權皆明確規範之。除非另有說明，此報告結果僅對檢驗之樣品負責。本報告未經本公司書面許可，不可部份複製。對本報告內容或外觀之任何未經授權之變更、偽造、竄改皆屬非法，違犯者將會被依法追訴。

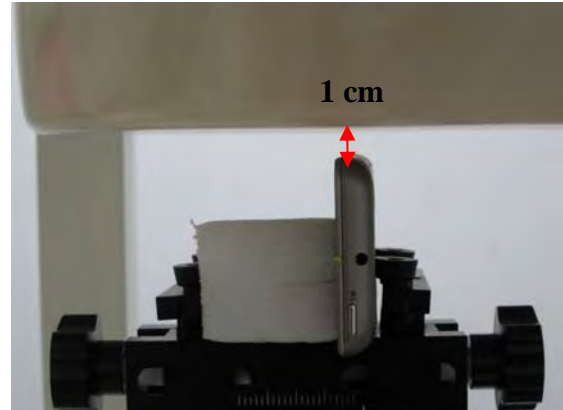
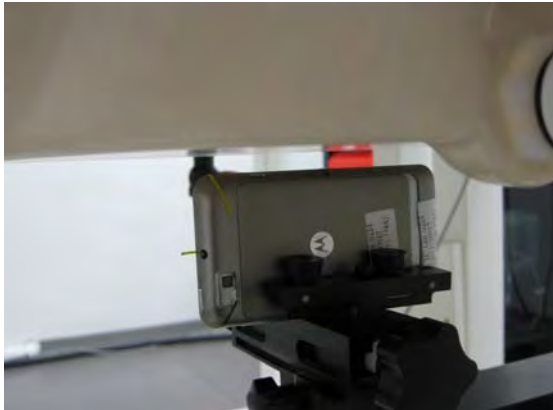

Fig.13 EUT Left to flat phantom

This document is issued by the Company subject to its General Conditions of Service printed overleaf or available on request and accessible at [www.sgs.com](http://www.sgs.com). Attention is drawn to the limitations of liability, indemnification, and Jurisdictional issued defined therein. Unless otherwise stated, the results shown in this test report refer only to the sample(s) tested. This document cannot be reproduced except in full, without prior approval of Company. Any unauthorized alteration, forgery or falsification of the content or appearance of this report is unlawful and offenders may be prosecuted to the fullest extent of the law. 此報告是遵循本公司訂定之通用服務條款所製作發放，請注意此條款列印於背面，亦可在[www.sgs.com](http://www.sgs.com)中查閱。將本公司之義務，免責，管轄權皆明確規範之。除非另有說明，此報告結果僅對檢驗之樣品負責。本報告未經本公司書面許可，不可部份複製。對本報告內容或外觀之任何未經授權之變更、偽造、竄改皆屬非法，違犯者將會被依法追訴。

## 11. Photographs of the EUT



Fig.14 Front view of EUT device



Fig.15 Back view of EUT device

This document is issued by the Company subject to its General Conditions of Service printed overleaf or available on request and accessible at [www.sgs.com](http://www.sgs.com). Attention is drawn to the limitations of liability, indemnification, and Jurisdictional issued defined therein. Unless otherwise stated, the results shown in this test report refer only to the sample(s) tested. This document cannot be reproduced except in full, without prior approval of Company. Any unauthorized alteration, forgery or falsification of the content or appearance of this report is unlawful and offenders may be prosecuted to the fullest extent of the law. 此報告是遵循本公司訂定之通用服務條款所製作發放，請注意此條款列印於背面，亦可在[www.sgs.com](http://www.sgs.com)中查閱。將本公司之義務，免責，管轄權皆明確規範之。除非另有說明，此報告結果僅對檢驗之樣品負責。本報告未經本公司書面許可，不可部份複製。對本報告內容或外觀之任何未經授權之變更、偽造、竄改皆屬非法，違犯者將會被依法追訴。



Fig.16 Front view of Battery



Fig.17 Back view of Battery

This document is issued by the Company subject to its General Conditions of Service printed overleaf or available on request and accessible at [www.sgs.com](http://www.sgs.com). Attention is drawn to the limitations of liability, indemnification, and Jurisdictional issued defined therein. Unless otherwise stated, the results shown in this test report refer only to the sample(s) tested. This document cannot be reproduced except in full, without prior approval of Company. Any unauthorized alteration, forgery or falsification of the content or appearance of this report is unlawful and offenders may be prosecuted to the fullest extent of the law. 此報告是遵循本公司訂定之通用服務條款所製作發放，請注意此條款列印於背面，亦可在[www.sgs.com](http://www.sgs.com)中查閱。將本公司之義務，免責，管轄權皆明確規範之。除非另有說明，此報告結果僅對檢驗之樣品負責。本報告未經本公司書面許可，不可部份複製。對本報告內容或外觀之任何未經授權之變更、偽造、竄改皆屬非法，違犯者將會被依法追訴。



Fig.18 Headset

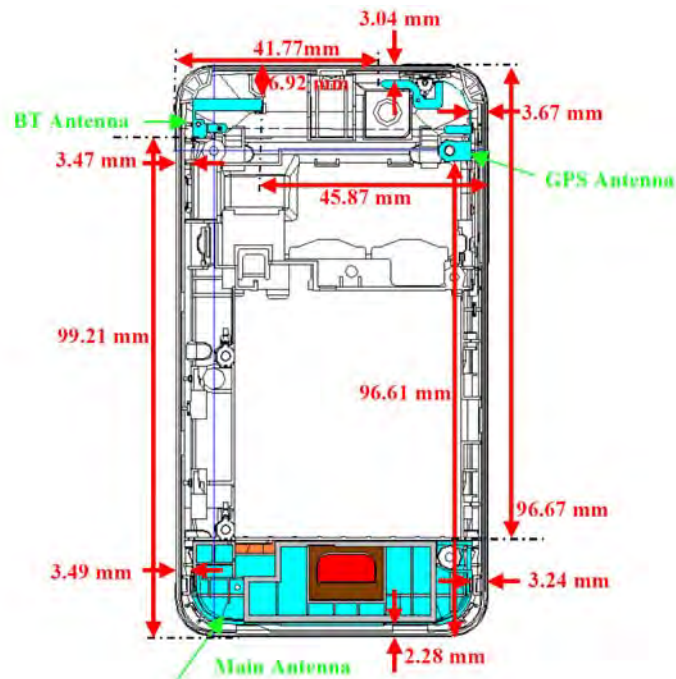

Fig.19 Antenna

- End of Report-

This document is issued by the Company subject to its General Conditions of Service printed overleaf or available on request and accessible at [www.sgs.com](http://www.sgs.com). Attention is drawn to the limitations of liability, indemnification, and Jurisdictional issued defined therein. Unless otherwise stated, the results shown in this test report refer only to the sample(s) tested. This document cannot be reproduced except in full, without prior approval of Company. Any unauthorized alteration, forgery or falsification of the content or appearance of this report is unlawful and offenders may be prosecuted to the fullest extent of the law. 此報告是遵循本公司訂定之通用服務條款所製作發放，請注意此條款列印於背面，亦可在[www.sgs.com](http://www.sgs.com)中查閱。將本公司之義務，免責，管轄權皆明確規範之。除非另有說明，此報告結果僅對檢驗之樣品負責。本報告未經本公司書面許可，不可部份複製。對本報告內容或外觀之任何未經授權之變更、偽造、竄改皆屬非法，違犯者將會被依法追訴。