

FCC Test Report

APPLICANT : Motorola Mobility, Inc.
EQUIPMENT : Quad GSM/GPRS/EDGE(downlink only) and Dual band WCDMA UMTS850/1900 mobile phone with BT/Wi-Fi
BRAND NAME : Motorola
MODEL NAME : XT550
MARKETING NAME : MOTOSMART™ MIX
TYPE NAME : M0D25
GPPD NUMBER : 3365
FCC ID : IHDT56NM2
STANDARD : FCC 47 CFR FCC Part 15 Subpart B
CLASSIFICATION : Certification

The product was received on Jan. 18, 2012 and completely tested on Mar. 23, 2012. We, SPORTON INTERNATIONAL INC., would like to declare that the tested sample has been evaluated in accordance with the procedures given in ANSI C63.4-2003 and shown the compliance with the applicable technical standards.

The test results in this report apply exclusively to the tested model / sample. Without written approval of SPORTON INTERNATIONAL INC., the test report shall not be reproduced except in full.

Reviewed by:



Jones Tsai / Manager



SPORTON INTERNATIONAL INC.

No. 52, Hwa Ya 1st Rd., Hwa Ya Technology Park, Kwei-Shan Hsiang, Tao Yuan Hsien, Taiwan, R.O.C.



TABLE OF CONTENTS

REVISION HISTORY 3

SUMMARY OF TEST RESULT 4

1. GENERAL DESCRIPTION 5

 1.1. Applicant 5

 1.2. Manufacturer 5

 1.3. Feature of Equipment Under Test 6

 1.4. Test Site 7

 1.5. Applied Standards 7

 1.6. Ancillary Equipment List 7

2. TEST CONFIGURATION OF EQUIPMENT UNDER TEST 8

 2.1. Test Mode 8

 2.2. Connection Diagram of Test System 10

 2.3. Test Software 11

3. TEST RESULT 12

 3.1. Test of AC Conducted Emission Measurement 12

 3.2. Test of Radiated Emission Measurement 20

4. LIST OF MEASURING EQUIPMENT 25

5. UNCERTAINTY OF EVALUATION 26



REVISION HISTORY

REPORT NO.	VERSION	DESCRIPTION	ISSUED DATE
FC211239-02A	Rev. 01	Initial issue of report	Apr. 06, 2012
FC211239-02A	Rev. 02	Update report of revising marketing name	May 08, 2012



SUMMARY OF TEST RESULT

Report Section	FCC Rule	IC Rule	Description	Limit	Result	Remark
3.1	15.107	7.2.4	AC Conducted Emission	< 15.107 limits < RSS-Gen table 2 limits	PASS	Under limit 4.78 dB at 2.080 MHz
3.2	15.109	7.2.3.2	Radiated Emission	< 15.109 limits or < RSS-Gen table 1 limits (Section 6)	PASS	Under limit 4.54 dB at 60.510 MHz



1. General Description

1.1. Applicant

Motorola Mobility, Inc.

No. 1, Wang Jing East Road, Chao Yang District, 100102 Beijing, P. R. China

1.2. Manufacturer

Gongqingcheng Cellon Communication Technology Co., LTD.

New industrial park, GongQingCheng, Jiujiang city, Jiangxi Province, China, Postal code : 332020

1.3. Feature of Equipment Under Test

Product Feature & Specification	
Equipment	Quad GSM/GPRS/EDGE(downlink only) and Dual band WCDMA UMTS850/1900 mobile phone with BT/Wi-Fi
Brand Name	Motorola
Model Name	XT550
Marketing Name	MOTOSMART™ MIX
Type Name	M0D25
FCC ID	IHDT56NM2
Tx Frequency Range	GSM850 : 824 MHz ~ 849 MHz GSM1900 : 1850 MHz ~ 1910 MHz WCDMA Band V : 824 MHz ~ 849 MHz WCDMA Band II : 1850 MHz ~ 1910 MHz Bluetooth : 2400 MHz ~ 2483.5 MHz WLAN : 2400 MHz ~ 2483.5 MHz
Rx Frequency Range	GSM850 : 869 MHz ~ 894 MHz GSM1900 : 1930 MHz ~ 1990 MHz WCDMA Band V : 869 MHz ~ 894 MHz WCDMA Band II : 1930 MHz ~ 1990 MHz Bluetooth : 2400 MHz ~ 2483.5 MHz WLAN : 2400 MHz ~ 2483.5 MHz GPS : 1.57542 GHz
Antenna Type	WWAN : Monopole Antenna WLAN : PIFA Antenna Bluetooth : Monopole Antenna
HW Version	B2
SW Version	ARGONS_4_02.07.02RDD
Type of Modulation	GSM: GMSK GPRS: GMSK EDGE: GMSK / 8PSK (Downlink Only) WCDMA: QPSK (Uplink) HSDPA: QPSK (Uplink) Bluetooth (1Mbps) : GFSK Bluetooth EDR (2Mbps) : $\pi/4$ -DQPSK Bluetooth EDR (3Mbps) : 8-DPSK 802.11b : DSSS (BPSK / QPSK / CCK) 802.11g/n : OFDM (BPSK / QPSK / 16QAM / 64QAM) GPS : BPSK
EUT Stage	Production Unit

Remark: The above EUT's information was declared by manufacturer. Please refer to the specifications or user's manual for more detailed description.

1.4. Test Site

Test Site	SPORTON INTERNATIONAL (KUNSHAN) INC.		
Test Site Location	No. 3-2, PingXiang Road, Kunshan, Jiangsu Province, P.R.C. TEL: +86-0512-5790-0158 FAX: +86-0512-5790-0958		
Test Site No.	Sporton Site No.		FCC/IC Registration No.
	CO01-KS	03CH01-KS	149928/4086E-1

1.5. Applied Standards

According to the specifications of the manufacturer, the EUT must comply with the requirements of the following standards:

- FCC 47 CFR FCC Part 15 Subpart B
- ANSI C63.4-2003
- IC RSS-Gen Issue 3

Remark: All test items were verified and recorded according to the standards and without any deviation during the test.

1.6. Ancillary Equipment List

Item	Equipment	Trade Name	Model Name	FCC ID	Data Cable	Power Cord
1.	System Simulator	R&S	CMU 200	N/A	N/A	Unshielded, 1.8 m
2.	GPS Station	T&E	GS-50	N/A	N/A	Unshielded, 1.8 m
3.	GPS Station	ADVIC	MP9000	N/A	N/A	Unshielded, 1.8 m
4.	PC	DELL	MT380	FCC DoC	N/A	Unshielded, 1.8 m
5.	PC	DELL	MT320	FCC DoC	N/A	Unshielded, 1.8 m
6.	Monitor	DELL	E1910Hc	FCC DoC	Shielded, 1.2 m	Unshielded, 1.8 m
7.	Printer	HP	Laser Jet 1018	FCC DoC	Shielded, 1.8 m	Unshielded, 1.8 m
8.	(USB) Keyboard	DELL	SK-8115	FCC DoC	Shielded, 1.8 m	N/A
9.	(USB) Mouse	DELL	MO56UC	FCC DoC	Shielded, 1.8 m	N/A
10.	(USB) Mouse	DELL	N231	FCC DoC	Shielded, 1.8 m	N/A
11.	iPod	Apple	A1199	FCC DoC	Shielded, 1.2 m	N/A
12.	Bluetooth Earphone	Nokia	BH-102	PYAHS-107W	N/A	N/A
13.	Bluetooth Earphone	Nokia	BH-106	QTLBH-106	N/A	N/A
14.	Router	D-Link	DIR-855	KA2DIR855A2	N/A	Unshielded, 1.8 m

2. Test Configuration of Equipment Under Test

2.1. Test Mode

The EUT has been associated with peripherals pursuant to ANSI C63.4-2003 and configuration operated in a manner tended to maximize its emission characteristics in a typical application.

Frequency range investigated: conduction (150 kHz to 30 MHz), radiation (30MHz to the 5th harmonic of the highest fundamental frequency or to 40 GHz, whichever is lower).

The EUT uses a USB interface and microprocessor operating 800MHz which is the maximum frequency used.

The following tables are showing the test modes as the worst cases and recorded in this report.

Item	EUT Configuration	Test Condition		
		EMI AC	EMI RE<1G	EMI RE≥1G
1.	Charging Mode (EUT with adapter)	☒	☒	Note 1
2.	Data application transferred mode (EUT with PC)	☒	☒	☒

Abbreviations:

- EMI AC: AC conducted emissions
- EMI RE ≥ 1G: EUT radiated emissions ≥ 1GHz
- EMI RE < 1G: EUT radiated emissions < 1GHz

Note 1: Testing for this mode is not required or not the worst case.

Remark: For signal above 1GHz, the worst case was test item 2.

Test Items	EUT Configure Mode	Function Type
AC Conducted Emission	1/2	Mode 1 : GSM850 Idle + Bluetooth Idle + WLAN Idle + Earphone + Camera + USB Cable (Charging from Adapter) <Fig. 1> Mode 2 : GSM1900 Idle + Bluetooth Idle + WLAN Idle + Earphone + MP3 + USB Cable (Charging from Adapter) <Fig. 1> Mode 3 : WCDMA Band V Idle + Bluetooth Idle + WLAN Idle + Earphone + GPS Rx + USB Cable (Charging from Adapter) <Fig. 2> Mode 4 : WCDMA Band II Idle + Bluetooth Idle + WLAN Idle + Earphone + USB Cable (Data Link with PC) <Fig. 3>
Radiated Emissions < 1GHz	1/2	Mode 1 : GSM850 Idle + Bluetooth Idle + WLAN Idle + Earphone + Camera + USB Cable (Charging from Adapter) <Fig. 1> Mode 2 : GSM1900 Idle + Bluetooth Idle + WLAN Idle + Earphone + MP3 + USB Cable (Charging from Adapter) <Fig. 1> Mode 3 : WCDMA Band V Idle + Bluetooth Idle + WLAN Idle + Earphone + GPS Rx + USB Cable (Charging from Adapter) <Fig. 2> Mode 4 : WCDMA Band II Idle + Bluetooth Idle + WLAN Idle + Earphone + USB Cable (Data Link with PC) <Fig. 3>
Radiated Emissions ≥ 1GHz	2	Mode 1 : WCDMA Band II Idle + Bluetooth Idle + WLAN Idle + Earphone + USB Cable (Data Link with PC) <Fig. 3>
<p>Remark:</p> <ol style="list-style-type: none"> 1. The worst case of AC is mode 3; the test data of this mode was reported. 2. The USB Link mode of AC Conducted Emission is mode 4; the test data of this mode was reported. 3. The worst case of RE < 1G is mode 4; only the test data of this mode was reported. 4. Link with PC means data application transferred mode between EUT and PC. 		

2.2. Connection Diagram of Test System

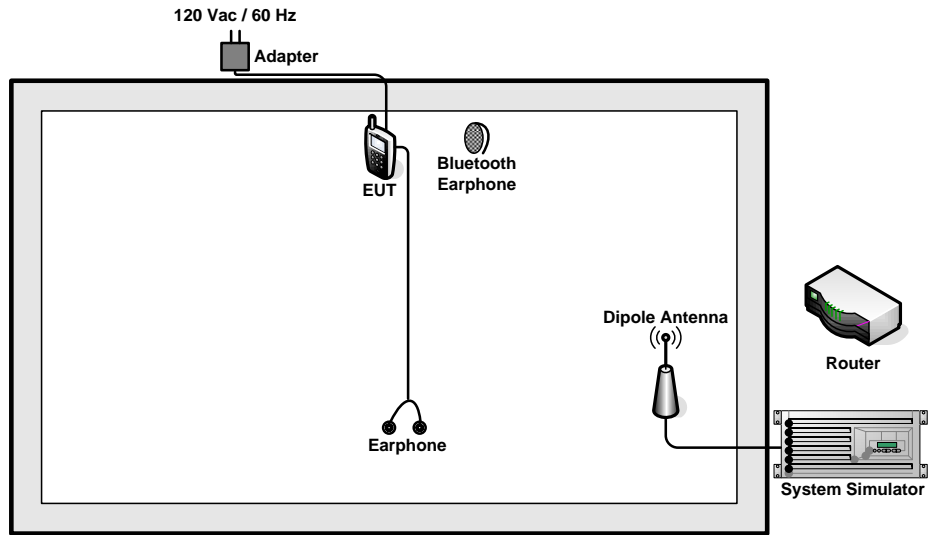

<Fig. 1>

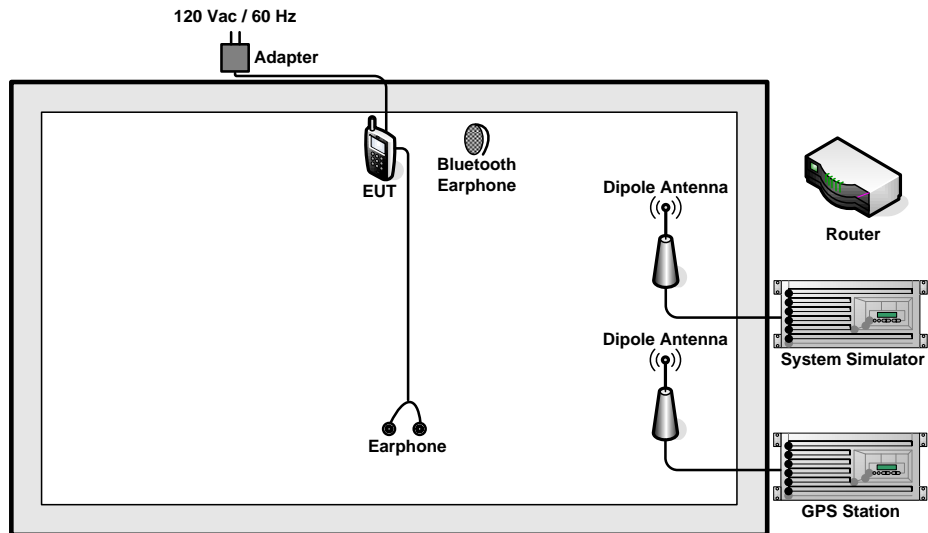

<Fig. 2>

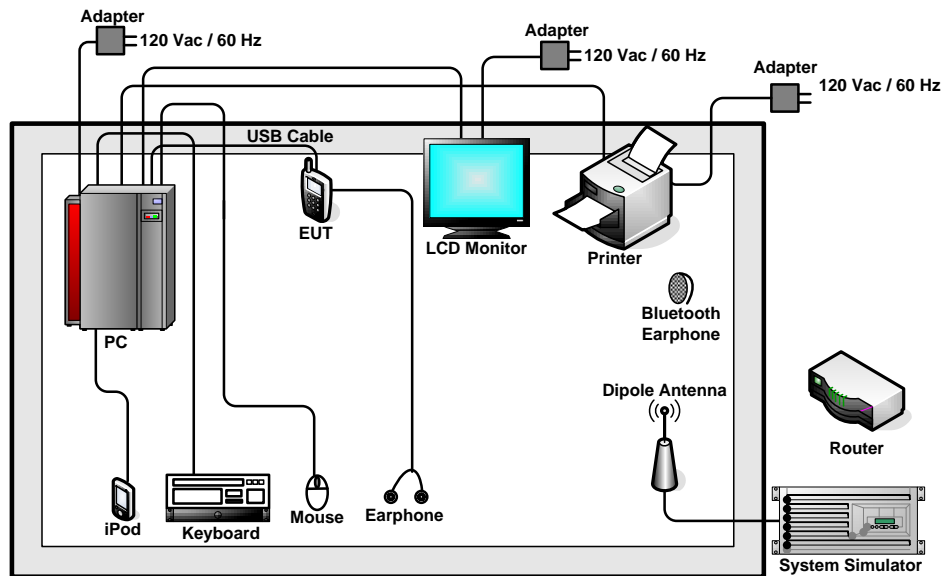

<Fig. 3>

2.3. Test Software

The EUT was in GSM or WCDMA idle mode during the testing. The EUT was synchronized to the BCCH, and is in continuous receiving mode by setting system simulator's paging reorganization.

At the same time, the EUT was attached to the Bluetooth earphone or WLAN AP, and the following programs installed in the EUT were programmed during the test.

1. Execute the program, "WINTHRAX.EXE", installed in PC for active sync files transfer with EUT via USB cable.
2. The EUT turns on GPS function to receive signals from GPS station continuously.
3. Execute "Music Player" to play MP3 file.
4. Turn on camera to capture images.

3. Test Result

3.1. Test of AC Conducted Emission Measurement

3.1.1 Limits of AC Conducted Emission

For equipment that is designed to be connected to the public utility (AC) power line, the radio frequency voltage that is conducted back onto the AC power line on any frequency or frequencies within the band 150 kHz to 30 MHz shall not exceed the limits in the following table.

Frequency of emission (MHz)	Conducted limit (dBuV)	
	Quasi-peak	Average
0.15-0.5	66 to 56*	56 to 46*
0.5-5	56	46
5-30	60	50

*Decreases with the logarithm of the frequency.

3.1.2 Measuring Instruments

See list of measuring instruments of this test report.

3.1.3 Test Procedure

1. The EUT was placed 0.4 meter from the conducting wall of the shielding room was kept at least 80 centimeters from any other grounded conducting surface.
2. Connect EUT to the power mains through a line impedance stabilization network (LISN).
3. All the support units are connecting to the other LISN.
4. The LISN provides 50 ohm coupling impedance for the measuring instrument.
5. The FCC states that a 50 ohm, 50 microhenry LISN should be used.
6. Both sides of AC line were checked for maximum conducted interference.
7. The frequency range from 150 KHz to 30 MHz was searched.
8. Set the test-receiver system to Peak Detect Function and specified bandwidth with Maximum Hold Mode.

3.1.4 Test Setup

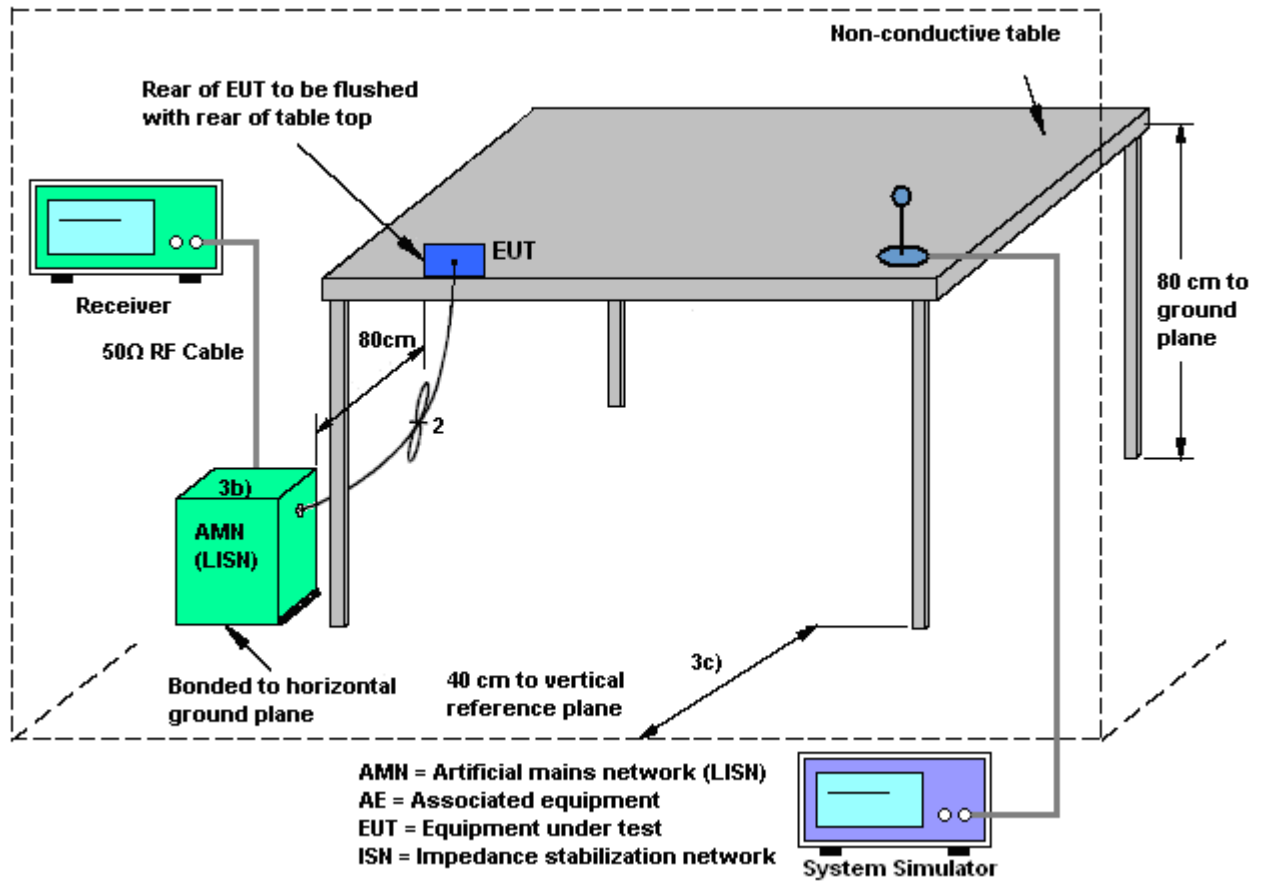



3.1.5 Test Result of AC Conducted Emission

Test Mode :	Mode 3	Temperature :	19~20°C
Test Engineer :	Tom Wang	Relative Humidity :	39~40%
Test Voltage :	120Vac / 60Hz	Phase :	Line
Function Type :	WCDMA Band V Idle + Bluetooth Idle + WLAN Idle + Earphone + GPS Rx + USB Cable (Charging from Adapter)		
Remark :	All emissions not reported here are more than 10 dB below the prescribed limit.		

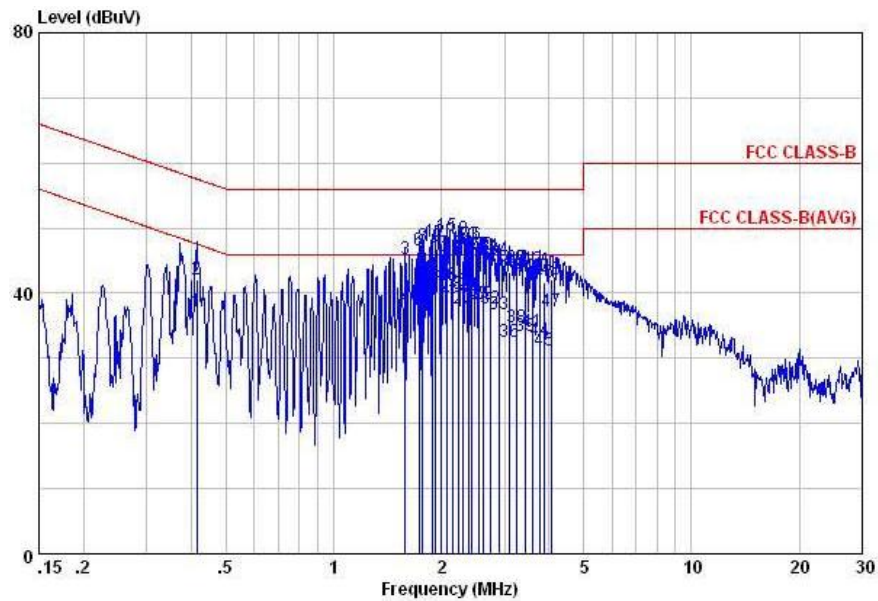

Site : C001-KS
 Condition: FCC CLASS-B LISN-100807 LINE

mode : Mode 3

	Freq	Level	Over	Limit	Read	LISN	Cable	Remark
	MHz	dBuV	dB	dBuV	dBuV	dB	dB	
1	0.41	37.31	-10.24	47.55	27.20	-0.08	10.19	Average
2	0.41	42.21	-15.34	57.55	32.10	-0.08	10.19	QP
3	1.59	45.30	-10.70	56.00	35.10	-0.11	10.31	QP
4	1.59	37.90	-8.10	46.00	27.70	-0.11	10.31	Average
5	1.73	39.11	-6.89	46.00	28.91	-0.11	10.31	Average
6	1.73	46.51	-9.49	56.00	36.31	-0.11	10.31	QP
7	1.77	39.41	-6.59	46.00	29.20	-0.11	10.32	Average
8	1.77	47.21	-8.79	56.00	37.00	-0.11	10.32	QP
9	1.89	40.41	-5.59	46.00	30.20	-0.11	10.32	Average
10	1.89	47.31	-8.69	56.00	37.10	-0.11	10.32	QP
11	1.93	40.02	-5.98	46.00	29.80	-0.11	10.33	Average
12	1.93	47.82	-8.18	56.00	37.60	-0.11	10.33	QP
13	2.00	45.42	-10.58	56.00	35.20	-0.11	10.33	QP
14	2.00	38.92	-7.08	46.00	28.70	-0.11	10.33	Average
15	2.08	48.82	-7.18	56.00	38.60	-0.11	10.33	QP
16	2.08	41.22	-4.78	46.00	31.00	-0.11	10.33	Average
17	2.16	46.23	-9.77	56.00	36.00	-0.11	10.34	QP
18	2.16	39.83	-6.17	46.00	29.60	-0.11	10.34	Average
19	2.22	48.43	-7.57	56.00	38.20	-0.11	10.34	QP
20	2.22	40.43	-5.57	46.00	30.20	-0.11	10.34	Average
21	2.30	45.03	-10.97	56.00	34.80	-0.11	10.34	QP
22	2.30	37.63	-8.37	46.00	27.40	-0.11	10.34	Average
23	2.38	47.54	-8.46	56.00	37.30	-0.11	10.35	QP
24	2.38	39.74	-6.26	46.00	29.50	-0.11	10.35	Average
25	2.42	39.54	-6.46	46.00	29.30	-0.11	10.35	Average
26	2.42	47.44	-8.56	56.00	37.20	-0.11	10.35	QP
27	2.54	38.24	-7.76	46.00	28.00	-0.11	10.35	Average



Test Mode :	Mode 3	Temperature :	19~20°C
Test Engineer :	Tom Wang	Relative Humidity :	39~40%
Test Voltage :	120Vac / 60Hz	Phase :	Line
Function Type :	WCDMA Band V Idle + Bluetooth Idle + WLAN Idle + Earphone + GPS Rx + USB Cable (Charging from Adapter)		
Remark :	All emissions not reported here are more than 10 dB below the prescribed limit.		

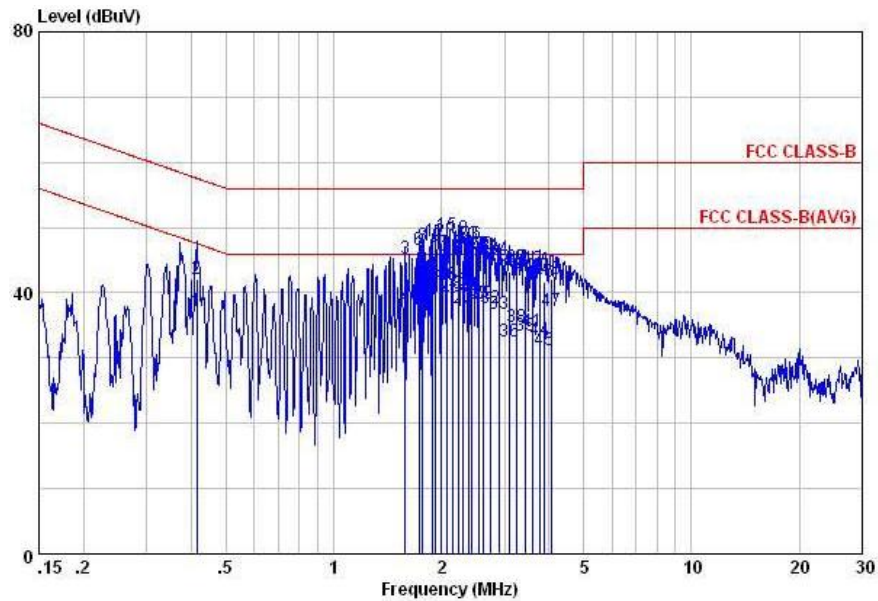

Site : C001-KS
 Condition: FCC CLASS-B LISN-100807 LINE

mode : Mode 3

	Freq	Level	Over	Limit	Read	LISN	Cable	Remark
	MHz	dBuV	Limit	Line	Level	Factor	Loss	
			dB	dBuV	dBuV	dB	dB	
28	2.54	45.84	-10.16	56.00	35.60	-0.11	10.35	QP
29	2.61	38.34	-7.66	46.00	28.09	-0.11	10.36	Average
30	2.61	45.94	-10.06	56.00	35.69	-0.11	10.36	QP
31	2.75	45.65	-10.35	56.00	35.41	-0.12	10.36	QP
32	2.75	37.65	-8.35	46.00	27.41	-0.12	10.36	Average
33	2.90	36.75	-9.25	46.00	26.50	-0.12	10.37	Average
34	2.90	45.15	-10.85	56.00	34.90	-0.12	10.37	QP
35	3.09	43.15	-12.85	56.00	32.90	-0.12	10.37	QP
36	3.09	32.55	-13.45	46.00	22.30	-0.12	10.37	Average
37	3.24	43.95	-12.05	56.00	33.70	-0.12	10.37	QP
38	3.24	34.85	-11.15	46.00	24.60	-0.12	10.37	Average
39	3.44	33.36	-12.64	46.00	23.10	-0.12	10.38	Average
40	3.44	42.46	-13.54	56.00	32.20	-0.12	10.38	QP
41	3.58	34.06	-11.94	46.00	23.80	-0.12	10.38	Average
42	3.58	43.76	-12.24	56.00	33.50	-0.12	10.38	QP
43	3.78	42.46	-13.54	56.00	32.21	-0.13	10.38	QP
44	3.78	32.86	-13.14	46.00	22.61	-0.13	10.38	Average
45	3.86	31.26	-14.74	46.00	21.00	-0.13	10.39	Average
46	3.86	41.76	-14.24	56.00	31.50	-0.13	10.39	QP
47	4.07	37.26	-8.74	46.00	27.00	-0.13	10.39	Average
48	4.07	42.16	-13.84	56.00	31.90	-0.13	10.39	QP



Test Mode :	Mode 3	Temperature :	19~20°C
Test Engineer :	Tom Wang	Relative Humidity :	39~40%
Test Voltage :	120Vac / 60Hz	Phase :	Neutral
Function Type :	WCDMA Band V Idle + Bluetooth Idle + WLAN Idle + Earphone + GPS Rx + USB Cable (Charging from Adapter)		
Remark :	All emissions not reported here are more than 10 dB below the prescribed limit.		

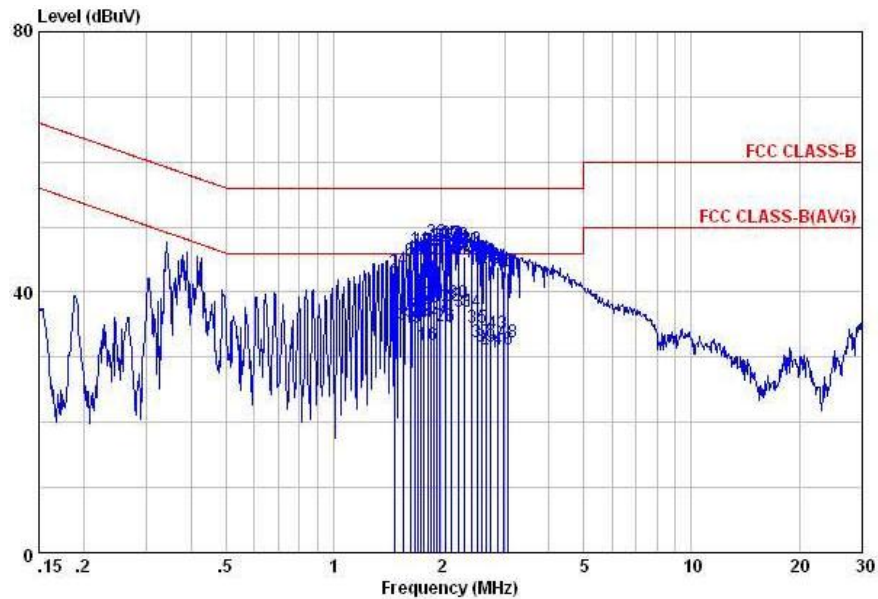

Site : C001-KS
 Condition: FCC CLASS-B LISN-100807 NEUTRAL

mode : Mode 3

	Freq	Level	Over	Limit	Read	LISN	Cable	Remark
	MHz	dBuV	Limit	Line	Level	Factor	Loss	
			dB	dBuV	dBuV	dB	dB	
1	1.48	32.10	-13.90	46.00	21.90	-0.10	10.30	Average
2	1.48	43.10	-12.90	56.00	32.90	-0.10	10.30	QP
3	1.56	34.90	-11.10	46.00	24.70	-0.10	10.30	Average
4	1.56	43.40	-12.60	56.00	33.20	-0.10	10.30	QP
5	1.64	35.50	-10.50	46.00	25.30	-0.11	10.31	Average
6	1.64	44.80	-11.20	56.00	34.60	-0.11	10.31	QP
7	1.68	36.31	-9.69	46.00	26.11	-0.11	10.31	Average
8	1.68	45.11	-10.89	56.00	34.91	-0.11	10.31	QP
9	1.72	34.61	-11.39	46.00	24.41	-0.11	10.31	Average
10	1.72	45.31	-10.69	56.00	35.11	-0.11	10.31	QP
11	1.75	46.61	-9.39	56.00	36.40	-0.11	10.32	QP
12	1.75	35.71	-10.29	46.00	25.50	-0.11	10.32	Average
13	1.79	46.31	-9.69	56.00	36.10	-0.11	10.32	QP
14	1.79	37.51	-8.49	46.00	27.30	-0.11	10.32	Average
15	1.83	45.31	-10.69	56.00	35.10	-0.11	10.32	QP
16	1.83	31.81	-14.19	46.00	21.60	-0.11	10.32	Average
17	1.87	44.81	-11.19	56.00	34.60	-0.11	10.32	QP
18	1.87	37.61	-8.39	46.00	27.40	-0.11	10.32	Average
19	1.90	46.31	-9.69	56.00	36.10	-0.11	10.32	QP
20	1.90	38.11	-7.89	46.00	27.90	-0.11	10.32	Average
21	1.94	38.62	-7.38	46.00	28.40	-0.11	10.33	Average
22	1.94	47.62	-8.38	56.00	37.40	-0.11	10.33	QP
23	1.98	47.02	-8.98	56.00	36.80	-0.11	10.33	QP
24	1.98	35.92	-10.08	46.00	25.70	-0.11	10.33	Average
25	2.05	46.92	-9.08	56.00	36.70	-0.11	10.33	QP
26	2.05	34.82	-11.18	46.00	24.60	-0.11	10.33	Average
27	2.13	47.43	-8.57	56.00	37.20	-0.11	10.34	QP



Test Mode :	Mode 3	Temperature :	19~20°C
Test Engineer :	Tom Wang	Relative Humidity :	39~40%
Test Voltage :	120Vac / 60Hz	Phase :	Neutral
Function Type :	WCDMA Band V Idle + Bluetooth Idle + WLAN Idle + Earphone + GPS Rx + USB Cable (Charging from Adapter)		
Remark :	All emissions not reported here are more than 10 dB below the prescribed limit.		

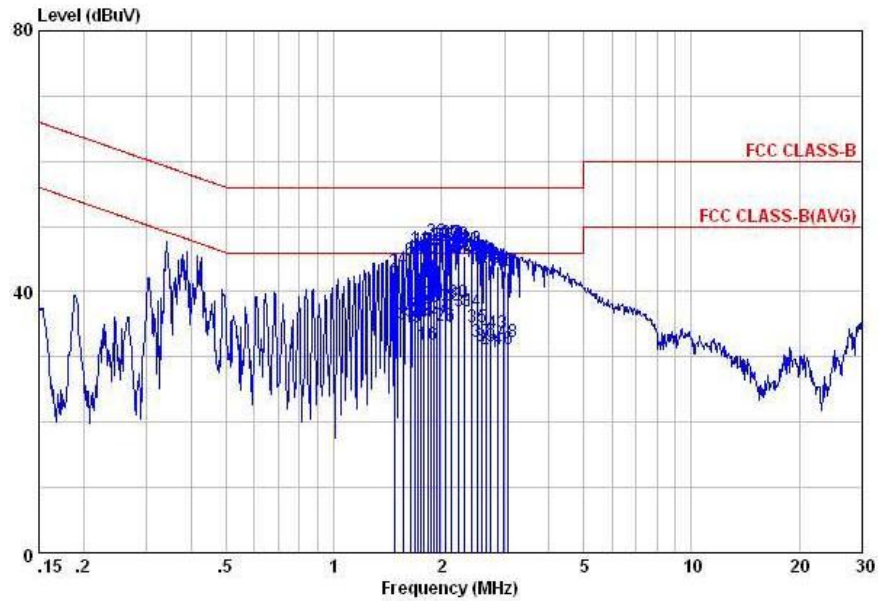

Site : C001-KS
 Condition: FCC CLASS-B LISN-100807 NEUTRAL

mode : Mode 3

	Freq	Level	Over	Limit	Read	LISN	Cable	Remark
	MHz	dBuV	Limit	Line	Level	Factor	Loss	
		dBuV	dB	dBuV	dBuV	dB	dB	
28	2.13	37.93	-8.07	46.00	27.70	-0.11	10.34	Average
29	2.24	47.23	-8.77	56.00	37.00	-0.11	10.34	QP
30	2.24	38.23	-7.77	46.00	28.00	-0.11	10.34	Average
31	2.32	37.03	-8.97	46.00	26.79	-0.11	10.35	Average
32	2.32	45.53	-10.47	56.00	35.29	-0.11	10.35	QP
33	2.43	46.64	-9.36	56.00	36.40	-0.11	10.35	QP
34	2.43	36.94	-9.06	46.00	26.70	-0.11	10.35	Average
35	2.51	34.64	-11.36	46.00	24.40	-0.11	10.35	Average
36	2.51	45.24	-10.76	56.00	35.00	-0.11	10.35	QP
37	2.59	32.24	-13.76	46.00	21.99	-0.11	10.36	Average
38	2.59	45.04	-10.96	56.00	34.79	-0.11	10.36	QP
39	2.66	31.64	-14.36	46.00	21.39	-0.11	10.36	Average
40	2.66	44.74	-11.26	56.00	34.49	-0.11	10.36	QP
41	2.75	30.75	-15.25	46.00	20.51	-0.12	10.36	Average
42	2.75	44.15	-11.85	56.00	33.91	-0.12	10.36	QP
43	2.88	33.65	-12.35	46.00	23.40	-0.12	10.37	Average
44	2.88	43.95	-12.05	56.00	33.70	-0.12	10.37	QP
45	2.98	43.15	-12.85	56.00	32.90	-0.12	10.37	QP
46	2.98	31.25	-14.75	46.00	21.00	-0.12	10.37	Average
47	3.07	42.95	-13.05	56.00	32.70	-0.12	10.37	QP
48	3.07	32.25	-13.75	46.00	22.00	-0.12	10.37	Average



Test Mode :	Mode 4	Temperature :	19~20°C
Test Engineer :	Tom Wang	Relative Humidity :	39~40%
Test Voltage :	120Vac / 60Hz	Phase :	Line
Function Type :	WCDMA Band II Idle + Bluetooth Idle + WLAN Idle + Earphone + USB Cable (Data Link with PC)		
Remark :	All emissions not reported here are more than 10 dB below the prescribed limit.		

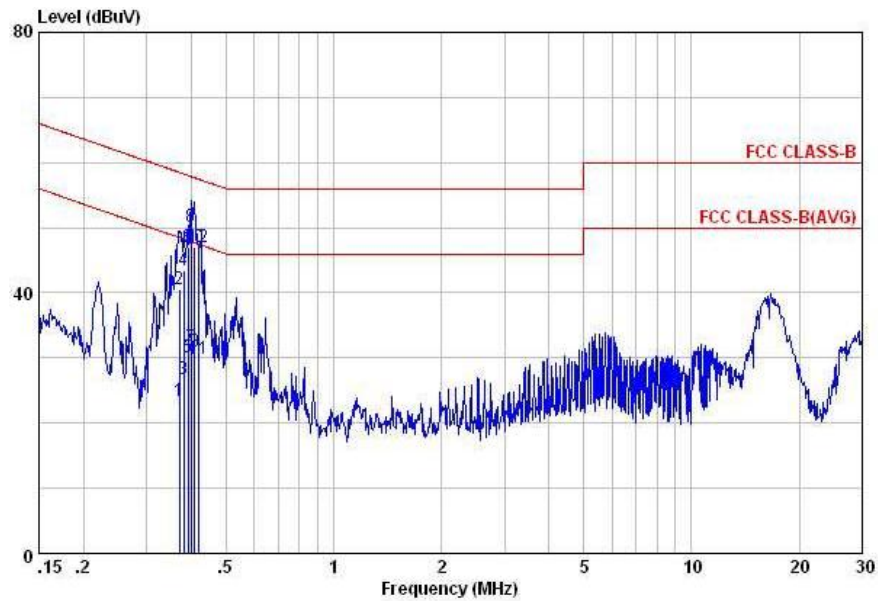

Site : C001-KS
 Condition: FCC CLASS-B LISN-100807 LINE

mode : Mode 4

	Freq	Level	Over	Limit	Read	LISN	Cable	Remark
	MHz	dBuV	Limit	Line	Level	Factor	Loss	
			dB	dBuV	dBuV	dB	dB	
1	0.37	23.41	-25.06	48.47	13.30	-0.08	10.19	Average
2	0.37	40.61	-17.86	58.47	30.50	-0.08	10.19	QP
3	0.38	26.71	-21.54	48.25	16.60	-0.08	10.19	Average
4	0.38	43.41	-14.84	58.25	33.30	-0.08	10.19	QP
5	0.39	30.01	-18.02	48.03	19.90	-0.08	10.19	Average
6	0.39	46.91	-11.12	58.03	36.80	-0.08	10.19	QP
7	0.40	31.71	-16.15	47.86	21.60	-0.08	10.19	Average
8	0.40	50.11	-7.75	57.86	40.00	-0.08	10.19	QP
9	0.41	30.91	-16.77	47.68	20.80	-0.08	10.19	Average
10	0.41	46.91	-10.77	57.68	36.80	-0.08	10.19	QP
11	0.42	29.82	-17.64	47.46	19.71	-0.08	10.19	Average
12	0.42	47.12	-10.34	57.46	37.01	-0.08	10.19	QP



Test Mode :	Mode 4	Temperature :	19~20°C
Test Engineer :	Tom Wang	Relative Humidity :	39~40%
Test Voltage :	120Vac / 60Hz	Phase :	Neutral
Function Type :	WCDMA Band II Idle + Bluetooth Idle + WLAN Idle + Earphone + USB Cable (Data Link with PC)		
Remark :	All emissions not reported here are more than 10 dB below the prescribed limit.		

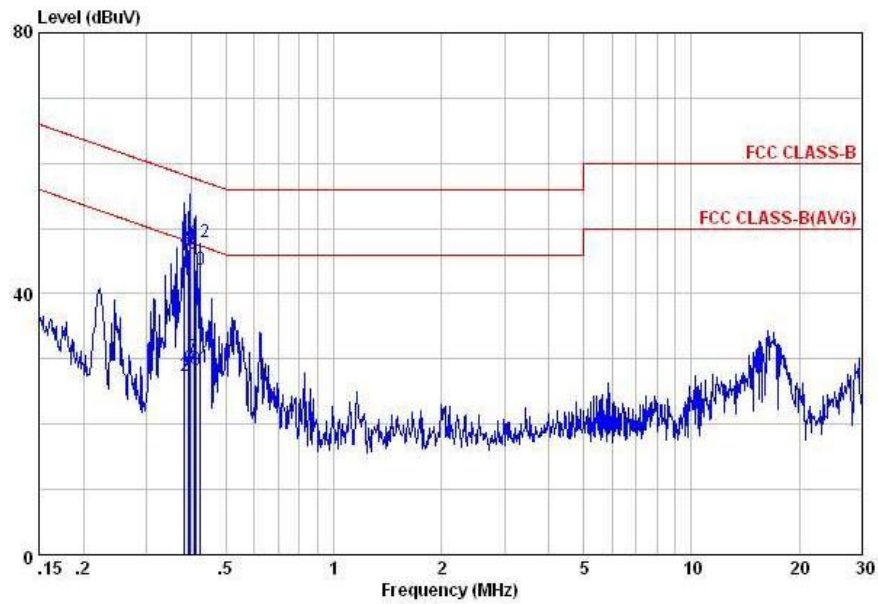

Site : C001-KS
 Condition: FCC CLASS-B LISN-100807 NEUTRAL

mode : Mode 4

	Freq	Level	Over	Limit	Read	LISN	Cable	Remark
	MHz	dBuV	Limit	Line	Level	Factor	Loss	
			dB	dBuV	dBuV	dB	dB	
1	0.38	45.91	-12.30	58.21	35.80	-0.08	10.19	QP
2	0.38	27.31	-20.90	48.21	17.20	-0.08	10.19	Average
3	0.39	46.81	-11.22	58.03	36.70	-0.08	10.19	QP
4	0.39	27.91	-20.12	48.03	17.80	-0.08	10.19	Average
5	0.40	46.51	-11.44	57.95	36.40	-0.08	10.19	QP
6	0.40	28.61	-19.34	47.95	18.50	-0.08	10.19	Average
7	0.41	30.21	-17.52	47.73	20.10	-0.08	10.19	Average
8	0.41	46.11	-11.62	57.73	36.00	-0.08	10.19	QP
9	0.41	28.21	-19.38	47.59	18.10	-0.08	10.19	Average
10	0.41	43.71	-13.88	57.59	33.60	-0.08	10.19	QP
11	0.42	28.82	-18.60	47.42	18.71	-0.08	10.19	Average
12	0.42	47.92	-9.50	57.42	37.81	-0.08	10.19	QP



3.2. Test of Radiated Emission Measurement

3.2.1. Limit of Radiated Emission

The emissions from an intentional radiator shall not exceed the field strength levels specified in the following table:

Frequency (MHz)	Field Strength (microvolts/meter)	Measurement Distance (meters)
0.009 – 0.490	2400/F(KHz)	300
0.490 – 1.705	24000/F(KHz)	30
1.705 – 30.0	30	30
30 – 88	100	3
88 – 216	150	3
216 - 960	200	3
Above 960	500	3

3.2.2. Measuring Instruments

See list of measuring instruments of this test report.



3.2.3. Test Procedures

1. The EUT was placed on a turntable with 0.8 meter above ground.
2. The EUT was set 3 meters from the interference receiving antenna, which was mounted on the top of a variable height antenna tower.
3. The table was rotated 360 degrees to determine the position of the highest radiation.
4. The antenna is a Bi-Log antenna and its height is adjusted between one meter and four meters above ground to find the maximum value of the field strength for both horizontal polarization and vertical polarization of the antenna.
5. For each suspected emission, the EUT was arranged to its worst case and then tune the antenna tower (from 1 m to 4 m) and turntable (from 0 degree to 360 degrees) to find the maximum reading.
6. Set the test-receiver system to Peak Detect Function and specified bandwidth with Maximum Hold Mode.
7. If the emission level of the EUT in peak mode was 3 dB lower than the limit specified, then testing will be stopped and peak values of EUT will be reported, otherwise, the emissions will be repeated one by one using the quasi-peak method and reported
8. Emission level (dBuV/m) = 20 log Emission level (uV/m)
9. Corrected Reading: Antenna Factor + Cable Loss + Read Level - Preamp Factor = Level

3.2.4. Test Setup of Radiated Emission

For radiated emissions below 30MHz

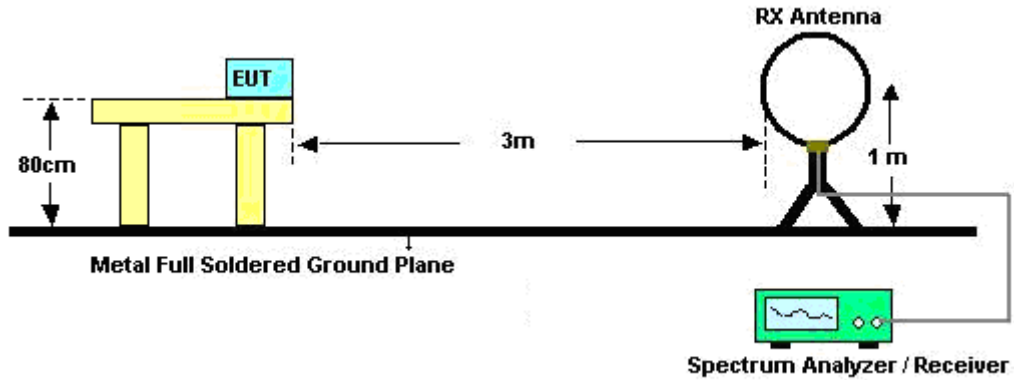

For radiated emissions above 30MHz

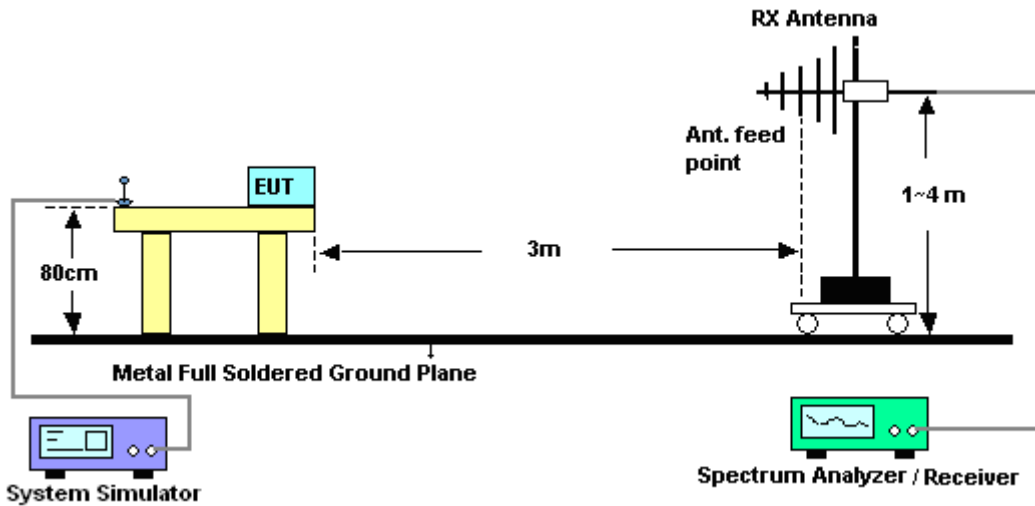

3.2.5. Test Results of Radiated Emissions (9 kHz ~ 30 MHz)

The low frequency, which started from 9 KHz to 30MHz, was pre-scanned and the result which was 20dB lower than the limit line per 15.31(o) was not reported.

3.2.6. Test Result of Radiated Emission

Test Mode :	Mode 4	Temperature :	21~22°C
Test Engineer :	Chemmy Cheng	Relative Humidity :	46~47%
Test Distance :	3m	Polarization :	Horizontal
Function Type :	WCDMA Band II Idle + Bluetooth Idle + WLAN Idle + Earphone + USB Cable (Data Link with PC)		

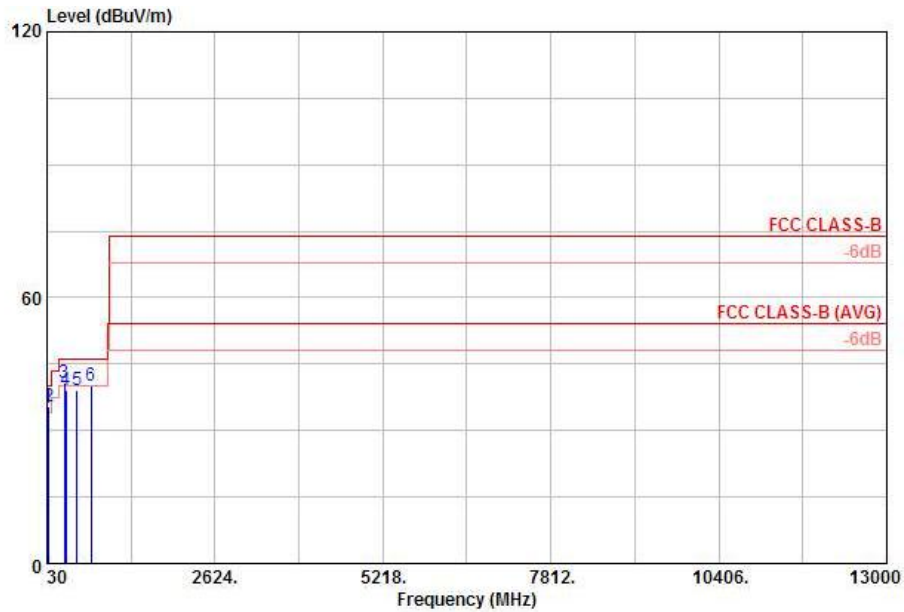

Site : 03CH01-KS
 Condition: FCC CLASS-B 3m LF_ANT_100803 HORIZONTAL

Mode : mode 4

	Freq	Level	Over	Limit	ReadAntenna	Cable	Preamp	Ant	Table	
	MHz	dBuV/m	Limit	Line	Level	Loss	Factor	Pos	Pos	Remark
			dB	dBuV/m	dBuV	dB	dB	cm	deg	
1 !	31.08	35.03	-4.97	40.00	47.57	17.29	0.25	30.08	---	Peak
2 !	60.51	35.46	-4.54	40.00	59.99	5.30	0.31	30.14	100	Peak
3 !	295.14	40.74	-5.26	46.00	57.04	12.93	0.72	29.95	---	Peak
4	319.60	38.95	-7.05	46.00	54.59	13.55	0.76	29.95	---	Peak
5	498.10	39.10	-6.90	46.00	50.69	17.18	0.96	29.73	---	Peak
6 !	715.80	40.11	-5.89	46.00	49.19	19.46	1.14	29.68	---	Peak



Test Mode :	Mode 4	Temperature :	21~22°C
Test Engineer :	Chemmy Cheng	Relative Humidity :	46~47%
Test Distance :	3m	Polarization :	Vertical
Function Type :	WCDMA Band II Idle + Bluetooth Idle + WLAN Idle + Earphone + USB Cable (Data Link with PC)		

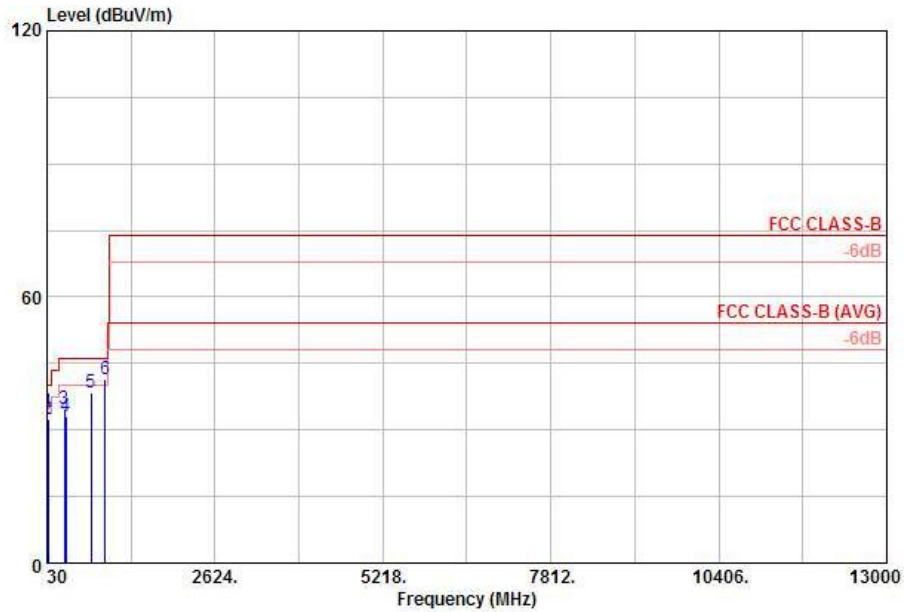

Site : 03CH01-KS
 Condition: FCC CLASS-B 3m LF_ANT_100803 VERTICAL

Mode : mode 4

	Freq	Level	Over	Limit	Readantenna	Cable	Preamp	Ant	Table	Remark	
	MHz	dBuV/m	dB	dBuV/m	dBuV	dB/m	dB	dB	cm	deg	
1 !	31.08	34.21	-5.79	40.00	46.75	17.29	0.25	30.08	---	---	Peak
2	49.44	32.47	-7.53	40.00	54.57	7.75	0.28	30.13	---	---	Peak
3	295.14	34.79	-11.21	46.00	51.09	12.93	0.72	29.95	---	---	Peak
4	319.60	33.14	-12.86	46.00	48.78	13.55	0.76	29.95	---	---	Peak
5	715.80	38.39	-7.61	46.00	47.47	19.46	1.14	29.68	---	---	Peak
6 !	933.50	41.40	-4.60	46.00	48.95	20.65	1.32	29.52	100	186	Peak



4. List of Measuring Equipment

Instrument	Manufacturer	Model No.	Serial No.	Characteristics	Calibration Date	Test Date	Due Date	Remark
EMI Test Receiver	R&S	ESCI7	100768	9kHz~7GHz	Jun. 02, 2011	Mar. 23, 2012	Jun. 01, 2012	Conduction (CO01-KS)
LISN	MessTec	AN3016	060103	9kHz~30MHz	Dec. 30, 2011	Mar. 23, 2012	Dec. 29, 2012	Conduction (CO01-KS)
LISN	MessTec	AN3016	060105	9kHz~30MHz	Dec. 30, 2011	Mar. 23, 2012	Dec. 29, 2012	Conduction (CO01-KS)
AC Power Source	Chroma	61602	ABP0000008 11	N/A	Nov. 16, 2011	Mar. 23, 2012	Nov. 15, 2012	Conduction (CO01-KS)
GPS Station	ADIVIC	MP9000	MP9000-1110 46	N/A	Dec. 15, 2011	Mar. 23, 2012	Dec. 14, 2012	Conduction (CO01-KS)
EMI Test Receiver	R&S	ESCI	100534	9kHz~3GHz	Nov. 09, 2011	Mar. 22, 2012	Nov. 08, 2012	Radiation (03CH01-KS)
Spectrum Analyzer	R&S	FSP40	100319	9kHz~40GHz	Dec. 30, 2011	Mar. 22, 2012	Dec. 29, 2012	Radiation (03CH01-KS)
Spectrum Analyzer	R&S	FSP30	101400	9kHz~30GHz	Jun. 02, 2011	Mar. 22, 2012	Jun. 01, 2012	Radiation (03CH01-KS)
Bilog Antenna	SCHAFFNER	CBL6112D	23182	25MHz~2GHz	Dec. 08, 2011	Mar. 22, 2012	Dec. 07, 2012	Radiation (03CH01-KS)
Double Ridge Horn Antenna	EMCO	3117	00075959	1GHz~18GHz	Jan. 06, 2012	Mar. 22, 2012	Jan. 05, 2013	Radiation (03CH01-KS)
Amplifier	Wireless	FPA-6592G	060029	9KHz~2GHz	Jan. 06, 2012	Mar. 22, 2012	Jan. 05, 2013	Radiation (03CH01-KS)
Amplifier	Wireless	FPA-6592G	060004	30MHz~2GHz	Dec. 30, 2011	Mar. 22, 2012	Dec. 29, 2012	Radiation (03CH01-KS)
Amplifier	Agilent	8449B	3008A02370	1GHz~26.5GHz	Dec. 30, 2011	Mar. 22, 2012	Dec. 29, 2012	Radiation (03CH01-KS)
Active Horn Antenna	com-power	AHA-118	701023	1G-18GHz	Nov. 07, 2011	Mar. 22, 2012	Nov. 06, 2012	Radiation (03CH01-KS)
SHF-EHF Horn	Schwarzbeck	BBHA 9170	BBHA170249	15-40GHz	Oct. 11, 2011	Mar. 22, 2012	Oct. 10, 2012	Radiation (03CH01-KS)
Loop Antenna	R&S	HFH2-Z2	860004/001	9 kHz~30 MHz	Jul. 29, 2010	Mar. 22, 2012	Jul. 28, 2012	Radiation (03CH01-KS)
GPS Station	T&E	GS-50	N/A	N/A	N/A	Mar. 22, 2012	N/A	Radiation (03CH01-KS)
System Simulator	R&S	CMU200	116456	Full-Band	Sep. 20, 2011	Mar. 22, 2012~ Mar. 23, 2012	Sep. 19, 2012	-

5. Uncertainty of Evaluation

Uncertainty of Conducted Emission Measurement (150 KHz ~ 30 MHz)

Contribution	Uncertainty of X_i		$u(X_i)$
	dB	Probability Distribution	
Receiver Reading	0.10	Normal (k=2)	0.05
Cable Loss	0.10	Normal (k=2)	0.05
AMN Insertion Loss	2.50	Rectangular	0.63
Receiver Specification	1.50	Rectangular	0.43
Site Imperfection	1.39	Rectangular	0.80
Mismatch	+0.34 / -0.35	U-Shape	0.24
Combined Standard Uncertainty $Uc(y)$	1.13		
Measuring Uncertainty for a Level of Confidence of 95% ($U = 2Uc(y)$)	2.26		

Uncertainty of Radiated Emission Measurement (30 MHz ~ 1000 MHz)

Contribution	Uncertainty of X_i		$u(X_i)$
	dB	Probability Distribution	
Receiver Reading	0.41	Normal (k=2)	0.21
Antenna Factor Calibration	0.83	Normal (k=2)	0.42
Cable Loss Calibration	0.25	Normal (k=2)	0.13
Pre-Amplifier Gain Calibration	0.27	Normal (k=2)	0.14
RCV/SPA Specification	2.50	Rectangular	0.72
Antenna Factor Interpolation for Frequency	1.00	Rectangular	0.29
Site Imperfection	1.43	Rectangular	0.83
Mismatch	+0.39 / -0.41	U-Shape	0.28
Combined Standard Uncertainty $Uc(y)$	1.27		
Measuring Uncertainty for a Level of Confidence of 95% ($U = 2Uc(y)$)	2.54		



Uncertainty of Radiated Emission Measurement (1 GHz ~ 40 GHz)

Contribution	Uncertainty of X_i		$u(X_i)$	C_i	$C_i * u(X_i)$
	dB	Probability Distribution			
Receiver Reading	±0.10	Normal (k=2)	0.10	1	0.10
Antenna Factor Calibration	±1.70	Normal (k=2)	0.85	1	0.85
Cable Loss Calibration	±0.50	Normal (k=2)	0.25	1	0.25
Receiver Correction	±2.00	Rectangular	1.15	1	1.15
Antenna Factor Directional	±1.50	Rectangular	0.87	1	0.87
Site Imperfection	±2.80	Triangular	1.14	1	1.14
Mismatch Receiver VSWR $\Gamma_1 = 0.197$ Antenna VSWR $\Gamma_2 = 0.194$ Uncertainty = $20\text{Log}(1-\Gamma_1*\Gamma_2)$	+0.34 / -0.35	U-Shape	0.244	1	0.244
Combined Standard Uncertainty $U_c(y)$	2.36				
Measuring Uncertainty for a Level of Confidence of 95% ($U = 2U_c(y)$)	4.72				