

# FCC RF Test Report

APPLICANT : Motorola Mobility, Inc.  
EQUIPMENT : Quad GSM/GPRS/EDGE(downlink only),  
UMTS850/2100,single sim, BT, 802.11 b/g/n,  
DLNA, WiFi Direct, GPS/AGPS, HSDPA,  
non-OMTP  
BRAND NAME : Motorola  
MODEL NAME /  
MARKETING NAME : XT550  
TYPE NAME : M0D24  
GPPD NUMBER : 3363  
FCC ID : IHDT56NM1  
STANDARD : FCC 47 CFR Part 2, 22(H), 24(E)  
CLASSIFICATION : PCS Licensed Transmitter Held to Ear (PCE)  
Tx/Rx FREQUENCY RANGE : GSM850 : 824.2 ~ 848.8 MHz /  
869.2 ~ 893.8 MHz  
GSM1900 : 1850.2 ~ 1909.8 MHz /  
1930.2 ~ 1989.8 MHz  
WCDMA Band V : 826.4 ~ 846.6 MHz /  
871.4 ~ 891.6 MHz  
MAX. ERP/EIRP POWER : GSM850 (GSM) : 1.047 W  
GSM1900 (GPRS 8) : 1.982 W  
WCDMA Band V (RMC 12.2Kbps) : 0.179 W

The product was received on Jan. 12, 2012 and completely tested on Feb. 23, 2012. We, SPORTON INTERNATIONAL INC., would like to declare that the tested sample has been evaluated in accordance with the procedures given in ANSI / TIA / EIA-603-C-2004 and shown compliance with the applicable technical standards.

The test results in this report apply exclusively to the tested model / sample. Without written approval of SPORTON INTERNATIONAL INC., the test report shall not be reproduced except in full.

Reviewed by:



Jones Tsai / Manager



## SPORTON INTERNATIONAL INC.

No. 52, Hwa Ya 1<sup>st</sup> Rd., Hwa Ya Technology Park, Kwei-Shan Hsiang, Tao Yuan Hsien, Taiwan, R.O.C.



# TABLE OF CONTENTS

**REVISION HISTORY..... 3**

**SUMMARY OF TEST RESULT ..... 4**

**1 GENERAL DESCRIPTION ..... 5**

    1.1 Applicant..... 5

    1.2 Manufacturer ..... 5

    1.3 Feature of Equipment Under Test..... 6

    1.4 Emission Designator and Maximum ERP/EIRP Power ..... 7

    1.5 Testing Site..... 7

    1.6 Applied Standards ..... 7

    1.7 Ancillary Equipment List ..... 7

**2 TEST CONFIGURATION OF EQUIPMENT UNDER TEST ..... 8**

    2.1 Test Mode..... 8

    2.2 Connection Diagram of Test System ..... 9

**3 TEST RESULT ..... 10**

    3.1 Conducted Output Power Measurement ..... 10

    3.2 Effective Radiated Power and Effective Isotropic Radiated Power Measurement ..... 12

    3.3 Occupied Bandwidth Measurement ..... 16

    3.4 Band Edge Measurement..... 20

    3.5 Conducted Emission Measurement ..... 27

    3.6 Field Strength of Spurious Radiation Measurement ..... 35

    3.7 Frequency Stability Measurement..... 43

**4 LIST OF MEASURING EQUIPMENT ..... 47**

**5 UNCERTAINTY OF EVALUATION ..... 48**





### SUMMARY OF TEST RESULT

Report Section	FCC Rule	IC Rule	Description	Limit	Result	Remark
3.1	§2.1046	N/A	Conducted Output Power	N/A	PASS	-
3.2	§22.913(a)(2)	RSS-132(4.4) SRSP-503(5.1.3)	Effective Radiated Power	< 7 Watts	PASS	-
3.2	§24.232(c)	RSS-133 (6.4) SRSP-510(5.1.2)	Equivalent Isotropic Radiated Power	< 2 Watts	PASS	-
3.3	§2.1049 §22.917(a) §24.238(a)	N/A	Occupied Bandwidth	N/A	PASS	-
3.4	§2.1051 §22.917(a) §24.238(a)	RSS-132 (4.5.1) RSS-133 (6.5.1)	Band Edge Measurement	< 43+10log <sub>10</sub> (P[Watts])	PASS	-
3.5	§2.1051 §22.917(a) §24.238(a)	RSS-132 (4.5.1) RSS-133 (6.5.1)	Conducted Emission	< 43+10log <sub>10</sub> (P[Watts])	PASS	-
3.6	§2.1053 §22.917(a) §24.238(a)	RSS-132 (4.5.1) RSS-133 (6.5.1)	Field Strength of Spurious Radiation	< 43+10log <sub>10</sub> (P[Watts])	PASS	Under limit 27.13 dB at 4182.00 MHz
3.7	§2.1055 §22.355 §24.235	RSS-132(4.3) RSS-133(6.3)	Frequency Stability for Temperature & Voltage	< 2.5 ppm	PASS	-



# **1 General Description**

## **1.1 Applicant**

**Motorola Mobility, Inc.**

No. 1, Wang Jing East Road, Chao Yang District, 100102 Beijing, P. R. China

## **1.2 Manufacturer**

**Gongqingcheng Cellon Communication Technology Co., LTD.**

New industrial park, GongQingCheng, Jiujiang city, Jiangxi Province, China, Postal code : 332020

### 1.3 Feature of Equipment Under Test

Product Feature & Specification	
<b>Equipment</b>	Quad GSM/GPRS/EDGE(downlink only), UMTS850/2100,single sim, BT, 802.11 b/g/n, DLNA, WiFi Direct, GPS/AGPS, HSDPA, non-OMTP
<b>Brand Name</b>	Motorola
<b>Model Name / Market Name</b>	XT550
<b>Type Name</b>	MOD24
<b>FCC ID</b>	IHDT56NM1
<b>Tx Frequency</b>	GSM850 : 824 MHz ~ 849 MHz GSM1900 : 1850 MHz ~ 1910 MHz WCDMA Band V : 824 MHz ~ 849 MHz
<b>Rx Frequency</b>	GSM850 : 869 MHz ~ 894 MHz GSM1900 : 1930 MHz ~ 1990 MHz WCDMA Band V : 869 MHz ~ 894 MHz
<b>Maximum Output Power to Antenna</b>	GSM850 : 33.21 dBm GSM1900 : 30.26 dBm WCDMA Band V : 24.08 dBm
<b>Antenna Type</b>	PIFA Antenna
<b>HW Version</b>	B2
<b>SW Version</b>	ARGONS_4_02.07.02RDD
<b>Type of Modulation</b>	GSM: GMSK GPRS: GMSK EDGE: GMSK / 8PSK (Downlink Only) WCDMA: QPSK (Uplink) HSDPA: QPSK (Uplink)
<b>EUT Stage</b>	Identical Prototype

**Remark:** The above EUT's information was declared by manufacturer. Please refer to the specifications or user's manual for more detailed description.

### 1.4 Emission Designator and Maximum ERP/EIRP Power

FCC Rule	System	Type of Modulation	Emission Designator	Maximum ERP/EIRP
Part 22	GSM850 GSM	GMSK	242KGXW	1.047 W
Part 22	WCDMA Band V RMC 12.2Kbps	QPSK	4M18F9W	0.179 W
Part 24	GSM1900 GPRS 8	GMSK	242KGXW	1.982 W

### 1.5 Testing Site

<b>Test Site</b>	SPORTON INTERNATIONAL (KUNSHAN) INC.		
<b>Test Site Location</b>	No. 3-2, PingXiang Road, Kunshan, Jiangsu Province, P.R.C. TEL: +86-0512-5790-0158 FAX: +86-0512-5790-0958		
<b>Test Site No.</b>	<b>Sporton Site No.</b>		<b>FCC/IC Registration No.</b>
	TH01-KS	03CH01-KS	149928/4086E-1

### 1.6 Applied Standards

According to the specifications of the manufacturer, the EUT must comply with the requirements of the following standards:

- ♦ FCC 47 CFR Part 2, 22(H), 24(E)
- ♦ ANSI / TIA / EIA-603-C-2004
- ♦ FCC KDB 971168 D01 Power Meas. License Digital Systems v01
- ♦ IC RSS-132 Issue 2
- ♦ IC RSS-133 Issue 5

**Remark:**

1. All test items were verified and recorded according to the standards and without any deviation during the test.
2. This EUT has also been tested and complied with the requirements of FCC Part 15, Subpart B, recorded in a separate test report.

### 1.7 Ancillary Equipment List

Item	Equipment	Trade Name	Model No.	FCC ID	Data Cable	Power Cord
1.	System Simulator	R&S	CMU200	N/A	N/A	Unshielded, 1.8 m
2.	DC Power Supply	GW	GPS-30300	N/A	N/A	Unshielded, 1.8 m

## 2 Test Configuration of Equipment Under Test

### 2.1 Test Mode

During all testing, EUT is in link mode with base station emulator at maximum power level. The spurious emission measurements were carried out in semi-anechoic chamber with 3-meter test range, and EUT is rotated on three test planes to find out the worst emission.

Frequency range investigated for radiated emission is as follows:

1. 30 MHz to 9000 MHz for GSM850 and WCDMA Band V.
2. 30 MHz to 19000 MHz for GSM1900.

Test Modes		
Band	Radiated TCs	Conducted TCs
GSM 850	■ GSM Link	■ GSM Link
GSM 1900	■ GPRS 8 Link	■ GPRS 8 Link
WCDMA Band V	■ RMC 12.2Kbps Link	■ RMC 12.2Kbps Link

**Note:**

1. The maximum power levels are GSM or GPRS multi-slot class 8 mode for GMSK link, and RMC 12.2Kbps mode for WCDMA band V, only these modes were used for all tests.
2. Because there are individual antennas for each WWAN, WLAN, and Bluetooth, the co-location test modes are not required.
3. All the Radiation and Conducted tests were performance with Battery 2.

The conducted power tables are as follows:

Band	GSM850			GSM1900		
Channel	128	189	251	512	661	810
Frequency (MHz)	824.2	836.4	848.8	1850.2	1880.0	1909.8
GSM (1 Uplink)	33.21	33.18	33.14	30.18	30.22	30.25
GPRS 8 (1 Uplink)	33.20	33.18	33.12	30.15	30.21	30.26
GPRS 10 (2 Uplink)	30.51	30.53	30.52	28.51	28.56	28.60
GPRS 12 (4 Uplink)	27.51	27.52	27.49	24.96	25.03	25.08

Conducted Power (*Unit: dBm)			
Band	WCDMA Band V		
Channel	4132	4182	4233
Frequency	826.4	836.4	846.6
RMC 12.2K	23.96	24.08	24.07
HSDPA Subtest-1	23.91	24.02	24.05
HSDPA Subtest-2	23.82	23.94	23.92
HSDPA Subtest-3	23.31	23.45	23.47
HSDPA Subtest-4	23.30	23.46	23.48

## 2.2 Connection Diagram of Test System

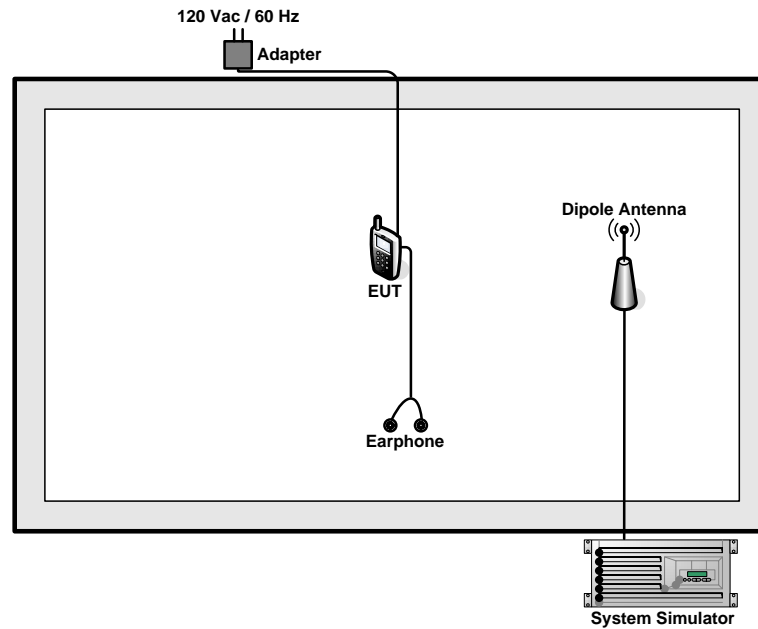

### 3 Test Result

#### 3.1 Conducted Output Power Measurement

##### 3.1.1 Description of the Conducted Output Power Measurement

A base station simulator was used to establish communication with the EUT. Its parameters were set to transmit the maximum power on the EUT. The measured power in the radio frequency on the transmitter output terminals shall be reported.

##### 3.1.2 Measuring Instruments

See list of measuring instruments of this test report.

##### 3.1.3 Test Procedures

1. The transmitter output port was connected to base station.
2. Set EUT at maximum power through base station.
3. Select lowest, middle, and highest channels for each band and different modulation.

##### 3.1.4 Test Setup

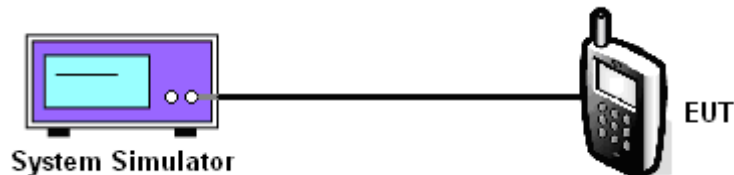



3.1.5 Test Result of Conducted Output Power

Cellular Band						
Modes	GSM850 (GSM)			WCDMA Band V (RMC 12.2Kbps)		
Channel	128 (Low)	189 (Mid)	251 (High)	4132 (Low)	4182 (Mid)	4233 (High)
Frequency (MHz)	824.2	836.4	848.8	826.4	836.4	846.6
Conducted Power (dBm)	33.21	33.18	33.14	23.96	24.08	24.07
Conducted Power (Watts)	2.09	2.08	2.06	0.25	0.26	0.26

PCS Band			
Modes	GSM1900 (GPRS 8)		
Channel	512 (Low)	661 (Mid)	810 (High)
Frequency (MHz)	1850.2	1880	1909.8
Conducted Power (dBm)	30.15	30.21	30.26
Conducted Power (Watts)	1.04	1.05	1.06



## 3.2 Effective Radiated Power and Effective Isotropic Radiated Power Measurement

### 3.2.1 Description of the ERP/EIRP Measurement

The substitution method, in ANSI / TIA / EIA-603-C-2004, was used for ERP/EIRP measurement, and the spectrum analyzer configuration follows KDB 971168 D01 Power Meas. License Digital Systems v01. The ERP of mobile transmitters must not exceed 7 Watts and the EIRP of mobile transmitters are limited to 2 Watts.

### 3.2.2 Measuring Instruments

See list of measuring instruments of this test report.

### 3.2.3 Test Procedures

1. The EUT was placed on a turntable with 1.0 meter height in a fully anechoic chamber.
2. The EUT was set at 1.2 meters from the receiving antenna, which was mounted on the antenna tower.
3. The table was rotated 360 degrees to determine the position of the highest radiated power.
4. The height of the receiving antenna is adjusted to look for the maximum ERP/EIRP.
5. Taking the record of maximum ERP/EIRP.
6. A dipole antenna was substituted in place of the EUT and was driven by a signal generator.
7. The conducted power at the terminal of the dipole antenna is measured.
8. Repeat step 3 to step 5 to get the maximum ERP/EIRP of the substitution antenna.
9.  $ERP/EIRP = P_s + E_t - E_s + G_s = P_s + R_t - R_s + G_s$

$P_s$  (dBm) : Input power to substitution antenna.

$G_s$  (dBi or dBd) : Substitution antenna Gain.

$E_t = R_t + AF$

$E_s = R_s + AF$

$AF$  (dB/m) : Receive antenna factor

$R_t$  : The highest received signal in spectrum analyzer for EUT.

$R_s$  : The highest received signal in spectrum analyzer for substitution antenna.

### 3.2.4 Test Setup

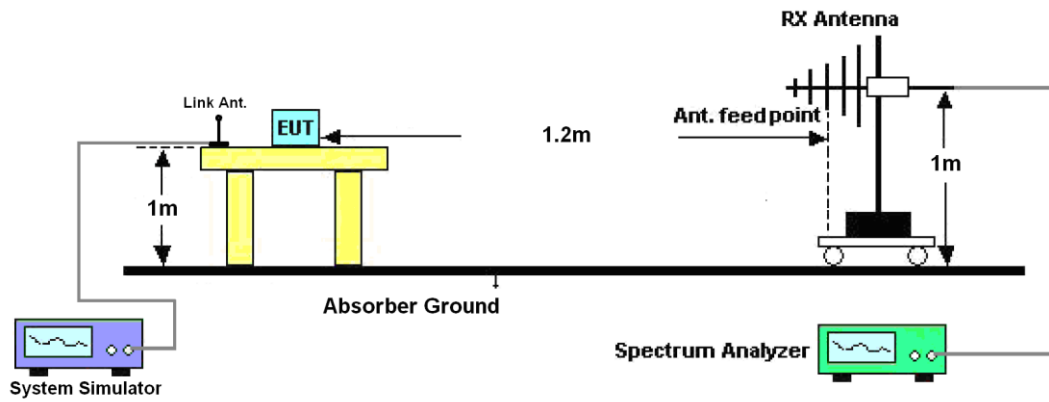



3.2.5 Test Result of ERP

GSM850 (GSM) Radiated Power ERP						
Horizontal Polarization						
Frequency (MHz)	Rt (dBm)	Rs (dBm)	Ps (dBm)	Gs (dBd)	ERP (dBm)	ERP (W)
824.20	-17.35	-48.12	0.00	-1.08	29.69	0.931
836.40	-17.37	-48.28	0.00	-0.93	29.98	0.995
848.80	-17.39	-48.35	0.00	-0.76	30.20	1.047
Vertical Polarization						
Frequency (MHz)	Rt (dBm)	Rs (dBm)	Ps (dBm)	Gs (dBd)	ERP (dBm)	ERP (W)
824.20	-29.92	-47.97	0.00	-1.08	16.97	0.050
836.40	-29.42	-48.01	0.00	-0.93	17.66	0.058
848.80	-29.10	-48.05	0.00	-0.76	18.19	0.066

WCDMA Band V (RMC 12.2Kbps) Radiated Power ERP						
Horizontal Polarization						
Frequency (MHz)	Rt (dBm)	Rs (dBm)	Ps (dBm)	Gs (dBd)	ERP (dBm)	ERP (W)
826.40	-25.43	-48.12	0.00	-1.08	21.61	0.145
836.40	-25.27	-48.28	0.00	-0.93	22.08	0.161
846.60	-25.05	-48.35	0.00	-0.76	22.54	0.179
Vertical Polarization						
Frequency (MHz)	Rt (dBm)	Rs (dBm)	Ps (dBm)	Gs (dBd)	ERP (dBm)	ERP (W)
826.40	-38.00	-47.97	0.00	-1.08	8.89	0.008
836.40	-37.38	-48.01	0.00	-0.93	9.70	0.009
846.60	-36.84	-48.05	0.00	-0.76	10.45	0.011



3.2.6 Test Result of EIRP

GSM1900 (GPRS 8) Radiated Power EIRP						
Horizontal Polarization						
Frequency (MHz)	Rt (dBm)	Rs (dBm)	Ps (dBm)	Gs (dBi)	EIRP (dBm)	EIRP (W)
1850.20	-21.00	-51.88	0.00	1.96	32.84	1.923
1880.00	-22.02	-52.99	0.00	2.00	32.97	1.982
1909.80	-23.96	-54.28	0.00	1.98	32.30	1.698
Vertical Polarization						
Frequency (MHz)	Rt (dBm)	Rs (dBm)	Ps (dBm)	Gs (dBi)	EIRP (dBm)	EIRP (W)
1850.20	-21.38	-52.13	0.00	1.96	32.71	1.866
1880.00	-22.63	-53.17	0.00	2.00	32.54	1.795
1909.80	-23.67	-54.13	0.00	1.98	32.44	1.754

### 3.3 Occupied Bandwidth Measurement

#### 3.3.1 Description of Occupied Bandwidth Measurement

The emission bandwidth is defined as the width of the signal between two points, located at the 2 sides of the carrier frequency, outside of which all emissions are attenuated at least 26 dB below the transmitter power.

#### 3.3.2 Measuring Instruments

See list of measuring instruments of this test report.

#### 3.3.3 Test Procedures

1. The EUT was connected to Spectrum Analyzer and Base Station via power divider.
2. The 99% and 26 dB occupied bandwidth (BW) of the middle channel for the highest RF powers were measured.

#### 3.3.4 Test Setup

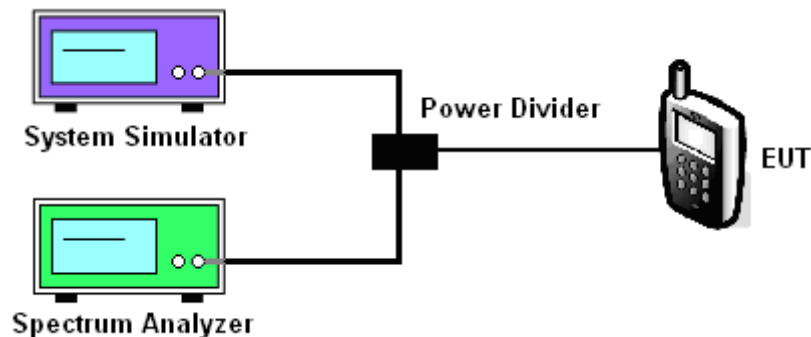



3.3.5 Test Result (Plots) of Occupied Bandwidth

Band :	GSM 850	Power Stage :	High
Test Mode :	GSM Link		

99% Occupied Bandwidth Plot on Channel 189

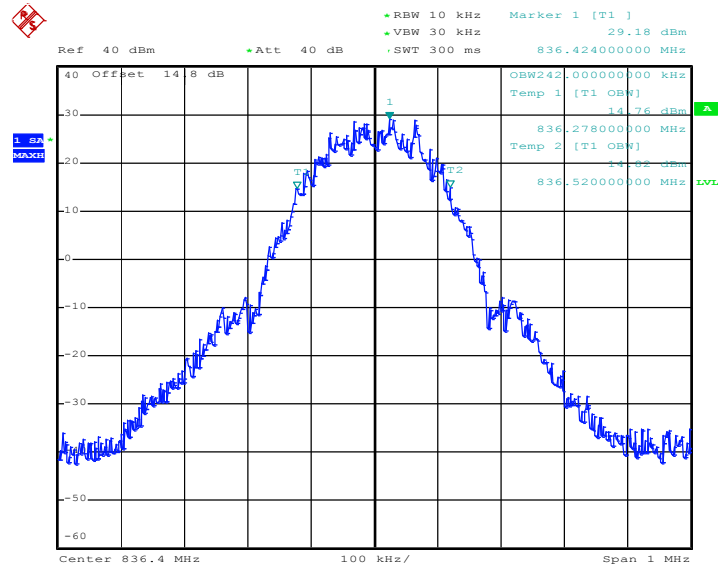

Date: 23.FEB.2012 22:03:04

26dB Bandwidth Plot on Channel 189

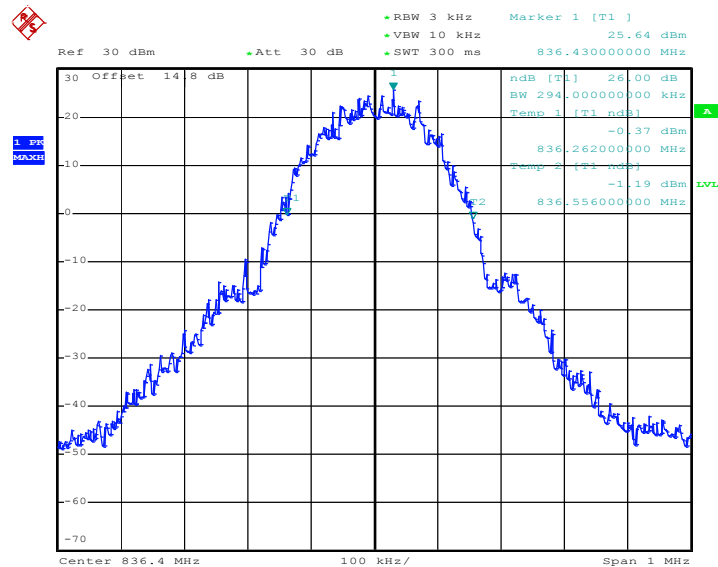

Date: 23.FEB.2012 21:50:37



<b>Band :</b>	GSM 1900	<b>Power Stage :</b>	High
<b>Test Mode :</b>	GPRS 8 Link		

99% Occupied Bandwidth Plot on Channel 661

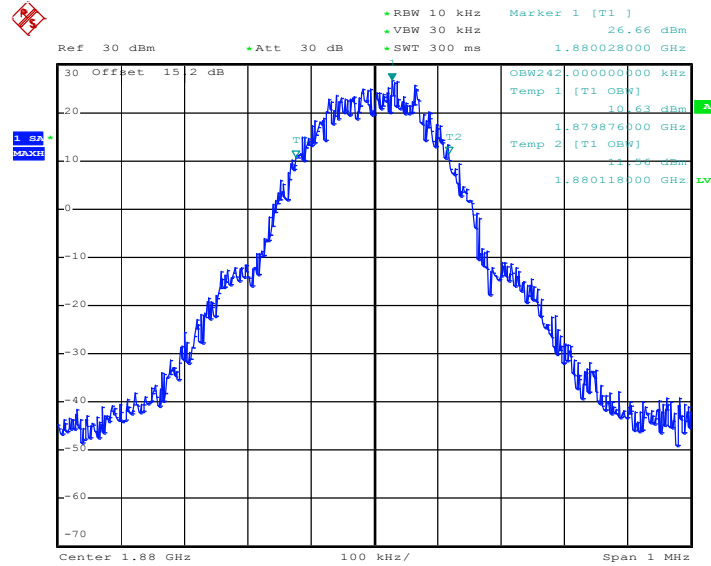

Date: 23.FEB.2012 22:31:09

26dB Bandwidth Plot on Channel 661

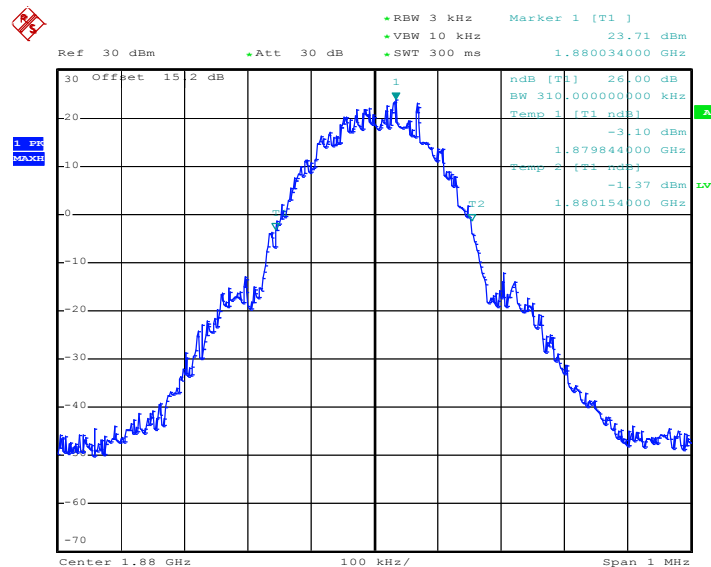

Date: 23.FEB.2012 22:29:51



<b>Band :</b>	WCDMA Band V	<b>Power Stage :</b>	High
<b>Test Mode :</b>	RMC 12.2Kbps Link		

**99% Occupied Bandwidth Plot on Channel 4182**

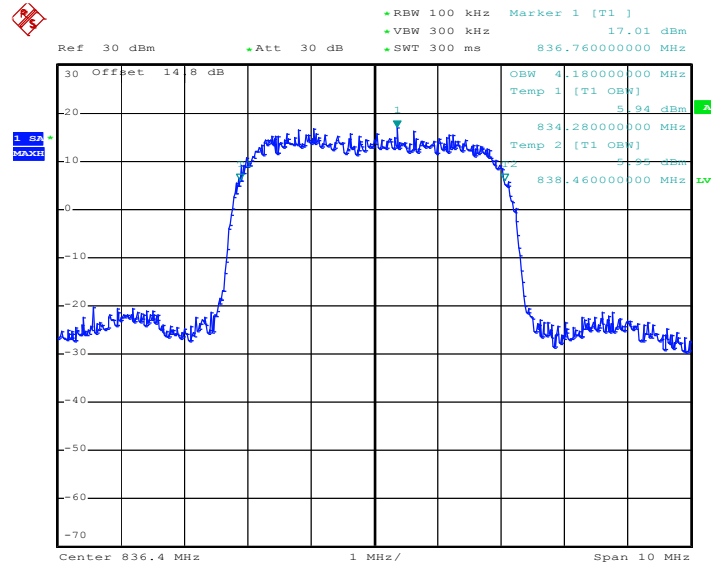

Date: 23.FEB.2012 23:44:45

**26dB Bandwidth Plot on Channel 4182**

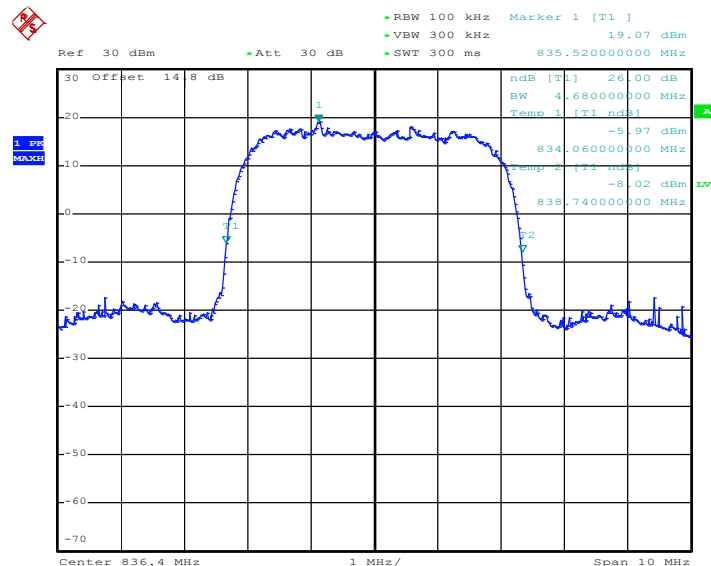

Date: 23.FEB.2012 23:43:28

## 3.4 Band Edge Measurement

### 3.4.1 Description of Band Edge Measurement

The power of any emission outside of the authorized operating frequency ranges must be lower than the transmitter power (P) by a factor of at least  $43 + 10 \log (P)$  dB.

### 3.4.2 Measuring Instruments

See list of measuring instruments of this test report.

### 3.4.3 Test Procedures

1. The EUT was connected to Spectrum Analyzer and Base Station via power divider.
2. The band edges of low and high channels for the highest RF powers were measured. Setting RBW as roughly BW/100.

### 3.4.4 Test Setup

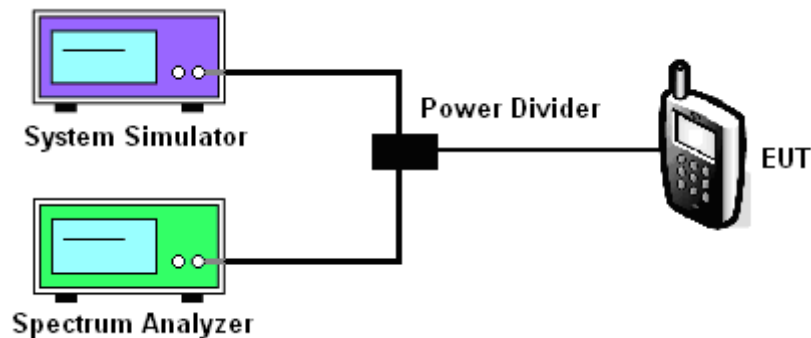

3.4.5 Test Result (Plots) of Conducted Band Edge

Band :	GSM850	Power Stage :	High
Test Mode :	GSM Link	26dB Bandwidth :	0.308MHz
Correction Factor :	0.11dB	Measurement Value :	-17.01dBm
Band Edge :	-16.90dBm		

Lower Band Edge Plot on Channel 128

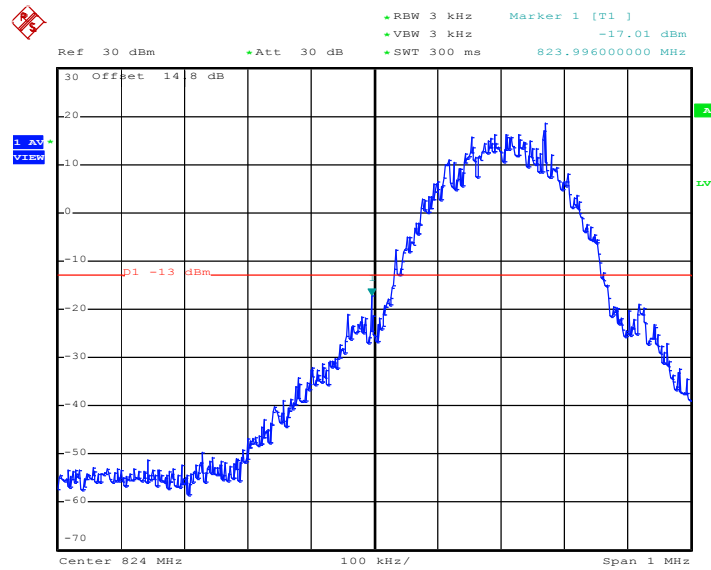

Date: 23.FEB.2012 21:53:47

1. Correction Factor(dB)= 10log(1% Emission BW/RBW)
2. Band Edge= Measurement Value + Correction Factor (dB)



Band :	GSM850	Power Stage :	High
Test Mode :	GSM Link	26dB Bandwidth :	0.308MHz
Correction Factor :	0.11dB	Measurement Value :	-15.17dBm
Band Edge :	-15.06dBm		

Higher Band Edge Plot on Channel 251

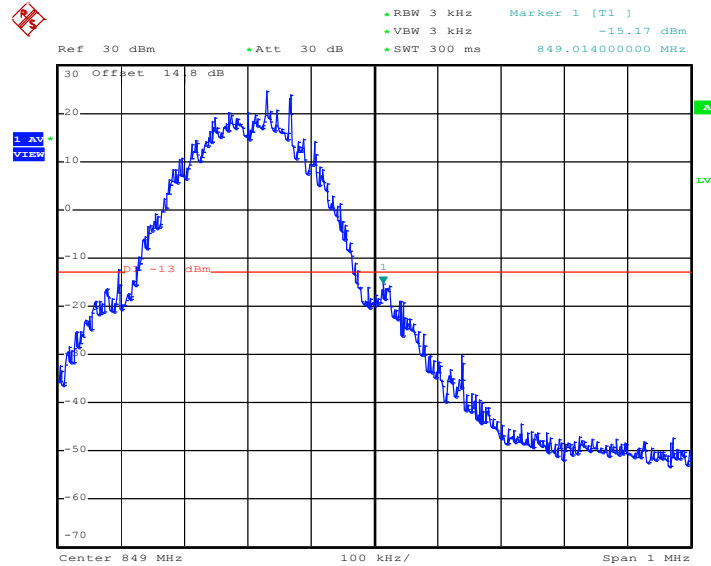

Date: 23.FEB.2012 21:54:14

1. Correction Factor(dB)=  $10\log(1\% \text{ Emission BW/RBW})$
2. Band Edge= Measurement Value + Correction Factor (dB)



Band :	GSM1900	Power Stage :	High
Test Mode :	GPRS 8 Link	26dB Bandwidth :	0.312MHz
Correction Factor :	0.17dB	Measurement Value :	-18.03dBm
Band Edge :	-17.86dBm		

Lower Band Edge Plot on Channel 512

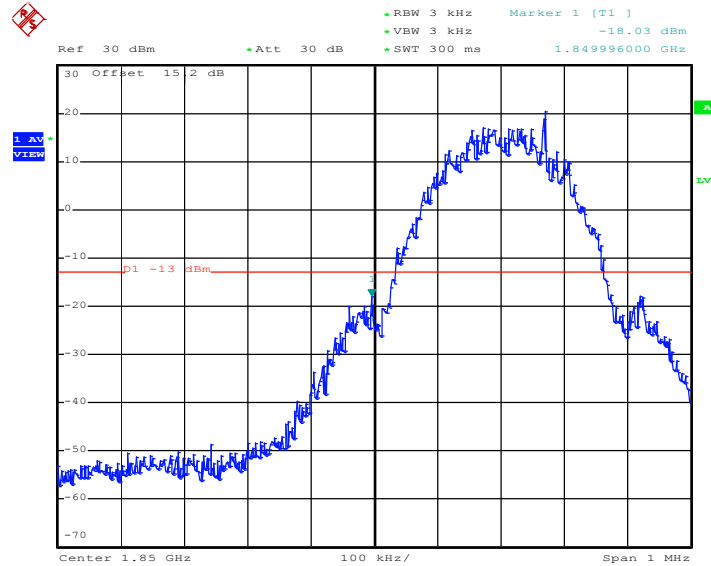

Date: 23.FEB.2012 22:32:59

1. Correction Factor(dB)=  $10\log(1\% \text{ Emission BW/RBW})$
2. Band Edge= Measurement Value + Correction Factor (dB)



Band :	GSM1900	Power Stage :	High
Test Mode :	GPRS 8 Link	26dB Bandwidth :	0.312MHz
Correction Factor :	0.17dB	Measurement Value :	-20.62dBm
Band Edge :	-20.45dBm		

Higher Band Edge Plot on Channel 810

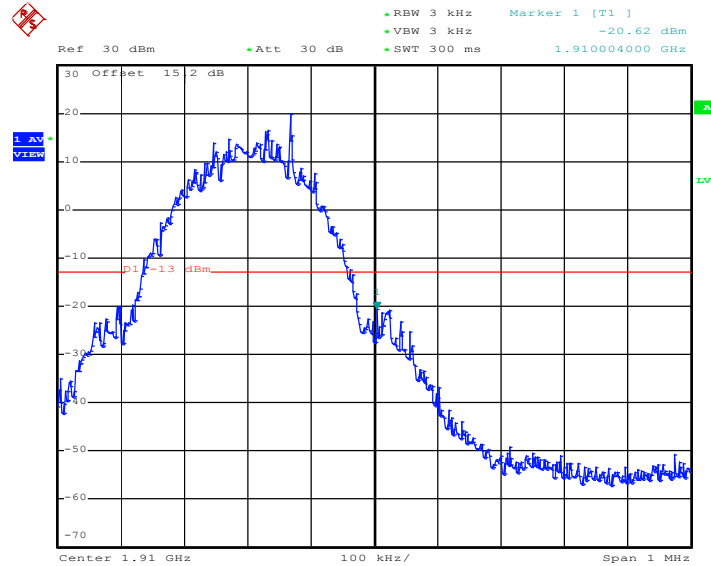

Date: 23.FEB.2012 22:33:25

1. Correction Factor(dB)=  $10\log(1\% \text{ Emission BW/RBW})$
2. Band Edge= Measurement Value + Correction Factor (dB)



Band :	WCDMA Band V	Power Stage :	High
Test Mode :	RMC 12.2Kbps Link	26dB Bandwidth :	4.68MHz
Correction Factor :	-3.30dB	Measurement Value :	-26.78dBm
Band Edge :	-30.08dBm		

Lower Band Edge Plot on Channel 4132

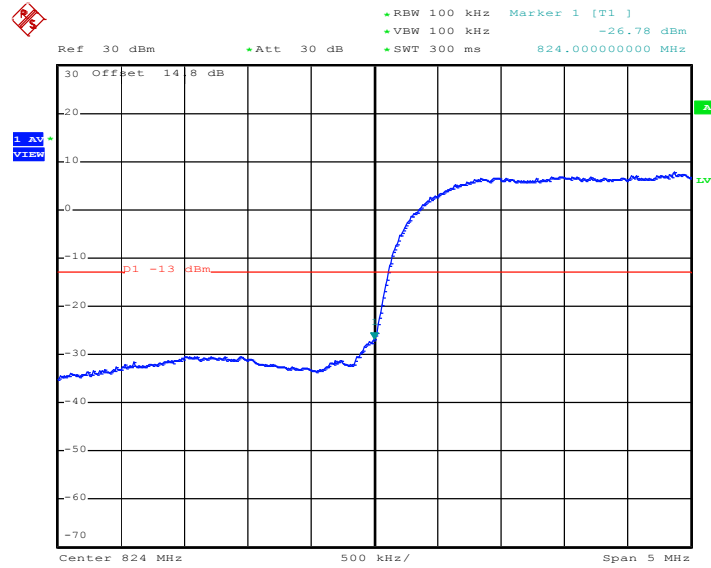

Date: 23.FEB.2012 23:46:38

1. Correction Factor(dB)=  $10\log(1\% \text{ Emission BW/RBW})$
2. Band Edge= Measurement Value + Correction Factor (dB)



Band :	WCDMA Band V	Power Stage :	High
Test Mode :	RMC 12.2Kbps Link	26dB Bandwidth :	4.68MHz
Correction Factor :	-3.30dB	Measurement Value :	-25.82dBm
Band Edge :	-29.12dBm		

Higher Band Edge Plot on Channel 4233

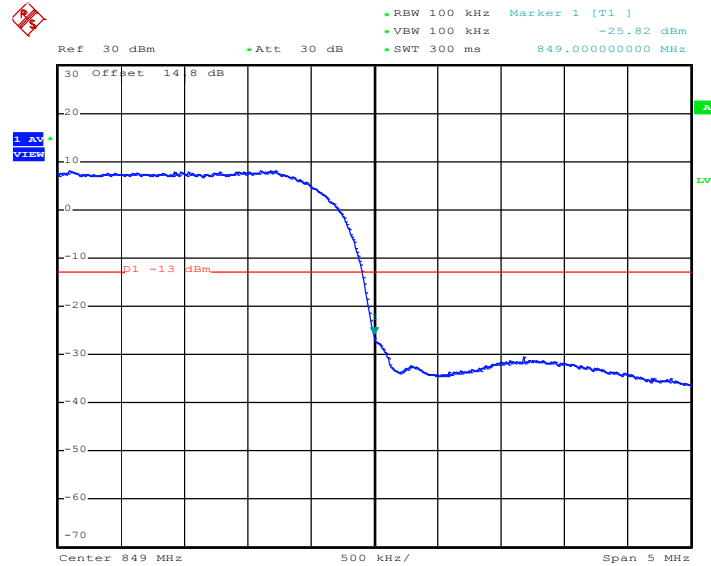

Date: 23.FEB.2012 23:47:04

1. Correction Factor(dB)=  $10\log(1\% \text{ Emission BW/RBW})$
2. Band Edge= Measurement Value + Correction Factor (dB)

## 3.5 Conducted Emission Measurement

### 3.5.1 Description of Conducted Emission Measurement

The power of any emission outside of the authorized operating frequency ranges must be lower than the transmitter power (P) by a factor of at least  $43 + 10 \log (P)$  dB.

It is measured by means of a calibrated spectrum analyzer and scanned from 30 MHz up to a frequency including its 10<sup>th</sup> harmonic.

### 3.5.2 Measuring Instruments

See list of measuring instruments of this test report.

### 3.5.3 Test Procedures

1. The EUT was connected to spectrum analyzer and base station via power divider.
2. The middle channel for the highest RF power within the transmitting frequency was measured.
3. The conducted spurious emission for the whole frequency range was taken.

### 3.5.4 Test Setup

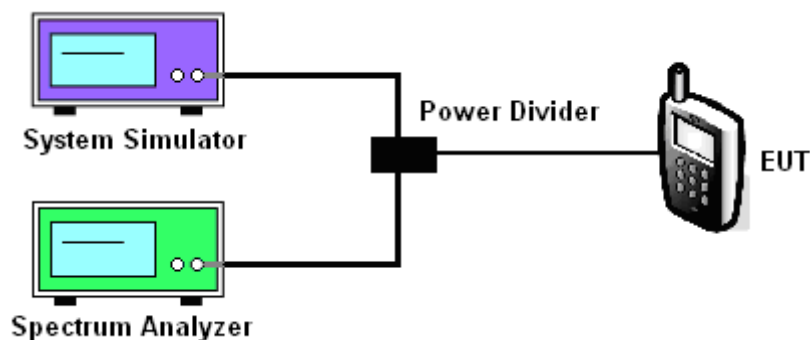



### 3.5.5 Test Result (Plots) of Conducted Emission

Band :	GSM850	Channel :	CH189
Test Mode :	GSM Link		

Conducted Emission Plot between 30MHz ~ 1GHz

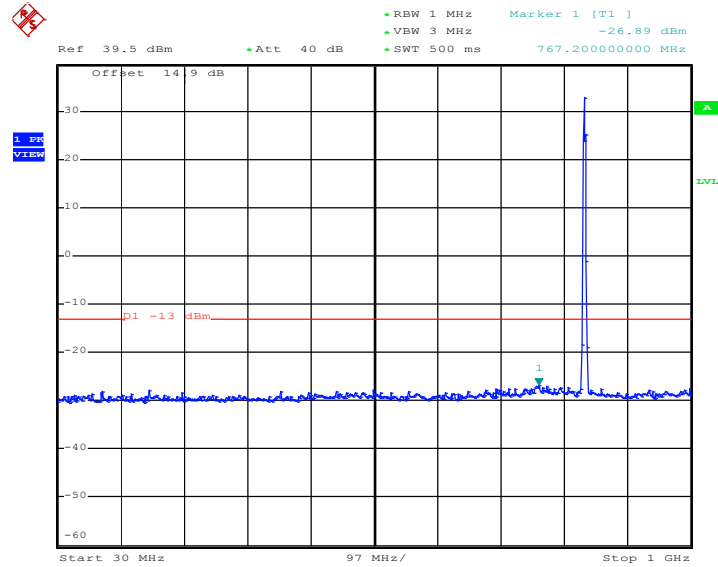

Date: 23.FEB.2012 23:19:02

Conducted Emission Plot between 1GHz ~ 3GHz

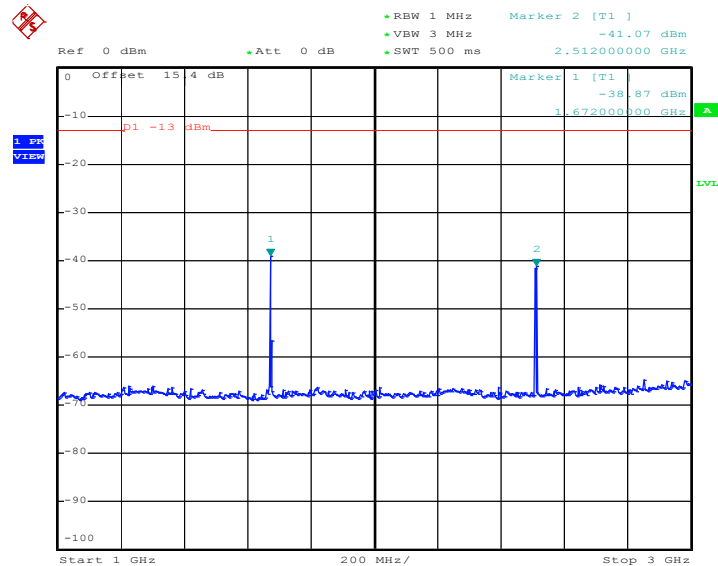

Date: 23.FEB.2012 23:17:46



### Conducted Emission Plot between 3GHz ~ 7GHz

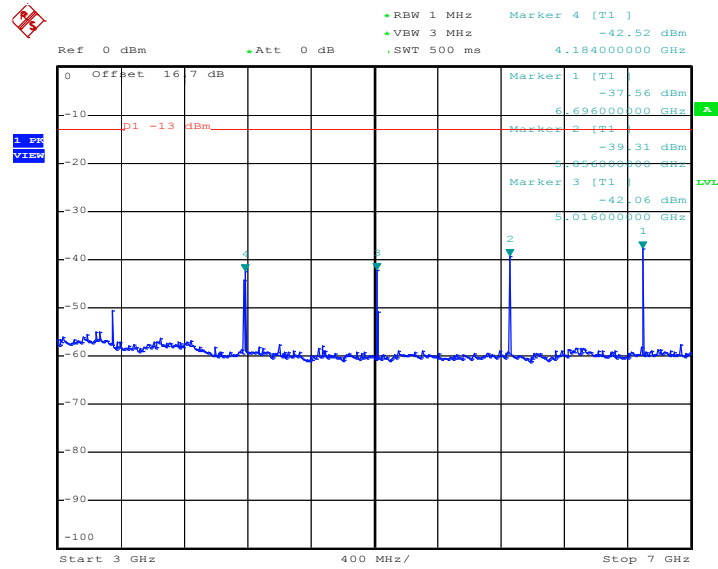

Date: 23.FEB.2012 23:21:30

### Conducted Emission Plot between 7GHz ~ 9GHz

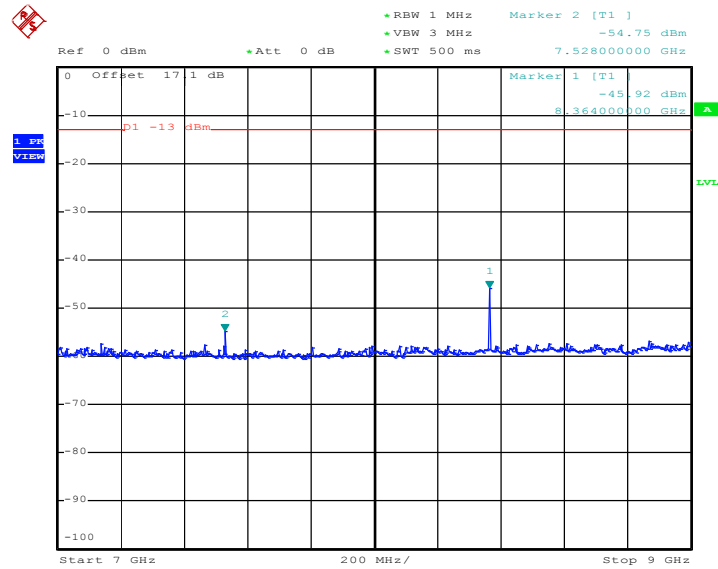

Date: 23.FEB.2012 23:15:09



Band :	GSM1900	Channel :	CH661
Test Mode :	GPRS 8 Link		

Conducted Emission Plot between 30MHz ~ 1GHz

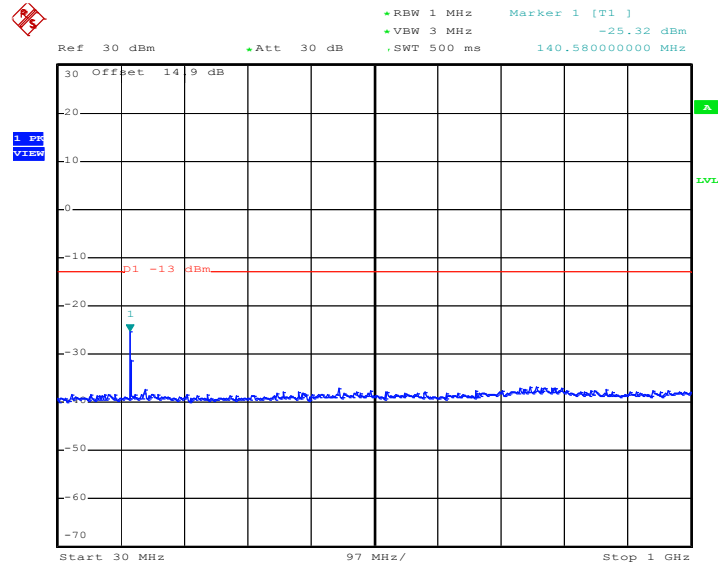

Date: 23.FEB.2012 22:55:01

Conducted Emission Plot between 1GHz ~ 3GHz

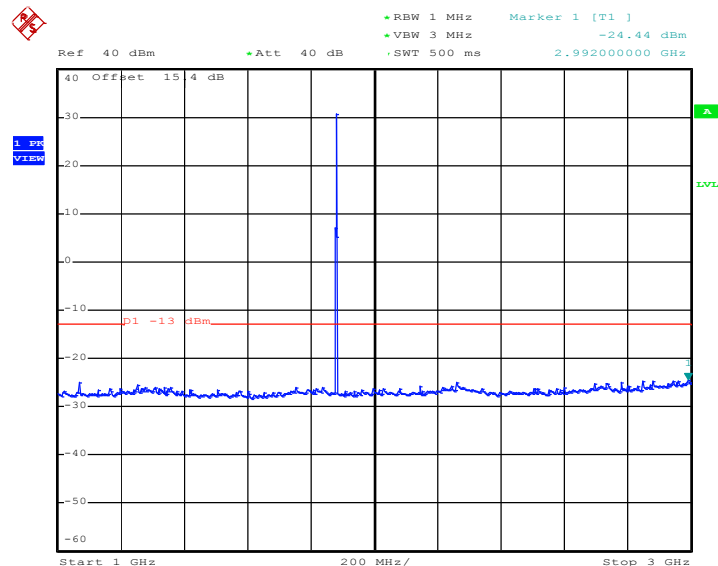

Date: 23.FEB.2012 22:56:28



Conducted Emission Plot between 3GHz ~ 7GHz

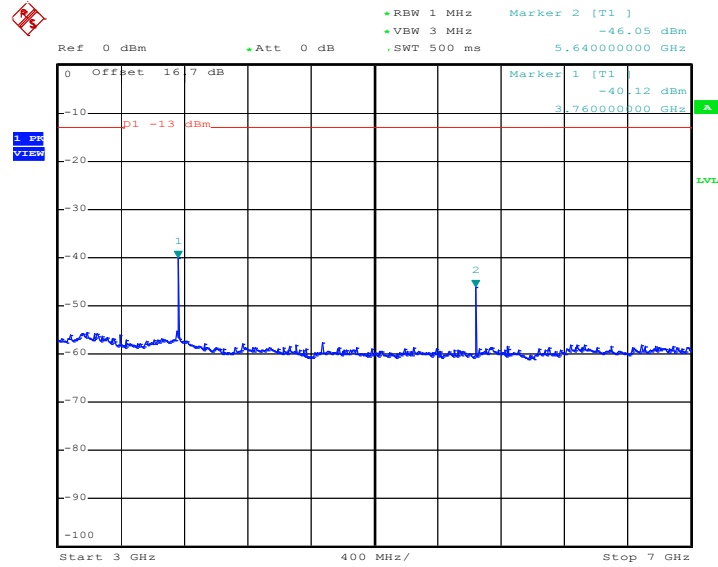

Date: 23.FEB.2012 22:58:29

Conducted Emission Plot between 7GHz ~ 13.6GHz

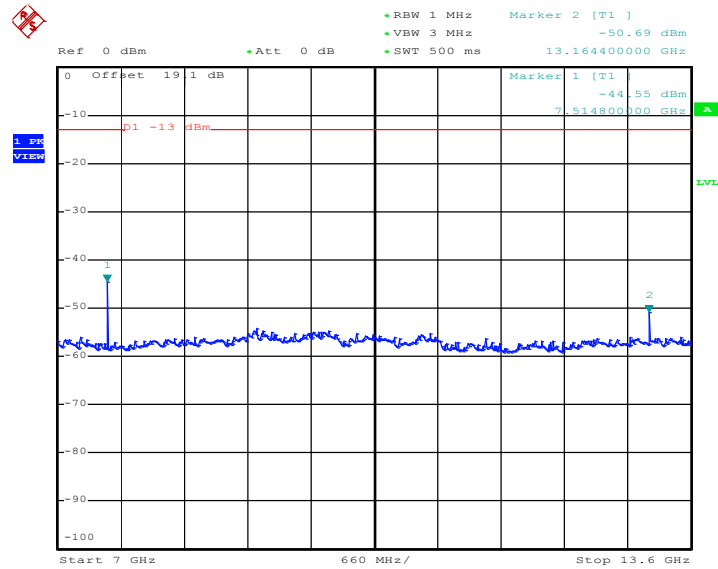

Date: 23.FEB.2012 22:59:12



Conducted Emission Plot between 13.6GHz ~ 19.1GHz

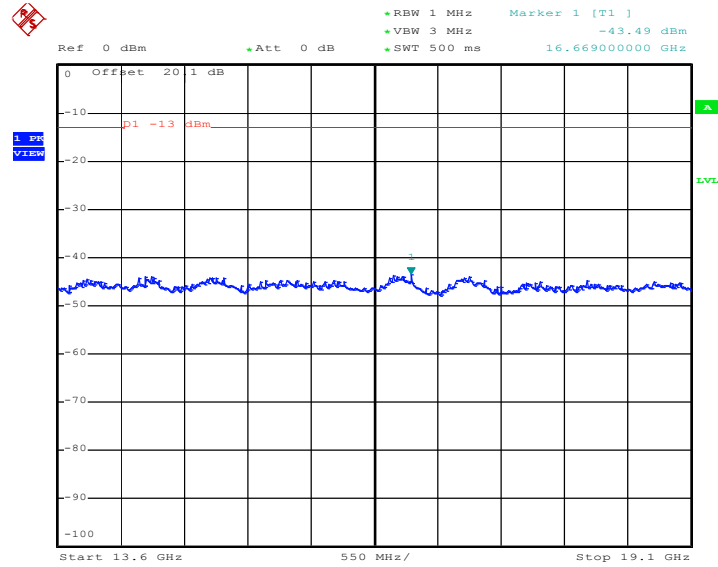

Date: 23.FEB.2012 23:00:12



Band :	WCDMA Band V	Channel :	CH4182
Test Mode :	RMC 12.2Kbps Link		

Conducted Emission Plot between 30MHz ~ 1GHz

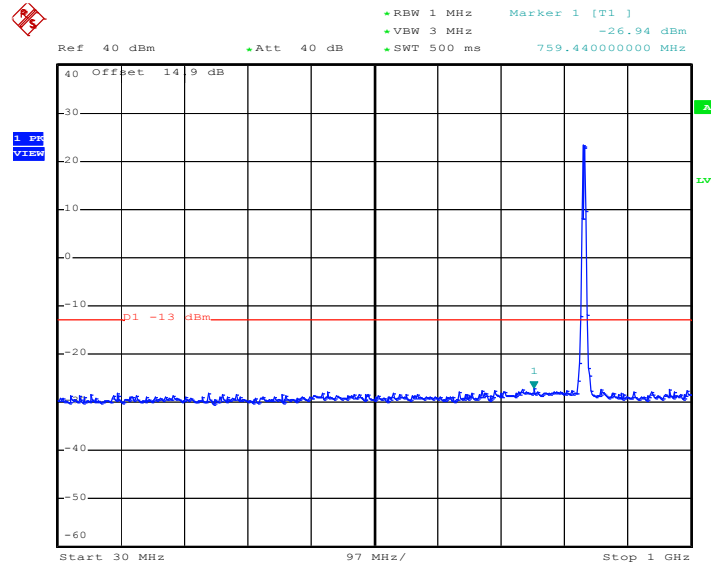

Date: 23.FEB.2012 23:57:46

Conducted Emission Plot between 1GHz ~ 3GHz

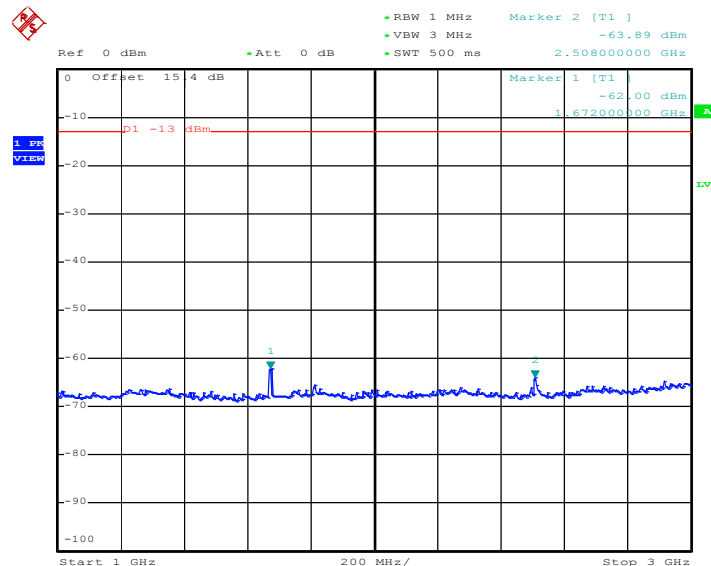

Date: 23.FEB.2012 23:54:18



Conducted Emission Plot between 3GHz ~ 7GHz

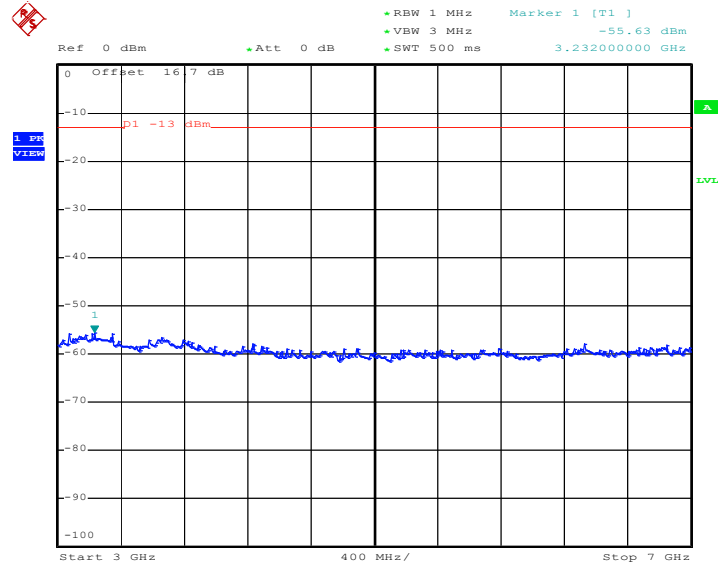

Date: 23.FEB.2012 23:55:04

Conducted Emission Plot between 7GHz ~ 9GHz

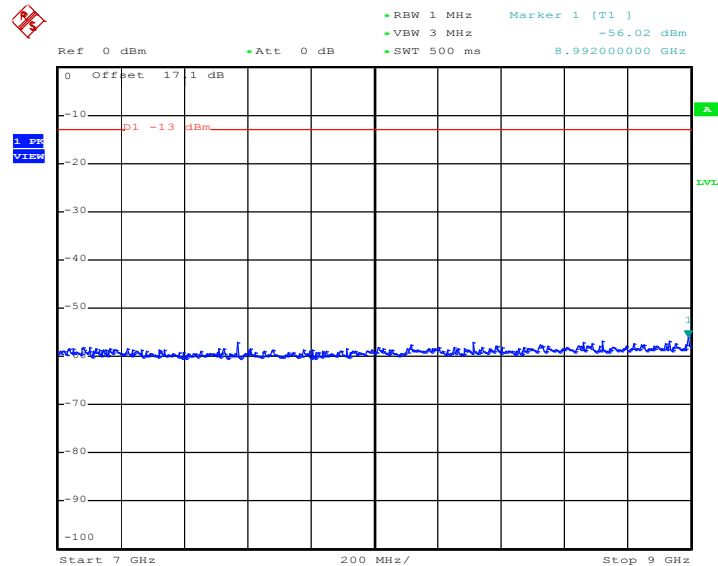

Date: 23.FEB.2012 23:55:49

## 3.6 Field Strength of Spurious Radiation Measurement

### 3.6.1 Description of Field Strength of Spurious Radiated Measurement

The radiated spurious emission was measured by substitution method according to ANSI / TIA / EIA-603-C-2004. The power of any emission outside of the authorized operating frequency ranges must be attenuated below the transmitter power (P) by a factor of at least  $43 + 10 \log (P)$  dB. The spectrum is scanned from 30 MHz up to a frequency including its 10th harmonic.

### 3.6.2 Measuring Instruments

See list of measuring instruments of this test report.

### 3.6.3 Test Procedures

1. The EUT was placed on a rotatable wooden table with 0.8 meter about ground.
2. The EUT was set 3 meters from the receiving antenna, which was mounted on the antenna tower.
3. The table was rotated 360 degrees to determine the position of the highest spurious emission.
4. The height of the receiving antenna is varied between one meter and four meters to search the maximum spurious emission for both horizontal and vertical polarizations.
5. Make the measurement with the spectrum analyzer's RBW = 1MHz, VBW = 3MHz, Sweep = 500ms, Taking the record of maximum spurious emission.
6. A horn antenna was substituted in place of the EUT and was driven by a signal generator.
7. Tune the output power of signal generator to the same emission level with EUT maximum spurious emission.
8. Taking the record of output power at antenna port.
9. Repeat step 7 to step 8 for another polarization.
10.  $EIRP \text{ (dBm)} = S.G. \text{ Power} - Tx \text{ Cable Loss} + Tx \text{ Antenna Gain}$
11.  $ERP \text{ (dBm)} = EIRP - 2.15$

### 3.6.4 Test Setup

For radiated emissions below 30MHz

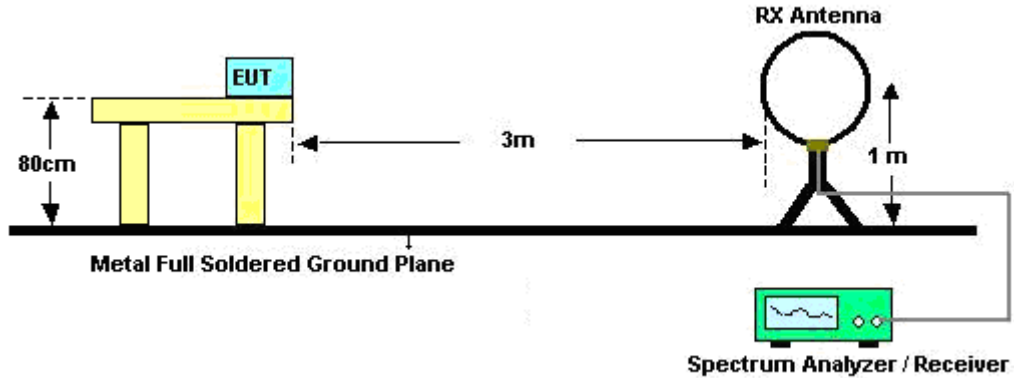

For radiated emissions above 30MHz

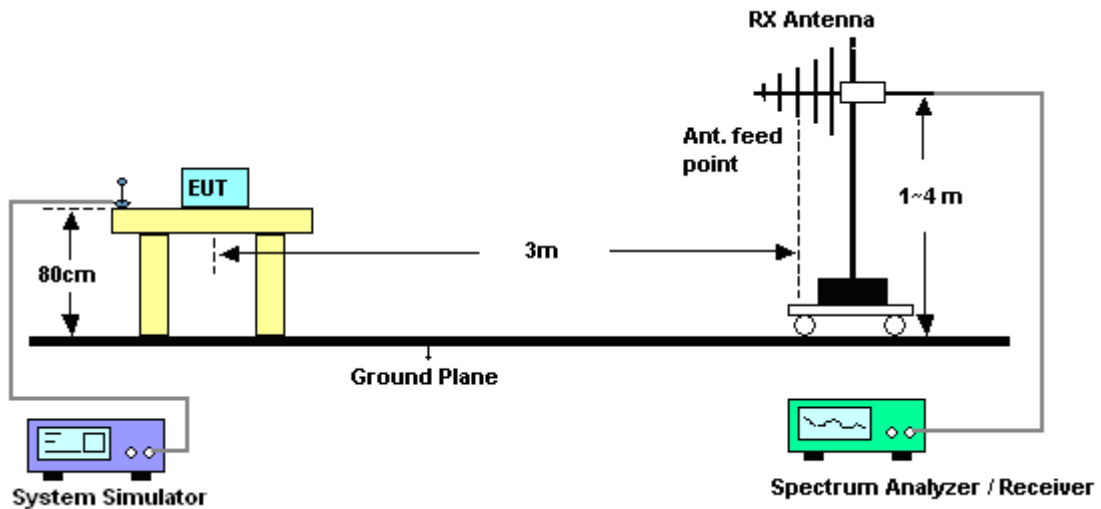

### 3.6.5 Test Results of Radiated Emissions (9 KHz ~ 30 MHz)

The low frequency, which started from 9 KHz to 30MHz, was pre-scanned and the result which was 20dB lower than the limit line per 15.31(o) was not reported.



3.6.6 Test Result of Field Strength of Spurious Radiated

<b>Band :</b>	GSM850	<b>Temperature :</b>	21~22°C
<b>Test Mode :</b>	GSM Link	<b>Relative Humidity :</b>	41~42%
<b>Test Engineer :</b>	Chenmy Cheng	<b>Polarization :</b>	Horizontal
<b>Remark :</b>	Spurious emissions within 30-1000MHz were found more than 20dB below limit line.		

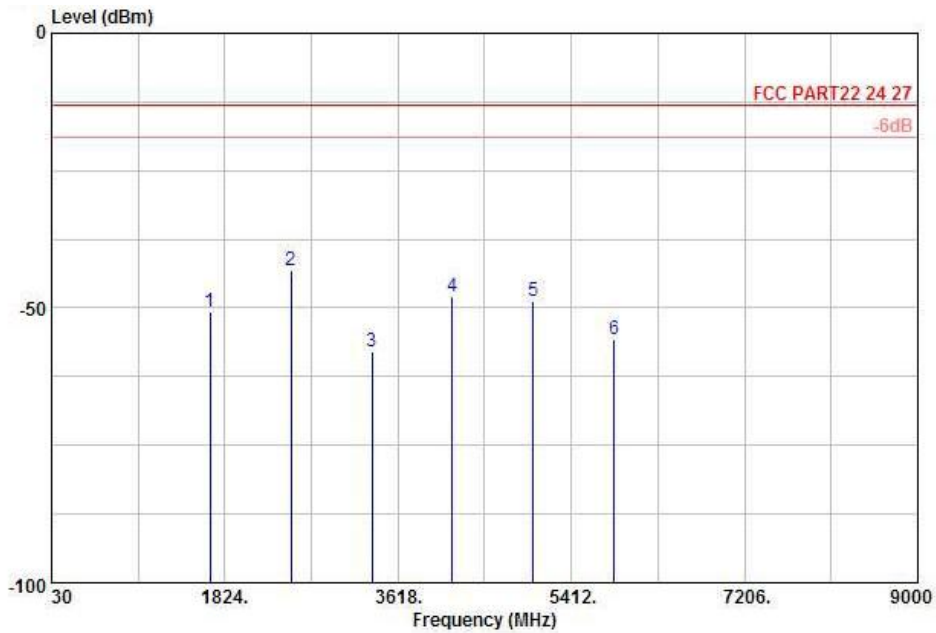

Site : 03CH01-KS  
 Condition: FCC PART22 24 HF EIRP FACTOR-09020 HORIZONTAL  
 Project : (FG) 211239  
 Plan : H

Frequency ( MHz )	ERP ( dBm )	Limit ( dBm )	Over Limit ( dB )	SPA Reading ( dBm )	S.G. Power ( dBm )	TX Cable loss ( dB )	TX Antenna Gain ( dBi )	Polarization ( H/V )	Result
1672	-50.73	-13	-37.73	-49.22	-51.38	0.57	3.37	H	Pass
2510	-43.10	-13	-30.10	-46.77	-45.33	0.78	5.16	H	Pass
3346	-57.91	-13	-44.91	-59.85	-61.55	0.87	6.66	H	Pass
4182	-46.86	-13	-33.86	-50.68	-51.45	0.97	7.71	H	Pass
5018	-48.73	-13	-35.73	-54.93	-54.40	1.09	8.91	H	Pass
5854	-55.66	-13	-42.66	-64.37	-62.10	1.22	9.81	H	Pass



<b>Band :</b>	GSM850	<b>Temperature :</b>	21~22°C
<b>Test Mode :</b>	GSM Link	<b>Relative Humidity :</b>	41~42%
<b>Test Engineer :</b>	Chenmy Cheng	<b>Polarization :</b>	Vertical
<b>Remark :</b>	Spurious emissions within 30-1000MHz were found more than 20dB below limit line.		

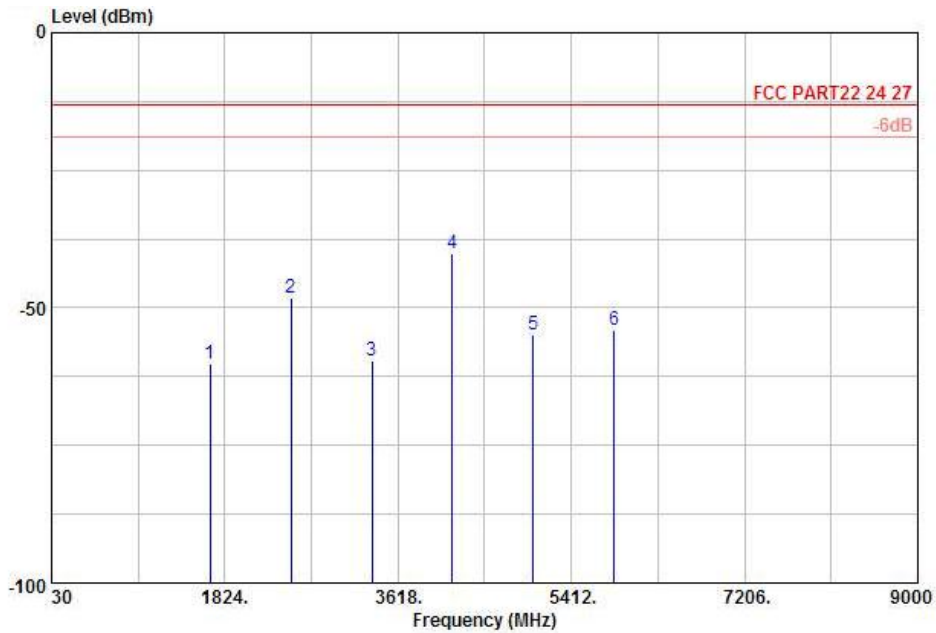

Site : 03CH01-KS  
 Condition: FCC PART22 24 HF EIRP FACTOR-09020 VERTICAL  
 Project : (FG) 211239  
 Plan : H

Frequency ( MHz )	ERP ( dBm )	Limit ( dBm )	Over Limit ( dB )	SPA Reading ( dBm )	S.G. Power ( dBm )	TX Cable loss ( dB )	TX Antenna Gain ( dBi )	Polarization ( H/V )	Result
1672	-60.21	-13	-47.21	-55.86	-60.86	0.57	3.37	V	Pass
2510	-48.21	-13	-35.21	-52.03	-50.44	0.78	5.16	V	Pass
3346	-59.57	-13	-46.57	-61.55	-63.21	0.87	6.66	V	Pass
4182	-40.13	-13	-27.13	-43.97	-44.72	0.97	7.71	V	Pass
5018	-54.86	-13	-41.86	-59.80	-60.53	1.09	8.91	V	Pass
5854	-54.00	-13	-41.00	-61.99	-60.44	1.22	9.81	V	Pass



<b>Band :</b>	GSM1900	<b>Temperature :</b>	21~22°C
<b>Test Mode :</b>	GPRS 8 Link	<b>Relative Humidity :</b>	41~42%
<b>Test Engineer :</b>	Chenmy Cheng	<b>Polarization :</b>	Horizontal
<b>Remark :</b>	Spurious emissions within 30-1000MHz were found more than 20dB below limit line.		

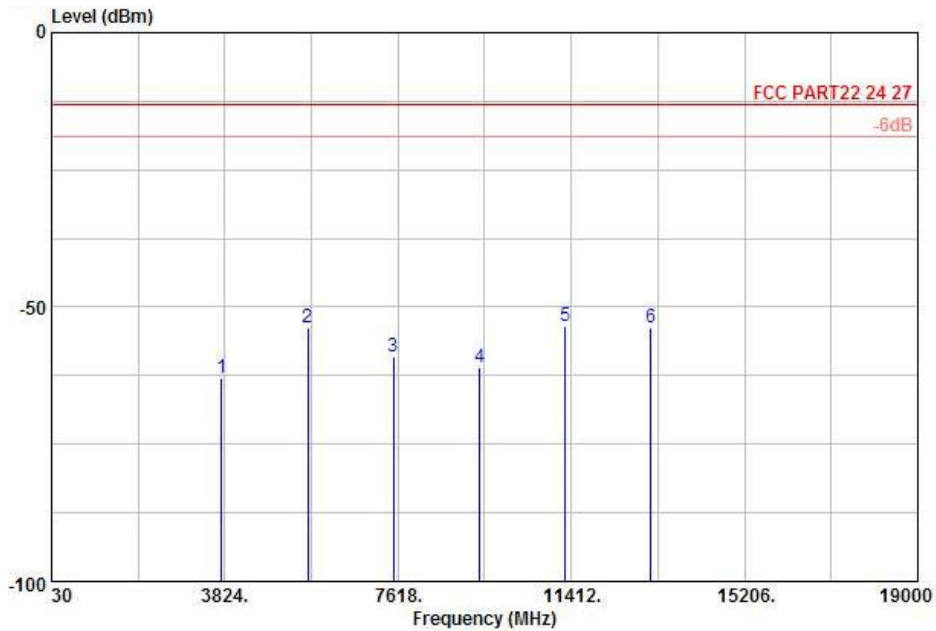

Site : 03CH01-KS  
 Condition: FCC PART22 24 HF EIRP FACTOR-09020 HORIZONTAL  
 Project : (FG) 211239  
 Plan : H

Frequency ( MHz )	EIRP ( dBm )	Limit ( dBm )	Over Limit ( dB )	SPA Reading ( dBm )	S.G. Power ( dBm )	TX Cable loss ( dB )	TX Antenna Gain ( dBi )	Polarization ( H/V )	Result
3760	-62.93	-13	-49.93	-63.90	-69.31	0.78	7.16	H	Pass
5640	-53.89	-13	-40.89	-58.14	-62.43	1.04	9.58	H	Pass
7520	-59.10	-13	-46.10	-64.23	-69.21	1.35	11.46	H	Pass
9400	-60.93	-13	-47.93	-64.19	-71.99	1.75	12.81	H	Pass
11280	-53.57	-13	-40.57	-65.06	-64.66	2	13.09	H	Pass
13160	-53.79	-13	-40.79	-65.09	-65.50	2.04	13.75	H	Pass



<b>Band :</b>	GSM1900	<b>Temperature :</b>	21~22°C
<b>Test Mode :</b>	GPRS 8 Link	<b>Relative Humidity :</b>	41~42%
<b>Test Engineer :</b>	Chenmy Cheng	<b>Polarization :</b>	Vertical
<b>Remark :</b>	Spurious emissions within 30-1000MHz were found more than 20dB below limit line.		

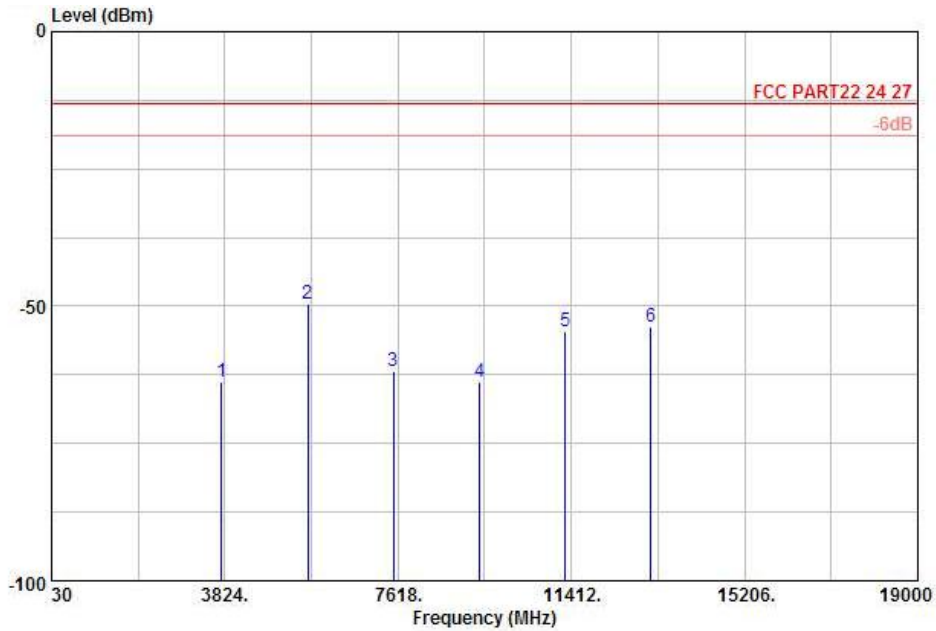

Site : 03CH01-KS  
 Condition: FCC PART22 24 -- HF EIRP FACTOR-09020 VERTICAL  
 Project : (FG) 211239  
 Plan : H

Frequency ( MHz )	EIRP ( dBm )	Limit ( dBm )	Over Limit ( dB )	SPA Reading ( dBm )	S.G. Power ( dBm )	TX Cable loss ( dB )	TX Antenna Gain ( dBi )	Polarization ( H/V )	Result
3760	-63.82	-13	-50.82	-65.19	-70.20	0.78	7.16	V	Pass
5640	-49.67	-13	-36.67	-55.94	-58.21	1.04	9.58	V	Pass
7520	-61.72	-13	-48.72	-66.21	-71.83	1.35	11.46	V	Pass
9400	-63.89	-13	-50.89	-65.11	-74.95	1.75	12.81	V	Pass
11280	-54.65	-13	-41.65	-65.89	-65.74	2	13.09	V	Pass
13160	-53.83	-13	-40.83	-65.02	-65.54	2.04	13.75	V	Pass



<b>Band :</b>	WCDMA Band V	<b>Temperature :</b>	21~22°C
<b>Test Mode :</b>	RMC 12.2Kbps Link	<b>Relative Humidity :</b>	41~42%
<b>Test Engineer :</b>	Chenmy Cheng	<b>Polarization :</b>	Horizontal
<b>Remark :</b>	Spurious emissions within 30-1000MHz were found more than 20dB below limit line.		

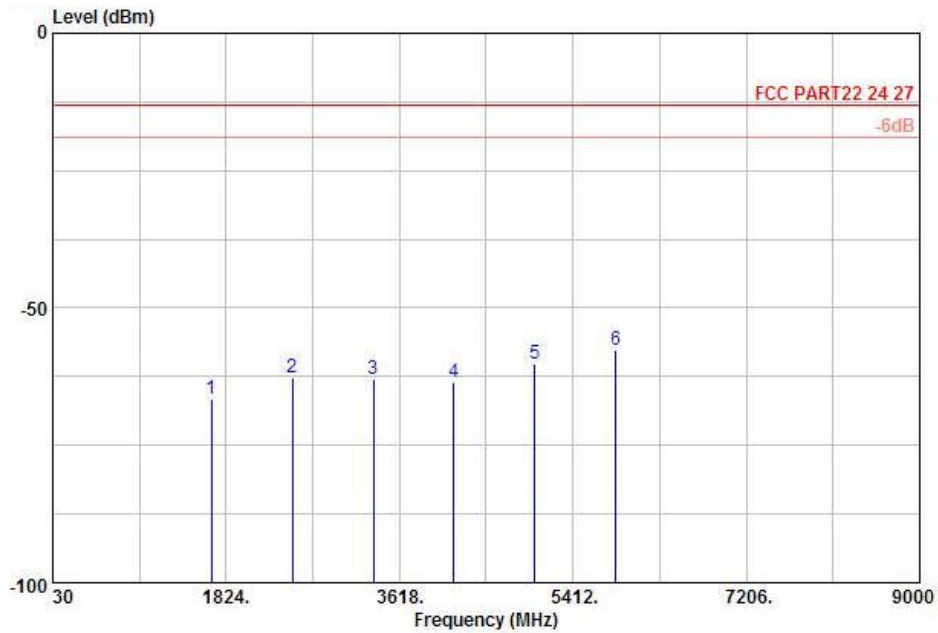

Site : 03CH01-KS  
 Condition: FCC PART22 24 HF EIRP FACTOR-09020 HORIZONTAL  
 Project : (FG) 211239  
 Plan : H

Frequency ( MHz )	ERP ( dBm )	Limit ( dBm )	Over Limit ( dB )	SPA Reading ( dBm )	S.G. Power ( dBm )	TX Cable loss ( dB )	TX Antenna Gain ( dBi )	Polarization ( H/V )	Result
1672	-66.51	-13	-53.51	-62.29	-67.16	0.57	3.37	H	Pass
2509	-62.55	-13	-49.55	-64.80	-64.78	0.78	5.16	H	Pass
3345	-62.95	-13	-49.95	-64.89	-66.59	0.87	6.66	H	Pass
4182	-63.43	-13	-50.43	-66.17	-68.02	0.97	7.71	H	Pass
5018	-60.12	-13	-47.12	-66.32	-65.79	1.09	8.91	H	Pass
5854	-57.74	-13	-44.74	-66.45	-64.18	1.22	9.81	H	Pass



<b>Band :</b>	WCDMA Band V	<b>Temperature :</b>	21~22°C
<b>Test Mode :</b>	RMC 12.2Kbps Link	<b>Relative Humidity :</b>	41~42%
<b>Test Engineer :</b>	Chenmy Cheng	<b>Polarization :</b>	Vertical
<b>Remark :</b>	Spurious emissions within 30-1000MHz were found more than 20dB below limit line.		

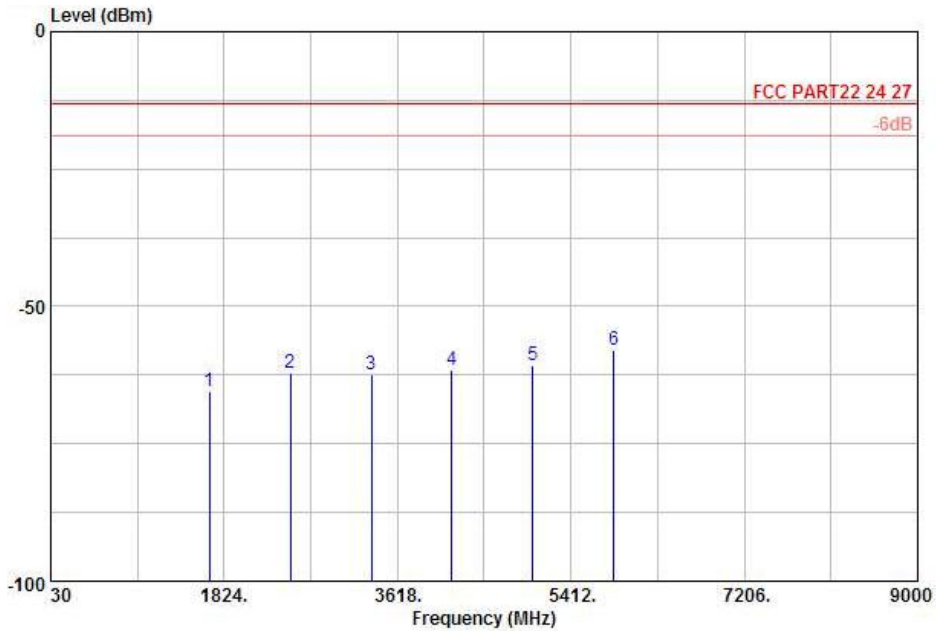

Site : 03CH01-KS  
 Condition: FCC PART22 24 HF EIRP FACTOR-09020 VERTICAL  
 Project : (FG) 211239  
 Plan : H

Frequency ( MHz )	ERP ( dBm )	Limit ( dBm )	Over Limit ( dB )	SPA Reading ( dBm )	S.G. Power ( dBm )	TX Cable loss ( dB )	TX Antenna Gain ( dBi )	Polarization ( H/V )	Result
1672	-65.33	-13	-52.33	-60.98	-65.98	0.57	3.37	V	Pass
2509	-61.99	-13	-48.99	-65.10	-64.22	0.78	5.16	V	Pass
3345	-62.49	-13	-49.49	-64.47	-66.13	0.87	6.66	V	Pass
4182	-61.62	-13	-48.62	-65.46	-66.21	0.97	7.71	V	Pass
5018	-60.68	-13	-47.68	-65.62	-66.35	1.09	8.91	V	Pass
5854	-57.85	-13	-44.85	-65.84	-64.29	1.22	9.81	V	Pass

## 3.7 Frequency Stability Measurement

### 3.7.1 Description of Frequency Stability Measurement

The frequency stability shall be measured by variation of ambient temperature and variation of primary supply voltage to ensure that the fundamental emission stays within the authorized frequency block. The frequency stability of the transmitter shall be maintained within  $\pm 0.00025\%$  ( $\pm 2.5\text{ppm}$ ) of the center frequency.

### 3.7.2 Measuring Instruments

See list of measuring instruments of this test report.

### 3.7.3 Test Procedures for Temperature Variation

1. The EUT was set up in the thermal chamber and connected with the base station.
2. With power OFF, the temperature was decreased to  $-30^{\circ}\text{C}$  and the EUT was stabilized for three hours. Power was applied and the maximum change in frequency was recorded within one minute.
3. With power OFF, the temperature was raised in  $10^{\circ}\text{C}$  step up to  $50^{\circ}\text{C}$ . The EUT was stabilized at each step for at least half an hour. Power was applied and the maximum frequency change was recorded within one minute.
4. If the EUT cannot be turned on at  $-30^{\circ}\text{C}$ , the testing lowest temperature will be raised in  $10^{\circ}\text{C}$  step until the EUT can be turned on.

### 3.7.4 Test Procedures for Voltage Variation

1. The EUT was placed in a temperature chamber at  $25\pm 5^{\circ}\text{C}$  and connected with the base station.
2. The power supply voltage to the EUT was varied from BEP to 115% of the nominal value measured at the input to the EUT.
3. The variation in frequency was measured for the worst case.

### 3.7.5 Test Setup

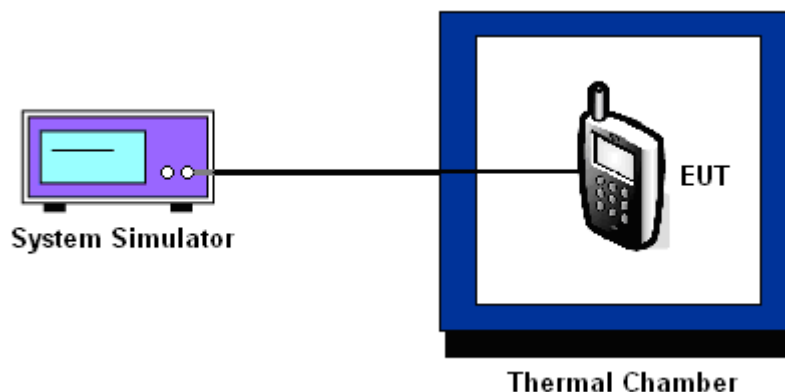

### 3.7.6 Test Result of Temperature Variation

Band :	GSM 850	Channel :	189
Limit (ppm) :	2.5		

Temperature (°C)	GSM		Result
	Freq. Dev. (Hz)	Deviation (ppm)	
-30	N/A	N/A	PASS
-20	N/A	N/A	
-10	-31	-0.04	
0	-36	-0.04	
10	-34	-0.04	
20	-34	-0.04	
30	-32	-0.04	
40	-36	-0.04	
50	-31	-0.04	
55	-33	-0.04	

**Note:** The manufacturer declared that the EUT could work properly between temperatures -10°C~55°C.



Band :	GSM 1900	Channel :	661
Limit (ppm) :	2.5		

Temperature (°C)	GPRS 8		Result
	Freq. Dev. (Hz)	Deviation (ppm)	
-30	N/A	N/A	PASS
-20	N/A	N/A	
-10	-61	-0.03	
0	-54	-0.03	
10	-59	-0.03	
20	-56	-0.03	
30	-61	-0.03	
40	-63	-0.03	
50	-57	-0.03	
55	-62	-0.03	

**Note:** The manufacturer declared that the EUT could work properly between temperatures -10°C~55°C.



Band :	WCDMA Band V	Channel :	4182
Limit (ppm) :	2.5		

Temperature (°C)	RMC 12.2Kbps		Result
	Freq. Dev. (Hz)	Deviation (ppm)	
-30	N/A	N/A	PASS
-20	N/A	N/A	
-10	-10	-0.01	
0	-9	-0.01	
10	12	0.01	
20	9	0.01	
30	12	0.01	
40	-14	-0.02	
50	-11	-0.01	
55	-15	-0.02	

**Note:** The manufacturer declared that the EUT could work properly between temperatures -10°C~55°C.

### 3.7.7 Test Result of Voltage Variation

Band & Channel	Mode	Voltage (Volt)	Freq. Dev. (Hz)	Deviation (ppm)	Limit (ppm)	Result
GSM 850 CH189	GSM	3.8	-38	-0.04	2.5	PASS
		BEP	-35	-0.04		
		4.2	-46	-0.05		
GSM 1900 CH661	GPRS 8	3.8	-63	-0.03		
		BEP	-67	-0.04		
		4.2	-60	-0.03		
WCDMA Band V CH4182	RMC 12.2Kbps	3.8	13	0.02		
		BEP	18	0.02		
		4.2	-14	-0.02		

**Note:**

1. Normal Voltage = 3.8V.
2. Battery End Point (BEP) = 3.5 V.



## 4 List of Measuring Equipment

Instrument	Manufacturer	Model No.	Serial No.	Characteristics	Calibration Date	Test Date	Due Date	Remark
Spectrum Analyzer	R&S	FSP40	100319	9kHz~40GHz	Dec. 30, 2011	Feb. 23, 2012	Dec. 29, 2012	Conducted (TH01-KS)
DC Power Supply	TOPWARD	GPS-3030D	E1884515	N/A	Aug. 23, 2011	Feb. 23, 2012	Aug. 22, 2012	Conducted (TH01-KS)
System Simulator	R&S	CMU200	837587/066	GSM/GPRS850/900/1800/1900,	Dec. 30, 2011	Feb. 23, 2012	Dec. 29, 2012	Conducted (TH01-KS)
EMI Test Receiver	R&S	ESCI	100534	9kHz~3GHz	Nov. 09, 2011	Feb. 23, 2012	Nov. 08, 2012	Radiation (03CH01-KS)
Spectrum Analyzer	R&S	FSP40	100319	9kHz~40GHz	Dec. 30, 2011	Feb. 23, 2012	Dec. 29, 2012	Radiation (03CH01-KS)
Spectrum Analyzer	R&S	FSP30	101400	9kHz~30GHz	Jun. 02, 2011	Feb. 23, 2012	Jun. 01, 2012	Radiation (03CH01-KS)
Bilog Antenna	SCHAFFNER	CBL6112D	23182	25MHz~2GHz	Dec. 08, 2011	Feb. 23, 2012	Dec. 07, 2012	Radiation (03CH01-KS)
Double Ridge Horn Antenna	EMCO	3117	00075959	1GHz~18GHz	Jan. 06, 2012	Feb. 23, 2012	Jan. 05, 2013	Radiation (03CH01-KS)
Amplifier	Wireless	FPA-6592G	060029	9KHz~2GHz	Jan. 06, 2012	Feb. 23, 2012	Jan. 05, 2013	Radiation (03CH01-KS)
Amplifier	Wireless	FPA-6592G	060004	30MHz~2GHz	Dec. 30, 2011	Feb. 23, 2012	Dec. 29, 2012	Radiation (03CH01-KS)
Amplifier	Agilent	8449B	3008A02370	1GHz~26.5GHz	Dec. 30, 2011	Feb. 23, 2012	Dec. 29, 2012	Radiation (03CH01-KS)
Active Horn Antenna	com-power	AHA-118	701023	1G-18GHz	Nov. 07, 2011	Feb. 23, 2012	Nov. 06, 2012	Radiation (03CH01-KS)
SHF-EHF Horn	Schwarzbeck	BBHA 9170	BBHA170249	15-40GHz	Oct. 11, 2011	Feb. 23, 2012	Oct. 10, 2012	Radiation (03CH01-KS)
Loop Antenna	R&S	HFH2-Z2	860004/001	9 kHz~30 MHz	Jul. 29, 2010	Feb. 23, 2012	Jul. 28, 2012	Radiation (03CH01-KS)
System Simulator	R&S	CMU200	837587/066	GSM/GPRS850/900/1800/1900,	Dec. 30, 2011	Feb. 23, 2012	Dec. 29, 2012	Radiation (03CH01-KS)

## 5 Uncertainty of Evaluation

### Uncertainty of Radiated Emission Measurement (30 MHz ~ 1000 MHz)

Contribution	Uncertainty of $X_i$		$u(X_i)$
	dB	Probability Distribution	
Receiver Reading	0.41	Normal (k=2)	0.21
Antenna Factor Calibration	0.83	Normal (k=2)	0.42
Cable Loss Calibration	0.25	Normal (k=2)	0.13
Pre-Amplifier Gain Calibration	0.27	Normal (k=2)	0.14
RCV/SPA Specification	2.50	Rectangular	0.72
Antenna Factor Interpolation for Frequency	1.00	Rectangular	0.29
Site Imperfection	1.43	Rectangular	0.83
Mismatch	+0.39 / -0.41	U-Shape	0.28
<b>Combined Standard Uncertainty <math>U_c(y)</math></b>	<b>1.27</b>		
<b>Measuring Uncertainty for a Level of Confidence of 95% (<math>U = 2U_c(y)</math>)</b>	<b>2.54</b>		

### Uncertainty of Radiated Emission Measurement (1 GHz ~ 40 GHz)

Contribution	Uncertainty of $X_i$		$u(X_i)$	$C_i$	$C_i * u(X_i)$
	dB	Probability Distribution			
Receiver Reading	$\pm 0.10$	Normal (k=2)	0.10	1	0.10
Antenna Factor Calibration	$\pm 1.70$	Normal (k=2)	0.85	1	0.85
Cable Loss Calibration	$\pm 0.50$	Normal (k=2)	0.25	1	0.25
Receiver Correction	$\pm 2.00$	Rectangular	1.15	1	1.15
Antenna Factor Directional	$\pm 1.50$	Rectangular	0.87	1	0.87
Site Imperfection	$\pm 2.80$	Triangular	1.14	1	1.14
Mismatch Receiver VSWR $\Gamma_1 = 0.197$ Antenna VSWR $\Gamma_2 = 0.194$ Uncertainty = $20\text{Log}(1-\Gamma_1*\Gamma_2)$	+0.34 / -0.35	U-Shape	0.244	1	0.244
<b>Combined Standard Uncertainty <math>U_c(y)</math></b>	<b>2.36</b>				
<b>Measuring Uncertainty for a Level of Confidence of 95% (<math>U = 2U_c(y)</math>)</b>	<b>4.72</b>				