

FCC RF Test Report

APPLICANT : Motorola Mobility, Inc.
EQUIPMENT : GSM / EGPRS Mobile Phone
BRAND NAME : Motorola
MODEL NAME : EX440
MARKETING NAME : MOTOGO!™ TV
GPPD NUMBER : 3347
FCC ID : IHDT56NE5
STANDARD : FCC 47 CFR Part 2, 22(H), 24(E)
CLASSIFICATION : PCS Licensed Transmitter Held to Ear (PCE)
TX/RX FREQUENCY RANGE : GSM850 : 824.2 ~ 848.8 MHz /
869.2 ~ 893.8 MHz
GSM1900 : 1850.2 ~ 1909.8 MHz /
1930.2 ~ 1989.8 MHz
MAX. ERP/EIRP POWER : GSM850 (GPRS 8) : 1.0617 W
GSM1900 (GSM) : 1.4997 W

The product was received on Apr. 10, 2012 and completely tested on Apr. 17, 2012. We, SPORTON INTERNATIONAL (KUNSHAN) INC., would like to declare that the tested sample has been evaluated in accordance with the procedures given in ANSI / TIA / EIA-603-C-2004 and shown compliance with the applicable technical standards.

The test results in this report apply exclusively to the tested model / sample. Without written approval of SPORTON INTERNATIONAL (KUNSHAN) INC., the test report shall not be reproduced except in full.

Reviewed by:



Jones Tsai / Manager



SPORTON INTERNATIONAL (KUNSHAN) INC.
No. 3-2, PingXiang Road, Kunshan, Jiangsu Province, P.R.C.



TABLE OF CONTENTS

REVISION HISTORY.....	3
SUMMARY OF TEST RESULT	4
1 GENERAL DESCRIPTION	5
1.1 Applicant.....	5
1.2 Manufacturer	5
1.3 Feature of Equipment Under Test.....	5
1.4 Emission Designator and Maximum ERP/EIRP Power	6
1.5 Testing Site	6
1.6 Applied Standards	6
1.7 Ancillary Equipment List.....	7
2 TEST CONFIGURATION OF EQUIPMENT UNDER TEST	8
2.1 Test Mode.....	8
2.2 Connection Diagram of Test System	9
3 TEST RESULT.....	10
3.1 Conducted Output Power Measurement.....	10
3.2 Effective Radiated Power and Effective Isotropic Radiated Power Measurement	12
3.3 Occupied Bandwidth Measurement	15
3.4 Band Edge Measurement.....	22
3.5 Conducted Emission Measurement	27
3.6 Field Strength of Spurious Radiation Measurement	33
3.7 Frequency Stability Measurement.....	39
4 LIST OF MEASURING EQUIPMENT	42
5 UNCERTAINTY OF EVALUATION	43



SUMMARY OF TEST RESULT

Report Section	FCC Rule	IC Rule	Description	Limit	Result	Remark
3.1	§2.1046	N/A	Conducted Output Power	N/A	PASS	-
3.2	§22.913(a)(2)	RSS-132(4.4) SRSP-503(5.1.3)	Effective Radiated Power	< 7 Watts	PASS	-
3.2	§24.232(c)	RSS-133 (6.4) SRSP-510(5.1.2)	Equivalent Isotropic Radiated Power	< 2 Watts	PASS	-
3.3	§2.1049 §22.917(a) §24.238(a)	N/A	Occupied Bandwidth	N/A	PASS	-
3.4	§2.1051 §22.917(a) §24.238(a)	RSS-132 (4.5.1) RSS-133 (6.5.1)	Band Edge Measurement	< 43+10log ₁₀ (P[Watts])	PASS	-
3.5	§2.1051 §22.917(a) §24.238(a)	RSS-132 (4.5.1) RSS-133 (6.5.1)	Conducted Emission	< 43+10log ₁₀ (P[Watts])	PASS	-
3.6	§2.1053 §22.917(a) §24.238(a)	RSS-132 (4.5.1) RSS-133 (6.5.1)	Field Strength of Spurious Radiation	< 43+10log ₁₀ (P[Watts])	PASS	Under limit 21.87 dB at 2510.000 MHz
3.7	§2.1055 §22.355 §24.235	RSS-132(4.3) RSS-133(6.3)	Frequency Stability for Temperature & Voltage	< 2.5 ppm	PASS	-

1 General Description

1.1 Applicant

Motorola Mobility, Inc.
8F., No. 9, Songgao Rd., Taipei 110, Taiwan

1.2 Manufacturer

Arima Communications Corp.
6F., No. 866, Jhongjheng Rd., Jhonghe Dist., New Taipei City 23586, Taiwan

1.3 Feature of Equipment Under Test

Product Feature & Specification	
Equipment	GSM / EGPRS Mobile Phone
Brand Name	Motorola
Model Name	EX440
Marketing Name	MOTOGO! TM TV
FCC ID	IHDT56NE5
Tx Frequency	GSM850 : 824 MHz ~ 849 MHz GSM1900 : 1850 MHz ~ 1910 MHz
Rx Frequency	GSM850 : 869 MHz ~ 894 MHz GSM1900 : 1930 MHz ~ 1990 MHz
Maximum Output Power to Antenna	GSM850 : 32.95 dBm GSM1900 : 30.02 dBm
Antenna Type	IFA Antenna
HW Version	PCR
SW Version	SILVTV_G_07.13.00RDD
Type of Modulation	GSM: GMSK GPRS: GMSK EDGE: GMSK / 8PSK (Downlink Only)
EUT Stage	Identical Prototype

Remark:

1. The above EUT's information was declared by manufacturer. Please refer to the specifications or user's manual for more detailed description.
2. For EDGE mode, EUT only supports receiver mode (Downlink) without transmitter mode.

1.4 Emission Designator and Maximum ERP/EIRP Power

FCC Rule	System	Type of Modulation	Emission Designator	Maximum ERP/EIRP
Part 22	GSM850 GPRS 8	GMSK	250KGXW	1.0617 W
Part 24	GSM1900 GSM	GMSK	250KGXW	1.4997 W

1.5 Testing Site

Test Site	SPORTON INTERNATIONAL (KUNSHAN) INC.		
Test Site Location	No. 3-2, PingXiang Road, Kunshan, Jiangsu Province, P.R.C. TEL: +86-0512-5790-0158 FAX: +86-0512-5790-0958		
Test Site No.	Sporton Site No.		FCC/IC Registration No.
	TH01-KS	03CH01-KS	149928/4086E-1

1.6 Applied Standards

According to the specifications of the manufacturer, the EUT must comply with the requirements of the following standards:

- FCC 47 CFR Part 2, 22(H), 24(E)
- ANSI / TIA / EIA-603-C-2004
- FCC KDB 971168 D01 Power Meas. License Digital Systems v01
- IC RSS-132 Issue 2
- IC RSS-133 Issue 5

Remark:

1. All test items were verified and recorded according to the standards and without any deviation during the test.
2. This EUT has also been tested and complied with the requirements of FCC Part 15, Subpart B, recorded in a separate test report.



1.7 Ancillary Equipment List

Item	Equipment	Trade Name	Model No.	FCC ID	Data Cable	Power Cord
1.	System Simulator	R&S	CMU200	N/A	N/A	Unshielded, 1.8 m
2.	DC Power Supply	GW	GPS-30300	N/A	N/A	Unshielded, 1.8 m

2 Test Configuration of Equipment Under Test

2.1 Test Mode

During all testing, EUT is in link mode with base station emulator at maximum power level. The spurious emission measurements were carried out in semi-anechoic chamber with 3-meter test range, and EUT is rotated on three test planes to find out the worst emission.

Frequency range investigated for radiated emission is as follows:

1. 30 MHz to 9000 MHz for GSM850.
2. 30 MHz to 19000 MHz for GSM1900.

Test Modes		
Band	Radiated TCs	Conducted TCs
GSM 850	■ GPRS 8 Link	■ GPRS 8 Link
GSM 1900	■ GSM Link	■ GSM Link

Note:

1. The maximum power levels are GPRS multi-slot class 8 mode for GSM 850 GMSK link, and GSM mode for GSM 1900 GMSK link, only these modes were used for all tests.
2. Because there are individual antennas for each WWAN, WLAN, and Bluetooth, the co-location test modes are not required.

The conducted power tables are as follows:

Conducted Power (*Unit: dBm)						
Band	GSM850			GSM1900		
Channel	128	189	251	512	661	810
Frequency	824.2	836.4	848.8	1850.2	1880.0	1909.8
GSM	32.94	32.94	32.94	29.99	30.00	30.02
GPRS 8	32.94	32.95	32.94	29.97	29.99	30.01
GPRS 10	29.41	29.39	29.43	27.66	27.68	27.73

2.2 Connection Diagram of Test System

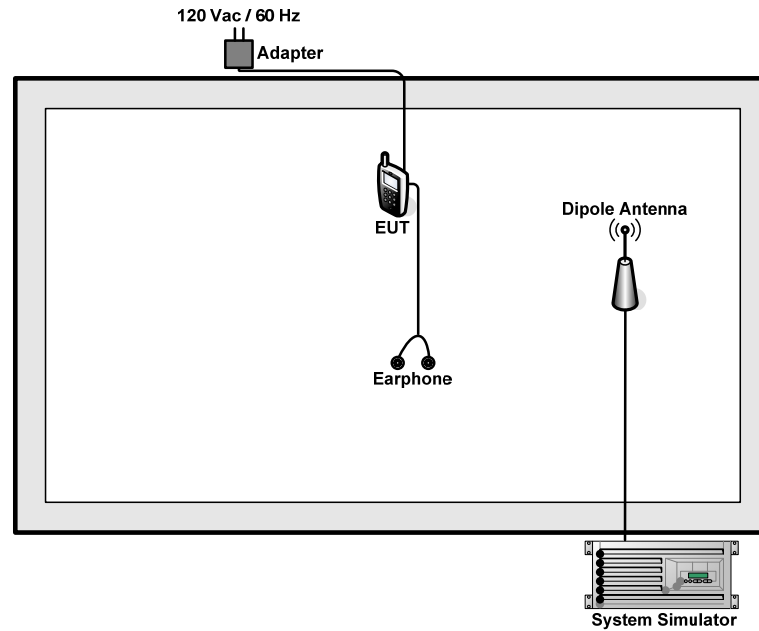

3 Test Result

3.1 Conducted Output Power Measurement

3.1.1 Description of the Conducted Output Power Measurement

The substitution method, in ANSI / TIA / EIA-603-C-2004, was used for ERP/EIRP measurement, and the spectrum analyzer configuration follows KDB 971168 D01 Power Meas. License Digital Systems v01. The ERP of mobile transmitters must not exceed 7 Watts and the EIRP of mobile transmitters are limited to 2 Watts.

3.1.2 Measuring Instruments

See list of measuring instruments of this test report.

3.1.3 Test Procedures

1. The transmitter output port was connected to base station.
2. Set EUT at maximum power through base station.
3. Select lowest, middle, and highest channels for each band and different modulation.

3.1.4 Test Setup

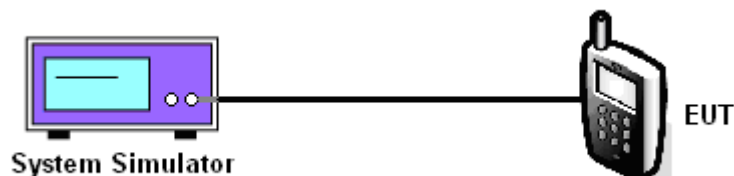



3.1.5 Test Result of Conducted Output Power

Cellular Band			
Modes	GSM850 (GPRS 8)		
Channel	128 (Low)	189 (Mid)	251 (High)
Frequency (MHz)	824.2	836.4	848.8
Conducted Power (dBm)	32.94	32.95	32.94
Conducted Power (Watts)	1.97	1.97	1.97

PCS Band			
Modes	GSM1900 (GSM)		
Channel	512 (Low)	661 (Mid)	810 (High)
Frequency (MHz)	1850.2	1880	1909.8
Conducted Power (dBm)	29.99	30.00	30.02
Conducted Power (Watts)	1.00	1.00	1.00

3.2 Effective Radiated Power and Effective Isotropic Radiated Power Measurement

3.2.1 Description of the ERP/EIRP Measurement

The substitution method, in ANSI / TIA / EIA-603-C-2004, was used for ERP/EIRP measurement, and the spectrum analyzer configuration follows KDB 971168 D01 Power Meas. License Digital Systems v01. The ERP of mobile transmitters must not exceed 7 Watts and the EIRP of mobile transmitters are limited to 2 Watts.

3.2.2 Measuring Instruments

See list of measuring instruments of this test report.

3.2.3 Test Procedures

1. The EUT was placed on a turntable with 1.0 meter height in a fully anechoic chamber.
2. The EUT was set at 1.2 meters from the receiving antenna, which was mounted on the antenna tower.
3. The table was rotated 360 degrees to determine the position of the highest radiated power.
4. The height of the receiving antenna is adjusted to look for the maximum ERP/EIRP.
5. Taking the record of maximum ERP/EIRP.
6. A dipole antenna was substituted in place of the EUT and was driven by a signal generator.
7. The conducted power at the terminal of the dipole antenna is measured.
8. Repeat step 3 to step 5 to get the maximum ERP/EIRP of the substitution antenna.
9. $ERP/EIRP = P_s + E_t - E_s + G_s = P_s + R_t - R_s + G_s$

P_s (dBm) : Input power to substitution antenna.

G_s (dBi or dBd) : Substitution antenna Gain.

$E_t = R_t + AF$

$E_s = R_s + AF$

AF (dB/m) : Receive antenna factor

R_t : The highest received signal in spectrum analyzer for EUT.

R_s : The highest received signal in spectrum analyzer for substitution antenna.

3.2.4 Test Setup

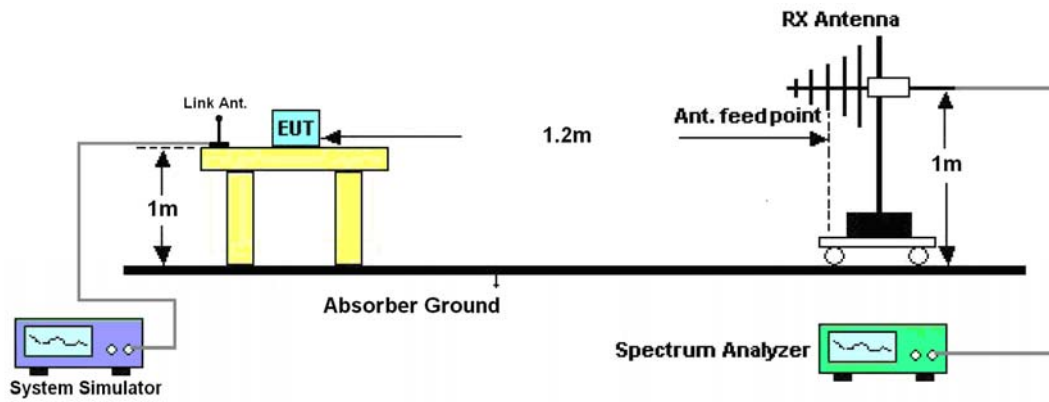

3.2.5 Test Result of ERP

GSM850 (GPRS 8) Radiated Power ERP						
Horizontal Polarization						
Frequency (MHz)	Rt (dBm)	Rs (dBm)	Ps (dBm)	Gs (dBd)	ERP (dBm)	ERP (W)
824.20	-19.72	-48.12	0.00	-1.08	27.32	0.5395
836.40	-18.60	-48.28	0.00	-0.93	28.75	0.7499
848.80	-17.33	-48.35	0.00	-0.76	30.26	1.0617
Vertical Polarization						
Frequency (MHz)	Rt (dBm)	Rs (dBm)	Ps (dBm)	Gs (dBd)	ERP (dBm)	ERP (W)
824.20	-31.62	-47.97	0.00	-1.08	15.27	0.0337
836.40	-29.73	-48.01	0.00	-0.93	17.35	0.0543
848.80	-27.67	-48.05	0.00	-0.76	19.62	0.0916

3.2.6 Test Result of EIRP

GSM1900 (GSM) Radiated Power EIRP						
Horizontal Polarization						
Frequency (MHz)	Rt (dBm)	Rs (dBm)	Ps (dBm)	Gs (dBi)	EIRP (dBm)	EIRP (W)
1850.20	-22.46	-51.88	0.00	1.96	31.38	1.3740
1880.00	-23.23	-52.99	0.00	2.00	31.76	1.4997
1909.80	-24.73	-54.28	0.00	1.98	31.53	1.4223
Vertical Polarization						
Frequency (MHz)	Rt (dBm)	Rs (dBm)	Ps (dBm)	Gs (dBi)	EIRP (dBm)	EIRP (W)
1850.20	-23.14	-52.13	0.00	1.96	30.95	1.2445
1880.00	-24.24	-53.17	0.00	2.00	30.93	1.2388
1909.80	-25.37	-54.13	0.00	1.98	30.74	1.1858

3.3 Occupied Bandwidth Measurement

3.3.1 Description of Occupied Bandwidth Measurement

The emission bandwidth is defined as the width of the signal between two points, located at the 2 sides of the carrier frequency, outside of which all emissions are attenuated at least 26 dB below the transmitter power.

3.3.2 Measuring Instruments

See list of measuring instruments of this test report.

3.3.3 Test Procedures

1. The EUT was connected to Spectrum Analyzer and Base Station via power divider.
2. The 99% and 26 dB occupied bandwidth (BW) of the middle channel for the highest RF powers were measured.

3.3.4 Test Setup

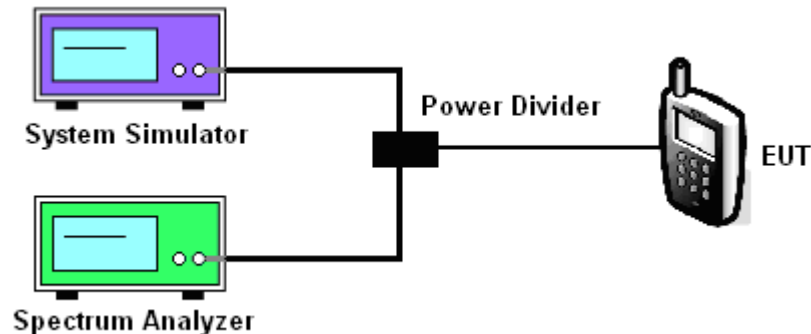

3.3.5 Test Result (Plots) of Occupied Bandwidth

Band :	GSM 850	Power Stage :	High
Test Mode :	GPRS 8 Link		

99% Occupied Bandwidth Plot on Channel 128

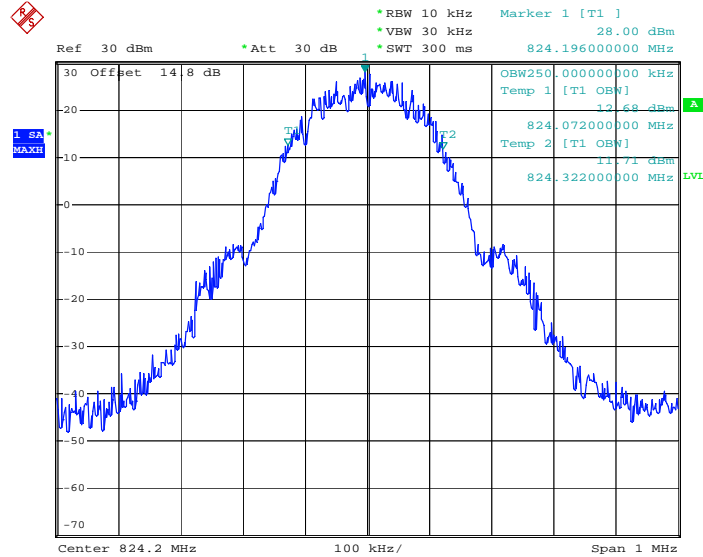

Date: 16.APR.2012 12:05:09

26dB Bandwidth Plot on Channel 128

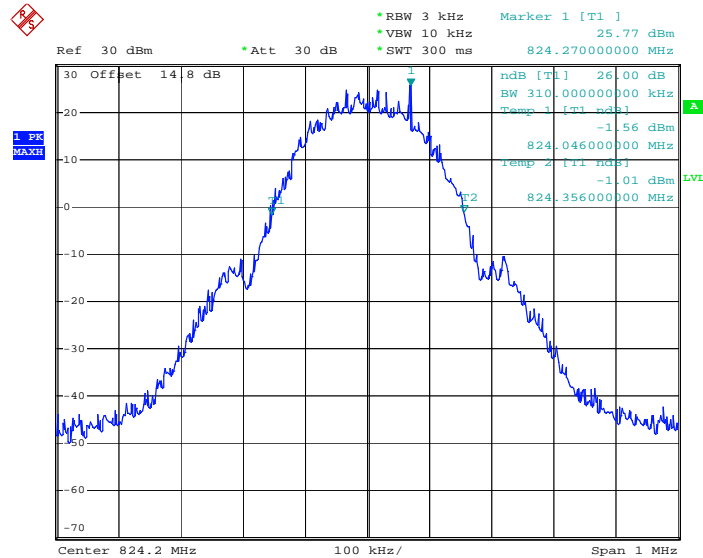

Date: 16.APR.2012 12:03:51



99% Occupied Bandwidth Plot on Channel 189

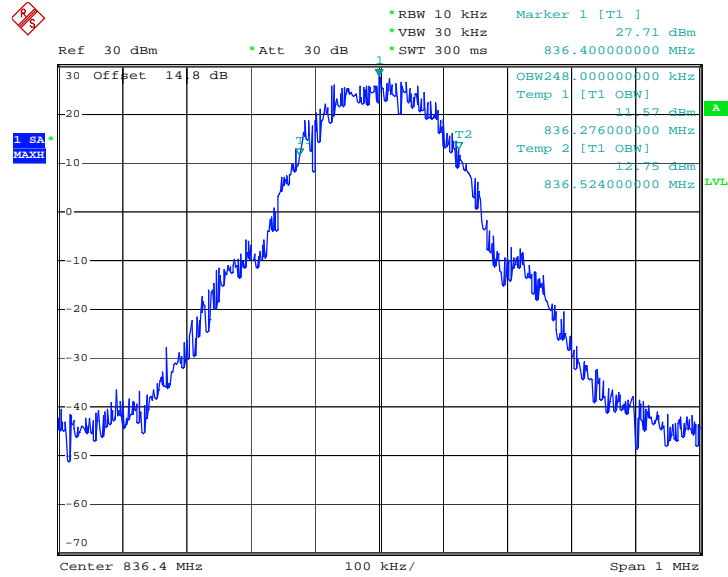

Date: 16.APR.2012 12:05:35

26dB Bandwidth Plot on Channel 189

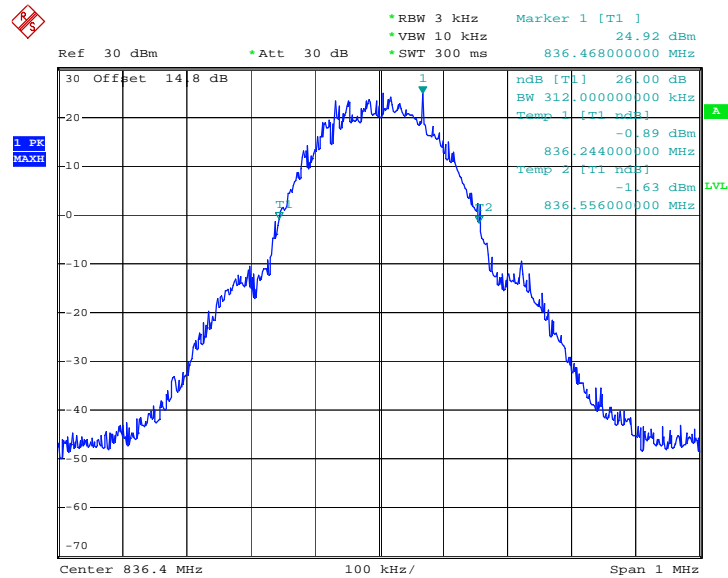

Date: 16.APR.2012 12:04:17



99% Occupied Bandwidth Plot on Channel 251

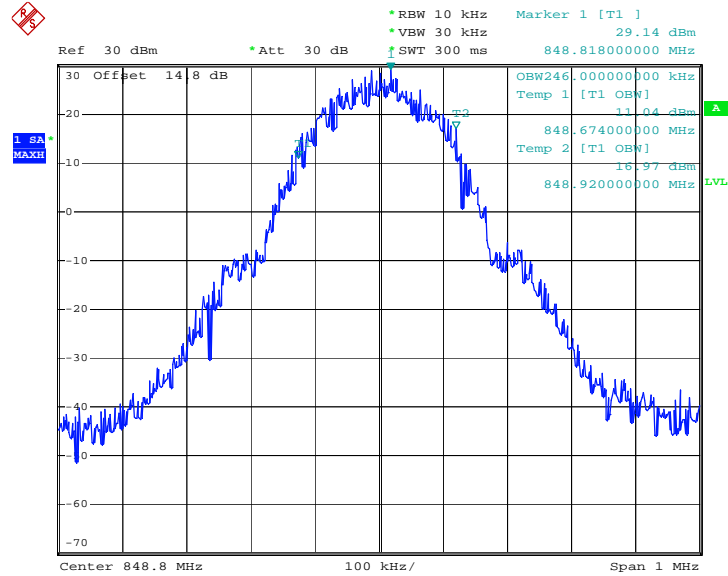

Date: 16.APR.2012 12:06:00

26dB Bandwidth Plot on Channel 251

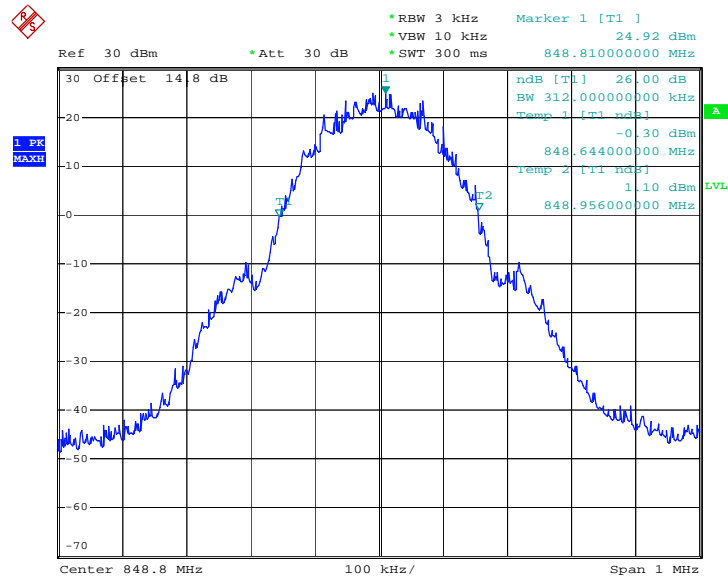

Date: 16.APR.2012 12:04:43



Band :	GSM 1900	Power Stage :	High
Test Mode :	GSM Link		

99% Occupied Bandwidth Plot on Channel 512

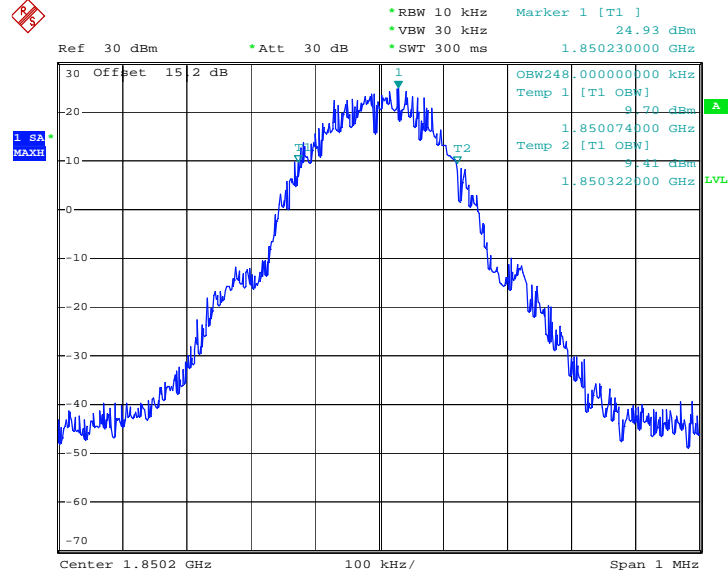

Date: 16.APR.2012 12:47:32

26dB Bandwidth Plot on Channel 512

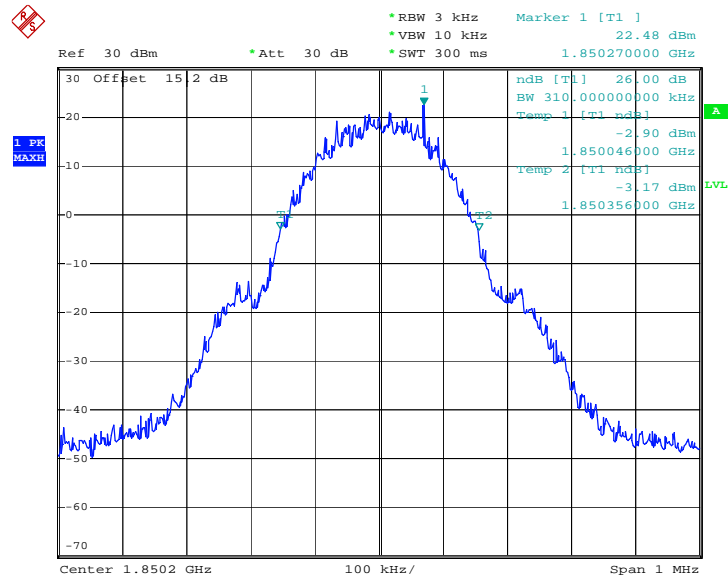

Date: 16.APR.2012 12:46:14



99% Occupied Bandwidth Plot on Channel 661

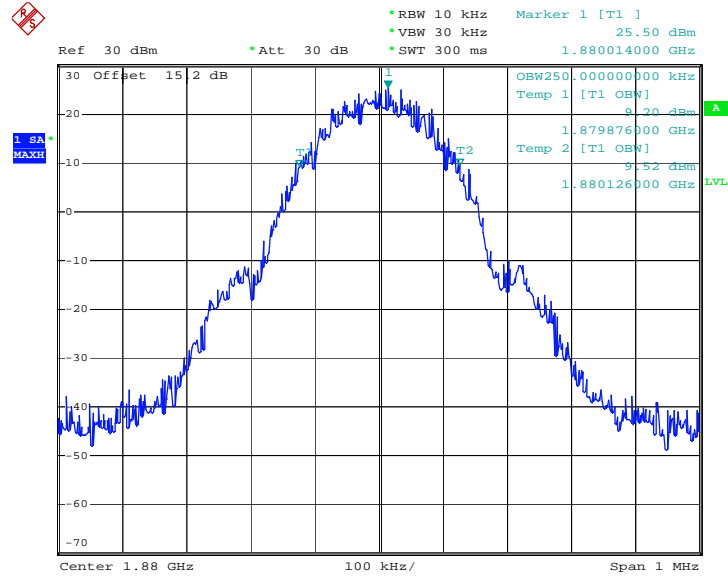

Date: 16.APR.2012 12:47:58

26dB Bandwidth Plot on Channel 661

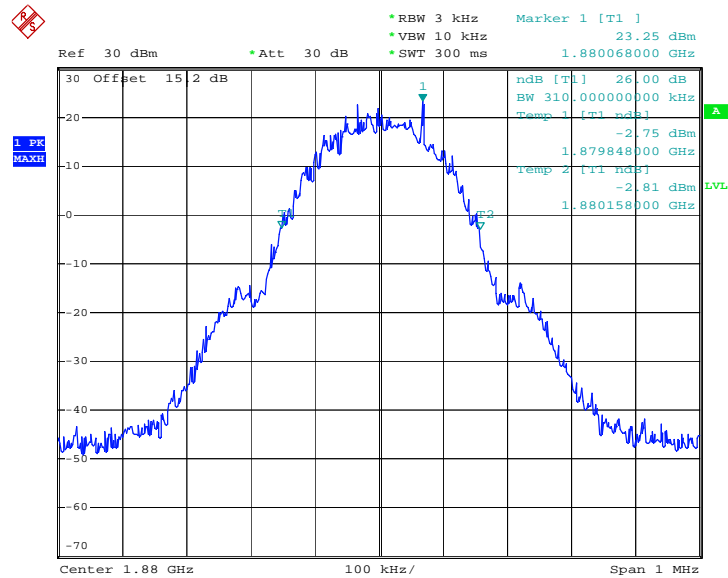

Date: 16.APR.2012 12:46:39



99% Occupied Bandwidth Plot on Channel 810

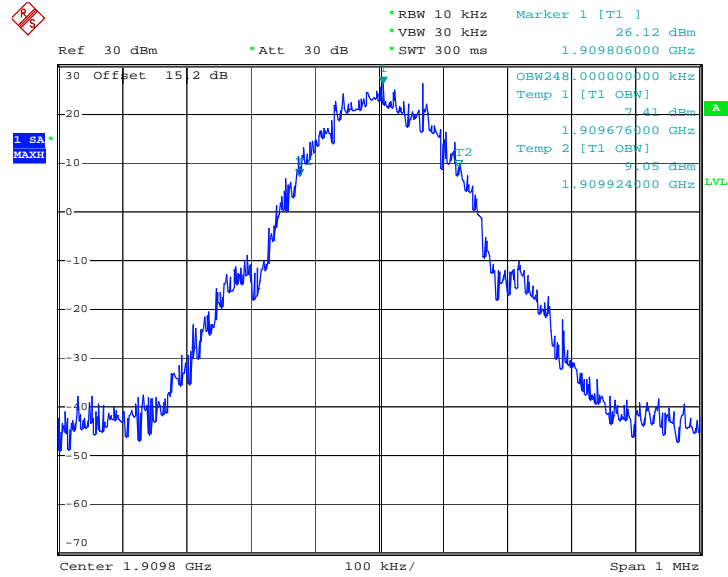

Date: 16.APR.2012 12:48:23

26dB Bandwidth Plot on Channel 810

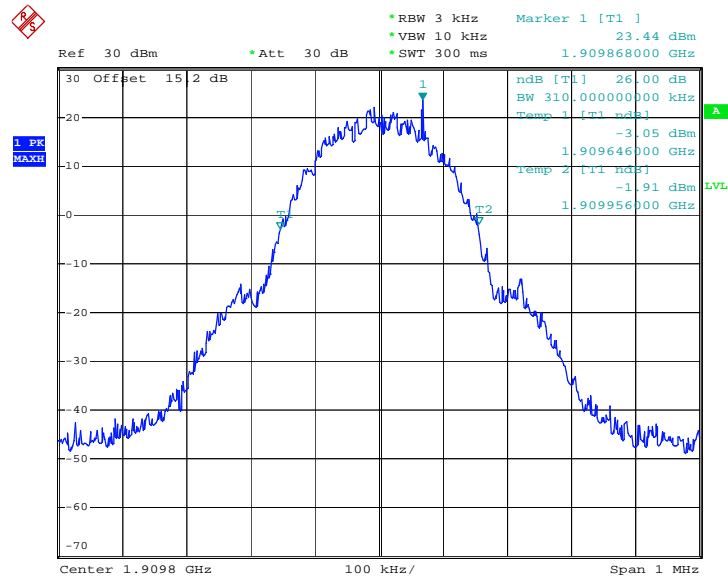

Date: 16.APR.2012 12:47:06

3.4 Band Edge Measurement

3.4.1 Description of Band Edge Measurement

The power of any emission outside of the authorized operating frequency ranges must be lower than the transmitter power (P) by a factor of at least $43 + 10 \log (P)$ dB.

3.4.2 Measuring Instruments

See list of measuring instruments of this test report.

3.4.3 Test Procedures

1. The EUT was connected to Spectrum Analyzer and Base Station via power divider.
2. The band edges of low and high channels for the highest RF powers were measured. Setting RBW as roughly $BW/100$.

3.4.4 Test Setup

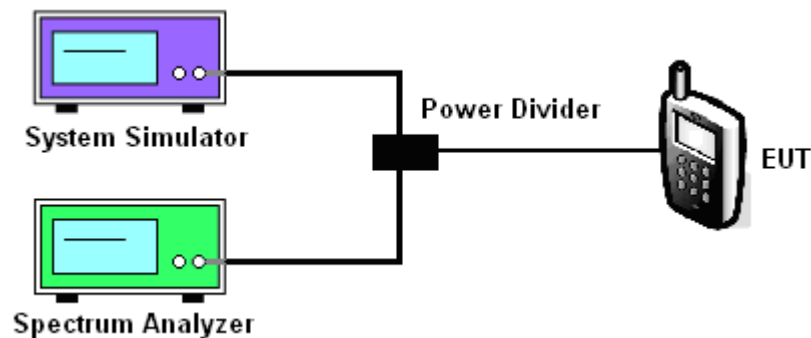

3.4.5 Test Result (Plots) of Conducted Band Edge

Band :	GSM850	Power Stage :	High
Test Mode :	GPRS 8 Link	Maximum 26dB Bandwidth :	0.312 MHz
Correction Factor :	0.17 dB	Measurement Value :	-17.21 dBm
Band Edge :	-17.04 dBm		

Lower Band Edge Plot on Channel 128

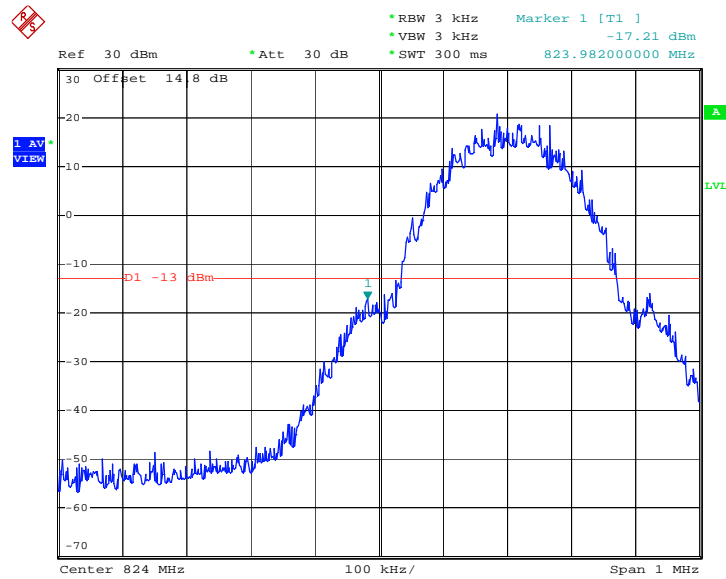

Date: 16.APR.2012 12:07:25

1. Correction Factor(dB)= 10log(1% Emission BW/RBW)
2. Band Edge= Measurement Value + Correction Factor(dB)



Band :	GSM850	Power Stage :	High
Test Mode :	GPRS 8 Link	Maximum 26dB Bandwidth :	0.312 MHz
Correction Factor :	0.17 dB	Measurement Value :	-15.05 dBm
Band Edge :	-14.88 dBm		

Higher Band Edge Plot on Channel 251

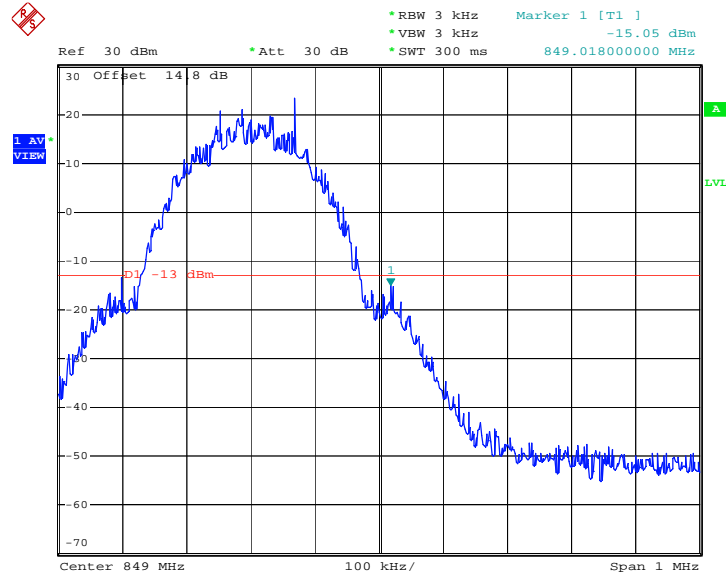

Date: 16.APR.2012 12:07:51

1. Correction Factor(dB)= $10\log(1\% \text{ Emission BW/RBW})$
2. Band Edge= Measurement Value + Correction Factor(dB)



Band :	GSM1900	Power Stage :	High
Test Mode :	GSM Link	Maximum 26dB Bandwidth :	0.310 MHz
Correction Factor :	0.14 dB	Measurement Value :	-19.50 dBm
Band Edge :	-19.36 dBm		

Lower Band Edge Plot on Channel 512

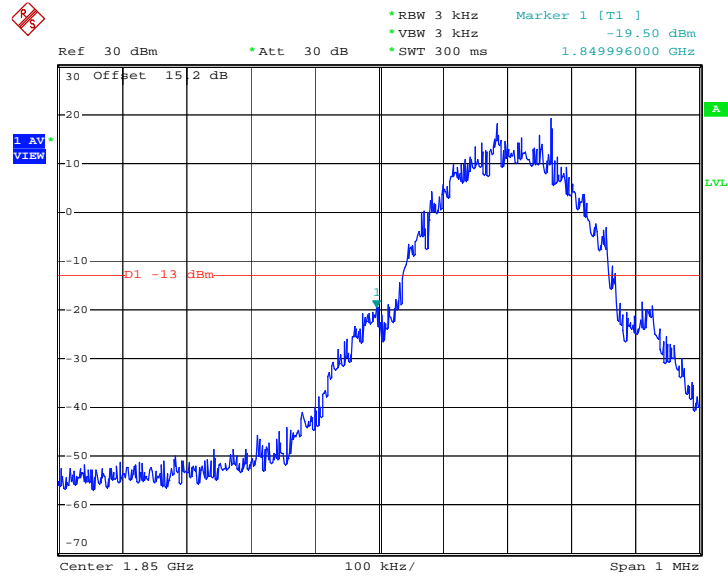

Date: 16.APR.2012 12:49:48

1. Correction Factor(dB)= 10log(1% Emission BW/RBW)
2. Band Edge= Measurement Value + Correction Factor(dB)



Band :	GSM1900	Power Stage :	High
Test Mode :	GSM Link	Maximum 26dB Bandwidth :	0.310 MHz
Correction Factor :	0.14dB	Measurement Value :	-18.29 dBm
Band Edge :	-18.15 dBm		

Higher Band Edge Plot on Channel 810

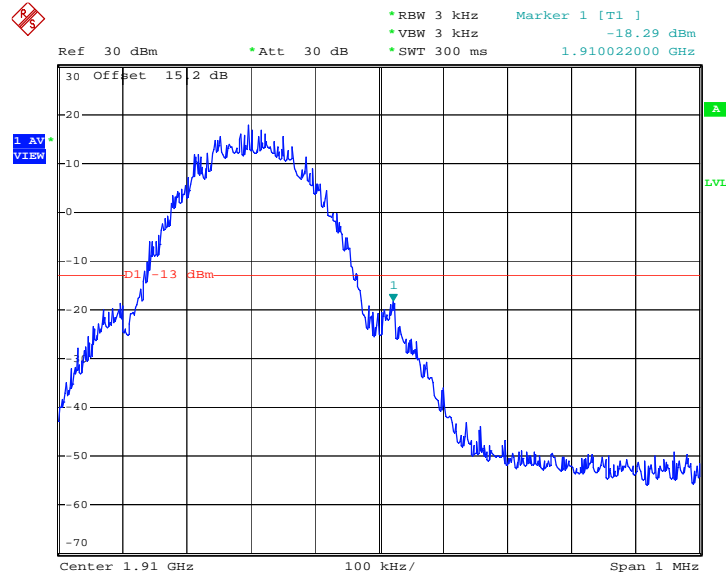

Date: 16.APR.2012 12:50:14

1. Correction Factor(dB)= 10log(1% Emission BW/RBW)
2. Band Edge= Measurement Value + Correction Factor(dB)

3.5 Conducted Emission Measurement

3.5.1 Description of Conducted Emission Measurement

The power of any emission outside of the authorized operating frequency ranges must be lower than the transmitter power (P) by a factor of at least $43 + 10 \log (P)$ dB.

It is measured by means of a calibrated spectrum analyzer and scanned from 30 MHz up to a frequency including its 10th harmonic.

3.5.2 Measuring Instruments

See list of measuring instruments of this test report.

3.5.3 Test Procedures

1. The EUT was connected to spectrum analyzer and base station via power divider.
2. The middle channel for the highest RF power within the transmitting frequency was measured.
3. The conducted spurious emission for the whole frequency range was taken.

3.5.4 Test Setup

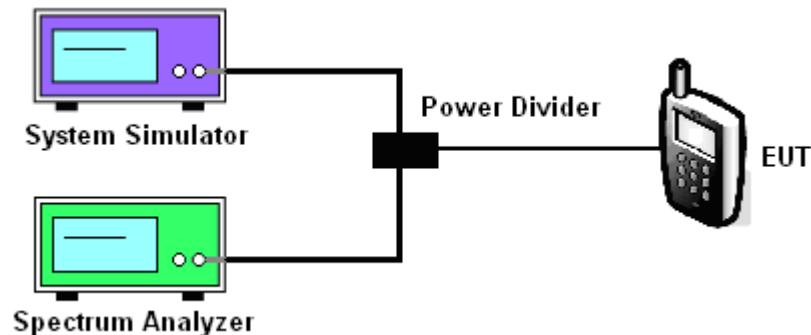

3.5.5 Test Result (Plots) of Conducted Emission

Band :	GSM850	Channel :	CH189
Test Mode :	GPRS 8 Link		

Conducted Emission Plot between 30MHz ~ 1GHz

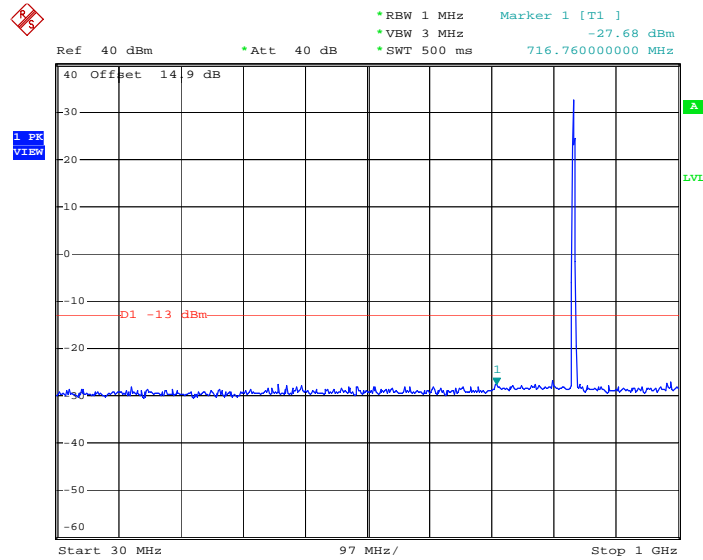

Date: 16.APR.2012 14:14:22

Conducted Emission Plot between 1GHz ~ 3GHz

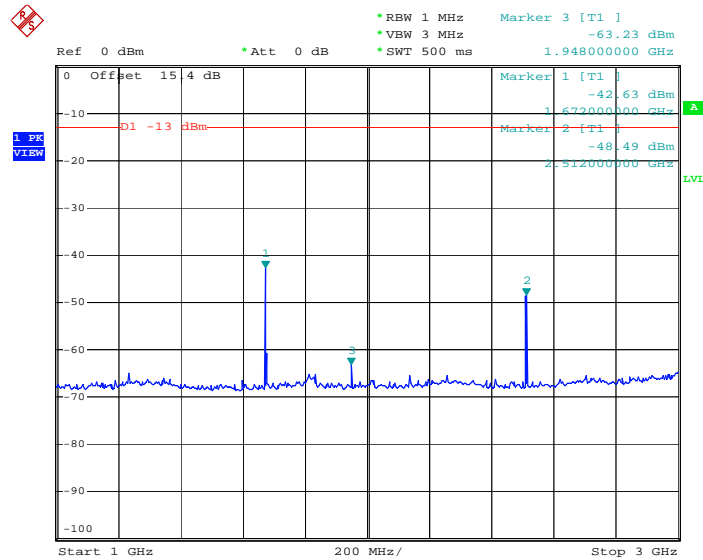

Date: 16.APR.2012 14:24:22



Conducted Emission Plot between 3GHz ~ 7GHz

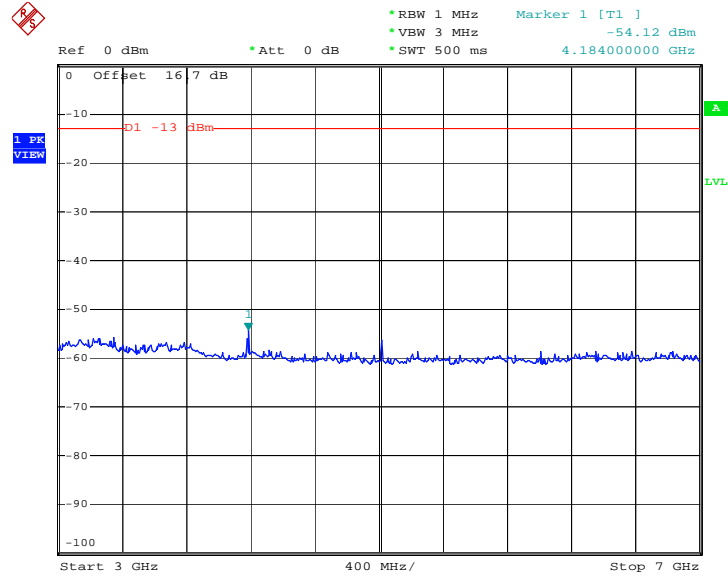

Date: 16.APR.2012 14:25:22

Conducted Emission Plot between 7GHz ~ 9GHz

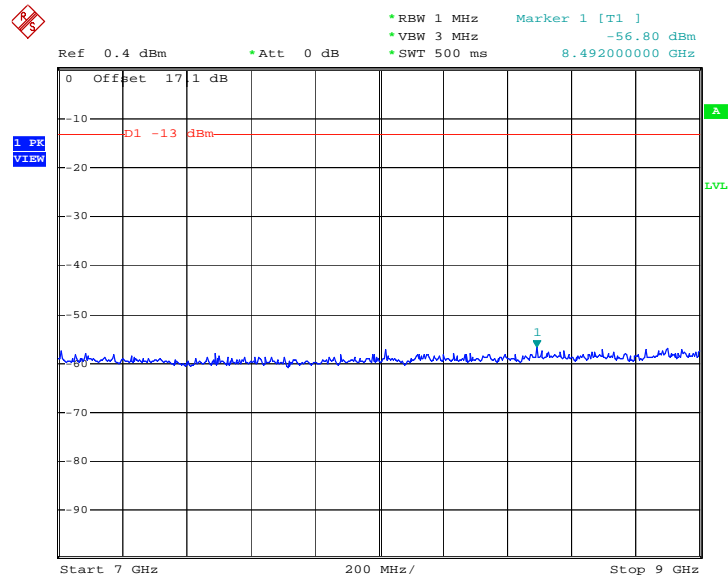

Date: 16.APR.2012 14:30:43



Band :	GSM1900	Channel :	CH661
Test Mode :	GSM Link		

Conducted Emission Plot between 30MHz ~ 1GHz

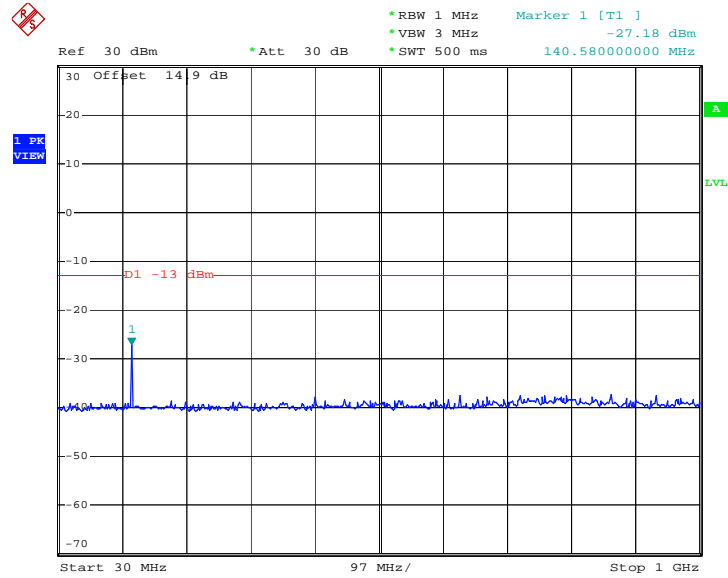

Date: 16.APR.2012 13:06:32

Conducted Emission Plot between 1GHz ~ 3GHz

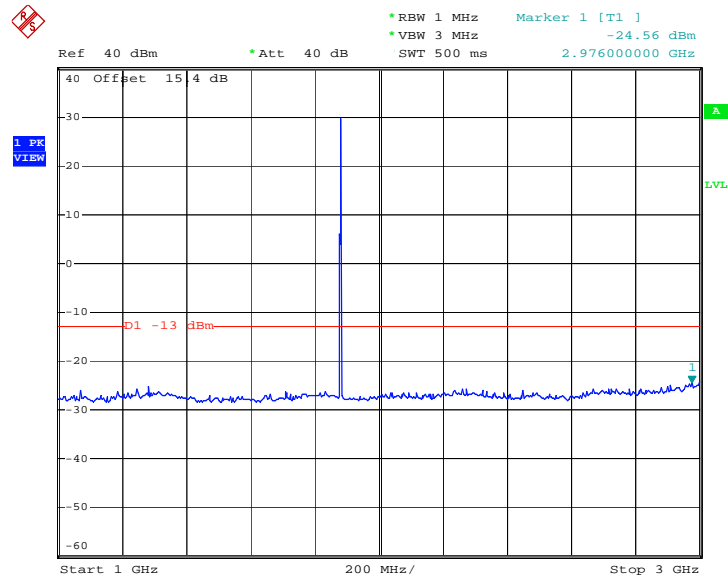

Date: 16.APR.2012 13:05:25



Conducted Emission Plot between 3GHz ~ 7GHz

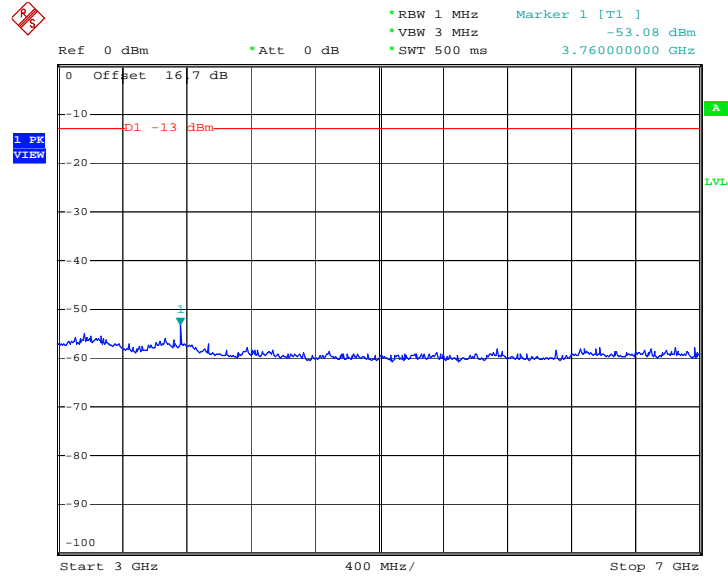

Date: 16.APR.2012 13:08:49

Conducted Emission Plot between 7GHz ~ 13.6GHz

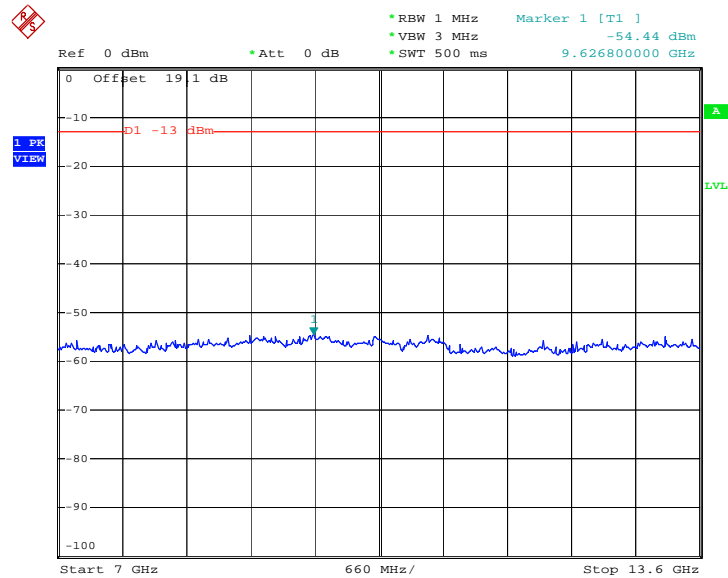

Date: 16.APR.2012 13:10:22



Conducted Emission Plot between 13.6GHz ~ 19.1GHz

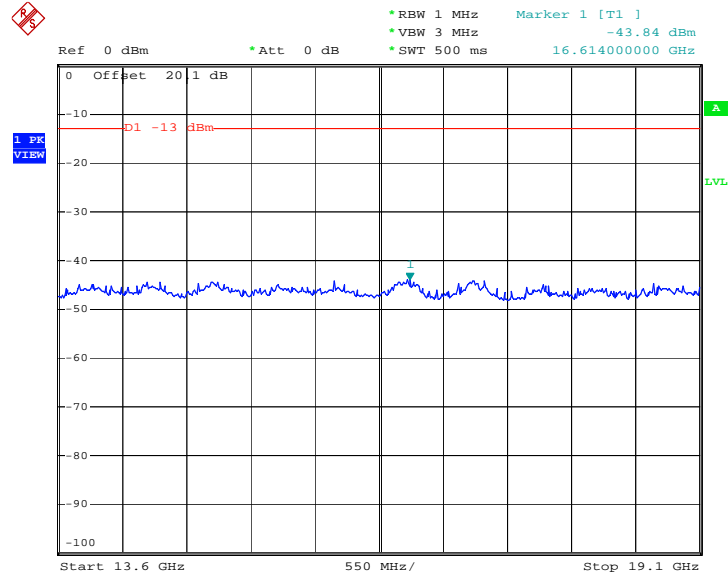

Date: 16.APR.2012 13:11:19

3.6 Field Strength of Spurious Radiation Measurement

3.6.1 Description of Field Strength of Spurious Radiated Measurement

The radiated spurious emission was measured by substitution method according to ANSI / TIA / EIA-603-C-2004. The power of any emission outside of the authorized operating frequency ranges must be attenuated below the transmitter power (P) by a factor of at least $43 + 10 \log (P)$ dB. The spectrum is scanned from 30 MHz up to a frequency including its 10th harmonic.

3.6.2 Measuring Instruments

See list of measuring instruments of this test report.

3.6.3 Test Procedures

4. The EUT was placed on a rotatable wooden table with 0.8 meter about ground.
5. The EUT was set 3 meters from the receiving antenna, which was mounted on the antenna tower.
6. The table was rotated 360 degrees to determine the position of the highest spurious emission.
7. The height of the receiving antenna is varied between one meter and four meters to search the maximum spurious emission for both horizontal and vertical polarizations.
8. Make the measurement with the spectrum analyzer's RBW = 1MHz, VBW = 3MHz, Sweep = 500ms, Taking the record of maximum spurious emission.
9. A horn antenna was substituted in place of the EUT and was driven by a signal generator.
10. Tune the output power of signal generator to the same emission level with EUT maximum spurious emission.
11. Taking the record of output power at antenna port.
12. Repeat step 7 to step 8 for another polarization.
13. $EIRP \text{ (dBm)} = S.G. \text{ Power} - Tx \text{ Cable Loss} + Tx \text{ Antenna Gain}$
14. $ERP \text{ (dBm)} = EIRP - 2.15$

3.6.4 Test Setup

For radiated emissions below 30MHz

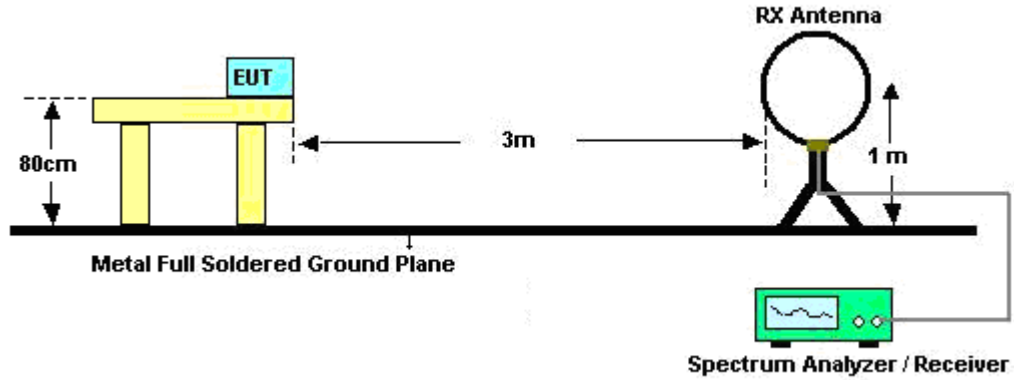

For radiated emissions above 30MHz

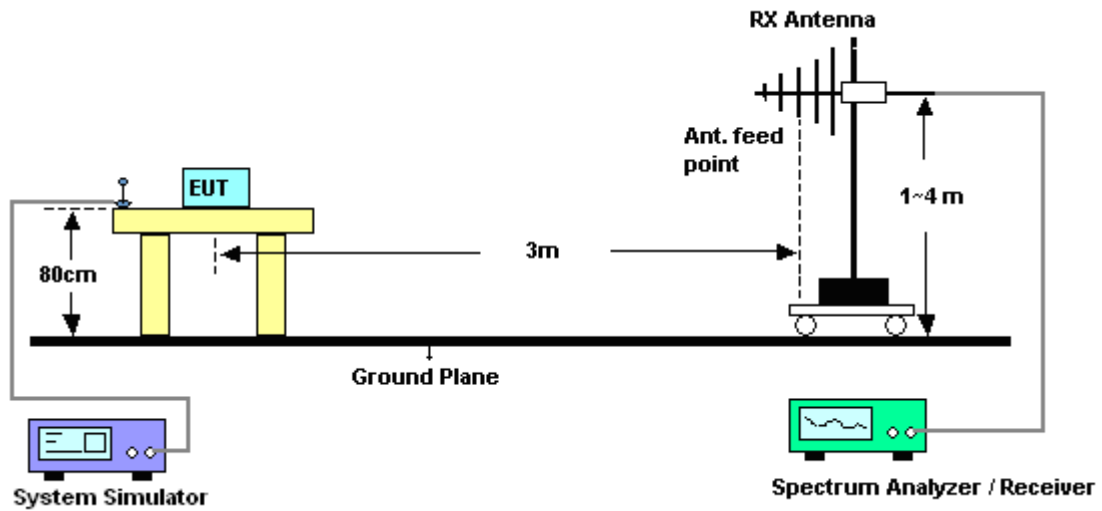

3.6.5 Test Results of Radiated Emissions (9 KHz ~ 30 MHz)

The low frequency, which started from 9 KHz to 30MHz, was pre-scanned and the result which was 20dB lower than the limit line per 15.31(o) was not reported.



3.6.6 Test Result of Field Strength of Spurious Radiated

Band :	GSM850	Temperature :	23~25°C
Test Mode :	GPRS 8 Link	Relative Humidity :	43~45%
Test Engineer :	Chenmy Cheng	Polarization :	Horizontal
Remark :	Spurious emissions within 30-1000MHz were found more than 20dB below limit line.		

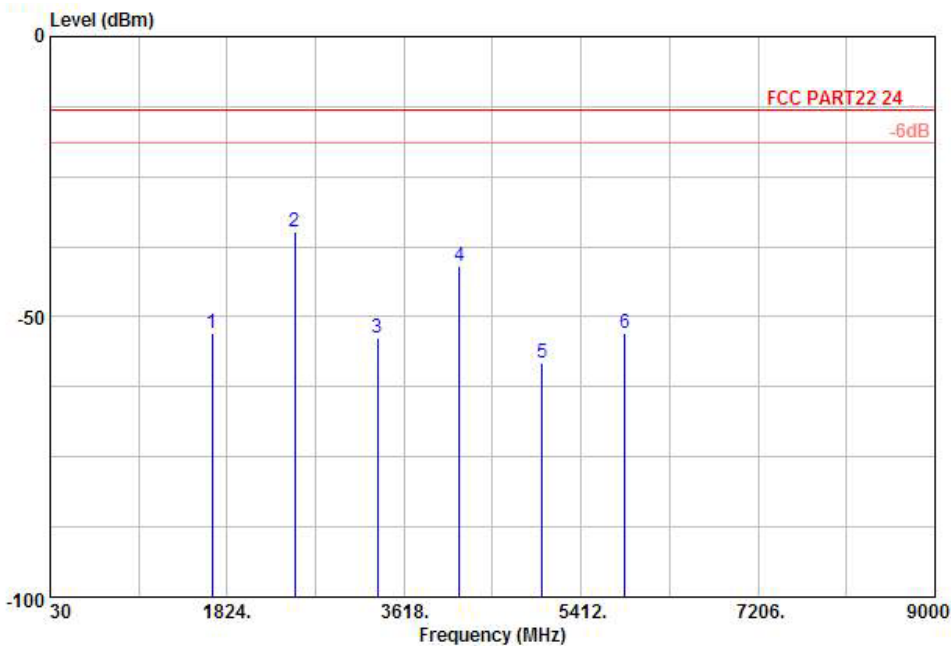

Site : 03CH01-KS
 Condition: FCC PART22 24 HF EIRP FACTOR-09020 HORIZONTAL
 Project : (FG) 241001
 Plan : H

Frequency (MHz)	ERP (dBm)	Limit (dBm)	Over Limit (dB)	SPA Reading (dBm)	S.G. Power (dBm)	TX Cable loss (dB)	TX Antenna Gain (dBi)	Polarization (H/V)	Result
1674	-52.90	-13	-39.90	-51.04	-53.55	0.57	3.37	H	Pass
2510	-34.87	-13	-21.87	-39.51	-37.10	0.78	5.16	H	Pass
3346	-53.83	-13	-40.83	-55.77	-57.47	0.87	6.66	H	Pass
4182	-40.91	-13	-27.91	-46.20	-45.50	0.97	7.71	H	Pass
5018	-58.21	-13	-45.21	-64.41	-63.88	1.09	8.91	H	Pass
5856	-52.84	-13	-39.84	-61.55	-59.28	1.22	9.81	H	Pass



Band :	GSM850	Temperature :	23~25°C
Test Mode :	GPRS 8 Link	Relative Humidity :	43~45%
Test Engineer :	Chenmy Cheng	Polarization :	Vertical
Remark :	Spurious emissions within 30-1000MHz were found more than 20dB below limit line.		

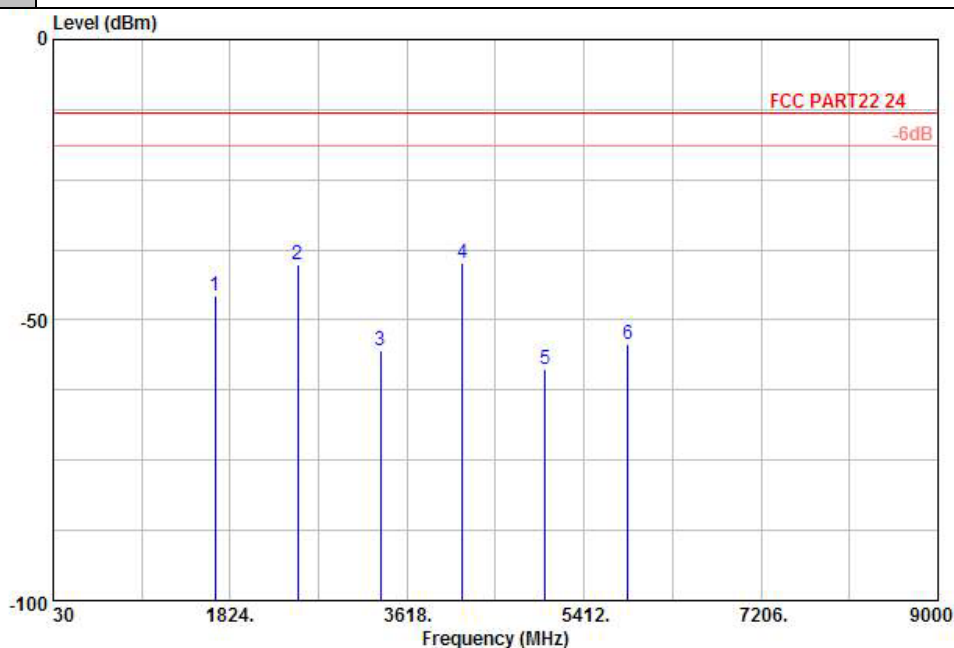

Site : 03CH01-KS
 Condition: FCC PART22 24 HF EIRP FACTOR-09020 VERTICAL
 Project : (FG) 241001
 Plan : H

Frequency (MHz)	ERP (dBm)	Limit (dBm)	Over Limit (dB)	SPA Reading (dBm)	S.G. Power (dBm)	TX Cable loss (dB)	TX Antenna Gain (dBi)	Polarization (H/V)	Result
1674	-45.63	-13	-32.63	-49.33	-46.28	0.57	3.37	V	Pass
2510	-40.04	-13	-27.04	-46.01	-42.27	0.78	5.16	V	Pass
3346	-55.49	-13	-42.49	-57.47	-59.13	0.87	6.66	V	Pass
4182	-39.84	-13	-26.84	-46.85	-44.43	0.97	7.71	V	Pass
5018	-58.71	-13	-45.71	-63.65	-64.38	1.09	8.91	V	Pass
5856	-54.24	-13	-41.24	-62.23	-60.68	1.22	9.81	V	Pass



Band :	GSM1900	Temperature :	23~25°C
Test Mode :	GSM Link	Relative Humidity :	43~45%
Test Engineer :	Chenmy Cheng	Polarization :	Horizontal
Remark :	Spurious emissions within 30-1000MHz were found more than 20dB below limit line.		

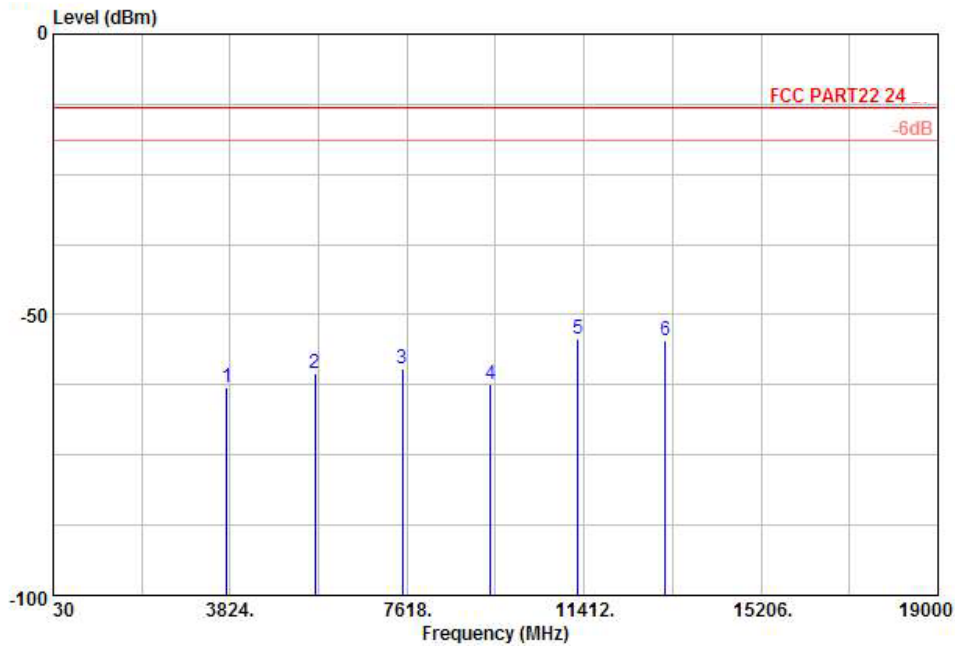

Site : 03CH01-KS
 Condition: FCC PART22 24 HF EIRP FACTOR-09020 HORIZONTAL
 Project : (FG) 241001
 Plan : H

Frequency (MHz)	EIRP (dBm)	Limit (dBm)	Over Limit (dB)	SPA Reading (dBm)	S.G. Power (dBm)	TX Cable loss (dB)	TX Antenna Gain (dBi)	Polarization (H/V)	Result
3760	-62.91	-13	-49.91	-63.88	-69.29	0.78	7.16	H	Pass
5640	-60.36	-13	-47.36	-64.54	-68.90	1.04	9.58	H	Pass
7520	-59.66	-13	-46.66	-64.79	-69.77	1.35	11.46	H	Pass
9400	-62.42	-13	-49.42	-65.68	-73.48	1.75	12.81	H	Pass
11280	-54.43	-13	-41.43	-65.92	-65.52	2	13.09	H	Pass
13160	-54.46	-13	-41.46	-65.76	-66.17	2.04	13.75	H	Pass



Band :	GSM1900	Temperature :	23~25°C
Test Mode :	GSM Link	Relative Humidity :	43~45%
Test Engineer :	Chenmy Cheng	Polarization :	Vertical
Remark :	Spurious emissions within 30-1000MHz were found more than 20dB below limit line.		

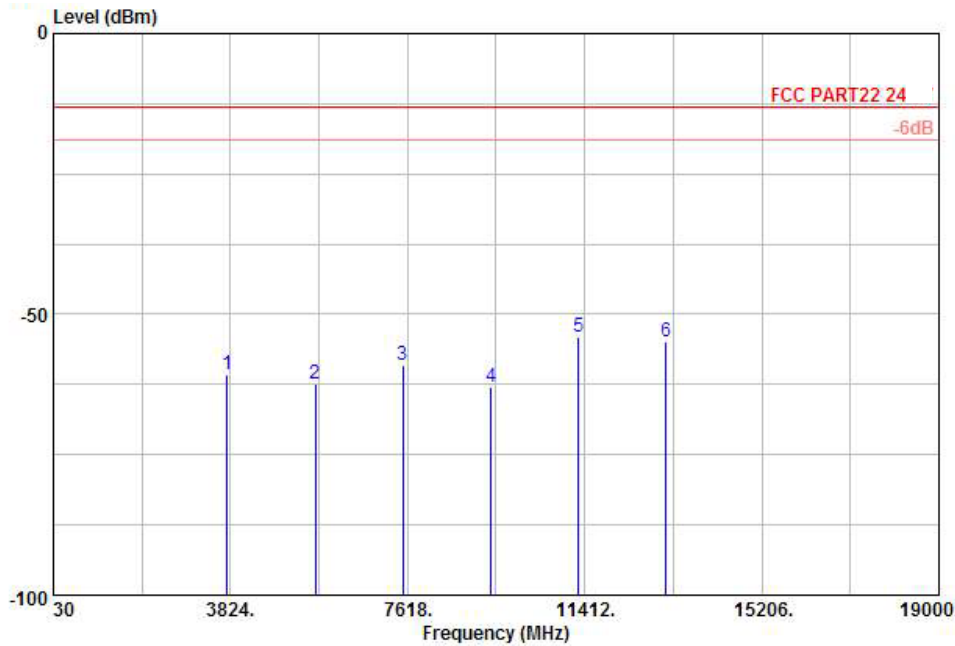

Site : 03CH01-KS
 Condition: FCC PART22 24 HF EIRP FACTOR-09020 VERTICAL
 Project : (FG) 241001
 Plan : H

Frequency (MHz)	EIRP (dBm)	Limit (dBm)	Over Limit (dB)	SPA Reading (dBm)	S.G. Power (dBm)	TX Cable loss (dB)	TX Antenna Gain (dBi)	Polarization (H/V)	Result
3760	-60.86	-13	-47.86	-62.23	-67.24	0.78	7.16	V	Pass
5640	-62.45	-13	-49.45	-65.67	-70.99	1.04	9.58	V	Pass
7520	-59.19	-13	-46.19	-63.68	-69.30	1.35	11.46	V	Pass
9400	-63.07	-13	-50.07	-64.29	-74.13	1.75	12.81	V	Pass
11280	-53.95	-13	-40.95	-65.19	-65.04	2	13.09	V	Pass
13160	-54.77	-13	-41.77	-65.96	-66.48	2.04	13.75	V	Pass

3.7 Frequency Stability Measurement

3.7.1 Description of Frequency Stability Measurement

The frequency stability shall be measured by variation of ambient temperature and variation of primary supply voltage to ensure that the fundamental emission stays within the authorized frequency block. The frequency stability of the transmitter shall be maintained within $\pm 0.00025\%$ ($\pm 2.5\text{ppm}$) of the center frequency.

3.7.2 Measuring Instruments

See list of measuring instruments of this test report.

3.7.3 Test Procedures for Temperature Variation

1. The EUT was set up in the thermal chamber and connected with the base station.
2. With power OFF, the temperature was decreased to -30°C and the EUT was stabilized for three hours. Power was applied and the maximum change in frequency was recorded within one minute.
3. With power OFF, the temperature was raised in 10°C step up to 50°C . The EUT was stabilized at each step for at least half an hour. Power was applied and the maximum frequency change was recorded within one minute.
4. If the EUT cannot be turned on at -30°C , the testing lowest temperature will be raised in 10°C step until the EUT can be turned on.

3.7.4 Test Procedures for Voltage Variation

1. The EUT was placed in a temperature chamber at $25\pm 5^{\circ}\text{C}$ and connected with the base station.
2. The power supply voltage to the EUT was varied from BEP to 115% of the nominal value measured at the input to the EUT.
3. The variation in frequency was measured for the worst case.

3.7.5 Test Setup

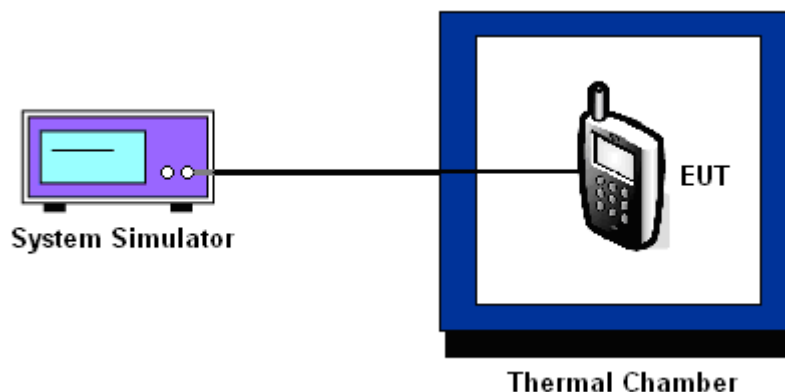

3.7.6 Test Result of Temperature Variation

Band :	GSM 850	Channel :	189
Limit (ppm) :	2.5		
Temperature (°C)	GPRS 8		Result
	Freq. Dev. (Hz)	Deviation (ppm)	
-30	N/A	N/A	PASS
-20	N/A	N/A	
-10	-23	-0.03	
0	-17	-0.02	
10	-20	-0.02	
20	-23	-0.03	
30	-22	-0.03	
40	-21	-0.02	
50	-19	-0.02	
55	-17	-0.02	

Note: The manufacturer declared that the EUT could work properly between temperatures -10°C~55°C.

Band :	GSM 1900	Channel :	661
Limit (ppm) :	2.5		

Temperature (°C)	GSM		Result
	Freq. Dev. (Hz)	Deviation (ppm)	
-30	N/A	N/A	PASS
-20	N/A	N/A	
-10	22	0.01	
0	24	0.01	
10	29	0.02	
20	25	0.01	
30	21	0.01	
40	19	0.01	
50	31	0.02	
55	35	0.02	

Note: The manufacturer declared that the EUT could work properly between temperatures -10°C~55°C.

3.7.7 Test Result of Voltage Variation

Band & Channel	Mode	Voltage (Volt)	Freq. Dev. (Hz)	Deviation (ppm)	Limit (ppm)	Result
GSM 850 CH189	GPRS 8	3.8	-26	-0.03	2.5	PASS
		BEP	-21	-0.02		
		4.2	-23	-0.03		
GSM 1900 CH661	GSM	3.8	-25	-0.01		
		BEP	-13	-0.01		
		4.2	-27	-0.01		

Note:

1. Normal Voltage = 3.8V.
2. Battery End Point (BEP) = 3.4 V.



4 List of Measuring Equipment

Instrument	Manufacturer	Model No.	Serial No.	Characteristics	Calibration Date	Test Date	Due Date	Remark
Spectrum Analyzer	R&S	FSP40	100319	9kHz~40GHz	Dec. 30, 2011	Apr. 16, 2012	Dec. 29, 2012	Conducted (TH01-KS)
System Simulator	R&S	CMU200	837587/066	2G Full-Band	Dec. 30, 2011	Apr. 16, 2012	Dec. 29, 2012	Conducted (TH01-KS)
DC Power Supply	TOPWARD	GPS-30300	E1884515	N/A	Aug. 23, 2011	Apr. 16, 2012	Aug. 22, 2012	Conducted (TH01-KS)
Thermal Chamber	Ten Billion	TTC-B3S	TBN-960502	N/A	Dec. 30, 2011	Apr. 16, 2012	Dec. 29, 2012	Conducted (TH01-KS)
EMI Test Receiver	R&S	ESCI	100534	9kHz~3GHz	Nov. 09, 2011	Apr. 17, 2012	Nov. 08, 2012	Radiation (03CH01-KS)
Spectrum Analyzer	R&S	FSP40	100319	9kHz~40GHz	Dec. 30, 2011	Apr. 17, 2012	Dec. 29, 2012	Radiation (03CH01-KS)
Bilog Antenna	SCHAFFNER	CBL6112D	23182	25MHz~2GHz	Dec. 08, 2011	Apr. 17, 2012	Dec. 07, 2012	Radiation (03CH01-KS)
Double Ridge Horn Antenna	EMCO	3117	00075959	1GHz~18GHz	Jan. 06, 2012	Apr. 17, 2012	Jan. 05, 2013	Radiation (03CH01-KS)
Amplifier	Wireless	FPA-6592G	060007	30MHz~2GHz	Dec. 30, 2011	Apr. 17, 2012	Dec. 29, 2012	Radiation (03CH01-KS)
Amplifier	Agilent	8449B	3008A02370	1GHz~26.5GHz	Dec. 30, 2011	Apr. 17, 2012	Dec. 29, 2012	Radiation (03CH01-KS)
Loop Antenna	R&S	HFH2-Z2	860004/00	9kHz~30 MHz	Jul. 28, 2011	Apr. 17, 2012	Jul. 27, 2012	Radiation (03CH01-KS)
System Simulator	R&S	CMU200	116456	Full-Band	Sep. 20, 2011	Apr. 17, 2012	Sep. 19, 2012	Radiation (03CH01-KS)

5 Uncertainty of Evaluation

Uncertainty of Radiated Emission Measurement (30 MHz ~ 1000 MHz)

Contribution	Uncertainty of X_i		$u(X_i)$
	dB	Probability Distribution	
Receiver Reading	0.41	Normal (k=2)	0.21
Antenna Factor Calibration	0.83	Normal (k=2)	0.42
Cable Loss Calibration	0.25	Normal (k=2)	0.13
Pre-Amplifier Gain Calibration	0.27	Normal (k=2)	0.14
RCV/SPA Specification	2.50	Rectangular	0.72
Antenna Factor Interpolation for Frequency	1.00	Rectangular	0.29
Site Imperfection	1.43	Rectangular	0.83
Mismatch	+0.39 / -0.41	U-Shape	0.28
Combined Standard Uncertainty $U_c(y)$	1.27		
Measuring Uncertainty for a Level of Confidence of 95% ($U = 2U_c(y)$)	2.54		

Uncertainty of Radiated Emission Measurement (1 GHz ~ 40 GHz)

Contribution	Uncertainty of X_i		$u(X_i)$	C_i	$C_i * u(X_i)$
	dB	Probability Distribution			
Receiver Reading	± 0.10	Normal (k=2)	0.10	1	0.10
Antenna Factor Calibration	± 1.70	Normal (k=2)	0.85	1	0.85
Cable Loss Calibration	± 0.50	Normal (k=2)	0.25	1	0.25
Receiver Correction	± 2.00	Rectangular	1.15	1	1.15
Antenna Factor Directional	± 1.50	Rectangular	0.87	1	0.87
Site Imperfection	± 2.80	Triangular	1.14	1	1.14
Mismatch Receiver VSWR $\Gamma_1 = 0.197$ Antenna VSWR $\Gamma_2 = 0.194$ Uncertainty = $20\text{Log}(1-\Gamma_1*\Gamma_2)$	+0.34 / -0.35	U-Shape	0.244	1	0.244
Combined Standard Uncertainty $U_c(y)$	2.36				
Measuring Uncertainty for a Level of Confidence of 95% ($U = 2U_c(y)$)	4.72				