



FCC RF Test Report

APPLICANT : Motorola Mobility, Inc.
EQUIPMENT : Mobile Phone
BRAND NAME : MOTOROLA
MODEL NAME : XT531
GPPD NUMBER : 3060
FCC ID : IHDT56MY1
STANDARD : FCC Part 15 Subpart C §15.247
CLASSIFICATION : Digital Spread Spectrum (DSS)

The product was received on Apr. 21, 2011 and completely tested on May 14, 2011. We, SPORTON INTERNATIONAL INC., would like to declare that the tested sample has been evaluated in accordance with the procedures given in ANSI C63.4-2003 and shown the compliance with the applicable technical standards.

The test results in this report apply exclusively to the tested model / sample. Without written approval of SPORTON INTERNATIONAL INC., the test report shall not be reproduced except in full.

Reviewed by:

Jones Tsai / Manager



SPORTON INTERNATIONAL INC.

No. 52, Hwa Ya 1st Rd., Hwa Ya Technology Park, Kwei-Shan Hsiang, Tao Yuan Hsien, Taiwan, R.O.C.

SPORTON INTERNATIONAL INC.

TEL : 886-3-327-3456

FAX : 886-3-328-4978

FCC ID : IHDT56MY1

Page Number : 1 of 60

Report Issued Date : May 17, 2011

Report Version : Rev. 01



TABLE OF CONTENTS

REVISION HISTORY..... 3

SUMMARY OF TEST RESULT 4

1 GENERAL DESCRIPTION..... 5

 1.1 Applicant 5

 1.2 Manufacturer..... 5

 1.3 Feature of Equipment Under Test 5

 1.4 Testing Site 6

 1.5 Applied Standards 6

 1.6 Ancillary Equipment List 7

2 TEST CONFIGURATION OF EQUIPMENT UNDER TEST..... 8

 2.1 RF Output Power 8

 2.2 Test Mode..... 9

 2.3 Connection Diagram of Test System..... 10

 2.4 RF Utility 10

3 TEST RESULT 11

 3.1 Number of Channel Measurement 11

 3.2 20dB Bandwidth Measurement 13

 3.3 Hopping Channel Separation Measurement 20

 3.4 Dwell Time Measurement..... 23

 3.5 Peak Output Power Measurement 25

 3.6 Band Edges Measurement 28

 3.7 Spurious Emission Measurement..... 40

 3.8 AC Conducted Emission Measurement..... 44

 3.9 Radiated Emission Measurement..... 48

 3.10 Antenna Requirements 57

4 LIST OF MEASURING EQUIPMENT..... 58

5 UNCERTAINTY OF EVALUATION..... 59

**SUMMARY OF TEST RESULT**

Report Section	FCC Rule	IC Rule	Description	Limit	Result	Remark
3.1	15.247(a)(1)	A8.4(2)	Number of Channels	≥ 15Chs	Pass	-
3.2	15.247(a)(1)	A8.1(a)	20dB Bandwidth	NA	Pass	-
3.3	15.247(a)(1)	A8.1(b)	Channel Separation	≥ 2/3 of 20dB BW	Pass	-
3.4	15.247(a)(1)	A8.1(d)	Dwell Time of Each Channel	≤ 0.4sec in 31.6sec period	Pass	-
3.5	15.247(b)(1)	A8.1(b)	Peak Output Power	≤ 125 mW	Pass	-
3.6	15.247(d)	A8.5	Frequency Band Edges	≤ 20dBc	Pass	-
3.7	15.247(d)	A8.5	Spurious Emission	< 20 dBc	Pass	-
3.8	15.207	Gen 7.2.2	AC Conducted Emission	15.207(a)	Pass	Under limit 16.8 dB at 1.55 MHz
3.9	15.247(d)	A8.5	Transmitter Radiated Emission	15.209(a) & 15.247(d)	Pass	Under limit 6.27 dB at 36.75 MHz
3.10	15.203 & 15.247(b)	A8.4	Antenna Requirement	N/A	Pass	-



1 General Description

1.1 Applicant

Motorola Mobility, Inc.

8F., No. 9, Songgao Rd., Taipei 110, Taiwan, R.O.C.

1.2 Manufacturer

Chi Mei Communication Systems, Inc.

No. 4, Mingsheng Street, Tucheng District, New Taipei City, 23678, Taiwan

1.3 Feature of Equipment Under Test

Product Feature & Specification	
Equipment	Mobile Phone
Brand Name	MOTOROLA
Model Name	XT531
FCC ID	IHDT56MY1
Tx/Rx Frequency Range	2400 MHz ~ 2483.5 MHz
Number of Channels	79
Carrier Frequency of Each Channel	2402+n*1 MHz; n=0~78
Channel Spacing	1 MHz
Maximum Output Power to Antenna	Bluetooth (1Mbps) : 8.17 dBm (0.007 W) Bluetooth EDR (2Mbps) : 6.89 dBm (0.005 W) Bluetooth EDR (3Mbps) : 7.66 dBm (0.006 W)
Antenna Type	PIFA Antenna with gain 0.723 dBi
HW Version	V3.0
SW Version	V4.130
Type of Modulation	Bluetooth (1Mbps) : GFSK Bluetooth EDR (2Mbps) : $\pi/4$ -DQPSK Bluetooth EDR (3Mbps) : 8-DPSK
EUT Stage	Production Unit

Remark:

1. For other wireless features of this EUT, test report will be issued separately.
2. This test report recorded only product characteristics and test results of Digital Spread Spectrum (DSS).
3. The above EUT's information was declared by manufacturer. Please refer to the specifications or user's manual for more detailed description.

1.4 Testing Site

Test Site	SPORTON INTERNATIONAL INC.		
Test Site Location	No. 52, Hwa Ya 1 st Rd., Hwa Ya Technology Park, Kwei-Shan Hsiang, Tao Yuan Hsien, Taiwan, R.O.C. TEL: +886-3-3273456 / FAX: +886-3-3284978		
Test Site No.	Sporton Site No.		FCC/IC Registration No.
	CO05-HY	03CH05-HY	722060/4086B-1

1.5 Applied Standards

According to the specifications of the manufacturer, the EUT must comply with the requirements of the following standards:

- ♦ FCC Part 15 Subpart C §15.247
- ♦ FCC Public Notice DA 00-705
- ♦ ANSI C63.4-2003
- ♦ IC RSS-210 Issue 8

Remark:

1. All test items were verified and recorded according to the standards and without any deviation during the test.
2. This EUT has also been tested and complied with the requirements of FCC Part 15, Subpart B (DoC), recorded in a separate test report.



1.6 Ancillary Equipment List

Item	Equipment	Trade Name	Model Name	FCC ID	Data Cable	Power Cord
1.	System Simulator	R&S	CMU 200	N/A	N/A	Unshielded, 1.8 m
2.	GPS Station	T&E	GS-50	N/A	N/A	Unshielded, 1.8 m
3.	WLAN AP	D-Link	DIR-628	KA2DIR628A2	N/A	Unshielded, 1.8 m
4.	Bluetooth Base Station	R&S	CBT32	N/A	N/A	Unshielded, 1.8 m
5.	Notebook	DELL	Vostro 1510	FCC DoC	N/A	AC I/P: Unshielded, 1.2 m DC O/P: Shielded, 1.8 m
6.	Bluetooth Earphone	Nokia	BH-102	PYAHS-107W	N/A	N/A

2 Test Configuration of Equipment Under Test

2.1 RF Output Power

Preliminary tests were performed in different data rate and recorded the RF output power in the following table:

Channel	Frequency	Bluetooth RF Output Power		
		Data Rate / Modulation		
		GFSK	$\pi/4$ -DQPSK	8-DPSK
		1Mbps	2Mbps	3Mbps
Ch00	2402MHz	8.15 dBm	6.86 dBm	7.62 dBm
Ch39	2441MHz	7.92 dBm	6.66 dBm	7.39 dBm
Ch78	2480MHz	8.17 dBm	6.89 dBm	7.66 dBm

Remark:

1. The data rate was set in 1Mbps for all the test items due to the highest RF output power.
2. The EUT is programmed to transmit signals continuously for all testing.

2.2 Test Mode

The EUT has been associated with peripherals pursuant to ANSI C63.4-2003 and configuration operated in a manner tended to maximize its emission characteristics in a typical application. Frequency range investigated: conduction (150 kHz to 30 MHz), radiation (9 kHz to the 10th harmonic of the highest fundamental frequency or to 40 GHz, whichever is lower).

Pre-scanned tests were conducted to determine the final configuration from all possible combinations.

The following tables are showing the test modes as the worst cases and recorded in this report.

Test Cases			
Test Item	Data Rate / Modulation		
	Bluetooth 1Mbps GFSK	Bluetooth EDR 2Mbps $\pi/4$ -DQPSK	Bluetooth EDR 3Mbps 8-DPSK
Conducted TCs	Mode 1: CH00_2402 MHz Mode 2: CH39_2441 MHz Mode 3: CH78_2480 MHz	Mode 4: CH00_2402 MHz Mode 5: CH39_2441 MHz Mode 6: CH78_2480 MHz	Mode 7: CH00_2402 MHz Mode 8: CH39_2441 MHz Mode 9: CH78_2480 MHz
Radiated TCs	Mode 1: CH00_2402 MHz Mode 2: CH39_2441 MHz Mode 3: CH78_2480 MHz	N/A	N/A
AC Conducted Emission	Mode 1 : GSM850 Idle + Bluetooth Link + WLAN Link + Adapter + Earphone + GPS Rx		
Remark: For radiated TCs, the data rate was set in 1Mbps due to the highest RF output power; only the data of these modes was reported.			

2.3 Connection Diagram of Test System

<Bluetooth Tx Mode>

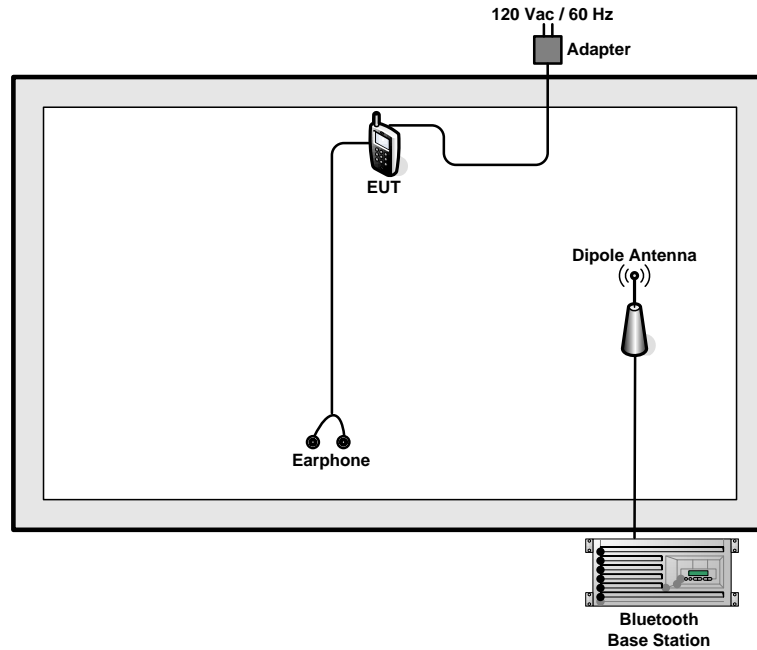

<AC Conducted Emission Mode>

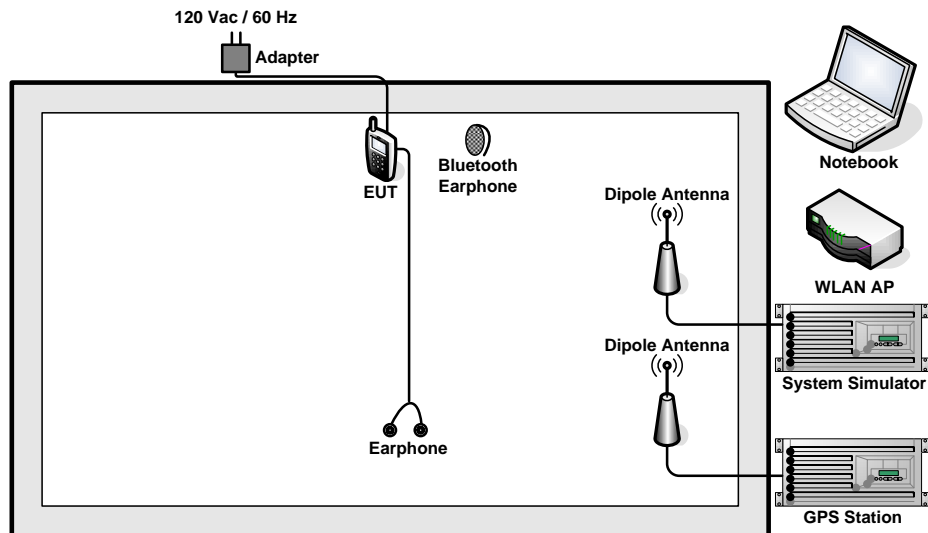

2.4 RF Utility

For Bluetooth function, key in “* # * # 767 # * # *” on the EUT directly. Then, the EUT will get into the engineering modes to contact with Bluetooth base station for transmitting and receiving signals continuously.

3 Test Result

3.1 Number of Channel Measurement

3.1.1 Limits of Number of Hopping Frequency

Frequency hopping systems in the 2400-2483.5 MHz band shall use at least 15 channels.

3.1.2 Measuring Instruments

See list of measuring instruments of this test report.

3.1.3 Test Procedure

1. The testing follows FCC Public Notice DA 00-705 Measurement Guidelines.
2. The RF output of EUT was connected to the spectrum analyzer by a low loss cable.
3. The modulation types of EUT are irrelevant to number of hopping channels deviation.
4. The EUT must have its hopping function enabled. Use the following spectrum analyzer settings:
Span = the frequency band of operation; RBW \geq 1% of the span; VBW \geq RBW; Sweep = auto;
Detector function = peak; Trace = max hold.
5. The number of hopping frequency used is defined as the device has the numbers of total channel.

3.1.4 Test Setup

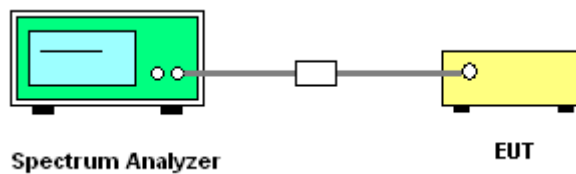

3.1.5 Test Result of Number of Hopping Frequency

Test Mode :	Mode 1~3	Temperature :	24~26°C
Test Engineer :	Pinkston Tu	Relative Humidity :	50~53%
Number of Hopping Channels (Channel)		Limits (Channel)	Pass/Fail
79		> 15	Pass



Number of Hopping Channel Plot on Channel 00 - 78

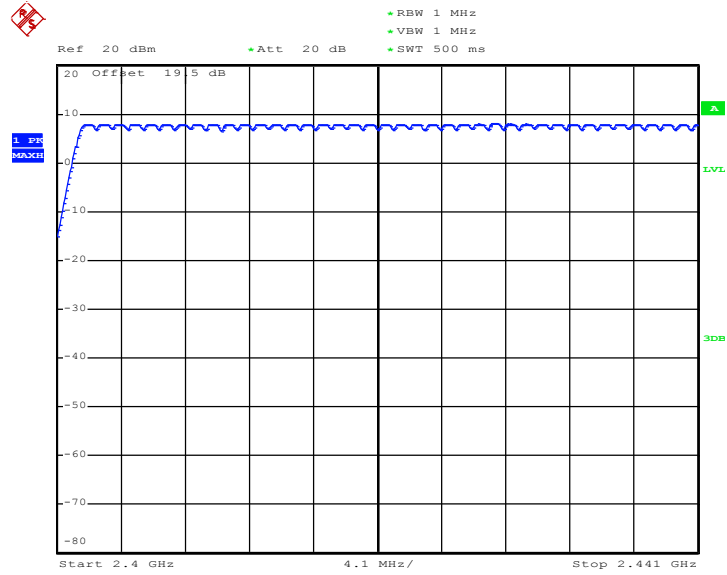

Date: 4.MAY.2011 09:32:11

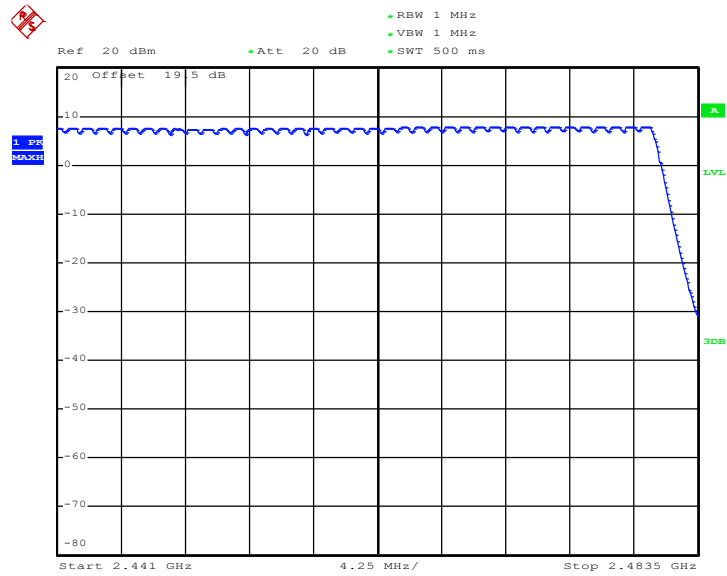

Date: 4.MAY.2011 09:36:39

3.2 20dB Bandwidth Measurement

3.2.1 Limit of 20dB Bandwidth

N/A

3.2.2 Measuring Instruments

See list of measuring instruments of this test report.

3.2.3 Test Procedures

1. The testing follows FCC Public Notice DA 00-705 Measurement Guidelines.
2. The RF output of EUT was connected to the spectrum analyzer by a low loss cable.
3. The EUT should be transmitting at its maximum data rate as the worst cases.
4. Use the following spectrum analyzer settings:
Span = approximately 2 to 3 times the 20 dB bandwidth, centered on a hopping channel;
RBW \geq 1% of the 20 dB bandwidth; VBW \geq RBW; Sweep = auto; Detector function = peak;
Trace = max hold.
5. The marker-delta reading at this point is the 20 dB bandwidth of the emission.

3.2.4 Test Setup

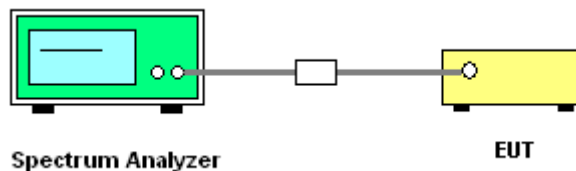



3.2.5 Test Result of 20dB Bandwidth

Test Mode :	Mode 1, 2, 3	Temperature :	24~26°C
Test Engineer :	Pinkston Tu	Relative Humidity :	50~53%

Channel	Frequency (MHz)	20dB Bandwidth (MHz)
00	2402	0.904
39	2441	0.904
78	2480	0.904

20 dB Bandwidth Plot on Channel 00

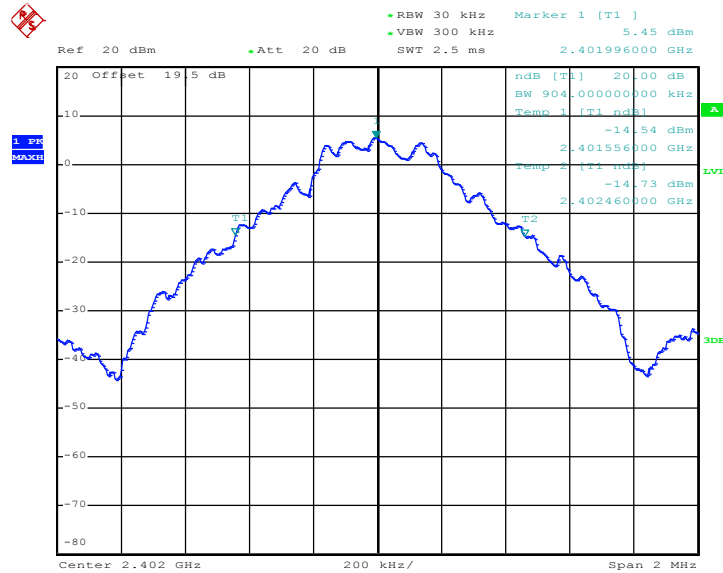

Date: 4.MAY.2011 09:08:53



20 dB Bandwidth Plot on Channel 39

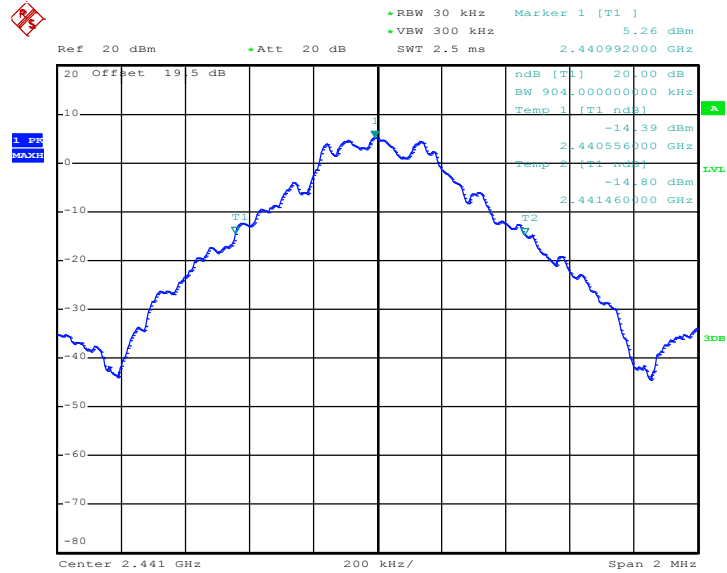

Date: 4.MAY.2011 09:09:58

20 dB Bandwidth Plot on Channel 78

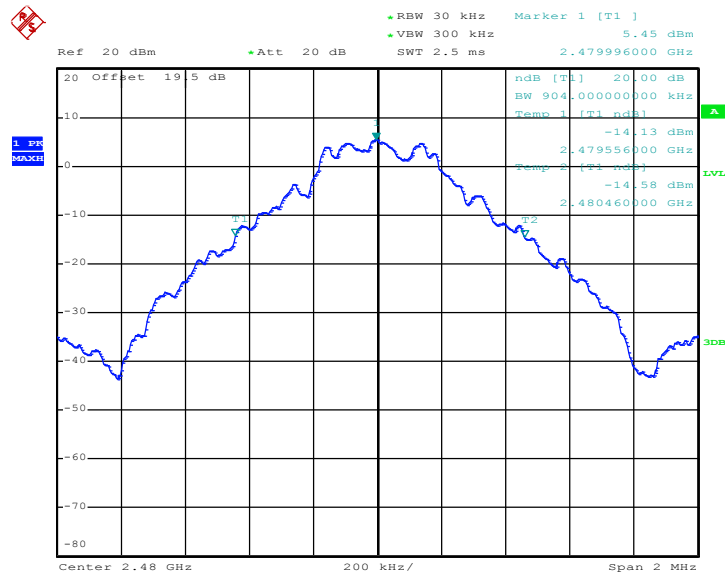

Date: 4.MAY.2011 09:10:55



Test Mode :	Mode 4, 5, 6	Temperature :	24~26°C
Test Engineer :	Pinkston Tu	Relative Humidity :	50~53%

Channel	Frequency (MHz)	20dB Bandwidth (MHz)
00	2402	1.338
39	2441	1.350
78	2480	1.350

20 dB Bandwidth Plot on Channel 00

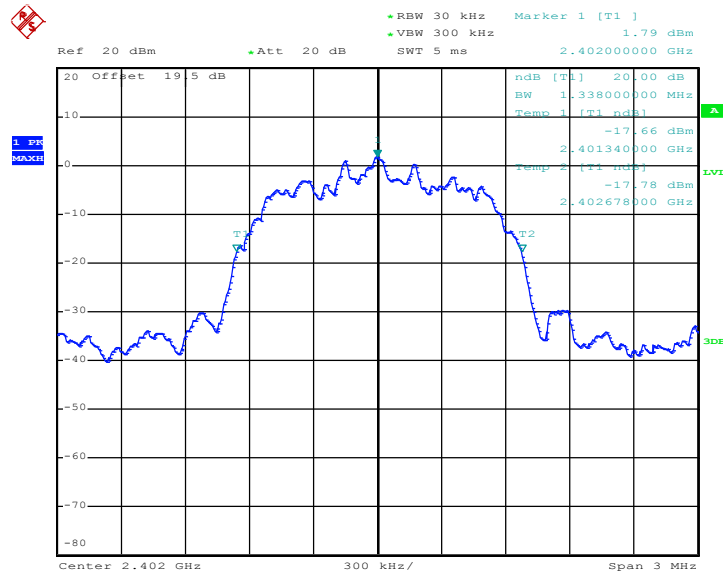

Date: 4.MAY.2011 09:11:54



20 dB Bandwidth Plot on Channel 39

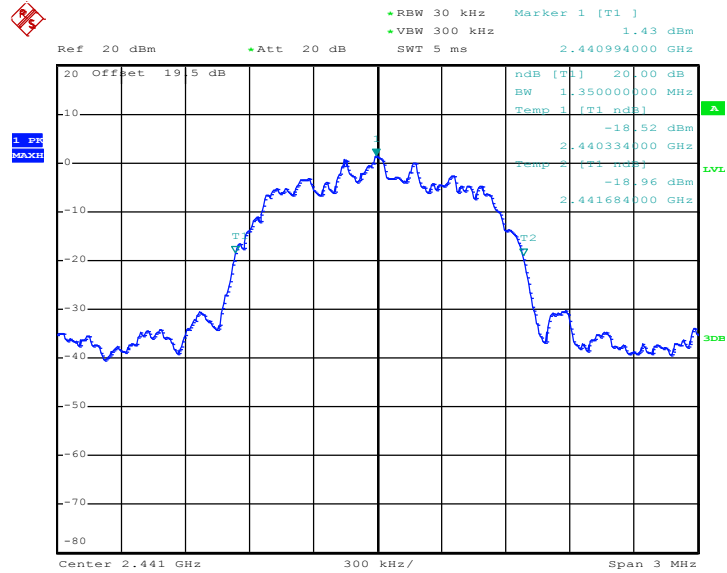

Date: 4.MAY.2011 09:12:22

20 dB Bandwidth Plot on Channel 78

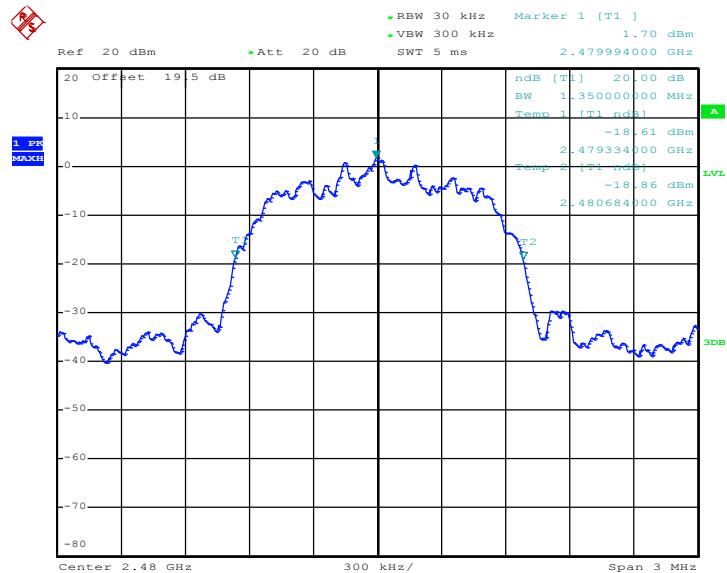

Date: 4.MAY.2011 09:12:48



Test Mode :	Mode 7, 8, 9	Temperature :	24~26°C
Test Engineer :	Pinkston Tu	Relative Humidity :	50~53%

Channel	Frequency (MHz)	20dB Bandwidth (MHz)
00	2402	1.338
39	2441	1.338
78	2480	1.332

20 dB Bandwidth Plot on Channel 00

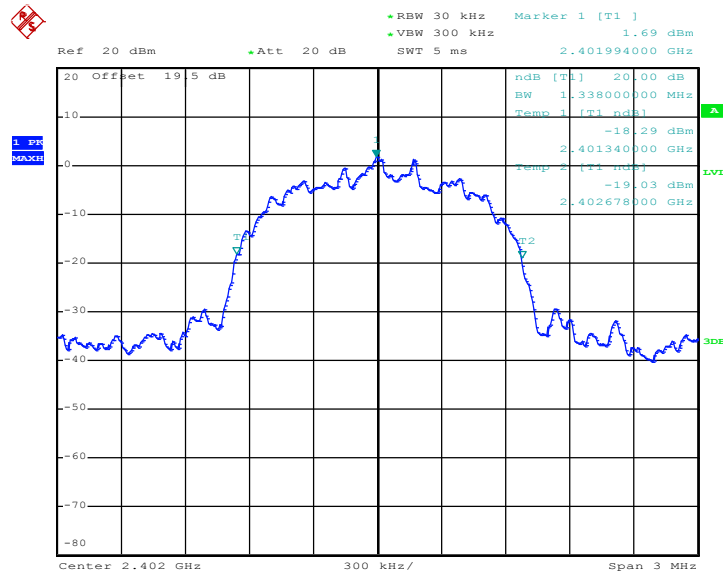

Date: 4.MAY.2011 09:13:22



20 dB Bandwidth Plot on Channel 39

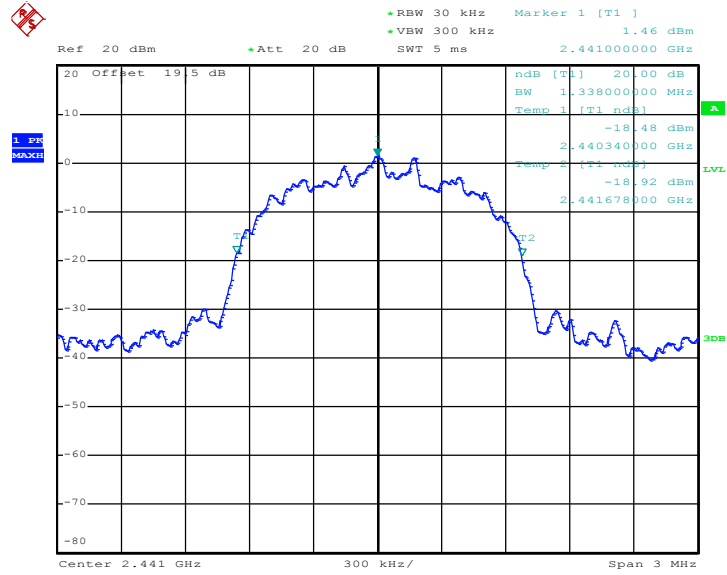

Date: 4.MAY.2011 09:13:50

20 dB Bandwidth Plot on Channel 78

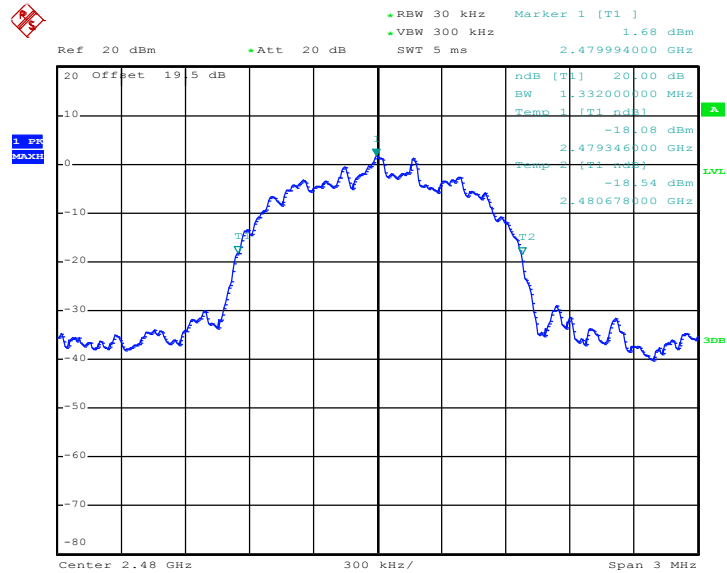

Date: 4.MAY.2011 09:14:09

3.3 Hopping Channel Separation Measurement

3.3.1 Limit of Hopping Channel Separation

Frequency hopping systems operating in the 2400-2483.5 MHz band may have hopping channel carrier frequencies that are separated by 25 kHz or two-thirds of the 20 dB bandwidth of the hopping channel, whichever is greater.

3.3.2 Measuring Instruments

See list of measuring instruments of this test report.

3.3.3 Test Procedures

1. Please refer FCC Public Notice DA 00-705 Measurement Guidelines.
2. The RF output of EUT was connected to the spectrum analyzer by a low loss cable.
3. The EUT should be transmitting at its maximum data rate as the worst cases.
4. Use the following spectrum analyzer settings:
Span = wide enough to capture the peaks of two adjacent channels; RBW \geq 1% of the span;
VBW \geq RBW; Sweep = auto; Detector function = peak; Trace = max hold.
5. Use the marker-delta function to determine the separation between the peaks of the adjacent channels.

3.3.4 Test Setup

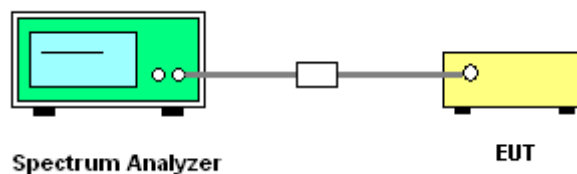



3.3.5 Test Result of Hopping Channel Separation

Test Mode :	Mode 1, 2, 3	Temperature :	24~26°C
Test Engineer :	Pinkston Tu	Relative Humidity :	50~53%

Channel	Frequency (MHz)	Frequency Separation (MHz)	(2/3 of 20dB BW) Limits (MHz)	Pass/Fail
00	2402	1.002	0.603	Pass
39	2441	1.002	0.603	Pass
78	2480	1.002	0.603	Pass

Channel Separation Plot on Channel 00 - 01

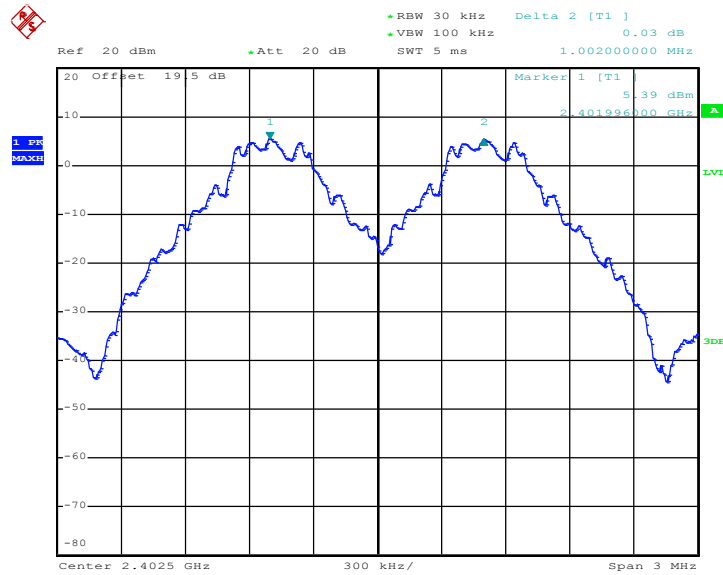

Date: 4.MAY.2011 08:46:31



Channel Separation Plot on Channel 39 - 40

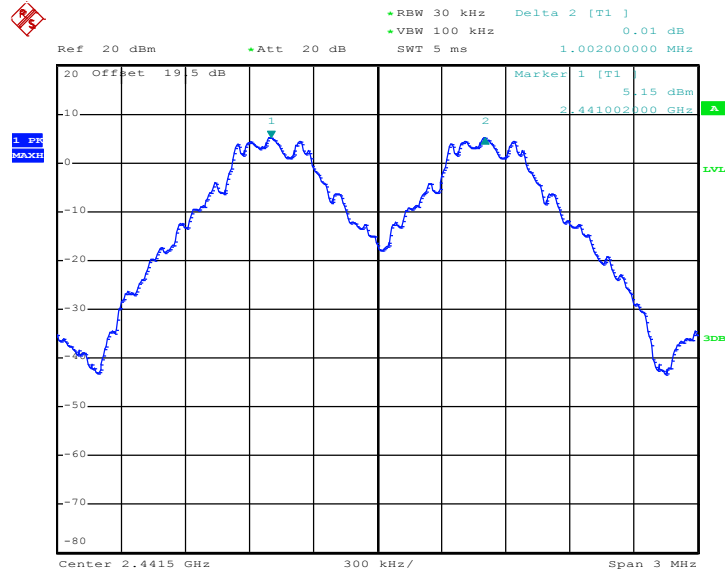

Date: 4.MAY.2011 08:48:42

Channel Separation Plot on Channel 77 - 78

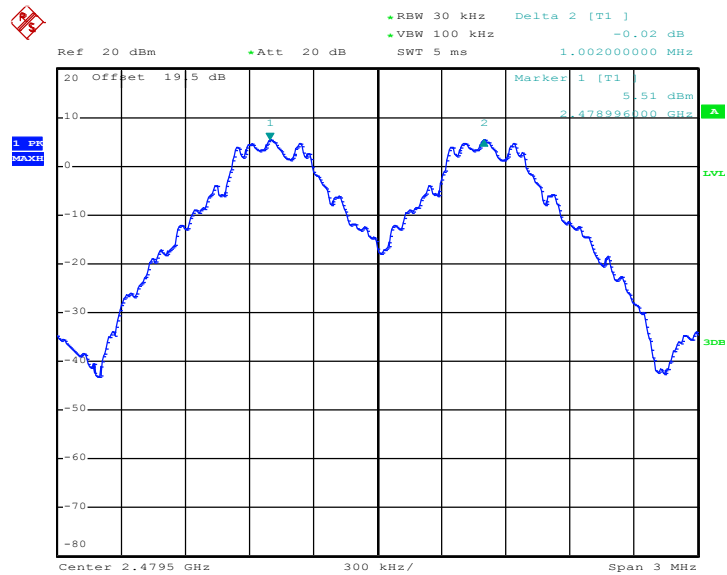

Date: 4.MAY.2011 08:50:40

3.4 Dwell Time Measurement

3.4.1 Limit of Dwell Time

The average time of occupancy on any channel shall not be greater than 0.4 seconds within a period of 0.4 seconds multiplied by the number of hopping channels employed.

3.4.2 Measuring Instruments

See list of measuring instruments of this test report.

3.4.3 Test Procedures

1. The testing follows FCC Public Notice DA 00-705 Measurement Guidelines.
2. The RF output of EUT was connected to the spectrum analyzer by a low loss cable.
3. The EUT should be transmitting at its maximum data rate as the worst cases.
4. The EUT must have its hopping function enabled. Use the following spectrum analyzer settings:
Span = zero span, centered on a hopping channel; RBW = 1 MHz; VBW ≥ RBW; Sweep = as necessary to capture the entire dwell time per hopping channel; Detector function = peak; Trace = max hold.
5. Use the marker-delta function to calculate the dwell time.

3.4.4 Test Setup

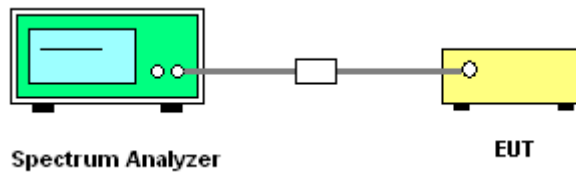

3.4.5 Test Result of Dwell Time

Test Mode :	Mode 2	Temperature :	24~26°C		
Test Engineer :	Pinkston Tu	Relative Humidity :	50~53%		
Package Mode	Average Hopping Channel	Package Transfer Time (usec)	Dwell Time (sec)	Limits (sec)	Pass/Fail
DH5	3.40	3004.00	0.32	0.4	Pass

Remark:

1. Dwell Time=79(channels) x 0.4(s) x average hopping channel x package transfer time
2. 79 channels come from the Hopping Channel number.
3. Average Hopping Channel = hops/sweep time
4. t: Package Transfer Time(us)



DH5 Dwell Time (One Pulse) Plot on Channel 39

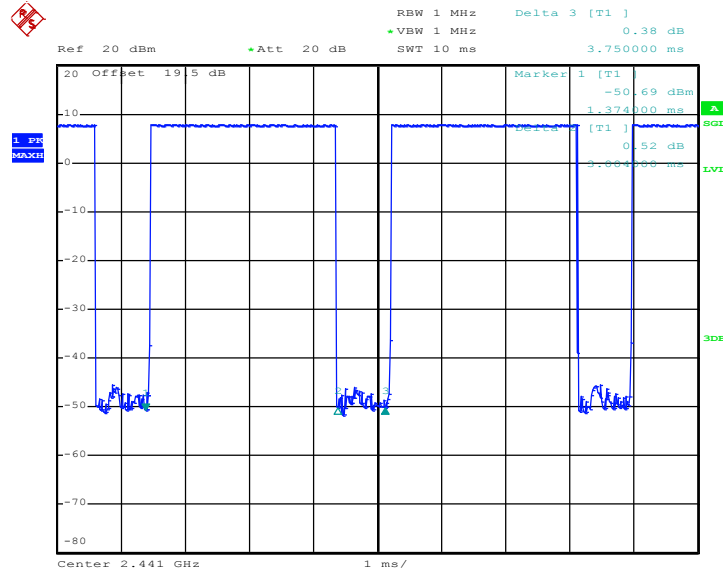

Date: 4.MAY.2011 08:41:21

DH5 Dwell Time (Count Pulses) Plot on Channel 39

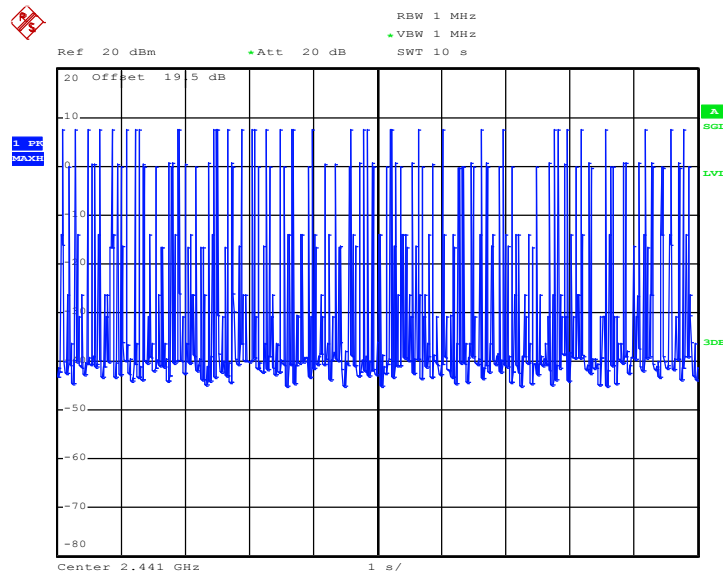

Date: 4.MAY.2011 09:06:47

3.5 Peak Output Power Measurement

3.5.1 Limit of Peak Output Power

Frequency hopping systems operating in the 2400-2483.5 MHz band may have hopping channel carrier frequencies that are separated by 25 kHz or two-thirds of the 20 dB bandwidth of the hopping channel, whichever is greater, provided the systems operate with an output power no greater than 125 mW (20.97dBm).

3.5.2 Measuring Instruments

See list of measuring instruments of this test report.

3.5.3 Test Procedures

1. The testing follows FCC Public Notice DA 00-705 Measurement Guidelines.
2. The RF output of EUT was connected to the spectrum analyzer by a low loss cable.

3.5.4 Test Setup

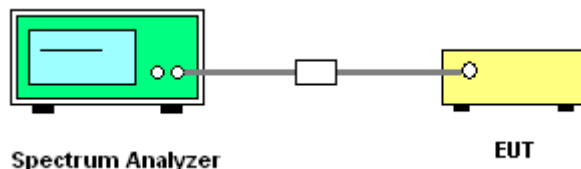

3.5.5 Test Result of Peak Output Power

Test Mode :	Mode 1, 2, 3	Temperature :	24~26°C	
Test Engineer :	Pinkston Tu	Relative Humidity :	50~53%	
Channel	Frequency (MHz)	RF Power (dBm)		
		GFSK	Max. Limits (dBm)	Pass/Fail
		1 Mbps		
00	2402	8.15	20.97	Pass
39	2441	7.92	20.97	Pass
78	2480	8.17	20.97	Pass



Peak Output Power Plot on Channel 00

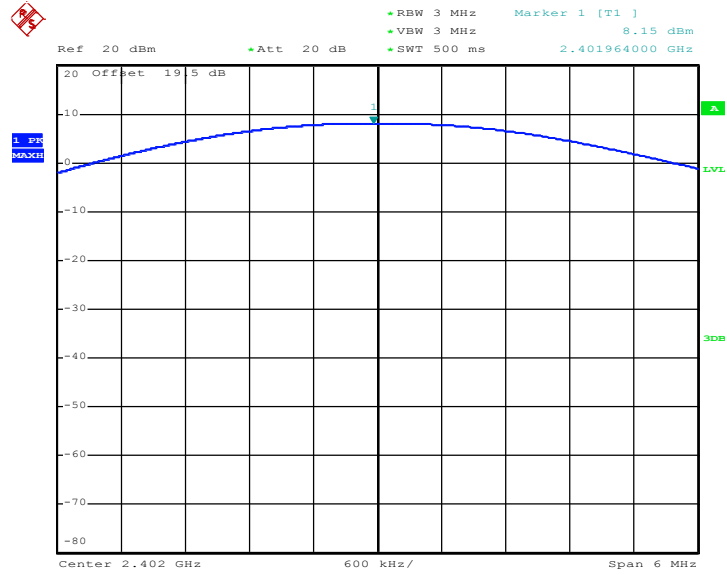

Date: 4.MAY.2011 08:33:45

Peak Output Power Plot on Channel 39

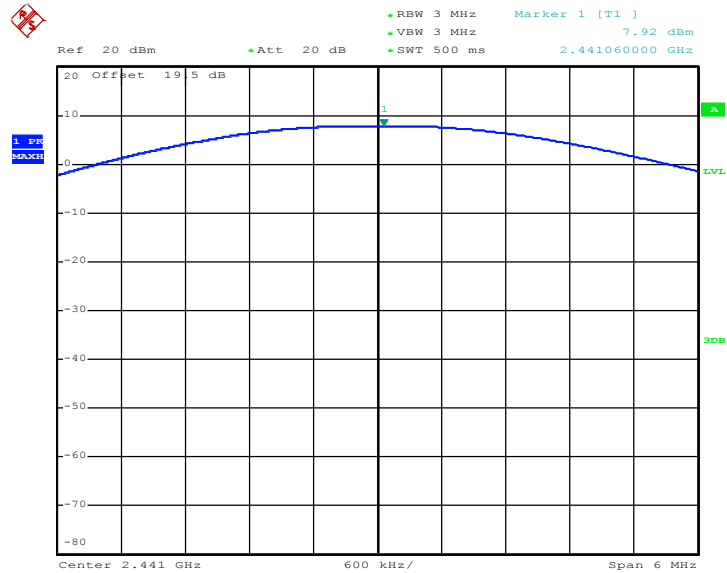

Date: 4.MAY.2011 08:35:00



Peak Output Power Plot on Channel 78

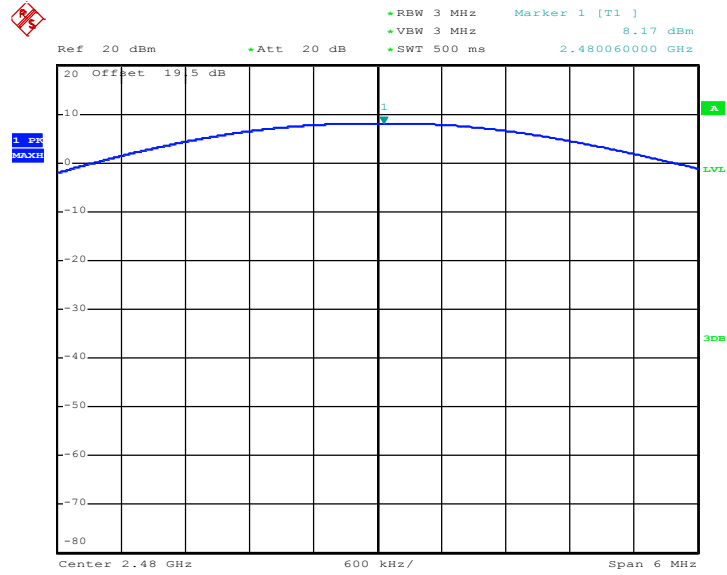

Date: 4.MAY.2011 08:36:14



3.6 Band Edges Measurement

3.6.1 Limit of Band Edges

In any 100 kHz bandwidth outside the intentional radiation frequency band, the radio frequency power shall be at least 20 dB below the highest level of the radiated power. In addition, radiated emissions which fall in the restricted bands must also comply with the radiated emission limits.

3.6.2 Measuring Instruments

See list of measuring instruments of this test report.

3.6.3 Test Procedures

1. The testing follows the guidelines in ANSI C63.4-2003 and FCC Public Notice DA 00-705 Measurement Guidelines.
2. RF antenna conducted test: Set RBW = 300kHz, Video bandwidth (VBW) \geq RBW. Band edge emissions must be at least 20 dB down from the highest emission level within the authorized band as measured with a 300k Hz RBW. Note: If the device complies with the use of power option 2 the attenuation under this paragraph shall be 30 dB instead of 20 dB.
3. Radiated emission test: Applies to band edge emissions that fall in the restricted bands listed in FCC Section 15.205. The maximum permitted average field strength is listed in FCC Section 15.209. A pre-amp is necessary for this measurement. For measurements above 1 GHz, set RBW = 1MHz, VBW = 1MHz, Sweep: Auto for Peak; set RBW = 1MHz, VBW = 10 Hz, Sweep: Auto for Average. If the emission is pulsed, modify the unit for continuous operation; use the settings shown above, then correct the reading by subtracting the peak-average correction factor, derived from the appropriate duty cycle calculation. See FCC Section 15.35(b) and (c).
4. In case the emission is fail due to the used RBW / VBW is too wide, marker-delta method of FCC Public Notice DA 00-705 will be followed.

3.6.4 Test Setup

<Radiated Band Edges>

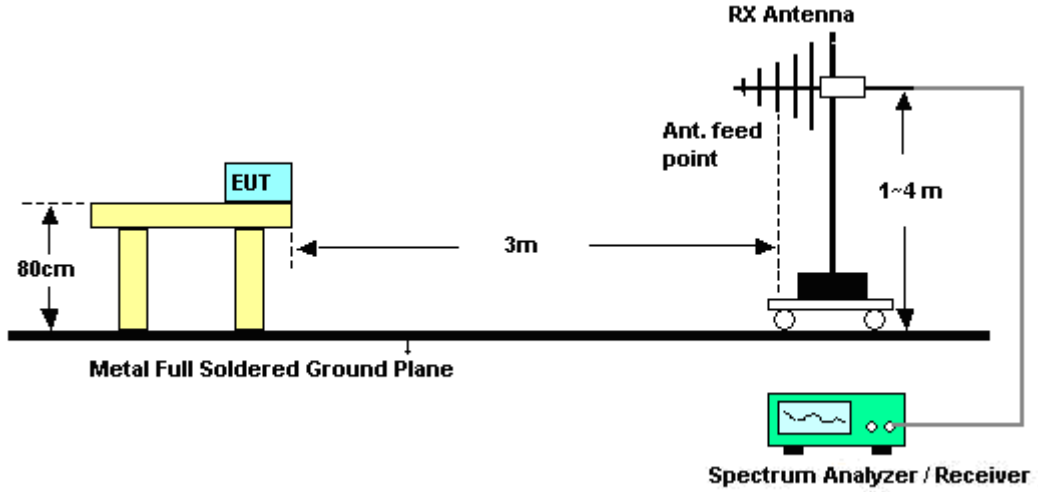

<Conducted Band Edges>

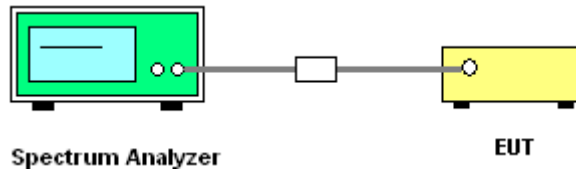



3.6.5 Test Result of Radiated Band Edges

Test Mode :	Mode 1	Temperature :	23~26°C
Test Channel :	00	Relative Humidity :	54~60%
		Test Engineer :	Wii Chang

ANTENNA POLARITY : HORIZONTAL										
Frequency (MHz)	Level (dBuV/m)	Over Limit (dB)	Limit Line (dBuV/m)	Read Level (dBuV)	Antenna Factor (dB)	Cable Loss (dB)	Preamp Factor (dB)	Ant Pos (cm)	Table Pos (deg)	Remark
2378	54.82	-19.18	74	52.75	31.68	4.47	34.08	147	25	Peak
2378	33.91	-20.09	54	31.84	31.68	4.47	34.08	147	25	Average

ANTENNA POLARITY : VERTICAL										
Frequency (MHz)	Level (dBuV/m)	Over Limit (dB)	Limit Line (dBuV/m)	Read Level (dBuV)	Antenna Factor (dB)	Cable Loss (dB)	Preamp Factor (dB)	Ant Pos (cm)	Table Pos (deg)	Remark
2378	56.65	-17.35	74	54.58	31.68	4.47	34.08	100	43	Peak
2378	33.18	-20.82	54	31.11	31.68	4.47	34.08	100	43	Average



Test Mode :	Mode 3	Temperature :	23~26°C
Test Channel :	78	Relative Humidity :	54~60%
		Test Engineer :	Wii Chang

ANTENNA POLARITY : HORIZONTAL										
Frequency (MHz)	Level (dBuV/m)	Over Limit (dB)	Limit Line (dBuV/m)	Read Level (dBuV)	Antenna Factor (dB)	Cable Loss (dB)	Preamp Factor (dB)	Ant Pos (cm)	Table Pos (deg)	Remark
2483.5	55.14	-18.86	74	52.85	31.78	4.59	34.08	170	33	Peak
2483.5	39.74	-14.26	54	37.45	31.78	4.59	34.08	170	33	Average

Summary results of marker-delta method:

Test mode	Maximum field strength of the fundamental emission (dBµV/m)	Delta Result (dB)	Average Result (dBµV/m)	Average Limit (dBµV/m)	Margin (dB)	Result
Single Carrier Mode	91.4	51.66	39.74	54	-14.26	Pass
Hopping Mode	91.4	51.75	39.65	54	-14.35	Pass

Note : Average result = Maximum field strength – Delta result

Summary results of marker-delta method:

Test mode	Maximum field strength of the fundamental emission (dBµV/m)	Delta Result (dB)	Peak Result (dBuV/m)	Peak Limit (dBuV/m)	Margin (dB)	Result
Single Carrier Mode	106.8	51.66	55.14	74	-18.86	Pass
Hopping Mode	106.8	51.75	55.05	74	-18.95	Pass

Note : Peak result = Maximum field strength – Delta result



ANTENNA POLARITY : VERTICAL										
Frequency (MHz)	Level (dBuV/m)	Over Limit (dB)	Limit Line (dBuV/m)	Read Level (dBuV)	Antenna Factor (dB)	Cable Loss (dB)	Preamp Factor (dB)	Ant Pos (cm)	Table Pos (deg)	Remark
2483.5	50.28	-23.72	74	47.99	31.78	4.59	34.08	128	51	Peak
2483.5	35.12	-18.88	54	32.83	31.78	4.59	34.08	128	51	Average

Summary results of marker-delta method:

Test mode	Maximum field strength of the fundamental emission (dBµV/m)	Delta Result (dB)	Average Result (dBµV/m)	Average Limit (dBµV/m)	Margin (dB)	Result
Single Carrier Mode	88.28	57.59	30.69	54	-23.31	Pass
Hopping Mode	88.28	53.16	35.12	54	-18.88	Pass

Note : Average result = Maximum field strength – Delta result

Summary results of marker-delta method:

Test mode	Maximum field strength of the fundamental emission (dBµV/m)	Delta Result (dB)	Peak Result (dBuV/m)	Peak Limit (dBuV/m)	Margin (dB)	Result
Single Carrier Mode	103.44	57.59	45.85	74	-28.15	Pass
Hopping Mode	103.44	53.16	50.28	74	-23.72	Pass

Note : Peak result = Maximum field strength – Delta result



Test Mode :	Mode 3	Temperature :	23~26°C
Test Channel :	78	Relative Humidity :	54~60%
Test Engineer :	Wii Chang	Polarization :	Horizontal

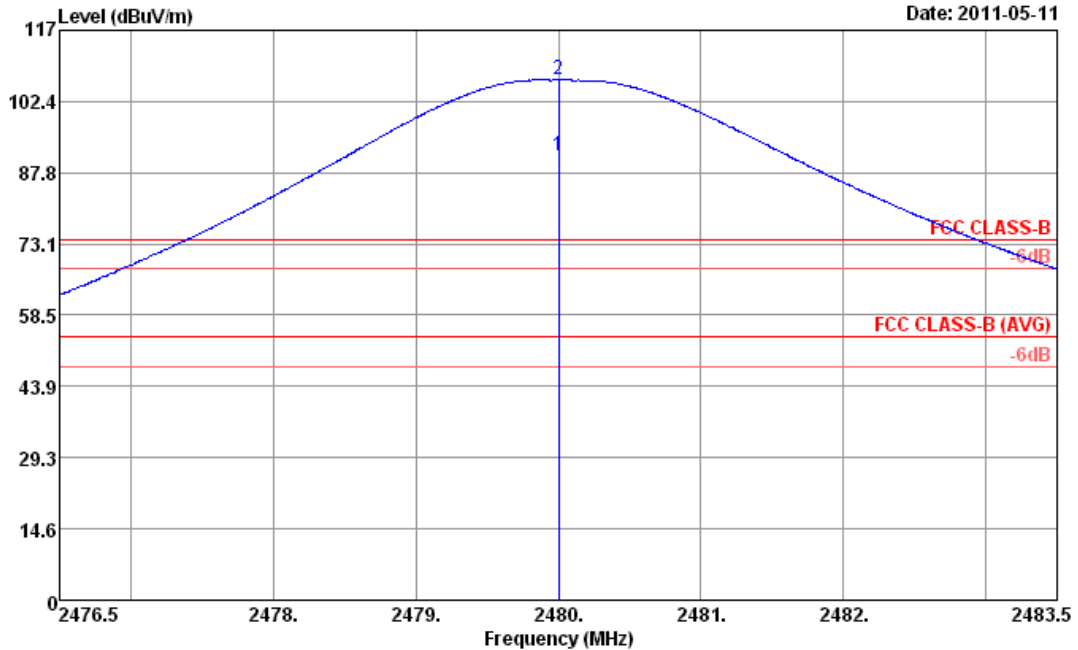

Site : 03CH05-HY
 Condition : FCC CLASS-B 3m HF_ANT_100824 HORIZONTAL
 Project : FR 142113
 Mode : Mode 3

	Freq	Level	Over Limit	Limit Line	ReadAntenna Level	Antenna Factor	Cable Loss	Preamp Factor	A/Pos	T/Pos	Remark
	MHz	dBuV/m	dB	dBuV/m	dBuV	dB/m	dB	dB	cm	deg	
1 *	2480.00	91.40	37.40	54.00	89.11	31.78	4.59	34.08	170	33	Average
2 *	2480.00	106.80	32.80	74.00	104.51	31.78	4.59	34.08	170	33	Peak

* Maximum field strength of the fundamental emission



Test Mode :	Mode 3	Temperature :	23~26°C
Test Channel :	78	Relative Humidity :	54~60%
Test Engineer :	Wii Chang	Polarization :	Horizontal

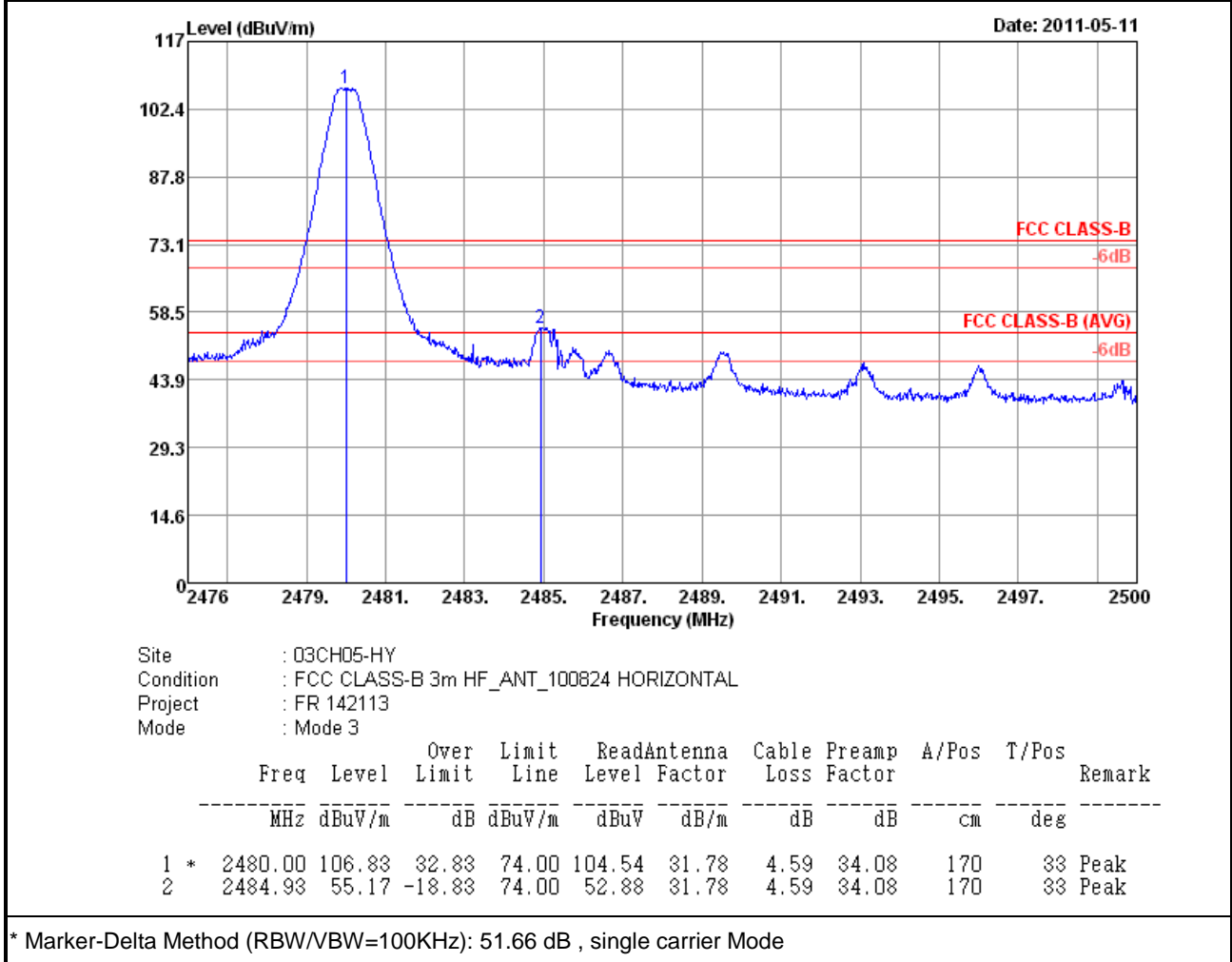



Test Mode :	Mode 3	Temperature :	23~26°C
Test Channel :	78	Relative Humidity :	54~60%
Test Engineer :	Wii Chang	Polarization :	Horizontal

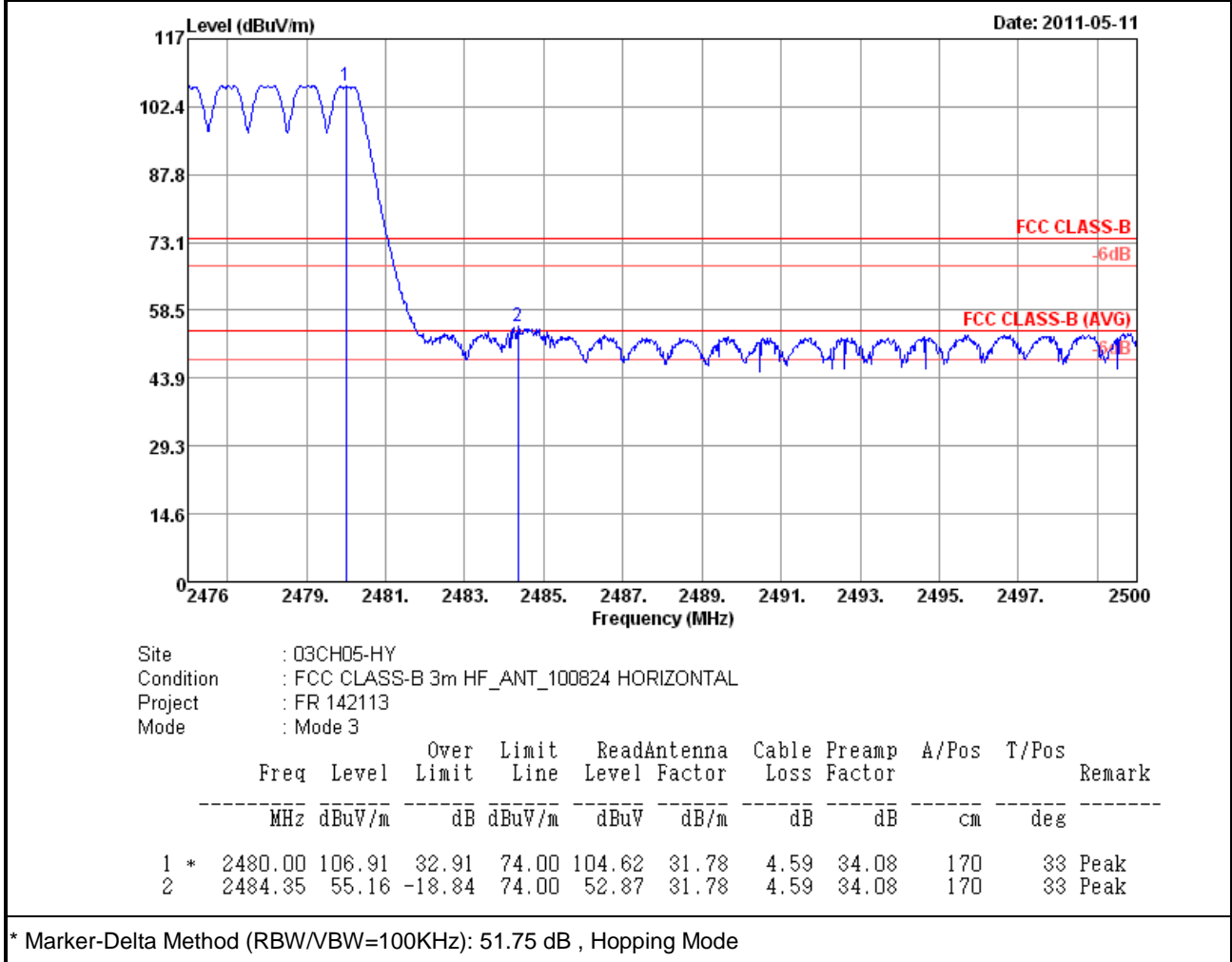



Test Mode :	Mode 3	Temperature :	23~26°C
Test Channel :	78	Relative Humidity :	54~60%
Test Engineer :	Wii Chang	Polarization :	Vertical

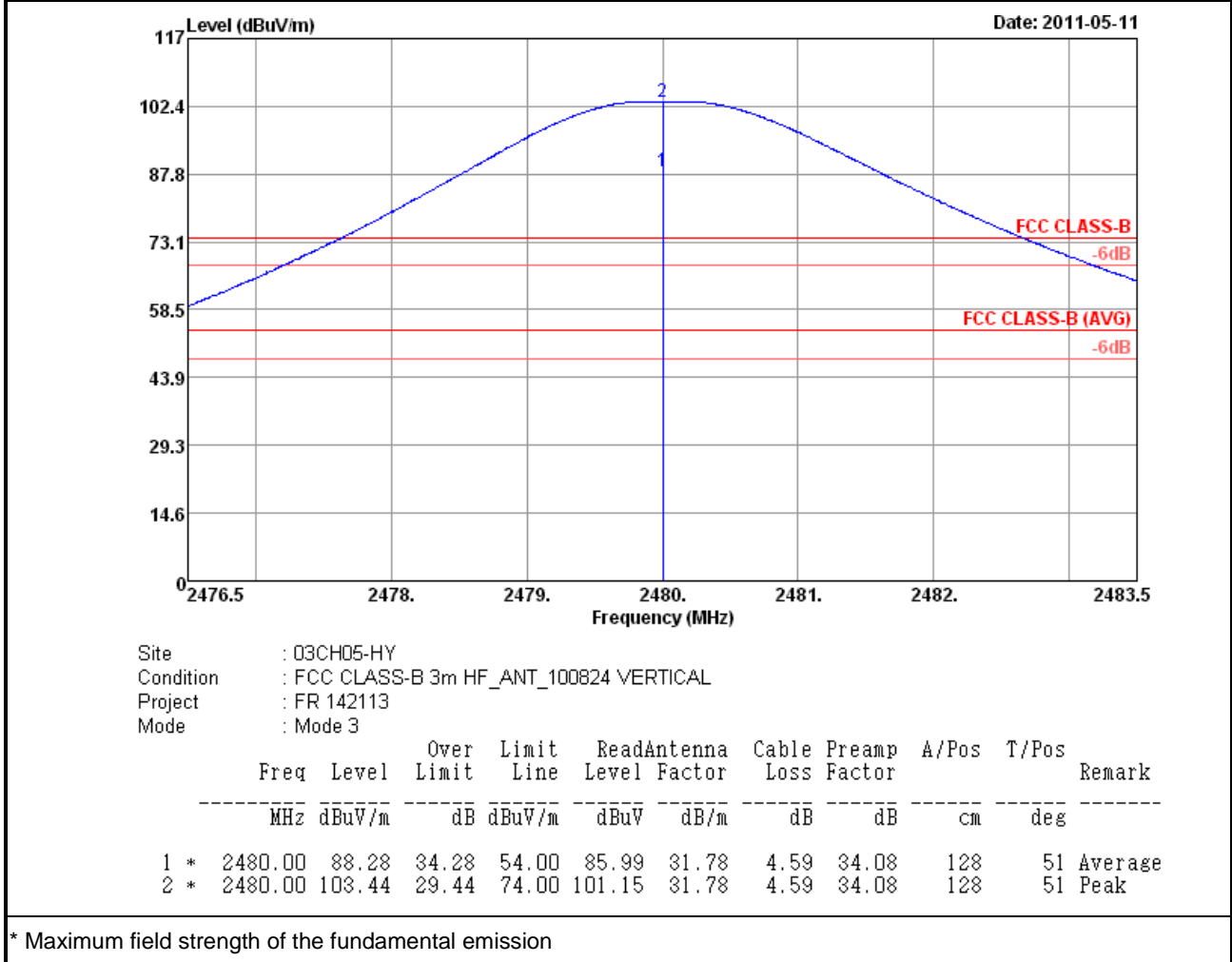



Test Mode :	Mode 3	Temperature :	23~26°C
Test Channel :	78	Relative Humidity :	54~60%
Test Engineer :	Wii Chang	Polarization :	Vertical

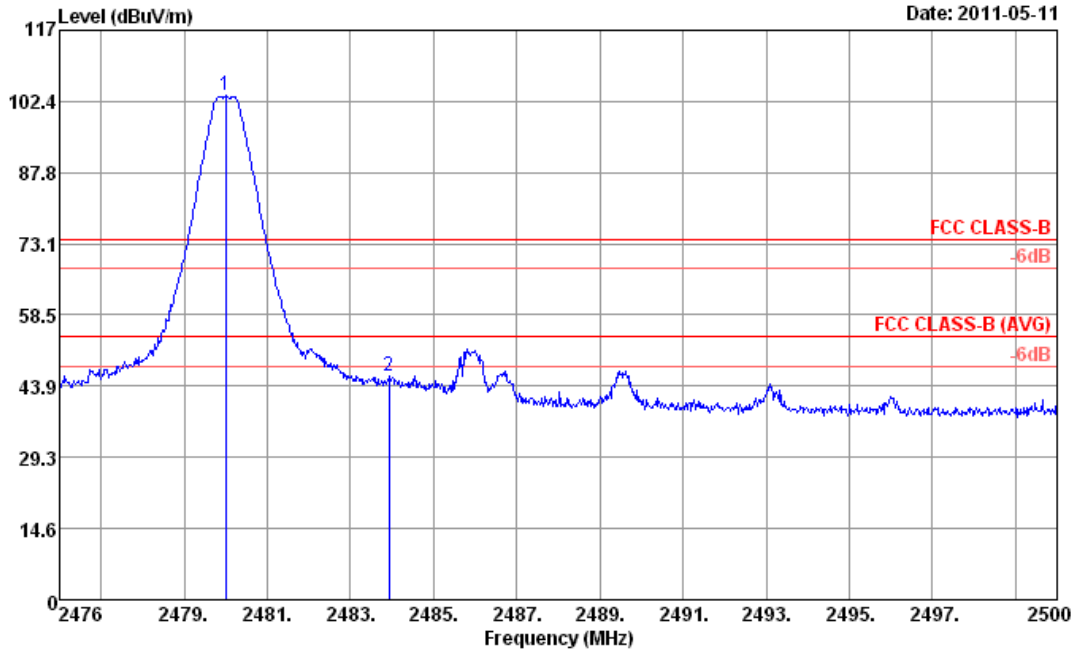

Site : 03CH05-HY
 Condition : FCC CLASS-B 3m HF_ANT_100824 VERTICAL
 Project : FR 142113
 Mode : Mode 3

	Over	Limit	ReadAntenna	Cable	Preamp	A/Pos	T/Pos	Remark
-----	Limit	Line	Level Factor	Loss	Factor	-----	-----	-----
-----	dB	dBuV/m	dBuV	dB	dB	cm	deg	-----
1 *	29.50	74.00	101.21	31.78	4.59	34.08	128	51 Peak
2	-28.09	74.00	43.62	31.78	4.59	34.08	128	51 Peak

* Marker-Delta Method (RBW/VBW=100KHz): 57.59 dB , single carrier Mode



Test Mode :	Mode 3	Temperature :	23~26°C
Test Channel :	78	Relative Humidity :	54~60%
Test Engineer :	Wii Chang	Polarization :	Vertical

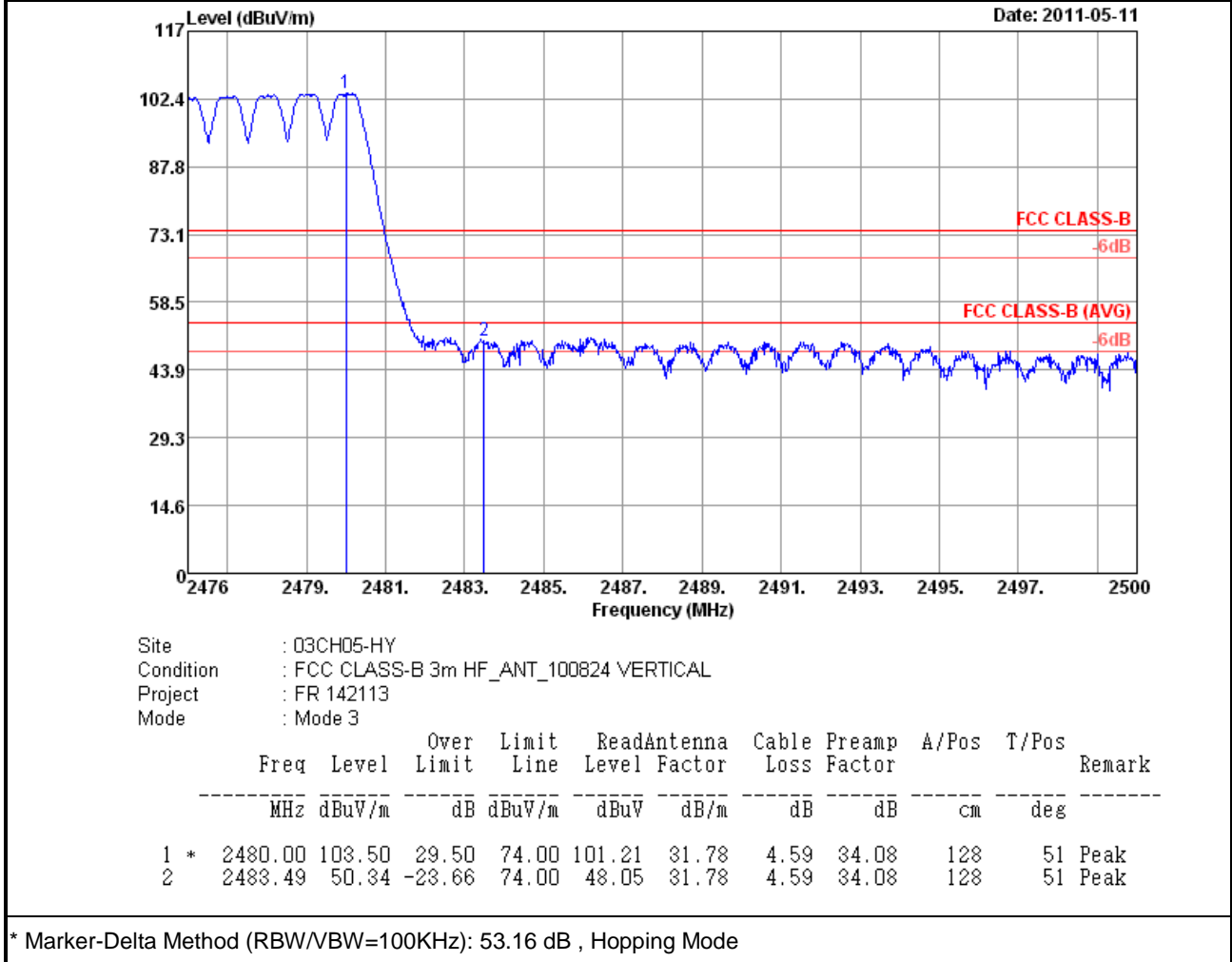



3.6.6 Test Result of Conducted Band Edges

Test Mode :	Mode 1 and 3	Temperature :	24~26°C
Test Channel :	00 and 78	Relative Humidity :	50~53%
		Test Engineer :	Pinkston Tu

Low Band Edge Plot on Channel 00

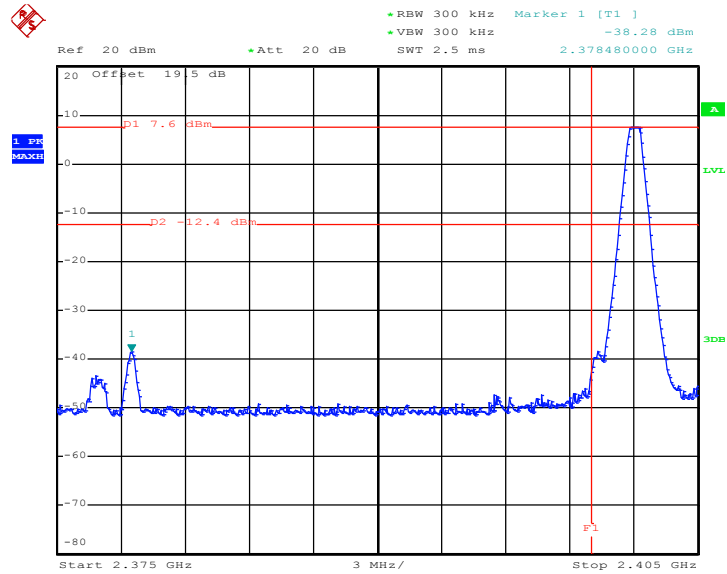

Date: 4.MAY.2011 09:44:47

High Band Edge Plot on Channel 78

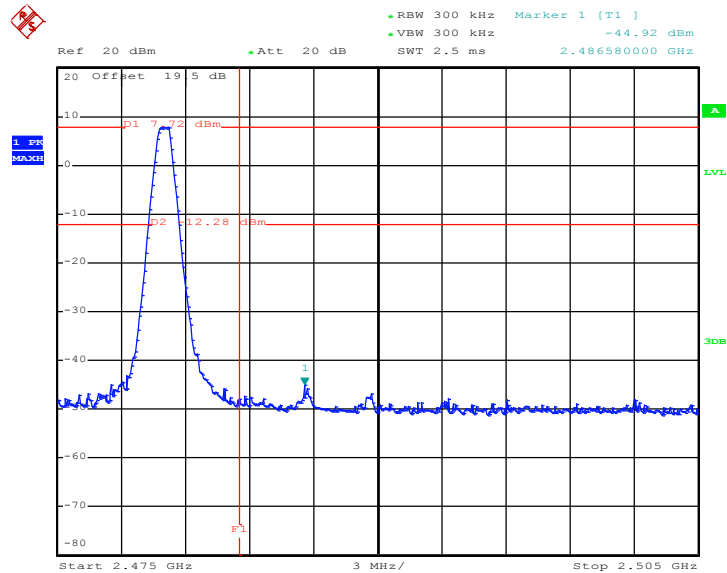

Date: 4.MAY.2011 09:38:53

3.7 Spurious Emission Measurement

3.7.1 Limit of Spurious Emission Measurement

All harmonics/spurious must be at least 20 dB down from the highest emission level within the authorized band.

3.7.2 Measuring Instruments

See list of measuring instruments of this test report.

3.7.3 Test Procedure

1. The transmitter output was connected to the spectrum analyzer via a low lose cable.
2. Set RBW = 100 kHz, Video bandwidth (VBW) \geq RBW, scan up through 10th harmonic. All harmonics / spurs must be at least 20 dB down from the highest emission level within the authorized band as measured with a 100 kHz RBW.

3.7.4 Test Setup

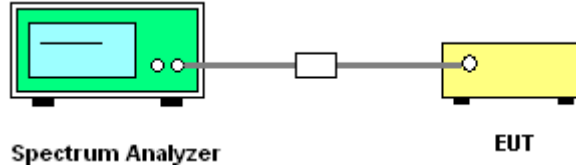



3.7.5 Test Result

Test Mode :	Mode 1	Temperature :	24~26°C
Test Channel :	00	Relative Humidity :	50~53%
		Test Engineer :	Pinkston Tu

Conducted Spurious Emission Plot between 30MHz ~ 3 GHz

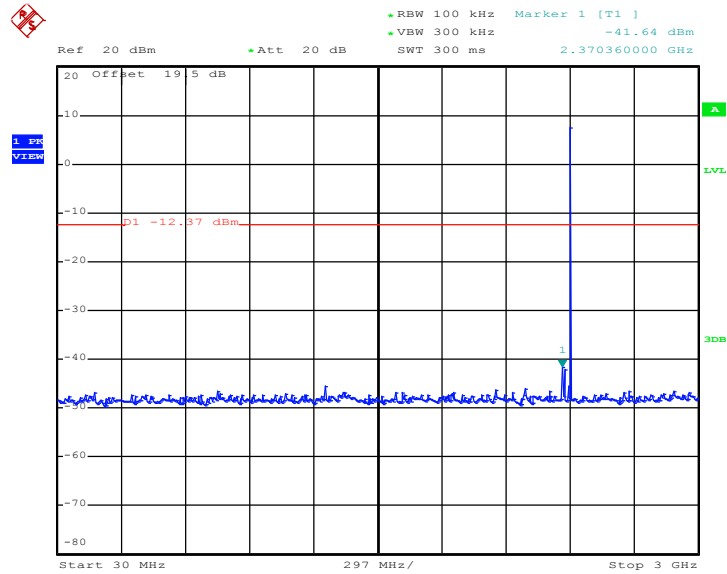

Date: 4.MAY.2011 09:26:13

Conducted Spurious Emission Plot between 3 GHz ~ 25 GHz

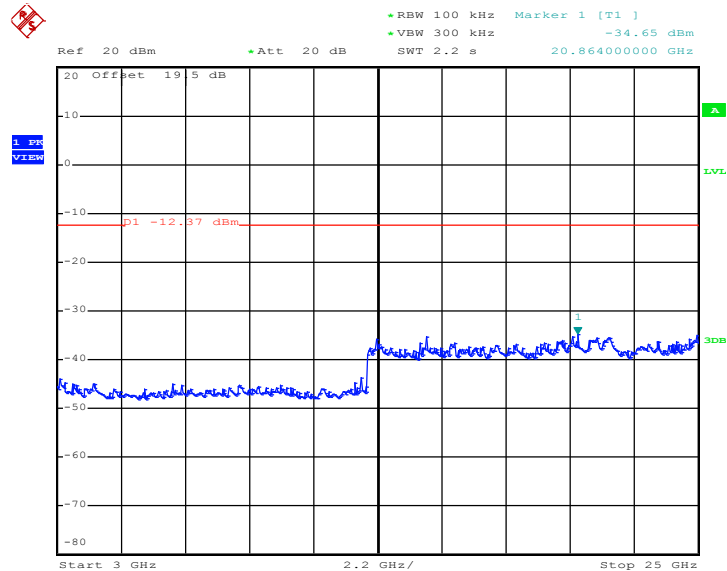

Date: 4.MAY.2011 09:26:25



Test Mode :	Mode 2	Temperature :	24~26°C
Test Channel :	39	Relative Humidity :	50~53%
		Test Engineer :	Pinkston Tu

Conducted Spurious Emission Plot between 30MHz ~ 3 GHz

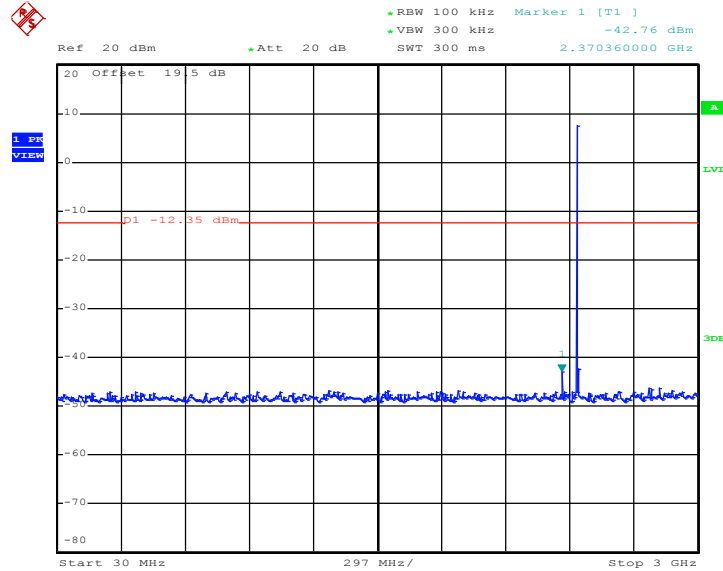

Date: 4.MAY.2011 09:27:17

Conducted Spurious Emission Plot between 3 GHz ~ 25 GHz

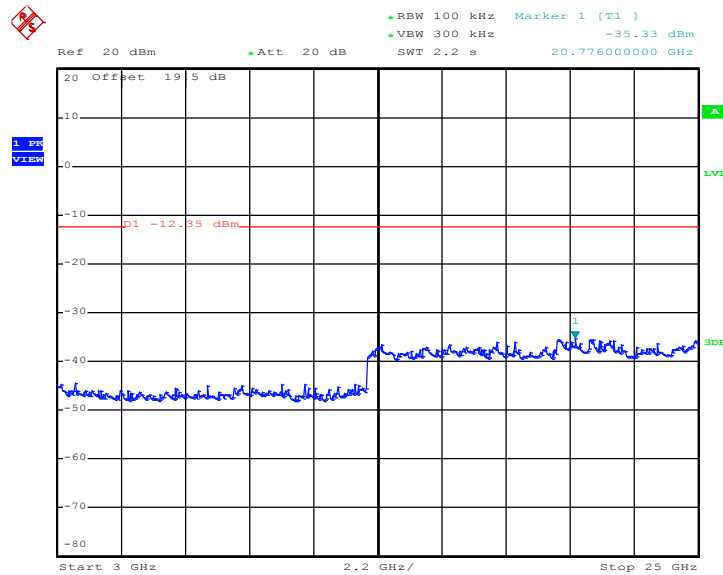

Date: 4.MAY.2011 09:27:29



Test Mode :	Mode 3	Temperature :	24~26°C
Test Channel :	78	Relative Humidity :	50~53%
		Test Engineer :	Pinkston Tu

Conducted Spurious Emission Plot between 30MHz ~ 3 GHz

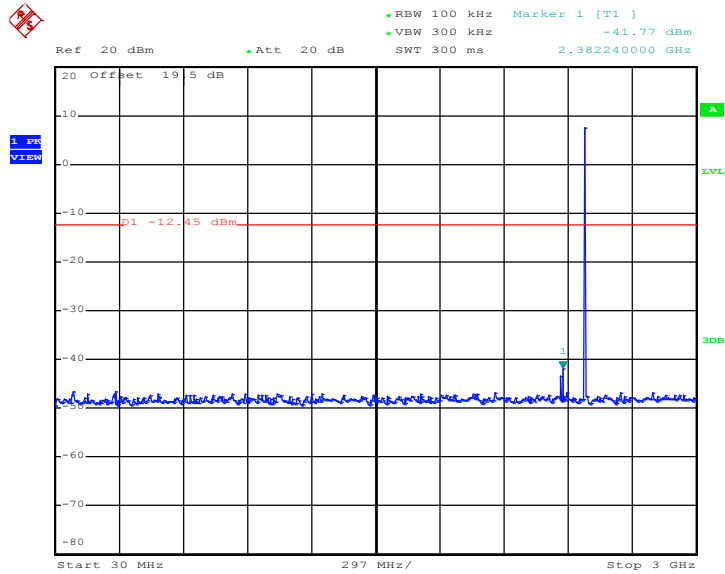

Date: 4.MAY.2011 09:28:21

Conducted Spurious Emission Plot between 3 GHz ~ 25 GHz

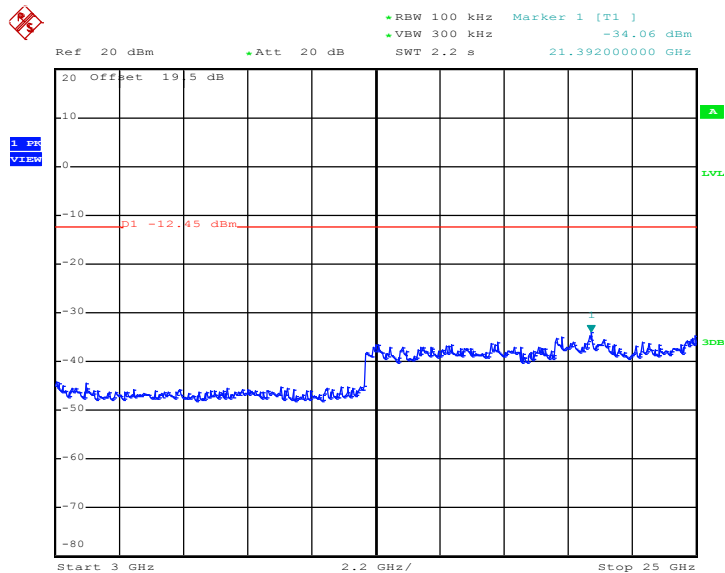

Date: 4.MAY.2011 09:28:33

3.8 AC Conducted Emission Measurement

3.8.1 Limit of AC Conducted Emission

For equipment that is designed to be connected to the public utility (AC) power line, the radio frequency voltage that is conducted back onto the AC power line on any frequency or frequencies within the band 150 kHz to 30 MHz shall not exceed the limits in the following table.

Frequency of emission (MHz)	Conducted limit (dBuV)	
	Quasi-peak	Average
0.15-0.5	66 to 56*	56 to 46*
0.5-5	56	46
5-30	60	50

*Decreases with the logarithm of the frequency.

3.8.2 Measuring Instruments

See list of measuring instruments of this test report.

3.8.3 Test Procedures

1. Please follow the guidelines in ANSI C63.4-2003.
2. The EUT was placed 0.4 meter from the conducting wall of the shielding room was kept at least 80 centimeters from any other grounded conducting surface.
3. Connect EUT to the power mains through a line impedance stabilization network (LISN).
4. All the support units are connecting to the other LISN.
5. The LISN provides 50 ohm coupling impedance for the measuring instrument.
6. The FCC states that a 50 ohm, 50 microhenry LISN should be used.
7. Both sides of AC line were checked for maximum conducted interference.
8. The frequency range from 150 kHz to 30 MHz was searched.
9. Set the test-receiver system to Peak Detect Function and specified bandwidth with Maximum Hold Mode.

3.8.4 Test Setup

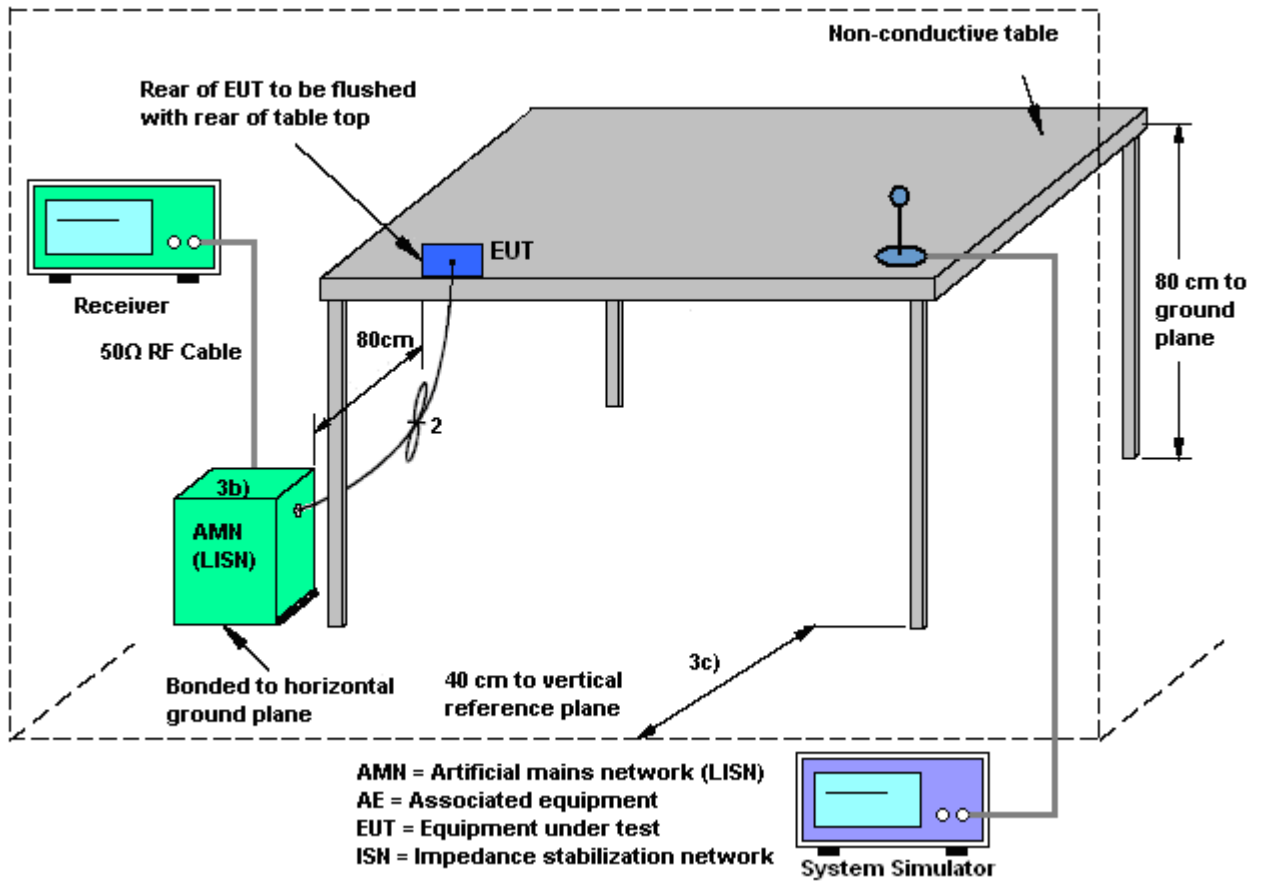

3.8.5 Test Result of AC Conducted Emission

Test Mode :	Mode 1	Temperature :	20~22°C
Test Engineer :	Novic Chiang	Relative Humidity :	40~42%
Test Voltage :	120Vac / 60Hz	Phase :	Line
Function Type :	GSM850 Idle + Bluetooth Link + WLAN Link + Adapter + Earphone + GPS Rx		
Remark :	All emissions not reported here are more than 10 dB below the prescribed limit.		

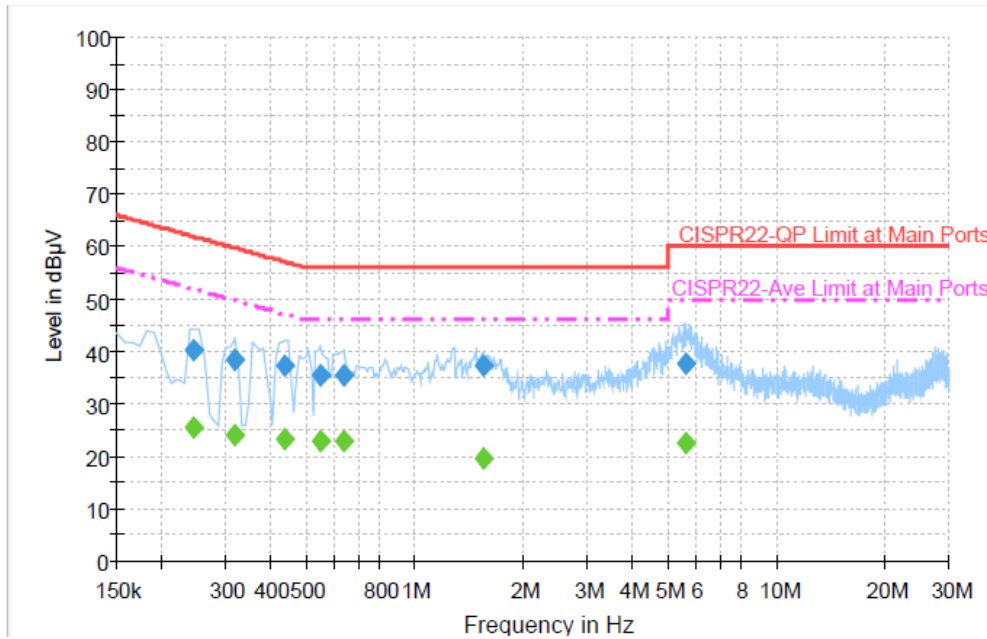

Final Result 1

Frequency (MHz)	QuasiPeak (dBµV)	Filter	Line	Corr. (dB)	Margin (dB)	Limit (dBµV)
0.246000	40.3	Off	L1	19.4	21.6	61.9
0.318000	38.3	Off	L1	19.4	21.5	59.8
0.438000	37.2	Off	L1	19.5	19.9	57.1
0.550000	35.4	Off	L1	19.4	20.6	56.0
0.638000	35.3	Off	L1	19.4	20.7	56.0
1.542000	37.3	Off	L1	19.4	18.7	56.0
5.590000	37.6	Off	L1	19.5	22.4	60.0

Final Result 2

Frequency (MHz)	Average (dBµV)	Filter	Line	Corr. (dB)	Margin (dB)	Limit (dBµV)
0.246000	25.4	Off	L1	19.4	26.5	51.9
0.318000	23.9	Off	L1	19.4	25.9	49.8
0.438000	23.4	Off	L1	19.5	23.7	47.1
0.550000	22.7	Off	L1	19.4	23.3	46.0
0.638000	22.7	Off	L1	19.4	23.3	46.0
1.542000	19.7	Off	L1	19.4	26.3	46.0
5.590000	22.5	Off	L1	19.5	27.5	50.0

Test Mode :	Mode 1	Temperature :	20~22°C
Test Engineer :	Novic Chiang	Relative Humidity :	40~42%
Test Voltage :	120Vac / 60Hz	Phase :	Neutral
Function Type :	GSM850 Idle + Bluetooth Link + WLAN Link + Adapter + Earphone + GPS Rx		
Remark :	All emissions not reported here are more than 10 dB below the prescribed limit.		

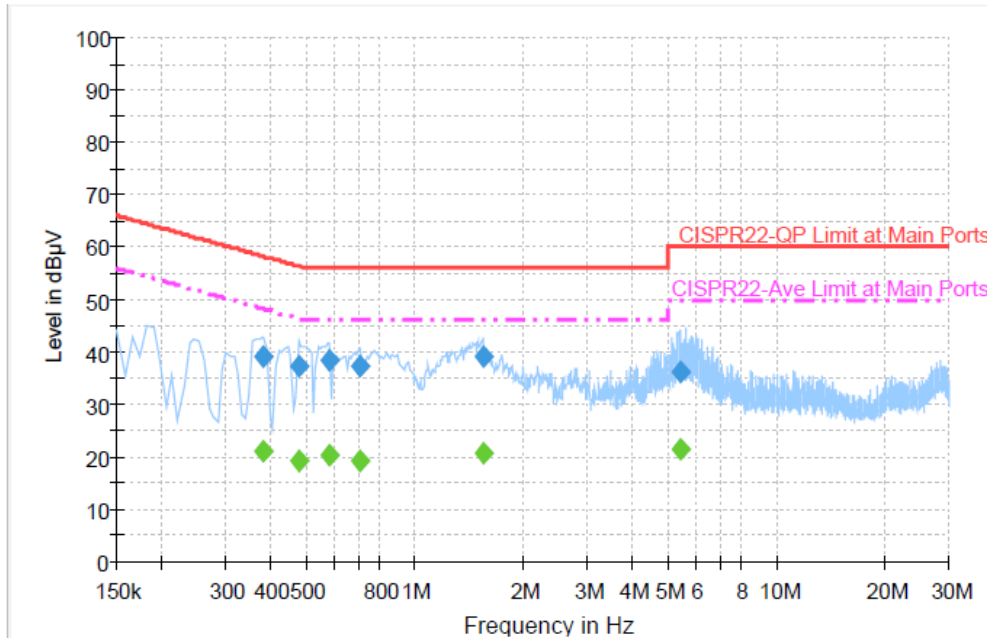

Final Result 1

Frequency (MHz)	QuasiPeak (dBµV)	Filter	Line	Corr. (dB)	Margin (dB)	Limit (dBµV)
0.382000	39.0	Off	N	19.4	19.2	58.2
0.478000	37.2	Off	N	19.4	19.2	56.4
0.582000	38.3	Off	N	19.4	17.7	56.0
0.710000	37.3	Off	N	19.5	18.7	56.0
1.550000	39.2	Off	N	19.5	16.8	56.0
5.406000	36.3	Off	N	19.5	23.7	60.0

Final Result 2

Frequency (MHz)	Average (dBµV)	Filter	Line	Corr. (dB)	Margin (dB)	Limit (dBµV)
0.382000	21.0	Off	N	19.4	27.2	48.2
0.478000	19.2	Off	N	19.4	27.2	46.4
0.582000	20.3	Off	N	19.4	25.7	46.0
0.710000	19.3	Off	N	19.5	26.7	46.0
1.550000	20.6	Off	N	19.5	25.4	46.0
5.406000	21.5	Off	N	19.5	28.5	50.0

3.9 Radiated Emission Measurement

3.9.1 Limit of Radiated Emission

In any 100 kHz bandwidth outside the intentional radiator frequency band, all harmonics/spurious must be at least 20 dB below the highest emission level within the authorized band. In addition, radiated emissions which fall in the restricted bands must also comply with the FCC section 15.209 limits as below.

Frequency (MHz)	Field Strength (microvolts/meter)	Measurement Distance (meters)
0.009 – 0.490	2400/F(kHz)	300
0.490 – 1.705	24000/F(kHz)	30
1.705 – 30.0	30	30
30 – 88	100	3
88 – 216	150	3
216 - 960	200	3
Above 960	500	3

3.9.2 Measuring Instruments

See list of measuring instruments of this test report.

3.9.3 Test Procedures

1. The testing follows the guidelines in FCC Public Notice DA 00-705 Measurement Guidelines.
2. Use the following spectrum analyzer settings:
 - (1) Span = wide enough to fully capture the emission being measured; RBW = 1 MHz for $f \geq 1$ GHz, 100 kHz for $f < 1$ GHz; VBW \geq RBW; Sweep = auto; Detector function = peak; Trace = max hold.
 - (2) Above 18 GHz shall be extrapolated to the specified distance using an extrapolation factor of 20 dB/decade from 3m to 1m.
 Distance extrapolation factor = $20 \log(\text{specific distance [3m]} / \text{test distance [1m]})$ (dB)
3. Follow the guidelines in ANSI C63.4-2003 with respect to maximizing the emission by rotating the EUT, measuring the emission for three EUT orthogonal planes, and adjusting the measurement antenna height and polarization. A pre-amp and a high pass filter are used for this test in order to get the good signal level.
4. Measured average value for the peak value is greater than 54 dBuV/m

3.9.4 Test Setup

For radiated emissions below 30MHz

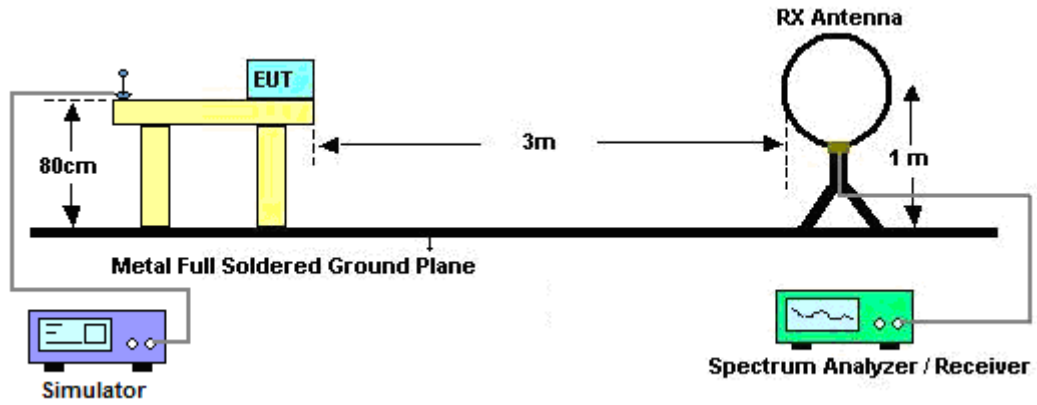

For radiated emissions from 30MHz to 1GHz

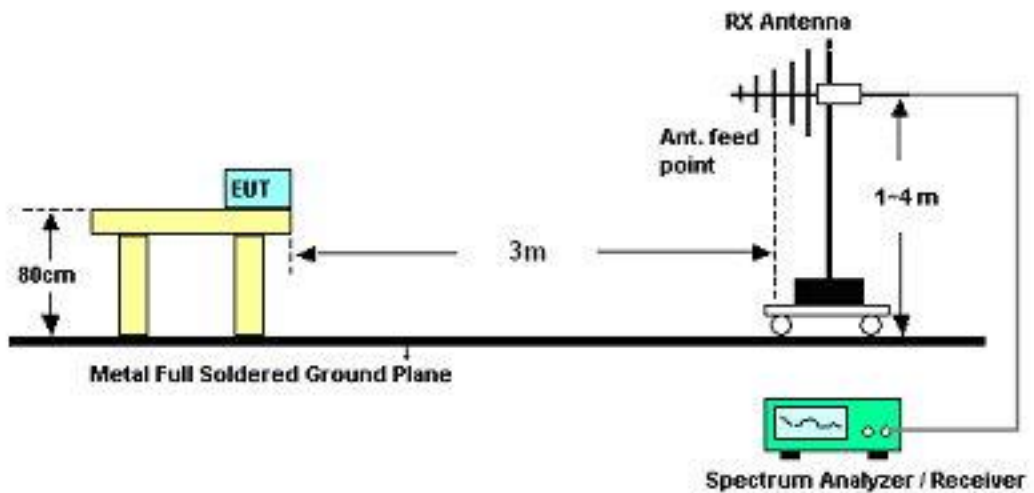

For radiated emissions above 1GHz

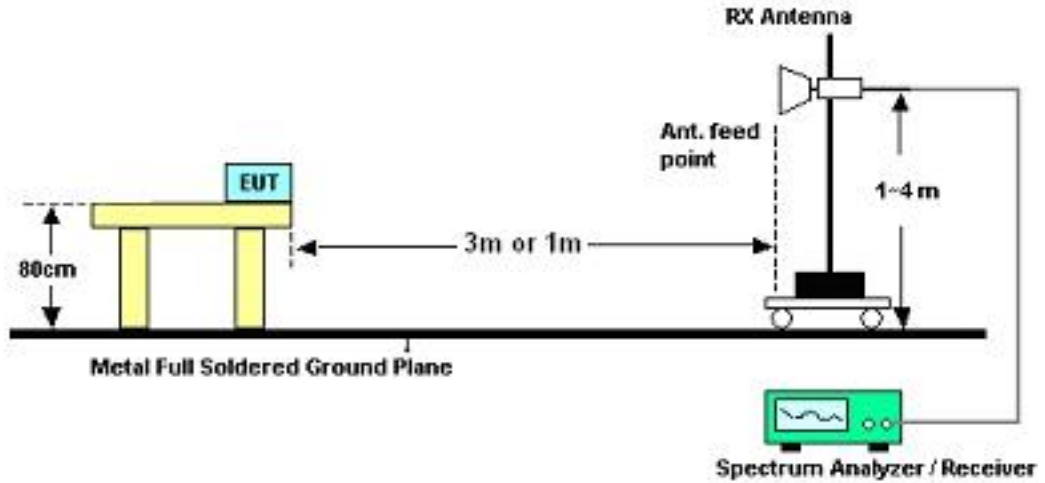

3.9.5 Test Results of Radiated Emissions (9 kHz ~ 30 MHz)

Test Engineer :	Wii Chang	Temperature :	23~26°C	
		Relative Humidity :	54~60%	
Frequency (MHz)	Level (dBuV)	Over Limit (dB)	Limit Line (dBuV)	Remark
-	-	-	-	See Note

Note:

The amplitude of spurious emissions that are attenuated by more than 20dB below the permissible value has no need to be reported.

Distance extrapolation factor = 40 log (specific distance / test distance) (dB);

Limit line = specific limits (dBuV) + distance extrapolation factor.



3.9.6 Test Result of Radiated Emission (30 MHz ~ 10th Harmonic)

Test Mode :	Mode 1	Temperature :	23~26°C
Test Channel :	00	Relative Humidity :	54~60%
Test Engineer :	Wii Chang	Polarization :	Horizontal
Remark :	2402 MHz is Fundamental Signals which can be ignored.		

Frequency (MHz)	Level (dBuV/m)	Over Limit (dB)	Limit Line (dBuV/m)	Read Level (dBuV)	Antenna Factor (dB)	Cable Loss (dB)	Preamp Factor (dB)	Ant Pos (cm)	Table Pos (deg)	Remark
32.97	29.92	-10.08	40	44.25	16.63	0.58	31.54	105	41	Peak
141.24	17.28	-26.22	43.5	37.1	10.62	1.07	31.51	-	-	Peak
162.84	16.41	-27.09	43.5	37.34	9.44	1.14	31.51	-	-	Peak
536.6	19.74	-26.26	46	30.96	17.67	2.1	30.99	-	-	Peak
663.3	21.08	-24.92	46	30.55	18.99	2.3	30.76	-	-	Peak
762	23.34	-22.66	46	31.06	20.31	2.51	30.54	-	-	Peak
2372.89	33.99	-20.01	54	31.92	31.68	4.47	34.08	147	25	Average
2372.89	60.89	-13.11	74	58.82	31.68	4.47	34.08	147	25	Peak
2378	33.91	-20.09	54	31.84	31.68	4.47	34.08	147	25	Average
2378	54.82	-19.18	74	52.75	31.68	4.47	34.08	147	25	Peak
2402	90.56	-	-	88.44	31.7	4.5	34.08	147	25	Average
2402	106.44	-	-	104.32	31.7	4.5	34.08	147	25	Peak
2486	32.12	-21.88	54	29.83	31.78	4.59	34.08	147	25	Average
2486	44.17	-29.83	74	41.88	31.78	4.59	34.08	147	25	Peak
7206	51.45	-34.99	86.44	65.84	35.23	8.02	57.64	100	0	Peak
9608	47.92	-38.52	86.44	57.58	36.62	10.34	56.62	100	0	Peak



Test Mode :	Mode 1	Temperature :	23~26°C
Test Channel :	00	Relative Humidity :	54~60%
Test Engineer :	Wii Chang	Polarization :	Vertical
Remark :	2402 MHz is Fundamental Signals which can be ignored.		

Frequency (MHz)	Level (dBuV/m)	Over Limit (dB)	Limit Line (dBuV/m)	Read Level (dBuV)	Antenna Factor (dB)	Cable Loss (dB)	Preamp Factor (dB)	Ant Pos (cm)	Table Pos (deg)	Remark
36.75	33.41	-6.59	40	49.76	14.59	0.58	31.52	122	178	Peak
62.67	29.4	-10.6	40	54.74	5.46	0.73	31.53	-	-	Peak
143.4	26.74	-16.76	43.5	46.57	10.54	1.14	31.51	-	-	Peak
458.9	18.33	-27.67	46	31.43	16.12	1.92	31.14	-	-	Peak
604.5	20.73	-25.27	46	30.65	18.74	2.2	30.86	-	-	Peak
718.6	21.48	-24.52	46	30.19	19.49	2.45	30.65	-	-	Peak
2372.7	33.32	-20.68	54	31.25	31.68	4.47	34.08	100	43	Average
2372.7	58.22	-15.78	74	56.15	31.68	4.47	34.08	100	43	Peak
2378	33.18	-20.82	54	31.11	31.68	4.47	34.08	100	43	Average
2378	56.65	-17.35	74	54.58	31.68	4.47	34.08	100	43	Peak
2402	88.93	-	-	86.81	31.7	4.5	34.08	100	43	Average
2402	104.24	-	-	102.12	31.7	4.5	34.08	100	43	Peak
2486	32.2	-21.8	54	29.91	31.78	4.59	34.08	100	43	Average
2486	44.05	-29.95	74	41.76	31.78	4.59	34.08	100	43	Peak
7206	49.74	-34.5	84.24	64.13	35.23	8.02	57.64	100	0	Peak



Test Mode :	Mode 2	Temperature :	23~26°C
Test Channel :	39	Relative Humidity :	54~60%
Test Engineer :	Wii Chang	Polarization :	Horizontal
Remark :	2441 MHz is Fundamental Signals which can be ignored.		

Frequency (MHz)	Level (dBuV/m)	Over Limit (dB)	Limit Line (dBuV/m)	Read Level (dBuV)	Antenna Factor (dB)	Cable Loss (dB)	Preamp Factor (dB)	Ant Pos (cm)	Table Pos (deg)	Remark
34.86	32.68	-7.32	40	48.14	15.48	0.58	31.52	113	54	Peak
141.24	17.4	-26.1	43.5	37.22	10.62	1.07	31.51	-	-	Peak
171.75	16.59	-26.91	43.5	38.04	8.86	1.23	31.54	-	-	Peak
536.6	19.25	-26.75	46	30.47	17.67	2.1	30.99	-	-	Peak
687.1	21.71	-24.29	46	31.01	19.08	2.35	30.73	-	-	Peak
812.4	23.85	-22.15	46	30.69	21.12	2.57	30.53	-	-	Peak
2374	32.63	-21.37	54	30.56	31.68	4.47	34.08	110	30	Average
2374	57.06	-16.94	74	54.99	31.68	4.47	34.08	110	30	Peak
2386	32.47	-21.53	54	30.38	31.7	4.47	34.08	110	30	Average
2386	54.87	-19.13	74	52.78	31.7	4.47	34.08	110	30	Peak
2441	89.81	-	-	87.58	31.75	4.56	34.08	110	30	Average
2441	105.33	-	-	103.1	31.75	4.56	34.08	110	30	Peak
2492	32.97	-21.03	54	30.63	31.8	4.62	34.08	110	30	Average
2492	52.89	-21.11	74	50.55	31.8	4.62	34.08	110	30	Peak
4882	46	-28	74	64.09	33.78	6.49	58.36	100	0	Peak
7323	44.16	-9.84	54	58.63	35.14	8.1	57.71	115	51	Average
7323	52.05	-21.95	74	66.52	35.14	8.1	57.71	115	51	Peak



Test Mode :	Mode 2	Temperature :	23~26°C
Test Channel :	39	Relative Humidity :	54~60%
Test Engineer :	Wii Chang	Polarization :	Vertical
Remark :	2441 MHz is Fundamental Signals which can be ignored.		

Frequency (MHz)	Level (dBuV/m)	Over Limit (dB)	Limit Line (dBuV/m)	Read Level (dBuV)	Antenna Factor (dB)	Cable Loss (dB)	Preamp Factor (dB)	Ant Pos (cm)	Table Pos (deg)	Remark
36.75	33.32	-6.68	40	49.67	14.59	0.58	31.52	101	350	Peak
62.67	30.61	-9.39	40	55.95	5.46	0.73	31.53	-	-	Peak
142.86	25.98	-17.52	43.5	45.77	10.58	1.14	31.51	-	-	Peak
516.3	18.92	-27.08	46	30.59	17.33	2.04	31.04	-	-	Peak
672.4	20.86	-25.14	46	30.24	19.02	2.35	30.75	-	-	Peak
811.7	23.29	-22.71	46	30.14	21.11	2.57	30.53	-	-	Peak
2374	32.48	-21.52	54	30.41	31.68	4.47	34.08	100	39	Average
2374	55.42	-18.58	74	53.35	31.68	4.47	34.08	100	39	Peak
2386	32.62	-21.38	54	30.53	31.7	4.47	34.08	100	39	Average
2386	57.66	-16.34	74	55.57	31.7	4.47	34.08	100	39	Peak
2441	88.27	-	-	86.04	31.75	4.56	34.08	100	39	Average
2441	102.94	-	-	100.71	31.75	4.56	34.08	100	39	Peak
2492	32.57	-21.43	54	30.23	31.8	4.62	34.08	100	39	Average
2492	48.52	-25.48	74	46.18	31.8	4.62	34.08	100	39	Peak
7323	50.22	-23.78	74	64.69	35.14	8.1	57.71	100	0	Peak



Test Mode :	Mode 3	Temperature :	23~26°C
Test Channel :	78	Relative Humidity :	54~60%
Test Engineer :	Wii Chang	Polarization :	Horizontal
Remark :	2480 MHz is Fundamental Signals which can be ignored.		

Frequency (MHz)	Level (dBuV/m)	Over Limit (dB)	Limit Line (dBuV/m)	Read Level (dBuV)	Antenna Factor (dB)	Cable Loss (dB)	Preamp Factor (dB)	Ant Pos (cm)	Table Pos (deg)	Remark
34.86	32.6	-7.4	40	48.06	15.48	0.58	31.52	100	159	Peak
45.12	15.33	-24.67	40	36.23	9.93	0.73	31.56	-	-	Peak
143.4	15.02	-28.48	43.5	34.85	10.54	1.14	31.51	-	-	Peak
533.8	18.16	-27.84	46	29.43	17.62	2.1	30.99	-	-	Peak
624.1	19.31	-26.69	46	29.06	18.82	2.25	30.82	-	-	Peak
748	21.1	-24.9	46	29.11	20.03	2.51	30.55	-	-	Peak
2372	32.37	-21.63	54	30.3	31.68	4.47	34.08	170	33	Average
2372	53.93	-20.07	74	51.86	31.68	4.47	34.08	170	33	Peak
2386	32.76	-21.24	54	30.67	31.7	4.47	34.08	170	33	Average
2386	54.16	-19.84	74	52.07	31.7	4.47	34.08	170	33	Peak
2480	91.43	-	-	89.14	31.78	4.59	34.08	170	33	Average
2480	106.84	-	-	104.55	31.78	4.59	34.08	170	33	Peak
2483.5	39.74	-14.26	54	37.45	31.78	4.59	34.08	170	33	Average
2483.5	55.14	-18.86	74	52.85	31.78	4.59	34.08	170	33	Peak
2506	59.11	-27.73	86.84	56.72	31.83	4.62	34.06	100	0	Peak
2532	53.57	-33.27	86.84	51.13	31.85	4.64	34.05	100	0	Peak
4960	46.3	-27.7	74	64.11	33.79	6.59	58.19	100	0	Peak
7440	47.16	-6.84	54	61.72	35.04	8.19	57.79	106	14	Average
7440	54.22	-19.78	74	68.78	35.04	8.19	57.79	106	14	Peak



Test Mode :	Mode 3	Temperature :	23~26°C
Test Channel :	78	Relative Humidity :	54~60%
Test Engineer :	Wii Chang	Polarization :	Vertical
Remark :	2480 MHz is Fundamental Signals which can be ignored.		

Frequency (MHz)	Level (dBuV/m)	Over Limit (dB)	Limit Line (dBuV/m)	Read Level (dBuV)	Antenna Factor (dB)	Cable Loss (dB)	Preamp Factor (dB)	Ant Pos (cm)	Table Pos (deg)	Remark
36.75	33.73	-6.27	40	50.08	14.59	0.58	31.52	108	141	Peak
62.4	30.23	-9.77	40	55.63	5.41	0.73	31.54	-	-	Peak
144.75	25.89	-17.61	43.5	45.76	10.5	1.14	31.51	-	-	Peak
586.3	20.19	-25.81	46	30.4	18.5	2.18	30.89	-	-	Peak
745.9	21.86	-24.14	46	29.9	20	2.51	30.55	-	-	Peak
884.5	24.34	-21.66	46	30.49	21.66	2.68	30.49	-	-	Peak
2386	32.62	-21.38	54	30.53	31.7	4.47	34.08	128	51	Average
2386	51.4	-22.6	74	49.31	31.7	4.47	34.08	128	51	Peak
2480	88.63	-	-	86.34	31.78	4.59	34.08	128	51	Average
2480	103.38	-	-	101.09	31.78	4.59	34.08	128	51	Peak
2483.5	35.12	-18.88	54	32.83	31.78	4.59	34.08	128	51	Average
2483.5	50.28	-23.72	74	47.99	31.78	4.59	34.08	128	51	Peak
2506	55.59	-27.79	83.38	53.2	31.83	4.62	34.06	100	0	Peak
2532	50.44	-32.94	83.38	48	31.85	4.64	34.05	100	0	Peak
4960	43.12	-30.88	74	60.93	33.79	6.59	58.19	100	0	Peak
7440	49.96	-24.04	74	64.52	35.04	8.19	57.79	100	0	Peak



3.10 Antenna Requirements

3.10.1 Standard Applicable

If directional gain of transmitting antennas is greater than 6dBi, the power shall be reduced by the same level in dB comparing to gain minus 6dBi. The use of a permanently attached antenna or of an antenna that uses a unique coupling to the intentional radiator shall be considered sufficient to comply with the FCC rule.

3.10.2 Antenna Connected Construction

The antennas type used in this product is PIFA Antenna without connector and it is considered to meet antenna requirement.

3.10.3 Antenna Gain

The antenna peak gain of EUT is less than 6 dBi. Therefore, it is not necessary to reduce maximum peak output power limit.

4 List of Measuring Equipment

Instrument	Manufacturer	Model No.	Serial No.	Characteristics	Calibration Date	Due Date	Remark
Spectrum Analyzer	R&S	FSP40	100055	9kHz~40GHz	Jun. 11, 2010	Jun. 10, 2011	Conducted (TH02-HY)
Power Meter	Anritsu	ML2495A	0932001	N/A	Sep. 13, 2010	Sep. 12, 2011	Conducted (TH02-HY)
Power Sensor	Anritsu	MA2411B	0846202	N/A	Sep. 14, 2010	Sep. 13, 2011	Conducted (TH02-HY)
Thermal Chamber	Ten Billion	TTH-D35P	TBN-9307 01	N/A	Jul. 30, 2010	Jul. 29, 2011	Conducted (TH02-HY)
EMI Test Receive	R&S	ESCS 30	100356	9KHz – 2.75GHz	Aug. 16, 2010	Aug. 15, 2011	Conduction (CO05-HY)
Two-LISN	R&S	ENV216	11-100081	9KHz – 30MHz	Dec. 03, 2010	Dec. 02, 2011	Conduction (CO05-HY)
Two-LISN	R&S	ENV216	11-100080	9KHz – 30MHz	Dec. 01, 2010	Nov. 30, 2011	Conduction (CO05-HY)
AC Power Source	APC	APC-1000W	N/A	N/A	N/A	N/A	Conduction (CO05-HY)
System Simulator	R&S	CMU200	117591	N/A	Oct. 18, 2010	Oct. 17, 2011	Conduction (CO05-HY)
Spectrum Analyzer	R&S	FSP30	101352	9KHz-40GHz	Nov. 03, 2010	Nov. 02, 2011	Radiation (03CH05-HY)
Amplifier	COM-POWER	PA-103	161075	1KHz - 1GHz	Mar. 29, 2011	Mar. 28, 2012	Radiation (03CH05-HY)
Bilog Antenna	SCHAFFNER	CBL6111C	2725	30MHz ~ 1GHz	Nov. 06, 2010	Nov. 05, 2011	Radiation (03CH05-HY)
SHF-EHF Horn Antenna	SCHWARZBECK	BBHA 9170	BBHA9170 251	15GHz- 40GHz	Oct. 18, 2010	Oct. 17, 2011	Radiation (03CH05-HY)
Pre Amplifier	Agilent	8449B	3008A019 17	1GHz- 26.5GHz	Apr. 14, 2011	Apr. 13, 2012	Radiation (03CH05-HY)
Turn Table	HD	Deis HD 2000	420/611	0 - 360 degree	N/A	N/A	Radiation (03CH05-HY)
Antenna Mast	HD	MA 240	240/666	1 m - 4 m	N/A	N/A	Radiation (03CH05-HY)
Horn Antenna	ESCO	3117	00066584	1GHz ~ 18GHz	Aug. 05, 2010	Aug. 04, 2011	Radiation (03CH05-HY)
Loop Antenna	R&S	HFH2-Z2	860004/00 1	9 kHz~30 MHz	Jul. 29, 2010	Jul. 28, 2011	Radiation (03CH05-HY)
Base Station	R&S	CBT32	100519	N/A	May 18, 2010	May 17, 2011	Radiation (03CH06-HY)

5 Uncertainty of Evaluation

Uncertainty of Conducted Emission Measurement (150 kHz ~ 30 MHz)

Contribution	Uncertainty of X_i		$u(X_i)$
	dB	Probability Distribution	
Receiver Reading	0.10	Normal (k=2)	0.05
Cable Loss	0.10	Normal (k=2)	0.05
AMN Insertion Loss	2.50	Rectangular	0.63
Receiver Specification	1.50	Rectangular	0.43
Site Imperfection	1.39	Rectangular	0.80
Mismatch	+0.34 / -0.35	U-Shape	0.24
Combined Standard Uncertainty $U_c(y)$	1.13		
Measuring Uncertainty for a Level of Confidence of 95% ($U = 2U_c(y)$)	2.26		

Uncertainty of Radiated Emission Measurement (30 MHz ~ 1000 MHz)

Contribution	Uncertainty of X_i		$u(X_i)$
	dB	Probability Distribution	
Receiver Reading	0.41	Normal (k=2)	0.21
Antenna Factor Calibration	0.83	Normal (k=2)	0.42
Cable Loss Calibration	0.25	Normal (k=2)	0.13
Pre-Amplifier Gain Calibration	0.27	Normal (k=2)	0.14
RCV/SPA Specification	2.50	Rectangular	0.72
Antenna Factor Interpolation for Frequency	1.00	Rectangular	0.29
Site Imperfection	1.43	Rectangular	0.83
Mismatch	+0.39 / -0.41	U-Shape	0.28
Combined Standard Uncertainty $U_c(y)$	1.27		
Measuring Uncertainty for a Level of Confidence of 95% ($U = 2U_c(y)$)	2.54		



Uncertainty of Radiated Emission Measurement (1 GHz ~ 40 GHz)

Contribution	Uncertainty of X_i		$u(X_i)$	C_i	$C_i * u(X_i)$
	dB	Probability Distribution			
Receiver Reading	±0.10	Normal (k=2)	0.10	1	0.10
Antenna Factor Calibration	±1.70	Normal (k=2)	0.85	1	0.85
Cable Loss Calibration	±0.50	Normal (k=2)	0.25	1	0.25
Receiver Correction	±2.00	Rectangular	1.15	1	1.15
Antenna Factor Directional	±1.50	Rectangular	0.87	1	0.87
Site Imperfection	±2.80	Triangular	1.14	1	1.14
Mismatch Receiver VSWR $\Gamma_1 = 0.197$ Antenna VSWR $\Gamma_2 = 0.194$ Uncertainty = $20\text{Log}(1-\Gamma_1*\Gamma_2)$	+0.34 / -0.35	U-Shape	0.244	1	0.244
Combined Standard Uncertainty $U_c(y)$	2.36				
Measuring Uncertainty for a Level of Confidence of 95% ($U = 2U_c(y)$)	4.72				