



FCC SAR Test Report

APPLICANT : Motorola Mobility Inc.
EQUIPMENT : CDMA1900 Smart Phone
BRAND NAME : MOTOROLA
MODEL NAME : WX435
FCC ID : IHDT56MS1
STANDARD : FCC 47 CFR Part 2 (2.1093)
IEEE C95.1-1991
IEEE 1528-2003
FCC OET Bulletin 65 Supplement C (Edition 01-01)

The product was received on Jan. 12, 2011 and completely tested on Jan. 26, 2011. We, SPORTON INTERNATIONAL INC., would like to declare that the tested sample has been evaluated in accordance with the procedures and shown the compliance with the applicable technical standards.

The test results in this report apply exclusively to the tested model / sample. Without written approval of SPORTON INTERNATIONAL INC., the test report shall not be reproduced except in full.

Reviewed by:

Roy Wu / Manager



SPORTON INTERNATIONAL INC.

No. 52, Hwa Ya 1st Rd., Hwa Ya Technology Park, Kwei-Shan Hsiang, Tao Yuan Hsien, Taiwan, R.O.C.



Table of Contents

Revision History.....	3
1. Statement of Compliance	4
2. Administration Data	5
2.1 Testing Laboratory	5
2.2 Applicant.....	5
2.3 Manufacturer	5
2.4 Application Details	5
3. General Information	6
3.1 Description of Device Under Test (DUT).....	6
3.2 Product Photos	6
3.3 Applied Standards	6
3.4 Device Category and SAR Limits	6
3.5 Test Conditions	7
3.5.1 Ambient Condition	7
3.5.2 Test Configuration.....	7
4. Specific Absorption Rate (SAR).....	8
4.1 Introduction.....	8
4.2 SAR Definition	8
5. SAR Measurement System.....	9
5.1 E-Field Probe.....	10
5.1.1 E-Field Probe Specification	10
5.1.2 E-Field Probe Calibration.....	11
5.2 Data Acquisition Electronics (DAE).....	11
5.3 Robot.....	11
5.4 Measurement Server	12
5.5 Phantom	13
5.6 Device Holder.....	14
5.7 Data Storage and Evaluation.....	16
5.7.1 Data Storage	16
5.7.2 Data Evaluation	16
5.8 Test Equipment List	18
6. Tissue Simulating Liquids.....	19
7. Uncertainty Assessment	21
8. SAR Measurement Evaluation	23
8.1 Purpose of System Performance check	23
8.2 System Setup	23
8.3 Validation Results	24
9. DUT Testing Position	25
10. Measurement Procedures	28
10.1 Spatial Peak SAR Evaluation	28
10.2 Area & Zoom Scan Procedures	29
10.3 Volume Scan Procedures	29
10.4 SAR Averaged Methods	29
10.5 Power Drift Monitoring	29
11. SAR Test Results	30
11.1 Conducted Power (Unit: dBm).....	30
11.2 Test Records for Head SAR Test	30
11.3 Test Records for Body SAR Test	30
12. References.....	31

- Appendix A. Plots of System Performance Check
- Appendix B. Plots of SAR Measurement
- Appendix C. DASYS Calibration Certificate
- Appendix D. Product Photos
- Appendix E. Test Setup Photos
- Appendix F. FCC 3G SAR Measurement Procedures



1. Statement of Compliance

The maximum results of Specific Absorption Rate (SAR) found during testing for **Motorola Mobility Inc. CDMA1900 Smart Phone MOTOROLA WX435** are as follows (with expanded uncertainty 21.4 % for 300 MHz to 3 GHz).

Band	Position	SAR _{1g} (W/kg)
CDMA2000 BC1	Head	1.09
	Body (1.5 cm Gap)	1.19

This device is in compliance with Specific Absorption Rate (SAR) for general population/uncontrolled exposure limits (1.6 W/kg) specified in FCC 47 CFR part 2 (2.1093) and ANSI/IEEE C95.1-1991, and had been tested in accordance with the measurement methods and procedures specified in IEEE 1528-2003 and FCC OET Bulletin 65 Supplement C (Edition 01-01).



2. Administration Data

2.1 Testing Laboratory

Test Site	SPORTON INTERNATIONAL INC.
Test Site Location	No. 52, Hwa Ya 1 st Rd., Hwa Ya Technology Park, Kwei-Shan Hsiang, Tao Yuan Hsien, Taiwan, R.O.C. TEL: +886-3-327-3456 FAX: +886-3-328-4978

2.2 Applicant

Company Name	Motorola Mobility Inc.
Address	8000 W. Sunrise Blvd, Plantation, FL 33322, USA

2.3 Manufacturer

Company Name	Chi Mei Communication Systems, Inc.
Address	No. 4, Mingsheng Street, Tucheng City, Taipei County 23678, Taiwan

2.4 Application Details

Date of Receipt of Application	Jan. 12, 2011
Date of Start during the Test	Jan. 20, 2011
Date of End during the Test	Jan. 26, 2011



3. General Information

3.1 Description of Device Under Test (DUT)

Product Feature & Specification	
DUT Type	CDMA1900 Smart Phone
Brand Name	MOTOROLA
Model Name	WX435
FCC ID	IHDT56MS1
Tx Frequency	1850 MHz ~ 1910 MHz
Rx Frequency	1930 MHz ~ 1990 MHz
Maximum Output Power to Antenna	24.80 dBm
Antenna Type	Fixed Internal Antenna
HW Version	PR3
SW Version	V1.116
Type of Modulation	QPSK
DUT Stage	Identical Prototype

Remark: The above DUT's information was declared by manufacturer. Please refer to the specifications or user's manual for more detailed description.

3.2 Product Photos

Please refer to Appendix D.

3.3 Applied Standards

The Specific Absorption Rate (SAR) testing specification, method and procedure for this device is in accordance with the following standards:

- FCC 47 CFR Part 2 (2.1093)
- IEEE C95.1-1991
- IEEE 1528-2003
- FCC OET Bulletin 65 Supplement C (Edition 01-01)
- FCC KDB 648474 D01 v01r05
- FCC KDB 941225 D01 v02

3.4 Device Category and SAR Limits

This device belongs to portable device category because its radiating structure is allowed to be used within 20 centimeters of the body of the user. Limit for General Population/Uncontrolled exposure should be applied for this device, it is 1.6 W/kg as averaged over any 1 gram of tissue.

3.5 Test Conditions

3.5.1 Ambient Condition

Ambient Temperature	20 to 24 °C
Humidity	< 60 %

3.5.2 Test Configuration

The device was controlled by using a base station emulator. Communication between the device and the emulator was established by air link. The distance between the DUT and the antenna of the emulator is larger than 50 cm and the output power radiated from the emulator antenna is at least 30 dB smaller than the output power of DUT. The DUT was set from the emulator to radiate maximum output power during all tests.

For WWAN SAR testing, the DUT is in CDMA2000 link mode, and its crest factor is 1.

<Maximum SAR list for each band and position>

	CDMA2000 BC1	802.11b/g	Max. SAR Summation
Right Cheek	1.09	0.179	1.269
Right Tilted	0.575	0.223	0.798
Left Cheek	0.683	0.328	1.011
Left Tilted	0.476	0.263	0.739
Face (Air Gap)	0.585	0.044	0.629
Bottom (Air Gap)	1.19	0.079	1.269

Note: The maximum SAR summation is calculated based on the same configuration and test position.

According to KDB 648474, the simultaneous transmission SAR for WWAN and WLAN was not required, because all the SAR summations are less than 1.6 W/kg. The simultaneous transmission SAR for WWAN and BT was not required, because the closest separation distance of these antennas is larger than 5 cm and the output power of Bluetooth is less than $2P_{Ref}$ (13.8 dBm).

4. Specific Absorption Rate (SAR)

4.1 Introduction

SAR is related to the rate at which energy is absorbed per unit mass in an object exposed to a radio field. The SAR distribution in a biological body is complicated and is usually carried out by experimental techniques or numerical modeling. The standard recommends limits for two tiers of groups, occupational/controlled and general population/uncontrolled, based on a person's awareness and ability to exercise control over his or her exposure. In general, occupational/controlled exposure limits are higher than the limits for general population/uncontrolled.

4.2 SAR Definition

The SAR definition is the time derivative (rate) of the incremental energy (dW) absorbed by (dissipated in) an incremental mass (dm) contained in a volume element (dv) of a given density (ρ). The equation description is as below:

$$\text{SAR} = \frac{d}{dt} \left(\frac{dW}{dm} \right) = \frac{d}{dt} \left(\frac{dW}{\rho dv} \right)$$

SAR is expressed in units of Watts per kilogram (W/kg)

SAR measurement can be either related to the temperature elevation in tissue by

$$\text{SAR} = C \left(\frac{\delta T}{\delta t} \right)$$

Where: C is the specific heat capacity, δT is the temperature rise and δt is the exposure duration, or related to the electrical field in the tissue by

$$\text{SAR} = \frac{\sigma |E|^2}{\rho}$$

Where: σ is the conductivity of the tissue, ρ is the mass density of the tissue and E is the RMS electrical field strength.

However for evaluating SAR of low power transmitter, electrical field measurement is typically applied.

5. SAR Measurement System

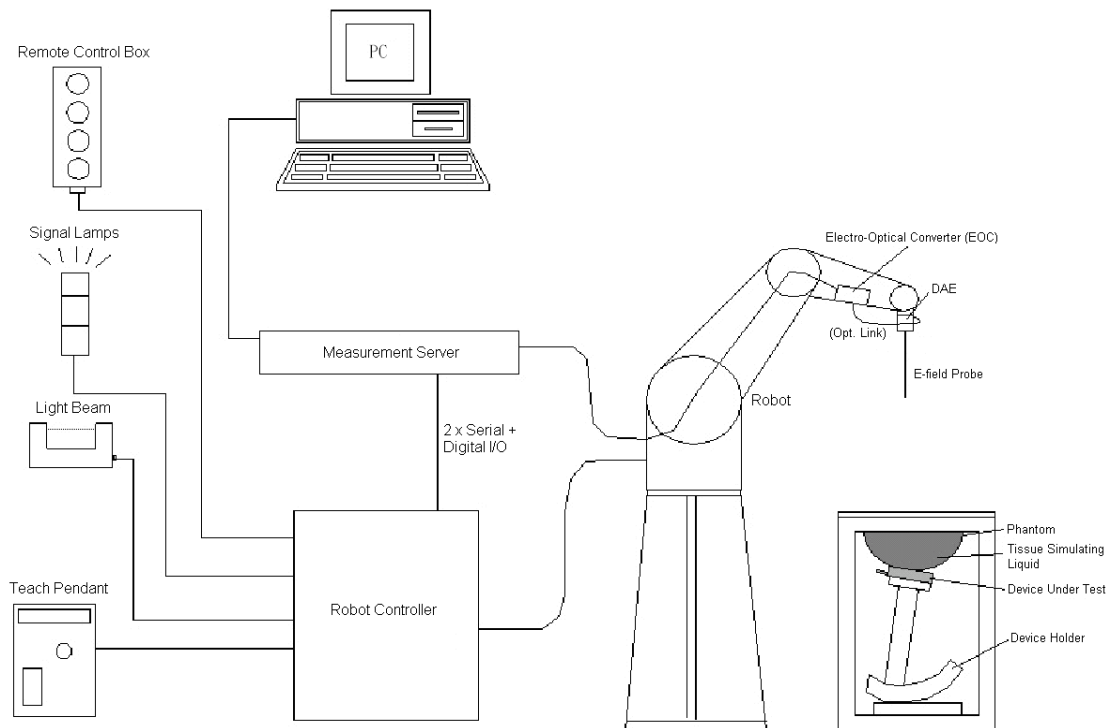

Fig 5.1 SPEAG DASY4 or DASY5 System Configurations

The DASY4 or DASY5 system for performance compliance tests is illustrated above graphically. This system consists of the following items:

- A standard high precision 6-axis robot with controller, a teach pendant and software
- A data acquisition electronic (DAE) attached to the robot arm extension
- A dosimetric probe equipped with an optical surface detector system
- The electro-optical converter (ECO) performs the conversion between optical and electrical signals
- A measurement server performs the time critical tasks such as signal filtering, control of the robot operation and fast movement interrupts.
- A probe alignment unit which improves the accuracy of the probe positioning
- A computer operating Windows XP
- DASY4 or DASY5 software
- Remote control with teach pendant and additional circuitry for robot safety such as warning lamps, etc.
- The SAM twin phantom
- A device holder
- Tissue simulating liquid
- Dipole for evaluating the proper functioning of the system

Some of the components are described in details in the following sub-sections.

5.1 E-Field Probe

The SAR measurement is conducted with the dosimetric probe (manufactured by SPEAG). The probe is specially designed and calibrated for use in liquid with high permittivity. The dosimetric probe has special calibration in liquid at different frequency. This probe has a built in optical surface detection system to prevent from collision with phantom.

5.1.1 E-Field Probe Specification

<ET3DV6>

Construction	Symmetrical design with triangular core Built-in optical fiber for surface detection system. Built-in shielding against static charges. PEEK enclosure material (resistant to organic solvents, e.g., DGBE)
Frequency	10 MHz to 3 GHz; Linearity: ± 0.2 dB
Directivity	± 0.2 dB in HSL (rotation around probe axis) ± 0.4 dB in HSL (rotation normal to probe axis)
Dynamic Range	5 μ W/g to 100 mW/g; Linearity: ± 0.2 dB
Dimensions	Overall length: 330 mm (Tip: 16 mm) Tip diameter: 6.8 mm (Body: 12 mm) Distance from probe tip to dipole centers: 2.7 mm



Fig 5.2 Photo of ET3DV6

<EX3DV4 Probe>

Construction	Symmetrical design with triangular core Built-in shielding against static charges PEEK enclosure material (resistant to organic solvents, e.g., DGBE)
Frequency	10 MHz to 6 GHz; Linearity: ± 0.2 dB
Directivity	± 0.3 dB in HSL (rotation around probe axis) ± 0.5 dB in tissue material (rotation normal to probe axis)
Dynamic Range	10 μ W/g to 100 mW/g; Linearity: ± 0.2 dB (noise: typically < 1 μ W/g)
Dimensions	Overall length: 330 mm (Tip: 20 mm) Tip diameter: 2.5 mm (Body: 12 mm) Typical distance from probe tip to dipole centers: 1 mm



Fig 5.3 Photo of EX3DV4

5.1.2 E-Field Probe Calibration

Each probe needs to be calibrated according to a dosimetric assessment procedure with accuracy better than $\pm 10\%$. The spherical isotropy shall be evaluated and within ± 0.25 dB. The sensitivity parameters (NormX, NormY, and NormZ), the diode compression parameter (DCP) and the conversion factor (ConvF) of the probe are tested. The calibration data can be referred to appendix C of this report.

5.2 Data Acquisition Electronics (DAE)

The data acquisition electronics (DAE) consists of a highly sensitive electrometer-grade preamplifier with auto-zeroing, a channel and gain-switching multiplexer, a fast 16 bit AD-converter and a command decoder and control logic unit. Transmission to the measurement server is accomplished through an optical downlink for data and status information as well as an optical uplink for commands and the clock. The input impedance of the DAE is 200 MOhm; the inputs are symmetrical and floating. Common mode rejection is above 80 dB.



Fig 5.4 Photo of DAE

5.3 Robot

The SPEAG DASY system uses the high precision robots (DASY4: RX90BL; DASY5: TX90XL) type from Stäubli SA (France). For the 6-axis controller system, the robot controller version (DASY4: CS7MB; DASY5: CS8c) from Stäubli is used. The Stäubli robot series have many features that are important for our application:

- High precision (repeatability ± 0.035 mm)
- High reliability (industrial design)
- Jerk-free straight movements
- Low ELF interference (the closed metallic construction shields against motor control fields)



Fig 5.5 Photo of DASY4



Fig 5.6 Photo of DASY5

5.4 Measurement Server

The measurement server is based on a PC/104 CPU board with CPU (DASY4: 166 MHz, Intel Pentium; DASY5: 400 MHz, Intel Celeron), chipdisk (DASY4: 32 MB; DASY5: 128 MB), RAM (DASY4: 64 MB, DASY5: 128 MB). The necessary circuits for communication with the DAE electronic box, as well as the 16 bit AD converter system for optical detection and digital I/O interface are contained on the DASY I/O board, which is directly connected to the PC/104 bus of the CPU board.

The measurement server performs all the real-time data evaluation for field measurements and surface detection, controls robot movements and handles safety operations.



Fig 5.7 Photo of Server for DASY4



Fig 5.8 Photo of Server for DASY5

5.5 Phantom

<SAM Twin Phantom>

Shell Thickness	2 ± 0.2 mm; Center ear point: 6 ± 0.2 mm
Filling Volume	Approx. 25 liters
Dimensions	Length: 1000 mm; Width: 500 mm; Height: adjustable feet
Measurement Areas	Left Hand, Right Hand, Flat Phantom



Fig 5.9 Photo of SAM Phantom

The bottom plate contains three pair of bolts for locking the device holder. The device holder positions are adjusted to the standard measurement positions in the three sections. A white cover is provided to tap the phantom during off-periods to prevent water evaporation and changes in the liquid parameters. On the phantom top, three reference markers are provided to identify the phantom position with respect to the robot.

<ELI4 Phantom>

Shell Thickness	2 ± 0.2 mm (sagging: <1%)
Filling Volume	Approx. 30 liters
Dimensions	Major ellipse axis: 600 mm Minor axis: 400 mm



Fig 5.10 Photo of ELI4 Phantom

The ELI4 phantom is intended for compliance testing of handheld and body-mounted wireless devices in the frequency range of 30 MHz to 6 GHz. ELI4 is fully compatible with standard and all known tissue simulating liquids.

5.6 Device Holder

<Device Holder for SAM Twin Phantom>

The SAR in the phantom is approximately inversely proportional to the square of the distance between the source and the liquid surface. For a source at 5 mm distance, a positioning uncertainty of ± 0.5 mm would produce a SAR uncertainty of ± 20 %. Accurate device positioning is therefore crucial for accurate and repeatable measurements. The positions in which the devices must be measured are defined by the standards.

The DASY device holder is designed to cope with different positions given in the standard. It has two scales for the device rotation (with respect to the body axis) and the device inclination (with respect to the line between the ear reference points). The rotation center for both scales is the ear reference point (EPR). Thus the device needs no repositioning when changing the angles.

The DASY device holder is constructed of low-loss POM material having the following dielectric parameters: relative permittivity $\epsilon = 3$ and loss tangent $\delta = 0.02$. The amount of dielectric material has been reduced in the closest vicinity of the device, since measurements have suggested that the influence of the clamp on the test results could thus be lowered.



Fig 5.11 Device Holder

<Laptop Extension Kit>

The extension is lightweight and made of POM, acrylic glass and foam. It fits easily on the upper part of the mounting device in place of the phone positioned. The extension is fully compatible with the SAM Twin and ELI phantoms.

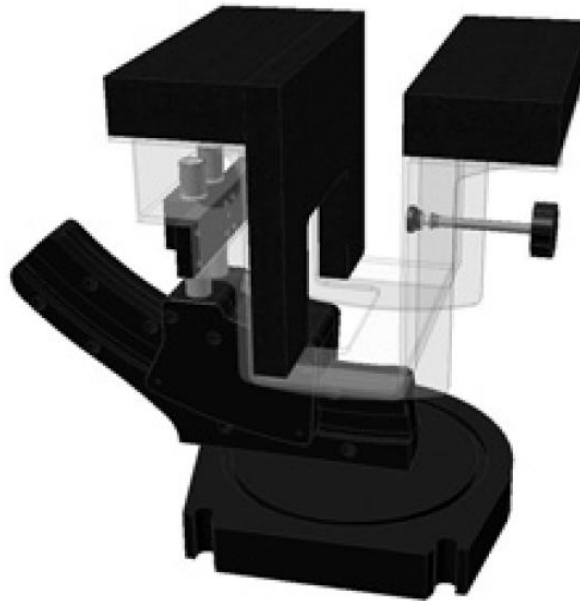

Fig 5.12 **Laptop Extension Kit**



5.7 Data Storage and Evaluation

5.7.1 Data Storage

The DASY software stores the assessed data from the data acquisition electronics as raw data (in microvolt readings from the probe sensors), together with all the necessary software parameters for the data evaluation (probe calibration data, liquid parameters and device frequency and modulation data) in measurement files. The post-processing software evaluates the desired unit and format for output each time the data is visualized or exported. This allows verification of the complete software setup even after the measurement and allows correction of erroneous parameter settings. For example, if a measurement has been performed with an incorrect crest factor parameter in the device setup, the parameter can be corrected afterwards and the data can be reevaluated.

The measured data can be visualized or exported in different units or formats, depending on the selected probe type (e.g., [V/m], [A/m], [mW/g]). Some of these units are not available in certain situations or give meaningless results, e.g., a SAR-output in a non-lose media, will always be zero. Raw data can also be exported to perform the evaluation with other software packages.

5.7.2 Data Evaluation

The DASY post-processing software (SEMCAD) automatically executes the following procedures to calculate the field units from the microvolt readings at the probe connector. The parameters used in the evaluation are stored in the configuration modules of the software :

Probe parameters :	- Sensitivity	Norm _i , a ₁₀ , a ₁₁ , a ₁₂
	- Conversion factor	ConvF _i
	- Diode compression point	dcp _i
Device parameters :	- Frequency	f
	- Crest factor	cf
Media parameters :	- Conductivity	σ
	- Density	ρ

These parameters must be set correctly in the software. They can be found in the component documents or they can be imported into the software from the configuration files issued for the DASY components. In the direct measuring mode of the multi-meter option, the parameters of the actual system setup are used. In the scan visualization and export modes, the parameters stored in the corresponding document files are used.

The first step of the evaluation is a linearization of the filtered input signal to account for the compression characteristics of the detector diode. The compensation depends on the input signal, the diode type and the DC-transmission factor from the diode to the evaluation electronics. If the exciting field is pulsed, the crest factor of the signal must be known to correctly compensate for peak power.

The formula for each channel can be given as :

$$V_i = U_i + U_i^2 \cdot \frac{cf}{dcp_i}$$

with V_i = compensated signal of channel i, (i = x, y, z)
 U_i = input signal of channel i, (i = x, y, z)
 cf = crest factor of exciting field (DASY parameter)
 dcp_i = diode compression point (DASY parameter)

From the compensated input signals, the primary field data for each channel can be evaluated :

$$\text{E-field Probes : } E_i = \sqrt{\frac{V_i}{\text{Norm}_i \cdot \text{ConvF}}}$$

$$\text{H-field Probes : } H_i = \sqrt{V_i} \cdot \frac{a_{i0} + a_{i1}f + a_{i2}f^2}{f}$$

with V_i = compensated signal of channel i, (i = x, y, z)
 Norm_i = sensor sensitivity of channel i, (i = x, y, z), $\mu\text{V}/(\text{V/m})^2$ for E-field Probes
 ConvF = sensitivity enhancement in solution
 a_{ij} = sensor sensitivity factors for H-field probes
 f = carrier frequency [GHz]
 E_i = electric field strength of channel i in V/m
 H_i = magnetic field strength of channel i in A/m

The RSS value of the field components gives the total field strength (Hermitian magnitude) :

$$E_{\text{tot}} = \sqrt{E_x^2 + E_y^2 + E_z^2}$$

The primary field data are used to calculate the derived field units.

$$\text{SAR} = E_{\text{tot}}^2 \cdot \frac{\sigma}{\rho \cdot 1000}$$

with SAR = local specific absorption rate in mW/g
 E_{tot} = total field strength in V/m
 σ = conductivity in [mho/m] or [Siemens/m]
 ρ = equivalent tissue density in g/cm^3

Note that the density is set to 1, to account for actual head tissue density rather than the density of the tissue simulating liquid.



5.8 Test Equipment List

Manufacturer	Name of Equipment	Type/Model	Serial Number	Calibration	
				Last Cal.	Due Date
SPEAG	Dosimetric E-Field Probe	ET3DV6	1787	May 18, 2010	May 17, 2011
SPEAG	Dosimetric E-Field Probe	ET3DV6	1788	Sep. 21, 2010	Sep. 20, 2011
SPEAG	Dosimetric E-Field Probe	EX3DV4	3731	Jul. 16, 2010	Jul. 15, 2011
SPEAG	835MHz System Validation Kit	D835V2	499	Mar. 22, 2010	Mar. 21, 2012
SPEAG	900MHz System Validation Kit	D900V2	190	Jul. 21, 2009	Jul. 20, 2011
SPEAG	1800MHz System Validation Kit	D1800V2	2d076	Jul. 20, 2009	Jul. 19, 2011
SPEAG	1900MHz System Validation Kit	D1900V2	5d041	Mar. 23, 2010	Mar. 22, 2012
SPEAG	2000MHz System Validation Kit	D2000V2	1010	Sep. 22, 2010	Sep. 21, 2012
SPEAG	2300MHz System Validation Kit	D2300V2	1006	Sep. 24, 2009	Sep. 23, 2011
SPEAG	2450MHz System Validation Kit	D2450V2	736	Jul. 20, 2009	Jul. 19, 2011
SPEAG	2600MHz System Validation Kit	D2600V2	1008	Sep. 24, 2009	Sep. 23, 2011
SPEAG	3500MHz System Validation Kit	D3500V2	1014	Sep. 17, 2009	Sep. 16, 2011
SPEAG	5GHz System Validation Kit	D5GHzV2	1006	Jan. 21, 2010	Jan. 20, 2012
SPEAG	Data Acquisition Electronics	DAE3	577	Jan. 13, 2011	Jan. 12, 2012
SPEAG	Data Acquisition Electronics	DAE4	778	Oct. 22, 2010	Oct. 21, 2011
SPEAG	Data Acquisition Electronics	DAE4	913	Nov. 18, 2010	Nov. 17, 2011
SPEAG	Device Holder	N/A	N/A	NCR	NCR
SPEAG	SAM Phantom	QD 000 P40 C	TP-1303	NCR	NCR
SPEAG	SAM Phantom	QD 000 P40 C	TP-1383	NCR	NCR
SPEAG	SAM Phantom	QD 000 P40 C	TP-1446	NCR	NCR
SPEAG	SAM Phantom	QD 000 P40 C	TP-1478	NCR	NCR
SPEAG	ELI4 Phantom	QD 0VA 001 BB	1026	NCR	NCR
SPEAG	ELI4 Phantom	QD 0VA 001 BA	1029	NCR	NCR
Agilent	PNA Series Network Analyzer	E8358A	US40260131	May 06, 2010	May 05, 2011
Agilent	Wireless Communication Test Set	E5515C	MY48360820	Jan. 12, 2010	Jan. 11, 2012
Agilent	Wireless Communication Test Set	E5515C	GB46311322	Feb. 16, 2009	Feb. 15, 2011
R&S	Universal Radio Communication Tester	CMU200	117995	Mar. 19, 2009	Mar. 18, 2011
Agilent	Dielectric Probe Kit	85070D	US01440205	NCR	NCR
Agilent	Dual Directional Coupler	778D	50422	NCR	NCR
AR	Power Amplifier	5S1G4M2	0328767	NCR	NCR
R&S	Spectrum Analyzer	FSP7	101131	Mar. 05, 2010	Mar. 04, 2011

Table 5.1 Test Equipment List

Note: The calibration certificate of DASY can be referred to appendix C of this report.

6. Tissue Simulating Liquids

For the measurement of the field distribution inside the SAM phantom with DASY, the phantom must be filled with around 25 liters of homogeneous body tissue simulating liquid. For head SAR testing, the liquid height from the ear reference point (ERP) of the phantom to the liquid top surface is larger than 15 cm, which is shown in Fig. 6.1. For body SAR testing, the liquid height from the center of the flat phantom to the liquid top surface is larger than 15 cm, which is shown in Fig. 6.2.

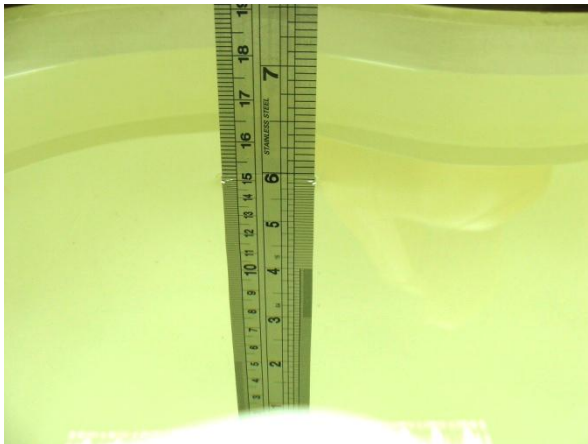

Fig 6.1 Photo of Liquid Height for Head SAR



Fig 6.2 Photo of Liquid Height for Body SAR

The following table gives the recipes for tissue simulating liquid.

Frequency (MHz)	Water (%)	Sugar (%)	Cellulose (%)	Salt (%)	Preventol (%)	DGBE (%)	Conductivity (σ)	Permittivity (ϵ_r)
For Head								
750	41.1	57.0	0.2	1.4	0.2	0	0.89	41.9
835	40.3	57.9	0.2	1.4	0.2	0	0.90	41.5
900	40.3	57.9	0.2	1.4	0.2	0	0.97	41.5
1800, 1900, 2000	55.2	0	0	0.3	0	44.5	1.40	40.0
2450	55.0	0	0	0	0	45.0	1.80	39.2
For Body								
750	51.7	47.2	0	0.9	0.1	0	0.96	55.5
835	50.8	48.2	0	0.9	0.1	0	0.97	55.2
900	50.8	48.2	0	0.9	0.1	0	1.05	55.0
1800, 1900, 2000	70.2	0	0	0.4	0	29.4	1.52	53.3
2450	68.6	0	0	0	0	31.4	1.95	52.7

Table 6.1 Recipes of Tissue Simulating Liquid

The following table gives the targets for tissue simulating liquid.

Frequency (MHz)	Liquid Type	Conductivity (σ)	$\pm 5\%$ Range	Permittivity (ϵ_r)	$\pm 5\%$ Range
750	Head	0.89	0.85 ~ 0.93	41.9	39.8 ~ 44.0
835	Head	0.90	0.86 ~ 0.95	41.5	39.4 ~ 43.6
900	Head	0.97	0.92 ~ 1.02	41.5	39.4 ~ 43.6
1800, 1900, 2000	Head	1.40	1.33 ~ 1.47	40.0	38.0 ~ 42.0
2450	Head	1.80	1.71 ~ 1.89	39.2	37.2 ~ 41.2
750	Body	0.96	0.91 ~ 1.01	55.5	52.7 ~ 58.3
835	Body	0.97	0.92 ~ 1.02	55.2	52.4 ~ 58.0
900	Body	1.05	1.00 ~ 1.10	55.0	52.3 ~ 57.8
1800, 1900, 2000	Body	1.52	1.44 ~ 1.60	53.3	50.6 ~ 56.0
2450	Body	1.95	1.85 ~ 2.05	52.7	50.1 ~ 55.3

Table 6.2 Targets of Tissue Simulating Liquid

The dielectric parameters of the liquids were verified prior to the SAR evaluation using an Agilent 85070D Dielectric Probe Kit and an Agilent Network Analyzer.

The following table shows the measuring results for simulating liquid.

Frequency (MHz)	Liquid Type	Temperature ($^{\circ}\text{C}$)	Conductivity (σ)	Permittivity (ϵ_r)	Measurement Date
1900	Head	21.5	1.42	41.1	Jan. 20, 2011
1900	Body	21.3	1.53	52.9	Jan. 26, 2011

Table 6.3 Measuring Results for Simulating Liquid

7. Uncertainty Assessment

The component of uncertainty may generally be categorized according to the methods used to evaluate them. The evaluation of uncertainty by the statistical analysis of a series of observations is termed a Type A evaluation of uncertainty. The evaluation of uncertainty by means other than the statistical analysis of a series of observation is termed a Type B evaluation of uncertainty. Each component of uncertainty, however evaluated, is represented by an estimated standard deviation, termed standard uncertainty, which is determined by the positive square root of the estimated variance.

A Type A evaluation of standard uncertainty may be based on any valid statistical method for treating data. This includes calculating the standard deviation of the mean of a series of independent observations; using the method of least squares to fit a curve to the data in order to estimate the parameter of the curve and their standard deviations; or carrying out an analysis of variance in order to identify and quantify random effects in certain kinds of measurement.

A type B evaluation of standard uncertainty is typically based on scientific judgment using all of the relevant information available. These may include previous measurement data, experience and knowledge of the behavior and properties of relevant materials and instruments, manufacture’s specification, data provided in calibration reports and uncertainties assigned to reference data taken from handbooks. Broadly speaking, the uncertainty is either obtained from an outdoor source or obtained from an assumed distribution, such as the normal distribution, rectangular or triangular distributions indicated in Table 7.1

Uncertainty Distributions	Normal	Rectangular	Triangular	U-Shape
Multi-plying Factor ^(a)	1/k ^(b)	1/√3	1/√6	1/√2

- (a) standard uncertainty is determined as the product of the multiplying factor and the estimated range of variations in the measured quantity
- (b) κ is the coverage factor

Table 7.1 Standard Uncertainty for Assumed Distribution

The combined standard uncertainty of the measurement result represents the estimated standard deviation of the result. It is obtained by combining the individual standard uncertainties of both Type A and Type B evaluation using the usual “root-sum-squares” (RSS) methods of combining standard deviations by taking the positive square root of the estimated variances.

Expanded uncertainty is a measure of uncertainty that defines an interval about the measurement result within which the measured value is confidently believed to lie. It is obtained by multiplying the combined standard uncertainty by a coverage factor. Typically, the coverage factor ranges from 2 to 3. Using a coverage factor allows the true value of a measured quantity to be specified with a defined probability within the specified uncertainty range. For purpose of this document, a coverage factor two is used, which corresponds to confidence interval of about 95 %. The DASY uncertainty Budget is showed in Table 7.2.



Error Description	Uncertainty Value (±%)	Probability Distribution	Divisor	Ci (1g)	Standard Uncertainty (1g)
Measurement System					
Probe Calibration	5.5	Normal	1	1	± 5.5 %
Axial Isotropy	4.7	Rectangular	√3	0.7	± 1.9 %
Hemispherical Isotropy	9.6	Rectangular	√3	0.7	± 3.9 %
Boundary Effects	1.0	Rectangular	√3	1	± 0.6 %
Linearity	4.7	Rectangular	√3	1	± 2.7 %
System Detection Limits	1.0	Rectangular	√3	1	± 0.6 %
Readout Electronics	0.3	Normal	1	1	± 0.3 %
Response Time	0.8	Rectangular	√3	1	± 0.5 %
Integration Time	2.6	Rectangular	√3	1	± 1.5 %
RF Ambient Noise	3.0	Rectangular	√3	1	± 1.7 %
RF Ambient Reflections	3.0	Rectangular	√3	1	± 1.7 %
Probe Positioner	0.4	Rectangular	√3	1	± 0.2 %
Probe Positioning	2.9	Rectangular	√3	1	± 1.7 %
Max. SAR Eval.	1.0	Rectangular	√3	1	± 0.6 %
Test Sample Related					
Device Positioning	2.9	Normal	1	1	± 2.9 %
Device Holder	3.6	Normal	1	1	± 3.6 %
Power Drift	5.0	Rectangular	√3	1	± 2.9 %
Phantom and Setup					
Phantom Uncertainty	4.0	Rectangular	√3	1	± 2.3 %
Liquid Conductivity (Target)	5.0	Rectangular	√3	0.64	± 1.8 %
Liquid Conductivity (Meas.)	2.5	Normal	1	0.64	± 1.6 %
Liquid Permittivity (Target)	5.0	Rectangular	√3	0.6	± 1.7 %
Liquid Permittivity (Meas.)	2.5	Normal	1	0.6	± 1.5 %
Combined Standard Uncertainty					± 10.7 %
Coverage Factor for 95 %					K = 2
Expanded Uncertainty					± 21.4 %

Table 7.2 Uncertainty Budget of DASY for frequency range 300 MHz to 3 GHz

8. SAR Measurement Evaluation

Each DASY system is equipped with one or more system validation kits. These units, together with the predefined measurement procedures within the DASY software, enable the user to conduct the system performance check and system validation. System validation kit includes a dipole, tripod holder to fix it underneath the flat phantom and a corresponding distance holder.

8.1 Purpose of System Performance check

The system performance check verifies that the system operates within its specifications. System and operator errors can be detected and corrected. It is recommended that the system performance check be performed prior to any usage of the system in order to guarantee reproducible results. The system performance check uses normal SAR measurements in a simplified setup with a well characterized source. This setup was selected to give a high sensitivity to all parameters that might fail or vary over time. The system check does not intend to replace the calibration of the components, but indicates situations where the system uncertainty is exceeded due to drift or failure.

8.2 System Setup

In the simplified setup for system evaluation, the DUT is replaced by a calibrated dipole and the power source is replaced by a continuous wave that comes from a signal generator. The calibrated dipole must be placed beneath the flat phantom section of the SAM twin phantom with the correct distance holder. The distance holder should touch the phantom surface with a light pressure at the reference marking and be oriented parallel to the long side of the phantom. The equipment setup is shown below:

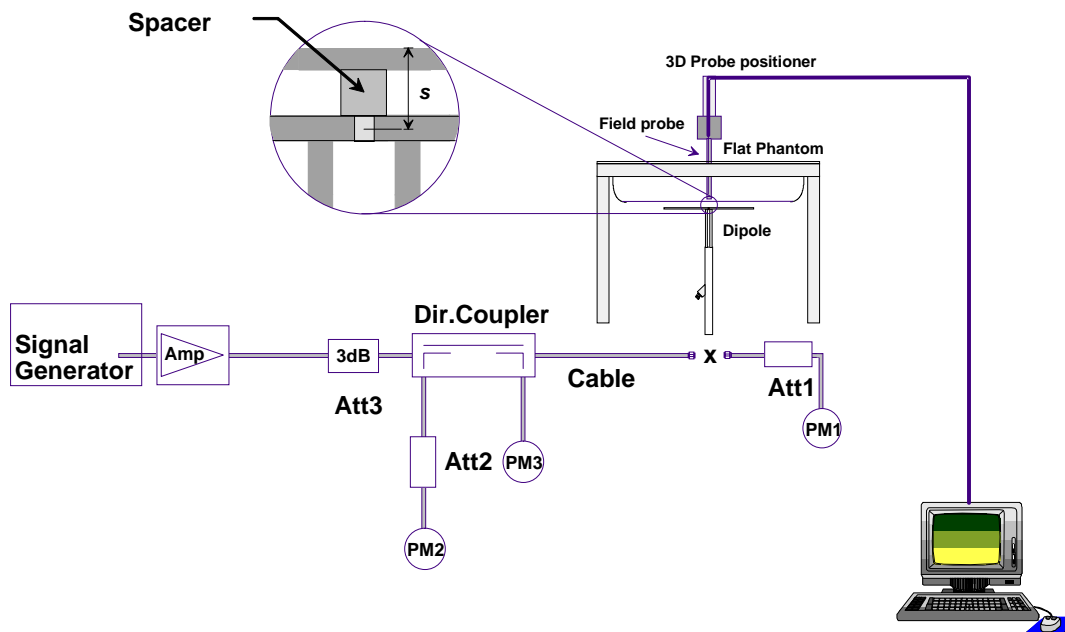

Fig 8.1 System Setup for System Evaluation

1. Signal Generator
2. Amplifier
3. Directional Coupler
4. Power Meter
5. Calibrated Dipole

The output power on dipole port must be calibrated to 24 dBm (250 mW) before dipole is connected.

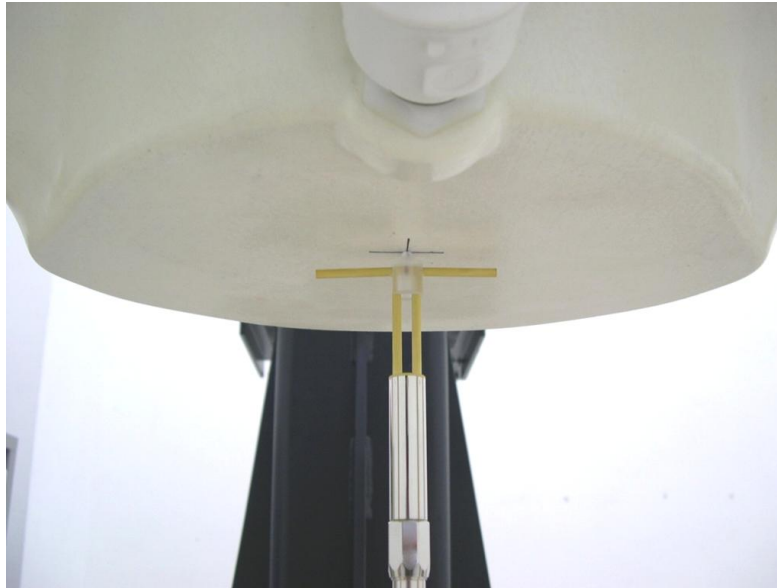

Fig 8.2 Photo of Dipole Setup

8.3 Validation Results

Comparing to the original SAR value provided by SPEAG, the validation data should be within its specification of 10 %. Table 8.1 shows the target SAR and measured SAR after normalized to 1W input power. The table below indicates the system performance check can meet the variation criterion and the plots can be referred to Appendix A of this report.

Measurement Date	Frequency (MHz)	Targeted SAR _{1g} (W/kg)	Measured SAR _{1g} (W/kg)	Deviation (%)
Jan. 20, 2011	1900	39.80	40.40	1.51
Jan. 26, 2011	1900	40.00	41.60	4.00

Table 8.1 Target and Measurement SAR after Normalized

9. DUT Testing Position

This DUT was tested in six different positions. They are right cheek, right tilted, left cheek, left tilted, face of the DUT with phantom 1.5 cm gap, and bottom of the DUT with phantom 1.5 cm gap as illustrated below:

1. Define two imaginary lines on the handset

- (a) The vertical centerline passes through two points on the front side of the handset - the midpoint of the width w_t of the handset at the level of the acoustic output, and the midpoint of the width w_b of the bottom of the handset.
- (b) The horizontal line is perpendicular to the vertical centerline and passes through the center of the acoustic output. The horizontal line is also tangential to the face of the handset at point A.
- (c) The two lines intersect at point A. Note that for many handsets, point A coincides with the center of the acoustic output; however, the acoustic output may be located elsewhere on the horizontal line. Also note that the vertical centerline is not necessarily parallel to the front face of the handset, especially for clamshell handsets, handsets with flip covers, and other irregularly shaped handsets.

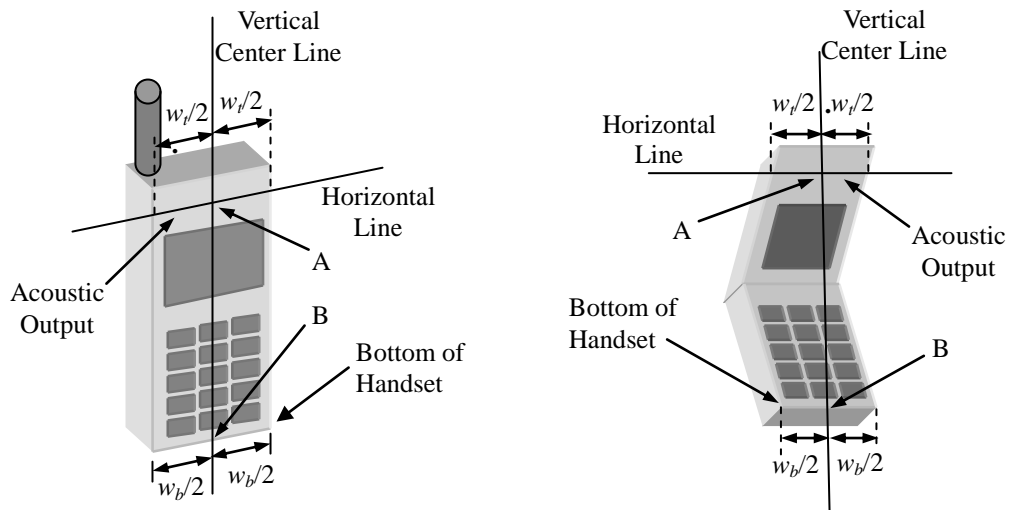

Fig 9.1 Illustration for Handset Vertical and Horizontal Reference Lines

2. Cheek Position

- (a) To position the device with the vertical center line of the body of the device and the horizontal line crossing the center piece in a plane parallel to the sagittal plane of the phantom. While maintaining the device in this plane, align the vertical center line with the reference plane containing the three ear and mouth reference point (M: Mouth, RE: Right Ear, and LE: Left Ear) and align the center of the ear piece with the line RE-LE.
- (b) To move the device towards the phantom with the ear piece aligned with the line LE-RE until the phone touched the ear. While maintaining the device in the reference plane and maintaining the phone contact with the ear, move the bottom of the phone until any point on the front side is in contact with the cheek of the phantom or until contact with the ear is lost (see Fig. 9.2).

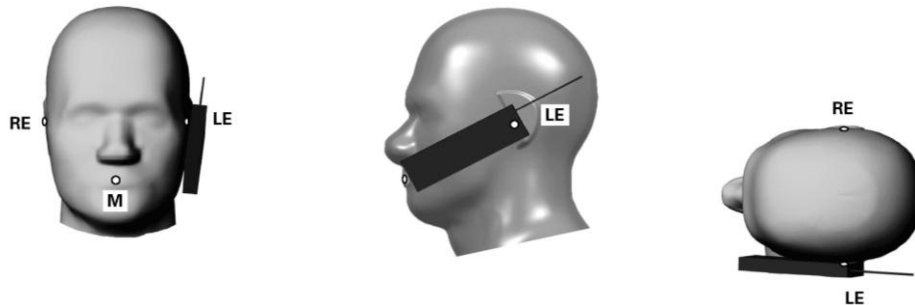

Fig 9.2 Illustration for Cheek Position

3. Tilted Position

- (a) To position the device in the “cheek” position described above.
- (b) While maintaining the device the reference plane described above and pivoting against the ear, moves it outward away from the mouth by an angle of 15 degrees or until contact with the ear is lost (see Fig. 9.3).

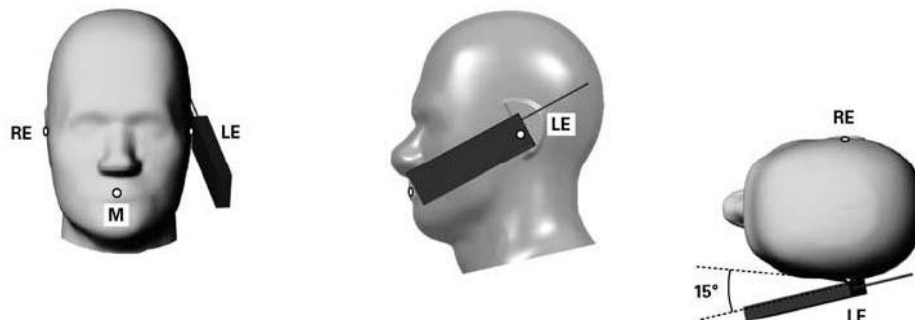

Fig 9.3 Illustration for Tilted Position

4. Body Worn Position

- (a) To position the device parallel to the phantom surface with either keypad up or down.
- (b) To adjust the device parallel to the flat phantom.
- (c) To adjust the distance between the device surface and the flat phantom to 1.5 cm.

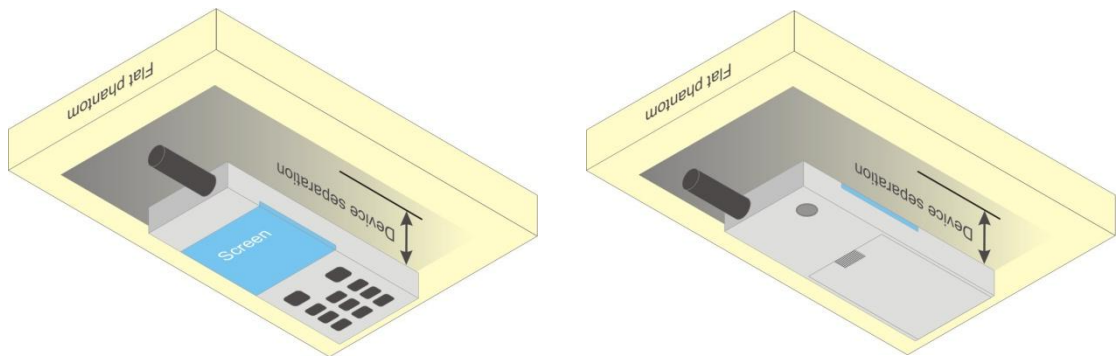

Fig 9.4 Illustration for Body Worn Position

5. DUT Setup Photos

Please refer to Appendix E for the test setup photos.

10. Measurement Procedures

The measurement procedures are as follows:

- (a) For WWAN function, link DUT with base station emulator in highest power channel
- (b) Set base station emulator to allow DUT to radiate maximum output power
- (c) Measure output power through RF cable and power meter
- (d) Place the DUT in the positions described in the last section
- (e) Set scan area, grid size and other setting on the DASY software
- (f) Taking data for the middle channel on each testing position
- (g) Find out the largest SAR result on these testing positions of each band
- (h) Measure SAR results for other channels in worst SAR testing position if the SAR of highest power channel is larger than 0.8 W/kg

According to the test standard, the recommended procedure for assessing the peak spatial-average SAR value consists of the following steps:

- (a) Power reference measurement
- (b) Area scan
- (c) Zoom scan
- (d) Power drift measurement

10.1 Spatial Peak SAR Evaluation

The procedure for spatial peak SAR evaluation has been implemented according to the test standard. It can be conducted for 1g and 10g, as well as for user-specific masses. The DASY software includes all numerical procedures necessary to evaluate the spatial peak SAR value.

The base for the evaluation is a "cube" measurement. The measured volume must include the 1g and 10g cubes with the highest averaged SAR values. For that purpose, the center of the measured volume is aligned to the interpolated peak SAR value of a previously performed area scan.

The entire evaluation of the spatial peak values is performed within the post-processing engine (SEMCAD). The system always gives the maximum values for the 1g and 10g cubes. The algorithm to find the cube with highest averaged SAR is divided into the following stages:

- (a) Extraction of the measured data (grid and values) from the Zoom Scan
- (b) Calculation of the SAR value at every measurement point based on all stored data (A/D values and measurement parameters)
- (c) Generation of a high-resolution mesh within the measured volume
- (d) Interpolation of all measured values from the measurement grid to the high-resolution grid
- (e) Extrapolation of the entire 3-D field distribution to the phantom surface over the distance from sensor to surface
- (f) Calculation of the averaged SAR within masses of 1g and 10g



10.2 Area & Zoom Scan Procedures

First Area Scan is used to locate the approximate location(s) of the local peak SAR value(s). The measurement grid within an Area Scan is defined by the grid extent, grid step size and grid offset. Next, in order to determine the EM field distribution in a three-dimensional spatial extension, Zoom Scan is required. The Zoom Scan measures 5x5x7 points with step size 8, 8 and 5 mm for 300 MHz to 3 GHz, and 8x8x8 points with step size 4, 4 and 2.5 mm for 3 GHz to 6 GHz. The Zoom Scan is performed around the highest E-field value to determine the averaged SAR-distribution over 10 g.

10.3 Volume Scan Procedures

The volume scan is used for assess overlapping SAR distributions for antennas transmitting in different frequency bands. It is equivalent to an oversized zoom scan used in standalone measurements. The measurement volume will be used to enclose all the simultaneous transmitting antennas. For antennas transmitting simultaneously in different frequency bands, the volume scan is measured separately in each frequency band. In order to sum correctly to compute the 1g aggregate SAR, the DUT remain in the same test position for all measurements and all volume scan use the same spatial resolution and grid spacing (step-size is 4, 4 and 2.5 mm). When all volume scan were completed, the software, SEMCAD postprocessor can combine and subsequently superpose these measurement data to calculating the multiband SAR.

10.4 SAR Averaged Methods

In DASy, the interpolation and extrapolation are both based on the modified Quadratic Shepard's method. The interpolation scheme combines a least-square fitted function method and a weighted average method which are the two basic types of computational interpolation and approximation.

Extrapolation routines are used to obtain SAR values between the lowest measurement points and the inner phantom surface. The extrapolation distance is determined by the surface detection distance and the probe sensor offset. The uncertainty increases with the extrapolation distance. To keep the uncertainty within 1% for the 1 g and 10 g cubes, the extrapolation distance should not be larger than 5 mm.

10.5 Power Drift Monitoring

All SAR testing is under the DUT install full charged battery and transmit maximum output power. In DASy measurement software, the power reference measurement and power drift measurement procedures are used for monitoring the power drift of DUT during SAR test. Both these procedures measure the field at a specified reference position before and after the SAR testing. The software will calculate the field difference in dB. If the power drift more than 5%, the SAR will be retested.



11. SAR Test Results

11.1 Conducted Power (Unit: dBm)

Band	CDMA2000 BC1		
Channel	25	600	1175
Frequency (MHz)	1851.25	1880.00	1908.75
1xRTT RC1+SO55	24.16	24.52	24.70
1xRTT RC3+SO55	24.64	24.57	24.65
1xRTT RC3+SO32 (FCH)	24.62	24.53	24.69
1xRTT RC3+SO32 (SCH)	24.46	24.50	24.67
1xEVDO RTAP 153.6	24.69	24.70	24.68
1xEVDO RETAP 4096	24.49	24.77	24.80

11.2 Test Records for Head SAR Test

Plot No.	Band	Mode	Test Position	Channel	SAR _{1g} (W/kg)
#01	CDMA2000 BC1	RC3+SO55	Right Cheek	1175	1.09
#02	CDMA2000 BC1	RC3+SO55	Right Tilted	1175	0.575
#03	CDMA2000 BC1	RC3+SO55	Left Cheek	1175	0.683
#04	CDMA2000 BC1	RC3+SO55	Left Tilted	1175	0.476
#05	CDMA2000 BC1	RC3+SO55	Right Cheek	25	0.982
#06	CDMA2000 BC1	RC3+SO55	Right Cheek	600	1.07

11.3 Test Records for Body SAR Test

Plot No.	Band	Mode	Test Position	Separation Distance (cm)	Channel	SAR _{1g} (W/kg)
#07	CDMA2000 BC1	RC3+SO32	Bottom of the DUT	1.5	1175	1.04
#08	CDMA2000 BC1	RC3+SO32	Face of the DUT	1.5	1175	0.585
#09	CDMA2000 BC1	RC3+SO32	Bottom of the DUT	1.5	600	1.13
#10	CDMA2000 BC1	RC3+SO32	Bottom of the DUT	1.5	25	1.19

Test Engineer : Andy He, Robert Liu and A-Rod Chen



12. References

- [1] FCC 47 CFR Part 2 "Frequency Allocations and Radio Treaty Matters; General Rules and Regulations"
- [2] IEEE Std. C95.1-1991, "IEEE Standard for Safety Levels with Respect to Human Exposure to Radio Frequency Electromagnetic Fields, 3 kHz to 300 GHz", 1991
- [3] IEEE Std. 1528-2003, "Recommended Practice for Determining the Peak Spatial-Average Specific Absorption Rate (SAR) in the Human Head from Wireless Communications Devices: Measurement Techniques", December 2003
- [4] FCC OET Bulletin 65 (Edition 97-01) Supplement C (Edition 01-01), "Evaluating Compliance with FCC Guidelines for Human Exposure to Radiofrequency Electromagnetic Fields", June 2001
- [5] SPEAG DASY System Handbook
- [6] FCC KDB 248227 D01 v01r02, "SAR Measurement Procedures for 802.11 a/b/g Transmitters", May 2007
- [7] FCC KDB 447498 D01 v04, "Mobile and Portable Device RF Exposure Procedures and Equipment Authorization Policies", November 2009
- [8] FCC KDB 447498 D02 v02, "SAR Measurement Procedures for USB Dongle Transmitters", November 2009
- [9] FCC KDB 616217 D01 v01r01, "SAR Evaluation Considerations for Laptop Computers with Antennas Built-in on Display Screens", November 2009
- [10] FCC KDB 616217 D03 v01, "SAR Evaluation Considerations for Laptop/Notebook/Netbook and Tablet Computers", November 2009
- [11] FCC KDB 648474 D01 v01r05, "SAR Evaluation Considerations for Handsets with Multiple Transmitters and Antennas", September 2008
- [12] FCC KDB 941225 D01 v02, "SAR Measurement Procedures for 3G Devices – CDMA 2000 / Ev-Do / WCDMA / HSDPA / HSPA", October 2007
- [13] FCC KDB 941225 D03 v01, "Recommended SAR Test Reduction Procedures for GSM / GPRS / EDGE", December 2008
- [14] FCC KDB 941225 D04 v01, "Evaluating SAR for GSM/(E)GPRS Dual Transfer Mode", January 27 2010



Appendix A. Plots of System Performance Check

The plots are shown as follows.

System Check_Head_1900MHz_110120

DUT: Dipole 1900 MHz

Communication System: CW; Frequency: 1900 MHz; Duty Cycle: 1:1

Medium: HSL_1900_110120 Medium parameters used: $f = 1900$ MHz; $\sigma = 1.42$ mho/m; $\epsilon_r = 41.1$; $\rho = 1000$

kg/m³

Ambient Temperature : 22.6 ; Liquid Temperature : 21.5

DASY5 Configuration:

- Probe: ET3DV6 - SN1788; ConvF(5.03, 5.03, 5.03); Calibrated: 2010/9/21
- Sensor-Surface: 4mm (Mechanical Surface Detection)
- Electronics: DAE4 Sn913; Calibrated: 2010/11/18
- Phantom: SAM - Front; Type: SAM; Serial: TP-1446
- Measurement SW: DASY5, V5.0 Build 125; SEMCAD X Version 13.4 Build 125

Pin=250mW/Area Scan (61x61x1): Measurement grid: dx=15mm, dy=15mm

Maximum value of SAR (interpolated) = 12 mW/g

Pin=250mW/Zoom Scan (7x7x7)/Cube 0: Measurement grid: dx=5mm, dy=5mm, dz=5mm

Reference Value = 95.2 V/m; Power Drift = -0.131 dB

Peak SAR (extrapolated) = 17.4 W/kg

SAR(1 g) = 10.1 mW/g; SAR(10 g) = 5.35 mW/g

Maximum value of SAR (measured) = 11.4 mW/g

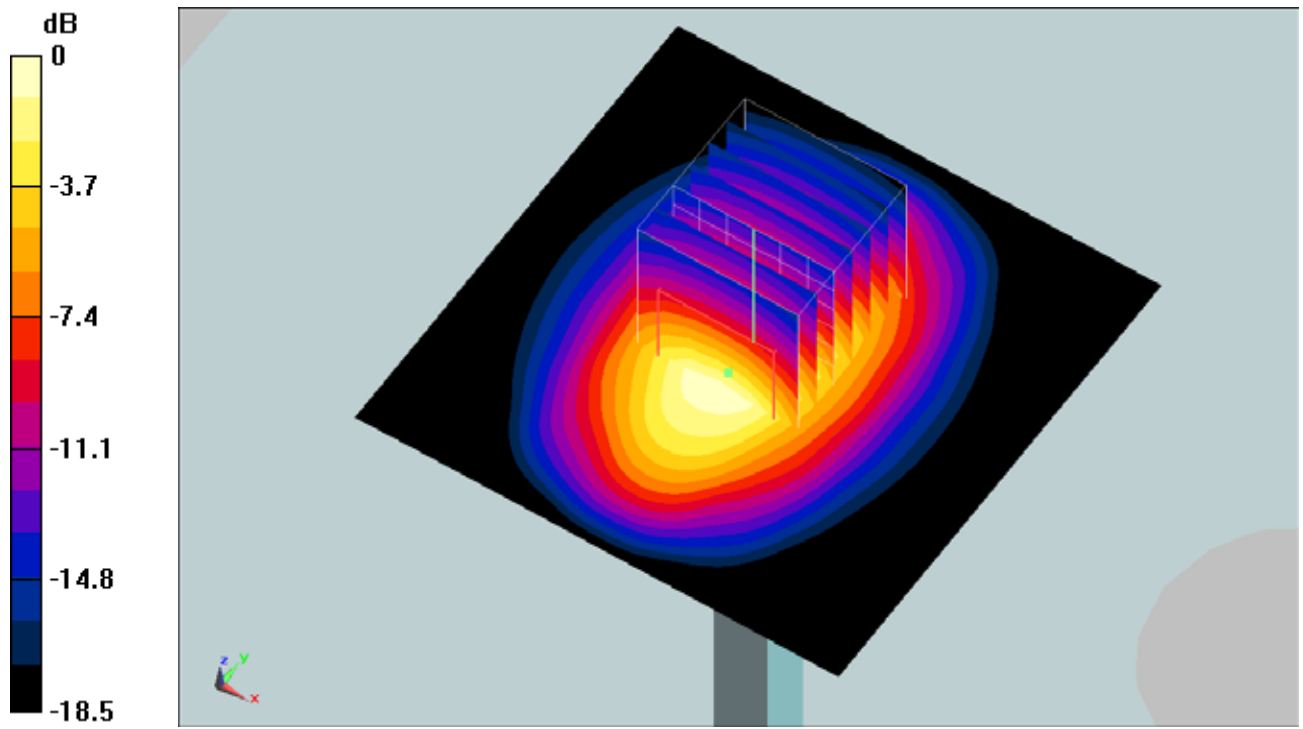

0 dB = 11.4mW/g

System Check_Body_1900MHz_110126

DUT: Dipole 1900 MHz

Communication System: CW; Frequency: 1900 MHz; Duty Cycle: 1:1

Medium: MSL_1900_110126 Medium parameters used: $f = 1900$ MHz; $\sigma = 1.53$ mho/m; $\epsilon_r = 52.9$; $\rho = 1000$ kg/m³

Ambient Temperature : 22.4 °C; Liquid Temperature : 21.3 °C

DASY4 Configuration:

- Probe: ET3DV6 - SN1787; ConvF(4.47, 4.47, 4.47); Calibrated: 2010/5/18
- Sensor-Surface: 4mm (Mechanical Surface Detection)
- Electronics: DAE4 Sn778; Calibrated: 2010/10/22
- Phantom: ELI 4.0_Front; Type: QDOVA001BB; Serial: 1026
- Measurement SW: DASY4, V4.7 Build 80; Postprocessing SW: SEMCAD, V1.8 Build 186

Pin=250mW/Area Scan (61x61x1): Measurement grid: dx=15mm, dy=15mm

Maximum value of SAR (interpolated) = 12.8 mW/g

Pin=250mW/Zoom Scan (7x7x7)/Cube 0: Measurement grid: dx=5mm, dy=5mm, dz=5mm

Reference Value = 94.0 V/m; Power Drift = 0.037 dB

Peak SAR (extrapolated) = 16.4 W/kg

SAR(1 g) = 10.4 mW/g; SAR(10 g) = 5.64 mW/g

Maximum value of SAR (measured) = 12.0 mW/g

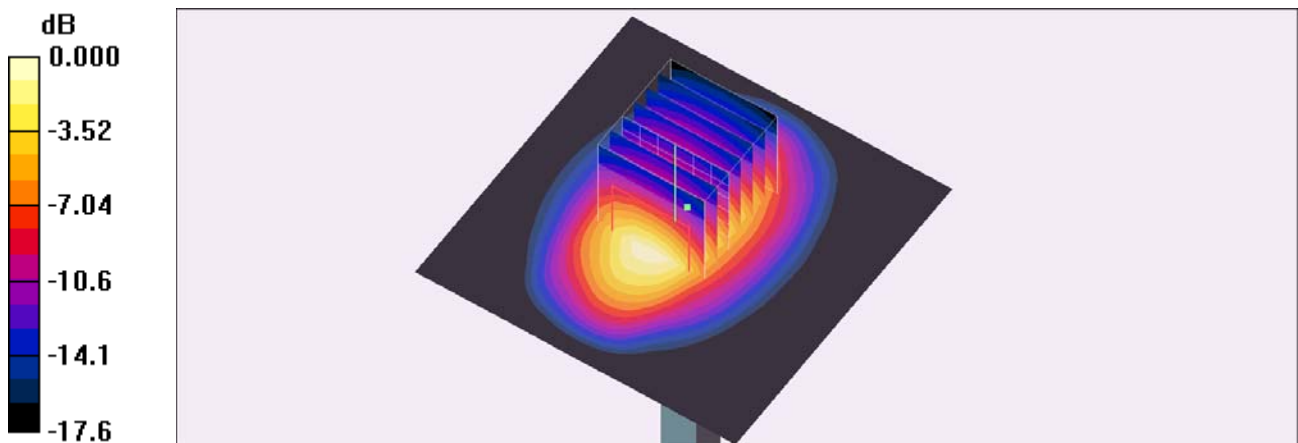

0 dB = 12.0mW/g



Appendix B. Plots of SAR Measurement

The plots are shown as follows.

#01 CDMA2000 BC1_RC3+SO55_Right Cheek_Ch1175

DUT: 111226

Communication System: CDMA ; Frequency: 1908.75 MHz; Duty Cycle: 1:1

Medium: HSL_1900_110120 Medium parameters used: $f = 1909$ MHz; $\sigma = 1.43$ mho/m; $\epsilon_r = 41$; $\rho = 1000$

kg/m³

Ambient Temperature : 22.5 ; Liquid Temperature : 21.5

DASY5 Configuration:

- Probe: ET3DV6 - SN1788; ConvF(5.03, 5.03, 5.03); Calibrated: 2010/9/21

- Sensor-Surface: 4mm (Mechanical Surface Detection)

- Electronics: DAE4 Sn913; Calibrated: 2010/11/18

- Phantom: SAM - Front; Type: SAM; Serial: TP-1446

- Measurement SW: DASY5, V5.0 Build 125; SEMCAD X Version 13.4 Build 125

Ch1175/Area Scan (41x81x1): Measurement grid: dx=20mm, dy=20mm

Maximum value of SAR (interpolated) = 1.13 mW/g

Ch1175/Zoom Scan (5x5x7)/Cube 0: Measurement grid: dx=8mm, dy=8mm, dz=5mm

Reference Value = 9.15 V/m; Power Drift = -0.188 dB

Peak SAR (extrapolated) = 1.63 W/kg

SAR(1 g) = 1.09 mW/g; SAR(10 g) = 0.667 mW/g

Maximum value of SAR (measured) = 1.17 mW/g

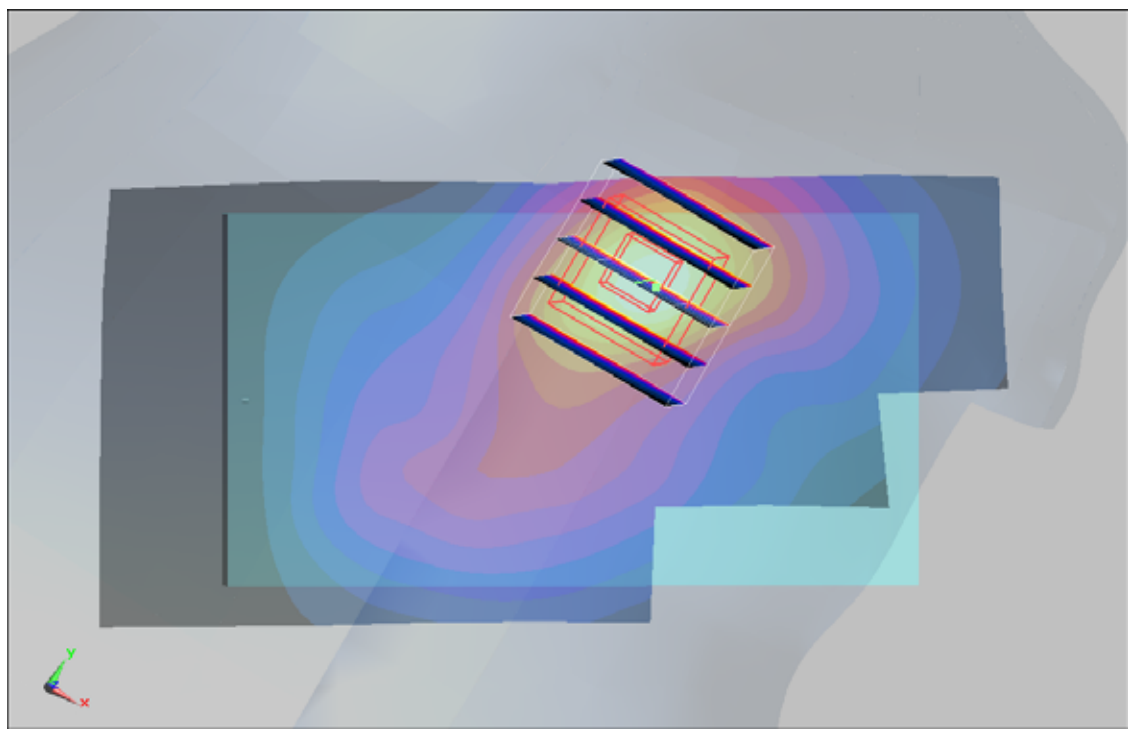
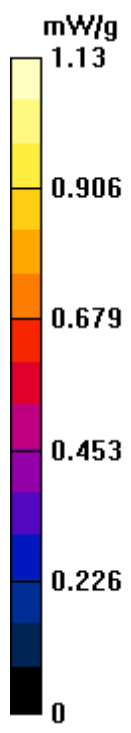

#01 CDMA2000 BC1_RC3+SO55_Right Cheek_Ch1175_2D

DUT: 111226

Communication System: CDMA ; Frequency: 1908.75 MHz; Duty Cycle: 1:1

Medium: HSL_1900_110120 Medium parameters used: $f = 1909$ MHz; $\sigma = 1.43$ mho/m; $\epsilon_r = 41$; $\rho = 1000$ kg/m³

Ambient Temperature : 22.5 ; Liquid Temperature : 21.5

DASY5 Configuration:

- Probe: ET3DV6 - SN1788; ConvF(5.03, 5.03, 5.03); Calibrated: 2010/9/21
- Sensor-Surface: 4mm (Mechanical Surface Detection)
- Electronics: DAE4 Sn913; Calibrated: 2010/11/18
- Phantom: SAM - Front; Type: SAM; Serial: TP-1446
- Measurement SW: DASY5, V5.0 Build 125; SEMCAD X Version 13.4 Build 125

Ch1175/Area Scan (41x81x1): Measurement grid: dx=20mm, dy=20mm

Maximum value of SAR (interpolated) = 1.13 mW/g

Ch1175/Zoom Scan (5x5x7)/Cube 0: Measurement grid: dx=8mm, dy=8mm, dz=5mm

Reference Value = 9.15 V/m; Power Drift = -0.188 dB

Peak SAR (extrapolated) = 1.63 W/kg

SAR(1 g) = 1.09 mW/g; SAR(10 g) = 0.667 mW/g

Maximum value of SAR (measured) = 1.17 mW/g

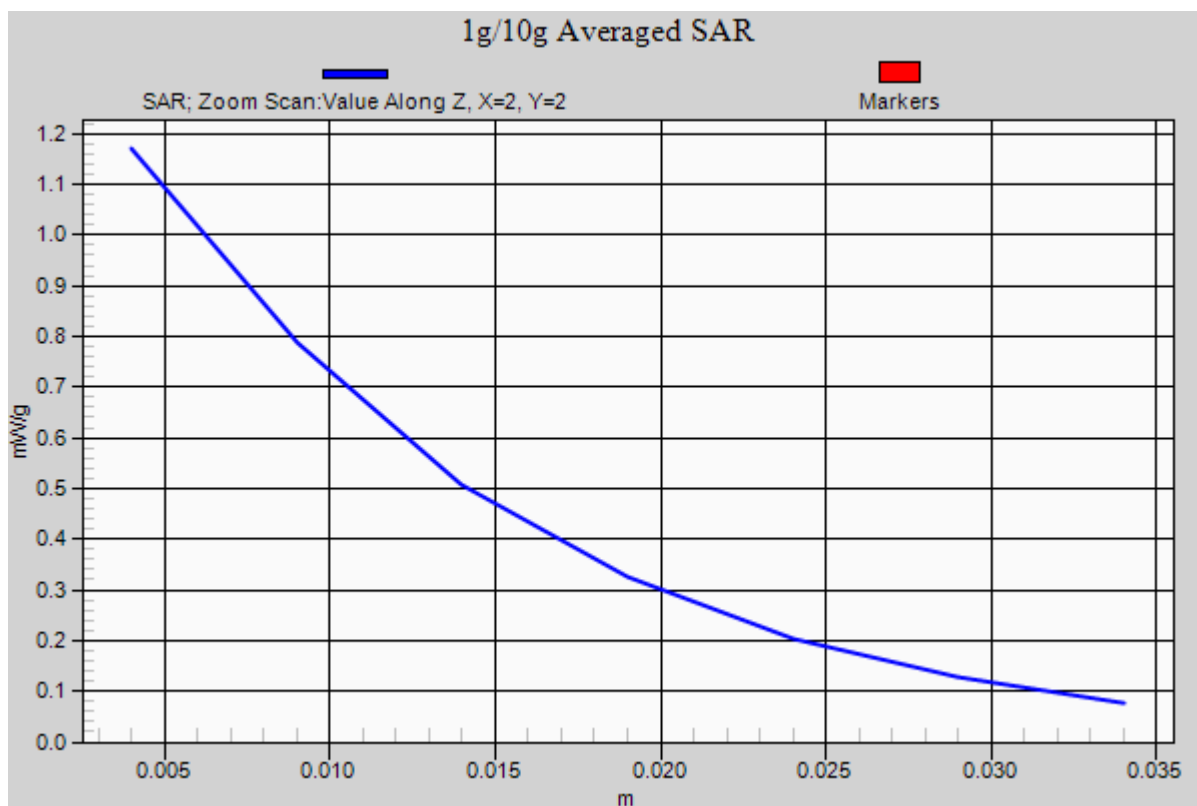

#02 CDMA2000 BC1_RC3+SO55_Right Tilted_Ch1175

DUT: 111226

Communication System: CDMA ; Frequency: 1908.75 MHz; Duty Cycle: 1:1

Medium: HSL_1900_110120 Medium parameters used: $f = 1909$ MHz; $\sigma = 1.43$ mho/m; $\epsilon_r = 41$; $\rho = 1000$

kg/m³

Ambient Temperature : 22.5 ; Liquid Temperature : 21.5

DASY5 Configuration:

- Probe: ET3DV6 - SN1788; ConvF(5.03, 5.03, 5.03); Calibrated: 2010/9/21

- Sensor-Surface: 4mm (Mechanical Surface Detection)

- Electronics: DAE4 Sn913; Calibrated: 2010/11/18

- Phantom: SAM - Front; Type: SAM; Serial: TP-1446

- Measurement SW: DASY5, V5.0 Build 125; SEMCAD X Version 13.4 Build 125

Ch1175/Area Scan (41x81x1): Measurement grid: dx=20mm, dy=20mm

Maximum value of SAR (interpolated) = 0.784 mW/g

Ch1175/Zoom Scan (5x5x7)/Cube 0: Measurement grid: dx=8mm, dy=8mm, dz=5mm

Reference Value = 15.7 V/m; Power Drift = -0.045 dB

Peak SAR (extrapolated) = 0.826 W/kg

SAR(1 g) = 0.575 mW/g; SAR(10 g) = 0.361 mW/g

Maximum value of SAR (measured) = 0.620 mW/g

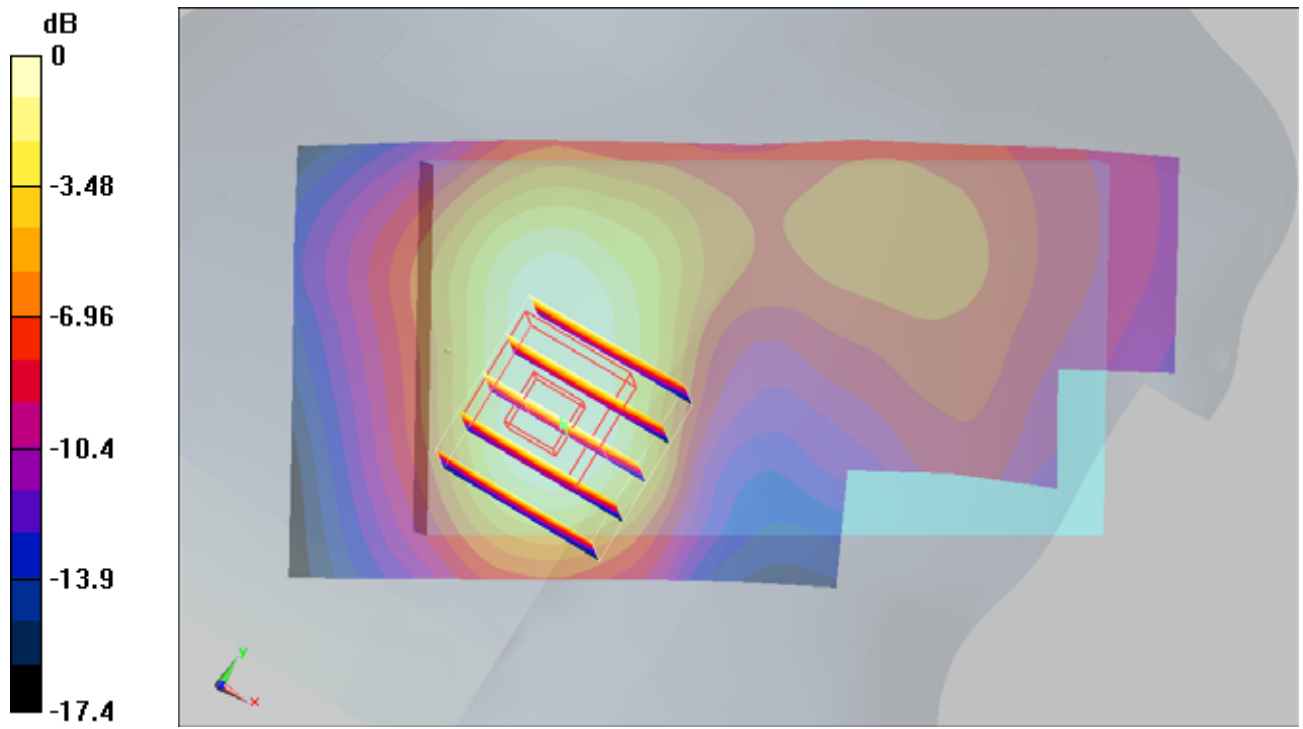

0 dB = 0.620mW/g

#03 CDMA2000 BC1_RC3+SO55_Left Cheek_Ch1175

DUT: 111226

Communication System: CDMA ; Frequency: 1908.75 MHz; Duty Cycle: 1:1

Medium: HSL_1900_110120 Medium parameters used: $f = 1909$ MHz; $\sigma = 1.43$ mho/m; $\epsilon_r = 41$; $\rho = 1000$

kg/m³

Ambient Temperature : 22.5 ; Liquid Temperature : 21.5

DASY5 Configuration:

- Probe: ET3DV6 - SN1788; ConvF(5.03, 5.03, 5.03); Calibrated: 2010/9/21

- Sensor-Surface: 4mm (Mechanical Surface Detection)

- Electronics: DAE4 Sn913; Calibrated: 2010/11/18

- Phantom: SAM - Front; Type: SAM; Serial: TP-1446

- Measurement SW: DASY5, V5.0 Build 125; SEMCAD X Version 13.4 Build 125

Ch1175/Area Scan (41x81x1): Measurement grid: dx=20mm, dy=20mm

Maximum value of SAR (interpolated) = 0.787 mW/g

Ch1175/Zoom Scan (5x5x7)/Cube 0: Measurement grid: dx=8mm, dy=8mm, dz=5mm

Reference Value = 7.53 V/m; Power Drift = -0.128 dB

Peak SAR (extrapolated) = 1.03 W/kg

SAR(1 g) = 0.683 mW/g; SAR(10 g) = 0.425 mW/g

Maximum value of SAR (measured) = 0.728 mW/g

Ch1175/Zoom Scan (5x5x7)/Cube 1: Measurement grid: dx=8mm, dy=8mm, dz=5mm

Reference Value = 7.53 V/m; Power Drift = -0.128 dB

Peak SAR (extrapolated) = 0.829 W/kg

SAR(1 g) = 0.599 mW/g; SAR(10 g) = 0.402 mW/g

Maximum value of SAR (measured) = 0.640 mW/g

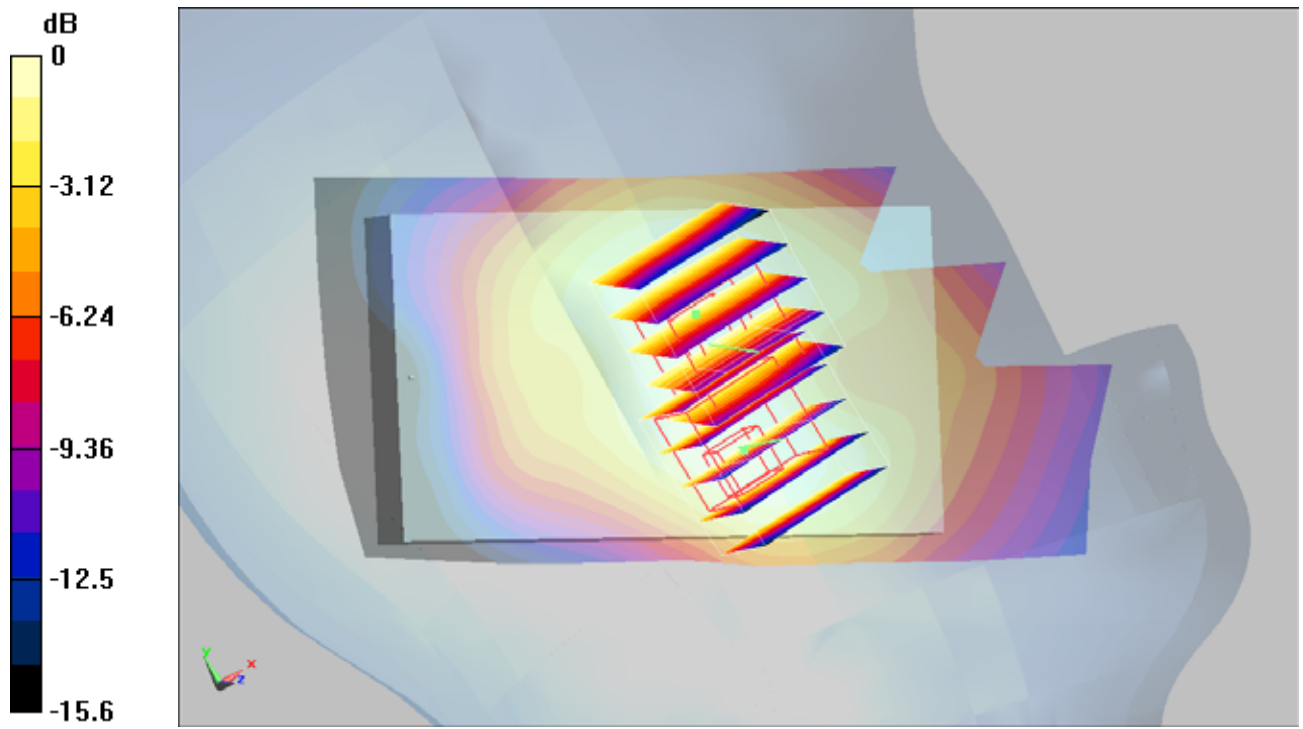

0 dB = 0.640mW/g

#04 CDMA2000 BC1_RC3+SO55_Left Tilted_Ch1175

DUT: 111226

Communication System: CDMA ; Frequency: 1908.75 MHz;Duty Cycle: 1:1

Medium: HSL_1900_110120 Medium parameters used: $f = 1909$ MHz; $\sigma = 1.43$ mho/m; $\epsilon_r = 41$; $\rho = 1000$

kg/m³

Ambient Temperature : 22.5 ; Liquid Temperature : 21.5

DASY5 Configuration:

- Probe: ET3DV6 - SN1788; ConvF(5.03, 5.03, 5.03); Calibrated: 2010/9/21
- Sensor-Surface: 4mm (Mechanical Surface Detection)
- Electronics: DAE4 Sn913; Calibrated: 2010/11/18
- Phantom: SAM - Front; Type: SAM; Serial: TP-1446
- Measurement SW: DASY5, V5.0 Build 125; SEMCAD X Version 13.4 Build 125

Ch1175/Area Scan (41x81x1): Measurement grid: dx=20mm, dy=20mm

Maximum value of SAR (interpolated) = 0.643 mW/g

Ch1175/Zoom Scan (5x5x7)/Cube 0: Measurement grid: dx=8mm, dy=8mm, dz=5mm

Reference Value = 13.9 V/m; Power Drift = -0.067 dB

Peak SAR (extrapolated) = 0.670 W/kg

SAR(1 g) = 0.476 mW/g; SAR(10 g) = 0.302 mW/g

Maximum value of SAR (measured) = 0.506 mW/g

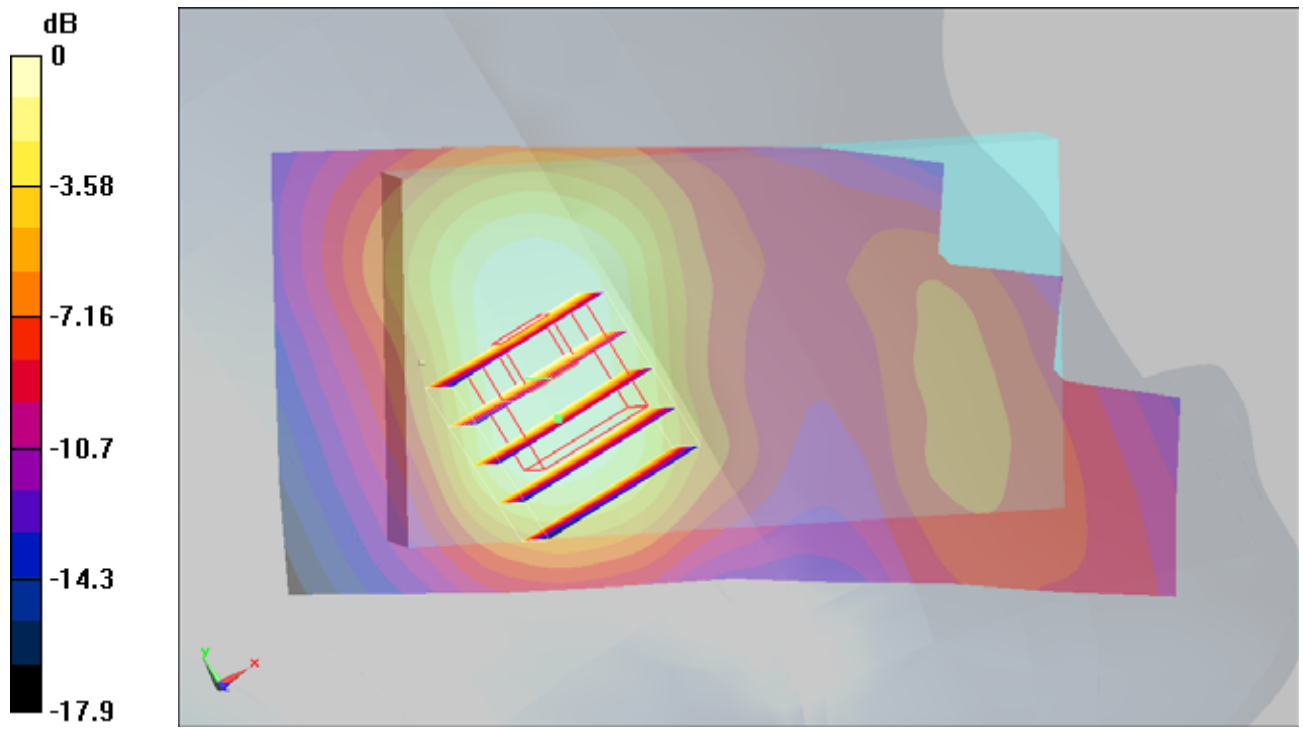

0 dB = 0.506mW/g

#08 CDMA2000 BC1_RC3+SO32_Face_1.5cm_Ch1175

DUT: 111226

Communication System: CDMA ; Frequency: 1908.75 MHz;Duty Cycle: 1:1

Medium: MSL_1900_110126 Medium parameters used: $f = 1909$ MHz; $\sigma = 1.54$ mho/m; $\epsilon_r = 52.8$; $\rho = 1000$ kg/m³

Ambient Temperature : 22.5 °C ; Liquid Temperature : 21.4 °C

DASY4 Configuration:

- Probe: ET3DV6 - SN1787; ConvF(4.47, 4.47, 4.47); Calibrated: 2010/5/18
- Sensor-Surface: 4mm (Mechanical Surface Detection)
- Electronics: DAE4 Sn778; Calibrated: 2010/10/22
- Phantom: ELI 4.0_Front; Type: QDOVA001BB; Serial: 1026
- Measurement SW: DASY4, V4.7 Build 80; Postprocessing SW: SEMCAD, V1.8 Build 186

Ch1175/Area Scan (41x81x1): Measurement grid: dx=20mm, dy=20mm

Maximum value of SAR (interpolated) = 0.709 mW/g

Ch1175/Zoom Scan (5x5x7)/Cube 0: Measurement grid: dx=8mm, dy=8mm, dz=5mm

Reference Value = 13.4 V/m; Power Drift = 0.107 dB

Peak SAR (extrapolated) = 0.821 W/kg

SAR(1 g) = 0.585 mW/g; SAR(10 g) = 0.389 mW/g

Maximum value of SAR (measured) = 0.624 mW/g

Ch1175/Zoom Scan (5x5x7)/Cube 1: Measurement grid: dx=8mm, dy=8mm, dz=5mm

Reference Value = 13.4 V/m; Power Drift = 0.107 dB

Peak SAR (extrapolated) = 0.735 W/kg

SAR(1 g) = 0.552 mW/g; SAR(10 g) = 0.366 mW/g

Maximum value of SAR (measured) = 0.593 mW/g

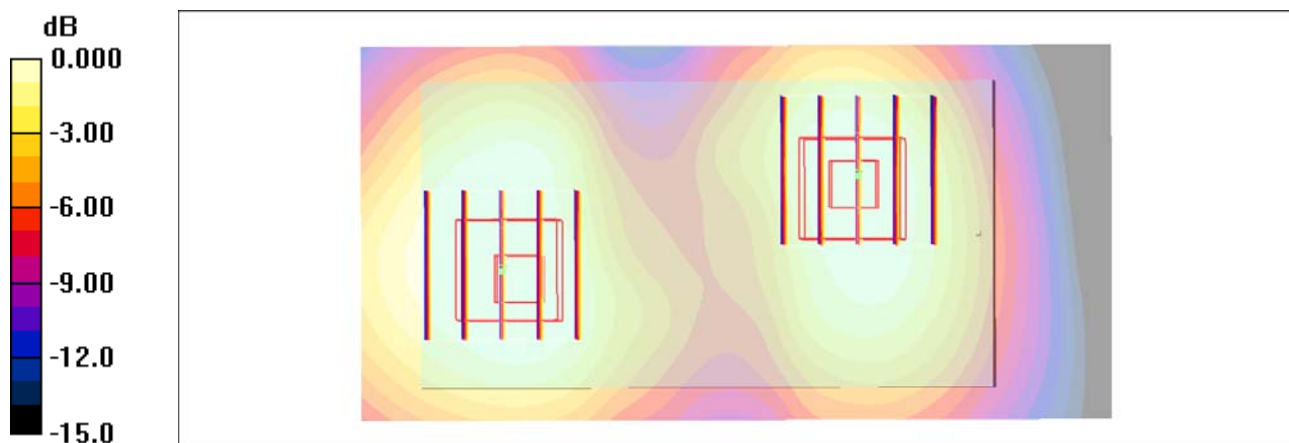

0 dB = 0.593mW/g

#10 CDMA2000 BC1_RC3+SO32_Bottom_1.5cm_Ch25

DUT: 111226

Communication System: CDMA ; Frequency: 1851.25 MHz; Duty Cycle: 1:1

Medium: MSL_1900_110126 Medium parameters used: $f = 1851.25 \text{ MHz}$; $\sigma = 1.49 \text{ mho/m}$; $\epsilon_r =$

53.1 ; $\rho = 1000 \text{ kg/m}^3$

Ambient Temperature : $22.4 \text{ }^\circ\text{C}$; Liquid Temperature : $21.3 \text{ }^\circ\text{C}$

DASY4 Configuration:

- Probe: ET3DV6 - SN1787; ConvF(4.47, 4.47, 4.47); Calibrated: 2010/5/18
- Sensor-Surface: 4mm (Mechanical Surface Detection)
- Electronics: DAE4 Sn778; Calibrated: 2010/10/22
- Phantom: ELI 4.0_Front; Type: QDOVA001BB; Serial: 1026
- Measurement SW: DASY4, V4.7 Build 80; Postprocessing SW: SEMCAD, V1.8 Build 186

Ch25/Area Scan (41x81x1): Measurement grid: $dx=20\text{mm}$, $dy=20\text{mm}$

Maximum value of SAR (interpolated) = 1.32 mW/g

Ch25/Zoom Scan (5x5x7)/Cube 0: Measurement grid: $dx=8\text{mm}$, $dy=8\text{mm}$, $dz=5\text{mm}$

Reference Value = 10.5 V/m ; Power Drift = -0.188 dB

Peak SAR (extrapolated) = 1.72 W/kg

SAR(1 g) = 1.19 mW/g ; SAR(10 g) = 0.702 mW/g

Maximum value of SAR (measured) = 1.34 mW/g

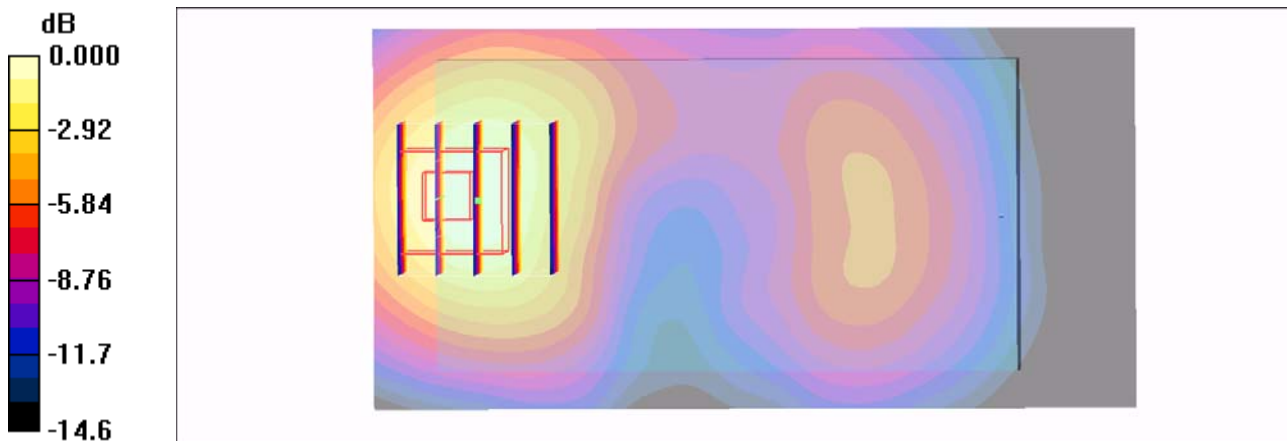

0 dB = 1.34mW/g

#10 CDMA2000 BC1_RC3+SO32_Bottom_1.5cm_Ch25_2D

DUT: 111226

Communication System: CDMA ; Frequency: 1851.25 MHz; Duty Cycle: 1:1

Medium: MSL_1900_110126 Medium parameters used: $f = 1851.25 \text{ MHz}$; $\sigma = 1.49 \text{ mho/m}$; $\epsilon_r =$

53.1 ; $\rho = 1000 \text{ kg/m}^3$

Ambient Temperature : $22.4 \text{ }^\circ\text{C}$; Liquid Temperature : $21.3 \text{ }^\circ\text{C}$

DASY4 Configuration:

- Probe: ET3DV6 - SN1787; ConvF(4.47, 4.47, 4.47); Calibrated: 2010/5/18
- Sensor-Surface: 4mm (Mechanical Surface Detection)
- Electronics: DAE4 Sn778; Calibrated: 2010/10/22
- Phantom: ELI 4.0_Front; Type: QDOVA001BB; Serial: 1026
- Measurement SW: DASY4, V4.7 Build 80; Postprocessing SW: SEMCAD, V1.8 Build 186

Ch25/Area Scan (41x81x1): Measurement grid: $dx=20\text{mm}$, $dy=20\text{mm}$

Maximum value of SAR (interpolated) = 1.32 mW/g

Ch25/Zoom Scan (5x5x7)/Cube 0: Measurement grid: $dx=8\text{mm}$, $dy=8\text{mm}$, $dz=5\text{mm}$

Reference Value = 10.5 V/m ; Power Drift = -0.188 dB

Peak SAR (extrapolated) = 1.72 W/kg

SAR(1 g) = 1.19 mW/g ; SAR(10 g) = 0.702 mW/g

Maximum value of SAR (measured) = 1.34 mW/g

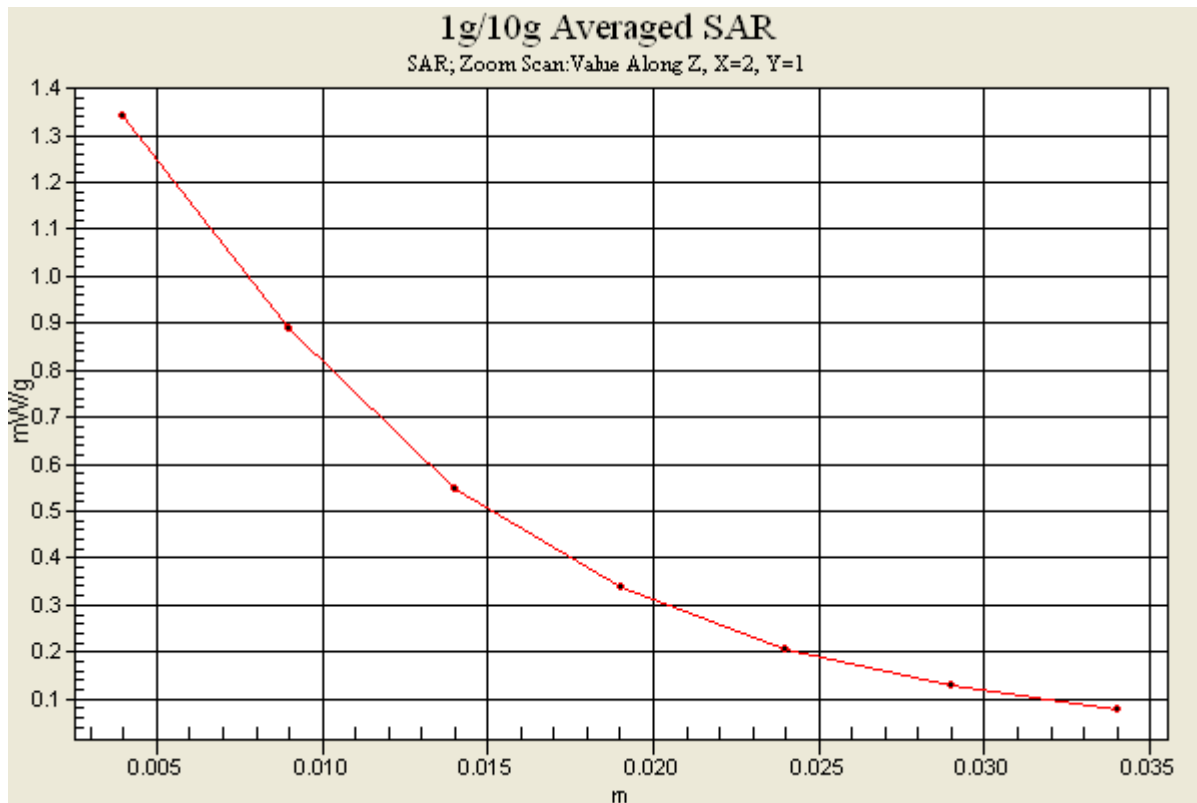



Appendix C. DASYS Calibration Certificate

The DASYS calibration certificates are shown as follows.



Calibration Laboratory of Schmid & Partner Engineering AG Zeughausstrasse 43, 8004 Zurich, Switzerland



S Schweizerischer Kalibrierdienst
C Service suisse d'etalonnage
S Servizio svizzero di taratura
S Swiss Calibration Service

Accredited by the Swiss Accreditation Service (SAS)
The Swiss Accreditation Service is one of the signatories to the EA Multilateral Agreement for the recognition of calibration certificates

Accreditation No.: SCS 108

Client Sporton (Auden)

Certificate No: D1900V2-5d041_Mar10

CALIBRATION CERTIFICATE

Object: D1900V2 - SN: 5d041
Calibration procedure(s): QA CAL-05.v7 Calibration procedure for dipole validation kits
Calibration date: March 23, 2010

This calibration certificate documents the traceability to national standards, which realize the physical units of measurements (SI). The measurements and the uncertainties with confidence probability are given on the following pages and are part of the certificate.

All calibrations have been conducted in the closed laboratory facility: environment temperature (22 ± 3)°C and humidity < 70%.

Calibration Equipment used (M&TE critical for calibration)

Table with 4 columns: Primary Standards, ID #, Cal Date (Certificate No.), Scheduled Calibration. Includes items like Power meter EPM-442A, Power sensor HP 8481A, Reference 20 dB Attenuator, etc.

Calibrated by: Name Dimce Iliev, Function Laboratory Technician, Signature [Handwritten]
Approved by: Name Katja Pokovic, Function Technical Manager, Signature [Handwritten]

Issued: March 23, 2010

This calibration certificate shall not be reproduced except in full without written approval of the laboratory.

Calibration Laboratory of
Schmid & Partner
Engineering AG
Zeughausstrasse 43, 8004 Zurich, Switzerland



S Schweizerischer Kalibrierdienst
C Service suisse d'étalonnage
S Servizio svizzero di taratura
S Swiss Calibration Service

Accredited by the Swiss Accreditation Service (SAS)
The Swiss Accreditation Service is one of the signatories to the EA
Multilateral Agreement for the recognition of calibration certificates

Accreditation No.: SCS 108

Glossary:

TSL	tissue simulating liquid
ConvF	sensitivity in TSL / NORM x,y,z
N/A	not applicable or not measured

Calibration is Performed According to the Following Standards:

- IEEE Std 1528-2003, "IEEE Recommended Practice for Determining the Peak Spatial-Averaged Specific Absorption Rate (SAR) in the Human Head from Wireless Communications Devices: Measurement Techniques", December 2003
- IEC 62209-1, "Procedure to measure the Specific Absorption Rate (SAR) for hand-held devices used in close proximity to the ear (frequency range of 300 MHz to 3 GHz)", February 2005
- Federal Communications Commission Office of Engineering & Technology (FCC OET), "Evaluating Compliance with FCC Guidelines for Human Exposure to Radiofrequency Electromagnetic Fields; Additional Information for Evaluating Compliance of Mobile and Portable Devices with FCC Limits for Human Exposure to Radiofrequency Emissions", Supplement C (Edition 01-01) to Bulletin 65

Additional Documentation:

- DASY4/5 System Handbook

Methods Applied and Interpretation of Parameters:

- Measurement Conditions:* Further details are available from the Validation Report at the end of the certificate. All figures stated in the certificate are valid at the frequency indicated.
- Antenna Parameters with TSL:* The dipole is mounted with the spacer to position its feed point exactly below the center marking of the flat phantom section, with the arms oriented parallel to the body axis.
- Feed Point Impedance and Return Loss:* These parameters are measured with the dipole positioned under the liquid filled phantom. The impedance stated is transformed from the measurement at the SMA connector to the feed point. The Return Loss ensures low reflected power. No uncertainty required.
- Electrical Delay:* One-way delay between the SMA connector and the antenna feed point. No uncertainty required.
- SAR measured:* SAR measured at the stated antenna input power.
- SAR normalized:* SAR as measured, normalized to an input power of 1 W at the antenna connector.
- SAR for nominal TSL parameters:* The measured TSL parameters are used to calculate the nominal SAR result.



Measurement Conditions

DASY system configuration, as far as not given on page 1.

DASY Version	DASY5	V5.2
Extrapolation	Advanced Extrapolation	
Phantom	Modular Flat Phantom V5.0	
Distance Dipole Center - TSL	10 mm	with Spacer
Zoom Scan Resolution	dx, dy, dz = 5 mm	
Frequency	1900 MHz \pm 1 MHz	

Head TSL parameters

The following parameters and calculations were applied.

	Temperature	Permittivity	Conductivity
Nominal Head TSL parameters	22.0 °C	40.0	1.40 mho/m
Measured Head TSL parameters	(22.0 \pm 0.2) °C	41.1 \pm 6 %	1.45 mho/m \pm 6 %
Head TSL temperature during test	(21.5 \pm 0.2) °C	----	----

SAR result with Head TSL

SAR averaged over 1 cm ³ (1 g) of Head TSL	Condition	
SAR measured	250 mW input power	10.1 mW / g
SAR normalized	normalized to 1W	40.4 mW / g
SAR for nominal Head TSL parameters	normalized to 1W	39.8 mW / g \pm 17.0 % (k=2)

SAR averaged over 10 cm ³ (10 g) of Head TSL	condition	
SAR measured	250 mW input power	5.25 mW / g
SAR normalized	normalized to 1W	21.0 mW / g
SAR for nominal Head TSL parameters	normalized to 1W	20.9 mW / g \pm 16.5 % (k=2)



Body TSL parameters

The following parameters and calculations were applied.

	Temperature	Permittivity	Conductivity
Nominal Body TSL parameters	22.0 °C	53.3	1.52 mho/m
Measured Body TSL parameters	(22.0 ± 0.2) °C	54.9 ± 6 %	1.58 mho/m ± 6 %
Body TSL temperature during test	(21.5 ± 0.2) °C	----	----

SAR result with Body TSL

SAR averaged over 1 cm ³ (1 g) of Body TSL	Condition	
SAR measured	250 mW input power	10.4 mW / g
SAR normalized	normalized to 1W	41.6 mW / g
SAR for nominal Body TSL parameters	normalized to 1W	40.0 mW / g ± 17.0 % (k=2)

SAR averaged over 10 cm ³ (10 g) of Body TSL	condition	
SAR measured	250 mW input power	5.57 mW / g
SAR normalized	normalized to 1W	22.3 mW / g
SAR for nominal Body TSL parameters	normalized to 1W	22.1 mW / g ± 16.5 % (k=2)



Appendix

Antenna Parameters with Head TSL

Impedance, transformed to feed point	50.9 Ω + 5.9 j Ω
Return Loss	- 24.6 dB

Antenna Parameters with Body TSL

Impedance, transformed to feed point	46.3 Ω + 5.7 j Ω
Return Loss	- 23.1 dB

General Antenna Parameters and Design

Electrical Delay (one direction)	1.202 ns
----------------------------------	----------

After long term use with 100W radiated power, only a slight warming of the dipole near the feedpoint can be measured.

The dipole is made of standard semirigid coaxial cable. The center conductor of the feeding line is directly connected to the second arm of the dipole. The antenna is therefore short-circuited for DC-signals.

No excessive force must be applied to the dipole arms, because they might bend or the soldered connections near the feedpoint may be damaged.

Additional EUT Data

Manufactured by	SPEAG
Manufactured on	July 04, 2003

DASY5 Validation Report for Head TSL

Date/Time: 23.03.2010 12:03:30

Test Laboratory: SPEAG, Zurich, Switzerland

DUT: Dipole 1900 MHz; Type: D1900V2; Serial: D1900V2 - SN:5d041

Communication System: CW; Frequency: 1900 MHz; Duty Cycle: 1:1

Medium: HSL U11 BB

Medium parameters used: $f = 1900$ MHz; $\sigma = 1.45$ mho/m; $\epsilon_r = 41.2$; $\rho = 1000$ kg/m³

Phantom section: Flat Section

Measurement Standard: DASYS (IEEE/IEC/ANSI C63.19-2007)

DASY5 Configuration:

- Probe: ES3DV3 - SN3205; ConvF(5.09, 5.09, 5.09); Calibrated: 26.06.2009
- Sensor-Surface: 3mm (Mechanical Surface Detection)
- Electronics: DAE4 Sn601; Calibrated: 02.03.2010
- Phantom: Flat Phantom 5.0 (front); Type: QD000P50AA; Serial: 1001
- Measurement SW: DASYS, V5.2 Build 157; SEMCAD X Version 14.0 Build 57

Pin=250 mW /d=10mm, dist=3.0mm (ES-Probe)/Zoom Scan (7x7x7) /Cube 0: Measurement grid: dx=5mm, dy=5mm, dz=5mm

Reference Value = 96.8 V/m; Power Drift = 0.040 dB

Peak SAR (extrapolated) = 18.4 W/kg

SAR(1 g) = 10.1 mW/g; SAR(10 g) = 5.25 mW/g

Maximum value of SAR (measured) = 12.7 mW/g

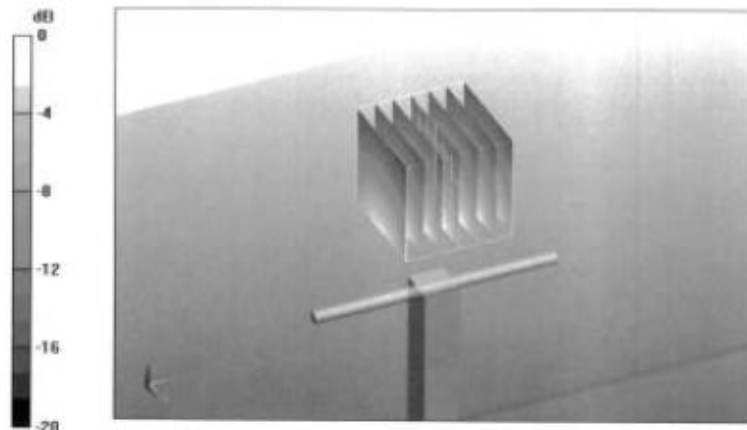

0 dB = 12.7mW/g



Impedance Measurement Plot for Head TSL

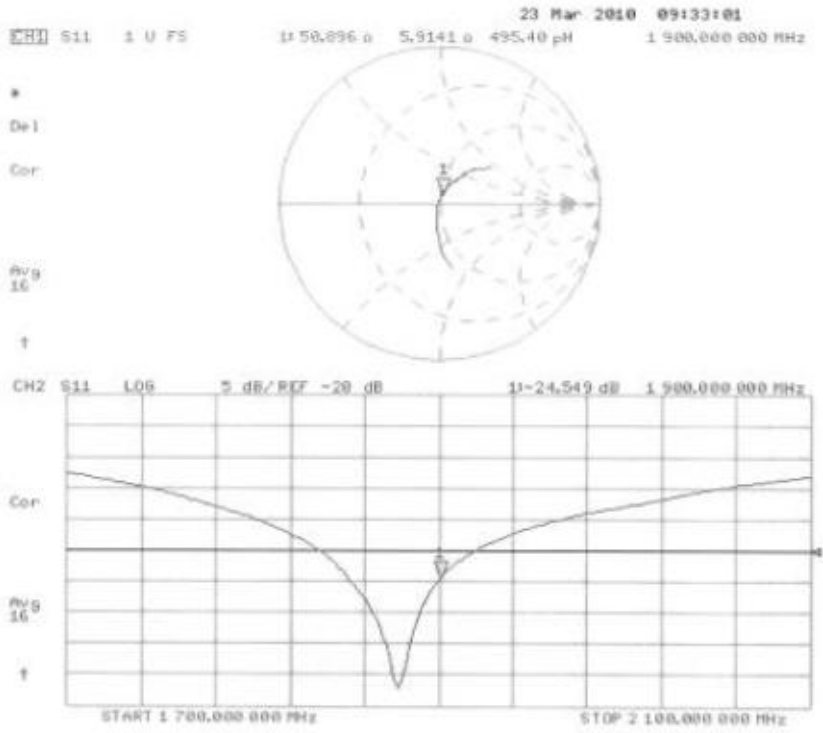

DASY5 Validation Report for Body

Date/Time: 17.03.2010 12:43:32

Test Laboratory: SPEAG, Zurich, Switzerland

DUT: Dipole 1900 MHz; Type: D1900V2; Serial: D1900V2 - SN:5d041

Communication System: CW; Frequency: 1900 MHz; Duty Cycle: 1:1

Medium: MSL U11 BB

Medium parameters used: $f = 1900$ MHz; $\sigma = 1.58$ mho/m; $\epsilon_r = 55$; $\rho = 1000$ kg/m³

Phantom section: Flat Section

Measurement Standard: DASY5 (IEEE/IEC/ANSI C63.19-2007)

DASY5 Configuration:

- Probe: ES3DV3 - SN3205; ConvF(4.59, 4.59, 4.59); Calibrated: 26.06.2009
- Sensor-Surface: 3mm (Mechanical Surface Detection)
- Electronics: DAE4 Sn601; Calibrated: 02.03.2010
- Phantom: Flat Phantom 5.0 (back); Type: QD000P50AA; Serial: 1002
- Measurement SW: DASY5, V5.2 Build 157; SEMCAD X Version 14.0 Build 57

Pin250 mW /d=10mm, dist=3.0mm (ES-Probe)/Zoom Scan (7x7x7) /Cube 0: Measurement

grid: dx=5mm, dy=5mm, dz=5mm

Reference Value = 96.1 V/m; Power Drift = 0.017 dB

Peak SAR (extrapolated) = 17.5 W/kg

SAR(1 g) = 10.4 mW/g; SAR(10 g) = 5.57 mW/g

Maximum value of SAR (measured) = 13.1 mW/g

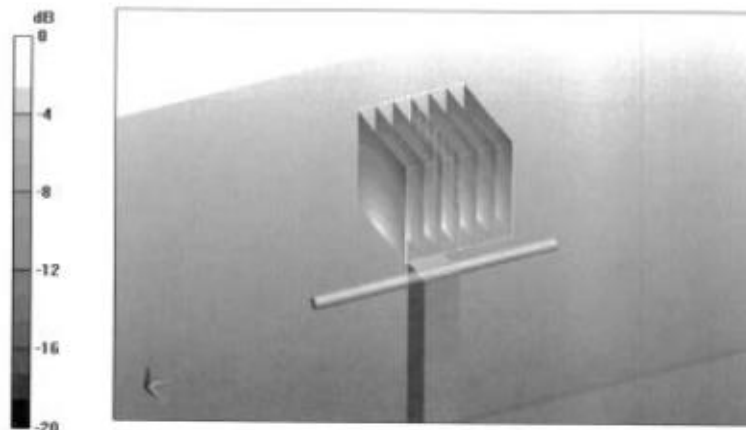

0 dB = 13.1mW/g



Impedance Measurement Plot for Body TSL

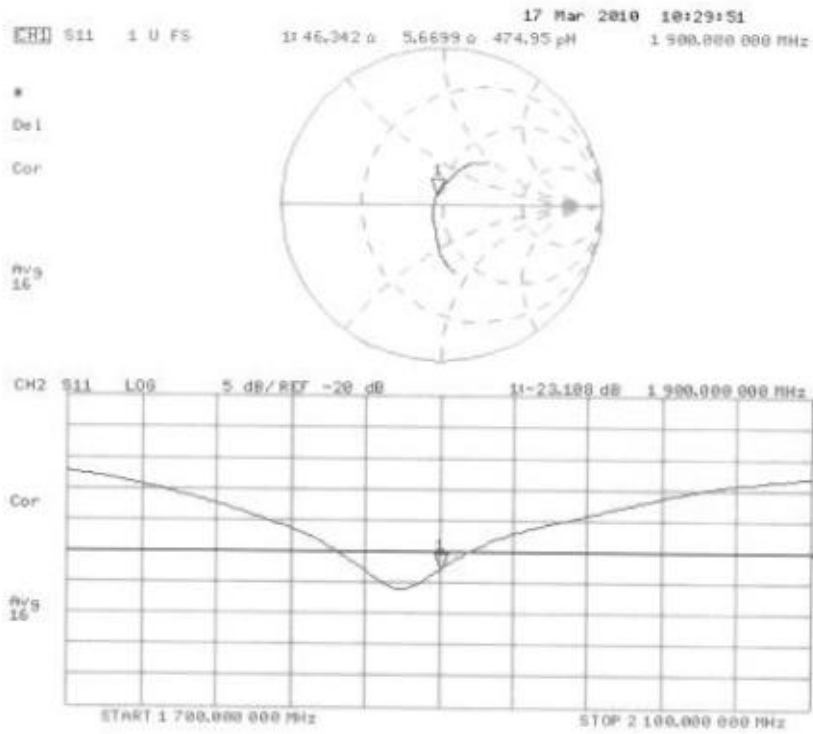



Calibration Laboratory of Schmid & Partner Engineering AG, Zeughausstrasse 43, 8004 Zurich, Switzerland



S Schweizerischer Kalibrierdienst, S Service suisse d'étalonnage, S Servizio svizzero di taratura, S Swiss Calibration Service

Accredited by the Swiss Accreditation Service (SAS). The Swiss Accreditation Service is one of the signatories to the EA Multilateral Agreement for the recognition of calibration certificates

Accreditation No.: SCS 108

Client Sporton (Auden)

Certificate No: DAE4-778_Oct10

CALIBRATION CERTIFICATE

Object: DAE4 - SD 000 D04 BJ - SN: 778
Calibration procedure(s): QA CAL-06.v22 Calibration procedure for the data acquisition electronics (DAE)
Calibration date: October 22, 2010

This calibration certificate documents the traceability to national standards, which realize the physical units of measurements (SI). The measurements and the uncertainties with confidence probability are given on the following pages and are part of the certificate.

All calibrations have been conducted in the closed laboratory facility: environment temperature (22 ± 3)°C and humidity < 70%.

Calibration Equipment used (M&TE critical for calibration)

Table with 4 columns: Standard Type, ID #, Date, and Check/Cal Date. Includes entries for Keithley Multimeter Type 2001 and Calibrator Box V1.1.

Calibrated by: Eric Hainfeld, Technician
Approved by: Fin Bornholt, R&D Director

Issued: October 22, 2010

This calibration certificate shall not be reproduced except in full without written approval of the laboratory.

Calibration Laboratory of
Schmid & Partner
Engineering AG
Zeughausstrasse 43, 8004 Zurich, Switzerland



S Schweizerischer Kalibrierdienst
C Service suisse d'étalonnage
S Servizio svizzero di taratura
S Swiss Calibration Service

Accredited by the Swiss Accreditation Service (SAS)
The Swiss Accreditation Service is one of the signatories to the EA
Multilateral Agreement for the recognition of calibration certificates

Accreditation No.: **SCS 108**

Glossary

DAE data acquisition electronics
Connector angle information used in DAS Y system to align probe sensor X to the robot coordinate system.

Methods Applied and Interpretation of Parameters

- **DC Voltage Measurement:** Calibration Factor assessed for use in DAS Y system by comparison with a calibrated instrument traceable to national standards. The figure given corresponds to the full scale range of the voltmeter in the respective range.
- **Connector angle:** The angle of the connector is assessed measuring the angle mechanically by a tool inserted. Uncertainty is not required.
- The following parameters as documented in the Appendix contain technical information as a result from the performance test and require no uncertainty.
 - **DC Voltage Measurement Linearity:** Verification of the Linearity at +10% and -10% of the nominal calibration voltage. Influence of offset voltage is included in this measurement.
 - **Common mode sensitivity:** Influence of a positive or negative common mode voltage on the differential measurement.
 - **Channel separation:** Influence of a voltage on the neighbor channels not subject to an input voltage.
 - **AD Converter Values with inputs shorted:** Values on the internal AD converter corresponding to zero input voltage
 - **Input Offset Measurement:** Output voltage and statistical results over a large number of zero voltage measurements.
 - **Input Offset Current:** Typical value for information; Maximum channel input offset current, not considering the input resistance.
 - **Input resistance:** Typical value for information: DAE input resistance at the connector, during internal auto-zeroing and during measurement.
 - **Low Battery Alarm Voltage:** Typical value for information. Below this voltage, a battery alarm signal is generated.
 - **Power consumption:** Typical value for information. Supply currents in various operating modes.



DC Voltage Measurement

A/D - Converter Resolution nominal

High Range: 1LSB = 6.1 μ V , full range = -100...+300 mV

Low Range: 1LSB = 61nV , full range = -1.....+3mV

DASY measurement parameters: Auto Zero Time: 3 sec; Measuring time: 3 sec

Calibration Factors	X	Y	Z
High Range	404.679 \pm 0.1% (k=2)	403.480 \pm 0.1% (k=2)	405.025 \pm 0.1% (k=2)
Low Range	3.98633 \pm 0.7% (k=2)	3.96375 \pm 0.7% (k=2)	3.99940 \pm 0.7% (k=2)

Connector Angle

Connector Angle to be used in DASY system	64.5 $^{\circ}$ \pm 1 $^{\circ}$
---	------------------------------------



Appendix

1. DC Voltage Linearity

High Range	Reading (μV)	Difference (μV)	Error (%)
Channel X + Input	200004.4	1.89	0.00
Channel X + Input	20001.11	1.41	0.01
Channel X - Input	-19998.36	1.54	-0.01
Channel Y + Input	199996.1	3.42	0.00
Channel Y + Input	19999.75	0.35	0.00
Channel Y - Input	-19999.92	-0.12	0.00
Channel Z + Input	200002.7	1.29	0.00
Channel Z + Input	19996.85	-2.55	-0.01
Channel Z - Input	-20004.31	-4.61	0.02

Low Range	Reading (μV)	Difference (μV)	Error (%)
Channel X + Input	2000.0	0.09	0.00
Channel X + Input	200.02	0.02	0.01
Channel X - Input	-198.62	1.48	-0.74
Channel Y + Input	1999.6	-0.58	-0.03
Channel Y + Input	199.13	-0.57	-0.29
Channel Y - Input	-200.71	-0.61	0.31
Channel Z + Input	2000.1	-0.01	-0.00
Channel Z + Input	198.96	-1.14	-0.57
Channel Z - Input	-200.98	-0.98	0.49

2. Common mode sensitivity

DASY measurement parameters: Auto Zero Time: 3 sec; Measuring time: 3 sec

	Common mode Input Voltage (mV)	High Range Average Reading (μV)	Low Range Average Reading (μV)
Channel X	200	-5.28	-6.07
	- 200	6.79	6.12
Channel Y	200	-1.80	-1.60
	- 200	0.97	0.35
Channel Z	200	-9.76	-9.86
	- 200	7.56	7.61

3. Channel separation

DASY measurement parameters: Auto Zero Time: 3 sec; Measuring time: 3 sec

	Input Voltage (mV)	Channel X (μV)	Channel Y (μV)	Channel Z (μV)
Channel X	200	-	1.86	-0.66
Channel Y	200	2.28	-	2.89
Channel Z	200	1.68	-0.15	-



4. AD-Converter Values with inputs shorted

DASY measurement parameters: Auto Zero Time: 3 sec; Measuring time: 3 sec

	High Range (LSB)	Low Range (LSB)
Channel X	16056	16950
Channel Y	16153	13741
Channel Z	16441	16086

5. Input Offset Measurement

DASY measurement parameters: Auto Zero Time: 3 sec; Measuring time: 3 sec

Input 10MΩ

	Average (μV)	min. Offset (μV)	max. Offset (μV)	Std. Deviation (μV)
Channel X	0.32	-2.35	2.08	0.55
Channel Y	-1.83	-2.96	-0.72	0.47
Channel Z	-1.93	-3.00	-0.90	0.45

6. Input Offset Current

Nominal Input circuitry offset current on all channels: <25fA

7. Input Resistance (Typical values for information)

	Zeroing (kOhm)	Measuring (MOhm)
Channel X	200	200
Channel Y	200	200
Channel Z	200	200

8. Low Battery Alarm Voltage (Typical values for information)

Typical values	Alarm Level (VDC)
Supply (+ Vcc)	+7.9
Supply (- Vcc)	-7.6

9. Power Consumption (Typical values for information)

Typical values	Switched off (mA)	Stand by (mA)	Transmitting (mA)
Supply (+ Vcc)	+0.01	+6	+14
Supply (- Vcc)	-0.01	-8	-9



Calibration Laboratory of Schmid & Partner Engineering AG Zeughausstrasse 43, 8004 Zurich, Switzerland



S Schweizerischer Kalibrierdienst
C Service suisse d'etalonnage
S Servizio svizzero di taratura
S Swiss Calibration Service

Accredited by the Swiss Accreditation Service (SAS)
The Swiss Accreditation Service is one of the signatories to the EA Multilateral Agreement for the recognition of calibration certificates

Accreditation No.: SCS 108

Client Auden

Certificate No: DAE4-913_Nov10

CALIBRATION CERTIFICATE

Object: DAE4 - SD 000 D04 BK - SN: 913
Calibration procedure(s): QA CAL-06.v22 Calibration procedure for the data acquisition electronics (DAE)
Calibration date: November 18, 2010

This calibration certificate documents the traceability to national standards, which realize the physical units of measurements (SI). The measurements and the uncertainties with confidence probability are given on the following pages and are part of the certificate.

All calibrations have been conducted in the closed laboratory facility: environment temperature (22 ± 3)°C and humidity < 70%.

Calibration Equipment used (M&TE critical for calibration)

Table with 4 columns: Standards, ID #, Date, and Check/Schedule. Includes Primary Standards (Keithley Multimeter) and Secondary Standards (Calibrator Box).

Calibrated by: Andrea Guntli, Technician
Approved by: Fin Bornholt, R&D Director

Issued: November 18, 2010

This calibration certificate shall not be reproduced except in full without written approval of the laboratory.

**Calibration Laboratory of
Schmid & Partner
Engineering AG**
Zeughausstrasse 43, 8004 Zurich, Switzerland



S Schweizerischer Kalibrierdienst
C Service suisse d'étalonnage
S Servizio svizzero di taratura
S Swiss Calibration Service

Accredited by the Swiss Accreditation Service (SAS)
The Swiss Accreditation Service is one of the signatories to the EA
Multilateral Agreement for the recognition of calibration certificates

Accreditation No.: **SCS 108**

Glossary

DAE data acquisition electronics
Connector angle information used in DASY system to align probe sensor X to the robot coordinate system.

Methods Applied and Interpretation of Parameters

- **DC Voltage Measurement:** Calibration Factor assessed for use in DASY system by comparison with a calibrated instrument traceable to national standards. The figure given corresponds to the full scale range of the voltmeter in the respective range.
- **Connector angle:** The angle of the connector is assessed measuring the angle mechanically by a tool inserted. Uncertainty is not required.
- The following parameters as documented in the Appendix contain technical information as a result from the performance test and require no uncertainty.
 - **DC Voltage Measurement Linearity:** Verification of the Linearity at +10% and -10% of the nominal calibration voltage. Influence of offset voltage is included in this measurement.
 - **Common mode sensitivity:** Influence of a positive or negative common mode voltage on the differential measurement.
 - **Channel separation:** Influence of a voltage on the neighbor channels not subject to an input voltage.
 - **AD Converter Values with inputs shorted:** Values on the internal AD converter corresponding to zero input voltage
 - **Input Offset Measurement:** Output voltage and statistical results over a large number of zero voltage measurements.
 - **Input Offset Current:** Typical value for information; Maximum channel input offset current, not considering the input resistance.
 - **Input resistance:** Typical value for information: DAE input resistance at the connector, during internal auto-zeroing and during measurement.
 - **Low Battery Alarm Voltage:** Typical value for information. Below this voltage, a battery alarm signal is generated.
 - **Power consumption:** Typical value for information. Supply currents in various operating modes.



DC Voltage Measurement

A/D - Converter Resolution nominal

High Range: 1LSB = 6.1µV, full range = -100...+300 mV

Low Range: 1LSB = 61nV, full range = -1.....+3mV

DASY measurement parameters: Auto Zero Time: 3 sec; Measuring time: 3 sec

Calibration Factors	X	Y	Z
High Range	404.184 ± 0.1% (k=2)	404.584 ± 0.1% (k=2)	405.128 ± 0.1% (k=2)
Low Range	3.97436 ± 0.7% (k=2)	4.02029 ± 0.7% (k=2)	4.02107 ± 0.7% (k=2)

Connector Angle

Connector Angle to be used in DASY system	169.5 ° ± 1 °
---	---------------



Appendix

1. DC Voltage Linearity

High Range	Reading (μV)	Difference (μV)	Error (%)
Channel X + Input	200000.1	-3.16	-0.00
Channel X + Input	20002.82	2.62	0.01
Channel X - Input	-19998.55	0.95	-0.00
Channel Y + Input	200000.3	-1.86	-0.00
Channel Y + Input	20001.18	0.98	0.00
Channel Y - Input	-20000.28	-0.88	0.00
Channel Z + Input	200000.3	-1.18	-0.00
Channel Z + Input	20000.48	0.48	0.00
Channel Z - Input	-20002.84	-2.54	0.01

Low Range	Reading (μV)	Difference (μV)	Error (%)
Channel X + Input	2001.3	1.27	0.06
Channel X + Input	199.36	-0.74	-0.37
Channel X - Input	-199.73	0.37	-0.19
Channel Y + Input	2000.0	-0.00	-0.00
Channel Y + Input	199.49	-0.41	-0.20
Channel Y - Input	-201.67	-1.87	0.94
Channel Z + Input	2000.4	0.36	0.02
Channel Z + Input	199.35	-0.65	-0.32
Channel Z - Input	-202.38	-2.48	1.24

2. Common mode sensitivity

DASY measurement parameters: Auto Zero Time: 3 sec; Measuring time: 3 sec

	Common mode Input Voltage (mV)	High Range Average Reading (μV)	Low Range Average Reading (μV)
Channel X	200	-13.95	-16.22
	- 200	17.51	15.74
Channel Y	200	-7.99	-7.96
	- 200	6.46	6.09
Channel Z	200	7.83	7.59
	- 200	-10.45	-10.43

3. Channel separation

DASY measurement parameters: Auto Zero Time: 3 sec; Measuring time: 3 sec

	Input Voltage (mV)	Channel X (μV)	Channel Y (μV)	Channel Z (μV)
Channel X	200	-	4.34	0.24
Channel Y	200	1.83	-	4.52
Channel Z	200	2.62	-0.19	-



4. AD-Converter Values with inputs shorted

DASY measurement parameters: Auto Zero Time: 3 sec; Measuring time: 3 sec

	High Range (LSB)	Low Range (LSB)
Channel X	15736	15737
Channel Y	15978	14708
Channel Z	16017	14960

5. Input Offset Measurement

DASY measurement parameters: Auto Zero Time: 3 sec; Measuring time: 3 sec

Input 10M Ω

	Average (μ V)	min. Offset (μ V)	max. Offset (μ V)	Std. Deviation (μ V)
Channel X	0.11	-1.34	2.10	0.67
Channel Y	-0.60	-2.27	0.97	0.74
Channel Z	-0.85	-2.98	0.71	0.64

6. Input Offset Current

Nominal input circuitry offset current on all channels: <25fA

7. Input Resistance (Typical values for information)

	Zeroing (kOhm)	Measuring (MOhm)
Channel X	200	200
Channel Y	200	200
Channel Z	200	200

8. Low Battery Alarm Voltage (Typical values for information)

Typical values	Alarm Level (VDC)
Supply (+ Vcc)	+7.9
Supply (- Vcc)	-7.6

9. Power Consumption (Typical values for information)

Typical values	Switched off (mA)	Stand by (mA)	Transmitting (mA)
Supply (+ Vcc)	+0.01	+6	+14
Supply (- Vcc)	-0.01	-8	-9



Calibration Laboratory of Schmid & Partner Engineering AG Zeughausstrasse 43, 8004 Zurich, Switzerland



S Schweizerischer Kalibrierdienst
C Service suisse d'etalonnage
S Servizio svizzero di taratura
S Swiss Calibration Service

Accredited by the Swiss Accreditation Service (SAS)
The Swiss Accreditation Service is one of the signatories to the EA Multilateral Agreement for the recognition of calibration certificates

Accreditation No.: SCS 108

Client Sporton (Auden)

Certificate No: ET3-1787_May10

CALIBRATION CERTIFICATE

Object: ET3DV6 - SN:1787
Calibration procedure(s): QA CAL-01.v6, QA CAL-23.v3 and QA CAL-25.v2 Calibration procedure for dosimetric E-field probes
Calibration date: May 18, 2010

This calibration certificate documents the traceability to national standards, which realize the physical units of measurements (SI). The measurements and the uncertainties with confidence probability are given on the following pages and are part of the certificate.

All calibrations have been conducted in the closed laboratory facility: environment temperature (22 ± 3)°C and humidity < 70%.

Calibration Equipment used (M&TE critical for calibration)

Table with 4 columns: Primary Standards, ID #, Cal Date (Certificate No.), Scheduled Calibration. Lists equipment like Power meter E4419B, Power sensor E4412A, Reference 3 dB Attenuator, etc.

Table with 4 columns: Secondary Standards, ID #, Check Date (in house), Scheduled Check. Lists RF generator HP 8648C, Network Analyzer HP 8753E.

Calibrated by: Jeton Kastrali, Laboratory Technician
Approved by: Katja Pokovic, Technical Manager

Issued: May 22, 2010

This calibration certificate shall not be reproduced except in full without written approval of the laboratory.

Calibration Laboratory of
Schmid & Partner
Engineering AG
 Zeughausstrasse 43, 8004 Zurich, Switzerland



S Schweizerischer Kalibrierdienst
S Service suisse d'étalonnage
C Servizio svizzero di taratura
S Swiss Calibration Service

Accredited by the Swiss Accreditation Service (SAS)

Accreditation No.: **SCS 108**

The Swiss Accreditation Service is one of the signatories to the EA
 Multilateral Agreement for the recognition of calibration certificates

Glossary:

TSL	tissue simulating liquid
NORM _{x,y,z}	sensitivity in free space
ConvF	sensitivity in TSL / NORM _{x,y,z}
DCP	diode compression point
CF	crest factor (1/duty_cycle) of the RF signal
A, B, C	modulation dependent linearization parameters
Polarization φ	φ rotation around probe axis
Polarization ϑ	ϑ rotation around an axis that is in the plane normal to probe axis (at measurement center), i.e., $\vartheta = 0$ is normal to probe axis

Calibration is Performed According to the Following Standards:

- IEEE Std 1528-2003, "IEEE Recommended Practice for Determining the Peak Spatial-Averaged Specific Absorption Rate (SAR) in the Human Head from Wireless Communications Devices: Measurement Techniques", December 2003
- IEC 62209-1, "Procedure to measure the Specific Absorption Rate (SAR) for hand-held devices used in close proximity to the ear (frequency range of 300 MHz to 3 GHz)", February 2005

Methods Applied and Interpretation of Parameters:

- NORM_{x,y,z}**: Assessed for E-field polarization $\vartheta = 0$ ($f \leq 900$ MHz in TEM-cell; $f > 1800$ MHz: R22 waveguide). NORM_{x,y,z} are only intermediate values, i.e., the uncertainties of NORM_{x,y,z} does not effect the E²-field uncertainty inside TSL (see below ConvF).
- NORM(f)_{x,y,z}** = NORM_{x,y,z} * frequency_response (see Frequency Response Chart). This linearization is implemented in DAS Y4 software versions later than 4.2. The uncertainty of the frequency response is included in the stated uncertainty of ConvF.
- DCP_{x,y,z}**: DCP are numerical linearization parameters assessed based on the data of power sweep with CW signal (no uncertainty required). DCP does not depend on frequency nor media.
- A_{x,y,z}; B_{x,y,z}; C_{x,y,z}; VR_{x,y,z}; A, B, C** are numerical linearization parameters assessed based on the data of power sweep for specific modulation signal. The parameters do not depend on frequency nor media. VR is the maximum calibration range expressed in RMS voltage across the diode.
- ConvF and Boundary Effect Parameters**: Assessed in flat phantom using E-field (or Temperature Transfer Standard for $f \leq 800$ MHz) and inside waveguide using analytical field distributions based on power measurements for $f > 800$ MHz. The same setups are used for assessment of the parameters applied for boundary compensation (alpha, depth) of which typical uncertainty values are given. These parameters are used in DAS Y4 software to improve probe accuracy close to the boundary. The sensitivity in TSL corresponds to NORM_{x,y,z} * ConvF whereby the uncertainty corresponds to that given for ConvF. A frequency dependent ConvF is used in DAS Y version 4.4 and higher which allows extending the validity from ± 50 MHz to ± 100 MHz.
- Spherical isotropy (3D deviation from isotropy)**: in a field of low gradients realized using a flat phantom exposed by a patch antenna.
- Sensor Offset**: The sensor offset corresponds to the offset of virtual measurement center from the probe tip (on probe axis). No tolerance required.



ET3DV6 SN:1787

May 18, 2010

Probe ET3DV6

SN:1787

Manufactured:	May 28, 2003
Last calibrated:	May 26, 2009
Recalibrated:	May 18, 2010

Calibrated for DAS Y/EASY Systems

(Note: non-compatible with DAS Y2 system!)



ET3DV6 SN:1787

May 18, 2010

DASY/EASY - Parameters of Probe: ET3DV6 SN:1787

Basic Calibration Parameters

	Sensor X	Sensor Y	Sensor Z	Unc (k=2)
Norm ($\mu\text{V}/(\text{V}/\text{m})^2$) ^A	1.60	1.79	2.10	$\pm 10.1\%$
DCP (mV) ^B	92.4	95.5	91.0	

Modulation Calibration Parameters

UID	Communication System Name	PAR		A dB	B dBuV	C	VR mV	Unc ^E (k=2)
10000	CW	0.00	X	0.00	0.00	1.00	300.0	$\pm 1.5\%$
			Y	0.00	0.00	1.00	300.0	
			Z	0.00	0.00	1.00	300.0	

The reported uncertainty of measurement is stated as the standard uncertainty of measurement multiplied by the coverage factor $k=2$, which for a normal distribution corresponds to a coverage probability of approximately 95%.

^A The uncertainties of NormX,Y,Z do not affect the E^2 -field uncertainty inside TSL (see Pages 5 and 6).

^B Numerical linearization parameter: uncertainty not required.

^E Uncertainty is determined using the maximum deviation from linear response applying rectangular distribution and is expressed for the square of the field value.



ET3DV6 SN:1787

May 18, 2010

DASY/EASY - Parameters of Probe: ET3DV6 SN:1787

Calibration Parameter Determined in Head Tissue Simulating Media

f [MHz]	Validity [MHz] [□]	Permittivity	Conductivity	ConvF X	ConvF Y	ConvF Z	Alpha	Depth Unc (k=2)
750	± 50 / ± 100	41.5 ± 5%	0.90 ± 5%	6.56	6.56	6.56	0.52	1.96 ± 11.0%
835	± 50 / ± 100	41.9 ± 5%	0.89 ± 5%	6.21	6.21	6.21	0.42	2.23 ± 11.0%
1750	± 50 / ± 100	40.1 ± 5%	1.37 ± 5%	5.36	5.36	5.36	0.49	1.18 ± 11.0%
1900	± 50 / ± 100	40.0 ± 5%	1.40 ± 5%	5.09	5.09	5.09	0.66	2.20 ± 11.0%
2450	± 50 / ± 100	39.2 ± 5%	1.80 ± 5%	4.50	4.50	4.50	0.99	1.63 ± 11.0%

[□] The validity of ± 100 MHz only applies for DASY v4.4 and higher (see Page 2). The uncertainty is the RSS of the ConvF uncertainty at calibration frequency and the uncertainty for the indicated frequency band.



ET3DV6 SN:1787

May 18, 2010

DASY/EASY - Parameters of Probe: ET3DV6 SN:1787

Calibration Parameter Determined in Body Tissue Simulating Media

f [MHz]	Validity [MHz] ^c	Permittivity	Conductivity	ConvF X	ConvF Y	ConvF Z	Alpha	Depth Unc (k=2)
750	± 50 / ± 100	55.5 ± 5%	0.96 ± 5%	6.22	6.22	6.22	0.48	2.20 ± 11.0%
835	± 50 / ± 100	55.2 ± 5%	0.97 ± 5%	6.12	6.12	6.12	0.39	2.45 ± 11.0%
1750	± 50 / ± 100	53.4 ± 5%	1.49 ± 5%	4.72	4.72	4.72	0.63	2.90 ± 11.0%
1900	± 50 / ± 100	53.3 ± 5%	1.52 ± 5%	4.47	4.47	4.47	0.88	2.39 ± 11.0%
2450	± 50 / ± 100	52.7 ± 5%	1.95 ± 5%	4.03	4.03	4.03	0.99	1.35 ± 11.0%

^c The validity of ± 100 MHz only applies for DASY v4.4 and higher (see Page 2). The uncertainty is the RSS of the ConvF uncertainty at calibration frequency and the uncertainty for the indicated frequency band.



ET3DV6 SN:1787

May 18, 2010

Frequency Response of E-Field

(TEM-Cell:ifi110 EXX, Waveguide: R22)

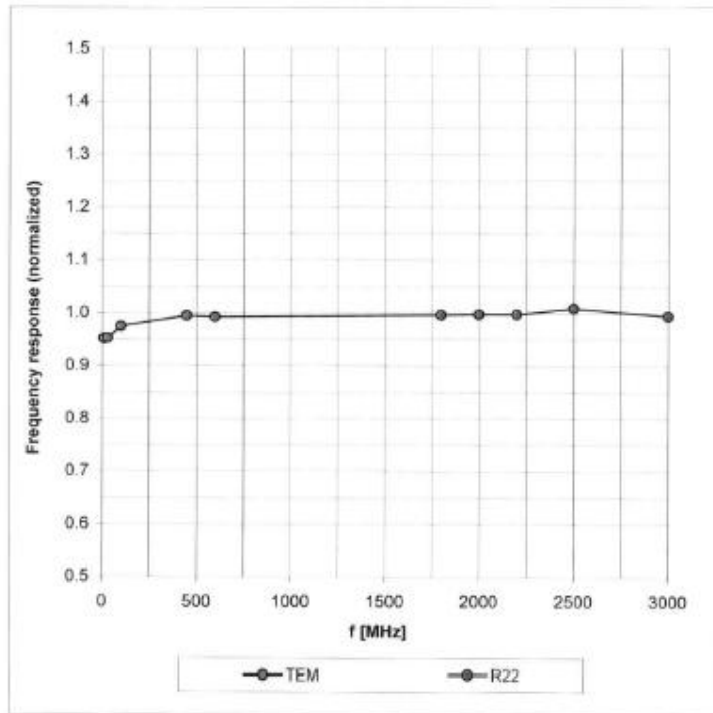

Uncertainty of Frequency Response of E-field: $\pm 6.3\%$ (k=2)



ET3DV6 SN:1787

May 18, 2010

Receiving Pattern (ϕ), $\vartheta = 0^\circ$

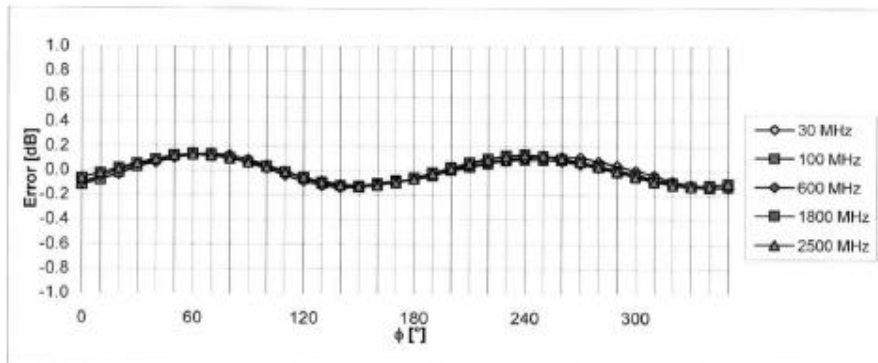
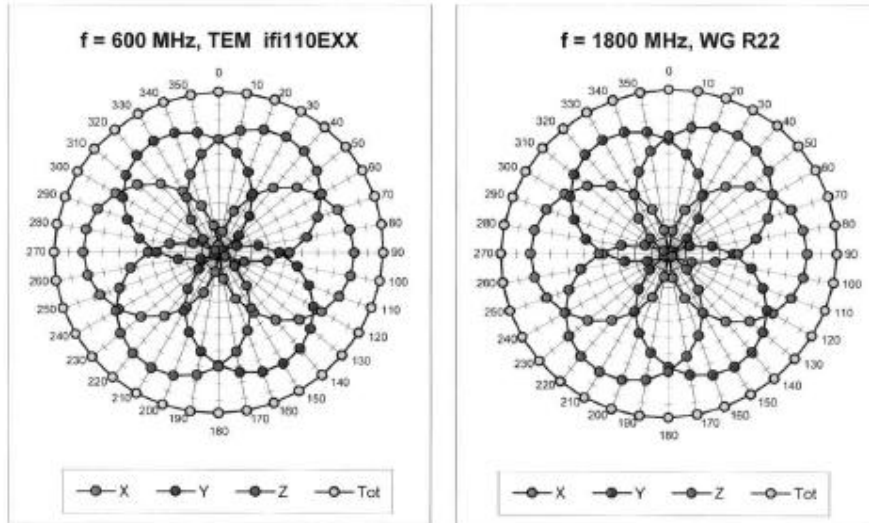

Uncertainty of Axial Isotropy Assessment: $\pm 0.5\%$ ($k=2$)

ET3DV6 SN:1787

May 18, 2010

Dynamic Range f(SAR_{head})
 (Waveguide R22, f = 1800 MHz)

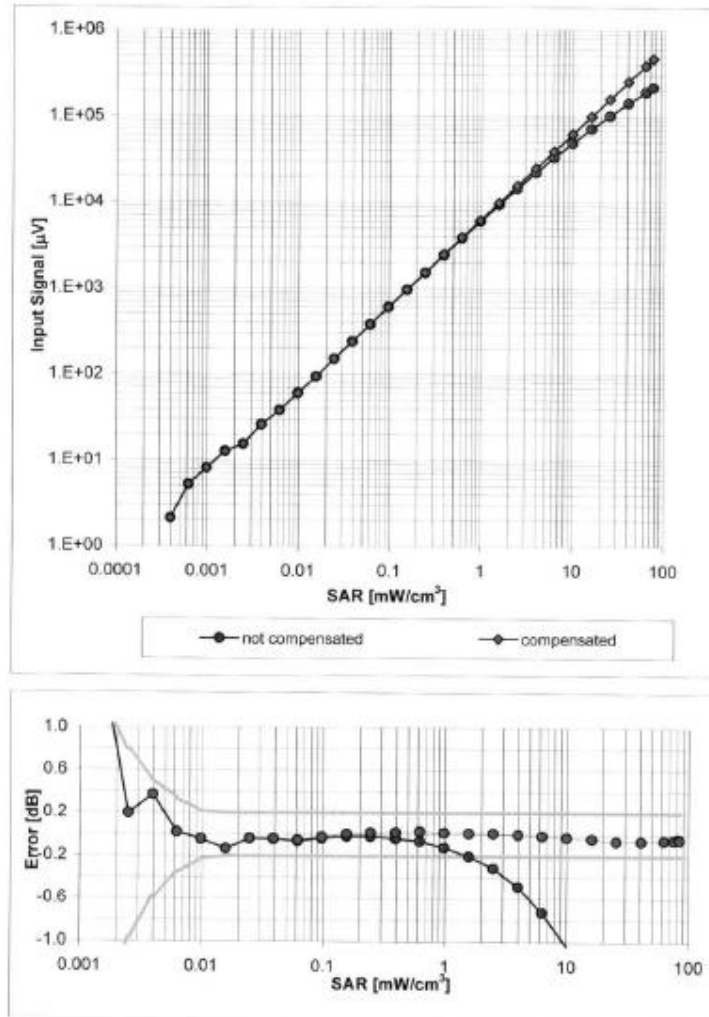

Uncertainty of Linearity Assessment: ± 0.6% (k=2)

ET3DV6 SN:1787

May 18, 2010

Conversion Factor Assessment

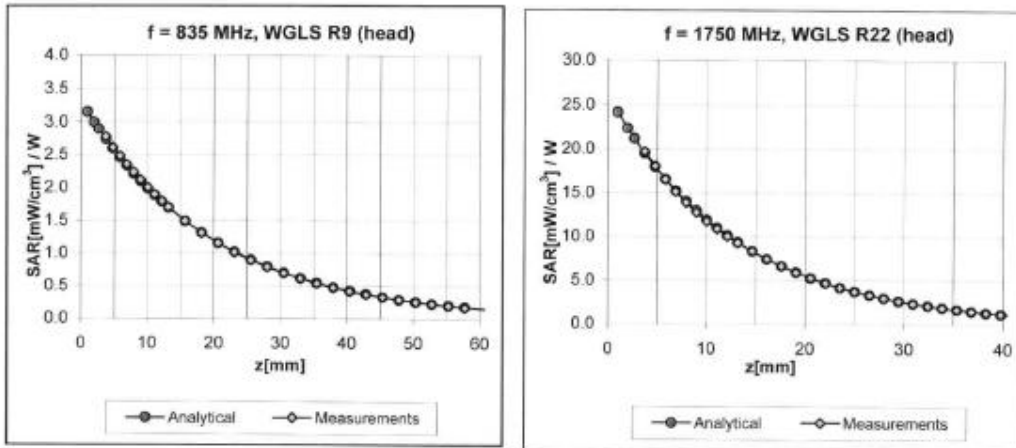

Deviation from Isotropy in HSL

Error (ϕ , θ), f = 900 MHz

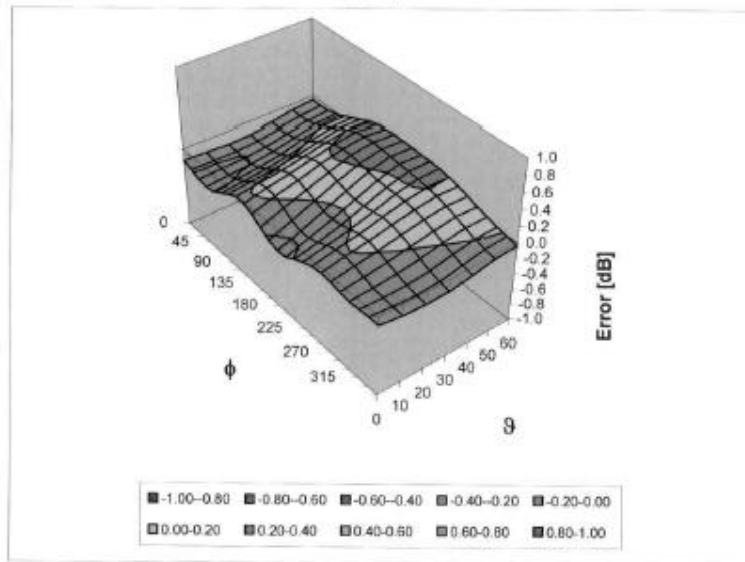

Uncertainty of Spherical Isotropy Assessment: $\pm 2.6\%$ (k=2)



ET3DV6 SN:1787

May 18, 2010

Other Probe Parameters

Sensor Arrangement	Triangular
Connector Angle (°)	Not applicable
Mechanical Surface Detection Mode	enabled
Optical Surface Detection Mode	disabled
Probe Overall Length	337 mm
Probe Body Diameter	10 mm
Tip Length	10 mm
Tip Diameter	6.8 mm
Probe Tip to Sensor X Calibration Point	2.7 mm
Probe Tip to Sensor Y Calibration Point	2.7 mm
Probe Tip to Sensor Z Calibration Point	2.7 mm
Recommended Measurement Distance from Surface	4 mm



Calibration Laboratory of Schmid & Partner Engineering AG, Zeughausstrasse 43, 8004 Zurich, Switzerland



S Schweizerischer Kalibrierdienst, C Service suisse d'etalonnage, S Servizio svizzero di taratura, S Swiss Calibration Service

Accredited by the Swiss Accreditation Service (SAS)
The Swiss Accreditation Service is one of the signatories to the EA Multilateral Agreement for the recognition of calibration certificates

Accreditation No.: SCS 108

Client Sporton (Auden)

Certificate No: ET3-1788_Sep10

CALIBRATION CERTIFICATE

Object: ET3DV6 - SN:1788
Calibration procedure(s): QA CAL-01.v6, QA CAL-23.v3 and QA CAL-25.v2
Calibration procedure for dosimetric E-field probes
Calibration date: September 21, 2010

This calibration certificate documents the traceability to national standards, which realize the physical units of measurements (SI). The measurements and the uncertainties with confidence probability are given on the following pages and are part of the certificate.

All calibrations have been conducted in the closed laboratory facility: environment temperature (22 ± 3)°C and humidity < 70%.

Calibration Equipment used (M&TE critical for calibration)

Table with 4 columns: Primary Standards, ID #, Cal Date (Certificate No.), Scheduled Calibration. Lists equipment like Power meter E4419B, Reference 3 dB Attenuator, etc.

Table with 4 columns: Secondary Standards, ID #, Check Date (in house), Scheduled Check. Lists RF generator HP 8648C, Network Analyzer HP 8753E.

Calibrated by: Jeton Kastrati, Laboratory Technician
Approved by: Katja Pokovic, Technical Manager

Issued: September 22, 2010

This calibration certificate shall not be reproduced except in full without written approval of the laboratory.

**Calibration Laboratory of
Schmid & Partner
Engineering AG**
Zeughausstrasse 43, 8004 Zurich, Switzerland



S Schweizerischer Kalibrierdienst
C Service suisse d'étalonnage
S Servizio svizzero di taratura
S Swiss Calibration Service

Accredited by the Swiss Accreditation Service (SAS)

The Swiss Accreditation Service is one of the signatories to the EA
Multilateral Agreement for the recognition of calibration certificates

Accreditation No.: **SCS 108**

Glossary:

TSL	tissue simulating liquid
NORM _{x,y,z}	sensitivity in free space
ConvF	sensitivity in TSL / NORM _{x,y,z}
DCP	diode compression point
CF	crest factor (1/duty_cycle) of the RF signal
A, B, C	modulation dependent linearization parameters
Polarization φ	φ rotation around probe axis
Polarization ϑ	ϑ rotation around an axis that is in the plane normal to probe axis (at measurement center), i.e., $\vartheta = 0$ is normal to probe axis

Calibration is Performed According to the Following Standards:

- a) IEEE Std 1528-2003, "IEEE Recommended Practice for Determining the Peak Spatial-Averaged Specific Absorption Rate (SAR) in the Human Head from Wireless Communications Devices: Measurement Techniques", December 2003
- b) IEC 62209-1, "Procedure to measure the Specific Absorption Rate (SAR) for hand-held devices used in close proximity to the ear (frequency range of 300 MHz to 3 GHz)", February 2005

Methods Applied and Interpretation of Parameters:

- **NORM_{x,y,z}:** Assessed for E-field polarization $\vartheta = 0$ ($f \leq 900$ MHz in TEM-cell; $f > 1800$ MHz: R22 waveguide). NORM_{x,y,z} are only intermediate values, i.e., the uncertainties of NORM_{x,y,z} does not effect the E²-field uncertainty inside TSL (see below ConvF).
- **NORM(f)_{x,y,z} = NORM_{x,y,z} * frequency_response** (see Frequency Response Chart). This linearization is implemented in DAS Y4 software versions later than 4.2. The uncertainty of the frequency response is included in the stated uncertainty of ConvF.
- **DCP_{x,y,z}:** DCP are numerical linearization parameters assessed based on the data of power sweep with CW signal (no uncertainty required). DCP does not depend on frequency nor media.
- **A_{x,y,z}; B_{x,y,z}; C_{x,y,z}; VR_{x,y,z}:** A, B, C are numerical linearization parameters assessed based on the data of power sweep for specific modulation signal. The parameters do not depend on frequency nor media. VR is the maximum calibration range expressed in RMS voltage across the diode.
- **ConvF and Boundary Effect Parameters:** Assessed in flat phantom using E-field (or Temperature Transfer Standard for $f \leq 800$ MHz) and inside waveguide using analytical field distributions based on power measurements for $f > 800$ MHz. The same setups are used for assessment of the parameters applied for boundary compensation (alpha, depth) of which typical uncertainty values are given. These parameters are used in DAS Y4 software to improve probe accuracy close to the boundary. The sensitivity in TSL corresponds to NORM_{x,y,z} * ConvF whereby the uncertainty corresponds to that given for ConvF. A frequency dependent ConvF is used in DAS Y version 4.4 and higher which allows extending the validity from ± 50 MHz to ± 100 MHz.
- **Spherical isotropy (3D deviation from isotropy):** in a field of low gradients realized using a flat phantom exposed by a patch antenna.
- **Sensor Offset:** The sensor offset corresponds to the offset of virtual measurement center from the probe tip (on probe axis). No tolerance required.



ET3DV6 SN:1788

September 21, 2010

Probe ET3DV6

SN:1788

Manufactured:	May 28, 2003
Last calibrated:	September 23, 2009
Recalibrated:	September 21, 2010

Calibrated for DASYS/EASY Systems

(Note: non-compatible with DASYS2 system!)



ET3DV6 SN:1788

September 21, 2010

DASY/EASY - Parameters of Probe: ET3DV6 SN:1788

Basic Calibration Parameters

	Sensor X	Sensor Y	Sensor Z	Unc (k=2)
Norm ($\mu\text{V}/(\text{V}/\text{m})^2$) ^A	1.76	1.69	1.76	$\pm 10.1\%$
DCP (mV) ^B	91.6	91.0	95.1	

Modulation Calibration Parameters

UID	Communication System Name	PAR		A dB	B dBuV	C	VR mV	Unc ^E (k=2)
10000	CW	0.00	X	0.00	0.00	1.00	300.0	$\pm 1.5\%$
			Y	0.00	0.00	1.00	300.0	
			Z	0.00	0.00	1.00	300.0	

The reported uncertainty of measurement is stated as the standard uncertainty of measurement multiplied by the coverage factor k=2, which for a normal distribution corresponds to a coverage probability of approximately 95%.

^A The uncertainties of NormX,Y,Z do not affect the E²-field uncertainty inside TSL, (see Pages 5 and 6).

^B Numerical linearization parameter: uncertainty not required.

^E Uncertainty is determined using the maximum deviation from linear response applying rectangular distribution and is expressed for the square of the field value.



ET3DV6 SN:1788

September 21, 2010

DASY/EASY - Parameters of Probe: ET3DV6 SN:1788

Calibration Parameter Determined in Head Tissue Simulating Media

f [MHz]	Validity [MHz] ^c	Permittivity	Conductivity	ConvF X	ConvF Y	ConvF Z	Alpha	Depth Unc (k=2)
835	± 50 / ± 100	41.5 ± 5%	0.90 ± 5%	6.23	6.23	6.23	0.41	2.32 ± 11.0%
900	± 50 / ± 100	41.5 ± 5%	0.97 ± 5%	6.11	6.11	6.11	0.29	2.85 ± 11.0%
1750	± 50 / ± 100	40.1 ± 5%	1.37 ± 5%	5.29	5.29	5.29	0.51	2.51 ± 11.0%
1900	± 50 / ± 100	40.0 ± 5%	1.40 ± 5%	5.03	5.03	5.03	0.66	2.25 ± 11.0%
2450	± 50 / ± 100	39.2 ± 5%	1.80 ± 5%	4.35	4.35	4.35	0.99	1.69 ± 11.0%

^c The validity of ± 100 MHz only applies for DASY v4.4 and higher (see Page 2). The uncertainty is the RSS of the ConvF uncertainty at calibration frequency and the uncertainty for the indicated frequency band.



ET3DV6 SN:1788

September 21, 2010

DASY/EASY - Parameters of Probe: ET3DV6 SN:1788

Calibration Parameter Determined in Body Tissue Simulating Media

f [MHz]	Validity [MHz] ^c	Permittivity	Conductivity	ConvF X	ConvF Y	ConvF Z	Alpha	Depth Unc (k=2)
835	± 50 / ± 100	55.2 ± 5%	0.97 ± 5%	5.99	5.99	5.99	0.35	2.62 ± 11.0%
900	± 50 / ± 100	55.0 ± 5%	1.05 ± 5%	6.07	6.07	6.07	0.32	2.87 ± 11.0%
1750	± 50 / ± 100	53.4 ± 5%	1.49 ± 5%	4.67	4.67	4.67	0.61	3.09 ± 11.0%
1900	± 50 / ± 100	53.3 ± 5%	1.52 ± 5%	4.39	4.39	4.39	0.83	2.56 ± 11.0%
2450	± 50 / ± 100	52.7 ± 5%	1.95 ± 5%	4.04	4.04	4.04	0.99	1.40 ± 11.0%

^c The validity of ± 100 MHz only applies for DASY v4.4 and higher (see Page 2). The uncertainty is the RSS of the ConvF uncertainty at calibration frequency and the uncertainty for the indicated frequency band.



ET3DV6 SN:1788

September 21, 2010

Frequency Response of E-Field

(TEM-Cell:ifi110 EXX, Waveguide: R22)

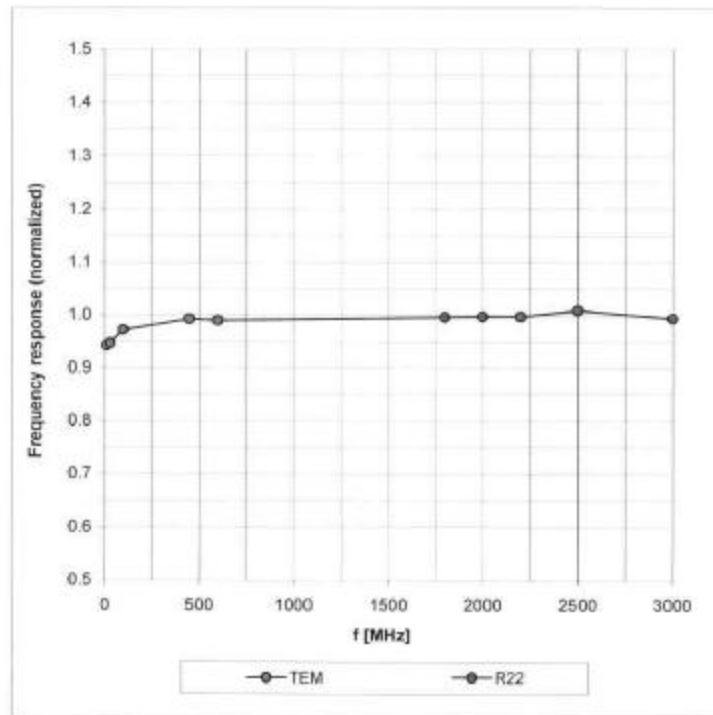

Uncertainty of Frequency Response of E-field: $\pm 6.3\%$ (k=2)



ET3DV6 SN:1788

September 21, 2010

Receiving Pattern (ϕ), $\theta = 0^\circ$

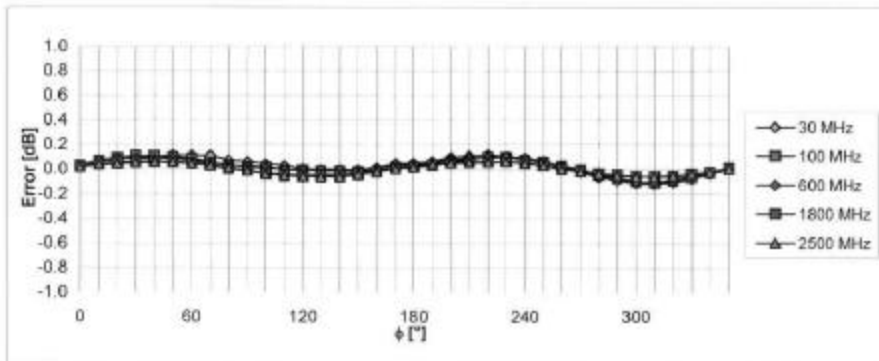
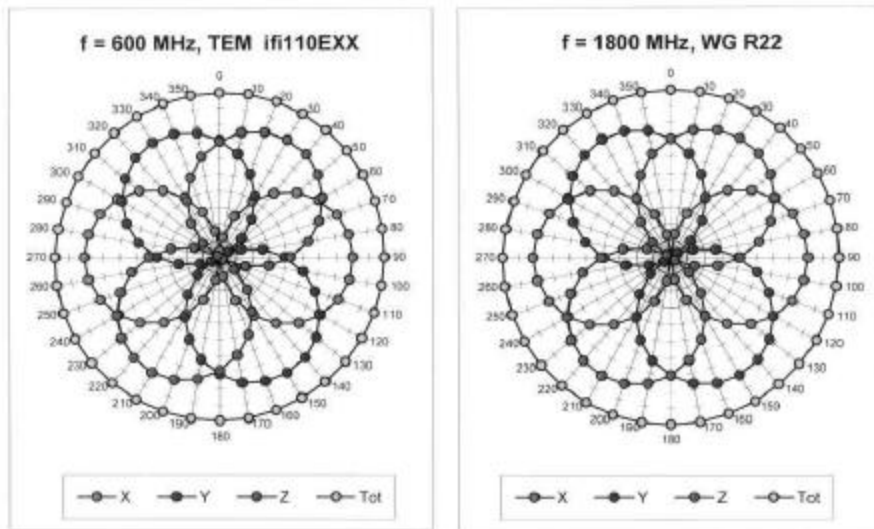

Uncertainty of Axial Isotropy Assessment: $\pm 0.5\%$ (k=2)



ET3DV6 SN:1788

September 21, 2010

Dynamic Range f(SAR_{head}) (Waveguide R22, f = 1800 MHz)

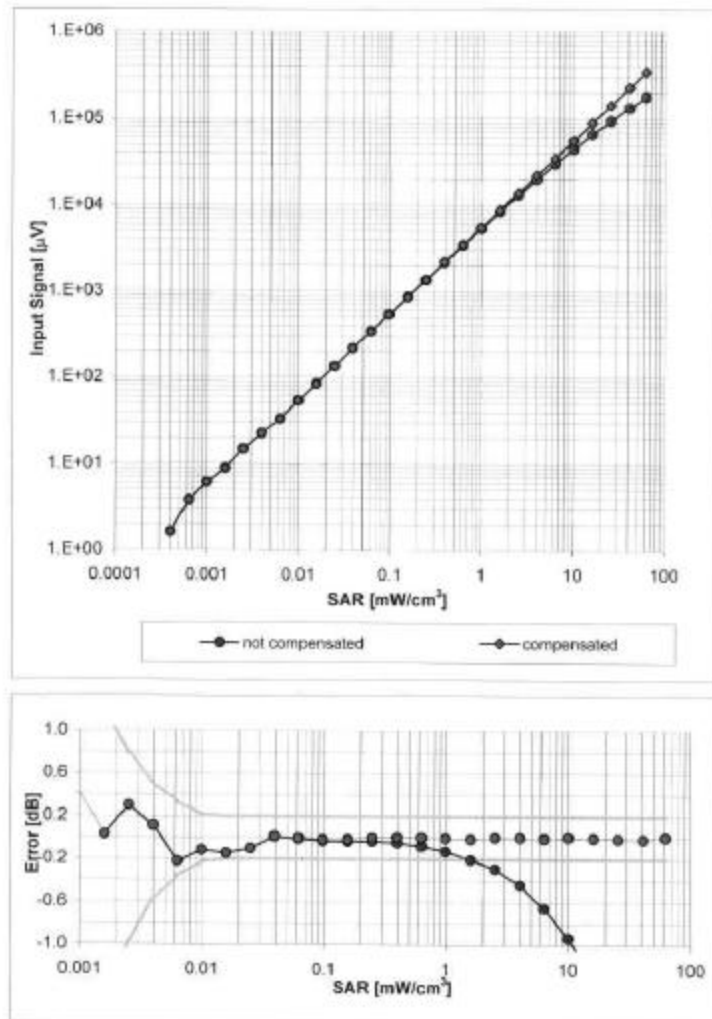

Uncertainty of Linearity Assessment: ± 0.6% (k=2)

ET3DV6 SN:1788

September 21, 2010

Conversion Factor Assessment

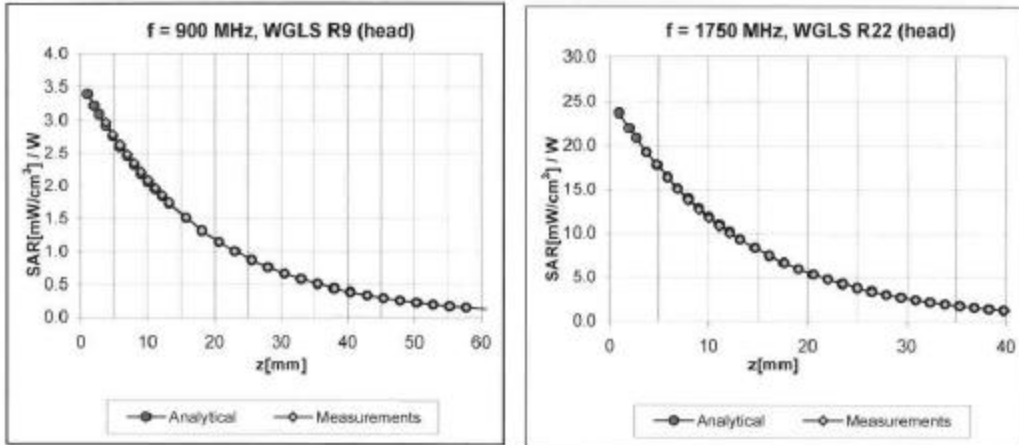

Deviation from Isotropy in HSL

Error (ϕ, θ), f = 900 MHz

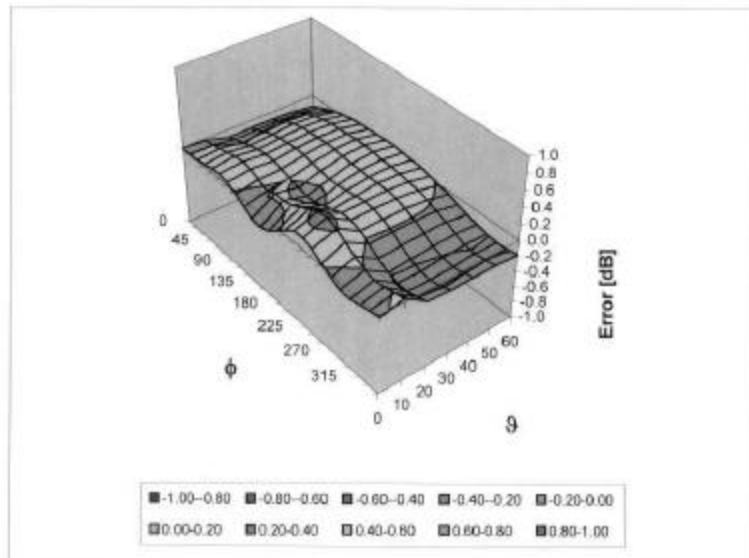

Uncertainty of Spherical Isotropy Assessment: $\pm 2.6\%$ (k=2)



ET3DV6 SN:1788

September 21, 2010

Other Probe Parameters

Sensor Arrangement	Triangular
Connector Angle (°)	Not applicable
Mechanical Surface Detection Mode	enabled
Optical Surface Detection Mode	disabled
Probe Overall Length	337 mm
Probe Body Diameter	10 mm
Tip Length	10 mm
Tip Diameter	6.8 mm
Probe Tip to Sensor X Calibration Point	2.7 mm
Probe Tip to Sensor Y Calibration Point	2.7 mm
Probe Tip to Sensor Z Calibration Point	2.7 mm
Recommended Measurement Distance from Surface	4 mm



Appendix F. FCC 3G SAR Measurement Procedures

Conducted Output Power:

The EUT was tested according to the requirements of the FCC 3G procedures and the 3.1.2.3.4.

A detailed analysis of the output power verification is provided as the table below:

Function Type	Reverse Traffic Channel	Test Mode	Radio Configuration		Service Option	Data Rates (kbps)	Power Control	Low Ch	Mid. Ch	High Ch
			Forward Traffic Channel (Fwd)	Reverse Traffic Channel (Rvs)				25	600	1175
CDMA2000 PCS	FCH	1	1	1	55	Full	All Up	24.16	24.52	24.70
		3	3	3	55	Full	All Up	24.64	24.57	24.65
		3	3	3	32	Full	All Up	24.62	24.53	24.69
	FCH+SCH	3	3	3	32	FCH:Full,SCH 9.6	All Up	24.46	24.50	24.67
	EVDO Rev.0	Subtype:0				RTAP 153.6	All Up	24.69	24.70	24.68
	EVDO Rev.A	Subtype:0				RETAP 4096	All Up	24.49	24.77	24.80

CDMA2000 Setup Configuration:

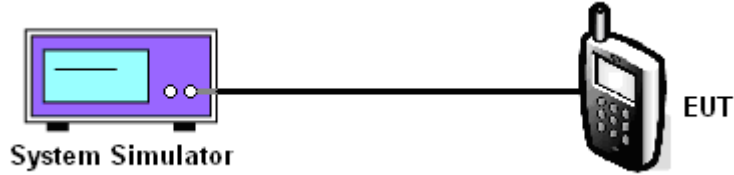

Setup Configuration

1. The EUT was connected to System Simulator, Agilent 8960. Refer to the drawing of Setup Configuration.
2. The RF path losses were compensated into the measurements.
3. A call was established between EUT and System Simulator with following setting:
 - a. For 1xRTT, set the Radio Configuration and the Service Option
 - b. For 1xEV-DO, set the Protocol Release and Data Rate
 - c. Set the Power Control to All Up Bits
4. The transmitted maximum output power was recorded.

Call Setup Screen						
Call Control	Active Cell Operating Mode				Call Parm	
Close Menu	Mobile Station Information				Cell Power	-86.00
	ESN (Hex):				dBm/1.23 MHz	
	ESN (Dec):				Cell Band	US PCS
	NCC:				Channel	1175
	MNC:				Protocol Rev	6 (IS-2000-0)
	MSIN:				Radio Config	(Fud1, Rus1)
	Slot Class:				FCH Service Option Setup	S055 (Loopback)
	Slot Cycle Index: ----				Service Option	S09 (Loopback)
	Protocol Revision:				Service Option f	S01 (Voice)
					Service Option f	S02 (Loopback)
				Service Option f	S03 (Voice)	
				Service Option f	S06 (SMS)	
				Service Option f	S055 (Loopback)	
				Service Option f	S068 (Voice)	
Active Cell				Sys Type: IS-2000		
Idle						
IntRef				Offset		
				1 of 4		

1xRTT setting for Radio Configuration 1 with Service Option 55



Call Setup Screen														
Call Control	Active Cell Operating Mode	Call Parm												
Operating Mode	<div style="border: 1px solid black; padding: 5px;"> <p style="text-align: center; margin: 0;">Access Terminal Information (AT Reported)</p> <p>Session Seed: Hardware ID Type (Hex): Hardware ID (Hex): Hardware ID (Decimal):</p> <hr/> <p style="text-align: center; margin: 0;">Access Terminal Information (AN Assigned)</p> <p>UATI 024: ---- UATI Color Code: ---- NAC Index: ----</p> <hr/> <p style="text-align: center; margin: 0;">Protocol Release</p> <table border="1" style="width: 100%; border-collapse: collapse;"> <tr> <td style="width: 50%;">Session App: 0 (1xEV-DO)</td> <td style="width: 50%;">Application</td> </tr> <tr> <td>Test Applica: A (1xEV-DO-A)</td> <td></td> </tr> <tr> <td>Limited TAP: B (1xEV-DO-B)</td> <td></td> </tr> <tr> <td>AT Directed</td> <td></td> </tr> <tr> <td>DRC Value Fi</td> <td></td> </tr> <tr> <td>ACK Channel</td> <td></td> </tr> </table> </div>	Session App: 0 (1xEV-DO)	Application	Test Applica: A (1xEV-DO-A)		Limited TAP: B (1xEV-DO-B)		AT Directed		DRC Value Fi		ACK Channel		Rvs Power Ctrl
Session App: 0 (1xEV-DO)		Application												
Test Applica: A (1xEV-DO-A)														
Limited TAP: B (1xEV-DO-B)														
AT Directed														
DRC Value Fi														
ACK Channel														
Active Cell		Active bits												
Start Data Connection		Pur Ctrl Step												
Close Session		1.0 dB												
Handoff Setup	Call Drop Timer													
AT Max Power	On													
23 dBm/1.23MHz	Call Limit Mode													
	Off													
	Protocol Rel													
	0 (1xEV-DO)													
1 of 3	Active Cell													
	Idle													
	IntRef	Offset												
	PLSub0	RTAP												
		2 of 3												

1xEV-DO setting for Protocol Release (Rev.0 or Rev.A)

Call Setup Screen														
Call Control	Active Cell Operating Mode	Call Parm												
Operating Mode	<div style="border: 1px solid black; padding: 5px;"> <p style="text-align: center; margin: 0;">Access Terminal Information (AT Reported)</p> <p>Session Seed: Hardware ID Type (Hex): Hardware ID (Hex): Hardware ID (Decimal):</p> <hr/> <p style="text-align: center; margin: 0;">Access Terminal Information (AN Assigned)</p> <p>UATI 024: ---- UATI Color Code: ---- NAC Index: ----</p> <hr/> <p style="text-align: center; margin: 0;">RTAP Rate</p> <table border="1" style="width: 100%; border-collapse: collapse;"> <tr> <td style="width: 50%;">Session App: 9.6 kbps</td> <td style="width: 50%;">Application</td> </tr> <tr> <td>Test Applica: 19.2 kbps</td> <td></td> </tr> <tr> <td>Limited TAP: 38.4 kbps</td> <td></td> </tr> <tr> <td>AT Directed: 76.8 kbps</td> <td></td> </tr> <tr> <td>DRC Value Fi: 153.6 kbps</td> <td></td> </tr> <tr> <td>ACK Channel</td> <td></td> </tr> </table> </div>	Session App: 9.6 kbps	Application	Test Applica: 19.2 kbps		Limited TAP: 38.4 kbps		AT Directed: 76.8 kbps		DRC Value Fi: 153.6 kbps		ACK Channel		Cell Power
Session App: 9.6 kbps		Application												
Test Applica: 19.2 kbps														
Limited TAP: 38.4 kbps														
AT Directed: 76.8 kbps														
DRC Value Fi: 153.6 kbps														
ACK Channel														
Active Cell		-86.00												
Start Data Connection		dBm/1.23 MHz												
Close Session		Cell Band												
Handoff Setup	US PCS													
AT Max Power	Channel													
23 dBm/1.23MHz	1175													
	Application Config													
	FTAP Rate													
	307.2 kbps													
	(2 Slot, QPSK)													
	RTAP Rate													
	9.6 kbps													
1 of 3	Active Cell													
	Idle													
	IntRef	Offset												
	PLSub0	RTAP												
		1 of 3												

1xEV-DO setting for RTAP data rate (153.6 kbps)



Call Setup Screen																				
Call Control	Active Cell Operating Mode				Call Parms															
Operating Mode	Access Terminal Information (AT Reported)				Cell Power															
Active Cell	Session Seed: Hardware ID Type (Hex): Hardware ID (Hex): Hardware ID (Decimal):				-86.00															
	Access Terminal Information (AM Assigned)				dBm/1.23 MHz															
Start Data Connection	UATI 024: ---- UATI Color Code: ---- MAC Index: ----				Cell Band															
	Application Configuration				US PCS															
Close Session	<table border="1"> <thead> <tr> <th>R-Data Packet Size</th> <th>Application</th> </tr> </thead> <tbody> <tr> <td>128</td> <td>AP</td> </tr> <tr> <td>256</td> <td>Z</td> </tr> <tr> <td>512</td> <td></td> </tr> <tr> <td>768</td> <td></td> </tr> <tr> <td>1024</td> <td>Capacity</td> </tr> <tr> <td>1536</td> <td>kbps</td> </tr> </tbody> </table>				R-Data Packet Size	Application	128	AP	256	Z	512		768		1024	Capacity	1536	kbps	Channel	
R-Data Packet Size	Application																			
128	AP																			
256	Z																			
512																				
768																				
1024	Capacity																			
1536	kbps																			
Handoff Setup					1175															
AT Max Power					Application Config															
23 dBm/1.23MHz					F-Traffic Format															
	Active Cell				4 (1024,2,128)															
	Idle				(307.2k, QPSK)															
	Sys Type: IS-856				R-Data Pkt Size															
	IntRef Offset				128															
1 of 3	PLSub0 RETAP				bits															
					1 of 3															

1xEV-DO setting for RETAP data rate (4096 kbps)



Reference:

- [1] SAR Measurement Procedures for 3G Devices CDMA 2000/Ev-Do/WCDMA/HSDPA, June 2006
Laboratory Division Office of Engineering and Technology Federal Communications Commission
- [2] 3.1.2.3.4 Maximum RF Output Power 3GPP2 C.S0033-0 Version 2.0, Date: 12 December 2003
Recommended Minimum Performance Standards for cdma2000 High Rate Packet Data Access
Terminal