

APPENDIX A: SAR TEST DATA

PCTEST ENGINEERING LABORATORY, INC.

**DUT: IHDT56MP1; Type: Cellular/PCS CDMA/EVDO Phone
with Bluetooth and WLAN; Serial: Unit X**

Communication System: Cellular CDMA; Frequency: 820.1 MHz; Duty Cycle: 1:1
Medium: 835 Head Medium parameters used (interpolated):
 $f = 820.1 \text{ MHz}$; $\sigma = 0.881 \text{ mho/m}$; $\epsilon_r = 42.5$; $\rho = 1000 \text{ kg/m}^3$
Phantom section: Right Section

Test Date: 06-21-2011; Ambient Temp: 23.2 °C; Tissue Temp: 22.1 °C

Probe: EX3DV4 - SN3561; ConvF(7.96, 7.96, 7.96); Calibrated: 8/19/2010
Sensor-Surface: 4mm (Mechanical Surface Detection)
Electronics: DAE4 Sn649; Calibrated: 2/21/2011
Phantom: SAM Sub; Type: SAM 4.0; Serial: TP-1403
Measurement SW: DASY4, V4.7 Build 80; Postprocessing SW: SEMCAD, V1.8 Build 186

**Mode: Cellular CDMA - FCC Rule Part 90S, Right Head,
Touch, Mid.ch, Standard Battery**

Area Scan (7x14x1): Measurement grid: $dx=15\text{mm}$, $dy=15\text{mm}$
Zoom Scan (5x5x7)/Cube 0: Measurement grid: $dx=8\text{mm}$, $dy=8\text{mm}$, $dz=5\text{mm}$
Reference Value = 33.5 V/m
Peak SAR (extrapolated) = 1.18 W/kg
SAR(1 g) = 0.927 mW/g; SAR(10 g) = 0.703 mW/g

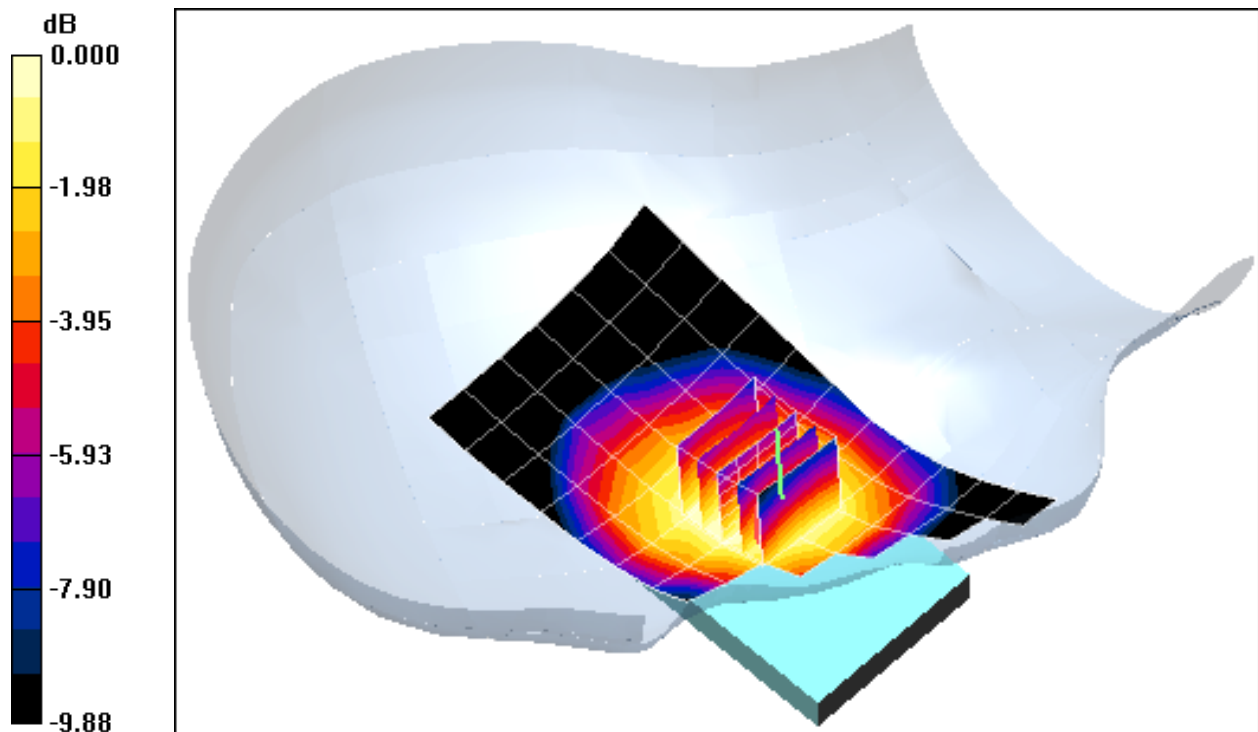

0 dB = 0.965mW/g

PCTEST ENGINEERING LABORATORY, INC.

**DUT: IHDT56MP1; Type: Cellular/PCS CDMA/EvDO Phone
with Bluetooth and WLAN ; Serial: Unit X**

Communication System: Cellular CDMA; Frequency: 820.1 MHz; Duty Cycle: 1:1
Medium: 835 Head Medium parameters used (interpolated):
 $f = 820.1 \text{ MHz}$; $\sigma = 0.88 \text{ mho/m}$; $\epsilon_r = 42.86$; $\rho = 1000 \text{ kg/m}^3$
Phantom section: Right Section

Test Date: 08-22-2011; Ambient Temp: 23.3°C; Tissue Temp: 22.0°C

Probe: ES3DV3 - SN3258; ConvF(6.18, 6.18, 6.18); Calibrated: 4/8/2011
Sensor-Surface: 4mm (Mechanical Surface Detection)
Electronics: DAE4 Sn649; Calibrated: 2/21/2011
Phantom: SAM Sub; Type: SAM 4.0; Serial: TP-1403
Measurement SW: DASY4, V4.7 Build 80; Postprocessing SW: SEMCAD, V1.8 Build 186

**Mode: Cellular EVDO Rev. A - FCC Rule Part 90S, Right Head,
Touch, Mid.ch, Standard Battery**

Area Scan (7x14x1): Measurement grid: dx=15mm, dy=15mm

Zoom Scan (5x5x7)/Cube 0: Measurement grid: dx=8mm, dy=8mm, dz=5mm

Reference Value = 34.5 V/m

Peak SAR (extrapolated) = 1.12 W/kg

SAR(1 g) = 0.838 mW/g; SAR(10 g) = 0.637 mW/g

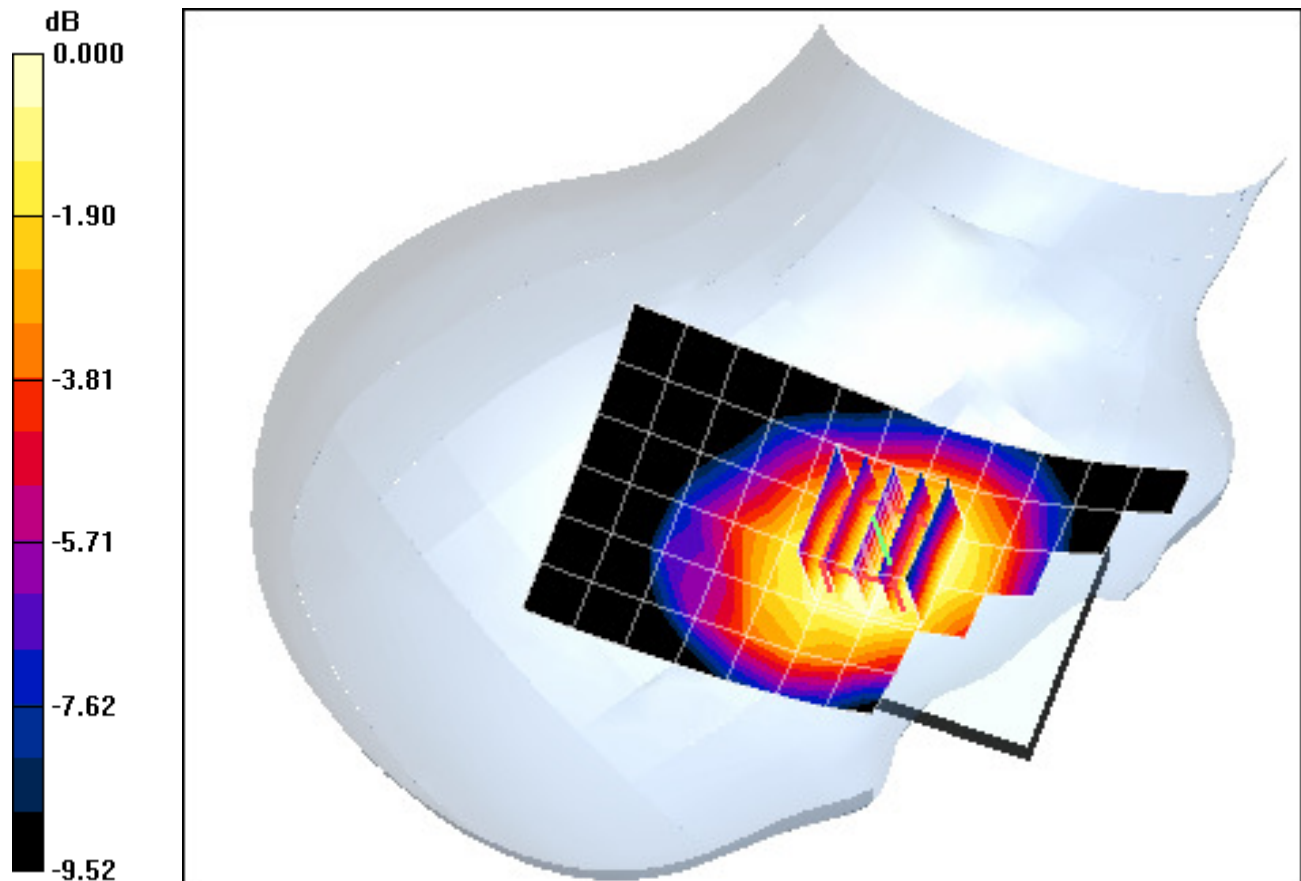

0 dB = 0.874mW/g

PCTEST ENGINEERING LABORATORY, INC.

**DUT: IHDT56MP1; Type: Cellular/PCS CDMA/EVDO Phone
with Bluetooth and WLAN; Serial: Unit X**

Communication System: Cellular CDMA; Frequency: 820.1 MHz; Duty Cycle: 1:1
Medium: 835 Head Medium parameters used (interpolated):
 $f = 820.1 \text{ MHz}$; $\sigma = 0.881 \text{ mho/m}$; $\epsilon_r = 42.5$; $\rho = 1000 \text{ kg/m}^3$
Phantom section: Right Section

Test Date: 06-21-2011; Ambient Temp: 23.2 °C; Tissue Temp: 22.1 °C

Probe: EX3DV4 - SN3561; ConvF(7.96, 7.96, 7.96); Calibrated: 8/19/2010
Sensor-Surface: 4mm (Mechanical Surface Detection)
Electronics: DAE4 Sn649; Calibrated: 2/21/2011
Phantom: SAM Sub; Type: SAM 4.0; Serial: TP-1403
Measurement SW: DASY4, V4.7 Build 80; Postprocessing SW: SEMCAD, V1.8 Build 186

**Mode: Cellular CDMA - FCC Rule Part 90S, Right Head
Tilt, Mid.ch, Standard Battery**

Area Scan (7x14x1): Measurement grid: dx=15mm, dy=15mm
Zoom Scan (5x5x7)/Cube 0: Measurement grid: dx=8mm, dy=8mm, dz=5mm
Reference Value = 28.3 V/m
Peak SAR (extrapolated) = 0.822 W/kg
SAR(1 g) = 0.642 mW/g; SAR(10 g) = 0.489 mW/g

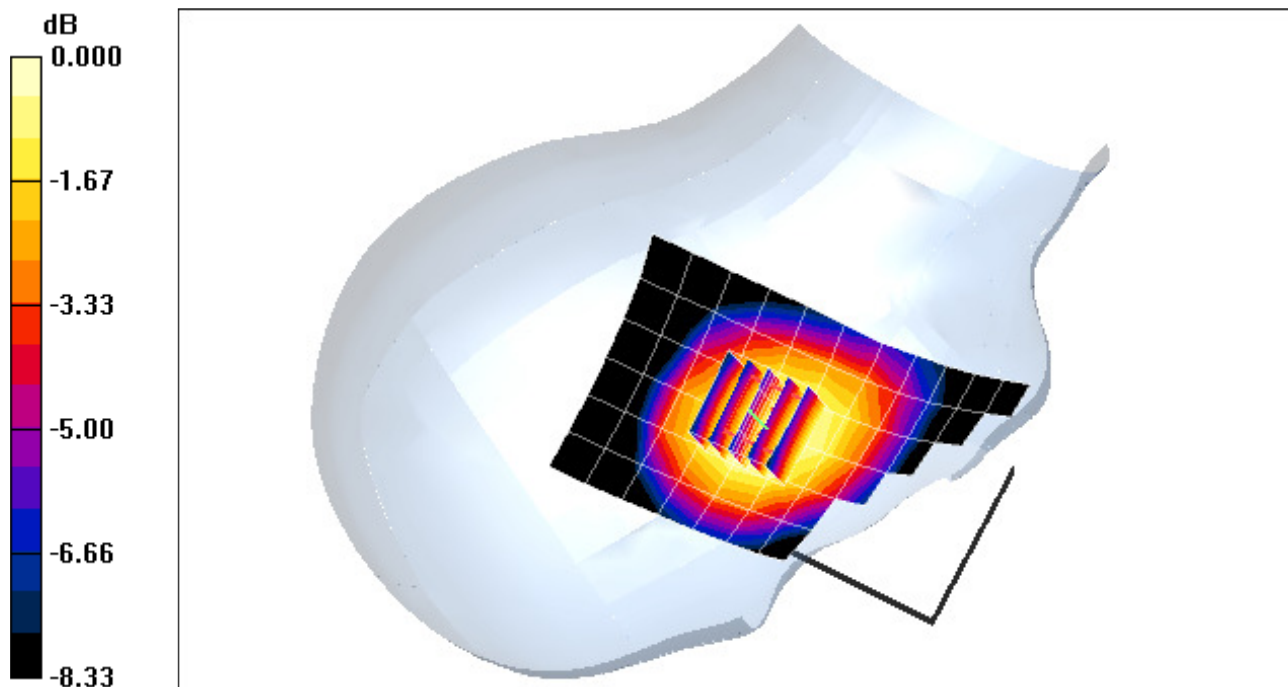

0 dB = 0.675mW/g

PCTEST ENGINEERING LABORATORY, INC.

**DUT: IHDT56MP1; Type: Cellular/PCS CDMA/EVDO Phone
with Bluetooth and WLAN; Serial: Unit X**

Communication System: Cellular CDMA; Frequency: 820.1 MHz; Duty Cycle: 1:1
Medium: 835 Head Medium parameters used (interpolated):
 $f = 820.1 \text{ MHz}$; $\sigma = 0.881 \text{ mho/m}$; $\epsilon_r = 42.5$; $\rho = 1000 \text{ kg/m}^3$
Phantom section: Left Section

Test Date: 06-21-2011; Ambient Temp: 23.2 °C; Tissue Temp: 22.1 °C

Probe: EX3DV4 - SN3561; ConvF(7.96, 7.96, 7.96); Calibrated: 8/19/2010
Sensor-Surface: 4mm (Mechanical Surface Detection)
Electronics: DAE4 Sn649; Calibrated: 2/21/2011
Phantom: SAM Sub; Type: SAM 4.0; Serial: TP-1403
Measurement SW: DASY4, V4.7 Build 80; Postprocessing SW: SEMCAD, V1.8 Build 186

**Mode: Cellular CDMA - FCC Rule Part 90S, Left Head,
Touch, Mid.ch, Standard Battery**

Area Scan (7x14x1): Measurement grid: $dx=15\text{mm}$, $dy=15\text{mm}$
Zoom Scan (5x5x7)/Cube 0: Measurement grid: $dx=8\text{mm}$, $dy=8\text{mm}$, $dz=5\text{mm}$
Reference Value = 10.4 V/m
Peak SAR (extrapolated) = 1.10 W/kg
SAR(1 g) = 0.888 mW/g; SAR(10 g) = 0.678 mW/g

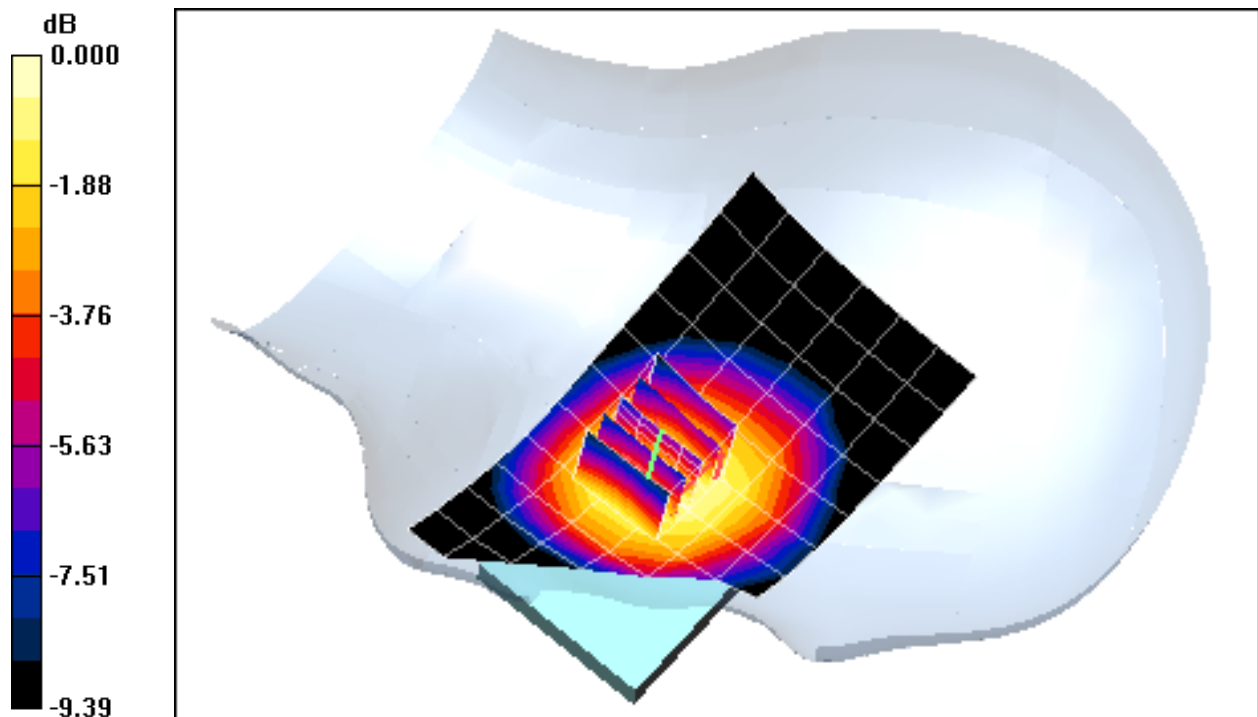

0 dB = 0.927mW/g

PCTEST ENGINEERING LABORATORY, INC.

**DUT: IHDT56MP1; Type: Cellular/PCS CDMA/EVDO Phone
with Bluetooth and WLAN; Serial: Unit X**

Communication System: Cellular CDMA; Frequency: 820.1 MHz; Duty Cycle: 1:1
Medium: 835 Head Medium parameters used (interpolated):
 $f = 820.1 \text{ MHz}$; $\sigma = 0.881 \text{ mho/m}$; $\epsilon_r = 42.5$; $\rho = 1000 \text{ kg/m}^3$
Phantom section: Left Section

Test Date: 06-21-2011; Ambient Temp: 23.2 °C; Tissue Temp: 22.1 °C

Probe: EX3DV4 - SN3561; ConvF(7.96, 7.96, 7.96); Calibrated: 8/19/2010
Sensor-Surface: 4mm (Mechanical Surface Detection)
Electronics: DAE4 Sn649; Calibrated: 2/21/2011
Phantom: SAM Sub; Type: SAM 4.0; Serial: TP-1403
Measurement SW: DASY4, V4.7 Build 80; Postprocessing SW: SEMCAD, V1.8 Build 186

**Mode: Cellular CDMA - FCC Rule Part 90S, Left Head,
Tilt, Mid.ch, Standard Battery**

Area Scan (7x14x1): Measurement grid: $dx=15\text{mm}$, $dy=15\text{mm}$
Zoom Scan (5x5x7)/Cube 0: Measurement grid: $dx=8\text{mm}$, $dy=8\text{mm}$, $dz=5\text{mm}$
Reference Value = 16.4 V/m
Peak SAR (extrapolated) = 0.642 W/kg
SAR(1 g) = 0.522 mW/g; SAR(10 g) = 0.402 mW/g

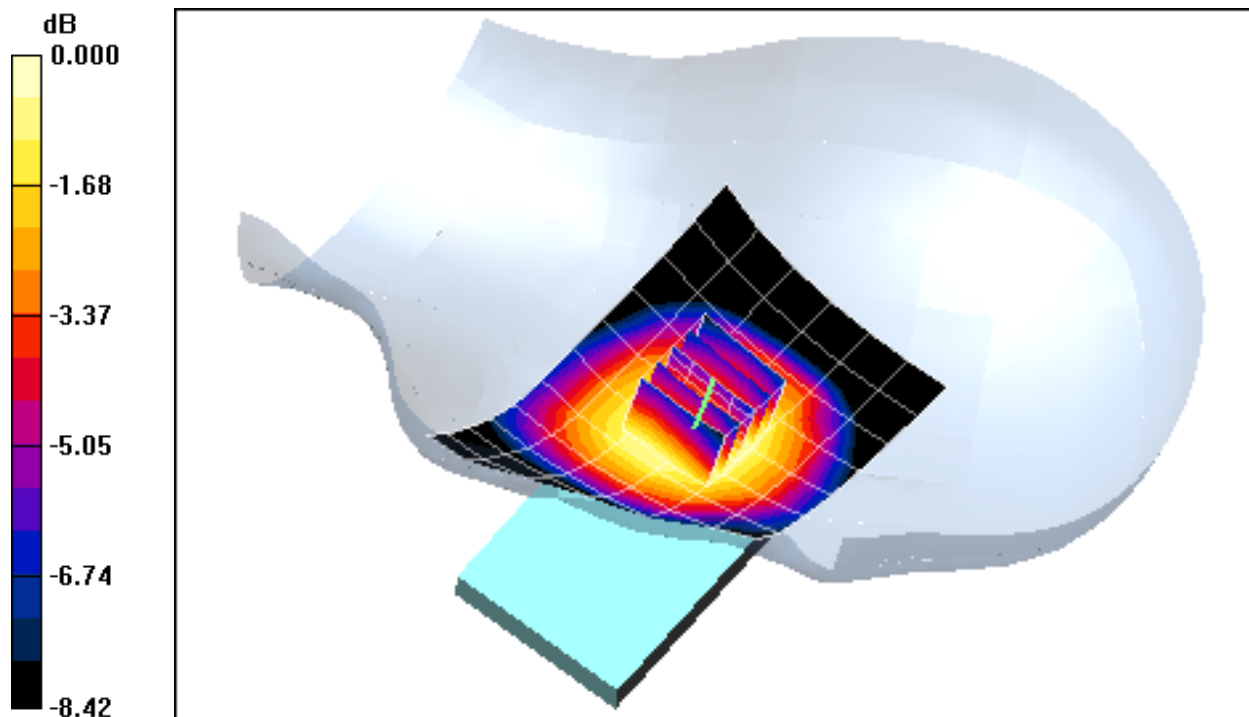

0 dB = 0.548mW/g

PCTEST ENGINEERING LABORATORY, INC.

**DUT: IHDT56MP1; Type: Cellular/PCS CDMA/EVDO Phone
with Bluetooth and WLAN; Serial: Unit X**

Communication System: Cellular CDMA; Frequency: 836.52 MHz; Duty Cycle: 1:1
Medium: 835 Head Medium parameters used (interpolated):
 $f = 836.52 \text{ MHz}$; $\sigma = 0.924 \text{ mho/m}$; $\epsilon_r = 42.2$; $\rho = 1000 \text{ kg/m}^3$
Phantom section: Right Section

Test Date: 06-21-2011; Ambient Temp: 23.2 °C; Tissue Temp: 22.1 °C

Probe: EX3DV4 - SN3561; ConvF(7.96, 7.96, 7.96); Calibrated: 8/19/2010
Sensor-Surface: 4mm (Mechanical Surface Detection)
Electronics: DAE4 Sn649; Calibrated: 2/21/2011
Phantom: SAM Sub; Type: SAM 4.0; Serial: TP-1403
Measurement SW: DASY4, V4.7 Build 80; Postprocessing SW: SEMCAD, V1.8 Build 186

**Mode: Cellular CDMA - FCC Rule Part 22H, Right Head,
Touch, Mid.ch, Standard Battery**

Area Scan (7x14x1): Measurement grid: dx=15mm, dy=15mm
Zoom Scan (5x5x7)/Cube 0: Measurement grid: dx=8mm, dy=8mm, dz=5mm
Reference Value = 34.9 V/m
Peak SAR (extrapolated) = 1.35 W/kg
SAR(1 g) = 1.02 mW/g; SAR(10 g) = 0.773 mW/g

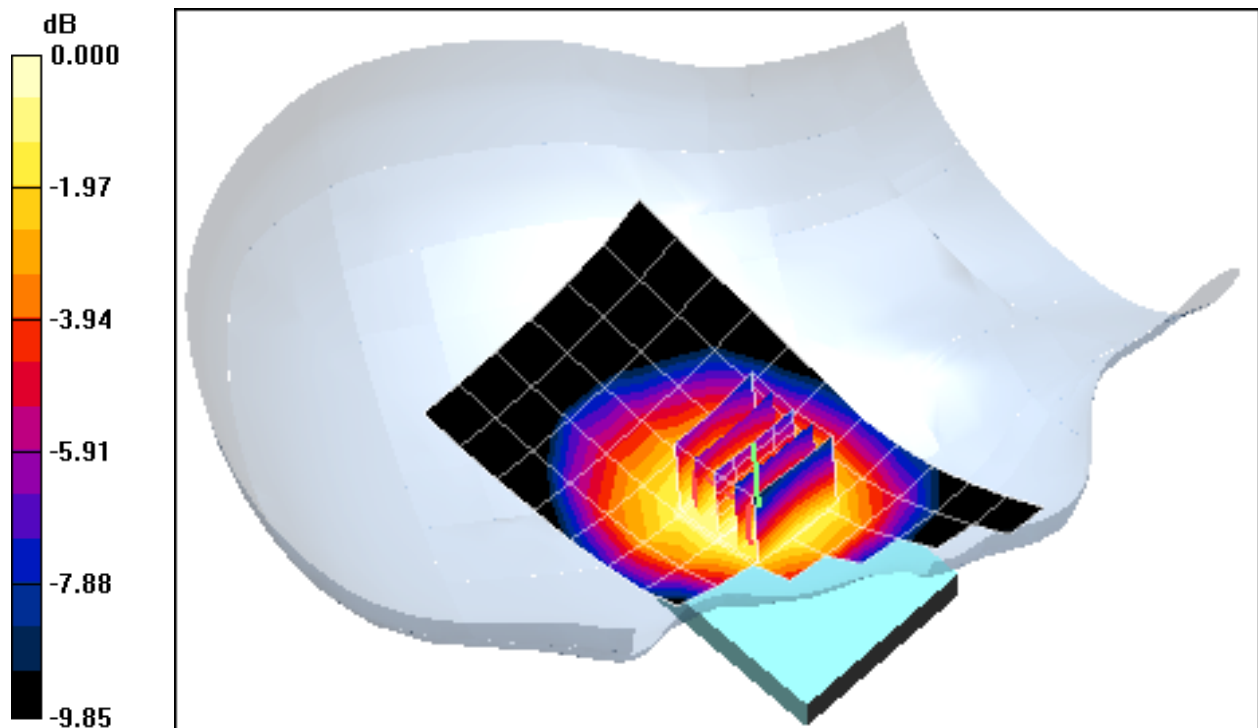

0 dB = 1.07mW/g

PCTEST ENGINEERING LABORATORY, INC.

**DUT: IHDT56MP1; Type: Cellular/PCS CDMA/EVDO Phone
with Bluetooth and WLAN; Serial: Unit X**

Communication System: Cellular CDMA; Frequency: 836.52 MHz; Duty Cycle: 1:1
Medium: 835 Head Medium parameters used (interpolated):
 $f = 836.52 \text{ MHz}$; $\sigma = 0.924 \text{ mho/m}$; $\epsilon_r = 42.2$; $\rho = 1000 \text{ kg/m}^3$
Phantom section: Right Section

Test Date: 06-21-2011; Ambient Temp: 23.2 °C; Tissue Temp: 22.1 °C

Probe: EX3DV4 - SN3561; ConvF(7.96, 7.96, 7.96); Calibrated: 8/19/2010
Sensor-Surface: 4mm (Mechanical Surface Detection)
Electronics: DAE4 Sn649; Calibrated: 2/21/2011
Phantom: SAM Sub; Type: SAM 4.0; Serial: TP-1403
Measurement SW: DASY4, V4.7 Build 80; Postprocessing SW: SEMCAD, V1.8 Build 186

**Mode: Cellular CDMA - FCC Rule Part 22H, Right Head,
Touch, Mid.ch, Standard Battery**

Area Scan (7x14x1): Measurement grid: dx=15mm, dy=15mm
Zoom Scan (5x5x7)/Cube 0: Measurement grid: dx=8mm, dy=8mm, dz=5mm
Reference Value = 34.9 V/m
Peak SAR (extrapolated) = 1.35 W/kg
SAR(1 g) = 1.02 mW/g; SAR(10 g) = 0.773 mW/g

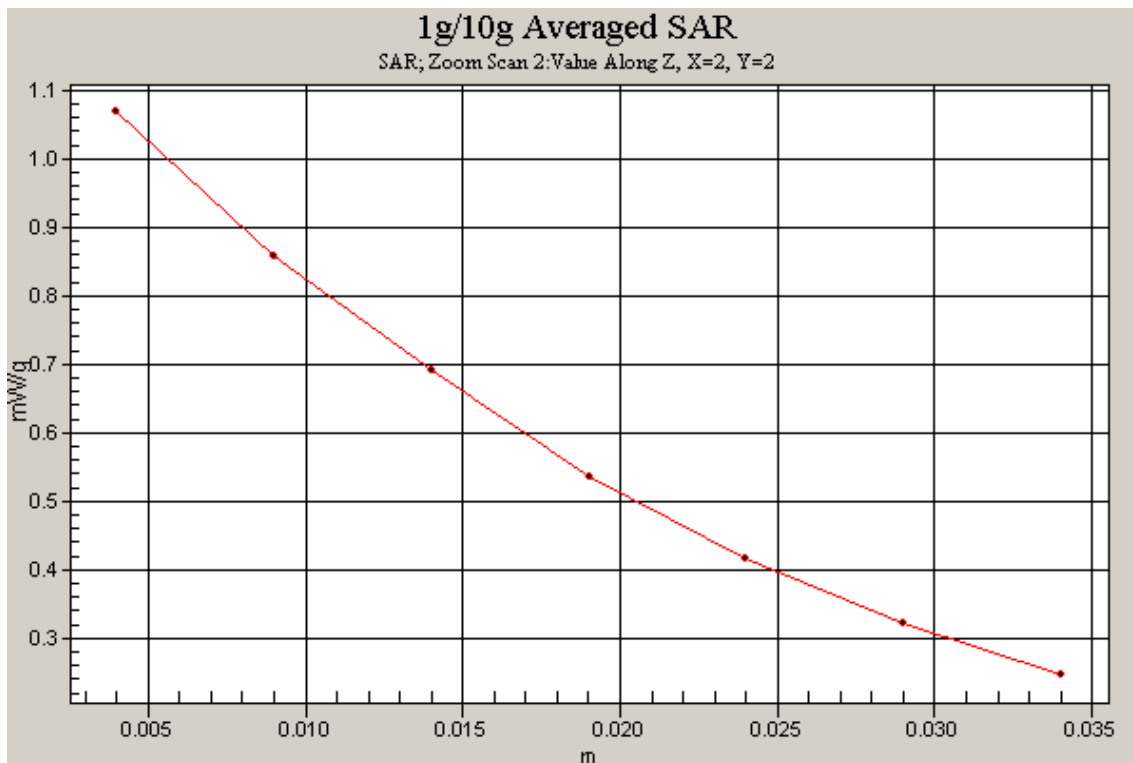

PCTEST ENGINEERING LABORATORY, INC.

**DUT: IHDT56MP1; Type: Cellular/PCS CDMA/EvDO Phone
with Bluetooth and WLAN ; Serial: Unit X**

Communication System: Cellular CDMA; Frequency: 836.52 MHz; Duty Cycle: 1:1
Medium: 835 Head Medium parameters used (interpolated):
 $f = 836.52 \text{ MHz}$; $\sigma = 0.903 \text{ mho/m}$; $\epsilon_r = 42.6$; $\rho = 1000 \text{ kg/m}^3$
Phantom section: Right Section

Test Date: 08-22-2011; Ambient Temp: 23.3°C; Tissue Temp: 22.0°C

Probe: ES3DV3 - SN3258; ConvF(6.18, 6.18, 6.18); Calibrated: 4/8/2011
Sensor-Surface: 4mm (Mechanical Surface Detection)
Electronics: DAE4 Sn649; Calibrated: 2/21/2011
Phantom: SAM Sub; Type: SAM 4.0; Serial: TP-1403
Measurement SW: DASY4, V4.7 Build 80; Postprocessing SW: SEMCAD, V1.8 Build 186

**Mode: Cellular EVDO - Rev. A - FCC Rule Part 22H, Right Head,
Touch, Mid.ch, Standard Battery**

Area Scan (7x14x1): Measurement grid: $dx=15\text{mm}$, $dy=15\text{mm}$
Zoom Scan (5x5x7)/Cube 0: Measurement grid: $dx=8\text{mm}$, $dy=8\text{mm}$, $dz=5\text{mm}$
Reference Value = 32.8 V/m
Peak SAR (extrapolated) = 1.13 W/kg
SAR(1 g) = 0.865 mW/g; SAR(10 g) = 0.653 mW/g

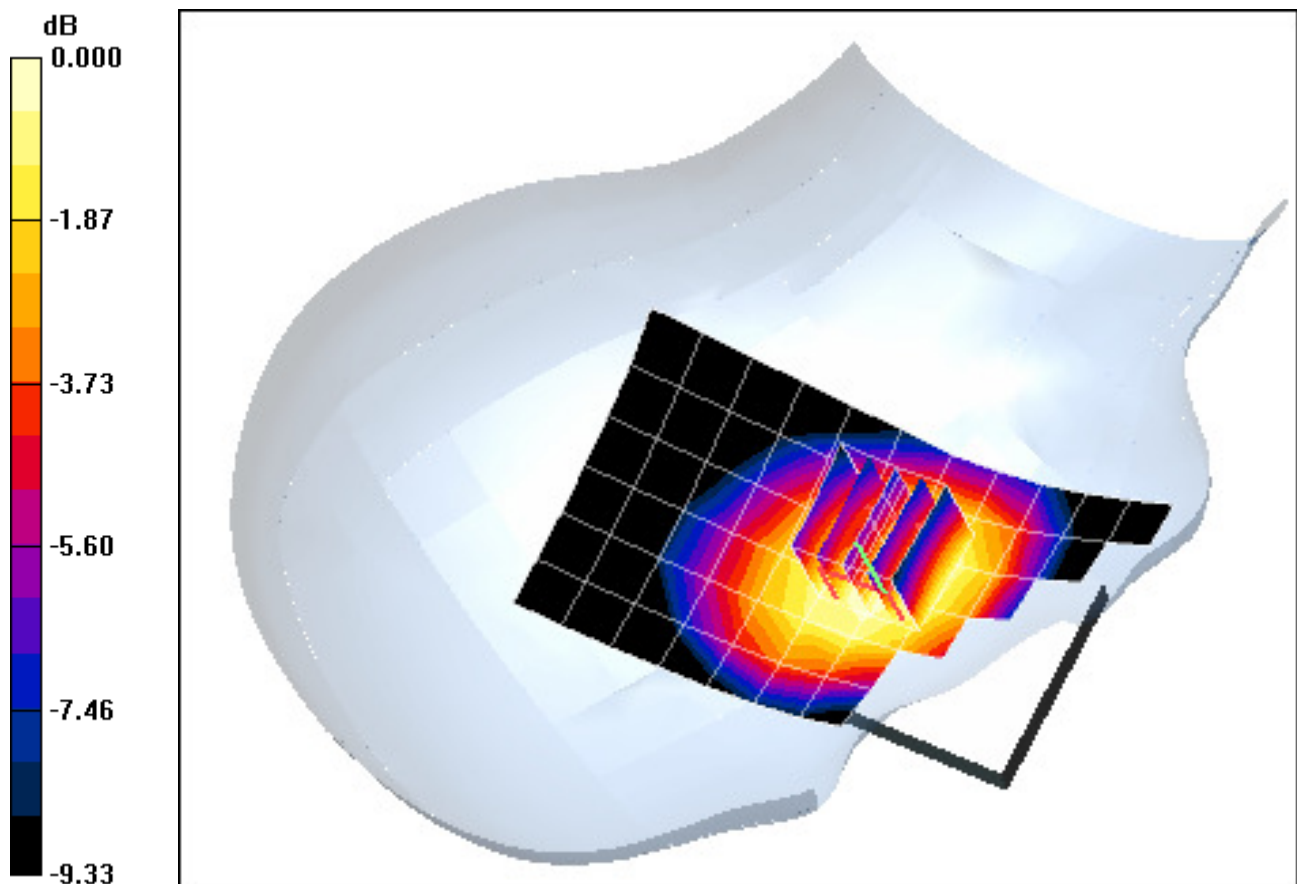

0 dB = 0.904mW/g

PCTEST ENGINEERING LABORATORY, INC.

**DUT: IHDT56MP1; Type: Cellular/PCS CDMA/EVDO Phone
with Bluetooth and WLAN; Serial: Unit X**

Communication System: Cellular CDMA; Frequency: 836.52 MHz; Duty Cycle: 1:1
Medium: 835 Head Medium parameters used (interpolated):
 $f = 836.52 \text{ MHz}$; $\sigma = 0.924 \text{ mho/m}$; $\epsilon_r = 42.2$; $\rho = 1000 \text{ kg/m}^3$
Phantom section: Right Section

Test Date: 06-21-2011; Ambient Temp: 23.2 °C; Tissue Temp: 22.1 °C

Probe: EX3DV4 - SN3561; ConvF(7.96, 7.96, 7.96); Calibrated: 8/19/2010
Sensor-Surface: 4mm (Mechanical Surface Detection)
Electronics: DAE4 Sn649; Calibrated: 2/21/2011
Phantom: SAM Sub; Type: SAM 4.0; Serial: TP-1403

Measurement SW: DASY4, V4.7 Build 80; Postprocessing SW: SEMCAD, V1.8 Build 186

**Mode: Cellular CDMA - FCC Rule Part 22H, Right Head,
Tilt, Mid.ch, Standard Battery**

Area Scan (7x14x1): Measurement grid: $dx=15\text{mm}$, $dy=15\text{mm}$

Zoom Scan (5x5x7)/Cube 0: Measurement grid: $dx=8\text{mm}$, $dy=8\text{mm}$, $dz=5\text{mm}$

Reference Value = 28.1 V/m

Peak SAR (extrapolated) = 0.862 W/kg

SAR(1 g) = 0.684 mW/g; SAR(10 g) = 0.515 mW/g

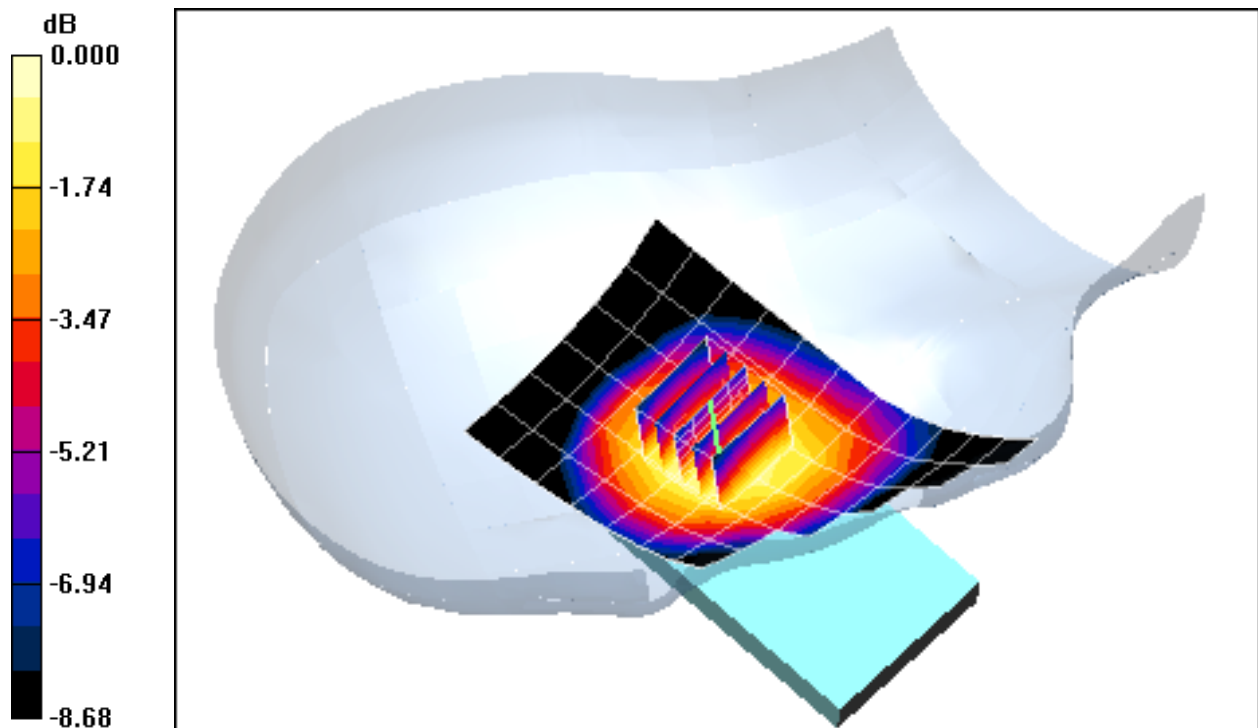

0 dB = 0.722mW/g

PCTEST ENGINEERING LABORATORY, INC.

**DUT: IHDT56MP1; Type: Cellular/PCS CDMA/EVDO Phone
with Bluetooth and WLAN; Serial: Unit X**

Communication System: Cellular CDMA; Frequency: 848.31 MHz; Duty Cycle: 1:1
Medium: 835 Head Medium parameters used (interpolated):
 $f = 848.31$ MHz; $\sigma = 0.94$ mho/m; $\epsilon_r = 42.3$; $\rho = 1000$ kg/m³
Phantom section: Left Section

Test Date: 06-21-2011; Ambient Temp: 23.2 °C; Tissue Temp: 22.1 °C

Probe: EX3DV4 - SN3561; ConvF(7.96, 7.96, 7.96); Calibrated: 8/19/2010
Sensor-Surface: 4mm (Mechanical Surface Detection)
Electronics: DAE4 Sn649; Calibrated: 2/21/2011
Phantom: SAM Sub; Type: SAM 4.0; Serial: TP-1403
Measurement SW: DASY4, V4.7 Build 80; Postprocessing SW: SEMCAD, V1.8 Build 186

**Mode: Cellular CDMA - FCC Rule Part 22H, Left Head,
Touch, High.ch, Standard Battery**

Area Scan (7x14x1): Measurement grid: dx=15mm, dy=15mm
Zoom Scan (5x5x7)/Cube 0: Measurement grid: dx=8mm, dy=8mm, dz=5mm
Reference Value = 10.1 V/m
Peak SAR (extrapolated) = 1.17 W/kg
SAR(1 g) = 0.934 mW/g; SAR(10 g) = 0.709 mW/g

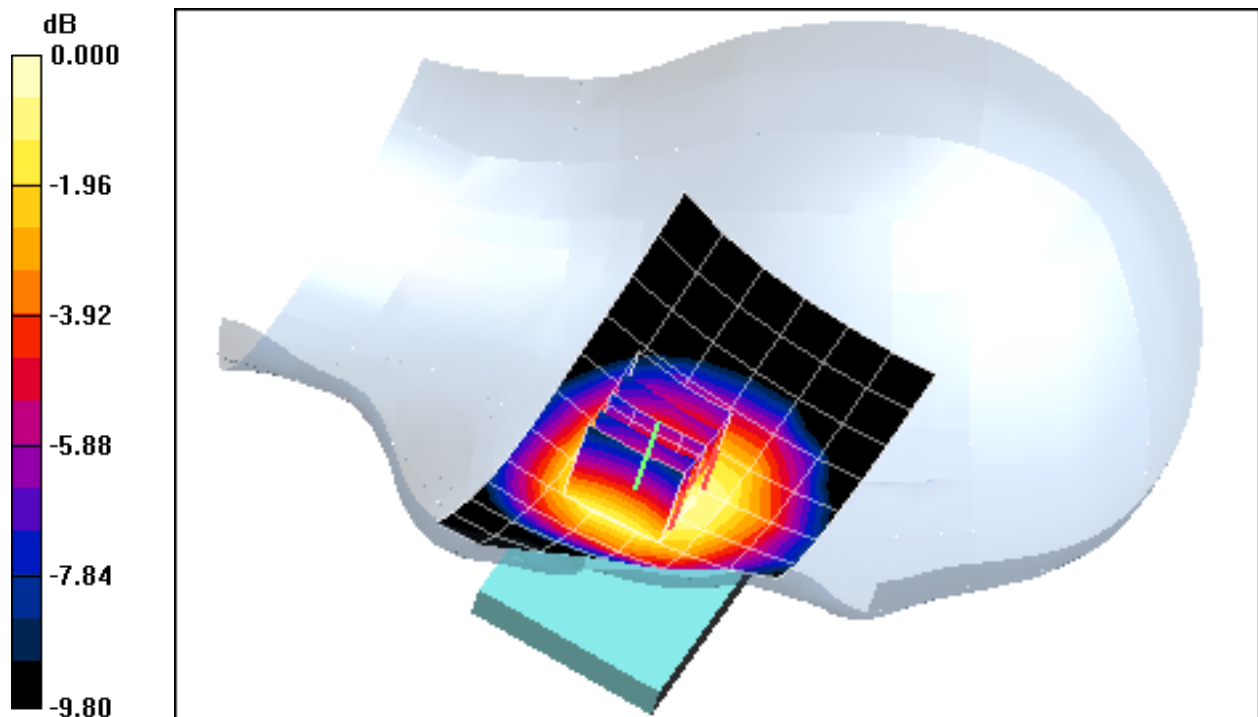

0 dB = 0.971mW/g

PCTEST ENGINEERING LABORATORY, INC.

**DUT: IHDT56MP1; Type: Cellular/PCS CDMA/EVDO Phone
with Bluetooth and WLAN; Serial: Unit X**

Communication System: Cellular CDMA; Frequency: 836.52 MHz; Duty Cycle: 1:1
Medium: 835 Head Medium parameters used (interpolated):
 $f = 836.52 \text{ MHz}$; $\sigma = 0.924 \text{ mho/m}$; $\epsilon_r = 42.2$; $\rho = 1000 \text{ kg/m}^3$
Phantom section: Left Section

Test Date: 06-21-2011; Ambient Temp: 23.2 °C; Tissue Temp: 22.1 °C

Probe: EX3DV4 - SN3561; ConvF(7.96, 7.96, 7.96); Calibrated: 8/19/2010
Sensor-Surface: 4mm (Mechanical Surface Detection)
Electronics: DAE4 Sn649; Calibrated: 2/21/2011
Phantom: SAM Sub; Type: SAM 4.0; Serial: TP-1403
Measurement SW: DASY4, V4.7 Build 80; Postprocessing SW: SEMCAD, V1.8 Build 186

**Mode: Cellular CDMA - FCC Rule Part 22H, Left Head,
Tilt, Mid.ch, Standard Battery**

Area Scan (7x14x1): Measurement grid: $dx=15\text{mm}$, $dy=15\text{mm}$
Zoom Scan (5x5x7)/Cube 0: Measurement grid: $dx=8\text{mm}$, $dy=8\text{mm}$, $dz=5\text{mm}$
Reference Value = 16.5 V/m
Peak SAR (extrapolated) = 0.712 W/kg
SAR(1 g) = 0.571 mW/g; SAR(10 g) = 0.437 mW/g

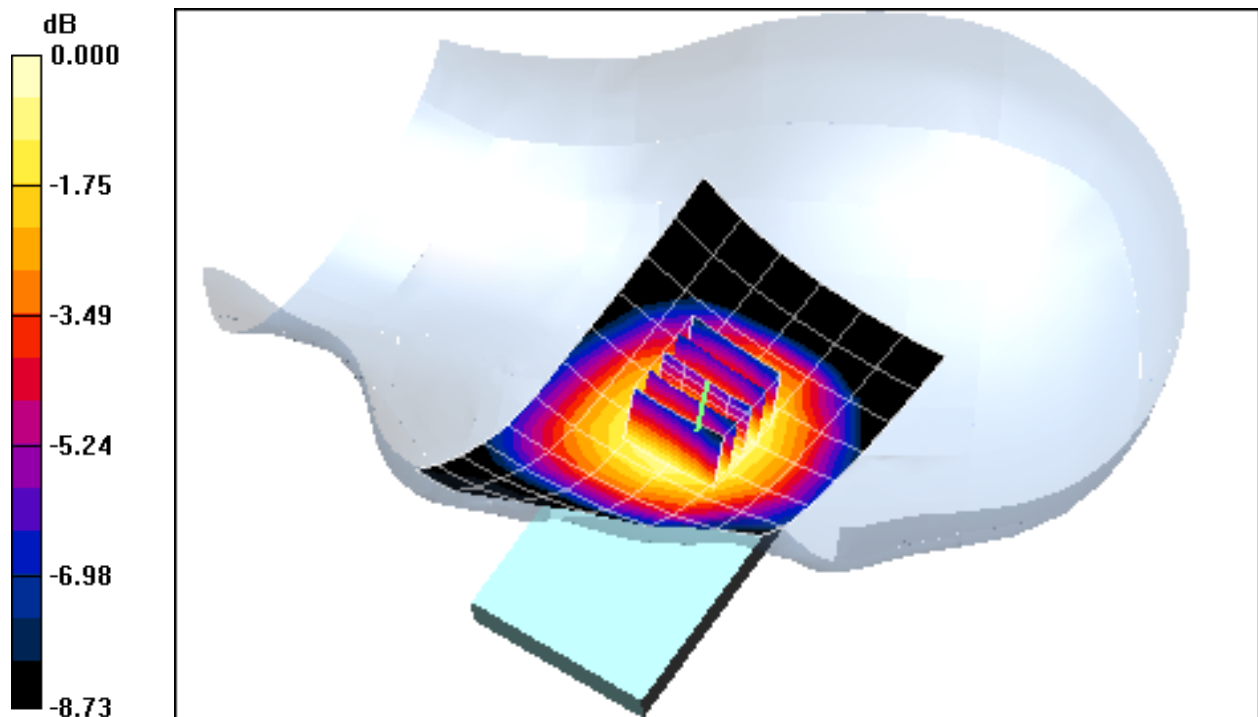

0 dB = 0.595mW/g

PCTEST ENGINEERING LABORATORY, INC.

**DUT: IHDT56MP1; Type: Cellular/PCS CDMA/EVDO Phone
with Bluetooth and WLAN; Serial: Unit X**

Communication System: PCS CDMA; Frequency: 1851.25 MHz; Duty Cycle: 1:1

Medium: 1900 Head Medium parameters used:

$f = 1851.25 \text{ MHz}$; $\sigma = 1.39 \text{ mho/m}$; $\epsilon_r = 40.18$; $\rho = 1000 \text{ kg/m}^3$

Phantom section: Flat Section

Test Date: 06-21-2011; Ambient Temp: 24.2 °C; Tissue Temp: 22.7 °C

Probe: EX3DV4 - SN3550; ConvF(7.01, 7.01, 7.01); Calibrated: 2/14/2011

Sensor-Surface: 4mm (Mechanical Surface Detection)

Electronics: DAE4 Sn665; Calibrated: 4/20/2011

Phantom: SAM Main; Type: SAM 4.0; Serial: TP-1114

Measurement SW: DASY4, V4.7 Build 80; Postprocessing SW: SEMCAD, V1.8 Build 186

**Mode: PCS CDMA, Mouth SAR, Low.ch,
Standard Battery, Replacing Right Touch**

Area Scan (7x9x1): Measurement grid: dx=15mm, dy=15mm

Zoom Scan (5x5x7)/Cube 0: Measurement grid: dx=8mm, dy=8mm, dz=5mm

Reference Value = 11.5 V/m

Peak SAR (extrapolated) = 1.69 W/kg

SAR(1 g) = 1.01 mW/g; SAR(10 g) = 0.570 mW/g

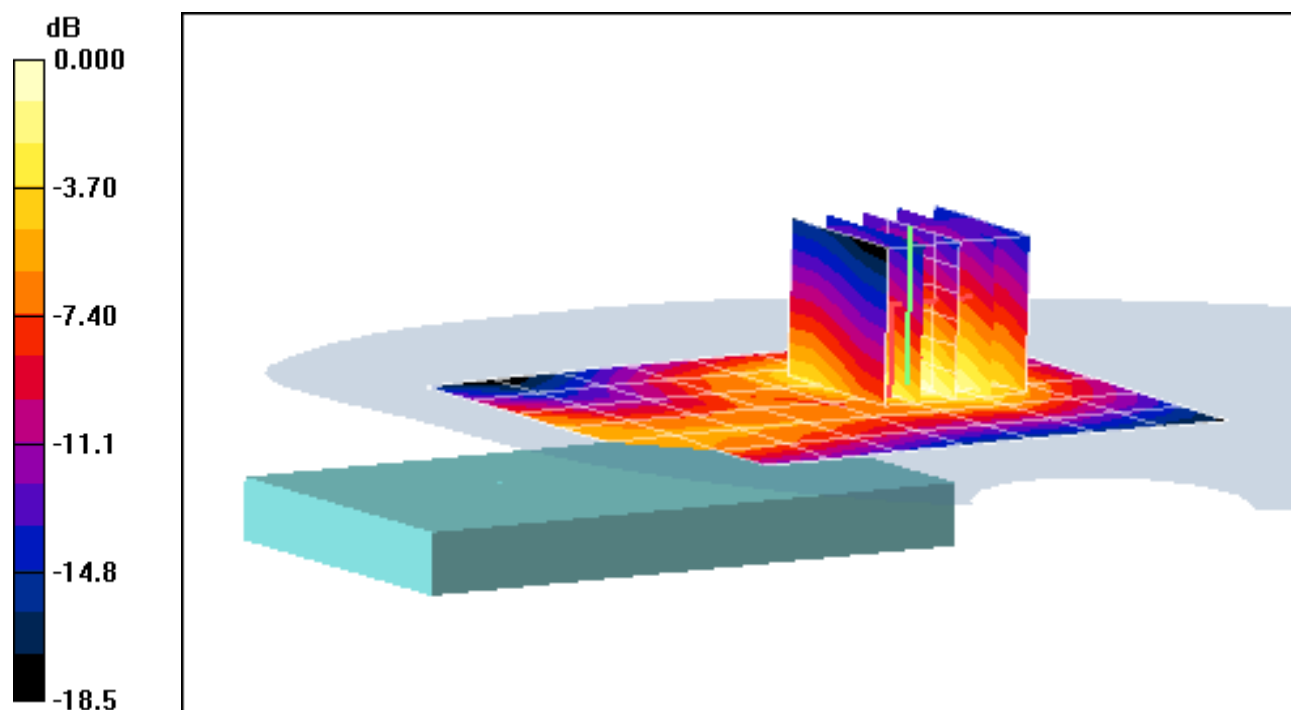

0 dB = 1.12mW/g

PCTEST ENGINEERING LABORATORY, INC.

**DUT: IHDT56MP1; Type: Cellular/PCS CDMA/EVDO Phone
with Bluetooth and WLAN; Serial: Unit X**

Communication System: PCS CDMA; Frequency: 1880 MHz; Duty Cycle: 1:1

Medium: 1900 Head Medium parameters used:

$f = 1880 \text{ MHz}$; $\sigma = 1.41 \text{ mho/m}$; $\epsilon_r = 40.16$; $\rho = 1000 \text{ kg/m}^3$

Phantom section: Right Section

Test Date: 06-21-2011; Ambient Temp: 24.2 °C; Tissue Temp: 22.7 °C

Probe: EX3DV4 - SN3550; ConvF(7.01, 7.01, 7.01); Calibrated: 2/14/2011

Sensor-Surface: 4mm (Mechanical Surface Detection)

Electronics: DAE4 Sn665; Calibrated: 4/20/2011

Phantom: SAM Main; Type: SAM 4.0; Serial: TP-1114

Measurement SW: DASY4, V4.7 Build 80; Postprocessing SW: SEMCAD, V1.8 Build 186

Mode: PCS CDMA, Right Head, Tilt, Mid.ch, Standard Battery

Area Scan (7x14x1): Measurement grid: dx=15mm, dy=15mm

Zoom Scan (5x5x7)/Cube 0: Measurement grid: dx=8mm, dy=8mm, dz=5mm

Reference Value = 16.7 V/m

Peak SAR (extrapolated) = 0.533 W/kg

SAR(1 g) = 0.358 mW/g; SAR(10 g) = 0.227 mW/g

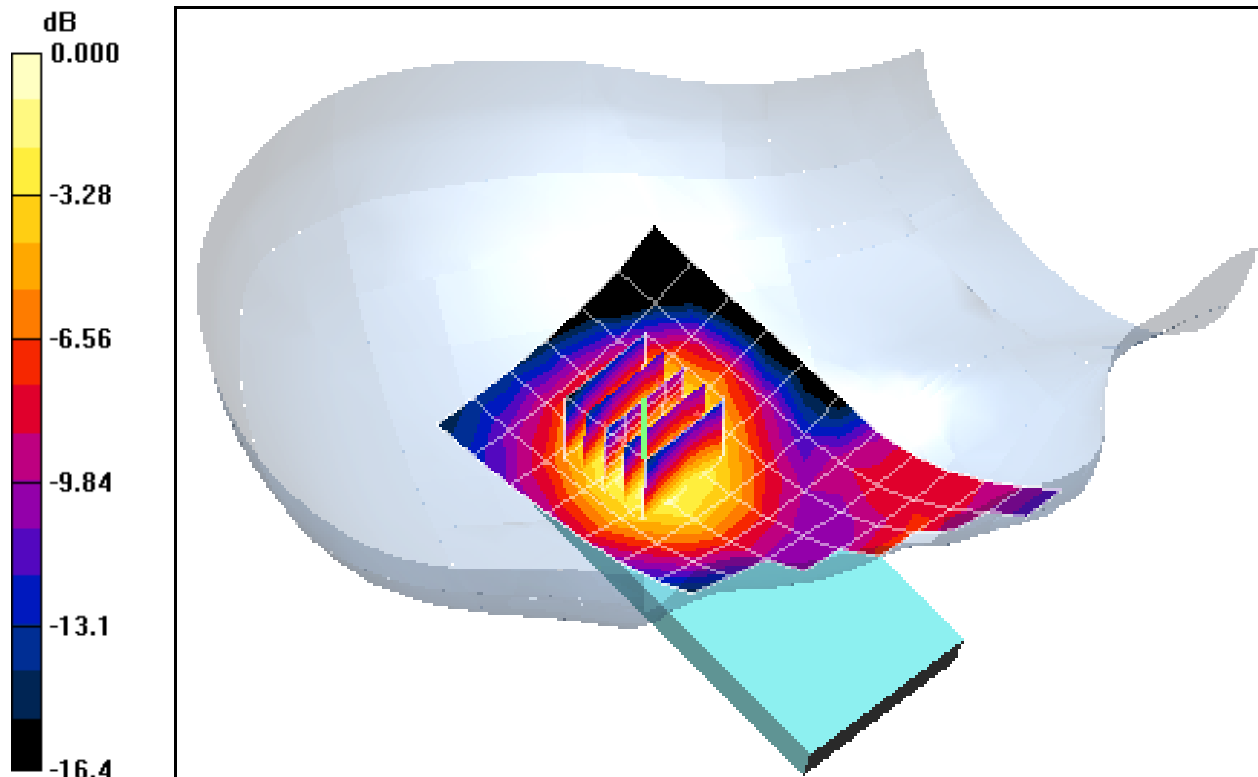

0 dB = 0.388mW/g

PCTEST ENGINEERING LABORATORY, INC.

**DUT: IHDT56MP1; Type: Cellular/PCS CDMA/EVDO Phone
with Bluetooth and WLAN; Serial: Unit X**

Communication System: PCS CDMA; Frequency: 1851.25 MHz; Duty Cycle: 1:1

Medium: 1900 Head Medium parameters used:

$f = 1851.25 \text{ MHz}$; $\sigma = 1.39 \text{ mho/m}$; $\epsilon_r = 40.18$; $\rho = 1000 \text{ kg/m}^3$

Phantom section: Left Section

Test Date: 06-21-2011; Ambient Temp: 24.2 °C; Tissue Temp: 22.7 °C

Probe: EX3DV4 - SN3550; ConvF(7.01, 7.01, 7.01); Calibrated: 2/14/2011

Sensor-Surface: 4mm (Mechanical Surface Detection)

Electronics: DAE4 Sn665; Calibrated: 4/20/2011

Phantom: SAM Main; Type: SAM 4.0; Serial: TP-1114

Measurement SW: DASY4, V4.7 Build 80; Postprocessing SW: SEMCAD, V1.8 Build 186

Mode: PCS CDMA, Left Head, Touch, Low.ch, Standard Battery

Area Scan (7x14x1): Measurement grid: dx=15mm, dy=15mm

Zoom Scan (5x5x7)/Cube 0: Measurement grid: dx=8mm, dy=8mm, dz=5mm

Reference Value = 30.0 V/m

Peak SAR (extrapolated) = 1.58 W/kg

SAR(1 g) = 1.06 mW/g; SAR(10 g) = 0.645 mW/g

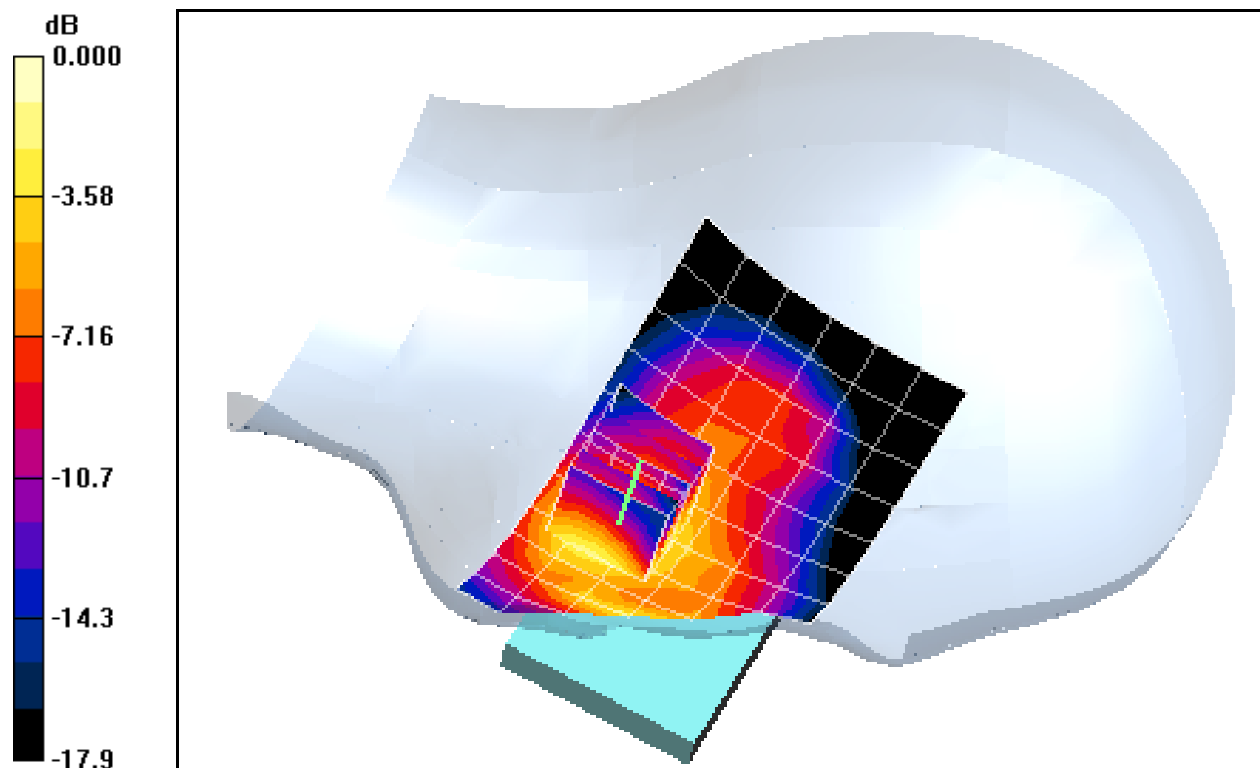

0 dB = 1.17mW/g

PCTEST ENGINEERING LABORATORY, INC.

**DUT: IHDT56MP1; Type: Cellular/PCS CDMA/EVDO Phone
with Bluetooth and WLAN; Serial: Unit X**

Communication System: PCS CDMA; Frequency: 1851.25 MHz; Duty Cycle: 1:1

Medium: 1900 Head Medium parameters used:

$f = 1851.25 \text{ MHz}$; $\sigma = 1.39 \text{ mho/m}$; $\epsilon_r = 40.18$; $\rho = 1000 \text{ kg/m}^3$

Phantom section: Left Section

Test Date: 06-21-2011; Ambient Temp: 24.2 °C; Tissue Temp: 22.7 °C

Probe: EX3DV4 - SN3550; ConvF(7.01, 7.01, 7.01); Calibrated: 2/14/2011

Sensor-Surface: 4mm (Mechanical Surface Detection)

Electronics: DAE4 Sn665; Calibrated: 4/20/2011

Phantom: SAM Main; Type: SAM 4.0; Serial: TP-1114

Measurement SW: DASY4, V4.7 Build 80; Postprocessing SW: SEMCAD, V1.8 Build 186

Mode: PCS CDMA, Left Head, Touch, Low.ch, Standard Battery

Area Scan (7x14x1): Measurement grid: dx=15mm, dy=15mm

Zoom Scan (5x5x7)/Cube 0: Measurement grid: dx=8mm, dy=8mm, dz=5mm

Reference Value = 30.0 V/m

Peak SAR (extrapolated) = 1.58 W/kg

SAR(1 g) = 1.06 mW/g; SAR(10 g) = 0.645 mW/g

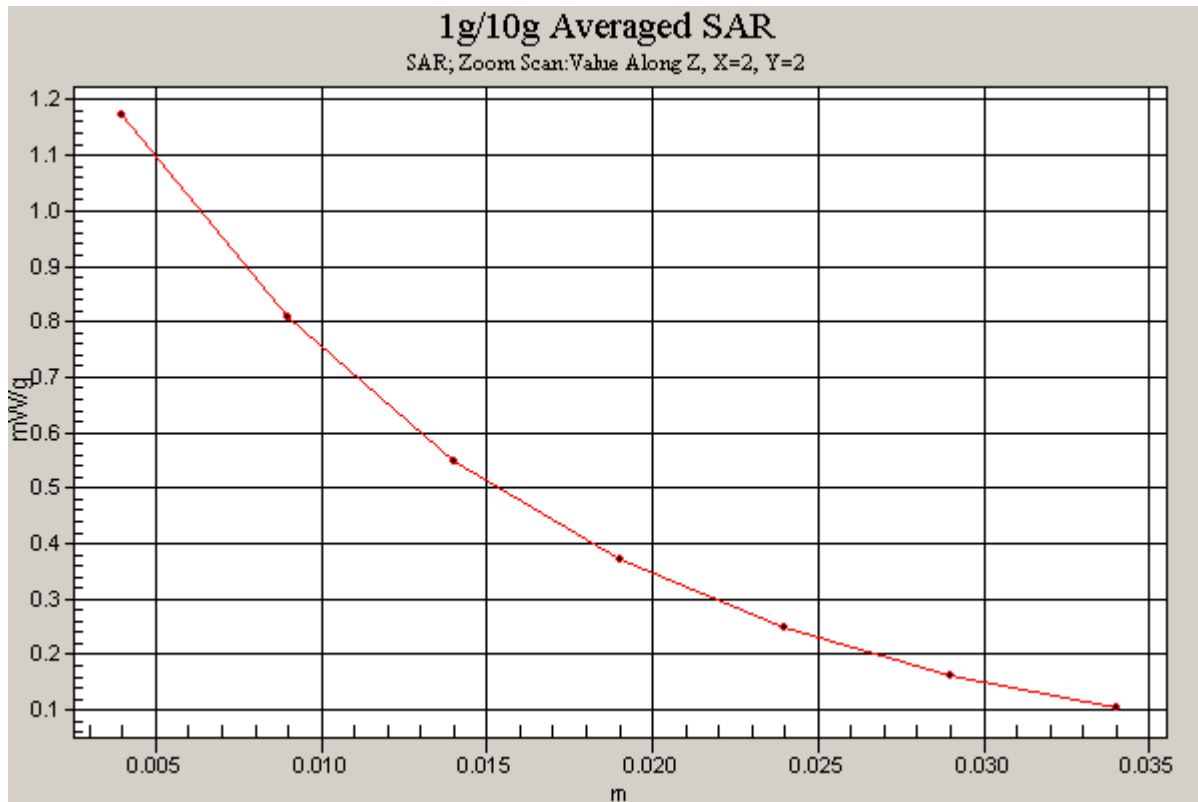

PCTEST ENGINEERING LABORATORY, INC.

**DUT: IHDT56MP1; Type: Cellular/PCS CDMA/EvDO Phone
with Bluetooth and WLAN ; Serial: Unit X**

Communication System: PCS CDMA; Frequency: 1851.25 MHz; Duty Cycle: 1:1
Medium: 1900 Head Medium parameters used (interpolated):
 $f = 1851.25 \text{ MHz}$; $\sigma = 1.39 \text{ mho/m}$; $\epsilon_r = 40.1$; $\rho = 1000 \text{ kg/m}^3$
Phantom section: Left Section

Test Date: 2/ /44/4233; Ambient Temp: 22.8° C; Tissue Temp: 20.2°C

Probe: EX3DV4 - SN3550; ConvF(7.01, 7.01, 7.01); Calibrated: 2/14/2011
Sensor-Surface: 4mm (Mechanical Surface Detection)
Electronics: DAE4 Sn665; Calibrated: 4/20/2011
Phantom: SAM Main; Type: SAM 4.0; Serial: TP-1114
Measurement SW: DASY4, V4.7 Build 80; Postprocessing SW: SEMCAD, V1.8 Build 186

Mode: PCS EVDO Rev. A, Left Head, Touch, Low.ch, Standard Battery

Area Scan (7x11x1): Measurement grid: dx=15mm, dy=15mm
Zoom Scan (5x5x7)/Cube 0: Measurement grid: dx=8mm, dy=8mm, dz=5mm
Reference Value = 28.8 V/m
Peak SAR (extrapolated) = 1.42 W/kg
SAR(1 g) = 0.963 mW/g; SAR(10 g) = 0.590 mW/g

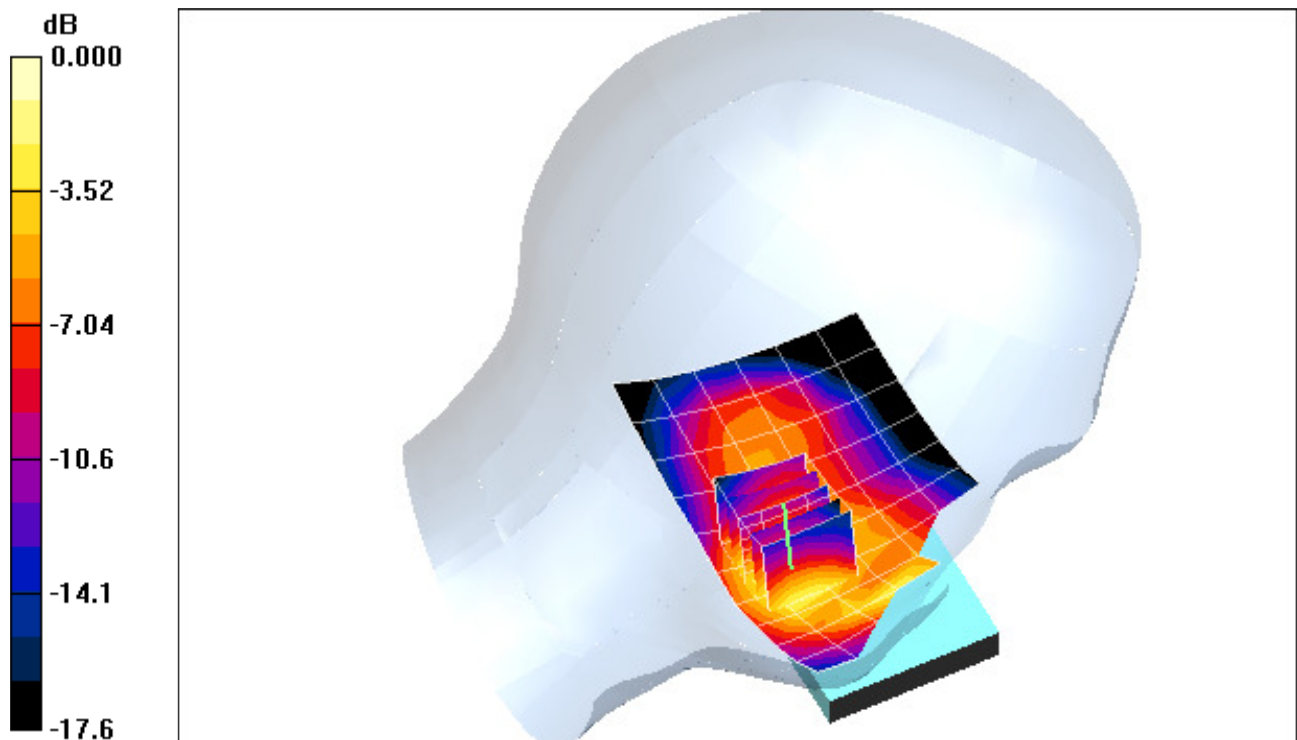

0 dB = 1.05mW/g

PCTEST ENGINEERING LABORATORY, INC.

**DUT: IHDT56MP1; Type: Cellular/PCS CDMA/EVDO Phone
with Bluetooth and WLAN; Serial: Unit X**

Communication System: PCS CDMA; Frequency: 1880 MHz; Duty Cycle: 1:1

Medium: 1900 Head Medium parameters used:

$f = 1880 \text{ MHz}$; $\sigma = 1.41 \text{ mho/m}$; $\epsilon_r = 40.16$; $\rho = 1000 \text{ kg/m}^3$

Phantom section: Left Section

Test Date: 06-21-2011; Ambient Temp: 24.2 °C; Tissue Temp: 22.7 °C

Probe: EX3DV4 - SN3550; ConvF(7.01, 7.01, 7.01); Calibrated: 2/14/2011

Sensor-Surface: 4mm (Mechanical Surface Detection)

Electronics: DAE4 Sn665; Calibrated: 4/20/2011

Phantom: SAM Main; Type: SAM 4.0; Serial: TP-1114

Measurement SW: DASY4, V4.7 Build 80; Postprocessing SW: SEMCAD, V1.8 Build 186

Mode: PCS CDMA, Left Head, Tilt, Mid.ch, Standard Battery

Area Scan (7x14x1): Measurement grid: dx=15mm, dy=15mm

Zoom Scan (5x5x7)/Cube 0: Measurement grid: dx=8mm, dy=8mm, dz=5mm

Reference Value = 16.8 V/m

Peak SAR (extrapolated) = 0.568 W/kg

SAR(1 g) = 0.354 mW/g; SAR(10 g) = 0.213 mW/g

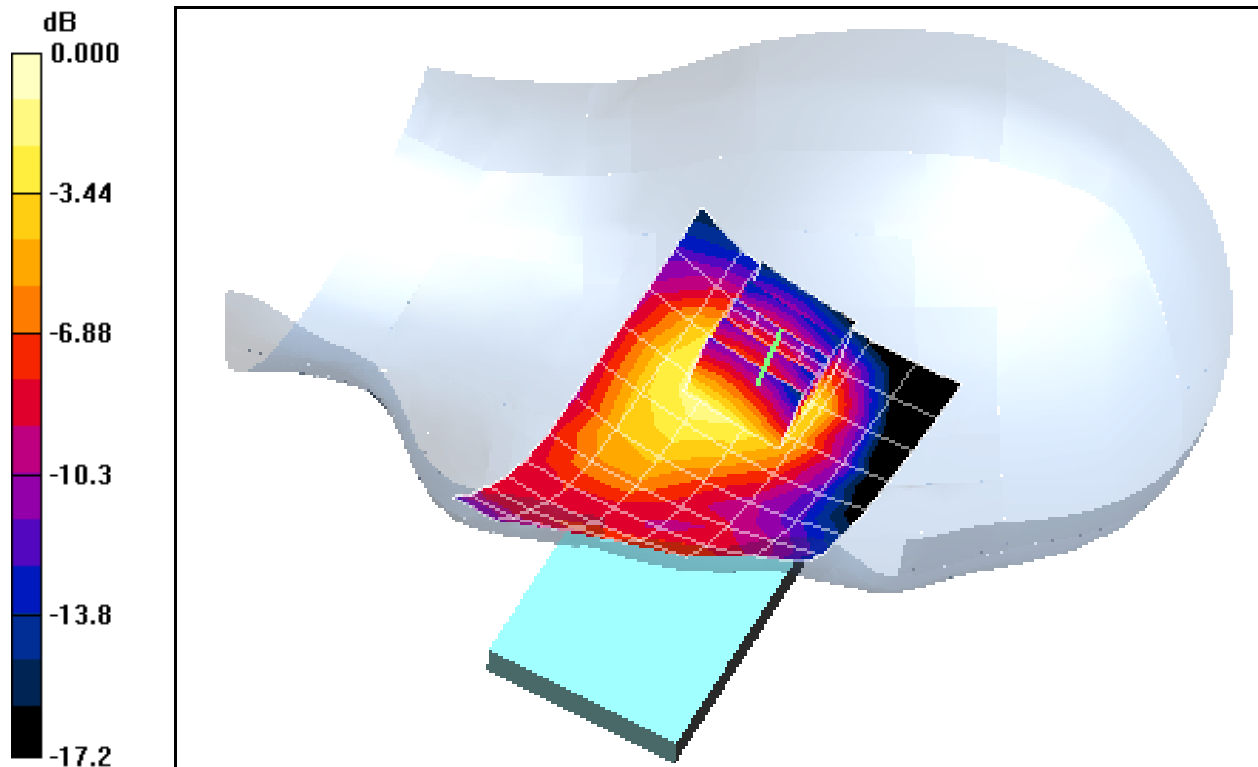

0 dB = 0.382mW/g

PCTEST ENGINEERING LABORATORY, INC.

**DUT: IHDT56MP1; Type: Cellular/PCS CDMA/EVDO Phone
with Bluetooth and WLAN; Serial: Unit C**

Communication System: IEEE 802.11b; Frequency: 2462 MHz; Duty Cycle: 1:1

Medium: 2450 Head Medium parameters used (interpolated):

$f = 2462 \text{ MHz}$; $\sigma = 1.89 \text{ mho/m}$; $\epsilon_r = 38.7$; $\rho = 1000 \text{ kg/m}^3$

Phantom section: Right Section

Test Date: 05-26-2011; Ambient Temp: 23.4 °C; Tissue Temp: 22.4 °C

Probe: ES3DV2 - SN3022; ConvF(4.21, 4.21, 4.21); Calibrated: 9/21/2010

Sensor-Surface: 3mm (Mechanical Surface Detection)

Electronics: DAE4 Sn704; Calibrated: 3/17/2011

Phantom: SAM with CRP; Type: SAM; Serial: TP1375

Measurement SW: DASY4, V4.7 Build 80; Postprocessing SW: SEMCAD, V1.8 Build 186

Mode: IEEE 802.11b, Right Head, Touch, Ch 11, 1 Mbps, Standard Battery

Area Scan (7x12x1): Measurement grid: dx=15mm, dy=15mm

Zoom Scan (5x5x7)/Cube 0: Measurement grid: dx=8mm, dy=8mm, dz=5mm

Reference Value = 13.2 V/m

Peak SAR (extrapolated) = 0.678 W/kg

SAR(1 g) = 0.321 mW/g; SAR(10 g) = 0.145 mW/g

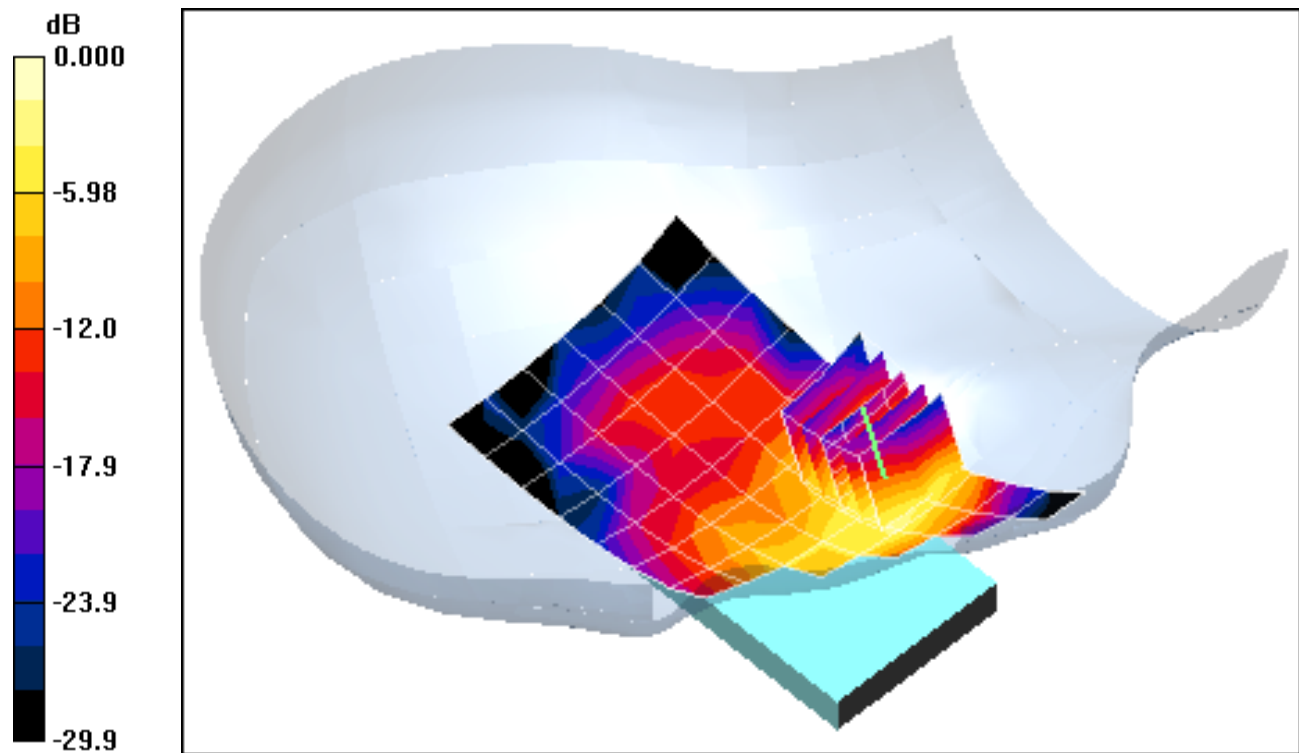

0 dB = 0.416mW/g

PCTEST ENGINEERING LABORATORY, INC.

**DUT: IHDT56MP1; Type: Cellular/PCS CDMA/EVDO Phone
with Bluetooth and WLAN; Serial: Unit C**

Communication System: IEEE 802.11b; Frequency: 2462 MHz; Duty Cycle: 1:1
Medium: 2450 Head Medium parameters used (interpolated):
 $f = 2462 \text{ MHz}$; $\sigma = 1.89 \text{ mho/m}$; $\epsilon_r = 38.7$; $\rho = 1000 \text{ kg/m}^3$
Phantom section: Right Section

Test Date: 05-26-2011; Ambient Temp: 23.4 °C; Tissue Temp: 22.4 °C

Probe: ES3DV2 - SN3022; ConvF(4.21, 4.21, 4.21); Calibrated: 9/21/2010
Sensor-Surface: 3mm (Mechanical Surface Detection)
Electronics: DAE4 Sn704; Calibrated: 3/17/2011
Phantom: SAM with CRP; Type: SAM; Serial: TP1375
Measurement SW: DASY4, V4.7 Build 80; Postprocessing SW: SEMCAD, V1.8 Build 186

Mode: IEEE 802.11b, Right Head, Touch, Ch 11, 1 Mbps, Standard Battery

Area Scan (7x12x1): Measurement grid: dx=15mm, dy=15mm
Zoom Scan (5x5x7)/Cube 0: Measurement grid: dx=8mm, dy=8mm, dz=5mm
Reference Value = 13.2 V/m
Peak SAR (extrapolated) = 0.678 W/kg
SAR(1 g) = 0.321 mW/g; SAR(10 g) = 0.145 mW/g

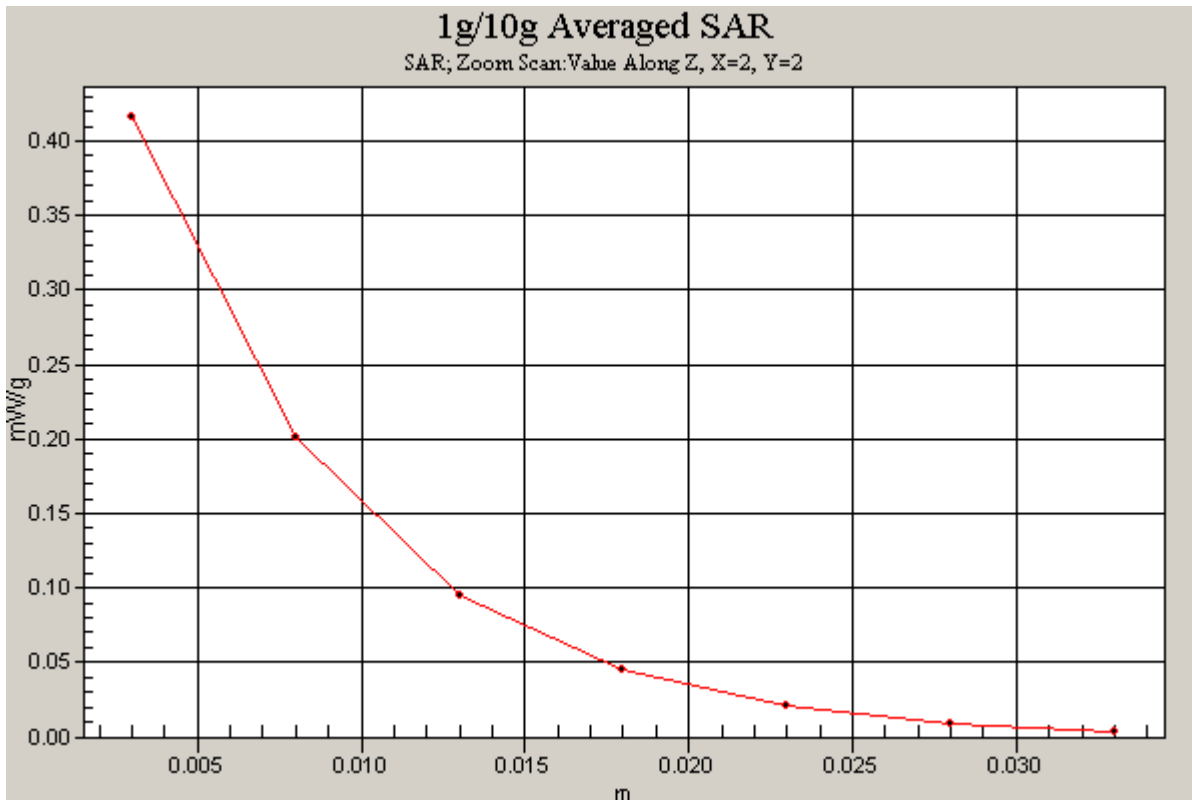

PCTEST ENGINEERING LABORATORY, INC.

**DUT: IHDT56MP1; Type: Cellular/PCS CDMA/EVDO Phone
with Bluetooth and WLAN; Serial: Unit C**

Communication System: IEEE 802.11b; Frequency: 2462 MHz; Duty Cycle: 1:1

Medium: 2450 Head Medium parameters used (interpolated):

$f = 2462 \text{ MHz}$; $\sigma = 1.89 \text{ mho/m}$; $\epsilon_r = 38.7$; $\rho = 1000 \text{ kg/m}^3$

Phantom section: Right Section

Test Date: 05-26-2011; Ambient Temp: 23.4 °C; Tissue Temp: 22.4 °C

Probe: ES3DV2 - SN3022; ConvF(4.21, 4.21, 4.21); Calibrated: 9/21/2010

Sensor-Surface: 3mm (Mechanical Surface Detection)

Electronics: DAE4 Sn704; Calibrated: 3/17/2011

Phantom: SAM with CRP; Type: SAM; Serial: TP1375

Measurement SW: DASY4, V4.7 Build 80; Postprocessing SW: SEMCAD, V1.8 Build 186

Mode: IEEE 802.11b, Right Head, Tilt, Ch 11, 1 Mbps, Standard Battery

Area Scan (7x14x1): Measurement grid: dx=15mm, dy=15mm

Zoom Scan (5x5x7)/Cube 0: Measurement grid: dx=8mm, dy=8mm, dz=5mm

Reference Value = 4.86 V/m

Peak SAR (extrapolated) = 0.085 W/kg

SAR(1 g) = 0.048 mW/g; SAR(10 g) = 0.026 mW/g

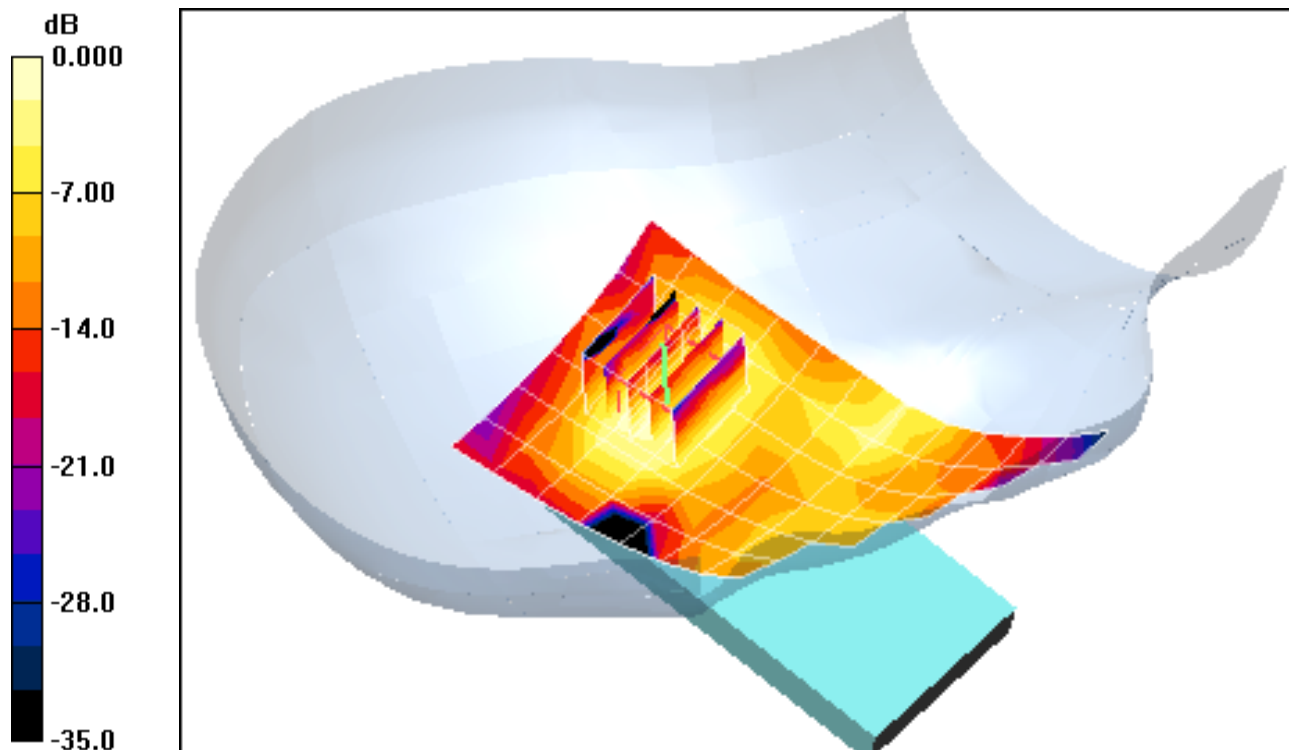

0 dB = 0.061mW/g

PCTEST ENGINEERING LABORATORY, INC.

**DUT: IHDT56MP1; Type: Cellular/PCS CDMA/EVDO Phone
with Bluetooth and WLAN; Serial: Unit C**

Communication System: IEEE 802.11b; Frequency: 2462 MHz; Duty Cycle: 1:1
Medium: 2450 Head Medium parameters used (interpolated):
 $f = 2462 \text{ MHz}$; $\sigma = 1.89 \text{ mho/m}$; $\epsilon_r = 38.7$; $\rho = 1000 \text{ kg/m}^3$
Phantom section: Left Section

Test Date: 05-26-2011; Ambient Temp: 23.4 °C; Tissue Temp: 22.4 °C

Probe: ES3DV2 - SN3022; ConvF(4.21, 4.21, 4.21); Calibrated: 9/21/2010
Sensor-Surface: 3mm (Mechanical Surface Detection)
Electronics: DAE4 Sn704; Calibrated: 3/17/2011
Phantom: SAM with CRP; Type: SAM; Serial: TP1375

Measurement SW: DASY4, V4.7 Build 80; Postprocessing SW: SEMCAD, V1.8 Build 186

Mode: IEEE 802.11b, Left Head, Touch, Ch 11, 1 Mbps, Standard Battery

Area Scan (7x12x1): Measurement grid: dx=15mm, dy=15mm

Zoom Scan (5x5x7)/Cube 0: Measurement grid: dx=8mm, dy=8mm, dz=5mm

Reference Value = 7.90 V/m

Peak SAR (extrapolated) = 0.154 W/kg

SAR(1 g) = 0.091 mW/g; SAR(10 g) = 0.050 mW/g

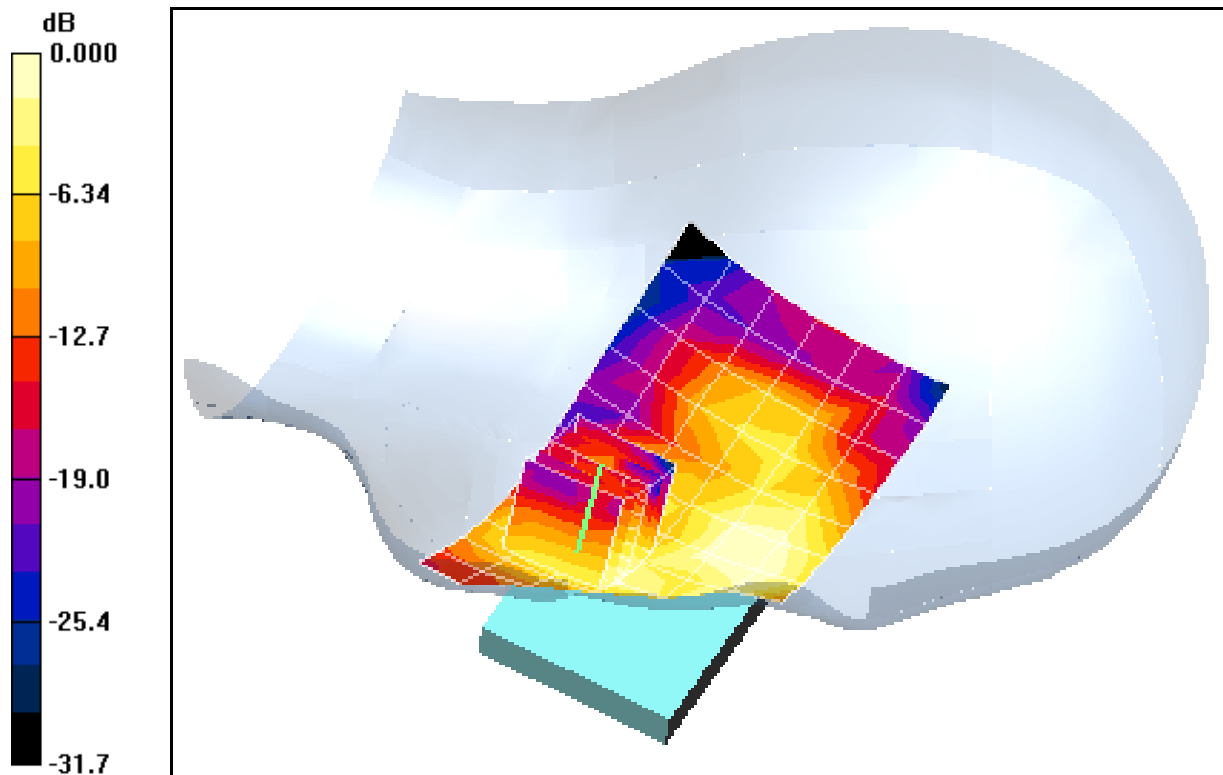

0 dB = 0.107mW/g

PCTEST ENGINEERING LABORATORY, INC.

**DUT: IHDT56MP1; Type: Cellular/PCS CDMA/EVDO Phone
with Bluetooth and WLAN; Serial: Unit C**

Communication System: IEEE 802.11b; Frequency: 2462 MHz; Duty Cycle: 1:1
Medium: 2450 Head Medium parameters used (interpolated):
 $f = 2462 \text{ MHz}$; $\sigma = 1.89 \text{ mho/m}$; $\epsilon_r = 38.7$; $\rho = 1000 \text{ kg/m}^3$
Phantom section: Left Section

Test Date: 05-26-2011; Ambient Temp: 23.4 °C; Tissue Temp: 22.4 °C

Probe: ES3DV2 - SN3022; ConvF(4.21, 4.21, 4.21); Calibrated: 9/21/2010
Sensor-Surface: 3mm (Mechanical Surface Detection)
Electronics: DAE4 Sn704; Calibrated: 3/17/2011
Phantom: SAM with CRP; Type: SAM; Serial: TP1375

Measurement SW: DASY4, V4.7 Build 80; Postprocessing SW: SEMCAD, V1.8 Build 186

Mode: IEEE 802.11b, Left Head, Tilt, Ch 11, 1 Mbps, Standard Battery

Area Scan (7x11x1): Measurement grid: dx=15mm, dy=15mm

Zoom Scan (5x5x7)/Cube 0: Measurement grid: dx=8mm, dy=8mm, dz=5mm

Reference Value = 5.85 V/m

Peak SAR (extrapolated) = 0.102 W/kg

SAR(1 g) = 0.058 mW/g; SAR(10 g) = 0.030 mW/g

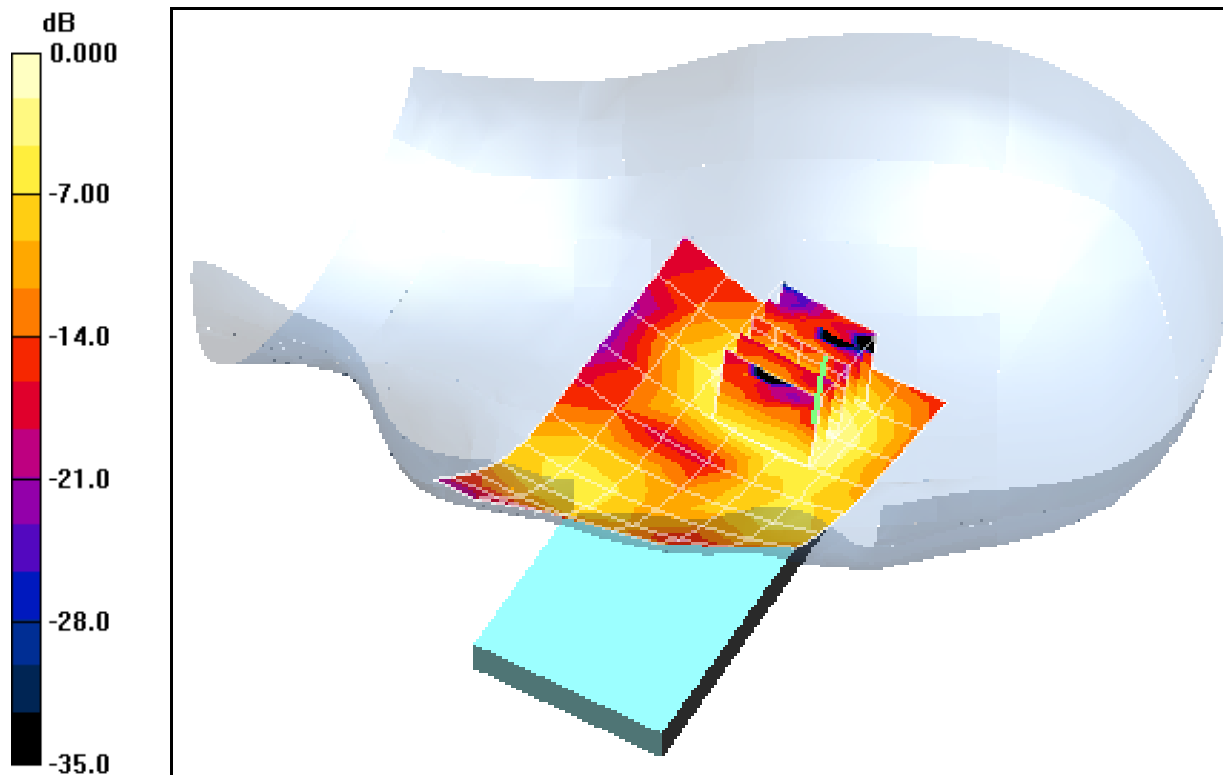

0 dB = 0.069mW/g

PCTEST ENGINEERING LABORATORY, INC.

**DUT: IHDT56MP1; Type: Cellular/PCS CDMA/EVDO Phone
with Bluetooth and WLAN; Serial: Unit X**

Communication System: Cellular CDMA; Frequency: 820.1 MHz; Duty Cycle: 1:1
Medium: 835 Body Medium parameters used (interpolated):
 $f = 820.1$ MHz; $\sigma = 0.952$ mho/m; $\epsilon_r = 53.19$; $\rho = 1000$ kg/m³
Phantom section: Flat Section; Space: 2.5 cm

Test Date: 06-20-2011; Ambient Temp: 23.5 °C; Tissue Temp: 22.2 °C

Probe: EX3DV4 - SN3561; ConvF(8.09, 8.09, 8.09); Calibrated: 8/19/2010

Sensor-Surface: 4mm (Mechanical Surface Detection)

Electronics: DAE4 Sn649; Calibrated: 2/21/2011

Phantom: SAM Main; Type: SAM 4.0; Serial: TP-1406

Measurement SW: DASY4, V4.7 Build 80; Postprocessing SW: SEMCAD, V1.8 Build 186

**Mode: Cellular CDMA - FCC Rule Part 90S, Body SAR,
Back side, Mid.ch, Standard Battery**

Area Scan (7x12x1): Measurement grid: dx=15mm, dy=15mm

Zoom Scan (5x5x7)/Cube 0: Measurement grid: dx=8mm, dy=8mm, dz=5mm

Reference Value = 27.7 V/m

Peak SAR (extrapolated) = 0.862 W/kg

SAR(1 g) = 0.668 mW/g; SAR(10 g) = 0.497 mW/g

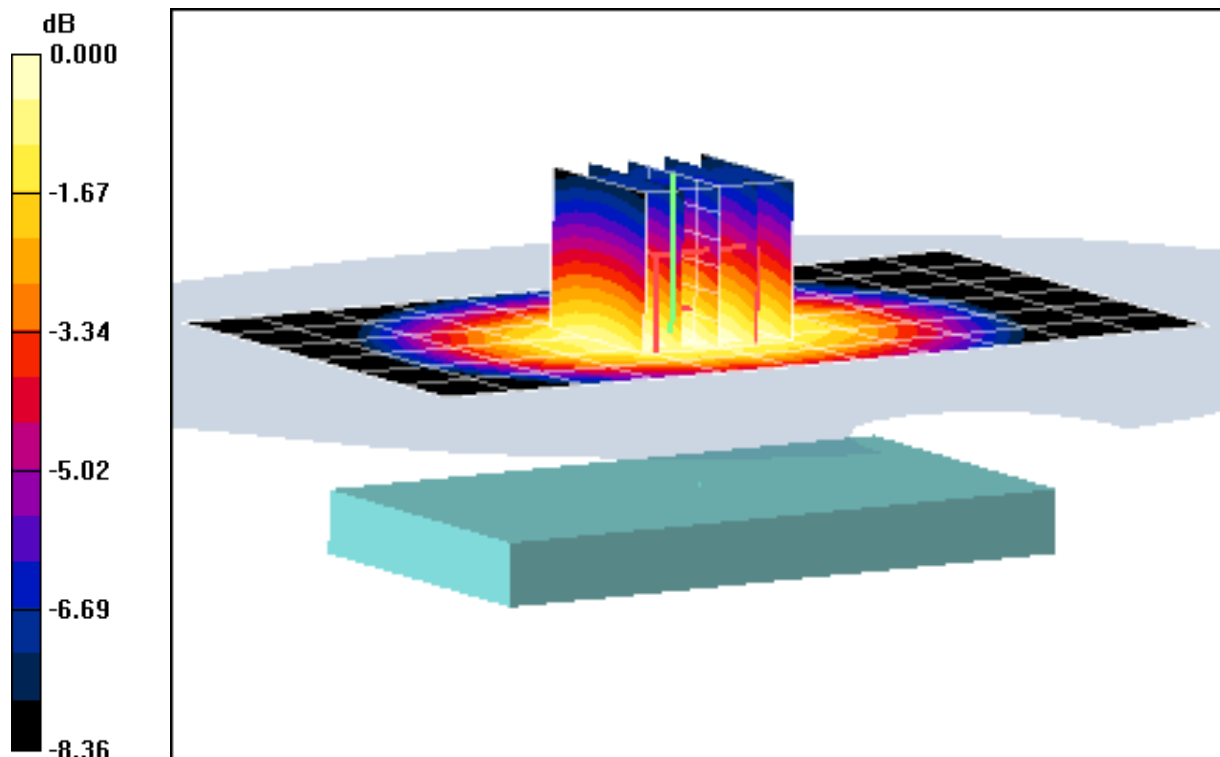

0 dB = 0.703mW/g

PCTEST ENGINEERING LABORATORY, INC.

**DUT: IHDT56MP1; Type: Cellular/PCS CDMA/EVDO Phone
with Bluetooth and WLAN; Serial: Unit Y**

Communication System: Cellular CDMA; Frequency: 820.1 MHz; Duty Cycle: 1:1
Medium: 835 Body Medium parameters used (interpolated):
 $f = 820.1$ MHz; $\sigma = 0.952$ mho/m; $\epsilon_r = 53.19$; $\rho = 1000$ kg/m³
Phantom section: Flat Section; Space: 1.0 cm

Test Date: 06-20-2011; Ambient Temp: 23.5 °C; Tissue Temp: 22.2 °C

Probe: EX3DV4 - SN3561; ConvF(8.09, 8.09, 8.09); Calibrated: 8/19/2010
Sensor-Surface: 4mm (Mechanical Surface Detection)
Electronics: DAE4 Sn649; Calibrated: 2/21/2011
Phantom: SAM Main; Type: SAM 4.0; Serial: TP-1406
Measurement SW: DASY4, V4.7 Build 80; Postprocessing SW: SEMCAD, V1.8 Build 186

**Mode: Cellular EVDO - FCC Rule Part 90S, Body SAR,
Back side, Mid.ch, Standard Battery**

Area Scan (7x12x1): Measurement grid: dx=15mm, dy=15mm
Zoom Scan (5x5x7)/Cube 0: Measurement grid: dx=8mm, dy=8mm, dz=5mm
Reference Value = 37.3 V/m
Peak SAR (extrapolated) = 1.57 W/kg
SAR(1 g) = 1.25 mW/g; SAR(10 g) = 0.914 mW/g

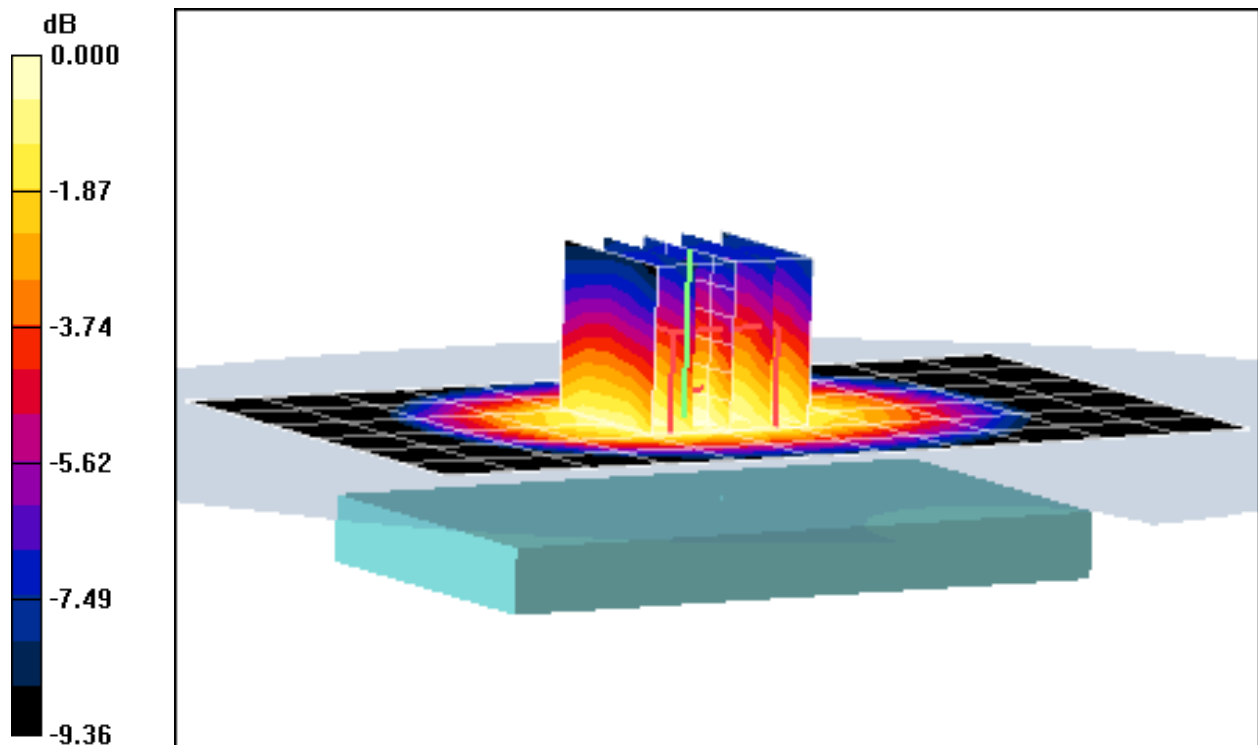

0 dB = 1.34mW/g

PCTEST ENGINEERING LABORATORY, INC.

**DUT: IHDT56MP1; Type: Cellular/PCS CDMA/EVDO Phone
with Bluetooth and WLAN ; Serial: Unit Y**

Communication System: Cellular CDMA; Frequency: 820.1 MHz; Duty Cycle: 1:1
Medium: 835 Body Medium parameters used (interpolated):
 $f = 820.1 \text{ MHz}$; $\sigma = 0.952 \text{ mho/m}$; $\epsilon_r = 53.19$; $\rho = 1000 \text{ kg/m}^3$
Phantom section: Flat Section; Space: 1.0 cm

Test Date: 06-20-2011; Ambient Temp: 23.5 °C; Tissue Temp: 22.2 °C

Probe: EX3DV4 - SN3561; ConvF(8.09, 8.09, 8.09); Calibrated: 8/19/2010
Sensor-Surface: 4mm (Mechanical Surface Detection)
Electronics: DAE4 Sn649; Calibrated: 2/21/2011
Phantom: SAM Main; Type: SAM 4.0; Serial: TP-1406
Measurement SW: DASY4, V4.7 Build 80; Postprocessing SW: SEMCAD, V1.8 Build 186

**Mode: Cellular EVDO - FCC Rule Part 90S, Body SAR,
Front side, Mid.ch, Standard Battery**

Area Scan (7x12x1): Measurement grid: dx=15mm, dy=15mm
Zoom Scan (5x5x7)/Cube 0: Measurement grid: dx=8mm, dy=8mm, dz=5mm
Reference Value = 34.6 V/m
Peak SAR (extrapolated) = 1.47 W/kg
SAR(1 g) = 1.04 mW/g; SAR(10 g) = 0.772 mW/g

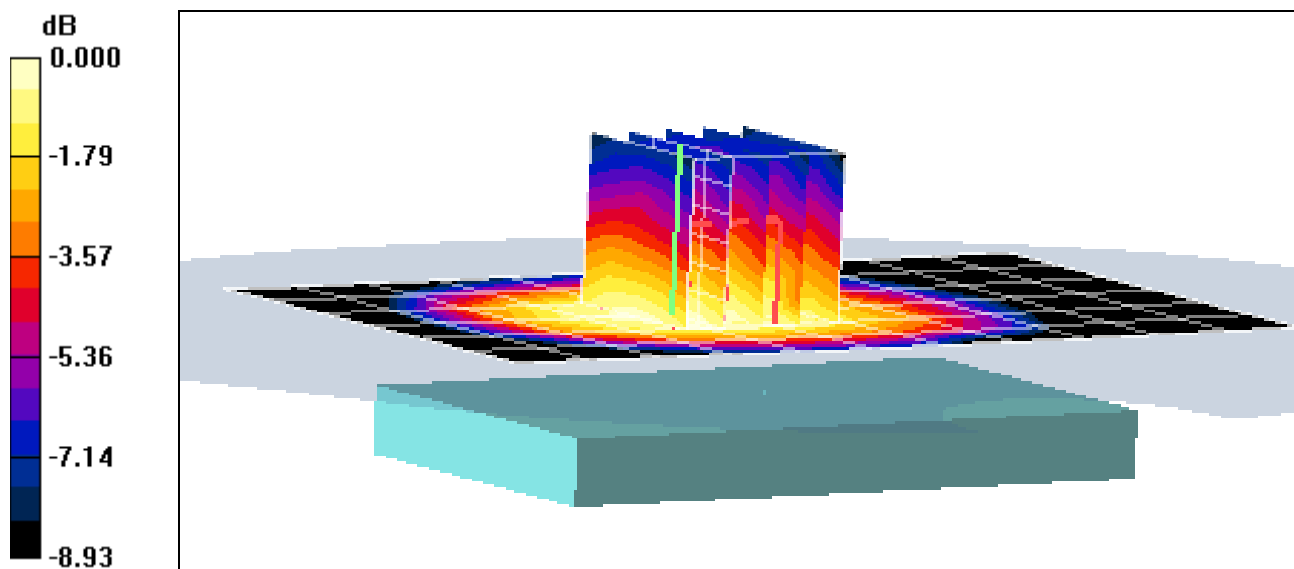

0 dB = 1.10mW/g

PCTEST ENGINEERING LABORATORY, INC.

**DUT: IHDT56MP1; Type: Cellular/PCS CDMA/EVDO Phone
with Bluetooth and WLAN; Serial: Unit Y**

Communication System: Cellular CDMA; Frequency: 820.1 MHz; Duty Cycle: 1:1
Medium: 835 Body Medium parameters used (interpolated):
 $f = 820.1 \text{ MHz}$; $\sigma = 0.952 \text{ mho/m}$; $\epsilon_r = 53.19$; $\rho = 1000 \text{ kg/m}^3$
Phantom section: Flat Section; Space: 1.0 cm

Test Date: 06-20-2011; Ambient Temp: 23.5 °C; Tissue Temp: 22.2 °C

Probe: EX3DV4 - SN3561; ConvF(8.09, 8.09, 8.09); Calibrated: 8/19/2010
Sensor-Surface: 4mm (Mechanical Surface Detection)
Electronics: DAE4 Sn649; Calibrated: 2/21/2011
Phantom: SAM Main; Type: SAM 4.0; Serial: TP-1406
Measurement SW: DASY4, V4.7 Build 80; Postprocessing SW: SEMCAD, V1.8 Build 186

**Mode: Cellular EVDO - FCC Rule Part 90S, Body SAR,
Bottom Edge, Mid.ch, Standard Battery**

Area Scan (5x7x1): Measurement grid: dx=15mm, dy=15mm
Zoom Scan (5x5x7)/Cube 0: Measurement grid: dx=8mm, dy=8mm, dz=5mm
Reference Value = 7.59 V/m
Peak SAR (extrapolated) = 0.076 W/kg
SAR(1 g) = 0.045 mW/g; SAR(10 g) = 0.027 mW/g

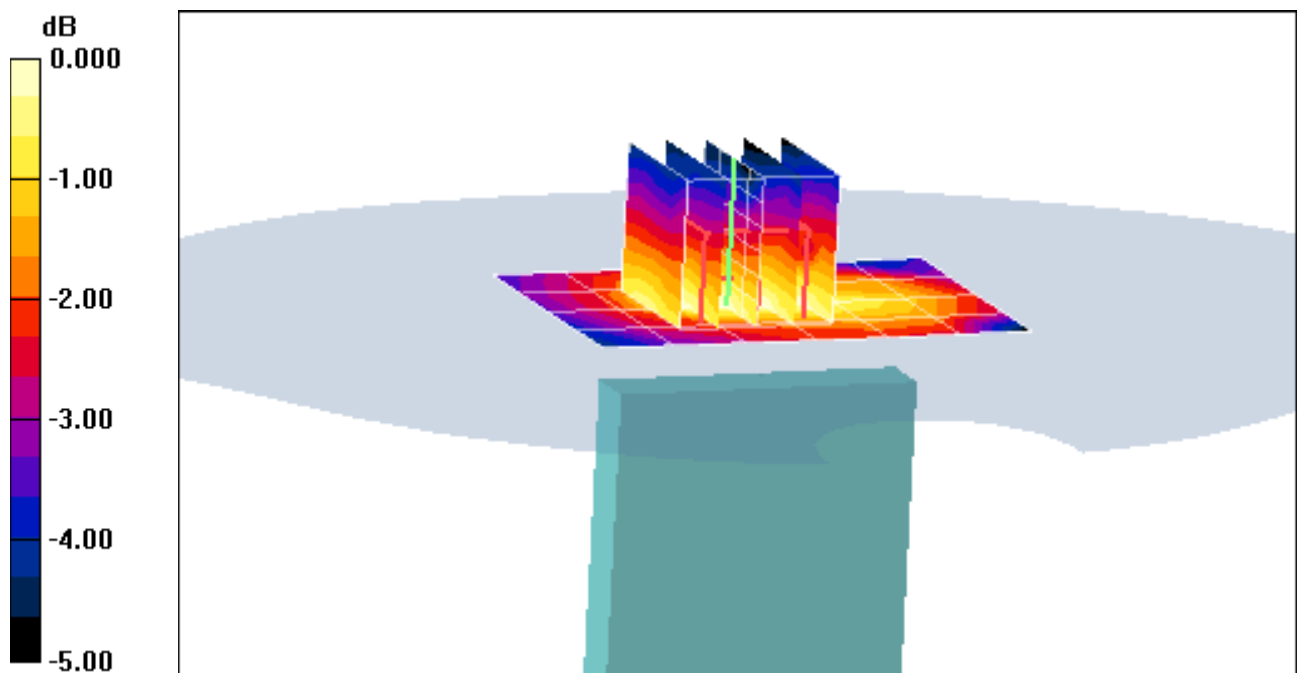

PCTEST ENGINEERING LABORATORY, INC.

**DUT: IHDT56MP1; Type: Cellular/PCS CDMA/EVDO Phone
with Bluetooth and WLAN ; Serial: Unit Y**

Communication System: Cellular CDMA; Frequency: 820.1 MHz; Duty Cycle: 1:1
Medium: 835 Body Medium parameters used (interpolated):
 $f = 820.1 \text{ MHz}$; $\sigma = 0.952 \text{ mho/m}$; $\epsilon_r = 53.19$; $\rho = 1000 \text{ kg/m}^3$
Phantom section: Flat Section; Space: 1.0 cm

Test Date: 06-20-2011; Ambient Temp: 23.5 °C; Tissue Temp: 22.2 °C

Probe: EX3DV4 - SN3561; ConvF(8.09, 8.09, 8.09); Calibrated: 8/19/2010
Sensor-Surface: 4mm (Mechanical Surface Detection)
Electronics: DAE4 Sn649; Calibrated: 2/21/2011
Phantom: SAM Main; Type: SAM 4.0; Serial: TP-1406
Measurement SW: DASY4, V4.7 Build 80; Postprocessing SW: SEMCAD, V1.8 Build 186

**Mode: Cellular EVDO - FCC Rule Part 90S, Body SAR,
Right Edge, Mid.ch, Standard Battery**

Area Scan (5x13x1): Measurement grid: dx=15mm, dy=15mm
Zoom Scan (5x5x7)/Cube 0: Measurement grid: dx=8mm, dy=8mm, dz=5mm
Reference Value = 29.5 V/m
Peak SAR (extrapolated) = 1.24 W/kg
SAR(1 g) = 0.833 mW/g; SAR(10 g) = 0.582 mW/g

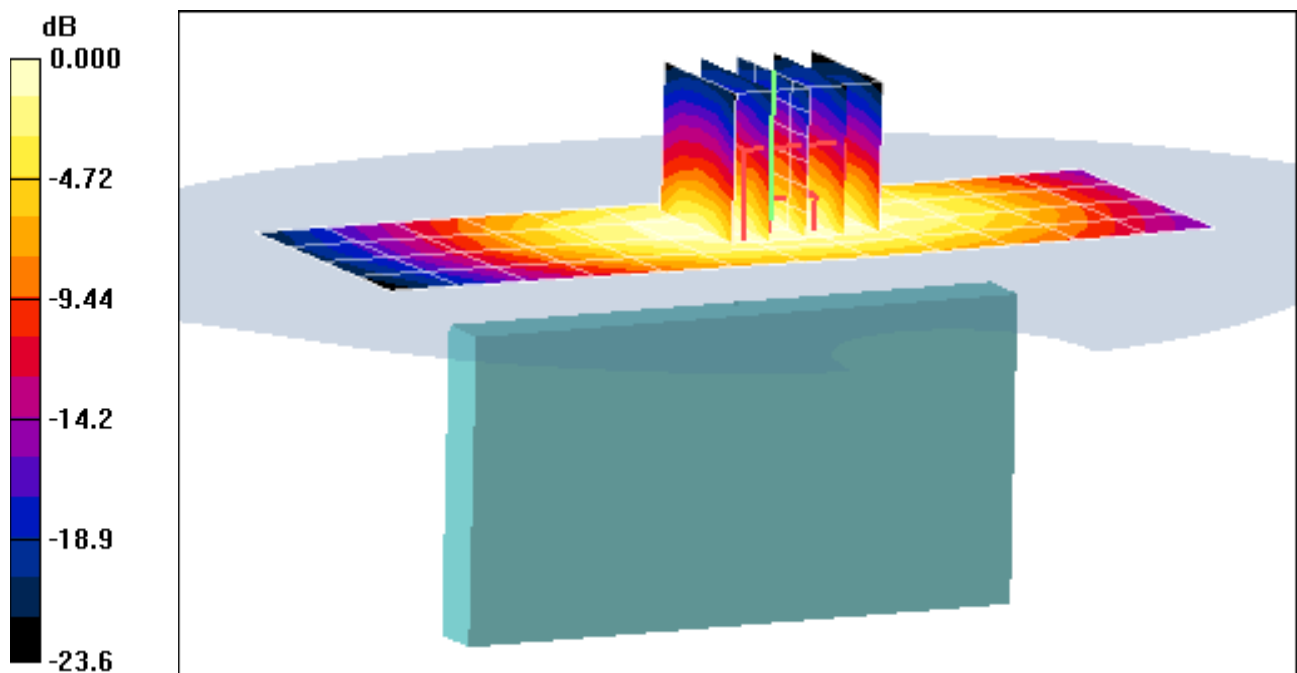

0 dB = 0.822mW/g

PCTEST ENGINEERING LABORATORY, INC.

**DUT: IHDT56MP1; Type: Cellular/PCS CDMA/EVDO Phone
with Bluetooth and WLAN; Serial: Unit Y**

Communication System: Cellular CDMA; Frequency: 820.1 MHz; Duty Cycle: 1:1
Medium: 835 Body Medium parameters used (interpolated):
 $f = 820.1 \text{ MHz}$; $\sigma = 0.952 \text{ mho/m}$; $\epsilon_r = 53.19$; $\rho = 1000 \text{ kg/m}^3$
Phantom section: Flat Section; Space: 1.0 cm

Test Date: 06-20-2011; Ambient Temp: 23.5 °C; Tissue Temp: 22.2 °C

Probe: EX3DV4 - SN3561; ConvF(8.09, 8.09, 8.09); Calibrated: 8/19/2010
Sensor-Surface: 4mm (Mechanical Surface Detection)
Electronics: DAE4 Sn649; Calibrated: 2/21/2011
Phantom: SAM Main; Type: SAM 4.0; Serial: TP-1406
Measurement SW: DASY4, V4.7 Build 80; Postprocessing SW: SEMCAD, V1.8 Build 186

**Mode: Cellular EVDO - FCC Rule Part 90S, Body SAR,
Left Edge, Mid.ch, Standard Battery**

Area Scan (5x13x1): Measurement grid: dx=15mm, dy=15mm
Zoom Scan (5x5x7)/Cube 0: Measurement grid: dx=8mm, dy=8mm, dz=5mm
Reference Value = 31.2 V/m
Peak SAR (extrapolated) = 1.13 W/kg
SAR(1 g) = 0.778 mW/g; SAR(10 g) = 0.541 mW/g

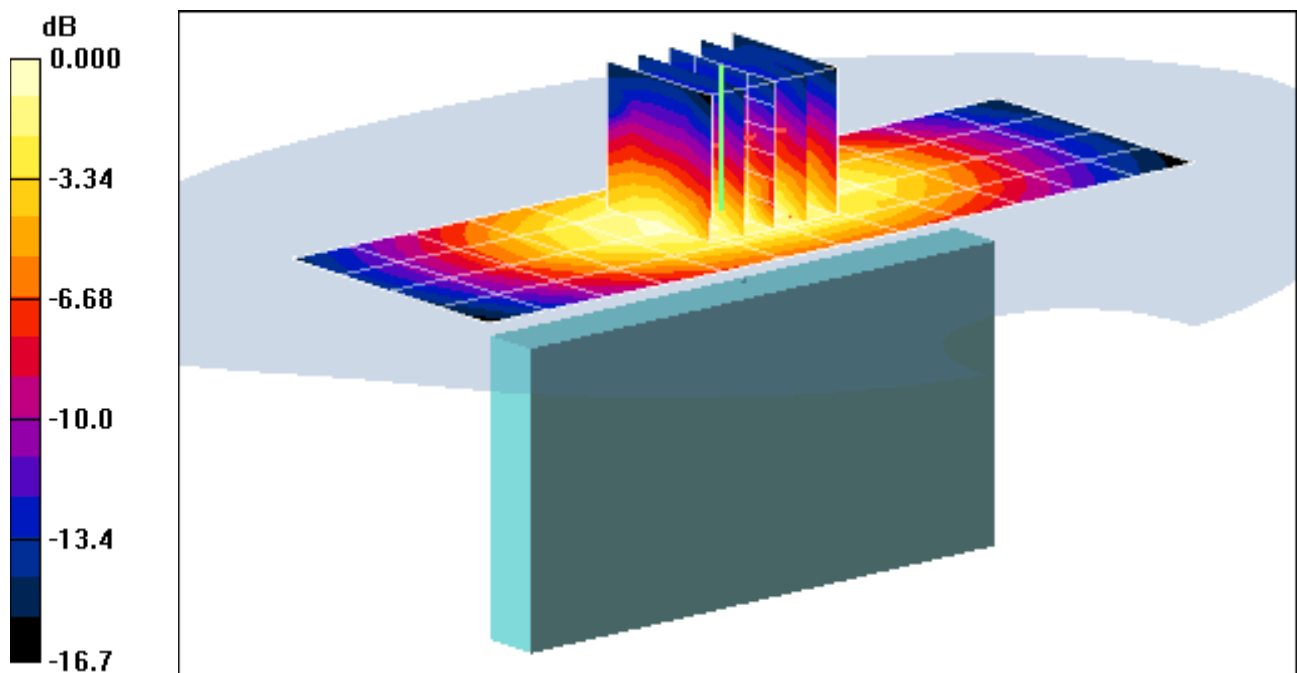

0 dB = 0.891mW/g

PCTEST ENGINEERING LABORATORY, INC.

**DUT: IHDT56MP1; Type: Cellular/PCS CDMA/EVDO Phone
with Bluetooth and WLAN; Serial: Unit X**

Communication System: Cellular CDMA; Frequency: 836.52 MHz; Duty Cycle: 1:1
Medium: 835 Body Medium parameters used (interpolated):
 $f = 836.52 \text{ MHz}$; $\sigma = 0.981 \text{ mho/m}$; $\epsilon_r = 53$; $\rho = 1000 \text{ kg/m}^3$
Phantom section: Flat Section; Space: 2.5 cm

Test Date: 06-20-2011; Ambient Temp: 23.5 °C; Tissue Temp: 22.2 °C

Probe: EX3DV4 - SN3561; ConvF(8.09, 8.09, 8.09); Calibrated: 8/19/2010
Sensor-Surface: 4mm (Mechanical Surface Detection)
Electronics: DAE4 Sn649; Calibrated: 2/21/2011
Phantom: SAM Main; Type: SAM 4.0; Serial: TP-1406
Measurement SW: DASY4, V4.7 Build 80; Postprocessing SW: SEMCAD, V1.8 Build 186

**Mode: Cellular CDMA - FCC Rule Part 22H, Body SAR,
Back side, Mid.ch, Standard Battery**

Area Scan (7x12x1): Measurement grid: dx=15mm, dy=15mm
Zoom Scan (5x5x7)/Cube 0: Measurement grid: dx=8mm, dy=8mm, dz=5mm
Reference Value = 28.5 V/m
Peak SAR (extrapolated) = 0.952 W/kg
SAR(1 g) = 0.732 mW/g; SAR(10 g) = 0.543 mW/g

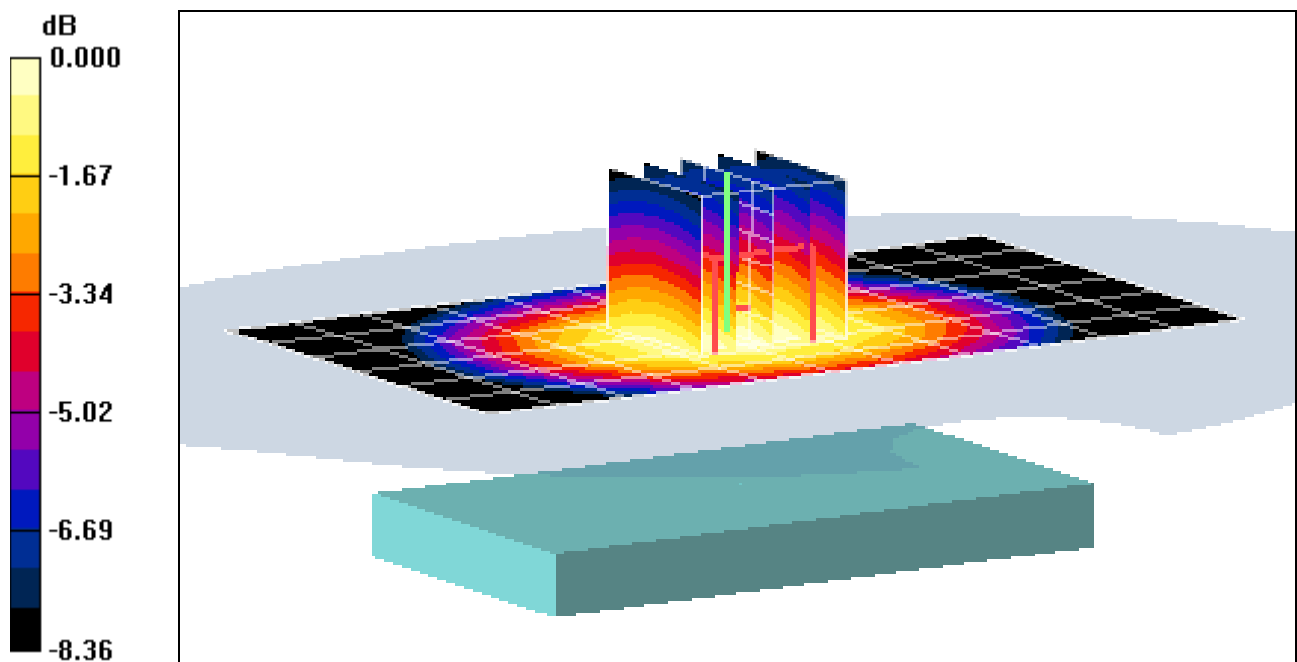

0 dB = 0.769mW/g

PCTEST ENGINEERING LABORATORY, INC.

**DUT: IHDT56MP1; Type: Cellular/PCS CDMA/EVDO Phone
with Bluetooth and WLAN; Serial: Unit Y**

Communication System: Cellular CDMA; Frequency: 836.52 MHz; Duty Cycle: 1:1
Medium: 835 Body Medium parameters used (interpolated):
 $f = 836.52 \text{ MHz}$; $\sigma = 0.981 \text{ mho/m}$; $\epsilon_r = 53$; $\rho = 1000 \text{ kg/m}^3$
Phantom section: Flat Section; Space: 1.0 cm

Test Date: 06-20-2011; Ambient Temp: 23.5 °C; Tissue Temp: 22.2 °C

Probe: EX3DV4 - SN3561; ConvF(8.09, 8.09, 8.09); Calibrated: 8/19/2010
Sensor-Surface: 4mm (Mechanical Surface Detection)
Electronics: DAE4 Sn649; Calibrated: 2/21/2011
Phantom: SAM Main; Type: SAM 4.0; Serial: TP-1406
Measurement SW: DASY4, V4.7 Build 80; Postprocessing SW: SEMCAD, V1.8 Build 186

**Mode: Cellular EVDO - FCC Rule Part 22H, Body SAR,
Back side, Mid.ch, Standard Battery**

Area Scan (7x12x1): Measurement grid: dx=15mm, dy=15mm
Zoom Scan (5x5x7)/Cube 0: Measurement grid: dx=8mm, dy=8mm, dz=5mm
Reference Value = 40.0 V/m
Peak SAR (extrapolated) = 1.75 W/kg
SAR(1 g) = 1.37 mW/g; SAR(10 g) = 1.02 mW/g

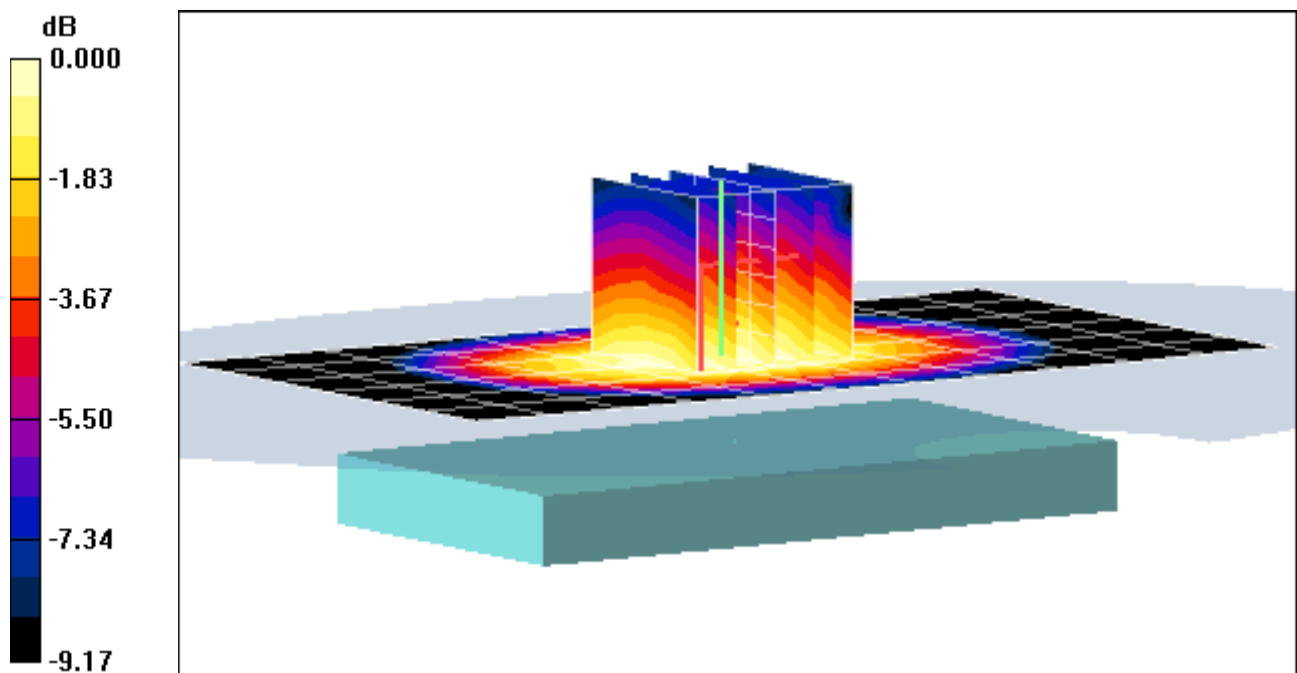

0 dB = 1.45mW/g

PCTEST ENGINEERING LABORATORY, INC.

**DUT: IHDT56MP1; Type: Cellular/PCS CDMA/EVDO Phone
with Bluetooth and WLAN; Serial: Unit Y**

Communication System: Cellular CDMA; Frequency: 836.52 MHz; Duty Cycle: 1:1
Medium: 835 Body Medium parameters used (interpolated):
 $f = 836.52 \text{ MHz}$; $\sigma = 0.981 \text{ mho/m}$; $\epsilon_r = 53$; $\rho = 1000 \text{ kg/m}^3$
Phantom section: Flat Section; Space: 1.0 cm

Test Date: 06-20-2011; Ambient Temp: 23.5 °C; Tissue Temp: 22.2 °C

Probe: EX3DV4 - SN3561; ConvF(8.09, 8.09, 8.09); Calibrated: 8/19/2010
Sensor-Surface: 4mm (Mechanical Surface Detection)
Electronics: DAE4 Sn649; Calibrated: 2/21/2011
Phantom: SAM Main; Type: SAM 4.0; Serial: TP-1406
Measurement SW: DASY4, V4.7 Build 80; Postprocessing SW: SEMCAD, V1.8 Build 186

**Mode: Cellular EVDO - FCC Rule Part 22H, Body SAR,
Back side, Mid.ch, Standard Battery**

Area Scan (7x12x1): Measurement grid: dx=15mm, dy=15mm
Zoom Scan (5x5x7)/Cube 0: Measurement grid: dx=8mm, dy=8mm, dz=5mm
Reference Value = 40.0 V/m
Peak SAR (extrapolated) = 1.75 W/kg
SAR(1 g) = 1.37 mW/g; SAR(10 g) = 1.02 mW/g

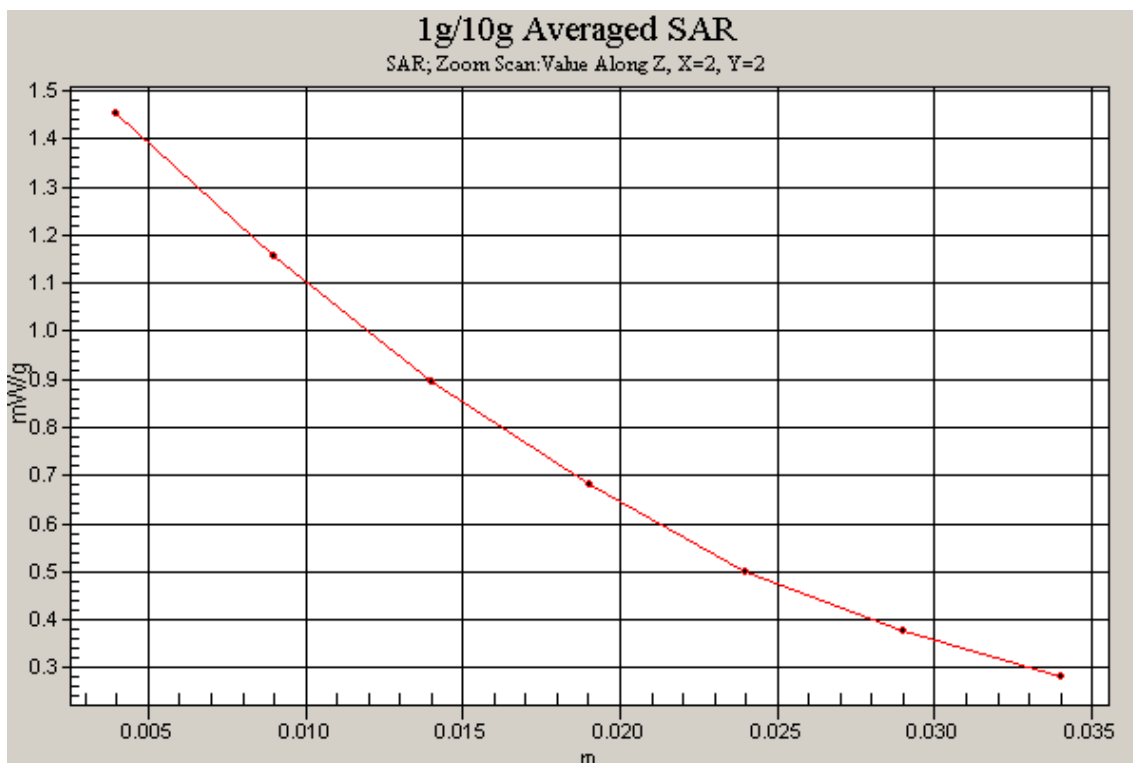

PCTEST ENGINEERING LABORATORY, INC.

**DUT: IHDT56MP1; Type: Cellular/PCS CDMA/EvDO Phone
with Bluetooth and WLAN ; Serial: Unit Y**

Communication System: Cellular CDMA; Frequency: 848.31 MHz; Duty Cycle: 1:1
Medium: 835 Body Medium parameters used (interpolated):
 $f = 848.31 \text{ MHz}$; $\sigma = 0.992 \text{ mho/m}$; $\epsilon_r = 53$; $\rho = 1000 \text{ kg/m}^3$
Phantom section: Flat Section; Space: 1.0 cm

Test Date: 06-20-2011; Ambient Temp: 23.5 °C; Tissue Temp: 22.2 °C

Probe: EX3DV4 - SN3561; ConvF(8.09, 8.09, 8.09); Calibrated: 8/19/2010
Sensor-Surface: 4mm (Mechanical Surface Detection)
Electronics: DAE4 Sn649; Calibrated: 2/21/2011
Phantom: SAM Main; Type: SAM 4.0; Serial: TP-1406
Measurement SW: DASY4, V4.7 Build 80; Postprocessing SW: SEMCAD, V1.8 Build 186

**Mode: Cellular EVDO - FCC Rule Part 22H, Body SAR
Front side, High.ch, Standard Battery**

Area Scan (7x12x1): Measurement grid: dx=15mm, dy=15mm
Zoom Scan (5x5x7)/Cube 0: Measurement grid: dx=8mm, dy=8mm, dz=5mm
Reference Value = 35.1 V/m
Peak SAR (extrapolated) = 1.37 W/kg
SAR(1 g) = 1.07 mW/g; SAR(10 g) = 0.810 mW/g

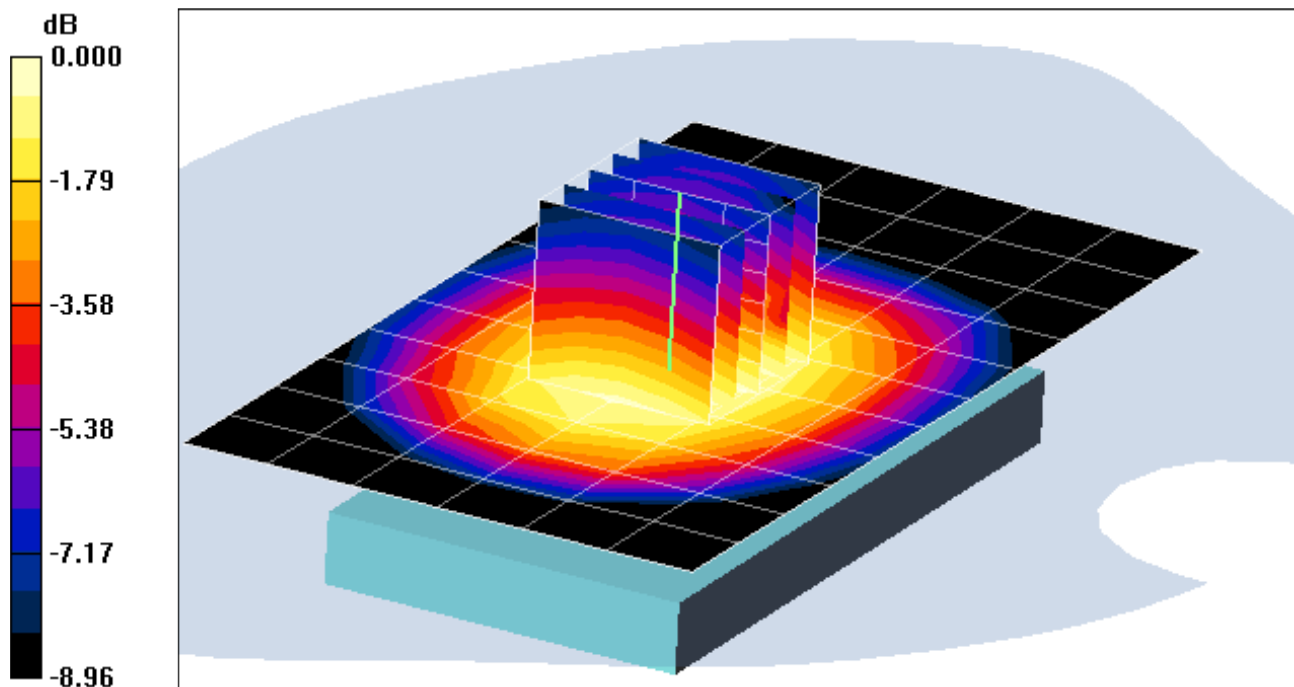

0 dB = 1.12mW/g

PCTEST ENGINEERING LABORATORY, INC.

**DUT: IHDT56MP1; Type: Cellular/PCS CDMA/EVDO Phone
with Bluetooth and WLAN ; Serial: Unit Y**

Communication System: Cellular CDMA; Frequency: 836.52 MHz; Duty Cycle: 1:1
Medium: 835 Body Medium parameters used (interpolated):
 $f = 836.52 \text{ MHz}$; $\sigma = 0.981 \text{ mho/m}$; $\epsilon_r = 53$; $\rho = 1000 \text{ kg/m}^3$
Phantom section: Flat Section; Space: 1.0 cm

Test Date: 06-20-2011; Ambient Temp: 23.5 °C; Tissue Temp: 22.2 °C

Probe: EX3DV4 - SN3561; ConvF(8.09, 8.09, 8.09); Calibrated: 8/19/2010
Sensor-Surface: 4mm (Mechanical Surface Detection)
Electronics: DAE4 Sn649; Calibrated: 2/21/2011
Phantom: SAM Main; Type: SAM 4.0; Serial: TP-1406
Measurement SW: DASY4, V4.7 Build 80; Postprocessing SW: SEMCAD, V1.8 Build 186

**Mode: Cellular EVDO - FCC Rule Part 22H, Body SAR,
Bottom Edge, Mid.ch, Standard Battery**

Area Scan (5x7x1): Measurement grid: dx=15mm, dy=15mm
Zoom Scan (5x5x7)/Cube 0: Measurement grid: dx=8mm, dy=8mm, dz=5mm
Reference Value = 7.88 V/m
Peak SAR (extrapolated) = 0.091 W/kg
SAR(1 g) = 0.051 mW/g; SAR(10 g) = 0.030 mW/g

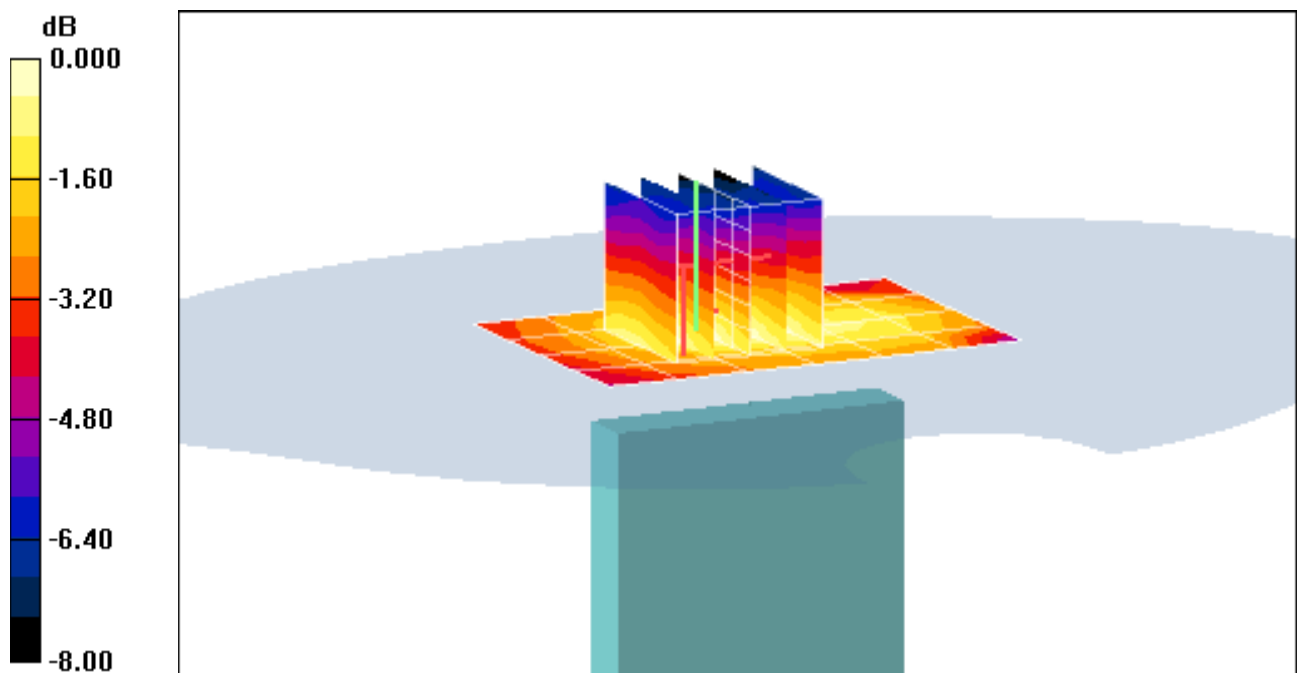

0 dB = 0.056mW/g

PCTEST ENGINEERING LABORATORY, INC.

**DUT: IHDT56MP1; Type: Cellular/PCS CDMA/EVDO Phone
with Bluetooth and WLAN; Serial: Unit Y**

Communication System: Cellular CDMA; Frequency: 836.52 MHz; Duty Cycle: 1:1
Medium: 835 Body Medium parameters used (interpolated):
 $f = 836.52 \text{ MHz}$; $\sigma = 0.981 \text{ mho/m}$; $\epsilon_r = 53$; $\rho = 1000 \text{ kg/m}^3$
Phantom section: Flat Section; Space: 1.0 cm

Test Date: 06-20-2011; Ambient Temp: 23.5 °C; Tissue Temp: 22.2 °C

Probe: EX3DV4 - SN3561; ConvF(8.09, 8.09, 8.09); Calibrated: 8/19/2010
Sensor-Surface: 4mm (Mechanical Surface Detection)
Electronics: DAE4 Sn649; Calibrated: 2/21/2011
Phantom: SAM Main; Type: SAM 4.0; Serial: TP-1406
Measurement SW: DASY4, V4.7 Build 80; Postprocessing SW: SEMCAD, V1.8 Build 186

**Mode: Cellular EVDO - FCC Rule Part 22H, Body SAR,
Right Edge, Mid.ch, Standard Battery**

Area Scan (5x13x1): Measurement grid: dx=15mm, dy=15mm
Zoom Scan (5x5x7)/Cube 0: Measurement grid: dx=8mm, dy=8mm, dz=5mm
Reference Value = 33.4 V/m
Peak SAR (extrapolated) = 1.27 W/kg
SAR(1 g) = 0.949 mW/g; SAR(10 g) = 0.678 mW/g

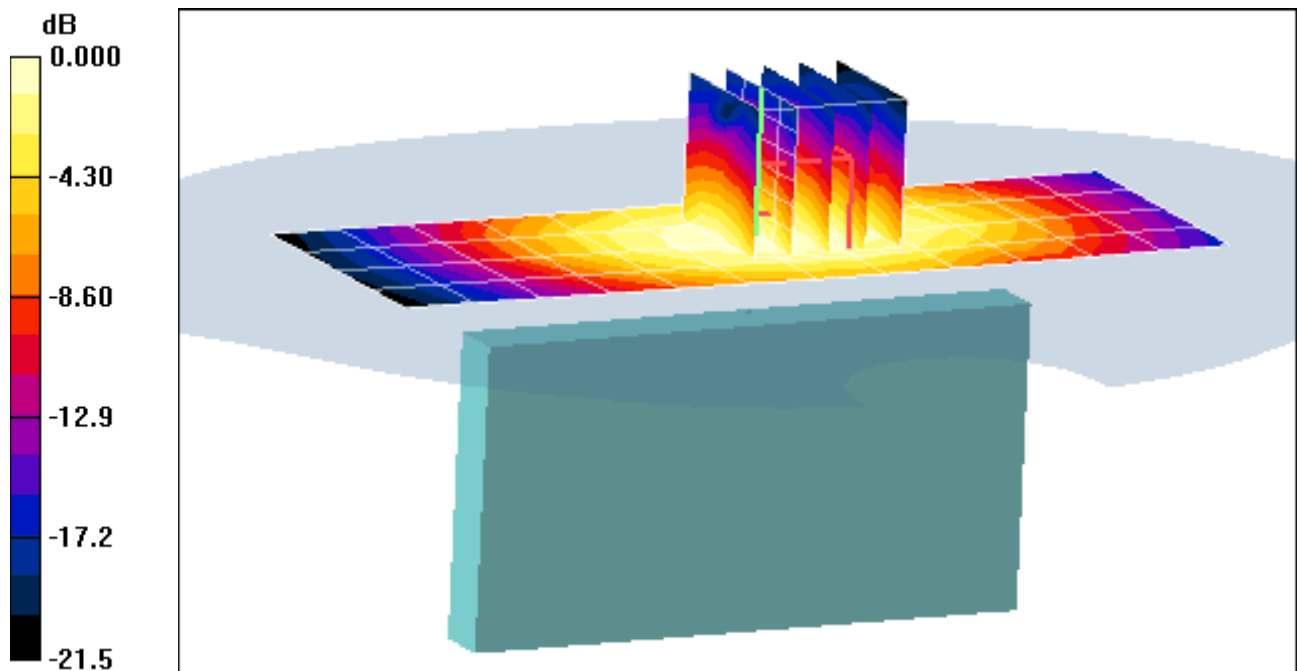

0 dB = 1.03mW/g

PCTEST ENGINEERING LABORATORY, INC.

**DUT: IHDT56MP1; Type: Cellular/PCS CDMA/EVDO Phone
with Bluetooth and WLAN; Serial: Unit Y**

Communication System: Cellular CDMA; Frequency: 836.52 MHz; Duty Cycle: 1:1
Medium: 835 Body Medium parameters used (interpolated):
 $f = 836.52 \text{ MHz}$; $\sigma = 0.981 \text{ mho/m}$; $\epsilon_r = 53$; $\rho = 1000 \text{ kg/m}^3$
Phantom section: Flat Section; Space: 1.0 cm

Test Date: 06-20-2011; Ambient Temp: 23.5 °C; Tissue Temp: 22.2 °C

Probe: EX3DV4 - SN3561; ConvF(8.09, 8.09, 8.09); Calibrated: 8/19/2010
Sensor-Surface: 4mm (Mechanical Surface Detection)
Electronics: DAE4 Sn649; Calibrated: 2/21/2011
Phantom: SAM Main; Type: SAM 4.0; Serial: TP-1406
Measurement SW: DASY4, V4.7 Build 80; Postprocessing SW: SEMCAD, V1.8 Build 186

**Mode: Cellular EVDO - FCC Rule Part 22H, Body SAR,
Left Edge, Mid.ch, Standard Battery**

Area Scan (5x13x1): Measurement grid: dx=15mm, dy=15mm
Zoom Scan (5x5x7)/Cube 0: Measurement grid: dx=8mm, dy=8mm, dz=5mm
Reference Value = 31.2 V/m
Peak SAR (extrapolated) = 1.27 W/kg
SAR(1 g) = 0.855 mW/g; SAR(10 g) = 0.596 mW/g

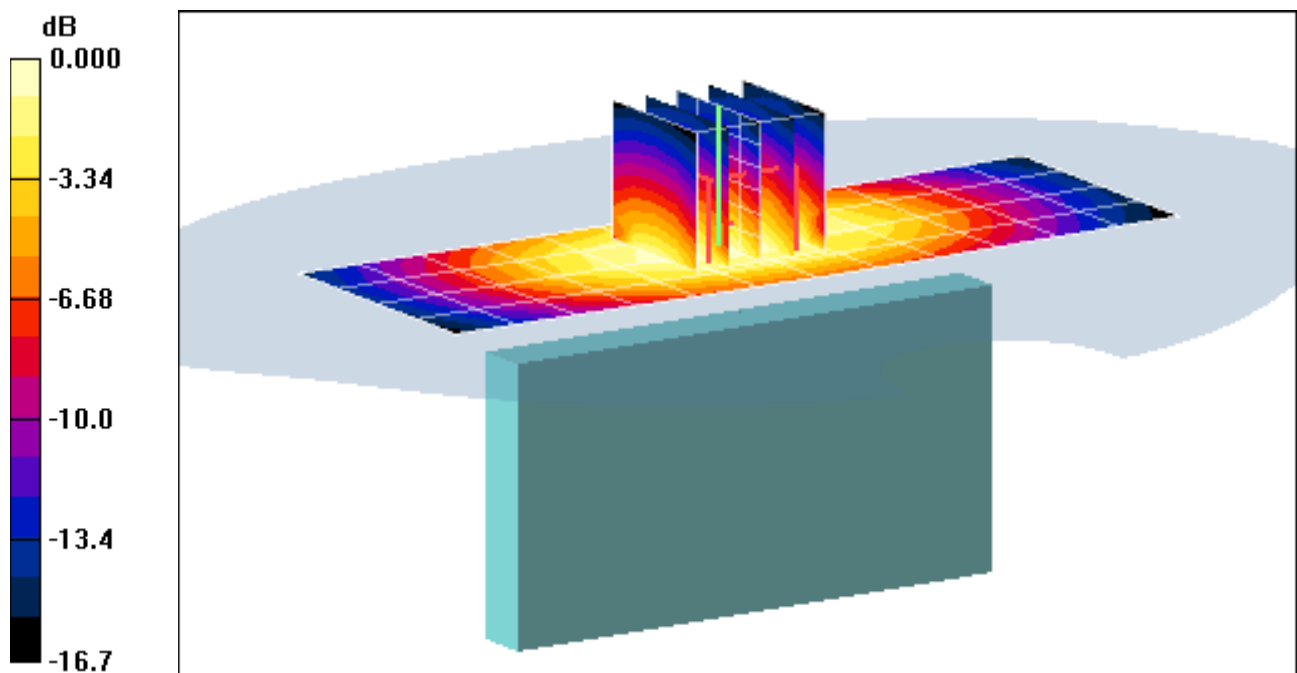

0 dB = 0.891mW/g

PCTEST ENGINEERING LABORATORY, INC.

**DUT: IHDT56MP1; Type: Cellular/PCS CDMA/EVDO Phone
with Bluetooth and WLAN; Serial: Unit X**

Communication System: PCS CDMA; Frequency: 1880 MHz; Duty Cycle: 1:1

Medium: 1900 Body Medium parameters used:

$f = 1880 \text{ MHz}$; $\sigma = 1.501 \text{ mho/m}$; $\epsilon_r = 51.4$; $\rho = 1000 \text{ kg/m}^3$

Phantom section: Flat Section; Space: 2.5 cm

Test Date: 06-22-2011; Ambient Temp: 24.1 °C; Tissue Temp: 22.6 °C

Probe: EX3DV4 - SN3550; ConvF(6.77, 6.77, 6.77); Calibrated: 2/14/2011

Sensor-Surface: 4mm (Mechanical Surface Detection)

Electronics: DAE4 Sn665; Calibrated: 4/20/2011

Phantom: SAM Sub; Type: SAM 4.0; Serial: TP-1357

Measurement SW: DASY4, V4.7 Build 80; Postprocessing SW: SEMCAD, V1.8 Build 186

Mode: PCS CDMA, Body SAR, Back side, Mid.ch, Standard Battery

Area Scan (7x11x1): Measurement grid: dx=15mm, dy=15mm

Zoom Scan (5x5x7)/Cube 0: Measurement grid: dx=8mm, dy=8mm, dz=5mm

Reference Value = 16.0 V/m

Peak SAR (extrapolated) = 0.686 W/kg

SAR(1 g) = 0.439 mW/g; SAR(10 g) = 0.268 mW/g

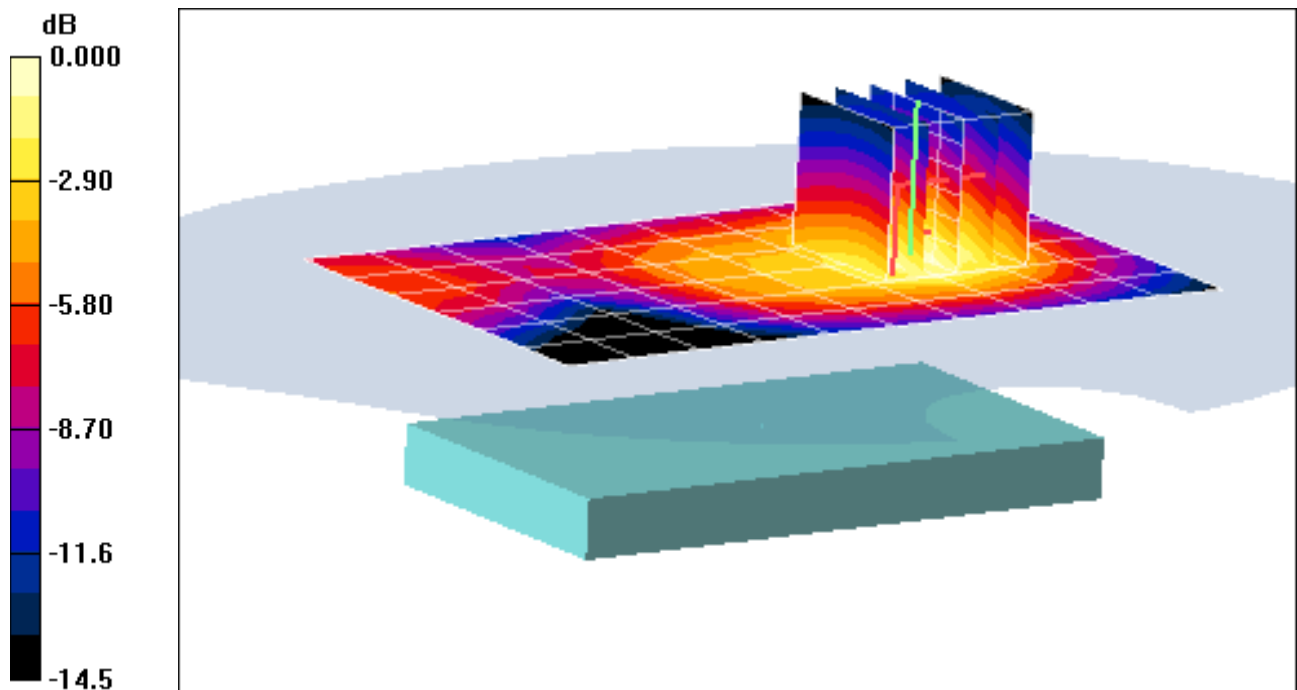

0 dB = 0.478mW/g

PCTEST ENGINEERING LABORATORY, INC.

**DUT: IHDT56MP1; Type: Cellular/PCS CDMA/EVDO Phone
with Bluetooth and WLAN; Serial: Unit Y**

Communication System: PCS CDMA; Frequency: 1880 MHz; Duty Cycle: 1:1
Medium: 1900 Body Medium parameters used:

$f = 1880 \text{ MHz}$; $\sigma = 1.501 \text{ mho/m}$; $\epsilon_r = 51.4$; $\rho = 1000 \text{ kg/m}^3$

Phantom section: Flat Section; Space: 1.0 cm

Test Date: 06-22-2011; Ambient Temp: 24.1 °C; Tissue Temp: 22.6 °C

Probe: EX3DV4 - SN3550; ConvF(6.77, 6.77, 6.77); Calibrated: 2/14/2011

Sensor-Surface: 4mm (Mechanical Surface Detection)

Electronics: DAE4 Sn665; Calibrated: 4/20/2011

Phantom: SAM Sub; Type: SAM 4.0; Serial: TP-1357

Measurement SW: DASY4, V4.7 Build 80; Postprocessing SW: SEMCAD, V1.8 Build 186

Mode: PCS EVDO, Body SAR, Back side, Mid.ch, Standard Battery

Area Scan (7x11x1): Measurement grid: dx=15mm, dy=15mm

Zoom Scan (5x5x7)/Cube 0: Measurement grid: dx=8mm, dy=8mm, dz=5mm

Reference Value = 21.5 V/m

Peak SAR (extrapolated) = 1.13 W/kg

SAR(1 g) = 0.624 mW/g; SAR(10 g) = 0.317 mW/g

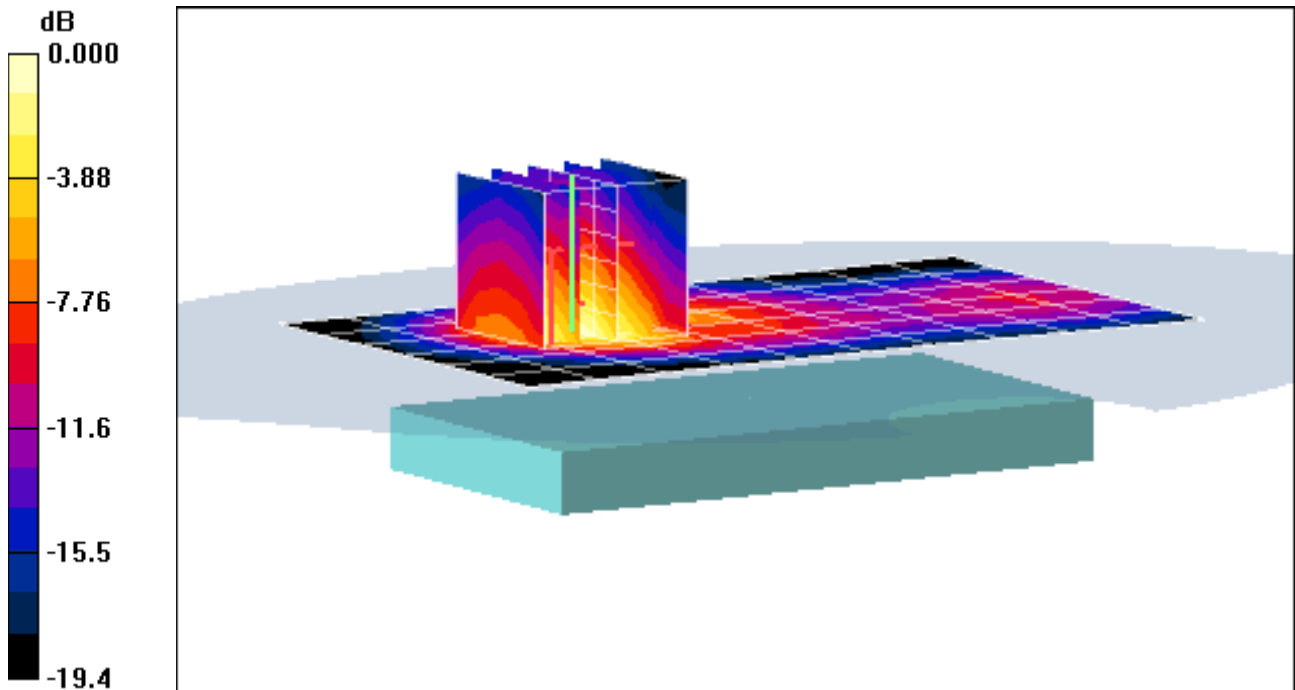

0 dB = 0.706mW/g

PCTEST ENGINEERING LABORATORY, INC.

**DUT: IHDT56MP1; Type: Cellular/PCS CDMA/EVDO Phone
with Bluetooth and WLAN; Serial: Unit Y**

Communication System: PCS CDMA; Frequency: 1880 MHz; Duty Cycle: 1:1

Medium: 1900 Body Medium parameters used:

$f = 1880 \text{ MHz}$; $\sigma = 1.501 \text{ mho/m}$; $\epsilon_r = 51.4$; $\rho = 1000 \text{ kg/m}^3$

Phantom section: Flat Section; Space: 1.0 cm

Test Date: 06-22-2011; Ambient Temp: 24.1 °C; Tissue Temp: 22.6 °C

Probe: EX3DV4 - SN3550; ConvF(6.77, 6.77, 6.77); Calibrated: 2/14/2011

Sensor-Surface: 4mm (Mechanical Surface Detection)

Electronics: DAE4 Sn665; Calibrated: 4/20/2011

Phantom: SAM Sub; Type: SAM 4.0; Serial: TP-1357

Measurement SW: DASY4, V4.7 Build 80; Postprocessing SW: SEMCAD, V1.8 Build 186

Mode: PCS EVDO, Body SAR, Front side, Mid.ch, Standard Battery

Area Scan (7x11x1): Measurement grid: dx=15mm, dy=15mm

Zoom Scan (5x5x7)/Cube 0: Measurement grid: dx=8mm, dy=8mm, dz=5mm

Reference Value = 17.8 V/m

Peak SAR (extrapolated) = 0.702 W/kg

SAR(1 g) = 0.417 mW/g; SAR(10 g) = 0.222 mW/g

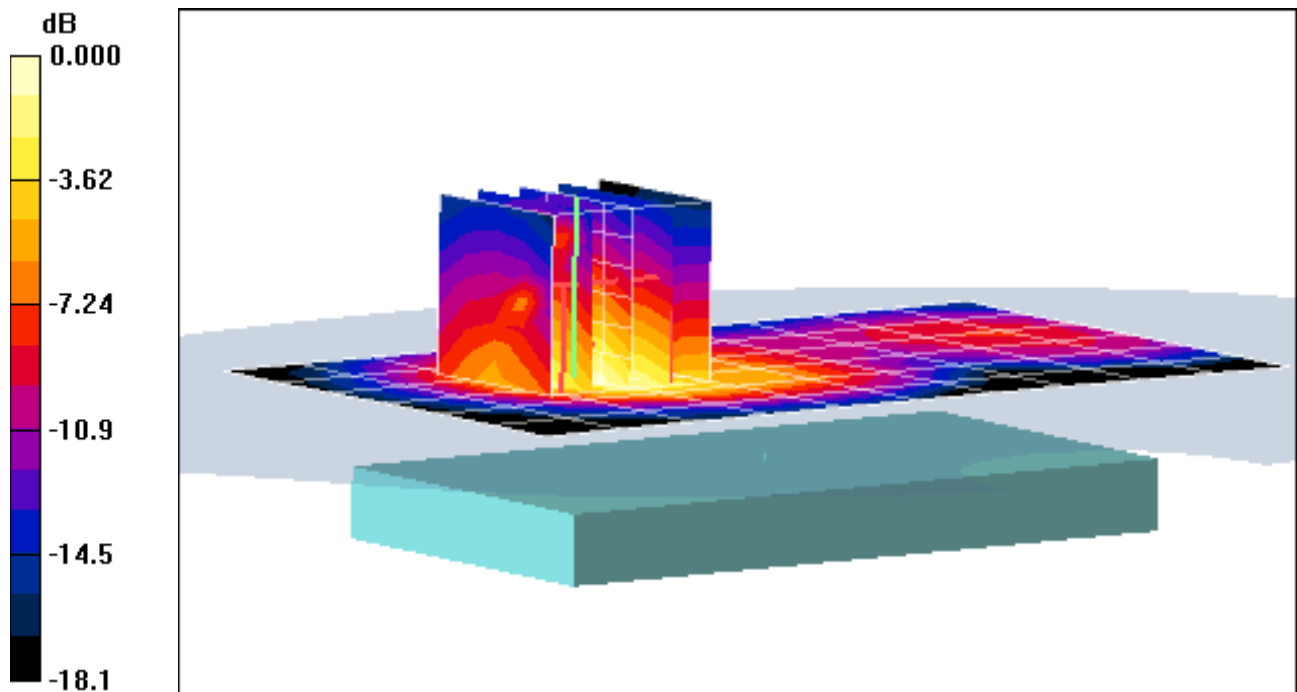

0 dB = 0.479mW/g

PCTEST ENGINEERING LABORATORY, INC.

**DUT: IHDT56MP1; Type: Cellular/PCS CDMA/EVDO Phone
with Bluetooth and WLAN; Serial: Unit Y**

Communication System: PCS CDMA; Frequency: 1880 MHz; Duty Cycle: 1:1

Medium: 1900 Body Medium parameters used:

$f = 1880 \text{ MHz}$; $\sigma = 1.501 \text{ mho/m}$; $\epsilon_r = 51.4$; $\rho = 1000 \text{ kg/m}^3$

Phantom section: Flat Section; Space: 1.0 cm

Test Date: 06-22-2011; Ambient Temp: 24.1 °C; Tissue Temp: 22.6 °C

Probe: EX3DV4 - SN3550; ConvF(6.77, 6.77, 6.77); Calibrated: 2/14/2011

Sensor-Surface: 4mm (Mechanical Surface Detection)

Electronics: DAE4 Sn665; Calibrated: 4/20/2011

Phantom: SAM Sub; Type: SAM 4.0; Serial: TP-1357

Measurement SW: DASY4, V4.7 Build 80; Postprocessing SW: SEMCAD, V1.8 Build 186

Mode: PCS EVDO, Body SAR, Bottom Edge, Mid.ch, Standard Battery

Area Scan (5x7x1): Measurement grid: dx=15mm, dy=15mm

Zoom Scan (5x5x7)/Cube 0: Measurement grid: dx=8mm, dy=8mm, dz=5mm

Reference Value = 27.1 V/m

Peak SAR (extrapolated) = 1.18 W/kg

SAR(1 g) = 0.730 mW/g; SAR(10 g) = 0.374 mW/g

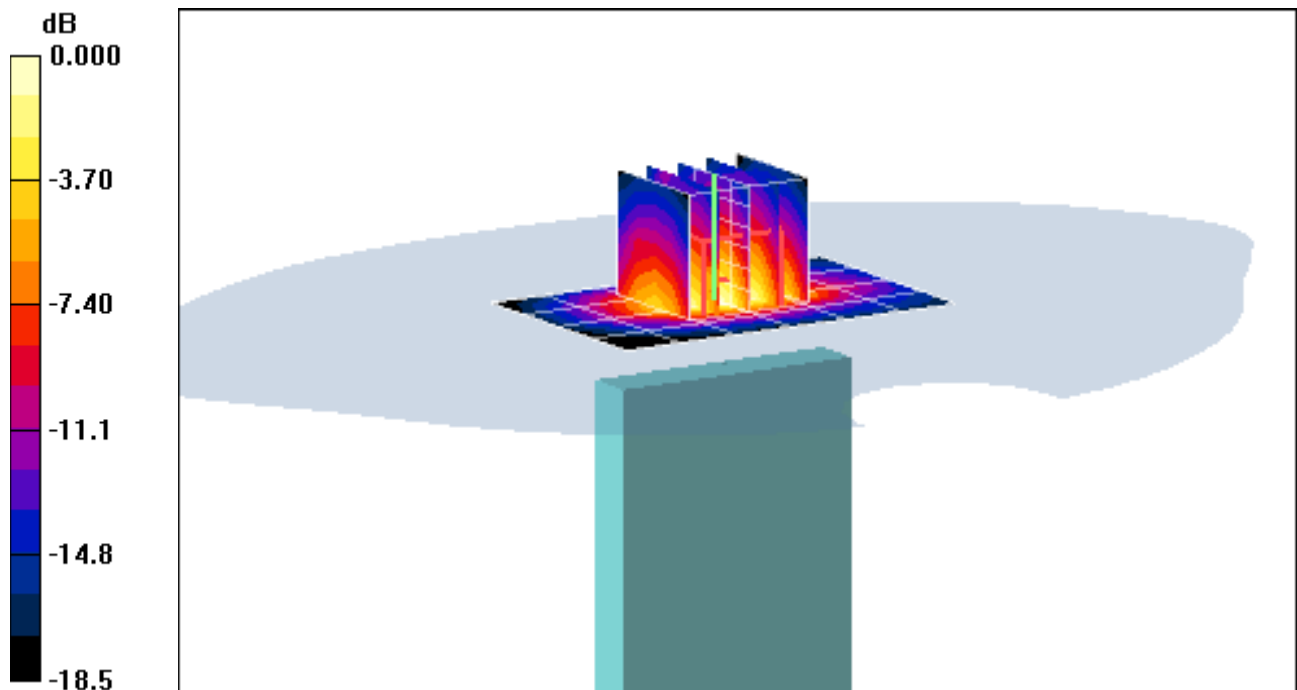

0 dB = 0.844mW/g

PCTEST ENGINEERING LABORATORY, INC.

**DUT: IHDT56MP1; Type: Cellular/PCS CDMA/EVDO Phone
with Bluetooth and WLAN; Serial: Unit Y**

Communication System: PCS CDMA; Frequency: 1880 MHz; Duty Cycle: 1:1
Medium: 1900 Body Medium parameters used:

$f = 1880 \text{ MHz}$; $\sigma = 1.501 \text{ mho/m}$; $\epsilon_r = 51.4$; $\rho = 1000 \text{ kg/m}^3$

Phantom section: Flat Section; Space: 1.0 cm

Test Date: 06-22-2011; Ambient Temp: 24.1 °C; Tissue Temp: 22.6 °C

Probe: EX3DV4 - SN3550; ConvF(6.77, 6.77, 6.77); Calibrated: 2/14/2011

Sensor-Surface: 4mm (Mechanical Surface Detection)

Electronics: DAE4 Sn665; Calibrated: 4/20/2011

Phantom: SAM Sub; Type: SAM 4.0; Serial: TP-1357

Measurement SW: DASY4, V4.7 Build 80; Postprocessing SW: SEMCAD, V1.8 Build 186

Mode: PCS EVDO, Body SAR, Bottom Edge, Mid.ch, Standard Battery

Area Scan (5x7x1): Measurement grid: dx=15mm, dy=15mm

Zoom Scan (5x5x7)/Cube 0: Measurement grid: dx=8mm, dy=8mm, dz=5mm

Reference Value = 27.1 V/m

Peak SAR (extrapolated) = 1.18 W/kg

SAR(1 g) = 0.730 mW/g; SAR(10 g) = 0.374 mW/g

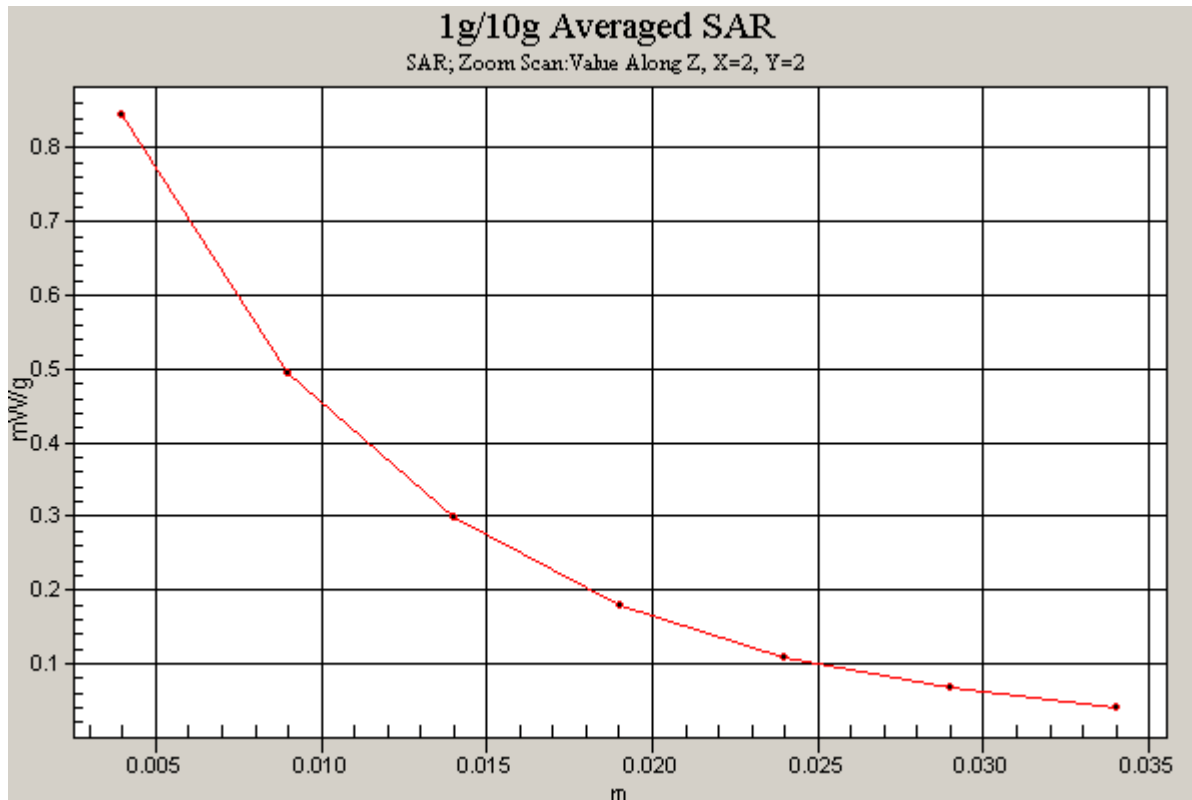

PCTEST ENGINEERING LABORATORY, INC.

**DUT: IHDT56MP1; Type: Cellular/PCS CDMA/EVDO Phone
with Bluetooth and WLAN; Serial: Unit Y**

Communication System: PCS CDMA; Frequency: 1880 MHz; Duty Cycle: 1:1

Medium: 1900 Body Medium parameters used:

$f = 1880 \text{ MHz}$; $\sigma = 1.501 \text{ mho/m}$; $\epsilon_r = 51.4$; $\rho = 1000 \text{ kg/m}^3$

Phantom section: Flat Section; Space: 1.0 cm

Test Date: 06-22-2011; Ambient Temp: 24.1 °C; Tissue Temp: 22.6 °C

Probe: EX3DV4 - SN3550; ConvF(6.77, 6.77, 6.77); Calibrated: 2/14/2011

Sensor-Surface: 4mm (Mechanical Surface Detection)

Electronics: DAE4 Sn665; Calibrated: 4/20/2011

Phantom: SAM Sub; Type: SAM 4.0; Serial: TP-1357

Measurement SW: DASY4, V4.7 Build 80; Postprocessing SW: SEMCAD, V1.8 Build 186

Mode: PCS EVDO, Body SAR, Right Edge, Mid.ch, Standard Battery

Area Scan (5x13x1): Measurement grid: dx=15mm, dy=15mm

Zoom Scan (5x5x7)/Cube 0: Measurement grid: dx=8mm, dy=8mm, dz=5mm

Reference Value = 4.02 V/m

Peak SAR (extrapolated) = 0.045 W/kg

SAR(1 g) = 0.024 mW/g; SAR(10 g) = 0.015 mW/g

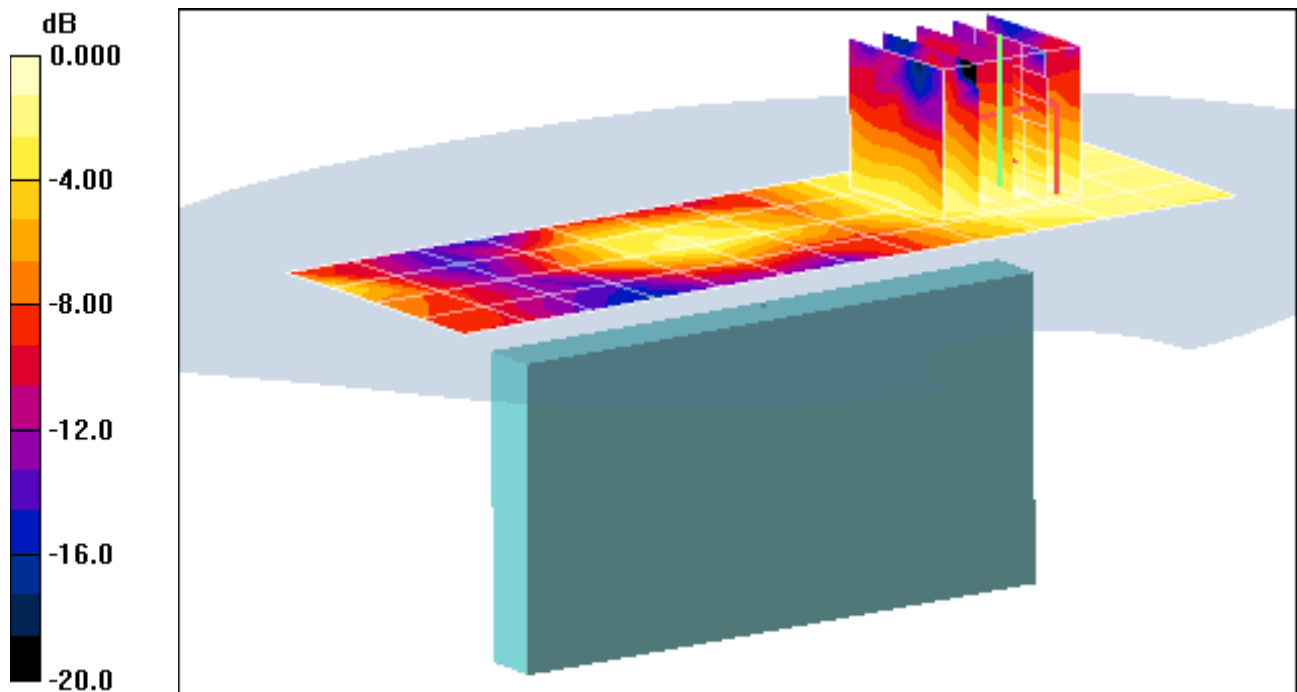

0 dB = 0.028mW/g

PCTEST ENGINEERING LABORATORY, INC.

**DUT: IHDT56MP1; Type: Cellular/PCS CDMA/EVDO Phone
with Bluetooth and WLAN; Serial: Unit Y**

Communication System: PCS CDMA; Frequency: 1880 MHz; Duty Cycle: 1:1

Medium: 1900 Body Medium parameters used:

$f = 1880 \text{ MHz}$; $\sigma = 1.501 \text{ mho/m}$; $\epsilon_r = 51.4$; $\rho = 1000 \text{ kg/m}^3$

Phantom section: Flat Section; Space: 1.0 cm

Test Date: 06-22-2011; Ambient Temp: 24.1 °C; Tissue Temp: 22.6 °C

Probe: EX3DV4 - SN3550; ConvF(6.77, 6.77, 6.77); Calibrated: 2/14/2011

Sensor-Surface: 4mm (Mechanical Surface Detection)

Electronics: DAE4 Sn665; Calibrated: 4/20/2011

Phantom: SAM Sub; Type: SAM 4.0; Serial: TP-1357

Measurement SW: DASY4, V4.7 Build 80; Postprocessing SW: SEMCAD, V1.8 Build 186

Mode: PCS EVDO, Body SAR, Left Edge, Mid.ch, Standard Battery

Area Scan (5x13x1): Measurement grid: dx=15mm, dy=15mm

Zoom Scan (5x5x7)/Cube 0: Measurement grid: dx=8mm, dy=8mm, dz=5mm

Reference Value = 8.00 V/m

Peak SAR (extrapolated) = 0.137 W/kg

SAR(1 g) = 0.087 mW/g; SAR(10 g) = 0.053 mW/g

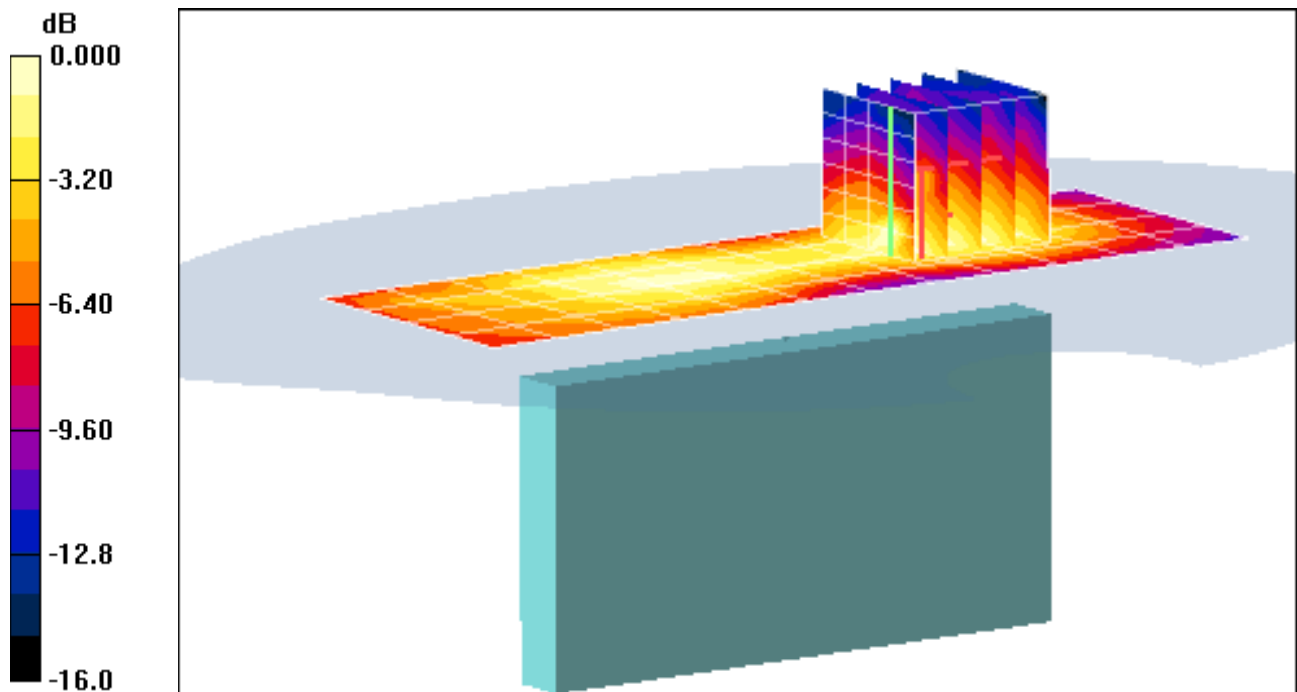

0 dB = 0.101mW/g

PCTEST ENGINEERING LABORATORY, INC.

**DUT: IHDT56MP1; Type: Cellular/PCS CDMA/EVDO Phone
with Bluetooth and WLAN; Serial: Unit C**

Communication System: IEEE 802.11b; Frequency: 2462 MHz; Duty Cycle: 1:1
Medium: 2450 Body Medium parameters used (interpolated):
 $f = 2462 \text{ MHz}$; $\sigma = 2.04 \text{ mho/m}$; $\epsilon_r = 50.7$; $\rho = 1000 \text{ kg/m}^3$
Phantom section: Flat Section; Space: 2.5 cm

Test Date: 06-01-2011; Ambient Temp: 23.9 °C; Tissue Temp: 22.3 °C

Probe: ES3DV2 - SN3022; ConvF(4.06, 4.06, 4.06); Calibrated: 9/21/2010
Sensor-Surface: 3mm (Mechanical Surface Detection)
Electronics: DAE4 Sn704; Calibrated: 3/17/2011

Phantom: SAM with CRP; Type: SAM; Serial: TP1375
Measurement SW: DASY4, V4.7 Build 80; Postprocessing SW: SEMCAD, V1.8 Build 186

Mode: IEEE 802.11b, Body SAR, Ch 11, 1 Mbps, Back Side, Standard Battery

Area Scan (7x11x1): Measurement grid: dx=15mm, dy=15mm

Zoom Scan (5x5x7)/Cube 0: Measurement grid: dx=8mm, dy=8mm, dz=5mm

Reference Value = 2.77 V/m

Peak SAR (extrapolated) = 0.025 W/kg

SAR(1 g) = 0.014 mW/g; SAR(10 g) = 0.0063 mW/g

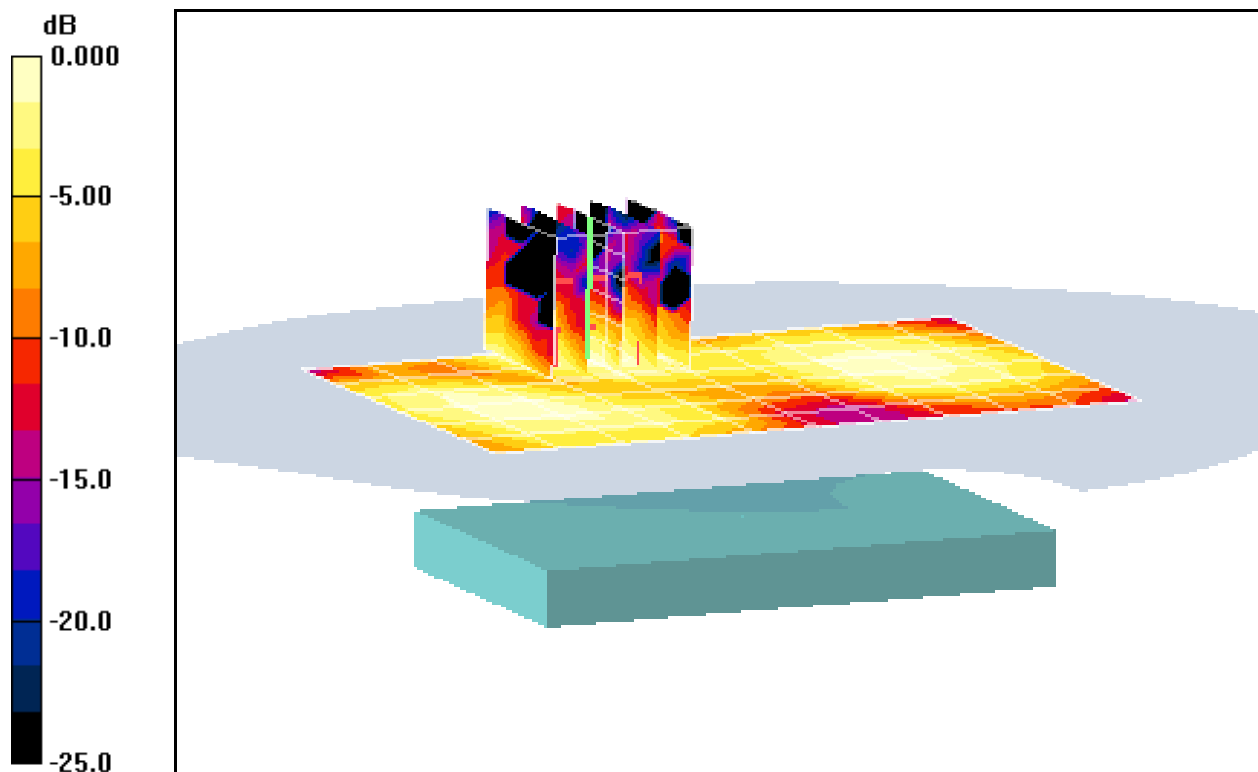

0 dB = 0.017mW/g

PCTEST ENGINEERING LABORATORY, INC.

**DUT: IHDT56MP1; Type: Cellular/PCS CDMA/EVDO Phone
with Bluetooth and WLAN; Serial: Unit E**

Communication System: IEEE 802.11b; Frequency: 2437 MHz; Duty Cycle: 1:1
Medium: 2450 Body Medium parameters used (interpolated):
 $f = 2437 \text{ MHz}$; $\sigma = 1.96 \text{ mho/m}$; $\epsilon_r = 51$; $\rho = 1000 \text{ kg/m}^3$
Phantom section: Flat Section; Space: 1.0 cm

Test Date: 06-07-2011; Ambient Temp: 24.9 °C; Tissue Temp: 23.0 °C

Probe: ES3DV2 - SN3022; ConvF(4.06, 4.06, 4.06); Calibrated: 9/21/2010
Sensor-Surface: 3mm (Mechanical Surface Detection)
Electronics: DAE4 Sn704; Calibrated: 3/17/2011

Phantom: SAM with CRP; Type: SAM; Serial: TP1375
Measurement SW: DASY4, V4.7 Build 80; Postprocessing SW: SEMCAD, V1.8 Build 186

Mode: IEEE 802.11b, Body SAR, Ch 06, 1 Mbps, Back Side, Standard Battery

Area Scan (7x11x1): Measurement grid: dx=15mm, dy=15mm

Zoom Scan (5x5x7)/Cube 0: Measurement grid: dx=8mm, dy=8mm, dz=5mm

Reference Value = 4.88 V/m

Peak SAR (extrapolated) = 0.131 W/kg

SAR(1 g) = 0.056 mW/g; SAR(10 g) = 0.025 mW/g

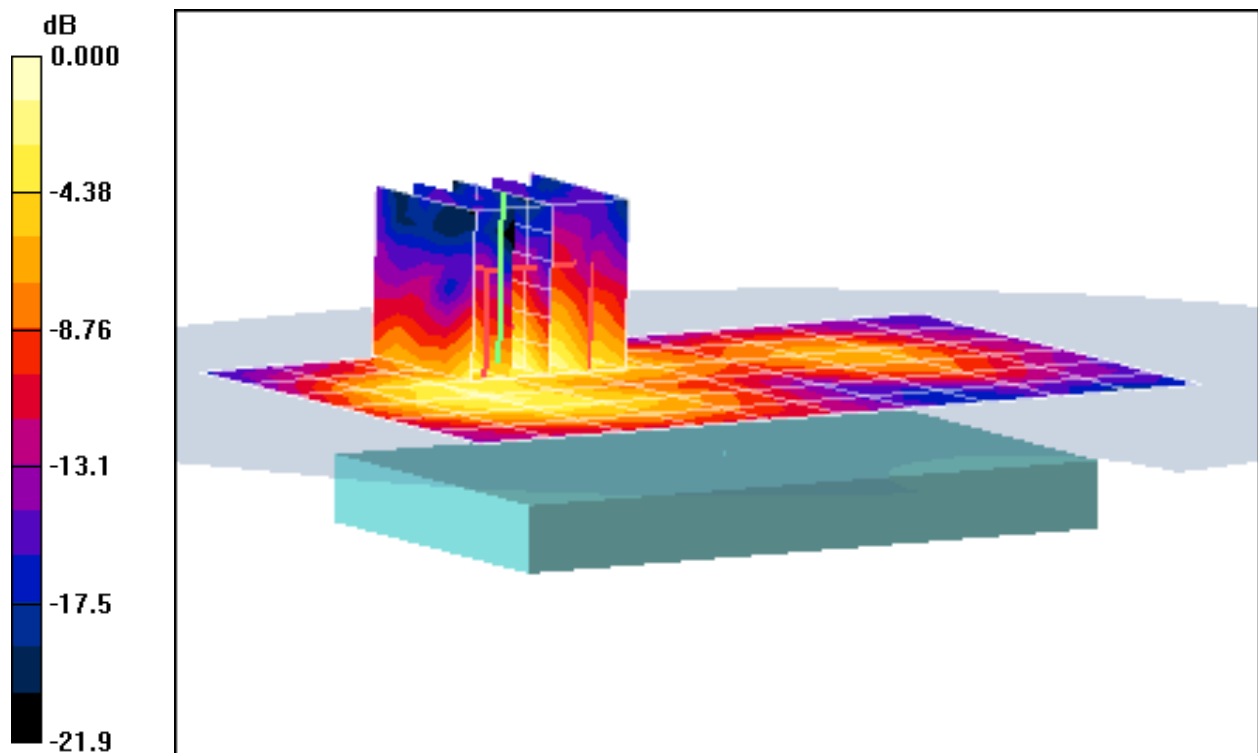

0 dB = 0.075mW/g

PCTEST ENGINEERING LABORATORY, INC.

**DUT: IHDT56MP1; Type: Cellular/PCS CDMA/EVDO Phone
with Bluetooth and WLAN; Serial: Unit E**

Communication System: IEEE 802.11b; Frequency: 2437 MHz; Duty Cycle: 1:1

Medium: 2450 Body Medium parameters used (interpolated):

$f = 2437 \text{ MHz}$; $\sigma = 1.96 \text{ mho/m}$; $\epsilon_r = 51$; $\rho = 1000 \text{ kg/m}^3$

Phantom section: Flat Section; Space: 1.0 cm

Test Date: 06-07-2011; Ambient Temp: 24.9 °C; Tissue Temp: 23.0 °C

Probe: ES3DV2 - SN3022; ConvF(4.06, 4.06, 4.06); Calibrated: 9/21/2010

Sensor-Surface: 3mm (Mechanical Surface Detection)

Electronics: DAE4 Sn704; Calibrated: 3/17/2011

Phantom: SAM with CRP; Type: SAM; Serial: TP1375

Measurement SW: DASY4, V4.7 Build 80; Postprocessing SW: SEMCAD, V1.8 Build 186

Mode: IEEE 802.11b, Body SAR, Ch 06, 1 Mbps, Back Side, Standard Battery

Area Scan (7x11x1): Measurement grid: dx=15mm, dy=15mm

Zoom Scan (5x5x7)/Cube 0: Measurement grid: dx=8mm, dy=8mm, dz=5mm

Reference Value = 4.88 V/m

Peak SAR (extrapolated) = 0.131 W/kg

SAR(1 g) = 0.056 mW/g; SAR(10 g) = 0.025 mW/g

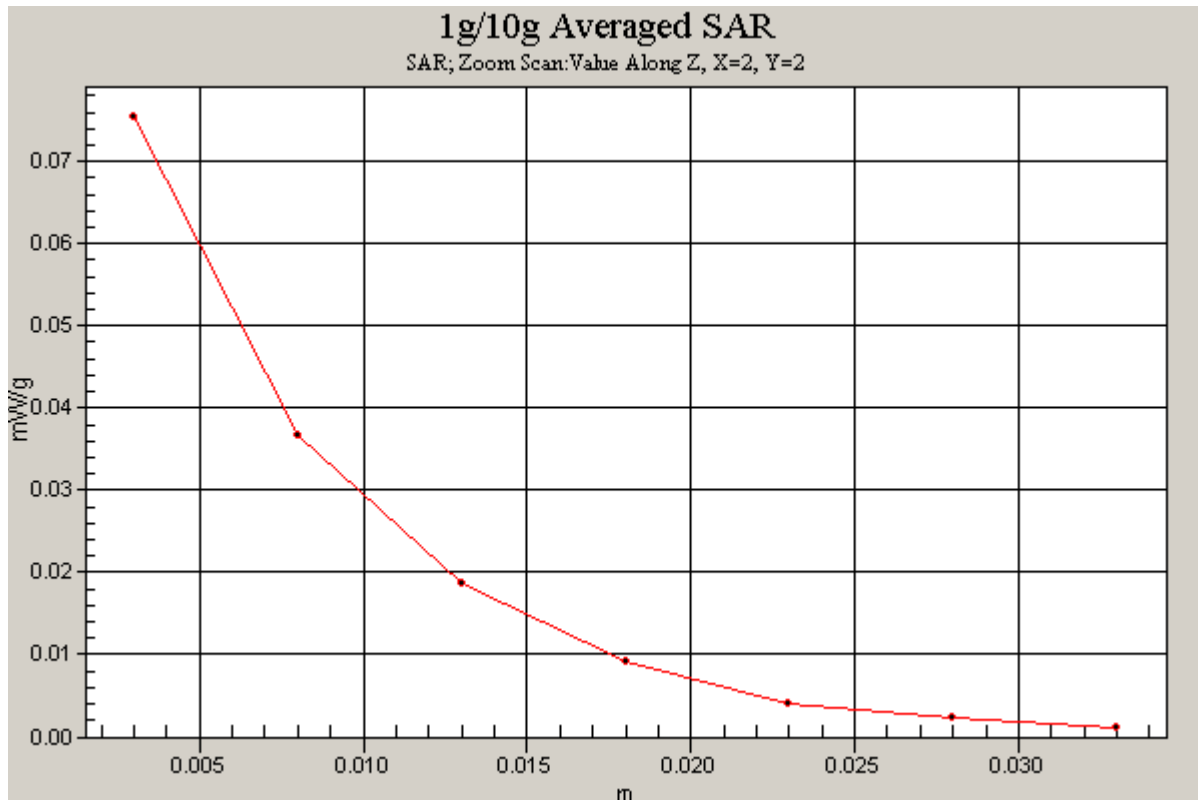

PCTEST ENGINEERING LABORATORY, INC.

**DUT: IHDT56MP1; Type: Cellular/PCS CDMA/EVDO Phone
with Bluetooth and WLAN; Serial: Unit E**

Communication System: IEEE 802.11b; Frequency: 2437 MHz; Duty Cycle: 1:1
Medium: 2450 Body Medium parameters used (interpolated):
 $f = 2437 \text{ MHz}$; $\sigma = 1.96 \text{ mho/m}$; $\epsilon_r = 51$; $\rho = 1000 \text{ kg/m}^3$
Phantom section: Flat Section; Space: 1.0 cm

Test Date: 06-07-2011; Ambient Temp: 24.9 °C; Tissue Temp: 23.0 °C

Probe: ES3DV2 - SN3022; ConvF(4.06, 4.06, 4.06); Calibrated: 9/21/2010
Sensor-Surface: 3mm (Mechanical Surface Detection)
Electronics: DAE4 Sn704; Calibrated: 3/17/2011

Phantom: SAM with CRP; Type: SAM; Serial: TP1375
Measurement SW: DASY4, V4.7 Build 80; Postprocessing SW: SEMCAD, V1.8 Build 186

Mode: IEEE 802.11b, Body SAR, Ch 06, 1 Mbps, Front Side, Standard Battery

Area Scan (7x11x1): Measurement grid: dx=15mm, dy=15mm

Zoom Scan (5x5x7)/Cube 0: Measurement grid: dx=8mm, dy=8mm, dz=5mm

Reference Value = 4.69 V/m

Peak SAR (extrapolated) = 0.084 W/kg

SAR(1 g) = 0.045 mW/g; SAR(10 g) = 0.025 mW/g

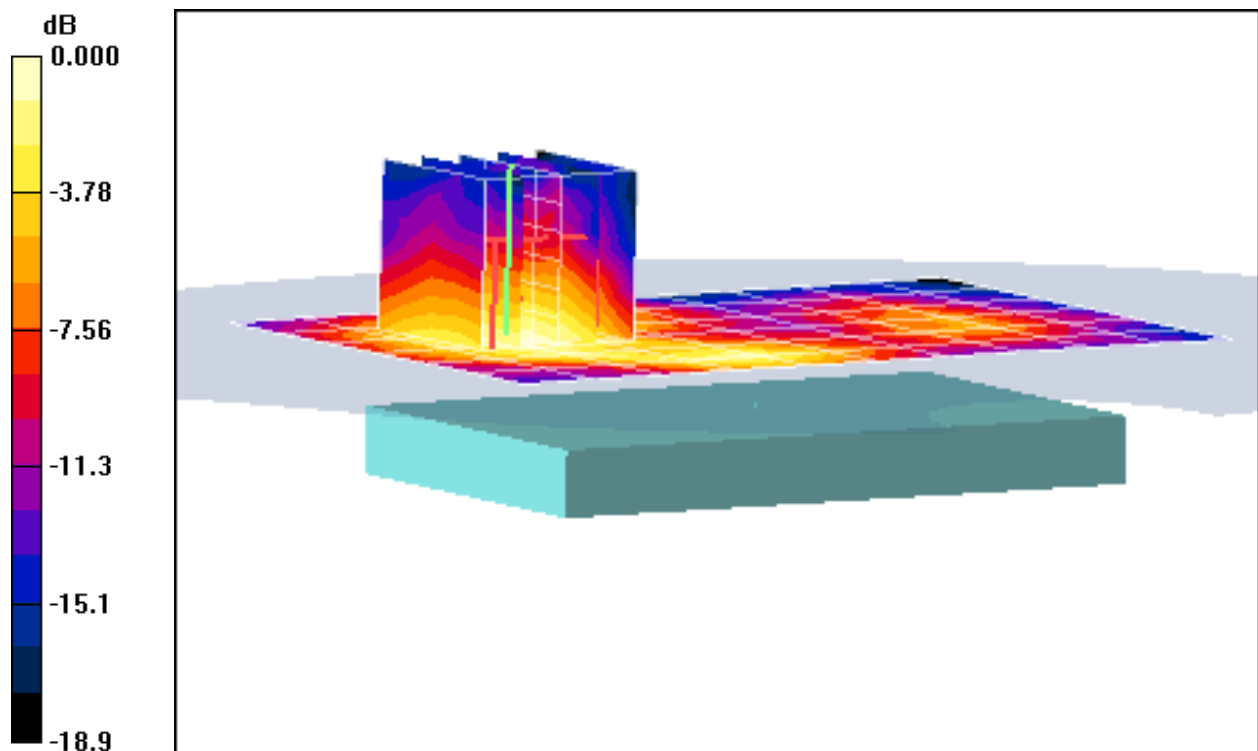

0 dB = 0.055mW/g

PCTEST ENGINEERING LABORATORY, INC.

**DUT: IHDT56MP1; Type: Cellular/PCS CDMA/EVDO Phone
with Bluetooth and WLAN; Serial: Unit E**

Communication System: IEEE 802.11b; Frequency: 2437 MHz; Duty Cycle: 1:1
Medium: 2450 Body Medium parameters used (interpolated):
 $f = 2437 \text{ MHz}$; $\sigma = 1.96 \text{ mho/m}$; $\epsilon_r = 51$; $\rho = 1000 \text{ kg/m}^3$
Phantom section: Flat Section; Space: 1.0 cm

Test Date: 06-07-2011; Ambient Temp: 24.9 °C; Tissue Temp: 23.0 °C

Probe: ES3DV2 - SN3022; ConvF(4.06, 4.06, 4.06); Calibrated: 9/21/2010
Sensor-Surface: 3mm (Mechanical Surface Detection)
Electronics: DAE4 Sn704; Calibrated: 3/17/2011
Phantom: SAM with CRP; Type: SAM; Serial: TP1375
Measurement SW: DASY4, V4.7 Build 80; Postprocessing SW: SEMCAD, V1.8 Build 186

Mode: IEEE 802.11b, Body SAR, Ch 06, 1 Mbps, Bottom Edge, Standard Battery

Area Scan (5x7x1): Measurement grid: dx=15mm, dy=15mm
Zoom Scan (5x5x7)/Cube 0: Measurement grid: dx=8mm, dy=8mm, dz=5mm
Reference Value = 4.25 V/m
Peak SAR (extrapolated) = 0.061 W/kg
SAR(1 g) = 0.032 mW/g; SAR(10 g) = 0.018 mW/g

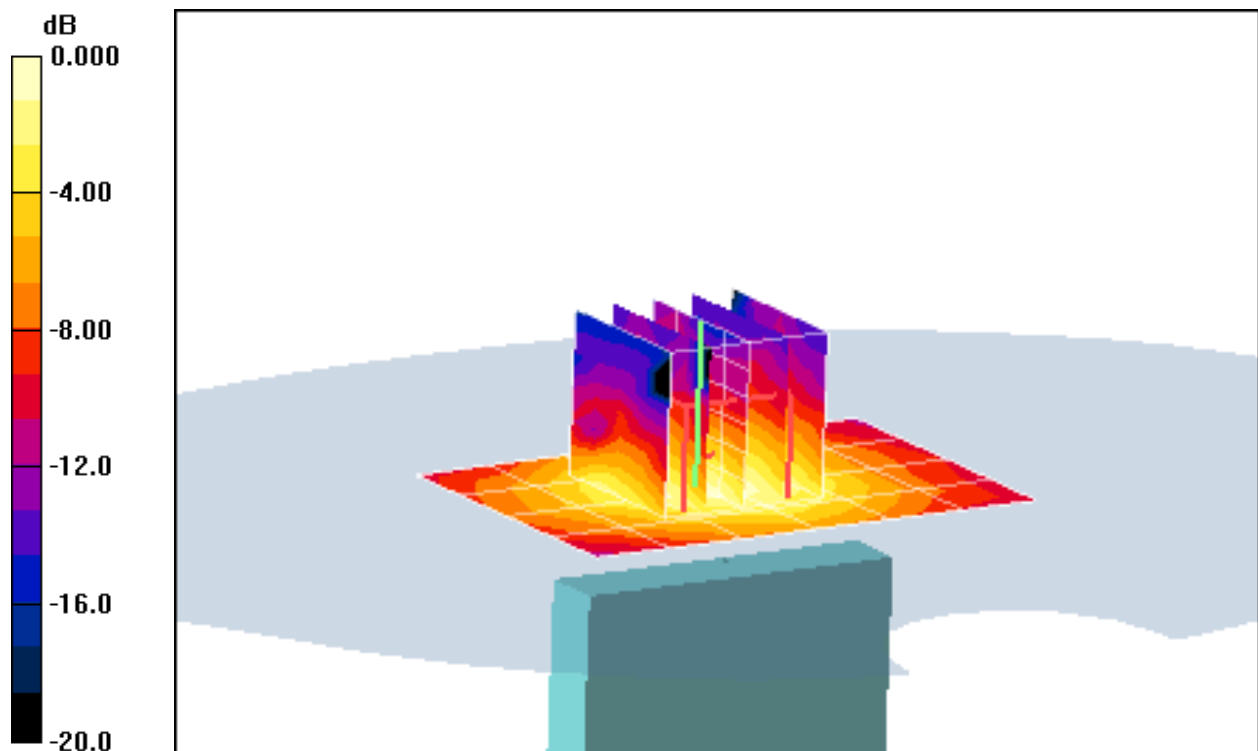

0 dB = 0.040mW/g

PCTEST ENGINEERING LABORATORY, INC.

**DUT: IHDT56MP1; Type: Cellular/PCS CDMA/EVDO Phone
with Bluetooth and WLAN; Serial: Unit E**

Communication System: IEEE 802.11b; Frequency: 2437 MHz; Duty Cycle: 1:1

Medium: 2450 Body Medium parameters used (interpolated):

$f = 2437 \text{ MHz}$; $\sigma = 1.96 \text{ mho/m}$; $\epsilon_r = 51$; $\rho = 1000 \text{ kg/m}^3$

Phantom section: Flat Section; Space: 1.0 cm

Test Date: 06-07-2011; Ambient Temp: 24.9 °C; Tissue Temp: 23.0 °C

Probe: ES3DV2 - SN3022; ConvF(4.06, 4.06, 4.06); Calibrated: 9/21/2010

Sensor-Surface: 3mm (Mechanical Surface Detection)

Electronics: DAE4 Sn704; Calibrated: 3/17/2011

Phantom: SAM with CRP; Type: SAM; Serial: TP1375

Measurement SW: DASY4, V4.7 Build 80; Postprocessing SW: SEMCAD, V1.8 Build 186

Mode: IEEE 802.11b, Body SAR, Ch 06, 1 Mbps, Right Edge, Standard Battery

Area Scan (5x13x1): Measurement grid: dx=15mm, dy=15mm

Zoom Scan (5x5x7)/Cube 0: Measurement grid: dx=8mm, dy=8mm, dz=5mm

Reference Value = 5.08 V/m

Peak SAR (extrapolated) = 0.118 W/kg

SAR(1 g) = 0.056 mW/g; SAR(10 g) = 0.028 mW/g

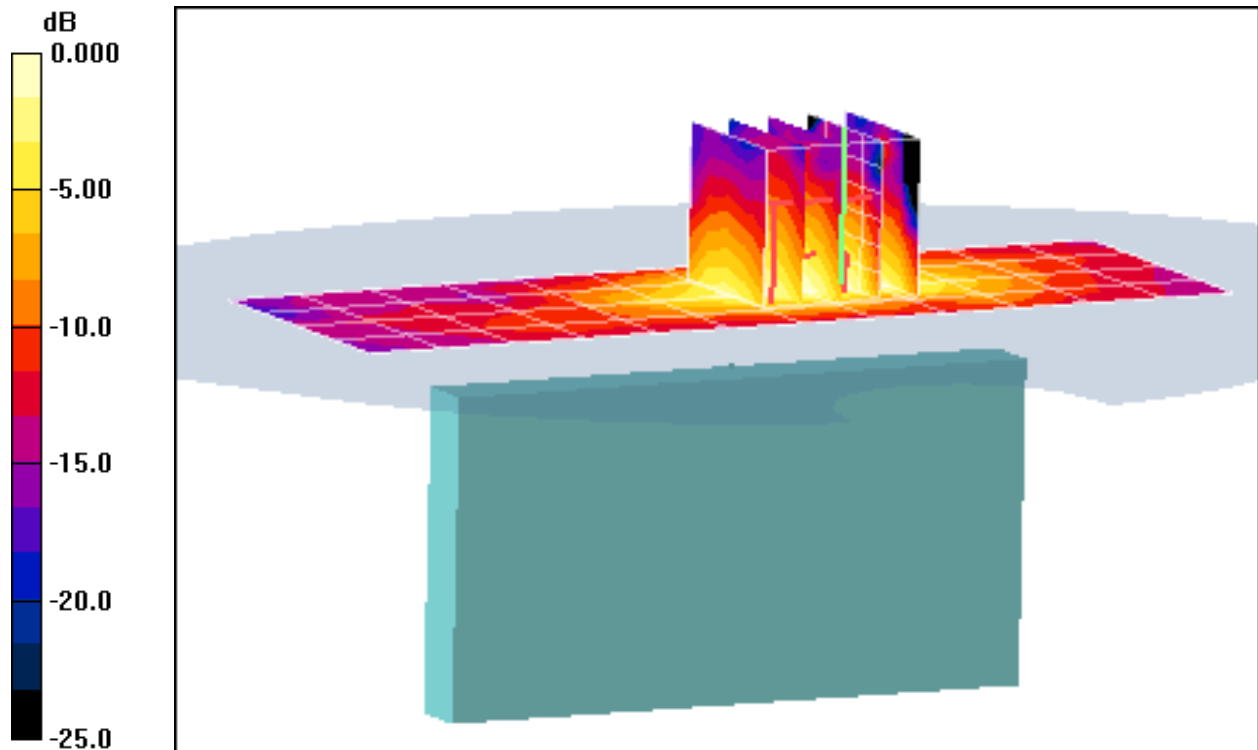

0 dB = 0.070mW/g

APPENDIX B: DIPOLE VALIDATION

PCTEST ENGINEERING LABORATORY, INC.

DUT: Dipole 835 MHz; Type: D835V2; Serial: 4d047

Communication System: CW; Frequency: 835 MHz; Duty Cycle: 1:1

Medium: 835 Head Medium parameters used:

$f = 835 \text{ MHz}$; $\sigma = 0.922 \text{ mho/m}$; $\epsilon_r = 42.2$; $\rho = 1000 \text{ kg/m}^3$

Phantom section: Flat Section; Space: 1.5 cm

Test Date: 06-21-2011; Ambient Temp: 23.2°C; Tissue Temp: 22.1°C

Probe: EX3DV4 - SN3561; ConvF(7.96, 7.96, 7.96); Calibrated: 8/19/2010

Sensor-Surface: 4mm (Mechanical Surface Detection)

Electronics: DAE4 Sn649; Calibrated: 2/21/2011

Phantom: SAM Sub; Type: SAM 4.0; Serial: TP-1403

Measurement SW: DASY4, V4.7 Build 80; Postprocessing SW: SEMCAD, V1.8 Build 186

835MHz System Verification

Area Scan (7x13x1): Measurement grid: dx=15mm, dy=15mm

Zoom Scan (5x5x7)/Cube 0: Measurement grid: dx=8mm, dy=8mm, dz=5mm

Input Power = 20.0 dBm (100 mW)

SAR(1 g) = 0.975 mW/g; SAR(10 g) = 0.636 mW/g

Deviation = 2.31 %

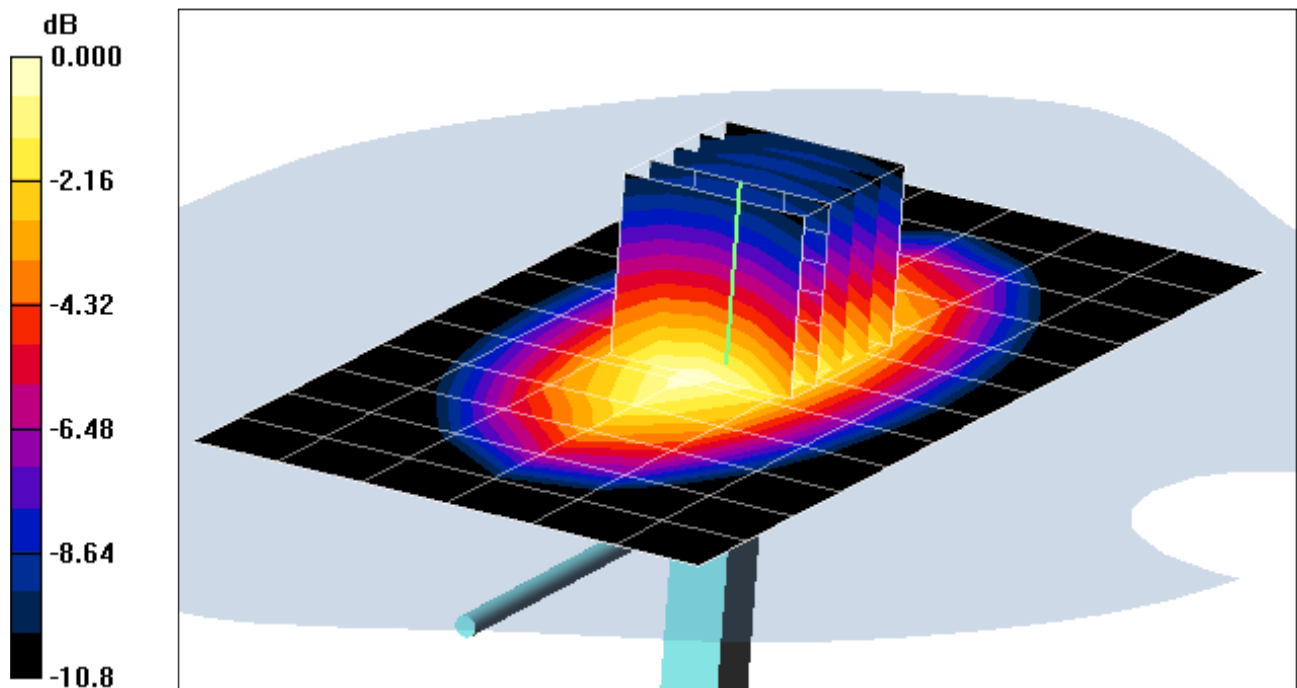

0 dB = 1.05mW/g

PCTEST ENGINEERING LABORATORY, INC.

DUT: Dipole 835 MHz; Type: D835V2; Serial: 4d047

Communication System: CW; Frequency: 835 MHz; Duty Cycle: 1:1

Medium: 835 Head Medium parameters used:

$f = 835 \text{ MHz}$; $\sigma = 0.902 \text{ mho/m}$; $\epsilon_r = 42.6$; $\rho = 1000 \text{ kg/m}^3$

Phantom section: Flat Section; Space: 1.5 cm

Test Date: 08-22-2011; Ambient Temp: 23.3°C; Tissue Temp: 22.0°C

Probe: ES3DV3 - SN3258; ConvF(6.18, 6.18, 6.18); Calibrated: 4/8/2011

Sensor-Surface: 4mm (Mechanical Surface Detection)

Electronics: DAE4 Sn649; Calibrated: 2/21/2011

Phantom: SAM Sub; Type: SAM 4.0; Serial: TP-1403

Measurement SW: DASY4, V4.7 Build 80; Postprocessing SW: SEMCAD, V1.8 Build 186

835MHz System Verification

Area Scan (7x13x1): Measurement grid: dx=15mm, dy=15mm

Zoom Scan (5x5x7)/Cube 0: Measurement grid: dx=8mm, dy=8mm, dz=5mm

Input Power = 24.0 dBm (250 mW)

SAR(1 g) = 2.48 mW/g; SAR(10 g) = 1.61 mW/g

Deviation = 4.09 %

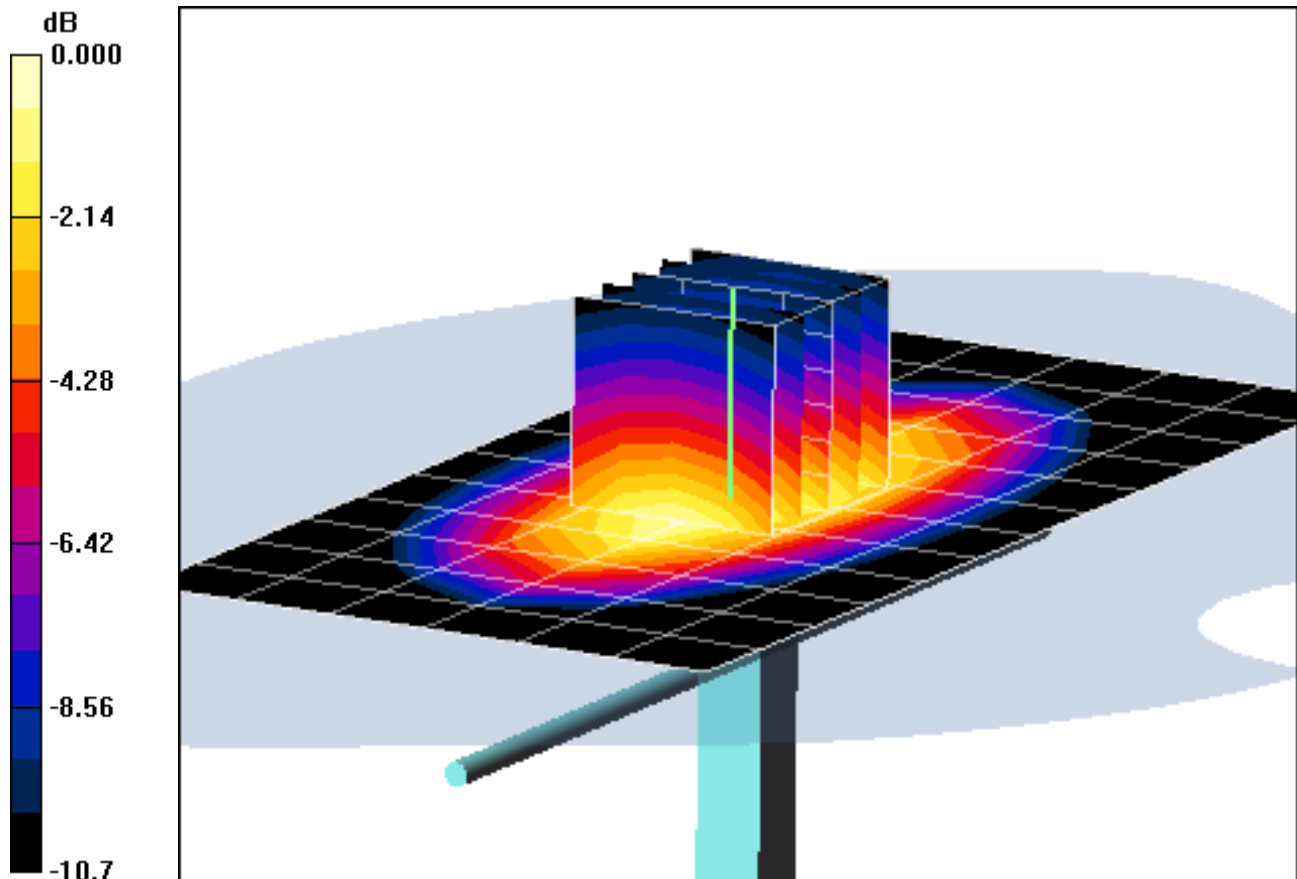

0 dB = 2.69mW/g

PCTEST ENGINEERING LABORATORY, INC.

DUT: Dipole 835 MHz; Type: D835V2; Serial: 4d047

Communication System: CW; Frequency: 835 MHz; Duty Cycle: 1:1

Medium: 835 Body Medium parameters used:

$f = 835 \text{ MHz}$; $\sigma = 0.98 \text{ mho/m}$; $\epsilon_r = 53$; $\rho = 1000 \text{ kg/m}^3$

Phantom section: Flat Section; Space: 1.5 cm

Test Date: 06-20-2011; Ambient Temp: 23.5 °C; Tissue Temp: 22.2 °C

Probe: EX3DV4 - SN3561; ConvF(8.09, 8.09, 8.09); Calibrated: 8/19/2010

Sensor-Surface: 4mm (Mechanical Surface Detection)

Electronics: DAE4 Sn649; Calibrated: 2/21/2011

Phantom: SAM Main; Type: SAM 4.0; Serial: TP-1406

Measurement SW: DASY4, V4.7 Build 80; Postprocessing SW: SEMCAD, V1.8 Build 186

835MHz System Verification

Area Scan (7x13x1): Measurement grid: dx=15mm, dy=15mm

Zoom Scan (5x5x7)/Cube 0: Measurement grid: dx=8mm, dy=8mm, dz=5mm

Input Power = 20.0 dBm (100 mW)

SAR(1 g) = 0.997 mW/g; SAR(10 g) = 0.653 mW/g

Deviation = 1.22 %

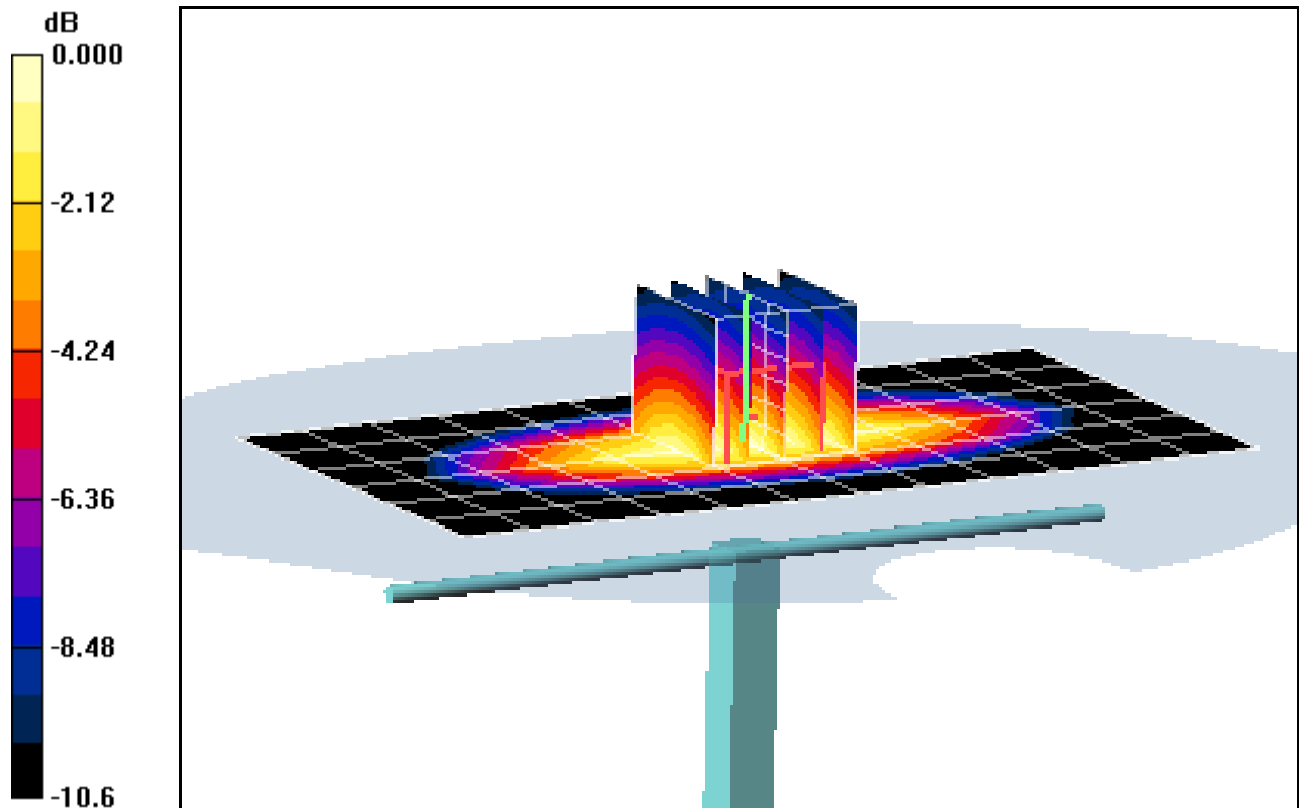

0 dB = 1.08mW/g

PCTEST ENGINEERING LABORATORY, INC.

DUT: SAR Dipole 1900 MHz; Type: D1900V2; Serial: 502

Communication System: CW; Frequency: 1900 MHz; Duty Cycle: 1:1

Medium: 1900 Head Medium parameters used (interpolated):

$f = 1900 \text{ MHz}$; $\sigma = 1.43 \text{ mho/m}$; $\epsilon_r = 40$; $\rho = 1000 \text{ kg/m}^3$

Phantom section: Flat Section; Space: 1.0 cm

Test Date: 06-21-2011; Ambient Temp: 24.2°C; Tissue Temp: 22.7°C

Probe: EX3DV4 - SN3550; ConvF(7.01, 7.01, 7.01); Calibrated: 2/14/2011

Sensor-Surface: 4mm (Mechanical Surface Detection)

Electronics: DAE4 Sn665; Calibrated: 4/20/2011

Phantom: SAM Main; Type: SAM 4.0; Serial: TP-1114

Measurement SW: DASY4, V4.7 Build 80; Postprocessing SW: SEMCAD, V1.8 Build 186

1900MHz System Verification

Area Scan (5x7x1): Measurement grid: dx=15mm, dy=15mm

Zoom Scan (5x5x7)/Cube 0: Measurement grid: dx=8mm, dy=8mm, dz=5mm

Input Power = 16.0 dBm (40 mW)

SAR(1 g) = 1.6 mW/g; SAR(10 g) = 0.825 mW/g

Deviation = -0.50%

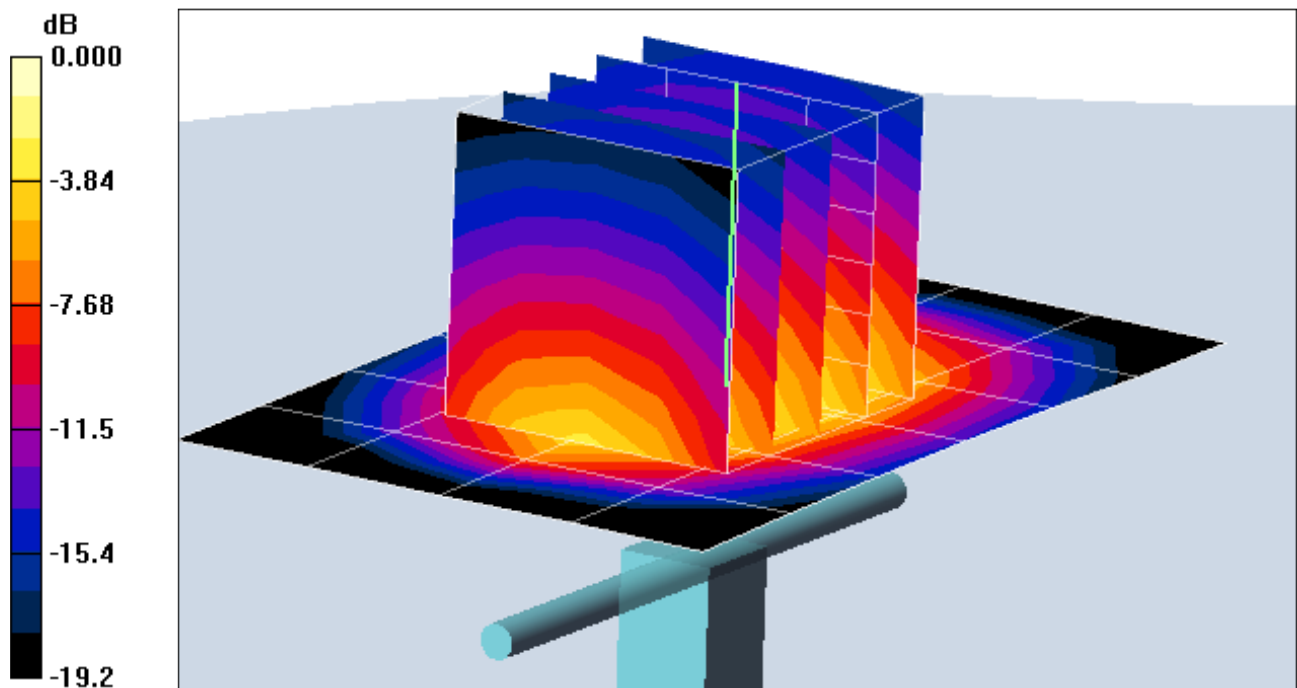

0 dB = 1.78mW/g

PCTEST ENGINEERING LABORATORY, INC.

DUT: SAR Dipole 1900 MHz; Type: D1900V2; Serial: 502

Communication System: CW; Frequency: 1900 MHz; Duty Cycle: 1:1

Medium: 1900 Head Medium parameters used (interpolated):

$f = 1900 \text{ MHz}$; $\sigma = 1.39 \text{ mho/m}$; $\epsilon_r = 38$; $\rho = 1000 \text{ kg/m}^3$

Phantom section: Flat Section; Space: 1.0 cm

Test Date: 08-22-2011; Ambient Temp: 23.6°C; Tissue Temp: 22.5°C

Probe: EX3DV4 - SN3550; ConvF(7.01, 7.01, 7.01); Calibrated: 2/14/2011

Sensor-Surface: 4mm (Mechanical Surface Detection)

Electronics: DAE4 Sn665; Calibrated: 4/20/2011

Phantom: SAM Main; Type: SAM 4.0; Serial: TP-1114

Measurement SW: DASY4, V4.7 Build 80; Postprocessing SW: SEMCAD, V1.8 Build 186

1900MHz System Verification

Area Scan (5x7x1): Measurement grid: dx=15mm, dy=15mm

Zoom Scan (5x5x7)/Cube 0: Measurement grid: dx=8mm, dy=8mm, dz=5mm

Input Power = 16.0 dBm (40 mW)

SAR(1 g) = 1.57 mW/g; SAR(10 g) = 0.804 mW/g

Deviation = -2.36 %

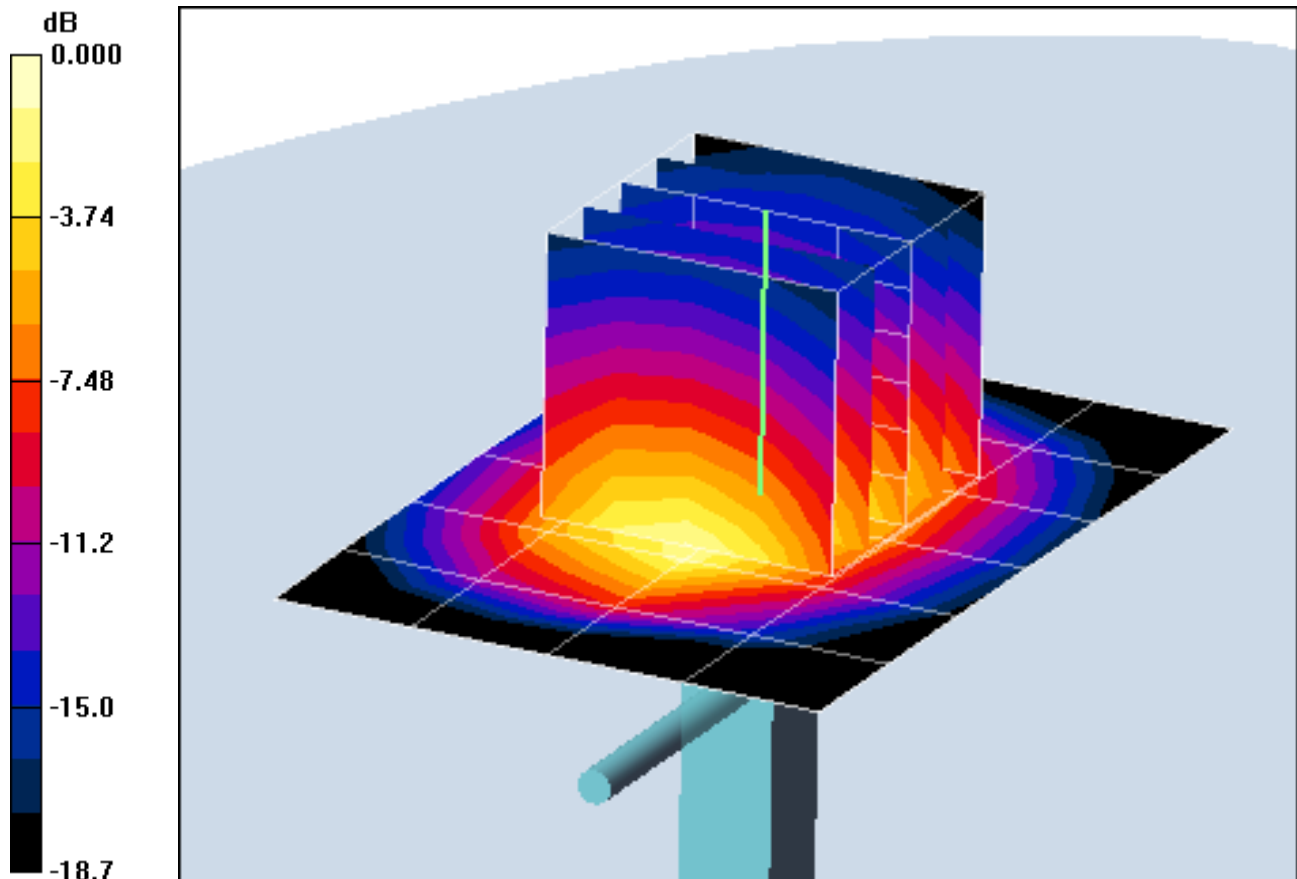

0 dB = 1.74mW/g

PCTEST ENGINEERING LABORATORY, INC.

DUT: Dipole 1900 MHz; Type: D1900V2; Serial: 502

Communication System: CW; Frequency: 1900 MHz; Duty Cycle: 1:1

Medium: 1900 Body Medium parameters used (interpolated):

$f = 1900 \text{ MHz}$; $\sigma = 1.52 \text{ mho/m}$; $\epsilon_r = 51.2$; $\rho = 1000 \text{ kg/m}^3$

Phantom section: Flat Section; Space: 1.0 cm

Test Date: 06-22-2011; Ambient Temp: 24.1°C; Tissue Temp: 22.6°C

Probe: EX3DV4 - SN3550; ConvF(6.77, 6.77, 6.77); Calibrated: 2/14/2011

Sensor-Surface: 4mm (Mechanical Surface Detection)

Electronics: DAE4 Sn665; Calibrated: 4/20/2011

Phantom: SAM Sub; Type: SAM 4.0; Serial: TP-1357

Measurement SW: DASY4, V4.7 Build 80; Postprocessing SW: SEMCAD, V1.8 Build 186

1900MHz System Verification

Area Scan (5x7x1): Measurement grid: dx=15mm, dy=15mm

Zoom Scan (5x5x7)/Cube 0: Measurement grid: dx=8mm, dy=8mm, dz=5mm

Input Power = 16.0 dBm (40 mW)

SAR(1 g) = 1.63 mW/g; SAR(10 g) = 0.834 mW/g

Deviation = -0.85 %

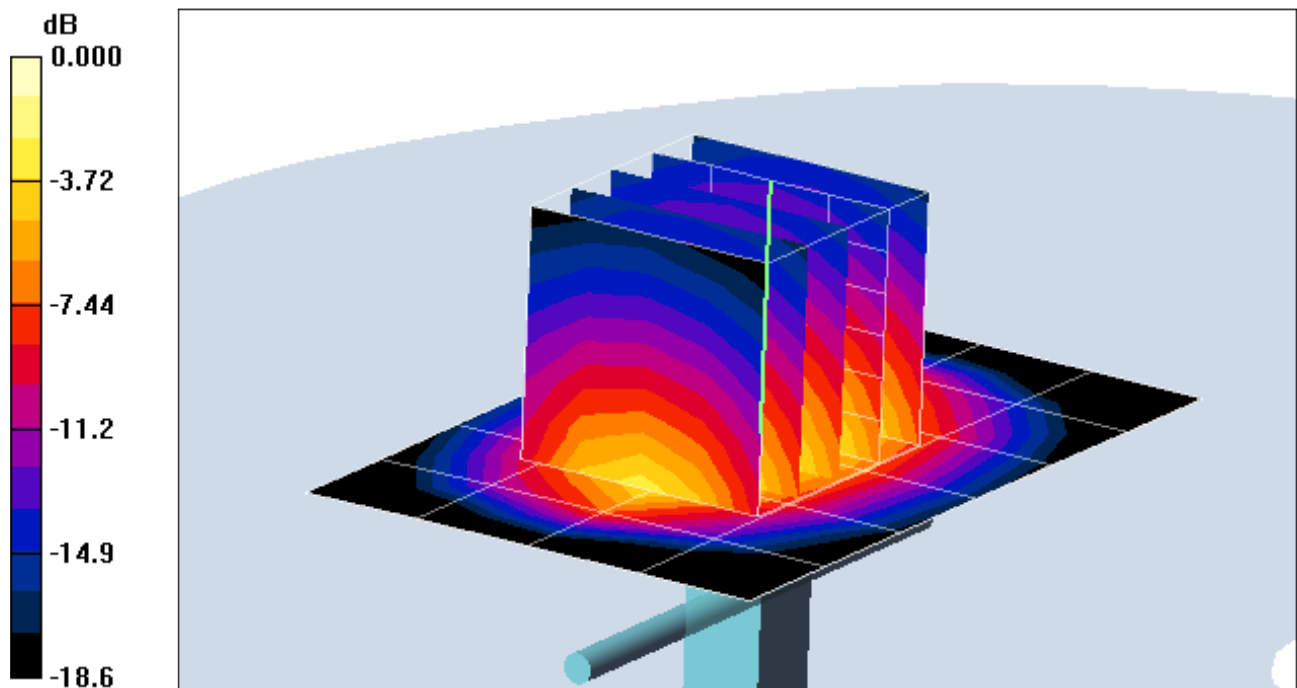

0 dB = 1.81mW/g

PCTEST ENGINEERING LABORATORY, INC.

DUT: SAR Dipole 2450 MHz; Type: D2450V2; Serial: 797

Communication System: CW; Frequency: 2450 MHz; Duty Cycle: 1:1

Medium: 2450 Head Medium parameters used:

$f = 2450 \text{ MHz}$; $\sigma = 1.88 \text{ mho/m}$; $\epsilon_r = 38.8$; $\rho = 1000 \text{ kg/m}^3$

Phantom section: Flat Section; Space: 1.0 cm

Test Date: 05-26-2011; Ambient Temp: 23.4°C; Tissue Temp: 22.4°C

Probe: ES3DV2 - SN3022; ConvF(4.21, 4.21, 4.21); Calibrated: 9/21/2010

Sensor-Surface: 3mm (Mechanical Surface Detection)

Electronics: DAE4 Sn704; Calibrated: 3/17/2011

Phantom: SAM with CRP; Type: SAM; Serial: TP1375

Measurement SW: DASY4, V4.7 Build 80; Postprocessing SW: SEMCAD, V1.8 Build 186

2450MHz System Verification

Area Scan (5x7x1): Measurement grid: dx=15mm, dy=15mm

Zoom Scan (5x5x7)/Cube 0: Measurement grid: dx=8mm, dy=8mm, dz=5mm

Input Power = 12 dBm (15.8 mW)

SAR(1 g) = 0.910 mW/g; SAR(10 g) = 0.415 mW/g

Deviation = 8.06 %

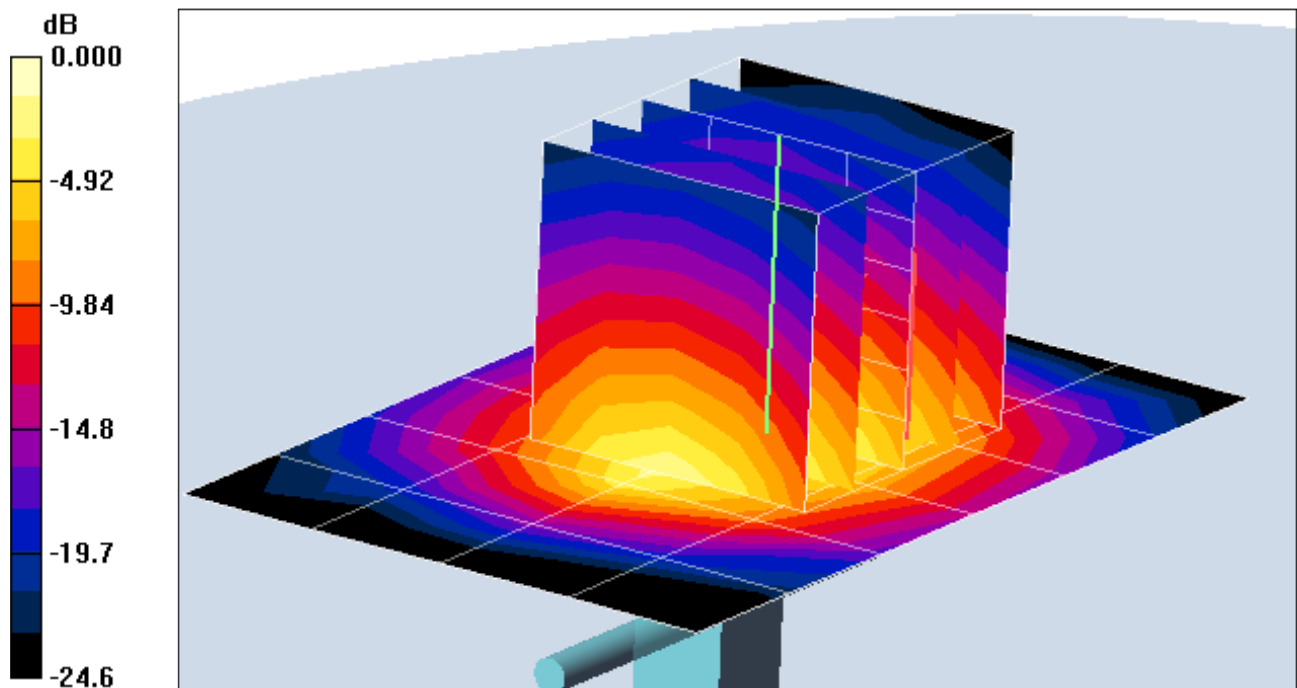

0 dB = 1.18mW/g

PCTEST ENGINEERING LABORATORY, INC.

DUT: SAR Dipole 2450 MHz; Type: D2450V2; Serial: 797

Communication System: CW; Frequency: 2450 MHz; Duty Cycle: 1:1

Medium: 2450 Head Medium parameters used:

$f = 2450 \text{ MHz}$; $\sigma = 1.79 \text{ mho/m}$; $\epsilon_r = 39.4$; $\rho = 1000 \text{ kg/m}^3$

Phantom section: Flat Section; Space: 1.0 cm

Test Date: 06-01-2011; Ambient Temp: 24.1 °C; Tissue Temp: 22.2°C

Probe: ES3DV2 - SN3022; ConvF(4.21, 4.21, 4.21); Calibrated: 9/21/2010

Sensor-Surface: 3mm (Mechanical Surface Detection)

Electronics: DAE4 Sn704; Calibrated: 3/17/2011

Phantom: SAM Sub Dasy B; Type: SAM 4.0; Serial: TP-1626

Measurement SW: DASY4, V4.7 Build 80; Postprocessing SW: SEMCAD, V1.8 Build 186

2450MHz System Verification

Area Scan (5x7x1): Measurement grid: dx=15mm, dy=15mm

Zoom Scan (5x5x7)/Cube 0: Measurement grid: dx=8mm, dy=8mm, dz=5mm

Input Power = 12 dBm (15.8 mW)

SAR(1 g) = 0.870 mW/g; SAR(10 g) = 0.408 mW/g

Deviation = 3.31 %

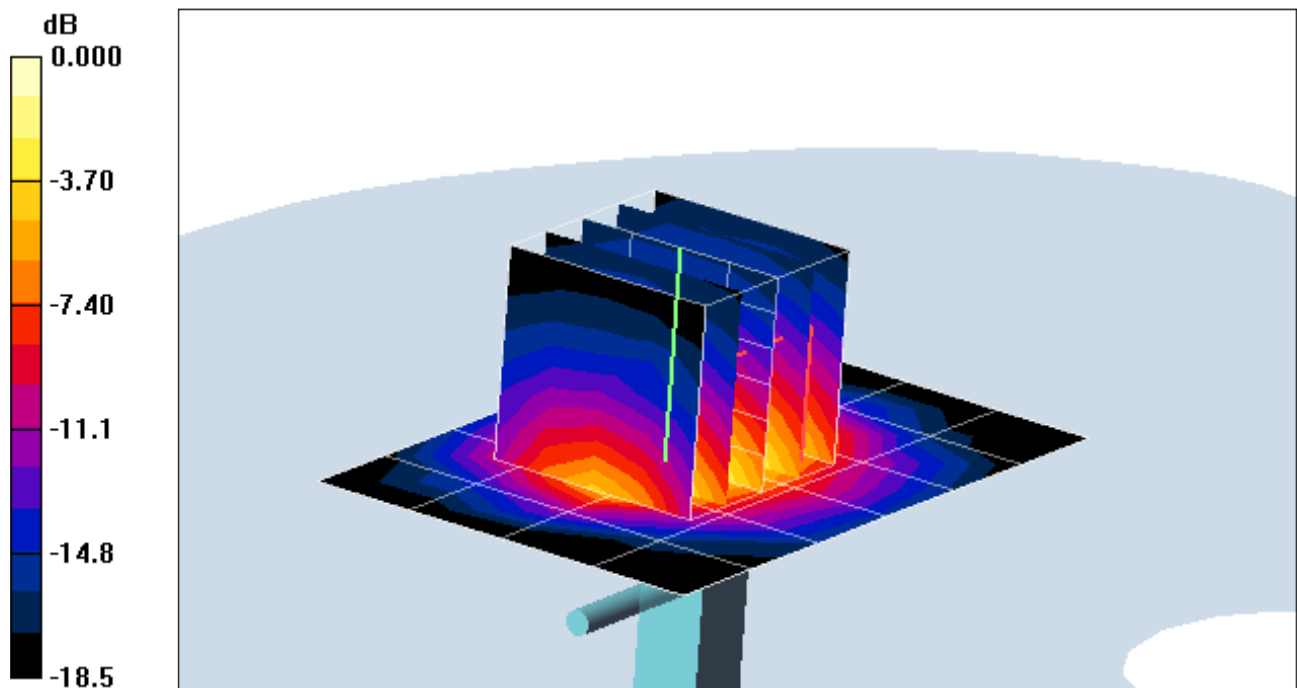

0 dB = 1.12mW/g

PCTEST ENGINEERING LABORATORY, INC.

DUT: SAR Dipole 2450 MHz; Type: D2450V2; Serial: 797

Communication System: CW; Frequency: 2450 MHz; Duty Cycle: 1:1

Medium: 2450 Body Medium parameters used:

$f = 2450 \text{ MHz}$; $\sigma = 2.03 \text{ mho/m}$; $\epsilon_r = 50.8$; $\rho = 1000 \text{ kg/m}^3$

Phantom section: Flat Section; Space: 1.0 cm

Test Date: 06-01-2011; Ambient Temp: 23.9 °C; Tissue Temp: 22.3°C

Probe: ES3DV2 - SN3022; ConvF(4.06, 4.06, 4.06); Calibrated: 9/21/2010

Sensor-Surface: 3mm (Mechanical Surface Detection)

Electronics: DAE4 Sn704; Calibrated: 3/17/2011

Phantom: SAM with CRP; Type: SAM; Serial: TP1375

Measurement SW: DASY4, V4.7 Build 80; Postprocessing SW: SEMCAD, V1.8 Build 186

2450MHz System Verification

Area Scan (5x7x1): Measurement grid: dx=15mm, dy=15mm

Zoom Scan (5x5x7)/Cube 0: Measurement grid: dx=8mm, dy=8mm, dz=5mm

Input Power = 12.0 dBm (15.8 mW)

SAR(1 g) = 0.864 mW/g; SAR(10 g) = 0.395 mW/g

Deviations = 4.56 %

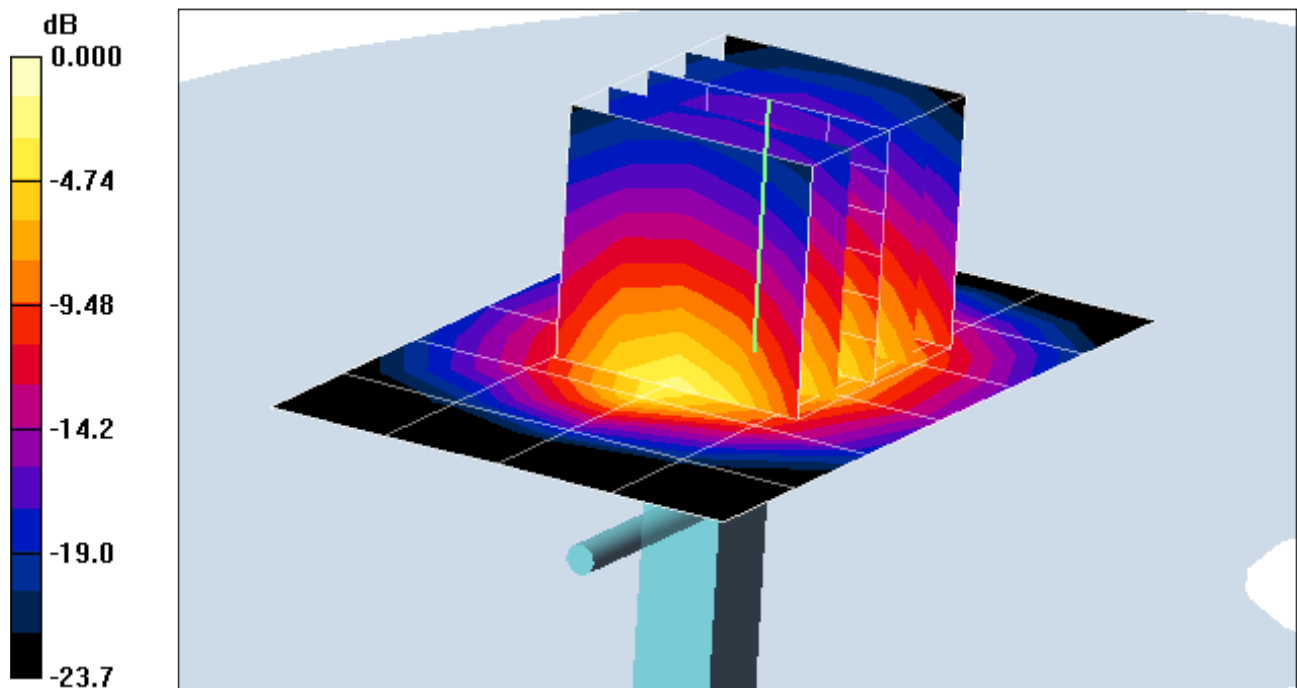

0 dB = 1.14mW/g

PCTEST ENGINEERING LABORATORY, INC.

DUT: SAR Dipole 2450 MHz; Type: D2450V2; Serial: 797

Communication System: CW; Frequency: 2450 MHz; Duty Cycle: 1:1

Medium: 2450 Body Medium parameters used:

$f = 2450 \text{ MHz}$; $\sigma = 1.98 \text{ mho/m}$; $\epsilon_r = 51$; $\rho = 1000 \text{ kg/m}^3$

Phantom section: Flat Section; Space: 1.0 cm

Test Date: 06-07-2011; Ambient Temp: 24.9°C; Tissue Temp: 23.0°C

Probe: ES3DV2 - SN3022; ConvF(4.06, 4.06, 4.06); Calibrated: 9/21/2010

Sensor-Surface: 3mm (Mechanical Surface Detection)

Electronics: DAE4 Sn704; Calibrated: 3/17/2011

Phantom: SAM with CRP; Type: SAM; Serial: TP1375

Measurement SW: DASY4, V4.7 Build 80; Postprocessing SW: SEMCAD, V1.8 Build 186

2450MHz System Verification

Area Scan (5x7x1): Measurement grid: dx=15mm, dy=15mm

Zoom Scan (5x5x7)/Cube 0: Measurement grid: dx=8mm, dy=8mm, dz=5mm

Input Power = 12.0 dBm (15.8 mW)

SAR(1 g) = 0.804 mW/g; SAR(10 g) = 0.370 mW/g

Deviation = -2.70 %

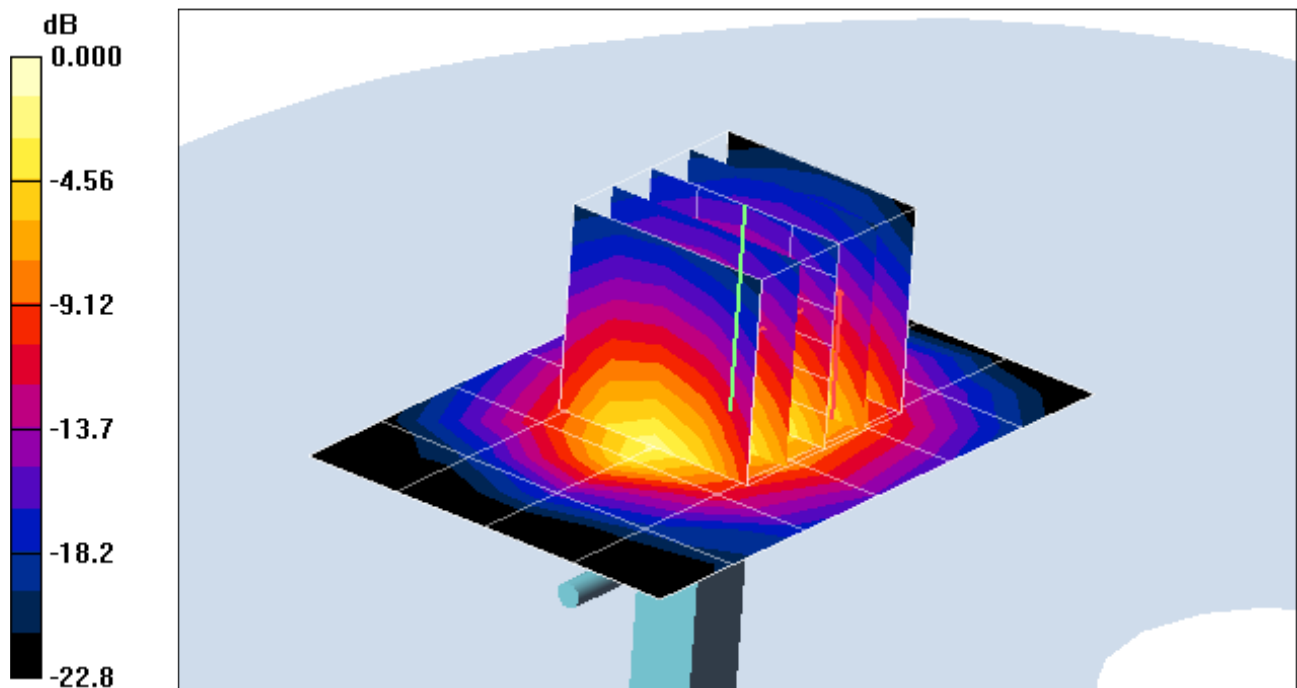

0 dB = 1.05mW/g

APPENDIX C: PROBE CALIBRATION



Accredited by the Swiss Accreditation Service (SAS)
The Swiss Accreditation Service is one of the signatories to the EA
Multilateral Agreement for the recognition of calibration certificates

Accreditation No.: **SCS 108**

Client **PC Test**

Certificate No: **ES3-3022_Sep10**

CALIBRATION CERTIFICATE

Object **ES3DV2 - SN:3022**

Calibration procedure(s) **QA CAL-01.v6, QA CAL-23.v3 and QA CAL-25.v2
Calibration procedure for dosimetric E-field probes**

Calibration date: **September 21, 2010**

✓
KOK
9/29/10

This calibration certificate documents the traceability to national standards, which realize the physical units of measurements (SI).
The measurements and the uncertainties with confidence probability are given on the following pages and are part of the certificate.

All calibrations have been conducted in the closed laboratory facility: environment temperature (22 ± 3)°C and humidity < 70%.

Calibration Equipment used (M&TE critical for calibration)

Primary Standards	ID #	Cal Date (Certificate No.)	Scheduled Calibration
Power meter E4419B	GB41293874	1-Apr-10 (No. 217-01136)	Apr-11
Power sensor E4412A	MY41495277	1-Apr-10 (No. 217-01136)	Apr-11
Power sensor E4412A	MY41498087	1-Apr-10 (No. 217-01136)	Apr-11
Reference 3 dB Attenuator	SN: S5054 (3c)	30-Mar-10 (No. 217-01159)	Mar-11
Reference 20 dB Attenuator	SN: S5086 (20b)	30-Mar-10 (No. 217-01161)	Mar-11
Reference 30 dB Attenuator	SN: S5129 (30b)	30-Mar-10 (No. 217-01160)	Mar-11
Reference Probe ES3DV2	SN: 3013	30-Dec-09 (No. ES3-3013_Dec09)	Dec-10
DAE4	SN: 660	20-Apr-10 (No. DAE4-660_Apr10)	Apr-11
Secondary Standards	ID #	Check Date (in house)	Scheduled Check
RF generator HP 8648C	US3642U01700	4-Aug-99 (in house check Oct-09)	In house check: Oct-11
Network Analyzer HP 8753E	US37390585	18-Oct-01 (in house check Oct-09)	In house check: Oct10

	Name	Function	Signature
Calibrated by:	Jeton Kastrati	Laboratory Technician	
Approved by:	Katja Pokovic	Technical Manager	

Issued: September 22, 2010

This calibration certificate shall not be reproduced except in full without written approval of the laboratory.



Accredited by the Swiss Accreditation Service (SAS)
The Swiss Accreditation Service is one of the signatories to the EA
Multilateral Agreement for the recognition of calibration certificates

Accreditation No.: **SCS 108**

Glossary:

TSL	tissue simulating liquid
NORM _{x,y,z}	sensitivity in free space
ConvF	sensitivity in TSL / NORM _{x,y,z}
DCP	diode compression point
CF	crest factor (1/duty_cycle) of the RF signal
A, B, C	modulation dependent linearization parameters
Polarization φ	φ rotation around probe axis
Polarization ϑ	ϑ rotation around an axis that is in the plane normal to probe axis (at measurement center), i.e., $\vartheta = 0$ is normal to probe axis

Calibration is Performed According to the Following Standards:

- IEEE Std 1528-2003, "IEEE Recommended Practice for Determining the Peak Spatial-Averaged Specific Absorption Rate (SAR) in the Human Head from Wireless Communications Devices: Measurement Techniques", December 2003
- IEC 62209-1, "Procedure to measure the Specific Absorption Rate (SAR) for hand-held devices used in close proximity to the ear (frequency range of 300 MHz to 3 GHz)", February 2005

Methods Applied and Interpretation of Parameters:

- NORM_{x,y,z}**: Assessed for E-field polarization $\vartheta = 0$ ($f \leq 900$ MHz in TEM-cell; $f > 1800$ MHz: R22 waveguide). NORM_{x,y,z} are only intermediate values, i.e., the uncertainties of NORM_{x,y,z} does not effect the E^2 -field uncertainty inside TSL (see below *ConvF*).
- NORM(f)_{x,y,z} = NORM_{x,y,z} * frequency_response** (see Frequency Response Chart). This linearization is implemented in DASY4 software versions later than 4.2. The uncertainty of the frequency response is included in the stated uncertainty of *ConvF*.
- DCP_{x,y,z}**: DCP are numerical linearization parameters assessed based on the data of power sweep with CW signal (no uncertainty required). DCP does not depend on frequency nor media.
- A_{x,y,z}; B_{x,y,z}; C_{x,y,z}; VR_{x,y,z}; A, B, C** are numerical linearization parameters assessed based on the data of power sweep for specific modulation signal. The parameters do not depend on frequency nor media. VR is the maximum calibration range expressed in RMS voltage across the diode.
- ConvF and Boundary Effect Parameters**: Assessed in flat phantom using E-field (or Temperature Transfer Standard for $f \leq 800$ MHz) and inside waveguide using analytical field distributions based on power measurements for $f > 800$ MHz. The same setups are used for assessment of the parameters applied for boundary compensation (alpha, depth) of which typical uncertainty values are given. These parameters are used in DASY4 software to improve probe accuracy close to the boundary. The sensitivity in TSL corresponds to **NORM_{x,y,z} * ConvF** whereby the uncertainty corresponds to that given for *ConvF*. A frequency dependent *ConvF* is used in DASY version 4.4 and higher which allows extending the validity from ± 50 MHz to ± 100 MHz.
- Spherical isotropy (3D deviation from isotropy)**: in a field of low gradients realized using a flat phantom exposed by a patch antenna.
- Sensor Offset**: The sensor offset corresponds to the offset of virtual measurement center from the probe tip (on probe axis). No tolerance required.

Probe ES3DV2

SN:3022

Manufactured:	April 15, 2003
Last calibrated:	September 18, 2009
Recalibrated:	September 21, 2010

Calibrated for DASY/EASY Systems

(Note: non-compatible with DASY2 system!)

DASY/EASY - Parameters of Probe: ES3DV2 SN:3022

Basic Calibration Parameters

	Sensor X	Sensor Y	Sensor Z	Unc (k=2)
Norm ($\mu\text{V}/(\text{V}/\text{m})^2$) ^A	1.01	1.05	1.01	± 10.1%
DCP (mV) ^B	92.8	92.5	89.7	

Modulation Calibration Parameters

UID	Communication System Name	PAR		A dB	B dBuV	C	VR mV	Unc ^E (k=2)
10000	CW	0.00	X	0.00	0.00	1.00	300.0	± 1.5%
			Y	0.00	0.00	1.00	300.0	
			Z	0.00	0.00	1.00	300.0	

The reported uncertainty of measurement is stated as the standard uncertainty of measurement multiplied by the coverage factor k=2, which for a normal distribution corresponds to a coverage probability of approximately 95%.

^A The uncertainties of NormX,Y,Z do not affect the E²-field uncertainty inside TSL (see Pages 5 and 6).

^B Numerical linearization parameter: uncertainty not required.

^E Uncertainty is determined using the maximum deviation from linear response applying recatangular distribution and is expressed for the square of the field value.

DASY/EASY - Parameters of Probe: ES3DV2 SN:3022

Calibration Parameter Determined in Head Tissue Simulating Media

f [MHz]	Validity [MHz] ^c	Permittivity	Conductivity	ConvF X	ConvF Y	ConvF Z	Alpha	Depth Unc (k=2)
750	± 50 / ± 100	41.9 ± 5%	0.89 ± 5%	6.32	6.32	6.32	0.87	1.01 ± 11.0%
835	± 50 / ± 100	41.5 ± 5%	0.90 ± 5%	6.02	6.02	6.02	0.62	1.20 ± 11.0%
1750	± 50 / ± 100	40.1 ± 5%	1.37 ± 5%	5.01	5.01	5.01	0.27	2.23 ± 11.0%
1900	± 50 / ± 100	40.0 ± 5%	1.40 ± 5%	4.83	4.83	4.83	0.25	2.29 ± 11.0%
2450	± 50 / ± 100	39.2 ± 5%	1.80 ± 5%	4.21	4.21	4.21	0.25	2.62 ± 11.0%
2600	± 50 / ± 100	39.0 ± 5%	1.96 ± 5%	4.14	4.14	4.14	0.25	2.64 ± 11.0%

^c The validity of ± 100 MHz only applies for DASY v4.4 and higher (see Page 2). The uncertainty is the RSS of the ConvF uncertainty at calibration frequency and the uncertainty for the indicated frequency band.

DASY/EASY - Parameters of Probe: ES3DV2 SN:3022

Calibration Parameter Determined in Body Tissue Simulating Media

f [MHz]	Validity [MHz] ^c	Permittivity	Conductivity	ConvF X	ConvF Y	ConvF Z	Alpha	Depth Unc (k=2)
750	± 50 / ± 100	55.5 ± 5%	0.96 ± 5%	6.09	6.09	6.09	0.68	1.20 ± 11.0%
835	± 50 / ± 100	55.2 ± 5%	0.97 ± 5%	5.89	5.89	5.89	0.65	1.20 ± 11.0%
1750	± 50 / ± 100	53.4 ± 5%	1.49 ± 5%	4.59	4.59	4.59	0.23	2.83 ± 11.0%
1900	± 50 / ± 100	53.3 ± 5%	1.52 ± 5%	4.34	4.34	4.34	0.22	3.71 ± 11.0%
2450	± 50 / ± 100	52.7 ± 5%	1.95 ± 5%	4.06	4.06	4.06	0.41	1.42 ± 11.0%
2600	± 50 / ± 100	52.5 ± 5%	2.16 ± 5%	4.06	4.06	4.06	0.53	1.23 ± 11.0%

^c The validity of ± 100 MHz only applies for DASY v4.4 and higher (see Page 2). The uncertainty is the RSS of the ConvF uncertainty at calibration frequency and the uncertainty for the indicated frequency band.

Frequency Response of E-Field

(TEM-Cell:ifi110 EXX, Waveguide: R22)

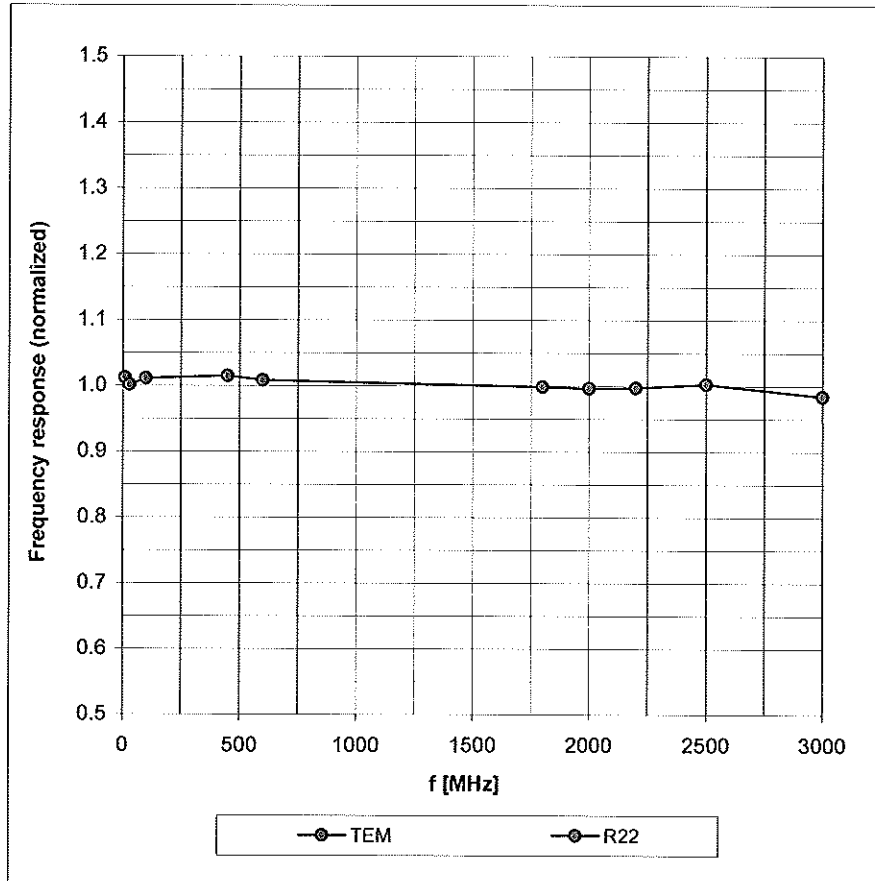

Uncertainty of Frequency Response of E-field: $\pm 6.3\%$ ($k=2$)

Receiving Pattern (ϕ), $\vartheta = 0^\circ$

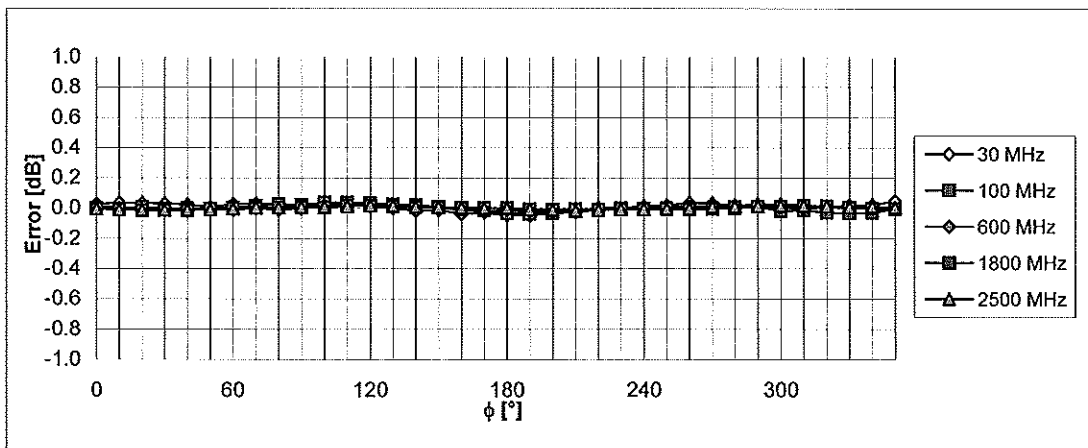
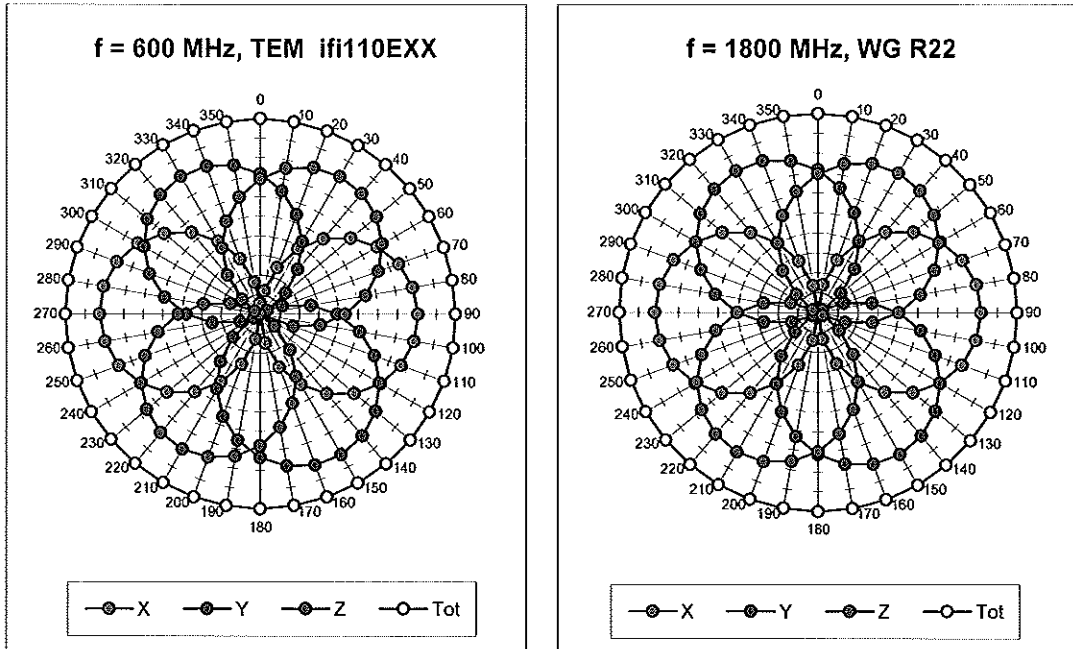

Uncertainty of Axial Isotropy Assessment: $\pm 0.5\%$ ($k=2$)

Dynamic Range $f(SAR_{head})$ (Waveguide R22, $f = 1800$ MHz)

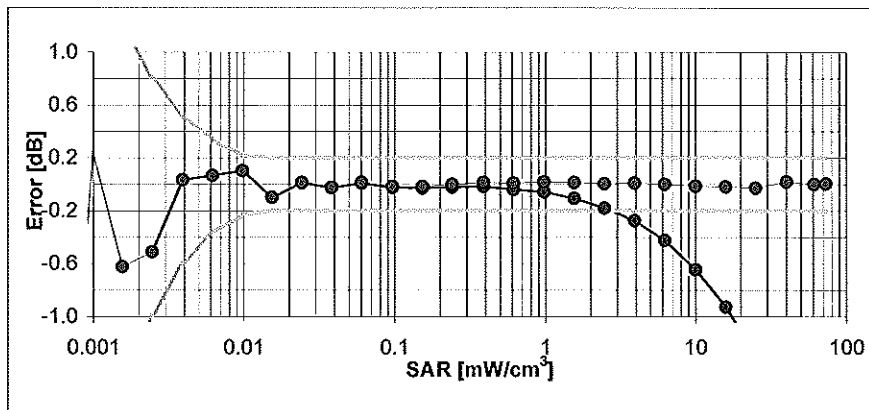
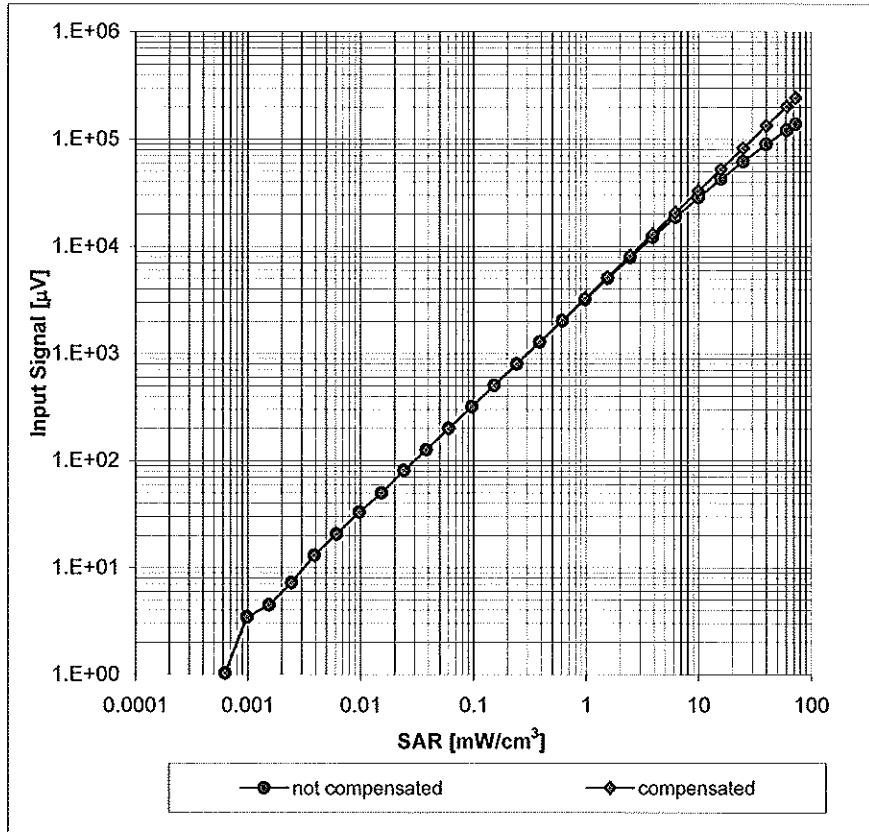

Uncertainty of Linearity Assessment: $\pm 0.6\%$ ($k=2$)

Conversion Factor Assessment

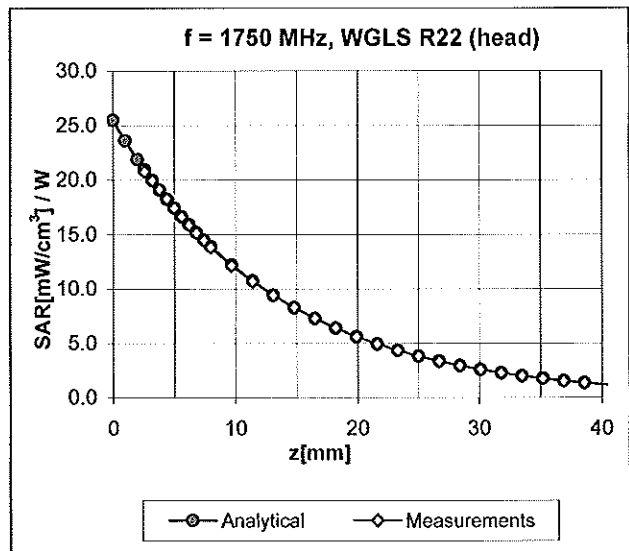
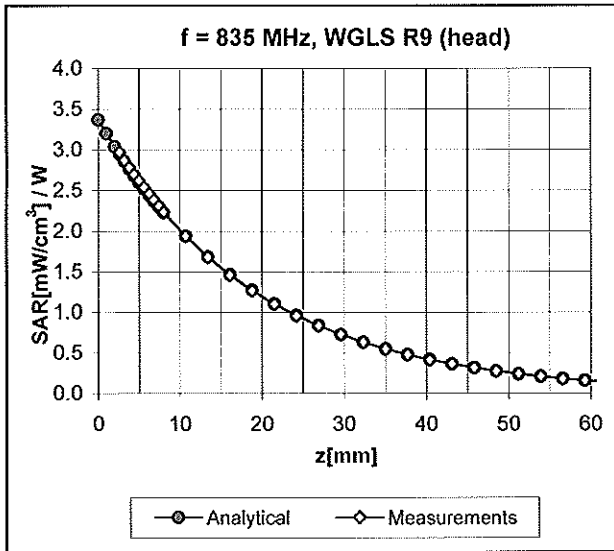

Deviation from Isotropy in HSL

Error (ϕ , θ), f = 900 MHz

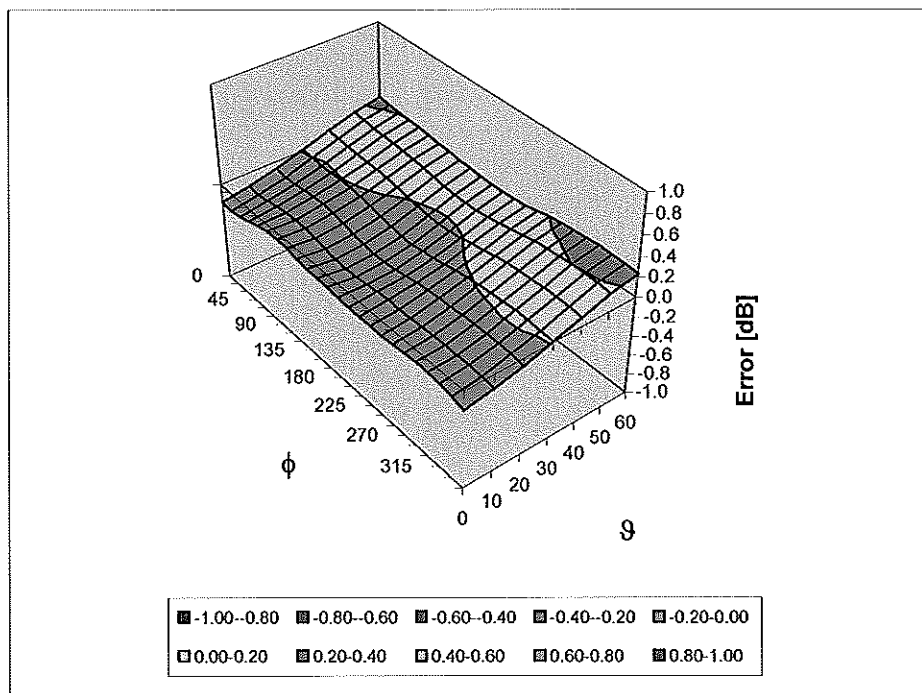

Uncertainty of Spherical Isotropy Assessment: $\pm 2.6\%$ (k=2)

Other Probe Parameters

Sensor Arrangement	Triangular
Connector Angle (°)	Not applicable
Mechanical Surface Detection Mode	enabled
Optical Surface Detection Mode	disabled
Probe Overall Length	337 mm
Probe Body Diameter	10 mm
Tip Length	10 mm
Tip Diameter	4.0 mm
Probe Tip to Sensor X Calibration Point	2 mm
Probe Tip to Sensor Y Calibration Point	2 mm
Probe Tip to Sensor Z Calibration Point	2 mm
Recommended Measurement Distance from Surface	3 mm



Accredited by the Swiss Accreditation Service (SAS)
The Swiss Accreditation Service is one of the signatories to the EA
Multilateral Agreement for the recognition of calibration certificates

Accreditation No.: **SCS 108**

Client **PC Test**

Certificate No: **EX-3550_Feb11**

CALIBRATION CERTIFICATE

Object: **EX3DV4 - SN:3550**

Calibration procedure(s): **QA CAL-01.v7, QA CAL-14.v3, QA CAL-23.v4, QA CAL-25.v3
Calibration procedure for dosimetric E-field probes**

Calibration date: **February 14, 2011**

This calibration certificate documents the traceability to national standards, which realize the physical units of measurements (SI).
The measurements and the uncertainties with confidence probability are given on the following pages and are part of the certificate.

All calibrations have been conducted in the closed laboratory facility: environment temperature (22 ± 3)°C and humidity < 70%.

Calibration Equipment used (M&TE critical for calibration)

✓
KOK
2/22/11

Primary Standards	ID	Cal Date (Certificate No.)	Scheduled Calibration
Power meter E4419B	GB41293874	01-Apr-10 (No. 217-01136)	Apr-11
Power sensor E4412A	MY41495277	01-Apr-10 (No. 217-01136)	Apr-11
Power sensor E4412A	MY41498087	01-Apr-10 (No. 217-01136)	Apr-11
Reference 3 dB Attenuator	SN: S5054 (3c)	30-Mar-10 (No. 217-01159)	Mar-11
Reference 20 dB Attenuator	SN: S5086 (20b)	30-Mar-10 (No. 217-01161)	Mar-11
Reference 30 dB Attenuator	SN: S5129 (30b)	30-Mar-10 (No. 217-01160)	Mar-11
Reference Probe ES3DV2	SN: 3013	29-Dec-10 (No. ES3-3013_Dec10)	Dec-11
DAE4	SN: 654	23-Apr-10 (No. DAE4-654_Apr10)	Apr-11
Secondary Standards	ID	Check Date (in house)	Scheduled Check
RF generator HP 8648C	US3642U01700	4-Aug-99 (in house check Oct-09)	In house check: Oct-11
Network Analyzer HP 8753E	US37390585	18-Oct-01 (in house check Oct-10)	In house check: Oct-11

	Name	Function	Signature
Calibrated by:	Katja Pokovic	Technical Manager	
Approved by:	Niels Kuster	Quality Manager	

Issued: February 14, 2011

This calibration certificate shall not be reproduced except in full without written approval of the laboratory.



Accredited by the Swiss Accreditation Service (SAS)

Accreditation No.: **SCS 108**

The Swiss Accreditation Service is one of the signatories to the EA Multilateral Agreement for the recognition of calibration certificates

Glossary:

TSL	tissue simulating liquid
NORM _{x,y,z}	sensitivity in free space
ConvF	sensitivity in TSL / NORM _{x,y,z}
DCP	diode compression point
CF	crest factor (1/duty_cycle) of the RF signal
A, B, C	modulation dependent linearization parameters
Polarization ω	ω rotation around probe axis
Polarization ϑ	ϑ rotation around an axis that is in the plane normal to probe axis (at measurement center), i.e., $\vartheta = 0$ is normal to probe axis

Calibration is Performed According to the Following Standards:

- IEEE Std 1528-2003, "IEEE Recommended Practice for Determining the Peak Spatial-Averaged Specific Absorption Rate (SAR) in the Human Head from Wireless Communications Devices: Measurement Techniques", December 2003
- IEC 62209-1, "Procedure to measure the Specific Absorption Rate (SAR) for hand-held devices used in close proximity to the ear (frequency range of 300 MHz to 3 GHz)", February 2005

Methods Applied and Interpretation of Parameters:

- NORM_{x,y,z}**: Assessed for E-field polarization $\vartheta = 0$ ($f \leq 900$ MHz in TEM-cell; $f > 1800$ MHz: R22 waveguide). NORM_{x,y,z} are only intermediate values, i.e., the uncertainties of NORM_{x,y,z} does not affect the E²-field uncertainty inside TSL (see below ConvF).
- NORM(f)_{x,y,z} = NORM_{x,y,z} * frequency_response** (see Frequency Response Chart). This linearization is implemented in DASY4 software versions later than 4.2. The uncertainty of the frequency response is included in the stated uncertainty of ConvF.
- DCP_{x,y,z}**: DCP are numerical linearization parameters assessed based on the data of power sweep with CW signal (no uncertainty required). DCP does not depend on frequency nor media.
- PAR**: PAR is the Peak to Average Ratio that is not calibrated but determined based on the signal characteristics
- A_{x,y,z}; B_{x,y,z}; C_{x,y,z}** are numerical linearization parameters in dB assessed based on the data of power sweep for specific modulation signal. The parameters do not depend on frequency nor media.
- VR**: VR is the validity range of the calibration related to the average diode voltage or DAE voltage in mV.
- ConvF and Boundary Effect Parameters**: Assessed in flat phantom using E-field (or Temperature Transfer Standard for $f \leq 800$ MHz) and inside waveguide using analytical field distributions based on power measurements for $f > 800$ MHz. The same setups are used for assessment of the parameters applied for boundary compensation (alpha, depth) of which typical uncertainty values are given. These parameters are used in DASY4 software to improve probe accuracy close to the boundary. The sensitivity in TSL corresponds to NORM_{x,y,z} * ConvF whereby the uncertainty corresponds to that given for ConvF. A frequency dependent ConvF is used in DASY version 4.4 and higher which allows extending the validity from ± 50 MHz to ± 100 MHz.
- Spherical isotropy (3D deviation from isotropy)**: in a field of low gradients realized using a flat phantom exposed by a patch antenna.
- Sensor Offset**: The sensor offset corresponds to the offset of virtual measurement center from the probe tip (on probe axis). No tolerance required.

Probe EX3DV4

SN:3550

Manufactured: May 19, 2004
Calibrated: February 14, 2011

Calibrated for DASY/EASY Systems
(Note: non-compatible with DASY2 system!)

DASY/EASY - Parameters of Probe: EX3DV4 - SN:3550

Basic Calibration Parameters

	Sensor X	Sensor Y	Sensor Z	Unc (k=2)
Norm ($\mu\text{V}/(\text{V}/\text{m})^2$) ^A	0.52	0.45	0.50	$\pm 10.1 \%$
DCP (mV) ^B	100.3	98.8	99.0	

Modulation Calibration Parameters

UID	Communication System Name	PAR		A dB	B dB	C dB	VR mV	Unc ^E (k=2)
10000	CW	0.00	X	0.00	0.00	1.00	110.7	$\pm 2.2 \%$
			Y	0.00	0.00	1.00	145.7	
			Z	0.00	0.00	1.00	148.8	

The reported uncertainty of measurement is stated as the standard uncertainty of measurement multiplied by the coverage factor $k=2$, which for a normal distribution corresponds to a coverage probability of approximately 95%.

^A The uncertainties of NormX,Y,Z do not affect the E^2 -field uncertainty inside TSL (see Pages 5 and 6).

^B Numerical linearization parameter: uncertainty not required.

^E Uncertainty is determined using the max. deviation from linear response applying rectangular distribution and is expressed for the square of the field value.

DASY/EASY - Parameters of Probe: EX3DV4 - SN:3550

Calibration Parameter Determined in Head Tissue Simulating Media

f (MHz) ^C	Relative Permittivity ^F	Conductivity (S/m) ^F	ConvF X	ConvF Y	ConvF Z	Alpha	Depth (mm)	Unct. (k=2)
750	41.9	0.89	8.42	8.42	8.42	0.48	0.69	± 12.0 %
835	41.5	0.90	8.04	8.04	8.04	0.33	0.84	± 12.0 %
1750	40.1	1.37	7.33	7.33	7.33	0.46	0.65	± 12.0 %
1900	40.0	1.40	7.01	7.01	7.01	0.42	0.72	± 12.0 %
2450	39.2	1.80	6.29	6.29	6.29	0.13	1.57	± 12.0 %
2600	39.0	1.96	6.13	6.13	6.13	0.20	1.32	± 12.0 %
4950	36.3	4.40	4.37	4.37	4.37	0.35	1.80	± 13.1 %
5200	36.0	4.66	4.06	4.06	4.06	0.35	1.80	± 13.1 %
5300	35.9	4.76	3.92	3.92	3.92	0.35	1.80	± 13.1 %
5500	35.6	4.96	3.77	3.77	3.77	0.35	1.80	± 13.1 %
5600	35.5	5.07	3.50	3.50	3.50	0.40	1.80	± 13.1 %
5800	35.3	5.27	3.64	3.64	3.64	0.40	1.80	± 13.1 %

^C Frequency validity of ± 100 MHz only applies for DASY v4.4 and higher (see Page 2), else it is restricted to ± 50 MHz. The uncertainty is the RSS of the ConvF uncertainty at calibration frequency and the uncertainty for the indicated frequency band.

^F At frequencies below 3 GHz, the validity of tissue parameters (ϵ and σ) can be relaxed to ± 10% if liquid compensation formula is applied to measured SAR values. At frequencies above 3 GHz, the validity of tissue parameters (ϵ and σ) is restricted to ± 5%. The uncertainty is the RSS of the ConvF uncertainty for indicated target tissue parameters.

DASY/EASY - Parameters of Probe: EX3DV4- SN:3550

Calibration Parameter Determined in Body Tissue Simulating Media

f (MHz) ^c	Relative Permittivity ^f	Conductivity (S/m) ^f	ConvF X	ConvF Y	ConvF Z	Alpha	Depth (mm)	Unct. (k=2)
750	55.5	0.96	8.18	8.18	8.18	0.23	1.09	± 12.0 %
835	55.2	0.97	8.11	8.11	8.11	0.25	1.05	± 12.0 %
1750	53.4	1.49	7.21	7.21	7.21	0.42	0.89	± 12.0 %
1900	53.3	1.52	6.77	6.77	6.77	0.35	0.84	± 12.0 %
2450	52.7	1.95	6.25	6.25	6.25	0.30	0.86	± 12.0 %
2600	52.5	2.16	5.98	5.98	5.98	0.21	1.03	± 12.0 %
3700	51.0	3.55	5.42	5.42	5.42	0.20	1.95	± 13.1 %
4950	49.4	5.01	3.72	3.72	3.72	0.45	1.90	± 13.1 %
5200	49.0	5.30	3.58	3.58	3.58	0.45	1.90	± 13.1 %
5300	48.9	5.42	3.31	3.31	3.31	0.48	1.90	± 13.1 %
5500	48.6	5.65	3.21	3.21	3.21	0.47	1.90	± 13.1 %
5600	48.5	5.77	3.19	3.19	3.19	0.45	1.90	± 13.1 %
5800	48.2	6.00	3.29	3.29	3.29	0.50	1.90	± 13.1 %

^c Frequency validity of ± 100 MHz only applies for DASY v4.4 and higher (see Page 2), else it is restricted to ± 50 MHz. The uncertainty is the RSS of the ConvF uncertainty at calibration frequency and the uncertainty for the indicated frequency band.

^f At frequencies below 3 GHz, the validity of tissue parameters (ϵ and σ) can be relaxed to ± 10% if liquid compensation formula is applied to measured SAR values. At frequencies above 3 GHz, the validity of tissue parameters (ϵ and σ) is restricted to ± 5%. The uncertainty is the RSS of the ConvF uncertainty for indicated target tissue parameters.

Frequency Response of E-Field

(TEM-Cell:ifi110 EXX, Waveguide: R22)

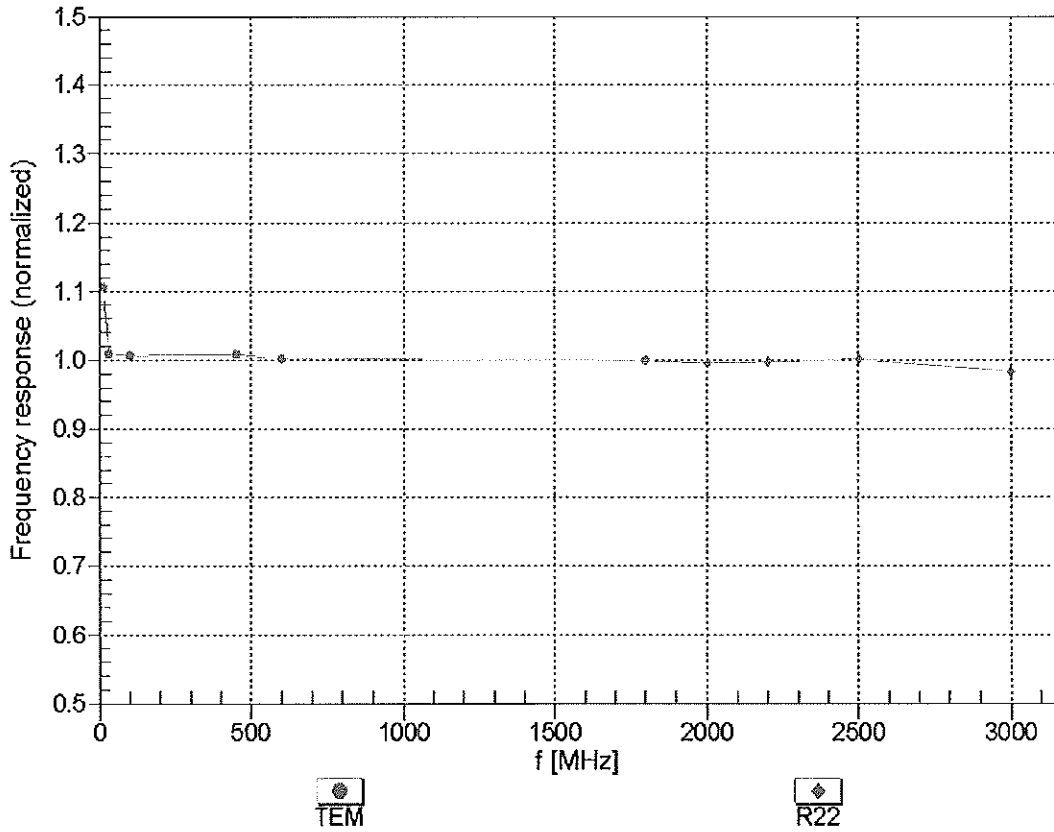

Uncertainty of Frequency Response of E-field: $\pm 6.3\%$ (k=2)

Receiving Pattern (ϕ), $\theta = 0^\circ$

f=600 MHz,TEM

f=1800 MHz,R22

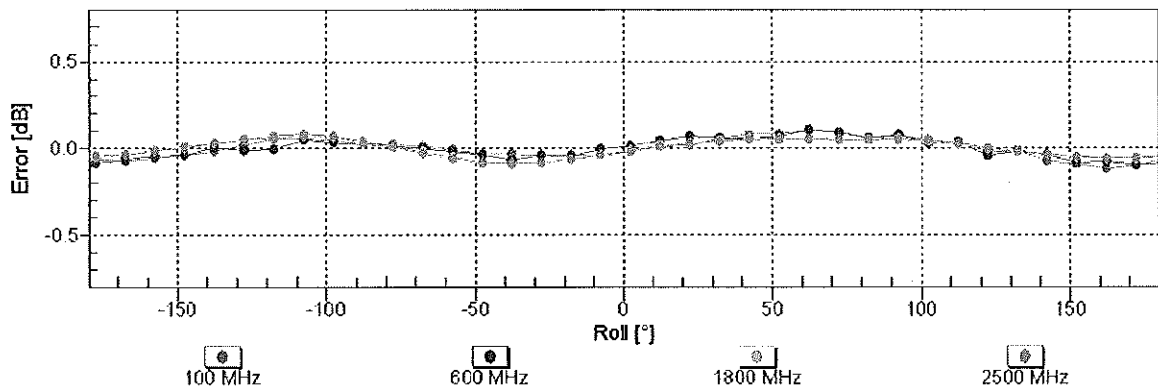
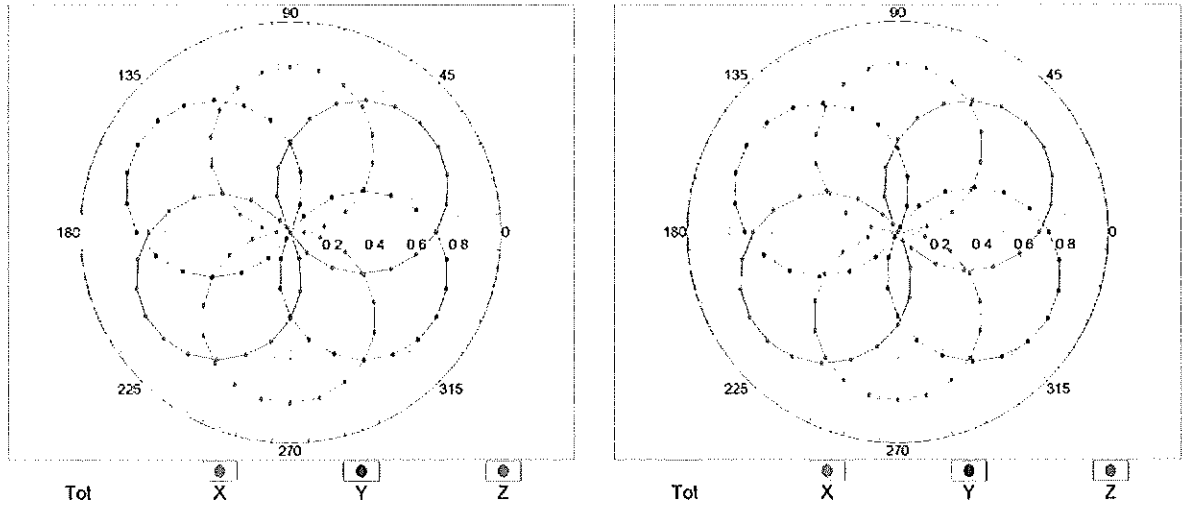

Uncertainty of Axial Isotropy Assessment: $\pm 0.5\%$ ($k=2$)

Dynamic Range $f(\text{SAR}_{\text{head}})$ (TEM cell , $f = 900 \text{ MHz}$)

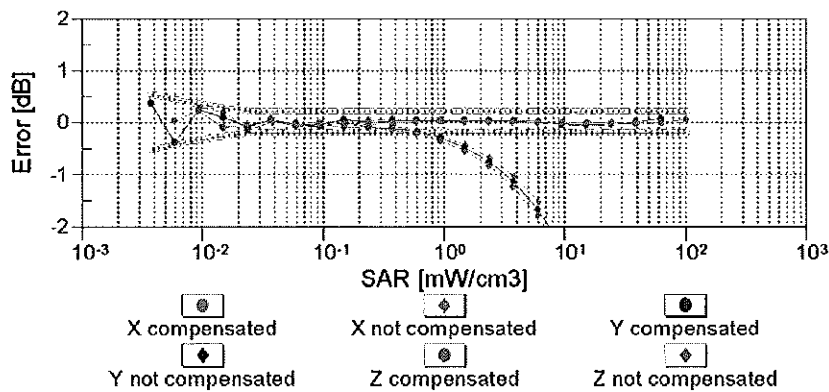
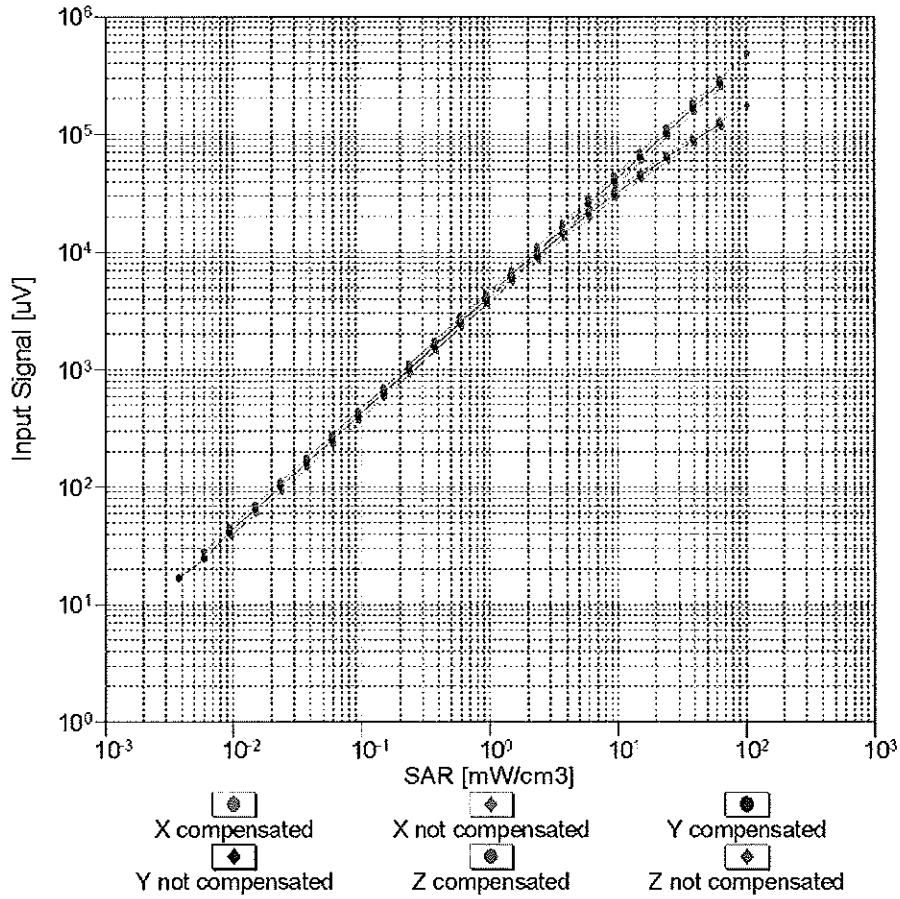

Uncertainty of Linearity Assessment: $\pm 0.6\%$ ($k=2$)

Conversion Factor Assessment

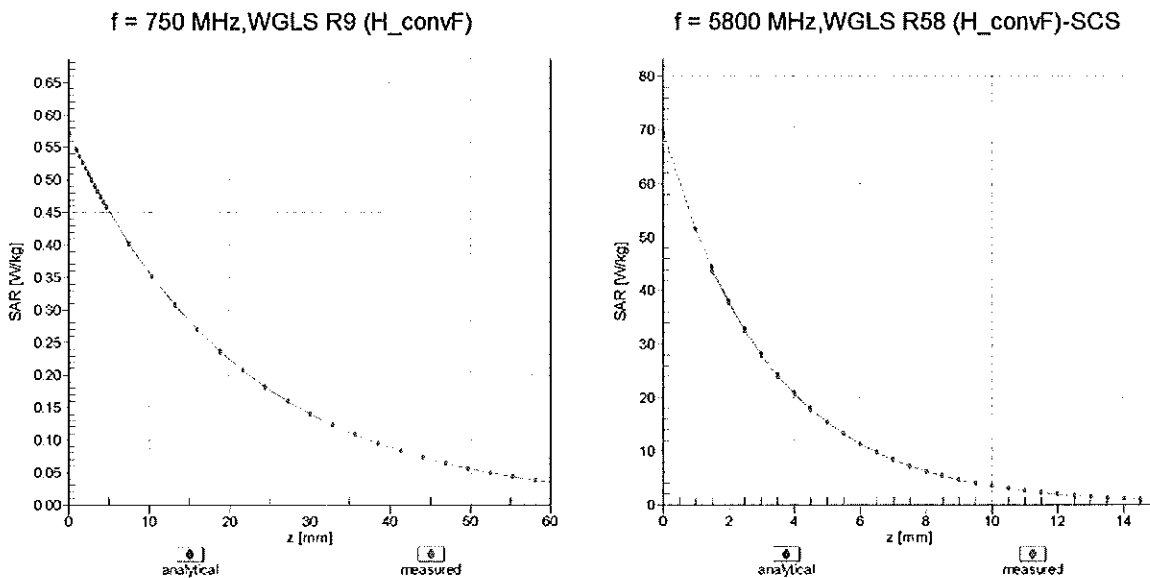

Deviation from Isotropy in Air Error (ϕ, ϑ), f = 900 MHz

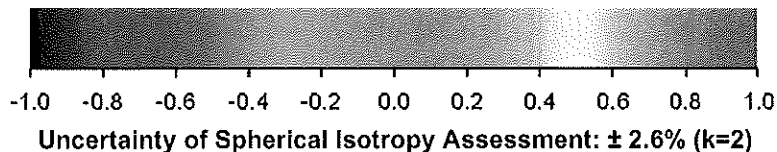
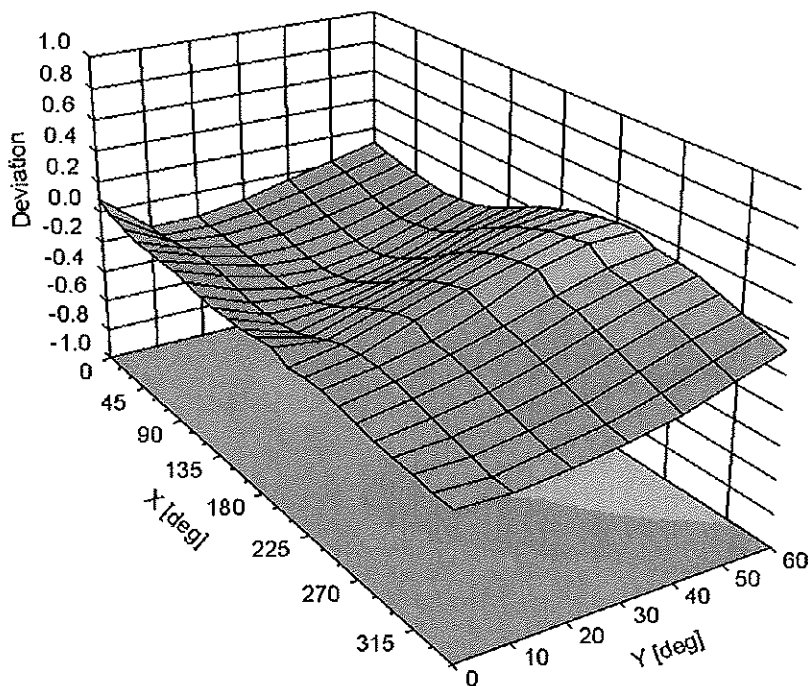

DASY/EASY - Parameters of Probe: EX3DV4 - SN:3550

Other Probe Parameters

Sensor Arrangement	Triangular
Connector Angle (°)	Not applicable
Mechanical Surface Detection Mode	enabled
Optical Surface Detection Mode	disabled
Probe Overall Length	337 mm
Probe Body Diameter	10 mm
Tip Length	9 mm
Tip Diameter	3 mm
Probe Tip to Sensor X Calibration Point	1 mm
Probe Tip to Sensor Y Calibration Point	1 mm
Probe Tip to Sensor Z Calibration Point	1 mm
Recommended Measurement Distance from Surface	2 mm



Accredited by the Swiss Accreditation Service (SAS)
The Swiss Accreditation Service is one of the signatories to the EA
Multilateral Agreement for the recognition of calibration certificates

Accreditation No.: SCS 108

Client **PC Test**

Certificate No: **EX3-3561_Aug10**

CALIBRATION CERTIFICATE

Object **EX3DV4 - SN:3561**

Calibration procedure(s) **QA CAL-01.v6, QA CAL-14.v3, QA CAL-23.v3 and QA CAL-25.v2
Calibration procedure for dosimetric E-field probes**

Calibration date: **August 19, 2010**

*KOK
8/30/10*

This calibration certificate documents the traceability to national standards, which realize the physical units of measurements (SI).
The measurements and the uncertainties with confidence probability are given on the following pages and are part of the certificate.

All calibrations have been conducted in the closed laboratory facility: environment temperature (22 ± 3)°C and humidity < 70%.

Calibration Equipment used (M&TE critical for calibration)

Primary Standards	ID #	Cal Date (Certificate No.)	Scheduled Calibration
Power meter E4419B	GB41293874	1-Apr-10 (No. 217-01136)	Apr-11
Power sensor E4412A	MY41495277	1-Apr-10 (No. 217-01136)	Apr-11
Power sensor E4412A	MY41498087	1-Apr-10 (No. 217-01136)	Apr-11
Reference 3 dB Attenuator	SN: S5054 (3c)	30-Mar-10 (No. 217-01159)	Mar-11
Reference 20 dB Attenuator	SN: S5086 (20b)	30-Mar-10 (No. 217-01161)	Mar-11
Reference 30 dB Attenuator	SN: S5129 (30b)	30-Mar-10 (No. 217-01160)	Mar-11
Reference Probe ES3DV2	SN: 3013	30-Dec-09 (No. ES3-3013_Dec09)	Dec-10
DAE4	SN: 660	20-Apr-10 (No. DAE4-660_Apr10)	Apr-11
Secondary Standards	ID #	Check Date (in house)	Scheduled Check
RF generator HP 8648C	US3642U01700	4-Aug-99 (in house check Oct-09)	In house check: Oct-11
Network Analyzer HP 8753E	US37390585	18-Oct-01 (in house check Oct-09)	In house check: Oct10

Calibrated by:	Name Katja Pokovic	Function Technical Manager	Signature
Approved by:	Name Niels Kuster	Function Quality Manager	Signature

Issued: August 20, 2010

This calibration certificate shall not be reproduced except in full without written approval of the laboratory.



Accredited by the Swiss Accreditation Service (SAS)
The Swiss Accreditation Service is one of the signatories to the EA
Multilateral Agreement for the recognition of calibration certificates

Accreditation No.: **SCS 108**

Glossary:

TSL	tissue simulating liquid
NORM _{x,y,z}	sensitivity in free space
ConvF	sensitivity in TSL / NORM _{x,y,z}
DCP	diode compression point
CF	crest factor (1/duty_cycle) of the RF signal
A, B, C	modulation dependent linearization parameters
Polarization φ	φ rotation around probe axis
Polarization ϑ	ϑ rotation around an axis that is in the plane normal to probe axis (at measurement center), i.e., $\vartheta = 0$ is normal to probe axis

Calibration is Performed According to the Following Standards:

- IEEE Std 1528-2003, "IEEE Recommended Practice for Determining the Peak Spatial-Averaged Specific Absorption Rate (SAR) in the Human Head from Wireless Communications Devices: Measurement Techniques", December 2003
- IEC 62209-1, "Procedure to measure the Specific Absorption Rate (SAR) for hand-held devices used in close proximity to the ear (frequency range of 300 MHz to 3 GHz)", February 2005

Methods Applied and Interpretation of Parameters:

- NORM_{x,y,z}**: Assessed for E-field polarization $\vartheta = 0$ ($f \leq 900$ MHz in TEM-cell; $f > 1800$ MHz: R22 waveguide). NORM_{x,y,z} are only intermediate values, i.e., the uncertainties of NORM_{x,y,z} does not effect the E²-field uncertainty inside TSL (see below ConvF).
- NORM(f)_{x,y,z}** = NORM_{x,y,z} * frequency_response (see Frequency Response Chart). This linearization is implemented in DASY4 software versions later than 4.2. The uncertainty of the frequency response is included in the stated uncertainty of ConvF.
- DCP_{x,y,z}**: DCP are numerical linearization parameters assessed based on the data of power sweep with CW signal (no uncertainty required). DCP does not depend on frequency nor media.
- A_{x,y,z}; B_{x,y,z}; C_{x,y,z}; VR_{x,y,z}**: A, B, C are numerical linearization parameters assessed based on the data of power sweep for specific modulation signal. The parameters do not depend on frequency nor media. VR is the maximum calibration range expressed in RMS voltage across the diode.
- ConvF and Boundary Effect Parameters**: Assessed in flat phantom using E-field (or Temperature Transfer Standard for $f \leq 800$ MHz) and inside waveguide using analytical field distributions based on power measurements for $f > 800$ MHz. The same setups are used for assessment of the parameters applied for boundary compensation (alpha, depth) of which typical uncertainty values are given. These parameters are used in DASY4 software to improve probe accuracy close to the boundary. The sensitivity in TSL corresponds to NORM_{x,y,z} * ConvF whereby the uncertainty corresponds to that given for ConvF. A frequency dependent ConvF is used in DASY version 4.4 and higher which allows extending the validity from ± 50 MHz to ± 100 MHz.
- Spherical isotropy (3D deviation from isotropy)**: in a field of low gradients realized using a flat phantom exposed by a patch antenna.
- Sensor Offset**: The sensor offset corresponds to the offset of virtual measurement center from the probe tip (on probe axis). No tolerance required.

Probe EX3DV4

SN:3561

Manufactured:	February 14, 2005
Last calibrated:	August 26, 2008
Recalibrated:	August 19, 2010

Calibrated for DASY/EASY Systems

(Note: non-compatible with DASY2 system!)

DASY/EASY - Parameters of Probe: EX3DV4 SN:3561**Basic Calibration Parameters**

	Sensor X	Sensor Y	Sensor Z	Unc (k=2)
Norm ($\mu\text{V}/(\text{V}/\text{m})^2$) ^A	0.45	0.48	0.43	$\pm 10.1\%$
DCP (mV) ^B	87.4	89.6	88.5	

Modulation Calibration Parameters

UID	Communication System Name	PAR		A dB	B dBuV	C	VR mV	Unc ^E (k=2)
10000	CW	0.00	X	0.00	0.00	1.00	300	$\pm 1.5\%$
			Y	0.00	0.00	1.00	300	
			Z	0.00	0.00	1.00	300	

The reported uncertainty of measurement is stated as the standard uncertainty of measurement multiplied by the coverage factor $k=2$, which for a normal distribution corresponds to a coverage probability of approximately 95%.

^A The uncertainties of NormX,Y,Z do not affect the \hat{E} field uncertainty inside TSL (see Pages 5 and 6).

^B Numerical linearization parameter: uncertainty not required.

^E Uncertainty is determined using the maximum deviation from linear response applying rectangular distribution and is expressed for the square of the field value

DASY/EASY - Parameters of Probe: EX3DV4 SN:3561

Calibration Parameter Determined in Head Tissue Simulating Media

f [MHz]	Validity [MHz] ^f	Permittivity	Conductivity	ConvF X	ConvF Y	ConvF Z	Alpha	Depth Unc (k=2)
750	± 50 / ± 100	41.9 ± 5%	0.89 ± 5%	8.36	8.36	8.36	0.76	0.64 ± 11.0%
835	± 50 / ± 100	41.5 ± 5%	0.90 ± 5%	7.96	7.96	7.96	0.75	0.64 ± 11.0%
1750	± 50 / ± 100	40.1 ± 5%	1.37 ± 5%	6.92	6.92	6.92	0.90	0.57 ± 11.0%
1900	± 50 / ± 100	40.0 ± 5%	1.40 ± 5%	6.69	6.69	6.69	0.76	0.63 ± 11.0%
2450	± 50 / ± 100	39.2 ± 5%	1.80 ± 5%	6.11	6.11	6.11	0.42	0.83 ± 11.0%
2600	± 50 / ± 100	39.0 ± 5%	1.96 ± 5%	6.09	6.09	6.09	0.36	0.93 ± 11.0%

^c The validity of ± 100 MHz only applies for DASY v4.4 and higher (see Page 2). The uncertainty is the RSS of the ConvF uncertainty at calibration frequency and the uncertainty for the indicated frequency band.

DASY/EASY - Parameters of Probe: EX3DV4 SN:3561

Calibration Parameter Determined in Body Tissue Simulating Media

f [MHz]	Validity [MHz] ^c	Permittivity	Conductivity	ConvF X	ConvF Y	ConvF Z	Alpha	Depth Unc (k=2)
835	± 50 / ± 100	55.2 ± 5%	0.97 ± 5%	8.09	8.09	8.09	0.74	0.65 ± 11.0%
1750	± 50 / ± 100	53.4 ± 5%	1.49 ± 5%	6.84	6.84	6.84	0.43	0.82 ± 11.0%
1900	± 50 / ± 100	53.3 ± 5%	1.52 ± 5%	6.59	6.59	6.59	0.56	0.71 ± 11.0%
2450	± 50 / ± 100	52.7 ± 5%	1.95 ± 5%	6.44	6.44	6.44	0.37	0.87 ± 11.0%
2600	± 50 / ± 100	52.5 ± 5%	2.16 ± 5%	6.45	6.45	6.45	0.37	0.95 ± 11.0%
4950	± 50 / ± 100	49.4 ± 5%	5.01 ± 5%	3.80	3.80	3.80	0.53	1.90 ± 13.1%
5200	± 50 / ± 100	49.0 ± 5%	5.30 ± 5%	3.67	3.67	3.67	0.60	1.95 ± 13.1%
5300	± 50 / ± 100	48.5 ± 5%	5.42 ± 5%	3.42	3.42	3.42	0.63	1.95 ± 13.1%
5500	± 50 / ± 100	48.6 ± 5%	5.65 ± 5%	3.31	3.31	3.31	0.63	1.95 ± 13.1%
5600	± 50 / ± 100	48.5 ± 5%	5.77 ± 5%	3.12	3.12	3.12	0.65	1.95 ± 13.1%
5800	± 50 / ± 100	48.2 ± 5%	6.00 ± 5%	3.25	3.25	3.25	0.65	1.95 ± 13.1%

^c The validity of ± 100 MHz only applies for DASY v4.4 and higher (see Page 2). The uncertainty is the RSS of the ConvF uncertainty at calibration frequency and the uncertainty for the indicated frequency band.

Frequency Response of E-Field

(TEM-Cell:ifi110 EXX, Waveguide: R22)

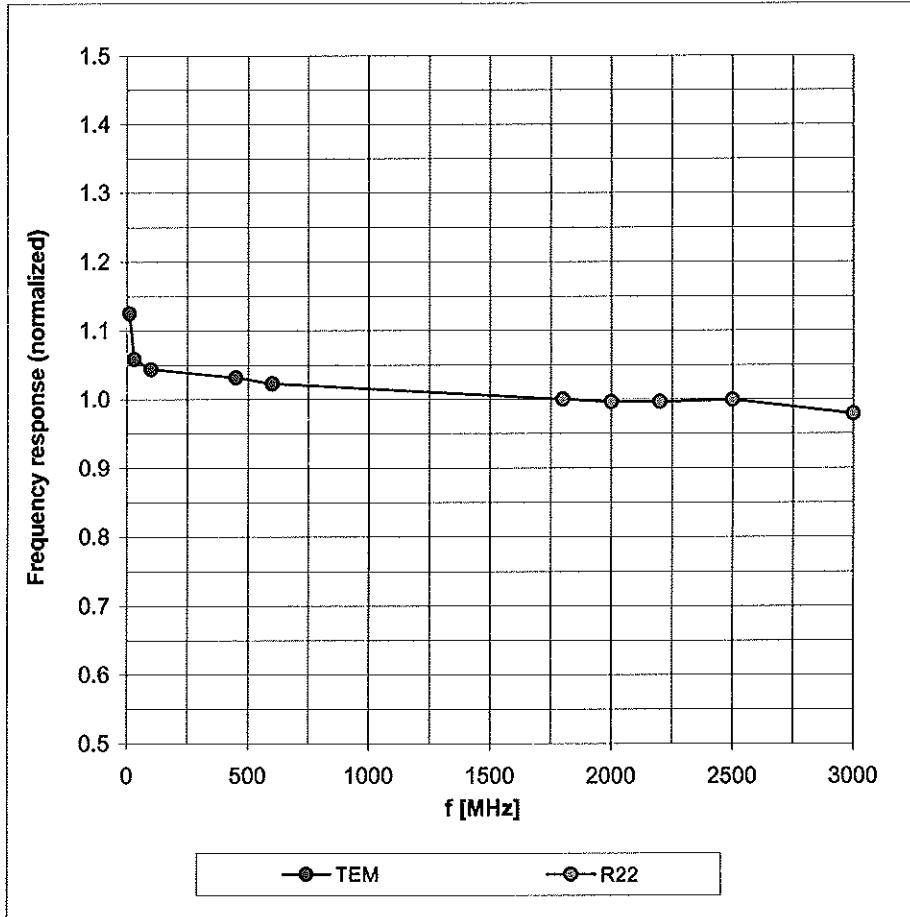

Uncertainty of Frequency Response of E-field: $\pm 6.3\%$ (k=2)

Receiving Pattern (ϕ), $\vartheta = 0^\circ$

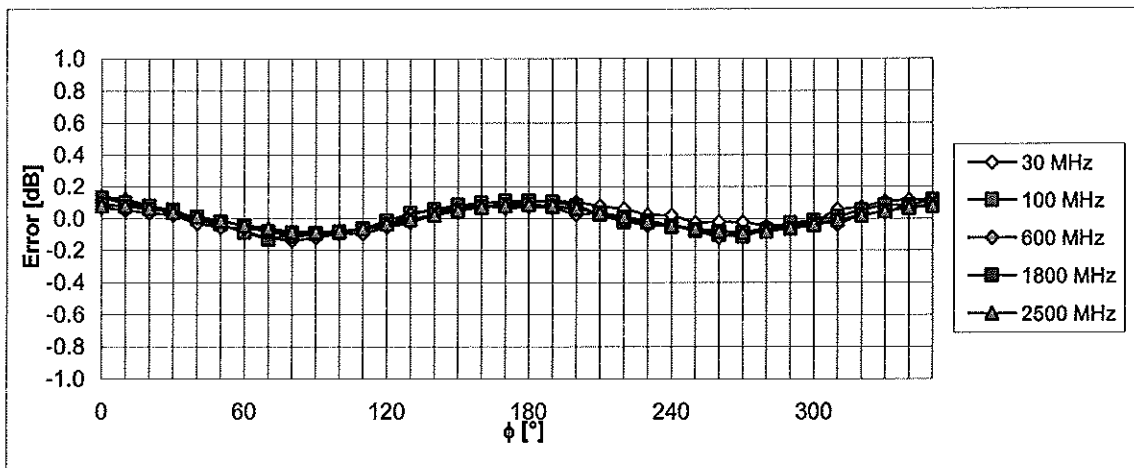
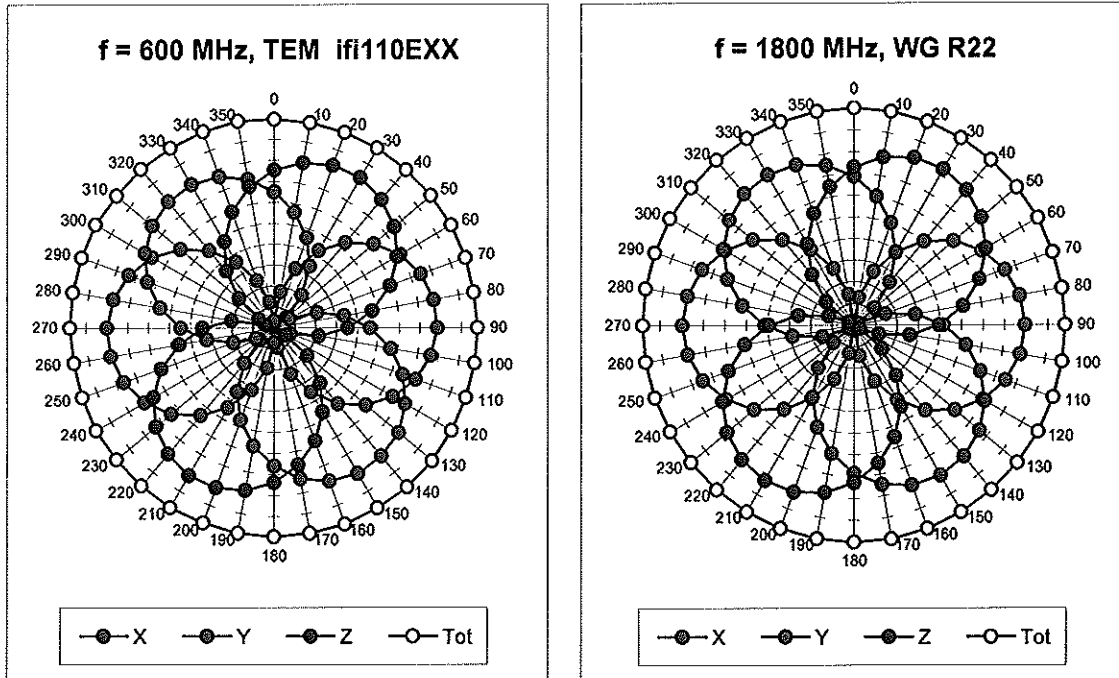

Uncertainty of Axial Isotropy Assessment: $\pm 0.5\%$ (k=2)

Dynamic Range $f(SAR_{head})$ (Waveguide R22, $f = 1800$ MHz)

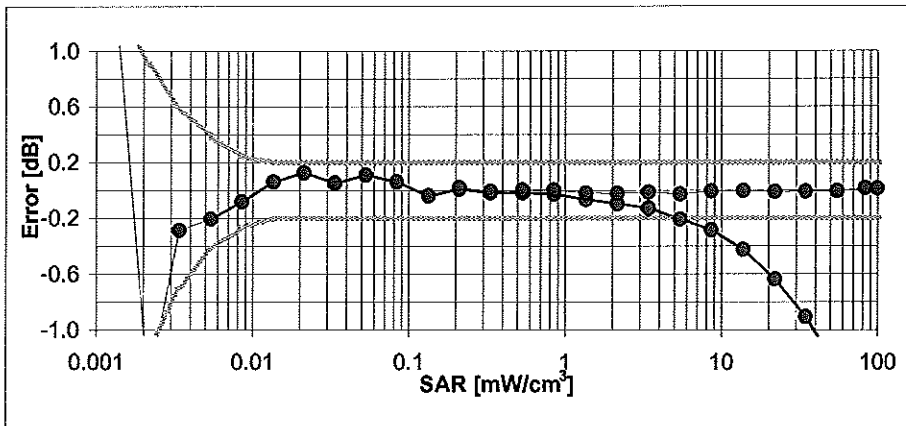
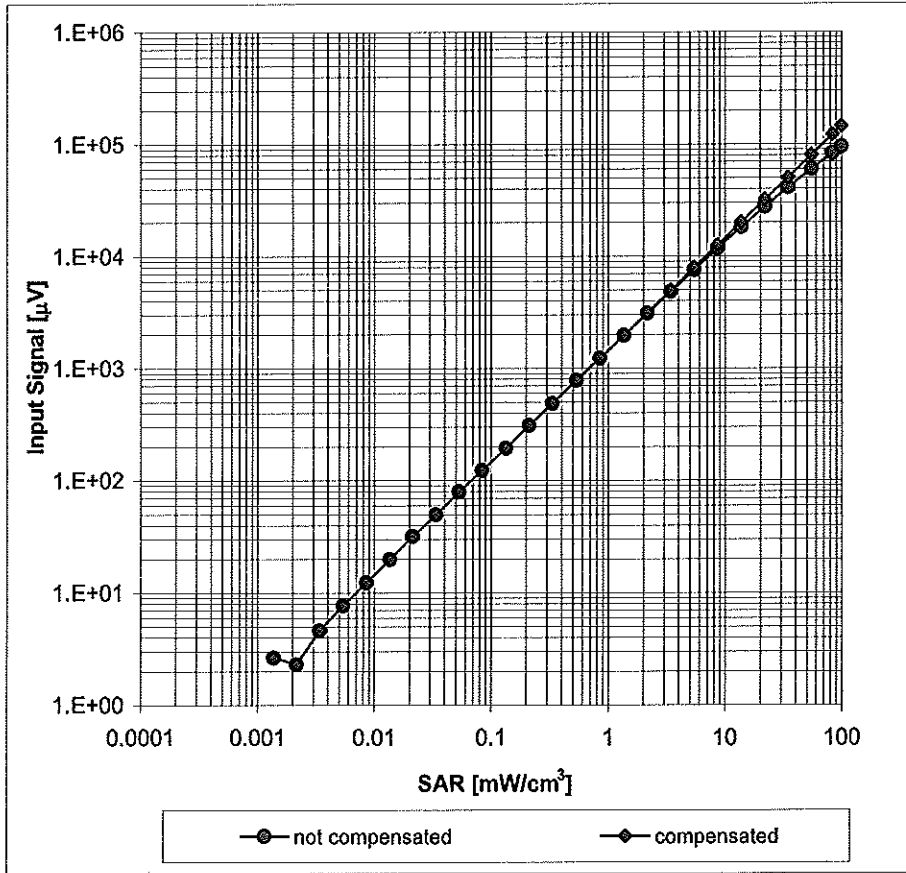

Uncertainty of Linearity Assessment: $\pm 0.6\%$ ($k=2$)

Conversion Factor Assessment

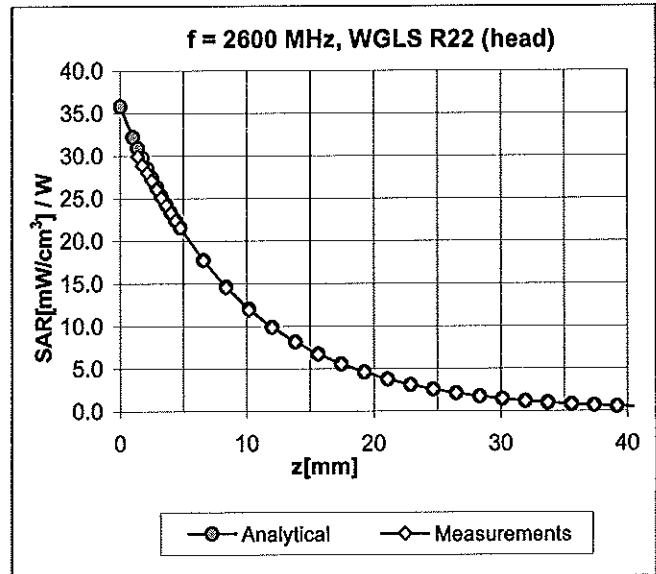
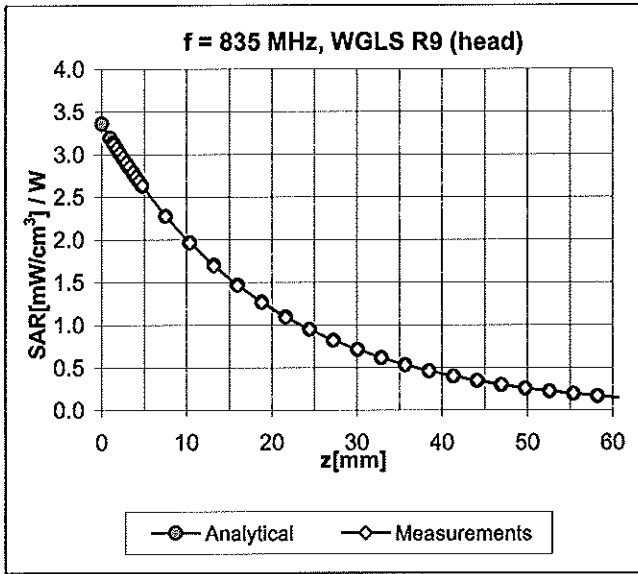

Deviation from Isotropy in HSL

Error (ϕ, θ), f = 900 MHz

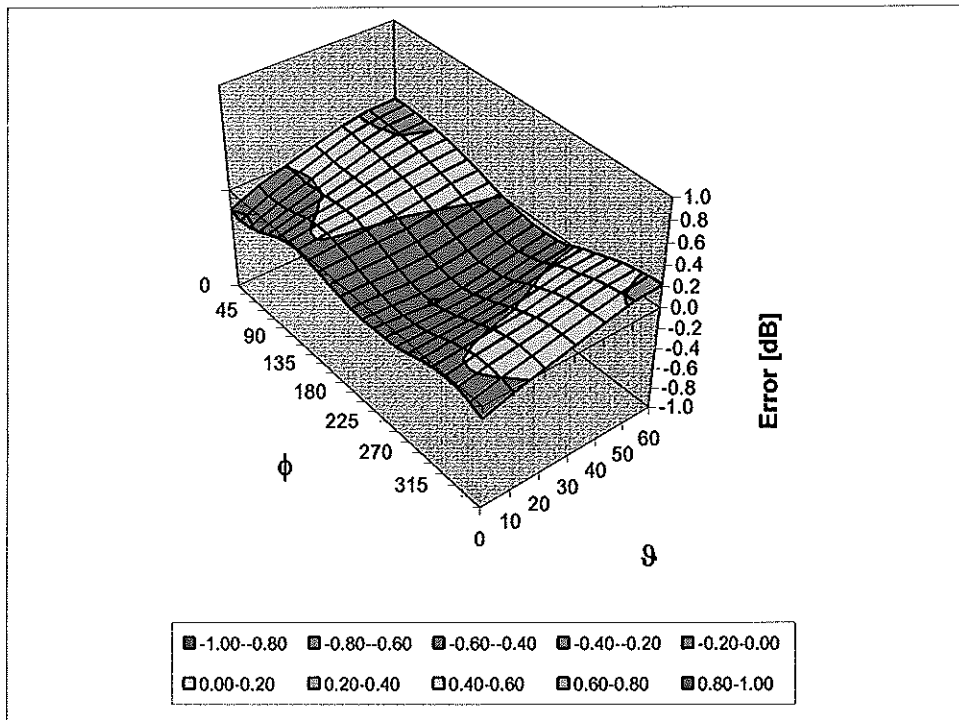

Uncertainty of Spherical Isotropy Assessment: $\pm 2.6\%$ (k=2)

Other Probe Parameters

Sensor Arrangement	Triangular
Connector Angle (°)	Not applicable
Mechanical Surface Detection Mode	enabled
Optical Surface Detection Mode	disabled
Probe Overall Length	337 mm
Probe Body Diameter	10 mm
Tip Length	9 mm
Tip Diameter	2.5 mm
Probe Tip to Sensor X Calibration Point	1 mm
Probe Tip to Sensor Y Calibration Point	1 mm
Probe Tip to Sensor Z Calibration Point	1 mm
Recommended Measurement Distance from Surface	2 mm



Accredited by the Swiss Accreditation Service (SAS)
The Swiss Accreditation Service is one of the signatories to the EA
Multilateral Agreement for the recognition of calibration certificates

Accreditation No.: **SCS 108**

Client **PC Test**

Certificate No: **D835V2-4d047_Feb11**

CALIBRATION CERTIFICATE

Object **D835V2 - SN: 4d047**

Calibration procedure(s) **QA CAL-05.v8
Calibration procedure for dipole validation kits**

Calibration date: **February 09, 2011**

✓
2/24/11
KOK

This calibration certificate documents the traceability to national standards, which realize the physical units of measurements (SI).
The measurements and the uncertainties with confidence probability are given on the following pages and are part of the certificate.

All calibrations have been conducted in the closed laboratory facility: environment temperature (22 ± 3)°C and humidity < 70%.

Calibration Equipment used (M&TE critical for calibration)

Primary Standards	ID #	Cal Date (Certificate No.)	Scheduled Calibration
Power meter EPM-442A	GB37480704	06-Oct-10 (No. 217-01266)	Oct-11
Power sensor HP 8481A	US37292783	06-Oct-10 (No. 217-01266)	Oct-11
Reference 20 dB Attenuator	SN: 5086 (20g)	30-Mar-10 (No. 217-01158)	Mar-11
Type-N mismatch combination	SN: 5047.2 / 06327	30-Mar-10 (No. 217-01162)	Mar-11
Reference Probe ES3DV3	SN: 3205	30-Apr-10 (No. ES3-3205_Apr10)	Apr-11
DAE4	SN: 601	10-Jun-10 (No. DAE4-601_Jun10)	Jun-11
Secondary Standards	ID #	Check Date (in house)	Scheduled Check
Power sensor HP 8481A	MY41092317	18-Oct-02 (in house check Oct-09)	in house check: Oct-11
RF generator R&S SMT-06	100005	4-Aug-99 (in house check Oct-09)	in house check: Oct-11
Network Analyzer HP 8753E	US37390585 S4206	18-Oct-01 (in house check Oct-10)	in house check: Oct-11

Calibrated by: **Dimce Iliev** Function: **Laboratory Technician** Signature: *D. Iliev*

Approved by: **Katja Pokovic** Technical Manager *Katja Pokovic*

Issued: February 9, 2011

This calibration certificate shall not be reproduced except in full without written approval of the laboratory.



Accredited by the Swiss Accreditation Service (SAS)
The Swiss Accreditation Service is one of the signatories to the EA
Multilateral Agreement for the recognition of calibration certificates

Accreditation No.: **SCS 108**

Glossary:

TSL	tissue simulating liquid
ConvF	sensitivity in TSL / NORM x,y,z
N/A	not applicable or not measured

Calibration is Performed According to the Following Standards:

- a) IEEE Std 1528-2003, "IEEE Recommended Practice for Determining the Peak Spatial-Averaged Specific Absorption Rate (SAR) in the Human Head from Wireless Communications Devices: Measurement Techniques", December 2003
- b) IEC 62209-1, "Procedure to measure the Specific Absorption Rate (SAR) for hand-held devices used in close proximity to the ear (frequency range of 300 MHz to 3 GHz)", February 2005
- c) Federal Communications Commission Office of Engineering & Technology (FCC OET), "Evaluating Compliance with FCC Guidelines for Human Exposure to Radiofrequency Electromagnetic Fields; Additional Information for Evaluating Compliance of Mobile and Portable Devices with FCC Limits for Human Exposure to Radiofrequency Emissions", Supplement C (Edition 01-01) to Bulletin 65

Additional Documentation:

- d) DAS4/5 System Handbook

Methods Applied and Interpretation of Parameters:

- *Measurement Conditions:* Further details are available from the Validation Report at the end of the certificate. All figures stated in the certificate are valid at the frequency indicated.
- *Antenna Parameters with TSL:* The dipole is mounted with the spacer to position its feed point exactly below the center marking of the flat phantom section, with the arms oriented parallel to the body axis.
- *Feed Point Impedance and Return Loss:* These parameters are measured with the dipole positioned under the liquid filled phantom. The impedance stated is transformed from the measurement at the SMA connector to the feed point. The Return Loss ensures low reflected power. No uncertainty required.
- *Electrical Delay:* One-way delay between the SMA connector and the antenna feed point. No uncertainty required.
- *SAR measured:* SAR measured at the stated antenna input power.
- *SAR normalized:* SAR as measured, normalized to an input power of 1 W at the antenna connector.
- *SAR for nominal TSL parameters:* The measured TSL parameters are used to calculate the nominal SAR result.

Measurement Conditions

DASY system configuration, as far as not given on page 1.

DASY Version	DASY5	V52.6
Extrapolation	Advanced Extrapolation	
Phantom	Modular Flat Phantom V4.9	
Distance Dipole Center - TSL	15 mm	with Spacer
Zoom Scan Resolution	dx, dy, dz = 5 mm	
Frequency	835 MHz \pm 1 MHz	

Head TSL parameters

The following parameters and calculations were applied.

	Temperature	Permittivity	Conductivity
Nominal Head TSL parameters	22.0 °C	41.5	0.90 mho/m
Measured Head TSL parameters	(22.0 \pm 0.2) °C	41.1 \pm 6 %	0.89 mho/m \pm 6 %
Head TSL temperature during test	(21.8 \pm 0.2) °C	----	----

SAR result with Head TSL

SAR averaged over 1 cm³ (1 g) of Head TSL	Condition	
SAR measured	250 mW input power	2.37 mW / g
SAR normalized	normalized to 1W	9.48 mW / g
SAR for nominal Head TSL parameters	normalized to 1W	9.53 mW / g \pm 17.0 % (k=2)

SAR averaged over 10 cm³ (10 g) of Head TSL	condition	
SAR measured	250 mW input power	1.54 mW / g
SAR normalized	normalized to 1W	6.16 mW / g
SAR for nominal Head TSL parameters	normalized to 1W	6.19 mW / g \pm 16.5 % (k=2)

Body TSL parameters

The following parameters and calculations were applied.

	Temperature	Permittivity	Conductivity
Nominal Body TSL parameters	22.0 °C	55.2	0.97 mho/m
Measured Body TSL parameters	(22.0 ± 0.2) °C	54.2 ± 6 %	0.99 mho/m ± 6 %
Body TSL temperature during test	(22.0 ± 0.2) °C	----	----

SAR result with Body TSL

SAR averaged over 1 cm ³ (1 g) of Body TSL	Condition	
SAR measured	250 mW input power	2.51 mW / g
SAR normalized	normalized to 1W	10.0 mW / g
SAR for nominal Body TSL parameters	normalized to 1W	9.85 mW / g ± 17.0 % (k=2)

SAR averaged over 10 cm ³ (10 g) of Body TSL	condition	
SAR measured	250 mW input power	1.64 mW / g
SAR normalized	normalized to 1W	6.56 mW / g
SAR for nominal Body TSL parameters	normalized to 1W	6.47 mW / g ± 16.5 % (k=2)

Appendix

Antenna Parameters with Head TSL

Impedance, transformed to feed point	50.1 Ω - 6.2 j Ω
Return Loss	- 24.2 dB

Antenna Parameters with Body TSL

Impedance, transformed to feed point	45.9 Ω - 8.2 j Ω
Return Loss	- 20.4 dB

General Antenna Parameters and Design

Electrical Delay (one direction)	1.387 ns
----------------------------------	----------

After long term use with 100W radiated power, only a slight warming of the dipole near the feedpoint can be measured.

The dipole is made of standard semirigid coaxial cable. The center conductor of the feeding line is directly connected to the second arm of the dipole. The antenna is therefore short-circuited for DC-signals.

No excessive force must be applied to the dipole arms, because they might bend or the soldered connections near the feedpoint may be damaged.

Additional EUT Data

Manufactured by	SPEAG
Manufactured on	August 16, 2006

DASY5 Validation Report for Head TSL

Date/Time: 09.02.2011 10:54:37

Test Laboratory: SPEAG, Zurich, Switzerland

DUT: Dipole 835 MHz; Type: D835V2; Serial: D835V2 - SN:4d047

Communication System: CW; Frequency: 835 MHz; Duty Cycle: 1:1

Medium: HSL900

Medium parameters used: $f = 835$ MHz; $\sigma = 0.89$ mho/m; $\epsilon_r = 41$; $\rho = 1000$ kg/m³

Phantom section: Flat Section

Measurement Standard: DASY5 (IEEE/IEC/ANSI C63.19-2007)

DASY5 Configuration:

- Probe: ES3DV3 - SN3205; ConvF(6.03, 6.03, 6.03); Calibrated: 30.04.2010
- Sensor-Surface: 3mm (Mechanical Surface Detection)
- Electronics: DAE4 Sn601; Calibrated: 10.06.2010
- Phantom: Flat Phantom 4.9L; Type: QD000P49AA; Serial: 1001
- Measurement SW: DASY52, V52.6.1 Build (408)
- Postprocessing SW: SEMCAD X, V14.4.2 Build (2595)

Pin=250 mW /d=15mm, dist=3.0mm (ES-Probe)/Zoom Scan (7x7x7) /Cube 0: Measurement grid: dx=5mm, dy=5mm, dz=5mm

Reference Value = 57.212 V/m; Power Drift = 0.02 dB

Peak SAR (extrapolated) = 3.567 W/kg

SAR(1 g) = 2.37 mW/g; SAR(10 g) = 1.54 mW/g

Maximum value of SAR (measured) = 2.763 mW/g

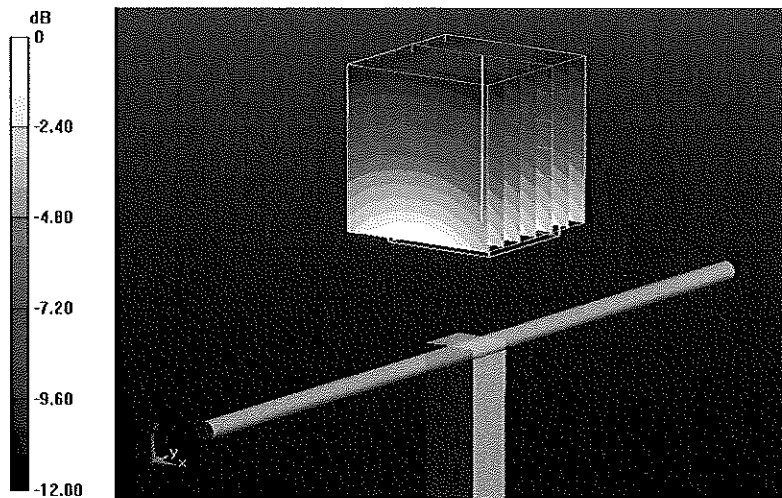

0 dB = 2.760mW/g

Impedance Measurement Plot for Head TSL

9 Feb 2011 10:16:52

[CH1] S11 1 U FS 1: 50.000 Ω -6.1836 Ω 30.824 pF 835.000 000 MHz

*
De1
Cor

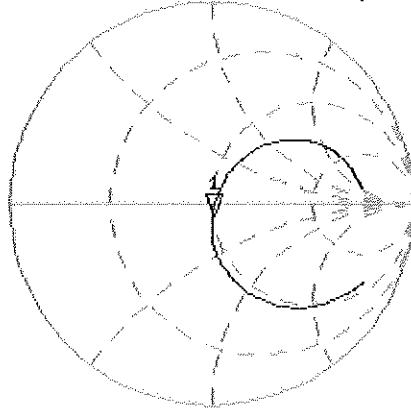

Avg
16

CH2 S11 LOG 5 dB/REF -20 dB 1: -24.208 dB 835.000 000 MHz

Cor

Avg
16

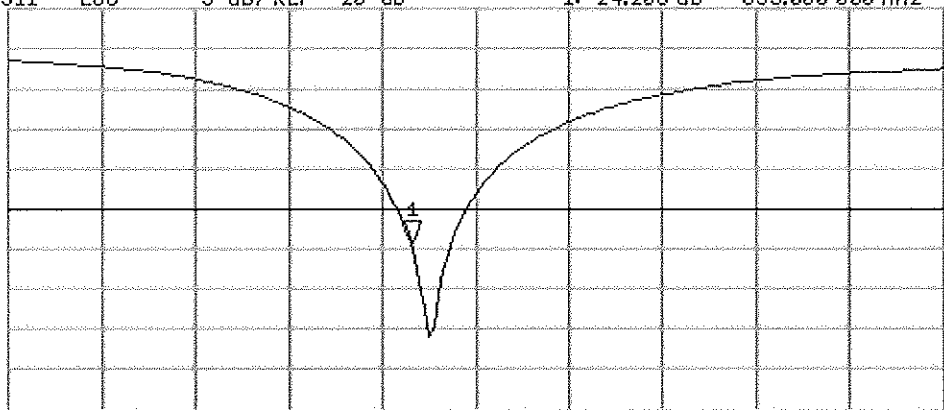

START 635.000 000 MHz

STOP 1 100.000 000 MHz

DASY5 Validation Report for Body TSL

Date/Time: 09.02.2011 13:56:30

Test Laboratory: SPEAG, Zurich, Switzerland

DUT: Dipole 835 MHz; Type: D835V2; Serial: D835V2 - SN:4d047

Communication System: CW; Frequency: 835 MHz; Duty Cycle: 1:1

Medium: MSL900

Medium parameters used: $f = 835$ MHz; $\sigma = 0.99$ mho/m; $\epsilon_r = 54.2$; $\rho = 1000$ kg/m³

Phantom section: Flat Section

Measurement Standard: DASY5 (IEEE/IEC/ANSI C63.19-2007)

DASY5 Configuration:

- Probe: ES3DV3 - SN3205; ConvF(5.86, 5.86, 5.86); Calibrated: 30.04.2010
- Sensor-Surface: 3mm (Mechanical Surface Detection)
- Electronics: DAE4 Sn601; Calibrated: 10.06.2010
- Phantom: Flat Phantom 4.9L; Type: QD000P49AA; Serial: 1001
- Measurement SW: DASY52, V52.6.1 Build (408)
- Postprocessing SW: SEMCAD X, V14.4.2 Build (2595)

Pin=250 mW /d=15mm, dist=3.0mm (ES-Probe)/Zoom Scan (7x7x7) /Cube 0: Measurement grid: dx=5mm, dy=5mm, dz=5mm

Reference Value = 56.092 V/m; Power Drift = 0.02 dB

Peak SAR (extrapolated) = 3.714 W/kg

SAR(1 g) = 2.51 mW/g; SAR(10 g) = 1.64 mW/g

Maximum value of SAR (measured) = 2.921 mW/g

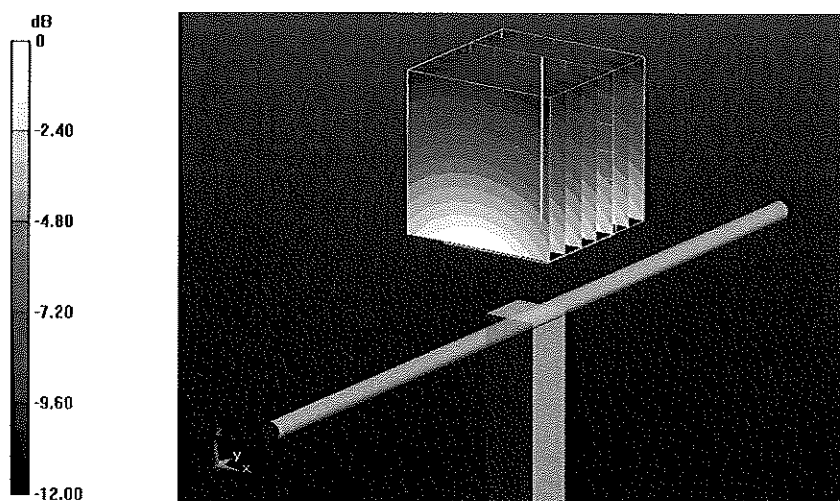

0 dB = 2.920mW/g

Impedance Measurement Plot for Body TSL

9 Feb 2011 14:20:21

CH1 S11 1 U FS 1: 45.922 Ω -8.2461 Ω 23.115 μF 835.000 000 MHz

*
Del
Cor

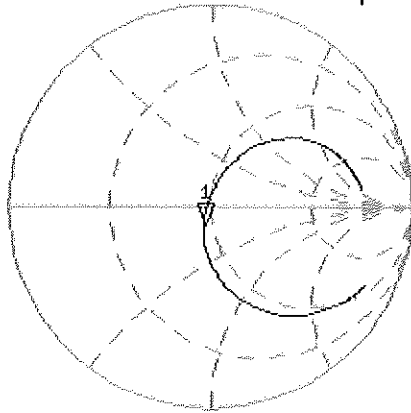

Avg
16

↑

CH2 S11 LOG 5 dB/REF -20 dB 1: -20.397 dB 835.000 000 MHz

Cor

Avg
16

↑

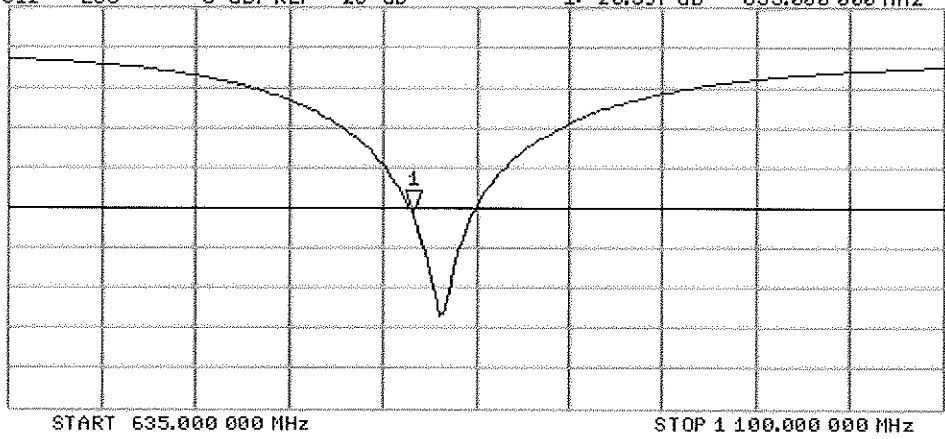



Accredited by the Swiss Accreditation Service (SAS)
The Swiss Accreditation Service is one of the signatories to the EA
Multilateral Agreement for the recognition of calibration certificates

Accreditation No.: **SCS 108**

Client **PC Test**

Certificate No: **D1900V2-502_Feb11**

CALIBRATION CERTIFICATE

Object **D1900V2 - SN: 502**

Calibration procedure(s) **QA CAL-05.v8
Calibration procedure for dipole validation kits**

Calibration date: **February 17, 2011**

✓
KOK
2/24/11

This calibration certificate documents the traceability to national standards, which realize the physical units of measurements (SI).
The measurements and the uncertainties with confidence probability are given on the following pages and are part of the certificate.

All calibrations have been conducted in the closed laboratory facility: environment temperature (22 ± 3)°C and humidity < 70%.

Calibration Equipment used (M&TE critical for calibration)

Primary Standards	ID #	Cal Date (Certificate No.)	Scheduled Calibration
Power meter EPM-442A	GB37480704	06-Oct-10 (No. 217-01266)	Oct-11
Power sensor HP 8481A	US37292783	06-Oct-10 (No. 217-01266)	Oct-11
Reference 20 dB Attenuator	SN: 5086 (20g)	30-Mar-10 (No. 217-01158)	Mar-11
Type-N mismatch combination	SN: 5047.2 / 06327	30-Mar-10 (No. 217-01162)	Mar-11
Reference Probe ES3DV3	SN: 3205	30-Apr-10 (No. ES3-3205_Apr10)	Apr-11
DAE4	SN: 601	10-Jun-10 (No. DAE4-601_Jun10)	Jun-11
Secondary Standards	ID #	Check Date (in house)	Scheduled Check
Power sensor HP 8481A	MY41092317	18-Oct-02 (in house check Oct-09)	In house check: Oct-11
RF generator R&S SMT-06	100005	4-Aug-99 (in house check Oct-09)	In house check: Oct-11
Network Analyzer HP 8753E	US37390585 S4206	18-Oct-01 (in house check Oct-10)	In house check: Oct-11

Calibrated by: **Dimce Iliev** **Function: Laboratory Technician** **Signature: [Signature]**

Approved by: **Katja Pokovic** **Technical Manager** **[Signature]**

Issued: February 17, 2011

This calibration certificate shall not be reproduced except in full without written approval of the laboratory.



Accredited by the Swiss Accreditation Service (SAS)

The Swiss Accreditation Service is one of the signatories to the EA
Multilateral Agreement for the recognition of calibration certificates

Accreditation No.: **SCS 108**

Glossary:

TSL	tissue simulating liquid
ConvF	sensitivity in TSL / NORM x,y,z
N/A	not applicable or not measured

Calibration is Performed According to the Following Standards:

- IEEE Std 1528-2003, "IEEE Recommended Practice for Determining the Peak Spatial-Averaged Specific Absorption Rate (SAR) in the Human Head from Wireless Communications Devices: Measurement Techniques", December 2003
- IEC 62209-1, "Procedure to measure the Specific Absorption Rate (SAR) for hand-held devices used in close proximity to the ear (frequency range of 300 MHz to 3 GHz)", February 2005
- Federal Communications Commission Office of Engineering & Technology (FCC OET), "Evaluating Compliance with FCC Guidelines for Human Exposure to Radiofrequency Electromagnetic Fields; Additional Information for Evaluating Compliance of Mobile and Portable Devices with FCC Limits for Human Exposure to Radiofrequency Emissions", Supplement C (Edition 01-01) to Bulletin 65

Additional Documentation:

- DASY4/5 System Handbook

Methods Applied and Interpretation of Parameters:

- Measurement Conditions:** Further details are available from the Validation Report at the end of the certificate. All figures stated in the certificate are valid at the frequency indicated.
- Antenna Parameters with TSL:** The dipole is mounted with the spacer to position its feed point exactly below the center marking of the flat phantom section, with the arms oriented parallel to the body axis.
- Feed Point Impedance and Return Loss:** These parameters are measured with the dipole positioned under the liquid filled phantom. The impedance stated is transformed from the measurement at the SMA connector to the feed point. The Return Loss ensures low reflected power. No uncertainty required.
- Electrical Delay:** One-way delay between the SMA connector and the antenna feed point. No uncertainty required.
- SAR measured:** SAR measured at the stated antenna input power.
- SAR normalized:** SAR as measured, normalized to an input power of 1 W at the antenna connector.
- SAR for nominal TSL parameters:** The measured TSL parameters are used to calculate the nominal SAR result.

Measurement Conditions

DASY system configuration, as far as not given on page 1.

DASY Version	DASY5	V52.6
Extrapolation	Advanced Extrapolation	
Phantom	Modular Flat Phantom V5.0	
Distance Dipole Center - TSL	10 mm	with Spacer
Zoom Scan Resolution	dx, dy, dz = 5 mm	
Frequency	1900 MHz \pm 1 MHz	

Head TSL parameters

The following parameters and calculations were applied.

	Temperature	Permittivity	Conductivity
Nominal Head TSL parameters	22.0 °C	40.0	1.40 mho/m
Measured Head TSL parameters	(22.0 \pm 0.2) °C	39.8 \pm 6 %	1.41 mho/m \pm 6 %
Head TSL temperature during test	(21.5 \pm 0.2) °C	----	----

SAR result with Head TSL

SAR averaged over 1 cm ³ (1 g) of Head TSL	Condition	
SAR measured	250 mW input power	10.1 mW / g
SAR normalized	normalized to 1W	40.4 mW / g
SAR for nominal Head TSL parameters	normalized to 1W	40.2 mW / g \pm 17.0 % (k=2)

SAR averaged over 10 cm ³ (10 g) of Head TSL	condition	
SAR measured	250 mW input power	5.26 mW / g
SAR normalized	normalized to 1W	21.0 mW / g
SAR for nominal Head TSL parameters	normalized to 1W	21.0 mW / g \pm 16.5 % (k=2)

Body TSL parameters

The following parameters and calculations were applied.

	Temperature	Permittivity	Conductivity
Nominal Body TSL parameters	22.0 °C	53.3	1.52 mho/m
Measured Body TSL parameters	(22.0 ± 0.2) °C	52.8 ± 6 %	1.55 mho/m ± 6 %
Body TSL temperature during test	(21.5 ± 0.2) °C	----	----

SAR result with Body TSL

SAR averaged over 1 cm ³ (1 g) of Body TSL	Condition	
SAR measured	250 mW input power	10.4 mW / g
SAR normalized	normalized to 1W	41.6 mW / g
SAR for nominal Body TSL parameters	normalized to 1W	41.1 mW / g ± 17.0 % (k=2)

SAR averaged over 10 cm ³ (10 g) of Body TSL	condition	
SAR measured	250 mW input power	5.48 mW / g
SAR normalized	normalized to 1W	21.9 mW / g
SAR for nominal Body TSL parameters	normalized to 1W	21.8 mW / g ± 16.5 % (k=2)

Appendix

Antenna Parameters with Head TSL

Impedance, transformed to feed point	51.3 Ω + 6.4 j Ω
Return Loss	- 23.8 dB

Antenna Parameters with Body TSL

Impedance, transformed to feed point	47.3 Ω + 6.7 j Ω
Return Loss	- 22.5 dB

General Antenna Parameters and Design

Electrical Delay (one direction)	1.206 ns
----------------------------------	----------

After long term use with 100W radiated power, only a slight warming of the dipole near the feedpoint can be measured.

The dipole is made of standard semirigid coaxial cable. The center conductor of the feeding line is directly connected to the second arm of the dipole. The antenna is therefore short-circuited for DC-signals.

No excessive force must be applied to the dipole arms, because they might bend or the soldered connections near the feedpoint may be damaged.

Additional EUT Data

Manufactured by	SPEAG
Manufactured on	November 14, 1998

DASY5 Validation Report for Head TSL

Date/Time: 17.02.2011 10:13:23

Test Laboratory: SPEAG, Zurich, Switzerland

DUT: Dipole 1900 MHz; Type: D1900V2; Serial: D1900V2 - SN:502

Communication System: CW; Frequency: 1900 MHz; Duty Cycle: 1:1

Medium: HSL U12 BB

Medium parameters used: $f = 1900$ MHz; $\sigma = 1.41$ mho/m; $\epsilon_r = 39.9$; $\rho = 1000$ kg/m³

Phantom section: Flat Section

Measurement Standard: DASY5 (IEEE/IEC/ANSI C63.19-2007)

DASY5 Configuration:

- Probe: ES3DV3 - SN3205; ConvF(5.09, 5.09, 5.09); Calibrated: 30.04.2010
- Sensor-Surface: 3mm (Mechanical Surface Detection)
- Electronics: DAE4 Sn601; Calibrated: 10.06.2010
- Phantom: Flat Phantom 5.0 (front); Type: QD000P50AA; Serial: 1001
- Measurement SW: DASY52, V52.6.1 Build (408)
- Postprocessing SW: SEMCAD X, V14.4.2 Build (2595)

Pin=250 mW /d=10mm, dist=3.0mm (ES-Probe)/Zoom Scan (7x7x7) /Cube 0: Measurement grid: dx=5mm, dy=5mm, dz=5mm

Reference Value = 97.159 V/m; Power Drift = 0.05 dB

Peak SAR (extrapolated) = 18.519 W/kg

SAR(1 g) = 10.1 mW/g; SAR(10 g) = 5.26 mW/g

Maximum value of SAR (measured) = 12.407 mW/g

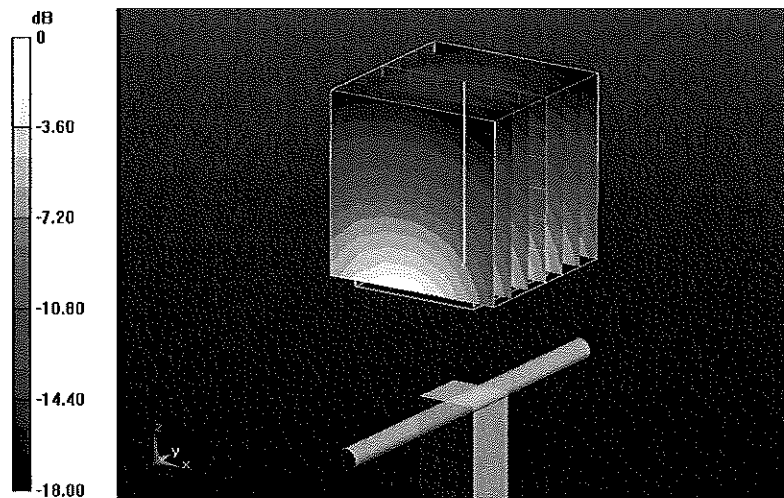

0 dB = 12.410mW/g

Impedance Measurement Plot for Head TSL

17 Feb 2011 10:39:46

CH1 S11 1 U FS 3: 51.264 Ω 6.4219 Ω 537.93 μ H 1 900.000 000 MHz

*
Del
CA

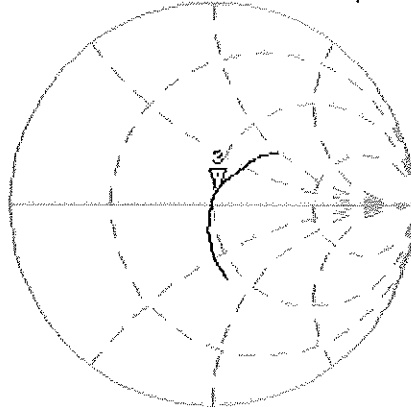

Avg
16

CH2 S11 LOG 5 dB/REF -20 dB 3:-23.804 dB 1 900.000 000 MHz

CA
Avg
16

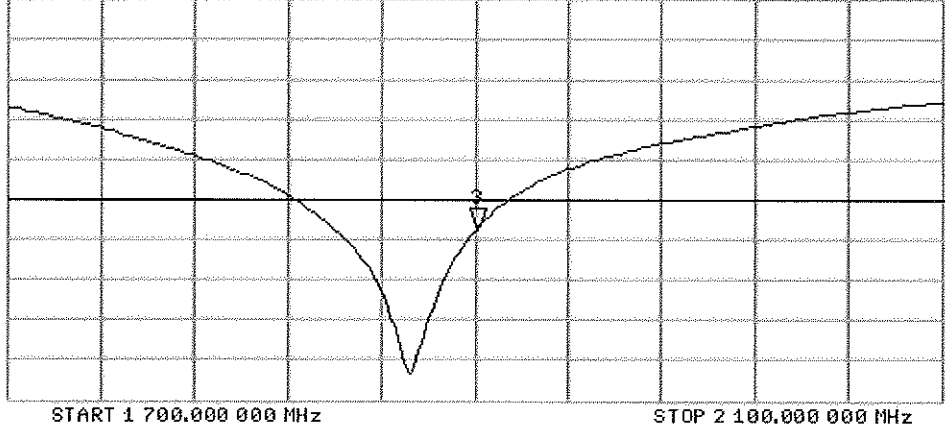

DASY5 Validation Report for Body TSL

Date/Time: 17.02.2011 10:55:26

Test Laboratory: SPEAG, Zurich, Switzerland

DUT: Dipole 1900 MHz; Type: D1900V2; Serial: D1900V2 - SN:502

Communication System: CW; Frequency: 1900 MHz; Duty Cycle: 1:1

Medium: MSL U12 BB

Medium parameters used: $f = 1900$ MHz; $\sigma = 1.55$ mho/m; $\epsilon_r = 52.9$; $\rho = 1000$ kg/m³

Phantom section: Flat Section

Measurement Standard: DASY5 (IEEE/IEC/ANSI C63.19-2007)

DASY5 Configuration:

- Probe: ES3DV3 - SN3205; ConvF(4.59, 4.59, 4.59); Calibrated: 30.04.2010
- Sensor-Surface: 3mm (Mechanical Surface Detection)
- Electronics: DAE4 Sn601; Calibrated: 10.06.2010
- Phantom: Flat Phantom 5.0 (back); Type: QD000P50AA; Serial: 1002
- Measurement SW: DASY52, V52.6.1 Build (408)
- Postprocessing SW: SEMCAD X, V14.4.2 Build (2595)

Pin=250 mW /d=10mm, dist=3.0mm (ES-Probe)/Zoom Scan (7x7x7) /Cube 0: Measurement grid: dx=5mm, dy=5mm, dz=5mm

Reference Value = 96.636 V/m; Power Drift = -0.02 dB

Peak SAR (extrapolated) = 17.829 W/kg

SAR(1 g) = 10.4 mW/g; SAR(10 g) = 5.48 mW/g

Maximum value of SAR (measured) = 13.070 mW/g

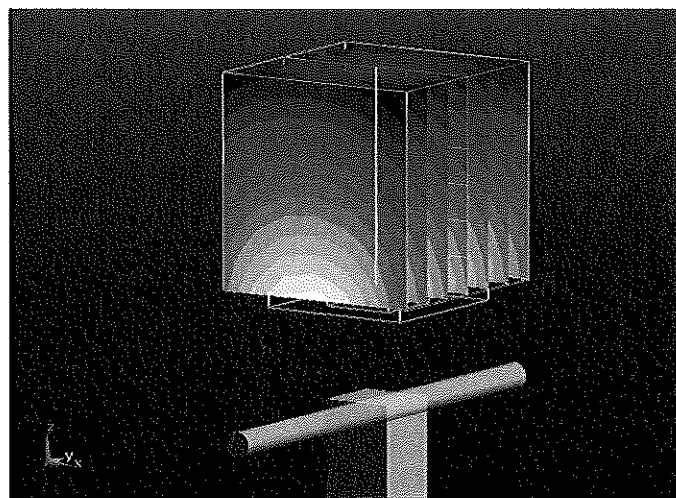

0 dB = 13.070mW/g

Impedance Measurement Plot for Body TSL

17 Feb 2011 10:40:17

CH1 S11 1 U FS 3: 47.260 Ω 6.7480 Ω 565.26 μ H 1 900.000 000 MHz

*
De1
CA

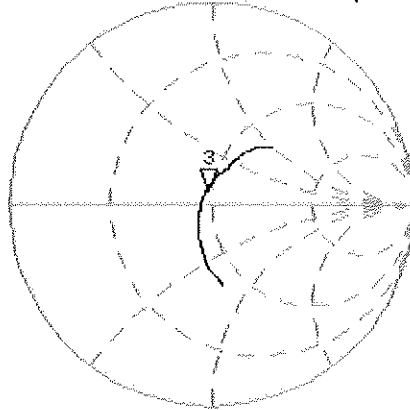

Avg
16
↑

CH2 S11 LOG 5 dB/REF -20 dB 3:-22.531 dB 1 900.000 000 MHz

CA

Avg
16
↑

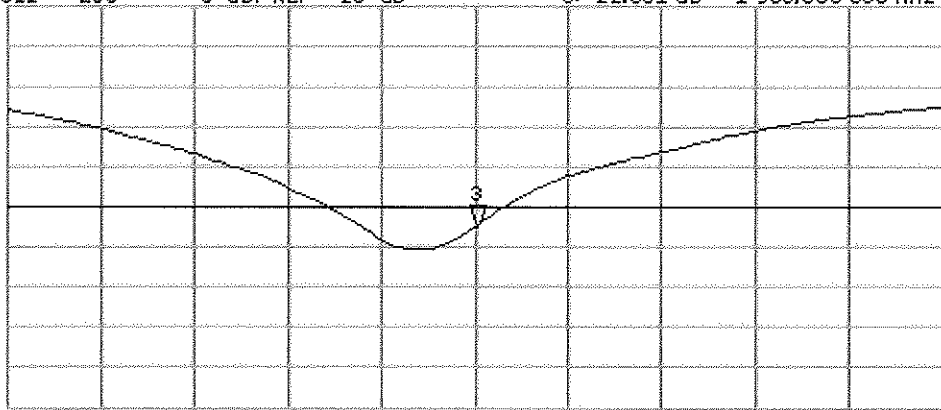

START 1 700.000 000 MHz

STOP 2 100.000 000 MHz



Accredited by the Swiss Accreditation Service (SAS)
The Swiss Accreditation Service is one of the signatories to the EA
Multilateral Agreement for the recognition of calibration certificates

Accreditation No.: **SCS 108**

Client **PC Test**

Certificate No: **D2450V2-797_Feb11**

CALIBRATION CERTIFICATE

Object **D2450V2 - SN: 797**

Calibration procedure(s) **QA CAL-05.v8
Calibration procedure for dipole validation kits**

Calibration date: **February 08, 2011**

*✓ KOK
2/24/11*

This calibration certificate documents the traceability to national standards, which realize the physical units of measurements (SI).
The measurements and the uncertainties with confidence probability are given on the following pages and are part of the certificate.

All calibrations have been conducted in the closed laboratory facility: environment temperature (22 ± 3)°C and humidity < 70%.

Calibration Equipment used (M&TE critical for calibration)

Primary Standards	ID #	Cal Date (Certificate No.)	Scheduled Calibration
Power meter EPM-442A	GB37480704	06-Oct-10 (No. 217-01266)	Oct-11
Power sensor HP 8481A	US37292783	06-Oct-10 (No. 217-01266)	Oct-11
Reference 20 dB Attenuator	SN: 5086 (20g)	30-Mar-10 (No. 217-01158)	Mar-11
Type-N mismatch combination	SN: 5047.2 / 06327	30-Mar-10 (No. 217-01162)	Mar-11
Reference Probe ES3DV3	SN: 3205	30-Apr-10 (No. ES3-3205_Apr10)	Apr-11
DAE4	SN: 601	10-Jun-10 (No. DAE4-601_Jun10)	Jun-11
Secondary Standards	ID #	Check Date (in house)	Scheduled Check
Power sensor HP 8481A	MY41092317	18-Oct-02 (in house check Oct-09)	In house check: Oct-11
RF generator R&S SMT-06	100005	4-Aug-99 (in house check Oct-09)	In house check: Oct-11
Network Analyzer HP 8753E	US37390585 S4206	18-Oct-01 (in house check Oct-10)	In house check: Oct-11

Calibrated by:	Name Dimce Iliev	Function Laboratory Technician	Signature <i>D. Iliev</i>
Approved by:	Katja Pokovic	Technical Manager	<i>Katja Pokovic</i>

Issued: February 8, 2011

This calibration certificate shall not be reproduced except in full without written approval of the laboratory.



Accredited by the Swiss Accreditation Service (SAS)
The Swiss Accreditation Service is one of the signatories to the EA
Multilateral Agreement for the recognition of calibration certificates

Accreditation No.: **SCS 108**

Glossary:

TSL	tissue simulating liquid
ConvF	sensitivity in TSL / NORM x,y,z
N/A	not applicable or not measured

Calibration is Performed According to the Following Standards:

- IEEE Std 1528-2003, "IEEE Recommended Practice for Determining the Peak Spatial-Averaged Specific Absorption Rate (SAR) in the Human Head from Wireless Communications Devices: Measurement Techniques", December 2003
- IEC 62209-1, "Procedure to measure the Specific Absorption Rate (SAR) for hand-held devices used in close proximity to the ear (frequency range of 300 MHz to 3 GHz)", February 2005
- Federal Communications Commission Office of Engineering & Technology (FCC OET), "Evaluating Compliance with FCC Guidelines for Human Exposure to Radiofrequency Electromagnetic Fields; Additional Information for Evaluating Compliance of Mobile and Portable Devices with FCC Limits for Human Exposure to Radiofrequency Emissions", Supplement C (Edition 01-01) to Bulletin 65

Additional Documentation:

- DASY4/5 System Handbook

Methods Applied and Interpretation of Parameters:

- Measurement Conditions:** Further details are available from the Validation Report at the end of the certificate. All figures stated in the certificate are valid at the frequency indicated.
- Antenna Parameters with TSL:** The dipole is mounted with the spacer to position its feed point exactly below the center marking of the flat phantom section, with the arms oriented parallel to the body axis.
- Feed Point Impedance and Return Loss:** These parameters are measured with the dipole positioned under the liquid filled phantom. The impedance stated is transformed from the measurement at the SMA connector to the feed point. The Return Loss ensures low reflected power. No uncertainty required.
- Electrical Delay:** One-way delay between the SMA connector and the antenna feed point. No uncertainty required.
- SAR measured:** SAR measured at the stated antenna input power.
- SAR normalized:** SAR as measured, normalized to an input power of 1 W at the antenna connector.
- SAR for nominal TSL parameters:** The measured TSL parameters are used to calculate the nominal SAR result.

Measurement Conditions

DASY system configuration, as far as not given on page 1.

DASY Version	DASY5	V52.6
Extrapolation	Advanced Extrapolation	
Phantom	Modular Flat Phantom V5.0	
Distance Dipole Center - TSL	10 mm	with Spacer
Zoom Scan Resolution	dx, dy, dz = 5 mm	
Frequency	2450 MHz \pm 1 MHz	

Head TSL parameters

The following parameters and calculations were applied.

	Temperature	Permittivity	Conductivity
Nominal Head TSL parameters	22.0 °C	39.2	1.80 mho/m
Measured Head TSL parameters	(22.0 \pm 0.2) °C	39.1 \pm 6 %	1.73 mho/m \pm 6 %
Head TSL temperature during test	(21.0 \pm 0.2) °C	----	----

SAR result with Head TSL

SAR averaged over 1 cm ³ (1 g) of Head TSL	Condition	
SAR measured	250 mW input power	13.1 mW / g
SAR normalized	normalized to 1W	52.4 mW / g
SAR for nominal Head TSL parameters	normalized to 1W	53.3 mW / g \pm 17.0 % (k=2)

SAR averaged over 10 cm ³ (10 g) of Head TSL	condition	
SAR measured	250 mW input power	6.14 mW / g
SAR normalized	normalized to 1W	24.6 mW / g
SAR for nominal Head TSL parameters	normalized to 1W	24.7 mW / g \pm 16.5 % (k=2)

Body TSL parameters

The following parameters and calculations were applied.

	Temperature	Permittivity	Conductivity
Nominal Body TSL parameters	22.0 °C	52.7	1.95 mho/m
Measured Body TSL parameters	(22.0 ± 0.2) °C	52.2 ± 6 %	1.94 mho/m ± 6 %
Body TSL temperature during test	(21.0 ± 0.2) °C	----	----

SAR result with Body TSL

SAR averaged over 1 cm ³ (1 g) of Body TSL	Condition	
SAR measured	250 mW input power	13.1 mW / g
SAR normalized	normalized to 1W	52.4 mW / g
SAR for nominal Body TSL parameters	normalized to 1W	52.3 mW / g ± 17.0 % (k=2)

SAR averaged over 10 cm ³ (10 g) of Body TSL	condition	
SAR measured	250 mW input power	6.05 mW / g
SAR normalized	normalized to 1W	24.2 mW / g
SAR for nominal Body TSL parameters	normalized to 1W	24.2 mW / g ± 16.5 % (k=2)

Appendix

Antenna Parameters with Head TSL

Impedance, transformed to feed point	$53.9 \Omega + 3.9 j\Omega$
Return Loss	- 25.5 dB

Antenna Parameters with Body TSL

Impedance, transformed to feed point	$49.0 \Omega + 5.2 j\Omega$
Return Loss	- 25.5 dB

General Antenna Parameters and Design

Electrical Delay (one direction)	1.151 ns
----------------------------------	----------

After long term use with 100W radiated power, only a slight warming of the dipole near the feedpoint can be measured.

The dipole is made of standard semirigid coaxial cable. The center conductor of the feeding line is directly connected to the second arm of the dipole. The antenna is therefore short-circuited for DC-signals.

No excessive force must be applied to the dipole arms, because they might bend or the soldered connections near the feedpoint may be damaged.

Additional EUT Data

Manufactured by	SPEAG
Manufactured on	January 24, 2006

DASY5 Validation Report for Head TSL

Date/Time: 07.02.2011 13:51:58

Test Laboratory: SPEAG, Zurich, Switzerland

DUT: Dipole 2450 MHz; Type: D2450V2; Serial: D2450V2 - SN:797

Communication System: CW; Frequency: 2450 MHz; Duty Cycle: 1:1

Medium: HSL U12 BB

Medium parameters used: $f = 2450$ MHz; $\sigma = 1.74$ mho/m; $\epsilon_r = 39.3$; $\rho = 1000$ kg/m³

Phantom section: Flat Section

Measurement Standard: DASY5 (IEEE/IEC/ANSI C63.19-2007)

DASY5 Configuration:

- Probe: ES3DV3 - SN3205; ConvF(4.53, 4.53, 4.53); Calibrated: 30.04.2010
- Sensor-Surface: 3mm (Mechanical Surface Detection)
- Electronics: DAE4 Sn601; Calibrated: 10.06.2010
- Phantom: Flat Phantom 5.0 (front); Type: QD000P50AA; Serial: 1001
- Measurement SW: DASY52, V52.6.1 Build (408)
- Postprocessing SW: SEMCAD X, V14.4.2 Build (2595)

Pin=250 mW /d=10mm, dist=3.0mm (ES-Probe)/Zoom Scan (7x7x7) /Cube 0: Measurement grid: dx=5mm, dy=5mm, dz=5mm

Reference Value = 101.6 V/m; Power Drift = 0.02 dB

Peak SAR (extrapolated) = 26.650 W/kg

SAR(1 g) = 13.1 mW/g; SAR(10 g) = 6.14 mW/g

Maximum value of SAR (measured) = 16.664 mW/g

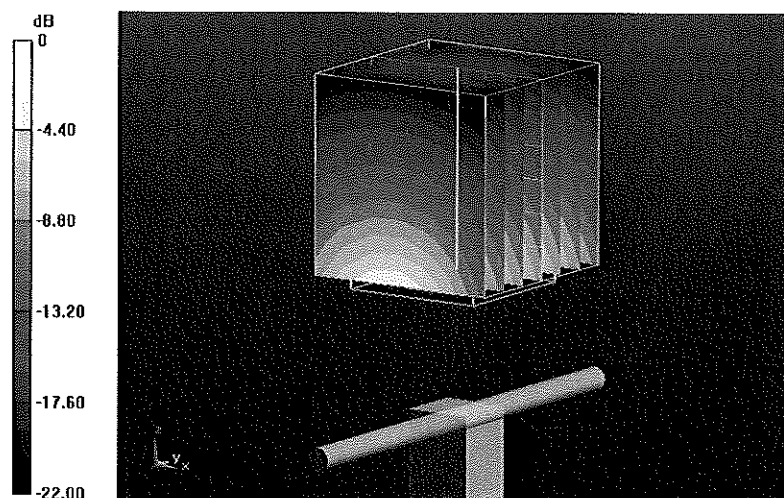

0 dB = 16.660mW/g

Impedance Measurement Plot for Head TSL

7 Feb 2011 10:40:17

[CH1] S11 1 U FS 4: 53.889 Ω 3.8828 Ω 252.23 μH 2 450.000 000 MHz

*
De1
Ca

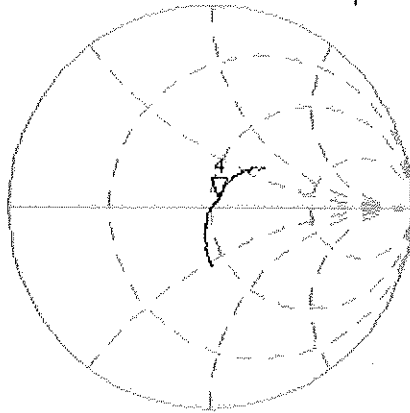

Avg
16

CH2 S11 LOG 5 dB/REF -20 dB 4:-25.540 dB 2 450.000 000 MHz

Ca

Avg
16

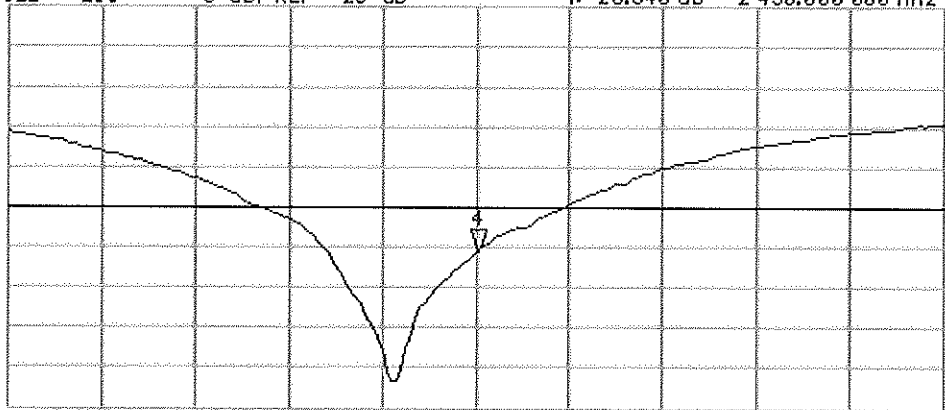

START 2 250.000 000 MHz

STOP 2 650.000 000 MHz

DASY5 Validation Report for Body TSL

Date/Time: 08.02.2011 13:24:09

Test Laboratory: SPEAG, Zurich, Switzerland

DUT: Dipole 2450 MHz; Type: D2450V2; Serial: D2450V2 - SN:797

Communication System: CW; Frequency: 2450 MHz; Duty Cycle: 1:1

Medium: MSL U12 BB

Medium parameters used: $f = 2450$ MHz; $\sigma = 1.95$ mho/m; $\epsilon_r = 52.4$; $\rho = 1000$ kg/m³

Phantom section: Flat Section

Measurement Standard: DASY5 (IEEE/IEC/ANSI C63.19-2007)

DASY5 Configuration:

- Probe: ES3DV3 - SN3205; ConvF(4.31, 4.31, 4.31); Calibrated: 30.04.2010
- Sensor-Surface: 3mm (Mechanical Surface Detection)
- Electronics: DAE4 Sn601; Calibrated: 10.06.2010
- Phantom: Flat Phantom 5.0 (back); Type: QD000P50AA; Serial: 1002
- Measurement SW: DASY52, V52.6.1 Build (408)
- Postprocessing SW: SEMCAD X, V14.4.2 Build (2595)

Pin=250 mW /d=10mm, dist=3.0mm (ES-Probe)/Zoom Scan (7x7x7) /Cube 0: Measurement grid: dx=5mm, dy=5mm, dz=5mm

Reference Value = 96.699 V/m; Power Drift = -0.08 dB

Peak SAR (extrapolated) = 27.483 W/kg

SAR(1 g) = 13.1 mW/g; SAR(10 g) = 6.05 mW/g

Maximum value of SAR (measured) = 17.122 mW/g

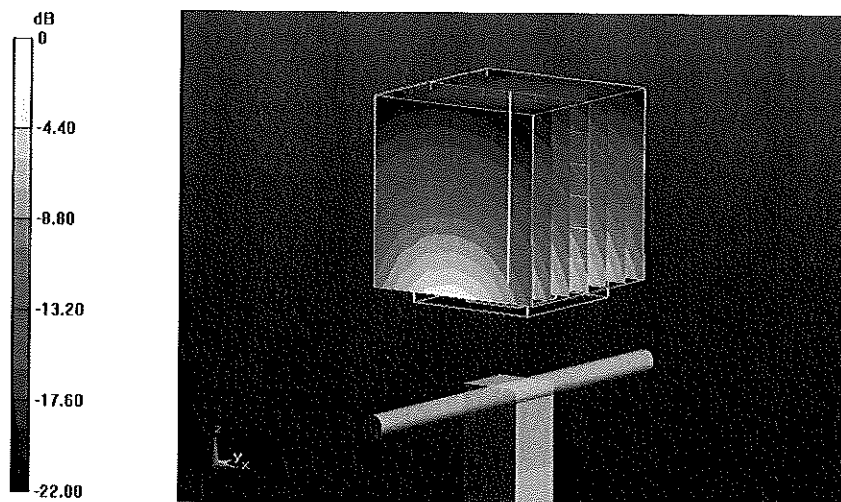

0 dB = 17.120mW/g

Impedance Measurement Plot for Body TSL

8 Feb 2011 10:58:23

CH1 S11 1 U FS S: 49.029 Ω 5.1934 Ω 337.37 pF 2 450.000 000 MHz

*
Del
CA

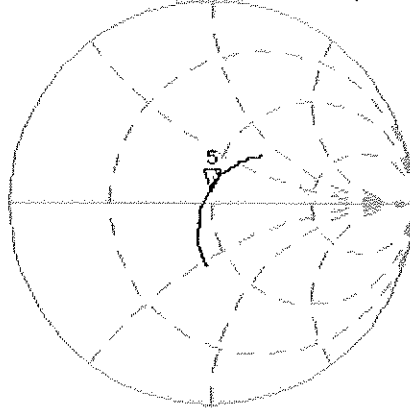

Avg
16

CH2 S11 LOG 5 dB/REF -20 dB S:-25.470 dB 2 450.000 000 MHz

CA

Avg
16

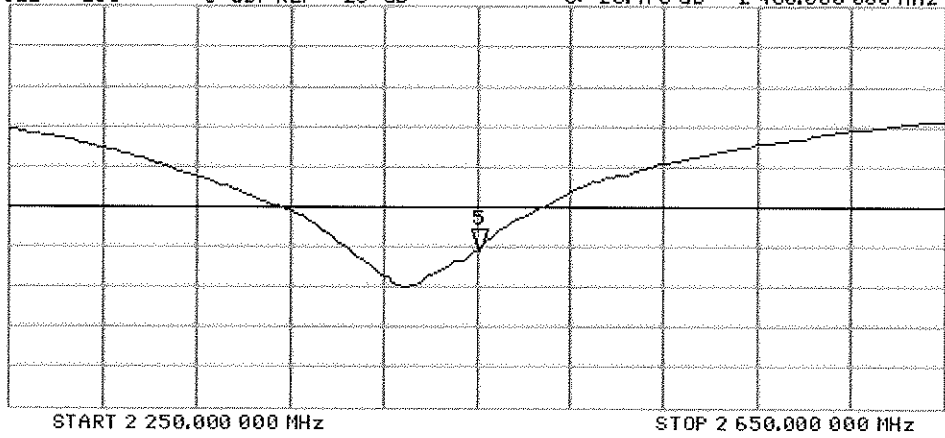



Accredited by the Swiss Accreditation Service (SAS)
The Swiss Accreditation Service is one of the signatories to the EA
Multilateral Agreement for the recognition of calibration certificates

Accreditation No.: **SCS 108**

Client **PC Test**

Certificate No: **ES3-3258_Apr11**

CALIBRATION CERTIFICATE

Object **ES3DV3 - SN:3258**

Calibration procedure(s) **QA CAL-01.v7, QA CAL-23.v4, QA CAL-25.v3
Calibration procedure for dosimetric E-field probes**

Calibration date: **April 8, 2011**

This calibration certificate documents the traceability to national standards, which realize the physical units of measurements (SI).
The measurements and the uncertainties with confidence probability are given on the following pages and are part of the certificate.

All calibrations have been conducted in the closed laboratory facility: environment temperature (22 ± 3)°C and humidity < 70%.

Calibration Equipment used (M&TE critical for calibration)

*✓ KOK
6/2/11*

Primary Standards	ID	Cal Date (Certificate No.)	Scheduled Calibration
Power meter E4419B	GB41293874	31-Mar-11 (No. 217-01372)	Apr-12
Power sensor E4412A	MY41495277	31-Mar-11 (No. 217-01372)	Apr-12
Power sensor E4412A	MY41498087	31-Mar-11 (No. 217-01372)	Apr-12
Reference 3 dB Attenuator	SN: S5054 (3c)	29-Mar-11 (No. 217-01369)	Apr-12
Reference 20 dB Attenuator	SN: S5086 (20b)	29-Mar-11 (No. 217-01367)	Apr-12
Reference 30 dB Attenuator	SN: S5129 (30b)	29-Mar-11 (No. 217-01370)	Apr-12
Reference Probe ES3DV2	SN: 3013	29-Dec-10 (No. ES3-3013_Dec10)	Dec-11
DAE4	SN: 654	23-Apr-10 (No. DAE4-654_Apr10)	Apr-11
Secondary Standards	ID	Check Date (in house)	Scheduled Check
RF generator HP 8648C	US3642U01700	4-Aug-99 (in house check Oct-09)	In house check: Oct-11
Network Analyzer HP 8753E	US37390585	18-Oct-01 (in house check Oct-10)	In house check: Oct-11

	Name	Function	Signature
Calibrated by:	Dimce Iliev	Laboratory Technician	<i>Dimce Iliev</i>
Approved by:	Kalja Pokovic	Technical Manager	<i>Kalja Pokovic</i>

Issued: April 13, 2011

This calibration certificate shall not be reproduced except in full without written approval of the laboratory.



Accredited by the Swiss Accreditation Service (SAS)

Accreditation No.: SCS 108

The Swiss Accreditation Service is one of the signatories to the EA
Multilateral Agreement for the recognition of calibration certificates

Glossary:

TSL	tissue simulating liquid
NORM _{x,y,z}	sensitivity in free space
ConvF	sensitivity in TSL / NORM _{x,y,z}
DCP	diode compression point
CF	crest factor (1/duty_cycle) of the RF signal
A, B, C	modulation dependent linearization parameters
Polarization φ	φ rotation around probe axis
Polarization ϑ	ϑ rotation around an axis that is in the plane normal to probe axis (at measurement center), i.e., $\vartheta = 0$ is normal to probe axis

Calibration is Performed According to the Following Standards:

- IEEE Std 1528-2003, "IEEE Recommended Practice for Determining the Peak Spatial-Averaged Specific Absorption Rate (SAR) in the Human Head from Wireless Communications Devices: Measurement Techniques", December 2003
- IEC 62209-1, "Procedure to measure the Specific Absorption Rate (SAR) for hand-held devices used in close proximity to the ear (frequency range of 300 MHz to 3 GHz)", February 2005

Methods Applied and Interpretation of Parameters:

- NORM_{x,y,z}**: Assessed for E-field polarization $\vartheta = 0$ ($f \leq 900$ MHz in TEM-cell; $f > 1800$ MHz: R22 waveguide). NORM_{x,y,z} are only intermediate values, i.e., the uncertainties of NORM_{x,y,z} does not affect the E²-field uncertainty inside TSL (see below ConvF).
- NORM(f)_{x,y,z}** = NORM_{x,y,z} * frequency_response (see Frequency Response Chart). This linearization is implemented in DASY4 software versions later than 4.2. The uncertainty of the frequency response is included in the stated uncertainty of ConvF.
- DCP_{x,y,z}**: DCP are numerical linearization parameters assessed based on the data of power sweep with CW signal (no uncertainty required). DCP does not depend on frequency nor media.
- PAR**: PAR is the Peak to Average Ratio that is not calibrated but determined based on the signal characteristics
- A_{x,y,z}; B_{x,y,z}; C_{x,y,z}** are numerical linearization parameters in dB assessed based on the data of power sweep for specific modulation signal. The parameters do not depend on frequency nor media.
- VR**: VR is the validity range of the calibration related to the average diode voltage or DAE voltage in mV.
- ConvF and Boundary Effect Parameters**: Assessed in flat phantom using E-field (or Temperature Transfer Standard for $f \leq 800$ MHz) and inside waveguide using analytical field distributions based on power measurements for $f > 800$ MHz. The same setups are used for assessment of the parameters applied for boundary compensation (alpha, depth) of which typical uncertainty values are given. These parameters are used in DASY4 software to improve probe accuracy close to the boundary. The sensitivity in TSL corresponds to NORM_{x,y,z} * ConvF whereby the uncertainty corresponds to that given for ConvF. A frequency dependent ConvF is used in DASY version 4.4 and higher which allows extending the validity from ± 50 MHz to ± 100 MHz.
- Spherical isotropy (3D deviation from isotropy)**: in a field of low gradients realized using a flat phantom exposed by a patch antenna.
- Sensor Offset**: The sensor offset corresponds to the offset of virtual measurement center from the probe tip (on probe axis). No tolerance required.

Probe ES3DV3

SN:3258

Manufactured: January 25, 2010
Calibrated: April 8, 2011

Calibrated for DASY/EASY Systems
(Note: non-compatible with DASY2 system!)

DASY/EASY - Parameters of Probe: ES3DV3 - SN:3258

Basic Calibration Parameters

	Sensor X	Sensor Y	Sensor Z	Unc (k=2)
Norm ($\mu V/(V/m)^2$) ^A	1.31	1.19	1.25	$\pm 10.1 \%$
DCP (mV) ^B	98.3	103.8	99.8	

Modulation Calibration Parameters

UID	Communication System Name	PAR		A dB	B dB	C dB	VR mV	Unc ^E (k=2)
10000	CW	0.00	X	0.00	0.00	1.00	115.1	$\pm 2.7 \%$
			Y	0.00	0.00	1.00	105.5	
			Z	0.00	0.00	1.00	113.5	

The reported uncertainty of measurement is stated as the standard uncertainty of measurement multiplied by the coverage factor $k=2$, which for a normal distribution corresponds to a coverage probability of approximately 95%.

^A The uncertainties of NormX,Y,Z do not affect the E^2 -field uncertainty inside TSL (see Pages 5 and 6).

^B Numerical linearization parameter: uncertainty not required.

^E Uncertainty is determined using the max. deviation from linear response applying rectangular distribution and is expressed for the square of the field value.

DASY/EASY - Parameters of Probe: ES3DV3 - SN:3258

Calibration Parameter Determined in Head Tissue Simulating Media

f (MHz) ^C	Relative Permittivity ^F	Conductivity (S/m) ^F	ConvF X	ConvF Y	ConvF Z	Alpha	Depth (mm)	Unct. (k=2)
750	41.9	0.89	6.41	6.41	6.41	1.00	1.00	± 12.0 %
835	41.5	0.90	6.18	6.18	6.18	1.00	1.00	± 12.0 %
1750	40.1	1.37	5.32	5.32	5.32	0.99	1.16	± 12.0 %
1900	40.0	1.40	5.15	5.15	5.15	1.00	1.15	± 12.0 %
2450	39.2	1.80	4.50	4.50	4.50	0.87	1.26	± 12.0 %
2600	39.0	1.96	4.33	4.33	4.33	0.87	1.24	± 12.0 %

^C Frequency validity of ± 100 MHz only applies for DASY v4.4 and higher (see Page 2), else it is restricted to ± 50 MHz. The uncertainty is the RSS of the ConvF uncertainty at calibration frequency and the uncertainty for the indicated frequency band.

^F At frequencies below 3 GHz, the validity of tissue parameters (ϵ and σ) can be relaxed to ± 10% if liquid compensation formula is applied to measured SAR values. At frequencies above 3 GHz, the validity of tissue parameters (ϵ and σ) is restricted to ± 5%. The uncertainty is the RSS of the ConvF uncertainty for indicated target tissue parameters.

DASY/EASY - Parameters of Probe: ES3DV3- SN:3258

Calibration Parameter Determined in Body Tissue Simulating Media

f (MHz) ^C	Relative Permittivity ^F	Conductivity (S/m) ^F	ConvF X	ConvF Y	ConvF Z	Alpha	Depth (mm)	Unct. (k=2)
750	55.5	0.96	6.16	6.16	6.16	1.00	1.00	± 12.0 %
835	55.2	0.97	6.12	6.12	6.12	1.00	1.00	± 12.0 %
1750	53.4	1.49	5.00	5.00	5.00	0.91	1.28	± 12.0 %
1900	53.3	1.52	4.75	4.75	4.75	0.90	1.23	± 12.0 %
2450	52.7	1.95	4.34	4.34	4.34	1.00	1.00	± 12.0 %
2600	52.5	2.16	4.16	4.16	4.16	0.94	1.15	± 12.0 %

^C Frequency validity of ± 100 MHz only applies for DASY v4.4 and higher (see Page 2), else it is restricted to ± 50 MHz. The uncertainty is the RSS of the ConvF uncertainty at calibration frequency and the uncertainty for the indicated frequency band.

^F At frequencies below 3 GHz, the validity of tissue parameters (ϵ and σ) can be relaxed to ± 10% if liquid compensation formula is applied to measured SAR values. At frequencies above 3 GHz, the validity of tissue parameters (ϵ and σ) is restricted to ± 5%. The uncertainty is the RSS of the ConvF uncertainty for indicated target tissue parameters.

Frequency Response of E-Field

(TEM-Cell: ifi110 EXX, Waveguide: R22)

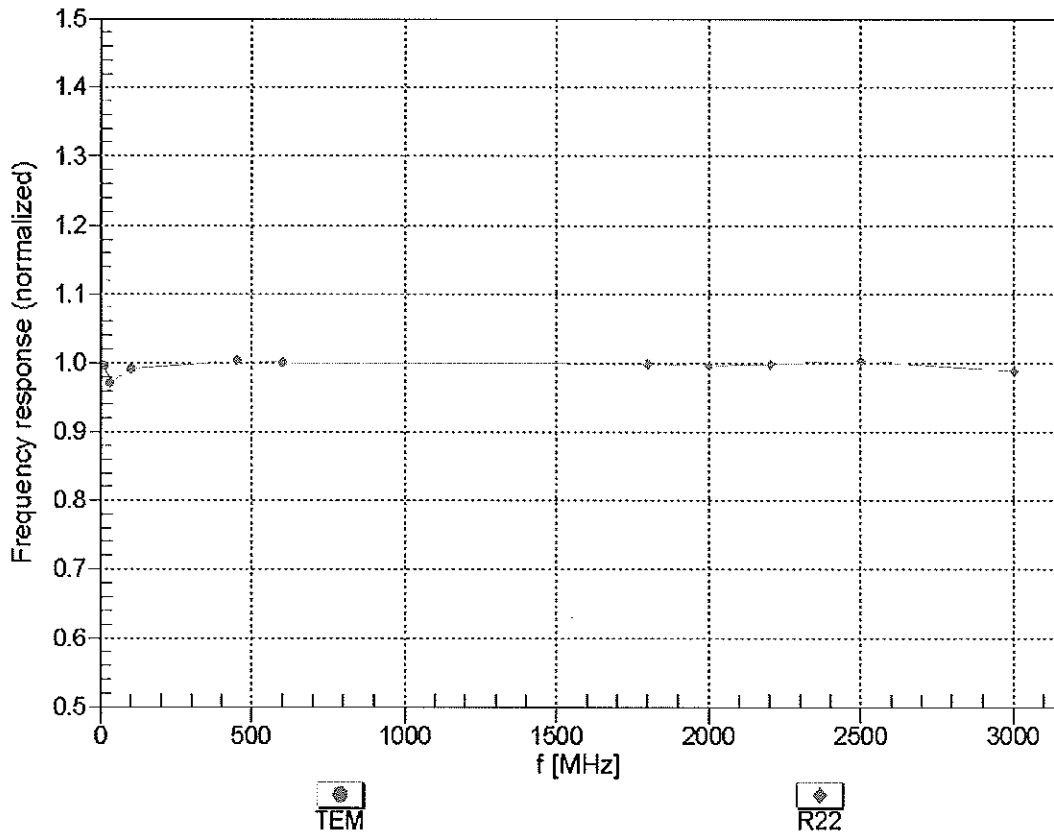

Uncertainty of Frequency Response of E-field: $\pm 6.3\%$ (k=2)

Receiving Pattern (ϕ), $\theta = 0^\circ$

f=600 MHz,TEM

f=1800 MHz,R22

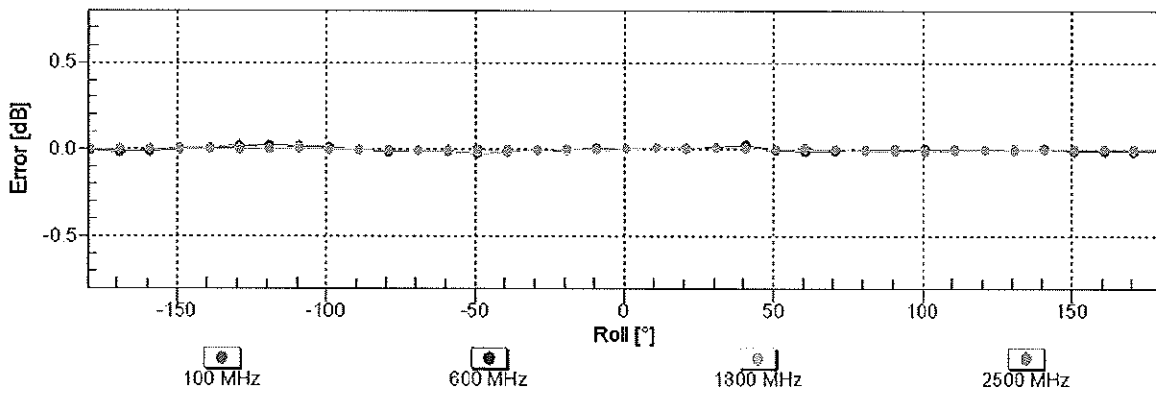
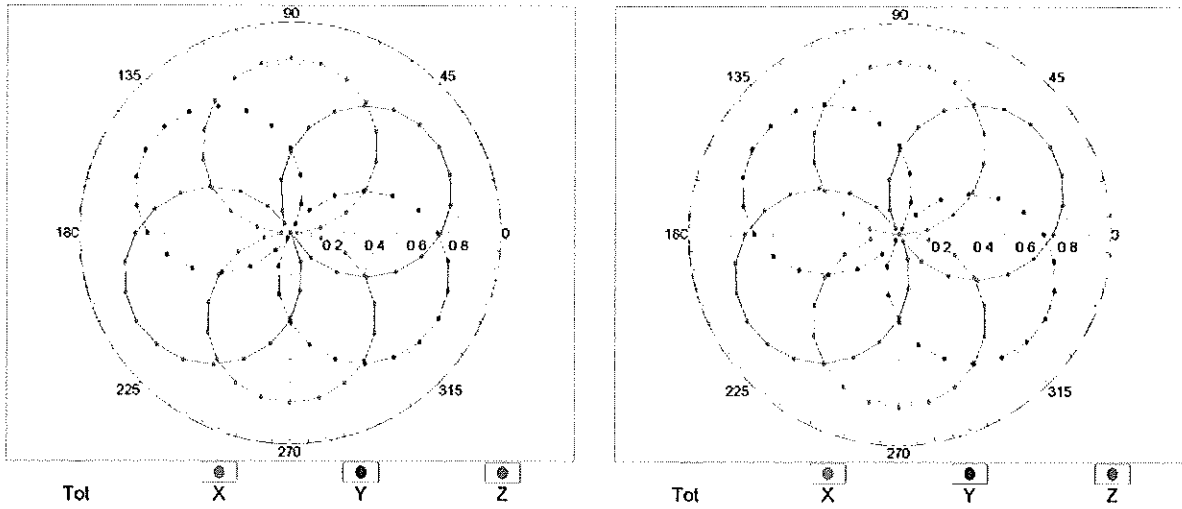

Uncertainty of Axial Isotropy Assessment: $\pm 0.5\%$ (k=2)

Dynamic Range $f(\text{SAR}_{\text{head}})$ (TEM cell , $f = 900 \text{ MHz}$)

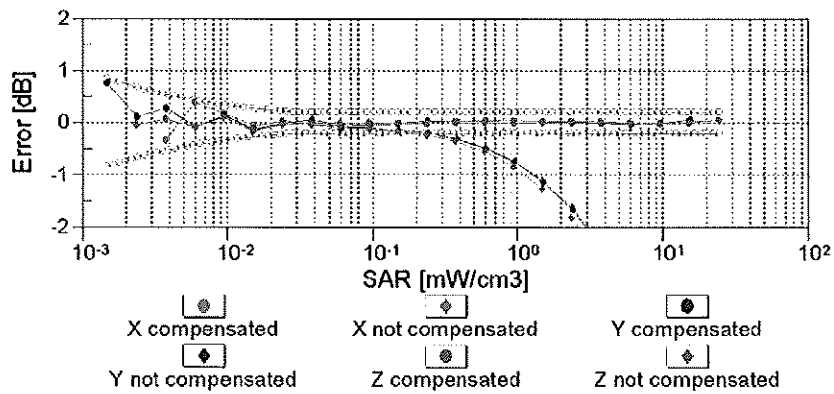
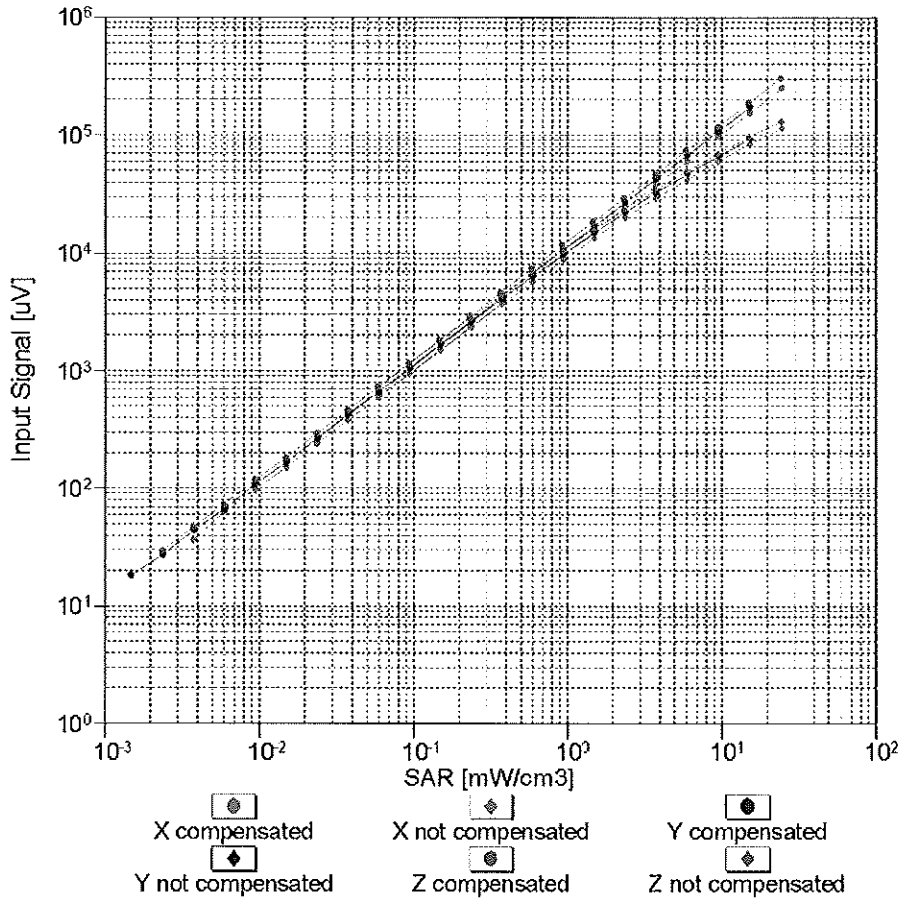

Uncertainty of Linearity Assessment: $\pm 0.6\%$ ($k=2$)

Conversion Factor Assessment

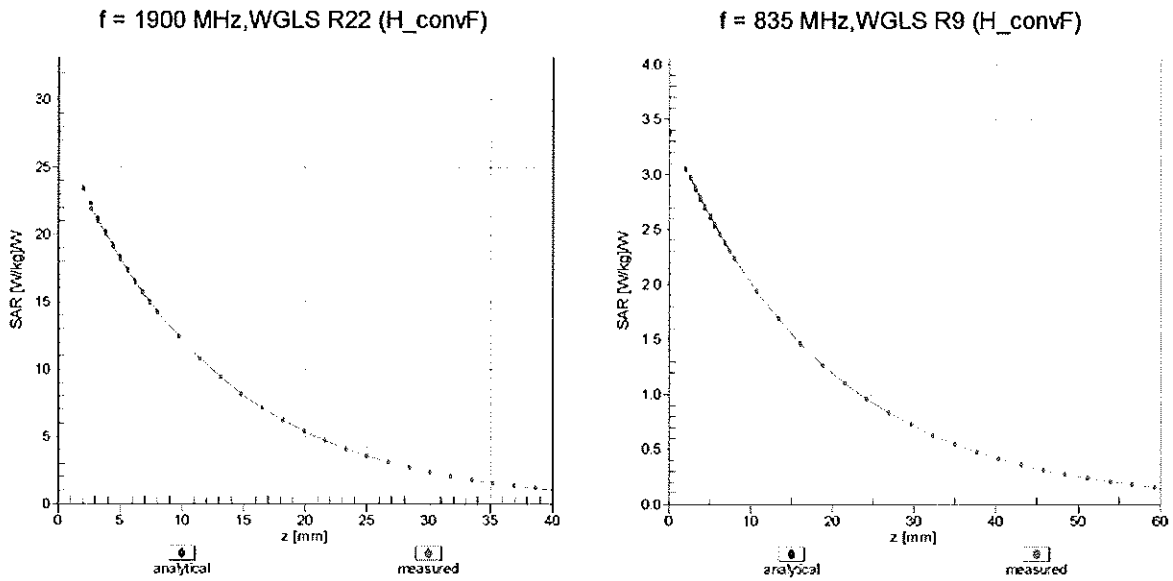

Deviation from Isotropy in Liquid Error (ϕ , θ), f = 900 MHz

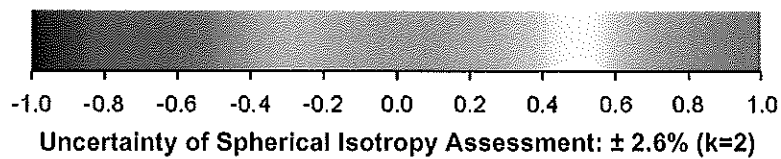
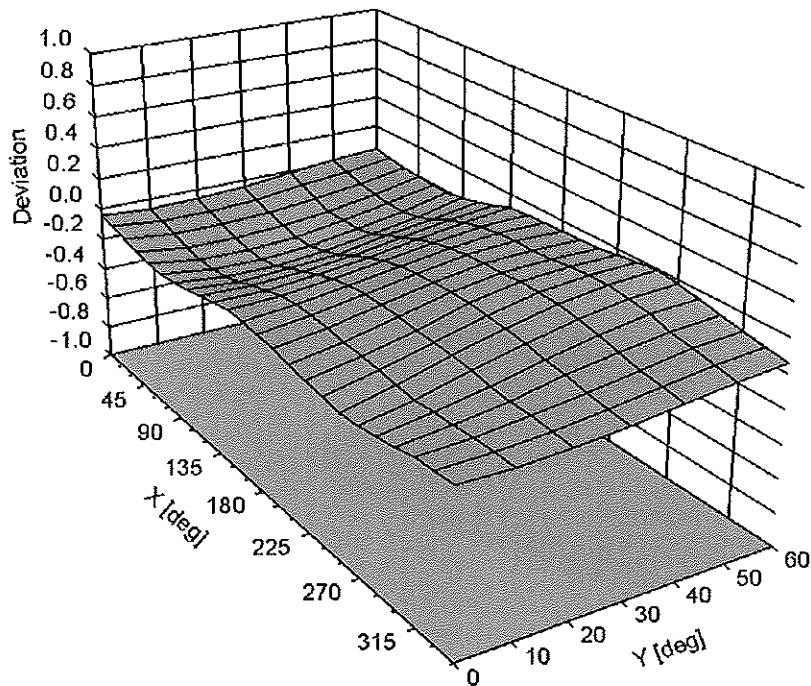

DASY/EASY - Parameters of Probe: ES3DV3 - SN:3258

Other Probe Parameters

Sensor Arrangement	Triangular
Connector Angle (°)	Not applicable
Mechanical Surface Detection Mode	enabled
Optical Surface Detection Mode	disabled
Probe Overall Length	337 mm
Probe Body Diameter	10 mm
Tip Length	10 mm
Tip Diameter	4 mm
Probe Tip to Sensor X Calibration Point	2 mm
Probe Tip to Sensor Y Calibration Point	2 mm
Probe Tip to Sensor Z Calibration Point	2 mm
Recommended Measurement Distance from Surface	3 mm