



**MOTOROLA**

## HAC Test Report for Near Field Emissions IHDT56MH1

**Tests Requested By:** Motorola Mobility, Inc.  
600 N. US Highway 45  
Libertyville, IL 60048

**Date of Tests:** Feb-04-2011  
**Date of Report:** Feb-11-2011

**Test Laboratory:** Motorola Mobility, Inc. - Product Safety & Compliance Laboratory  
600 N. US Highway 45  
Libertyville, Illinois 60048

**Report Author:** Thomas Knipple  
Senior RF Engineer

**Statement of Compliance:** Motorola declares under its sole responsibility that portable cellular telephone FCC ID IHDT56MH1 to which this declaration relates, complies with recommendations and guidelines per FCC 47 CFR §20.19. The measurements were performed to ensure compliance to ANSI C63.19-2007. It also declares that the product was tested in accordance with the appropriate measurement standards, guidelines and recommended practices. Any deviations from these standards, guidelines and recommended practices are noted below:

(none)

**Results Summary:** M Category = M3

©MOTOROLA MOBILITY, INC. 2011

This test report shall not be reproduced except in full, without written approval of the laboratory.

The results and statements contained herein relate only to the items tested. The names of individuals involved may be mentioned only in connection with the statements or results from this report.

Motorola encourages all feedback, both positive and negative, on this test report.

**Table of Contents**

**1. INTRODUCTION .....3**

**2. DESCRIPTION OF THE DEVICE UNDER TEST.....3**

**3. TEST EQUIPMENT USED.....4**

**4. VALIDATION .....5**

**5. PROBE MODULATION FACTOR .....6**

**6. TEST RESULTS.....8**

**Appendix 1: Details justifying the conversion to peak**  
**A1.1 Procedure for PMF measurements**  
**A1.2 0-span spectrum plots for PMF measurements**

**Appendix 2: HAC Distribution Plots for Validation**

**Appendix 3: HAC Distribution Plots for E-Field and H-Field**

**Appendix 4: Motorola Uncertainty Budget**  
**A4.1 Motorola Uncertainty Budget for RF HAC testing**  
**A4.2 Probe Rotation Contributions to Isotropy Error**

**Appendix 5: Pictures of Test Setup**

**Appendix 6: Probe Calibration Certificates**

**Appendix 7: Dipole Characterization Certificates**

**1. Introduction**

The Motorola Mobile Devices Business Product Safety Laboratory has performed Hearing Aid Compatibility (HAC) measurements for the portable cellular phone (FCC ID IHDT56MH1). The portable cellular phone was tested in accordance with the ANSI C63.19-2007 standard. The test results presented herein clearly demonstrate compliance per FCC 47 CFR § 20.19. This report demonstrates compliance for near-field emissions only and not for Telecoil HAC performance compliance.

**2. Description of the Device Under Test**

**Table 1: Information for the Device Under Test**

Serial number (Used For)	364VLYK6TY (All HAC testing, conducted power measurements)						
Mode(s) of Operation	800 iDEN (Interconnect / Dispatch)	800 iDEN (Packet Data)	900 iDEN (Interconnect/ Dispatch)	900 iDEN (Packet Data)	MOTotalk (Dispatch)	Wi-Fi 802.11b/g	Bluetooth
Modulation Mode(s)	M16-QAM	M64-QAM, M16-QAM, QPSK	M16-QAM	M64-QAM, M16-QAM, QPSK	8FSK	BPSK	GFSK
Maximum Output Power Setting	28.06 dBm		28.06 dBm		28.83 dBm	18.0 dBm	10.0 dBm
Duty Cycle	2:6 / 1:6	81:120	2:6 / 1:6	81:120	114:120	1:1	1:1
Transmitting Frequency Range(s)	806.0125 – 824.9875 MHz		896.01875 – 901.98125 MHz		902.525 – 927.475 MHz	2412.0 - 2462.5 MHz	2400.0 – 2483.5 MHz
Production Unit or Identical Prototype (47 CFR §2.908)	Identical Prototype						
Device Category	Portable						
Supports Voice on Interface	YES	NO	YES	NO	NO	YES (VOIP)	NO
Test requirements defined in C63.19-2007	YES	NO	YES	NO	NO	NO	NO
Supports Simultaneous Operation With	Wi-Fi, Bluetooth	Bluetooth	Wi-Fi, Bluetooth	Bluetooth	Wi-Fi	iDEN, MOTotalk	iDEN

Note: No Bluetooth profile exists in this phone that will allow a Bluetooth link while in a cellular call that passes audio to the earpiece. If the user had Bluetooth enabled and a link established, they could not be listening to the phone through the earpiece.

Note: Wi-Fi capability is included in this phone without measurements for hearing aid compatibility based on the interim ruling by the FCC according to paragraph 37 of the Federal Register, Volume 3, Number 89, as of May 7, 2008. Users shall be informed of this via the product user guide per the same FCC ruling.

**3. Test Equipment Used**

The Motorola Mobile Devices Business Product Safety & Compliance Laboratory utilizes a Dosimetric Assessment System (DASY4™ v4.7) manufactured by Schmid & Partner Engineering AG (SPEAG™), of Zurich Switzerland. All the HAC measurements are taken within a shielded enclosure. The measurement uncertainty budget is given in Appendix 4. The list of calibrated equipment used for the measurements is shown below.

**Table 2: Dosimetric System Equipment**

Description	Serial Number	Cal Date	Cal Due Date
E-Field Probe ER3DV6R	2244	May-11-2010	May-11-2011
DAE4	387	May-19-2010	May-19-2011
H-Field Probe H3DV6	6078	May-11-2010	May-11-2011
DAE4	650	May-20-2010	May-20-2011
835 MHz Dipole CD835V3	1076	Feb-16-2010	Feb-16-2012

**Table 3: Additional Test Equipment**

Description	Serial Number	Cal Date	Cal Due Date
Power Supply 6623A	US37360829	Nov-02-2009	Nov-05-2011
Signal Generator E4438C	MY45090104	Aug-22-2009	Aug-22-2011
Amplifier ZHL-42-SMA	1040		
3 dB Attenuator 8491A	50579	Nov-13-2009	Nov-13-2011
Directional Coupler 778D	18578	Jun-07-2010	Jun-07-2012
Power Meter E4417A	MY45100140	Dec-23-2009	Dec-23-2011
Power Sensor #1 – E9323A	MY44420341	Aug-30-2010	Aug-30-2011
Power Sensor #2 - E9323A	MY44420342	Aug-30-2010	Aug-30-2011
10 dB Attenuator 8491A	3929M50704	Nov-12-2009	Nov-12-2011
Spectrum Analyzer E4403B	US39440480	Oct-26-2010	Oct-26-2011
Power Splitter ZAPD-21-S(+)	SU327300437		

### 4. Validation

Validations of the DASY4 v4.7 test system were performed using the measurement equipment listed in Section 3.1. All validations occur in free space using the DASY4 test arch. Note that the 10 mm probe-to-dipole separation is measured from the top edge of the dipole to the calibration reference point of the probe. SPEAG uses the center point of the probe sensor(s) as the reference point when establishing targets for their dipoles. Therefore, because SPEAG’s dipoles and targets are used, it is appropriate to measure the 10 mm separation distance to the center of the sensors as they do. This reference point was used for validation only. Validations were performed at 835 MHz and/or 898 MHz. The results obtained from the validations are displayed in the table below. The field contour plots are included in Appendix 2.

Validations were performed to verify that measured E-field and H-field values are within  $\pm 25\%$  from the target reference values provided by the manufacturer (Ref: Appendix 7). Per Section 4.3.2.1 of the C63.19 standard, “Values within  $\pm 25\%$  are acceptable, of which 12% is deviation and 13% is measurement uncertainty”. Therefore, the E-field and H-field dipole verification results shown in Table 4 are in accordance with the acceptable parameters defined by the standard.

**Table 4: Dipole Measurement Summary**

Dipole	Date	f (MHz)	Protocol	Input Power (mW)	E-Field Results (V/m)	Target for Dipole (V/m)	% Deviation
1076	Feb-04-2011	835	CW	100	169.25	164.8	+2.7%
1076	Feb-04-2011	898	CW	100	151.55	155.3	-2.4%

Dipole	Date	f (MHz)	Protocol	Input Power (mW)	H-Field Results (A/m)	Target for Dipole (A/m)	% Deviation
1076	Feb-04-2011	835	CW	100	0.455	0.459	-0.9%
1076	Feb-04-2011	898	CW	100	0.428	0.434	-1.4%

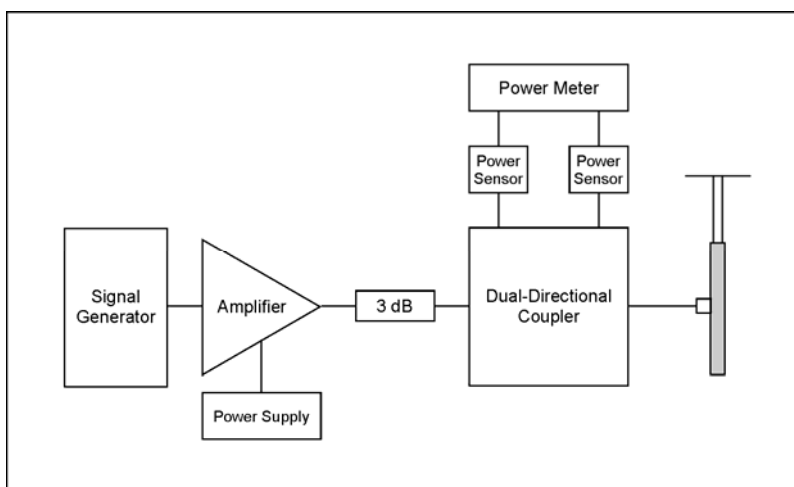

**Figure 1: Setup for Validation measurements**

### 5. Probe Modulation Factor

After every probe calibration, the response of the probe to each applicable modulated signal (CDMA, GSM, etc) must be assessed at the frequencies of operation. The response of the probe system to a CW field at each frequency of interest is compared to its response to a modulated signal with equal peak amplitude. For each PMF assessment, a signal generator was used to replace the original CW signal with the desired modulated signal. The PMF results applicable to this test document are shown in Table 5.

RF Field Probe Modulation Response was measured with the field probe and associated measurement equipment. The PMF was measured using a signal generator as follows:

1. Illuminate a dipole with a CW signal at the intended measured frequency.
2. Fix the probe at a set location relative to the dipole, typically located at the field reference point.
3. Record the reading of the probe measurement system of the CW signal.
4. Substitute a modulated signal of the same amplitude, using the same modulation as that used by the intended WD for the CW signal.
5. Record the reading of the probe measurement system of the modulated signal.
6. The ratio of the CW to modulated signal reading is the probe modulation factor.

Using a dual-directional coupler, the forward power and reverse power are measured and adjusted when connected to the dipole and spectrum analyzer through a power splitter and matched cables. The spectrum analyzer is used to set the peak amplitude of the modulated signal equal to the amplitude of the CW signal. The procedure used to ensure that the amplitudes are the same is given in Appendix 1. 0-Span spectrum plots for each signal type measured are also provided in Appendix 1.

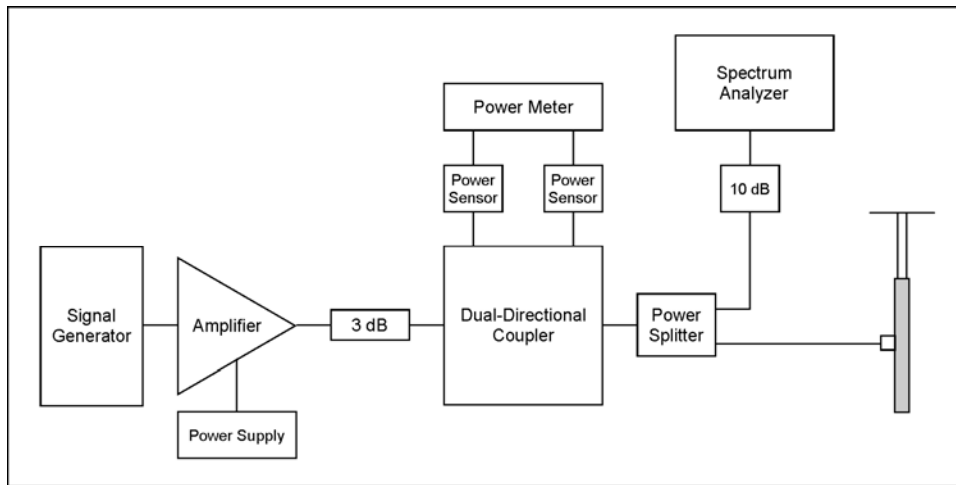

**Figure 2: Setup for PMF measurements**

To measure the PMF for an iDEN signal, the modulated signal is injected into the dipole. When the peak power level produces a field strength less than or equal to the M3 category limit, this power level is used. If this peak power level produces a field strength much greater than the M3 category limit, a power level which produces a field strength approximately equal to the M3 category limit is used instead.

**Table 5: PMF Measurement Summary**

f (MHz)	Protocol	E-Field Probe SN 2244		H-Field Probe SN 6078	
		E-Field (V/m)	E-Field Modulation Factor	H-Field (A/m)	H-Field Modulation Factor
813	CW	295.9		1.145	
	iDEN (2:6 Rate)	83.86	3.53	0.3714	3.08
	iDEN (1:6 Rate)	58.78	5.03	0.2632	4.35
898	CW	223.0		1.059	
	iDEN (2:6 Rate)	65.53	3.40	0.3506	3.02
	iDEN (1:6 Rate)	45.96	4.85	0.2461	4.30

f (MHz)	Protocol	E-Field Probe SN 2244		H-Field Probe SN 6078	
		E-Field (V/m)	E-Field Modulation Factor	H-Field (A/m)	H-Field Modulation Factor
813	CW	116.0		0.5281	
	80% AM	73.35	1.58	0.3423	1.54
898	CW	90.36		0.4392	
	80% AM	57.04	1.58	0.2847	1.54

## 6. Test Results

The phone was tested in normal configurations for against-the-ear use. When applicable, configurations are tested with the antenna in its fully-extended position. These test configurations are tested at the high, middle and low frequency channels of each applicable operating band and mode; for example, GSM, CDMA, WCDMA, or iDEN.

The DUT is capable of operation in a test mode that allows control of the transmitter without the need to place actual phone calls. This guarantees that the unit does not change its transmitter power, and that the resultant measured field values will not be affected by external connections. For the purposes of this testing the unit is commanded to test mode and manually set to the proper channel, transmitter power level and transmit mode of operation. For the purposes of these tests, the transmitter was operated at the highest power level available.

The cellular phone model tested in this report uses the following default battery:

Battery #1 – SNN5875A – 1860 mAH Battery

The phone is placed in the HAC measurement system with a fully charged battery. At the end of each test the DASY™ system measures the drift of the field strength at a fixed reference point to ensure that the DUT has not changed in transmitter power.

The DASY4 v4.7 measurement system specified in section 3.1 was utilized within the intended operations as set by the SPEAG™ setup. The default settings for the grid spacing of the scan were set to 5 mm as shown in the Field plots included in Appendix 2 and 3. The 5 cm x 5 cm area measurement grid is centered on the acoustic output of the device. The Test Arch provided by SPEAG is used to position the DUT. The pictures of the setup are included in Appendix 5. The WD reference plane is parallel to the device and contains the highest point on its contour in the area of the phone that normally rests against the user's ear. The measurement plane contains the center point of the probe sensor(s). The device is positioned such that the WD reference plane is located 15 mm from, and parallel to, the measurement plane. This is in accordance with section 4.4 of the standard, which states that "The WD reference plane is a plane parallel with the front "face" of the WD and containing the highest point on its contour in the area of the phone that normally rests against the user's ear."

During testing, the DUT is placed into a polystyrene block (3-pound expanded polystyrene) which is machined to precisely fit the DUT's shape. The test positioner, provided by SPEAG, is used to grip the block. This positioning conforms to the specifications given in the paragraph above. The addition of the block does not increase the uncertainty budget, which is provided in Appendix 4. The pictures of the measurement setup are included in Appendix 5.

The HAC Rating results for E-Field and H-field are shown in Tables 6 through 9. Also shown are the measured conducted output powers, the measured drifts, excluded areas, and the peak field values. PMF measurements are taken from Section 5. The worst-case test conditions are indicated with **bold numbers** in the tables and are detailed in Appendix 3: HAC distribution plots for E-Field and H-Field.

Drift was measured using the typical DASY4 v4.7 measurement routines. The field is measured at the reference location (center of the ear piece) at the beginning of the test. After completion of the E-field or H-field measurement, the probe returns to the same reference location and takes another measurement. The drift is the delta between these two values and is included in the test report scans.

Per SPEAG's recommendation, the phone plots in Appendix 3 use the following standard transmitter ratios as "Duty Cycle": 1:8 for GSM transmitters; 1:1 for full-rate CDMA and 1:8 for 1/8<sup>th</sup> rate CDMA; 1:1 for WCDMA; 1:6 for 1:6 rate iDEN and 1:3 for 2:6 rate iDEN. Per SPEAG's recommendation, in order to account for probe modulation response, PMF is applied during post-processing of the measured data in SEMCAD. PMF also appears in the phone plots in Appendix 3.

DUT Emissions Limits (AWF = 0) f < 960 MHz	
Rating	E-Field
M3	199.5 – 354.8 V/m
M4	< 199.5 V/m

**Table 6: HAC E-Field measurement results for the portable cellular telephone at highest possible output power (2:6 Rate).**

Band	Antenna Position	Frequency Setting (MHz)	Conducted Output Power (dBm)	Measured PMF	Drift (dB)	Excluded Cells	Peak Field (V/m)	Rating
iDEN 800	Internal	806.0125	28.01	3.53	0.183	8,9	221.0	M3
		815.5125	27.98		-0.023	8,9	261.0	M3
		824.9875	27.99		<b>-0.042</b>	<b>8,9</b>	<b>277.0</b>	<b>M3</b>
iDEN 900	Internal	896.0188	28.09	3.40	-0.096	8,9	235.1	M3
		901.9813	28.15		<b>-0.171</b>	<b>8,9</b>	<b>254.5</b>	<b>M3</b>

**Table 7: HAC E-Field measurement results for the portable cellular telephone at highest possible output power (1:6 Rate).**

Band	Antenna Position	Frequency Setting (MHz)	Conducted Output Power (dBm)	Measured PMF	Drift (dB)	Excluded Cells	Peak Field (V/m)	Rating
iDEN 800	Internal	806.0125	28.00	5.03	-0.076	8,9	228.5	M3
		815.5125	28.11		-0.062	8,9	261.8	M3
		824.9875	27.99		<b>-0.023</b>	<b>2,3</b>	<b>278.2</b>	<b>M3</b>
iDEN 900	Internal	896.0188	28.21	4.85	-0.076	8,9	240.9	M3
		901.9813	28.13		<b>-0.007</b>	<b>8,9</b>	<b>258.4</b>	<b>M3</b>

DUT Emissions Limits (AWF = 0) f < 960 MHz	
Rating	H-Field
M3	0.60 – 1.07 A/m
M4	< 0.60 A/m

**Table 8: HAC H-Field measurement results for the portable cellular telephone at highest possible output power (2:6 Rate).**

Band	Antenna Position	Frequency Setting (MHz)	Conducted Output Power (dBm)	Measured PMF	Drift (dB)	Excluded Cells	Peak Field (A/m)	Rating
iDEN 800	Internal	806.0125	28.01	3.08	0.037	1,4,7	0.256	M4
		815.5125	27.98		-0.147	1,4,7	0.310	M4
		824.9875	27.99		<b>-0.073</b>	<b>1,4,7</b>	<b>0.323</b>	<b>M4</b>
iDEN 900	Internal	896.0188	28.09	3.02	<b>-0.113</b>	<b>1,4,7</b>	<b>0.327</b>	<b>M4</b>
		901.9813	28.15		-0.168	1,4,7	0.229	M4

**Table 9: HAC H-Field measurement results for the portable cellular telephone at highest possible output power (1:6 Rate).**

Band	Antenna Position	Frequency Setting (MHz)	Conducted Output Power (dBm)	Measured PMF	Drift (dB)	Excluded Cells	Peak Field (A/m)	Rating
iDEN 800	Internal	806.0125	28.00	4.35	<b>-0.153</b>	<b>1,4,7</b>	<b>0.327</b>	<b>M4</b>
		815.5125	28.11		0.168	1,4,7	0.263	M4
		824.9875	27.99		-0.061	1,4,7	0.307	M4
iDEN 900	Internal	896.0188	28.21	4.30	-0.196	1,4,7	0.337	M4
		901.9813	28.13		<b>0.086</b>	<b>1,4,7</b>	<b>0.341</b>	<b>M4</b>

**Appendix 1**

**Details justifying the conversion to peak**

### A1.1 Procedure for PMF measurements

1. Set up and calibrate the HAC validation rack as noted in Figure 2; a power splitter is connected to the dual-directional coupler, which is then connected to both the spectrum analyzer and dipole on the output side of the splitter using matched cables. This cabling arrangement will remain in place throughout the following steps.
2. Command the HAC validation rack as you would for a normal CW HAC validation with forward power per Table A1 for the mode, frequency, and field probe type of interest.
3. Set up the dipole and phantom as you would for a normal CW HAC validation.
4. In the DASY software, open appropriate job template and verify the following parameters:  
Medium = "Air";  
Communication System = "HAC – Dipole";  
Ensure the proper probe & DAE are installed and laser aligned
5. **Measure the CW signal:** With the CW signal transmitting through the dipole, command the DASY system to run the appropriate field measurement job.
6. Do **not** turn off the signal generator power.
7. **Setting the CW Reference Level on the Spectrum Analyzer:**
  - a. Set up the Spectrum Analyzer for the following Settings:

Frequency:	Freq. being tested (EX: 835/1880)
Span:	Zero Span
Res BW:	iDEN – 100 kHz; GSM – 300 kHz; CDMA – 3 MHz; WCDMA – 5 MHz;
Video BW:	iDEN – 300 kHz; GSM – 1MHz; CDMA and WCDMA – 30 kHz**;
Sweep Time:	20 ms; 120 ms for iDEN
Scale:	1 dB
Detector:	PEAK / Manual
  - b. Adjust the REF level until the CW signal is aligned with the Center Line (approx. 15 dB). NOTE: After this point, the Reference Line must remain fixed. Do not change it.
8. **Measure the modulated signal(s):**
  - a. Command the signal generator to the desired modulation.
  - b. Set the Spectrum Analyzer Sweep Time to 20 ms.
  - c. Adjust the amplitude of the power on the signal generator so that the PEAK of the modulated signal is at the CW Reference Line:
    - i. On the Spectrum Analyzer, press the [View Trace] button and then select (Max Hold), this will show only the Peak output.
    - ii. Press (Clear Write) and then (Max Hold) each time an amplitude adjustment is made.
  - d. Allow the Max Hold line to stabilize. Then check that the highest peak of the Max Hold line corresponds with the CW Reference Line (without going over). If not correct, repeat the steps beginning with step 8c.
9. Command the DASY system to run the appropriate field measurement job.
10. Repeat steps 2 through 9 until all PMF measurements have been completed.

\*\*The use of 30 kHz VBW is validated. The power measurements are verified using an average power meter.

**Table A1: PMF Measurement, CW Signal Dipole Input Power**

Mode	f (MHz)	Field Probe Type	Dipole Input Power	Notes
80% AM	813	E and H	100 mW	
	835			
	898			
	1730			
	1880			
CDMA (Full & 1/8 <sup>th</sup> )	835	E and H	320 mW	1
	1730		50 mW	2
	1880		50 mW	2
WCDMA	835	E and H	250 mW	1
	1730		50 mW	2
	1880		50 mW	2
GSM	835	E-Field	690 mW	2
		H-Field	270 mW	2
	1880	E-Field	35 mW	2
		H-Field	27 mW	2
iDEN (1:6 & 2:6)	813	E-Field	640 mW	1
		H-Field	460 mW	2
	898	E-Field	640 mW	1
		H-Field	580 mW	2

**Note 1:** The power level shown represents the typical DUT peak power level for this configuration.

**Note 2:** The typical peak power level for this configuration results in a field strength significantly higher than the relevant M3 category limit field strength, and is therefore not realistic. The power level shown results in a field strength approximating the M3 category limit value.

### A1.2 0-Span Spectrum Plots for PMF measurements

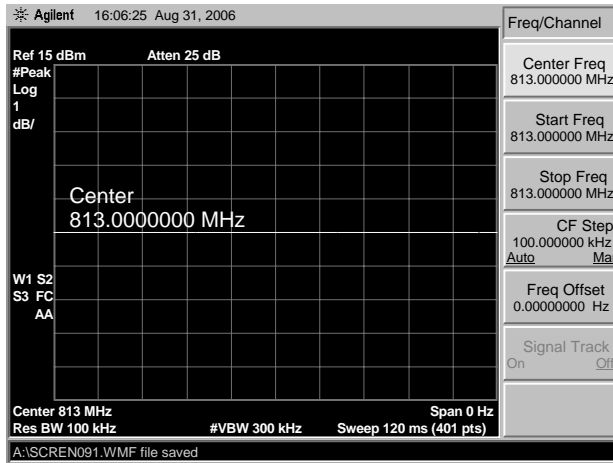

CW 813 MHz

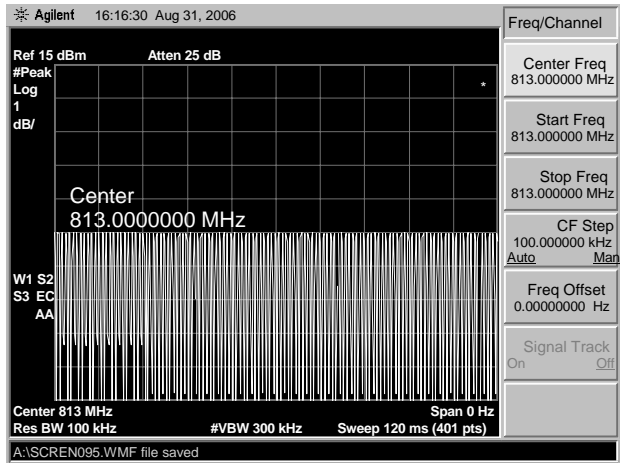

80% AM 813 MHz

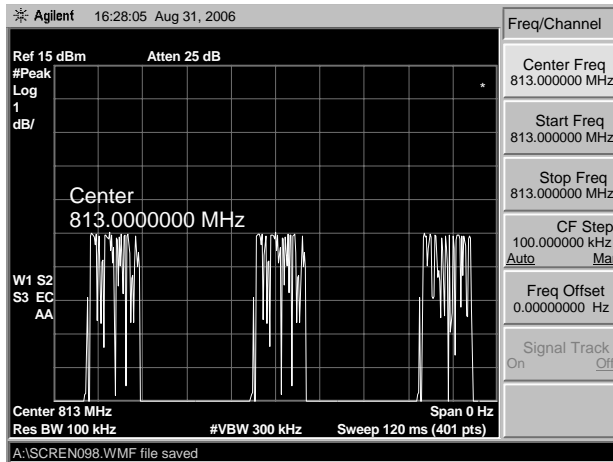

iDEN 813 MHz (2:6 rate)

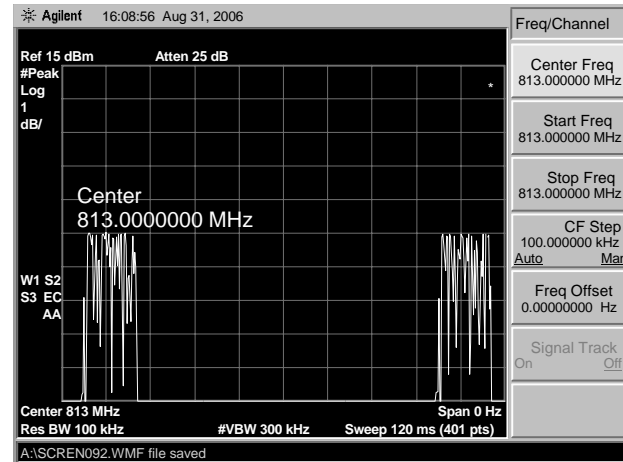

iDEN 813 MHz (1:6 rate)

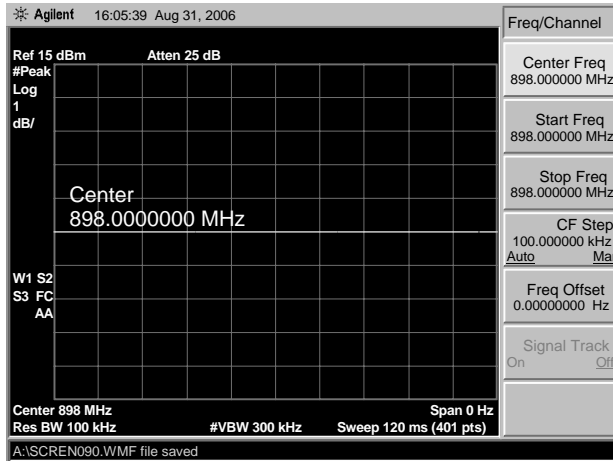

CW 898 MHz

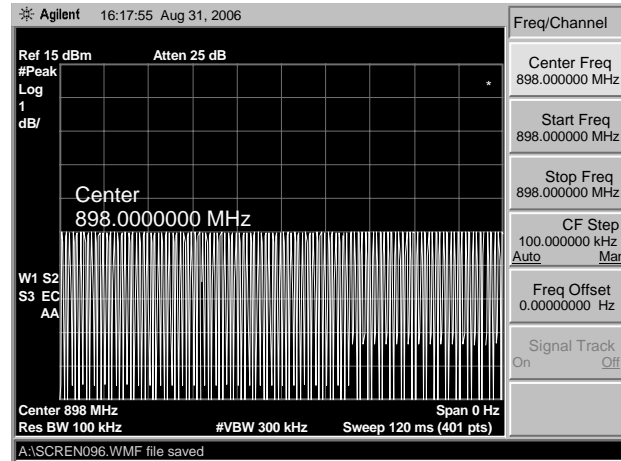

80% AM 898 MHz

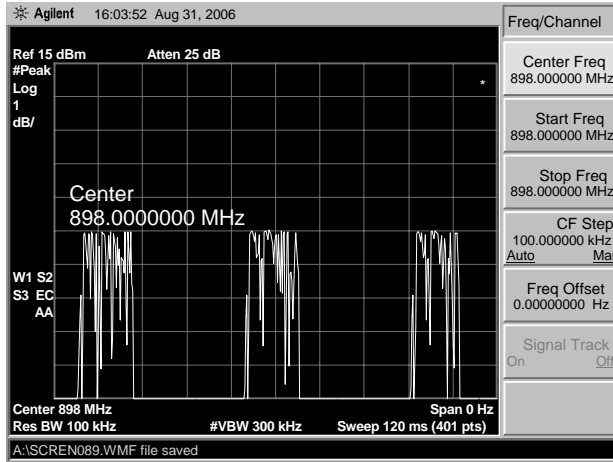

iDEN 898 MHz (2:6 rate)

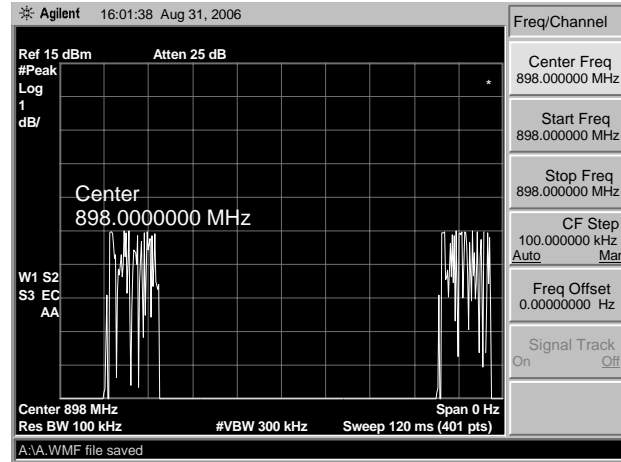

iDEN 898 MHz (1:6 rate)

**Appendix 2**

**HAC distribution plots for Validation**

Date/Time: 2/4/2011 6:40:42 AM

## Test Laboratory: Motorola - Feb-04-2011 E-Field 835 MHz

**DUT: HAC-Dipole 835 MHz; Type: CD835V3; Serial: 1076; FCC ID: IHDT56MH1**

Procedure Notes: 835 MHz HAC Validation; Dipole Sn# 1076; Input Power = 100 mW

Communication System: CW - HAC; Frequency: 835 MHz; Duty Cycle: 1:1

Medium: Air; Medium parameters used:  $\sigma = 0$  mho/m,  $\epsilon_r = 1$ ;  $\rho = 0$  kg/m<sup>3</sup>

DASY4 Configuration:

- Probe: ER3DV6R - SN2244; ConvF(1, 1, 1); Calibrated: 5/11/2010
- Sensor-Surface: 0mm (Fix Surface)Sensor-Surface: (Fix Surface)
- Electronics: DAE4 Sn387; Calibrated: 5/19/2010
- Phantom: R-3, HAC Test Arch (rev.2); Type: SD HAC P01 BA; Serial: 1071;
- Measurement SW: DASY4, V4.7 Build 80; Postprocessing SW: SEMCAD, V1.8 Build 186

### E Scan - Probe center 10mm above Dipole/Hearing Aid Compatibility Test (41x361x1):

Measurement grid: dx=5mm, dy=5mm; Probe Modulation Factor = 1.00

Device Reference Point: 0.000, 0.000, -6.30 mm; Reference Value = 99.3 V/m; Power Drift = 0.033 dB

Maximum value of Total (interpolated) = 177.7 V/m

Average value of Total (interpolated) =  $(177.7 + 160.8) / 2 = 169.25$  V/m

Peak E-field in V/m

Grid 1 <b>169.2 M4</b>	<b>Grid 2</b> <b>177.7 M4</b>	Grid 3 <b>175.6 M4</b>
Grid 4 <b>87.7 M4</b>	Grid 5 <b>91.7 M4</b>	Grid 6 <b>91.3 M4</b>
Grid 7 <b>149.4 M4</b>	<b>Grid 8</b> <b>160.8 M4</b>	Grid 9 <b>160.7 M4</b>

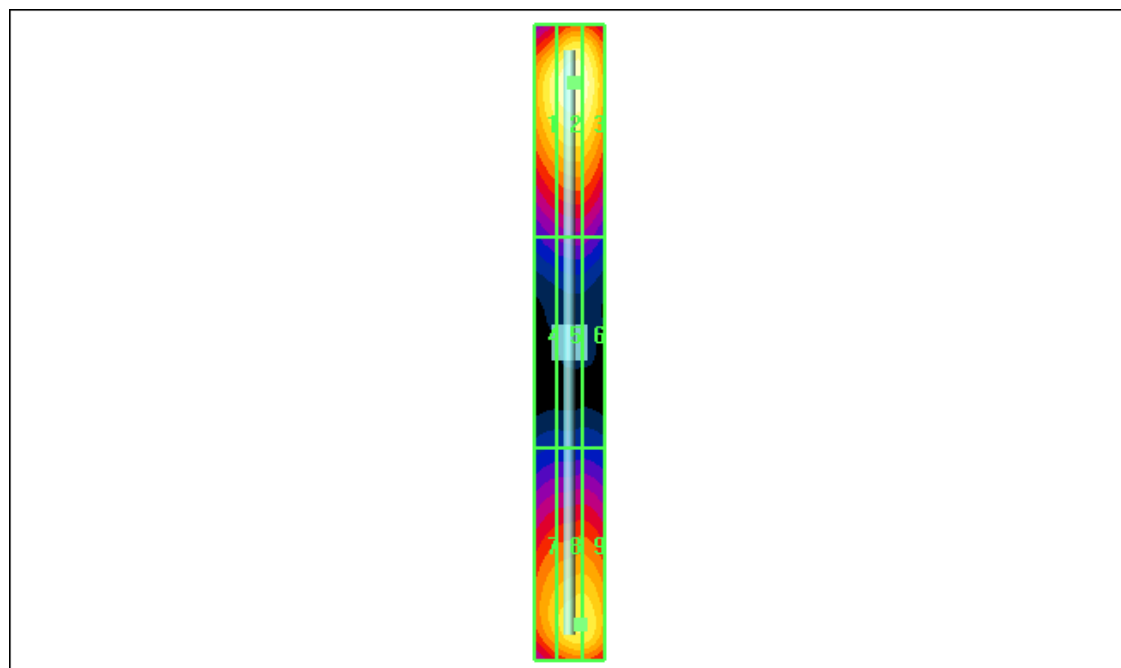
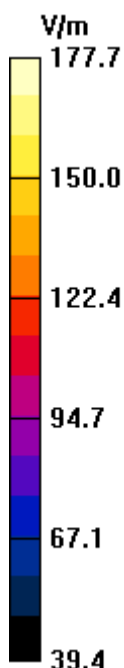

Date/Time: 2/4/2011 7:32:20 AM

## Test Laboratory: Motorola - Feb-04-2011 E-Field 898 MHz

DUT: HAC-Dipole 898 MHz; Type: CD835V3; Serial: 1076; FCC ID: IHDT56MH1

Procedure Notes: 898 MHz HAC Validation; Dipole Sn# 1076; Input Power = 100 mW

Communication System: CW - HAC; Frequency: 898 MHz; Duty Cycle: 1:1

Medium: Air; Medium parameters used:  $\sigma = 0$  mho/m,  $\epsilon_r = 1$ ;  $\rho = 0$  kg/m<sup>3</sup>

DASY4 Configuration:

- Probe: ER3DV6R - SN2244; ConvF(1, 1, 1); Calibrated: 5/11/2010
- Sensor-Surface: 0mm (Fix Surface)Sensor-Surface: (Fix Surface)
- Electronics: DAE4 Sn387; Calibrated: 5/19/2010
- Phantom: R-3, HAC Test Arch (rev.2); Type: SD HAC P01 BA; Serial: 1071;
- Measurement SW: DASY4, V4.7 Build 80; Postprocessing SW: SEMCAD, V1.8 Build 186

### E Scan - Probe center 10mm above Dipole/Hearing Aid Compatibility Test (41x361x1):

Measurement grid: dx=5mm, dy=5mm; Probe Modulation Factor = 1.00

Device Reference Point: 0.000, 0.000, -6.30 mm; Reference Value = 85.5 V/m; Power Drift = -0.019 dB

Maximum value of Total (interpolated) = 158.9 V/m

Average value of Total (interpolated) =  $(158.9 + 144.2) / 2 = 151.55$  V/m

Peak E-field in V/m

Grid 1 <b>151.7 M4</b>	<b>Grid 2</b> <b>158.9 M4</b>	Grid 3 <b>157.1 M4</b>
Grid 4 <b>72.8 M4</b>	Grid 5 <b>76.7 M4</b>	Grid 6 <b>75.9 M4</b>
Grid 7 <b>134.3 M4</b>	<b>Grid 8</b> <b>144.2 M4</b>	Grid 9 <b>144.1 M4</b>

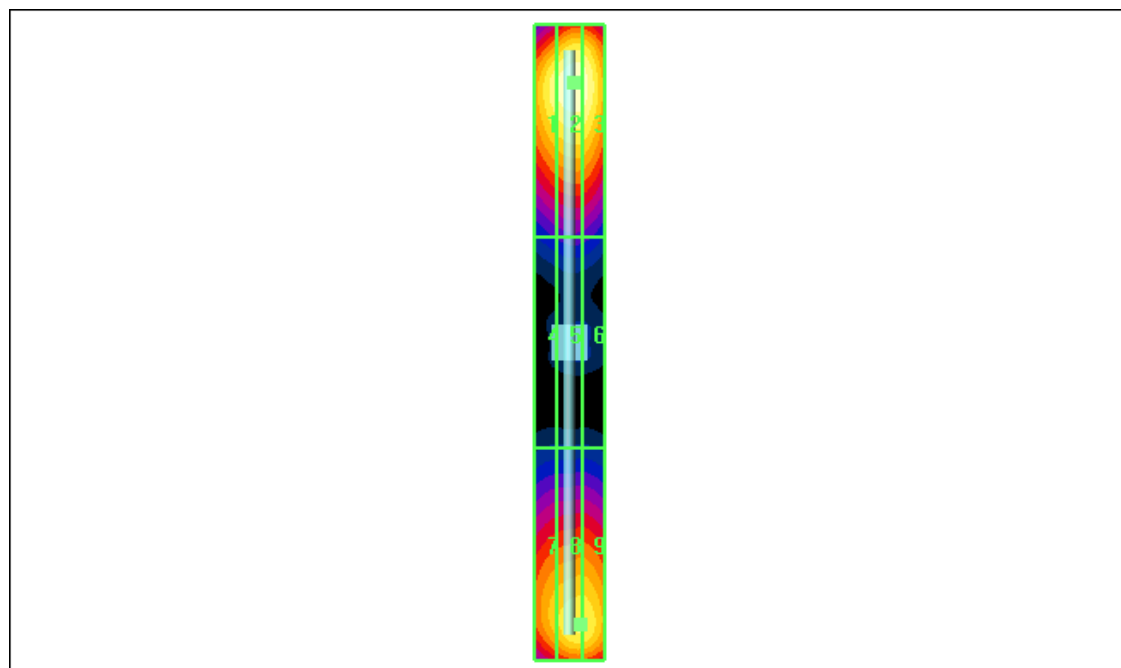
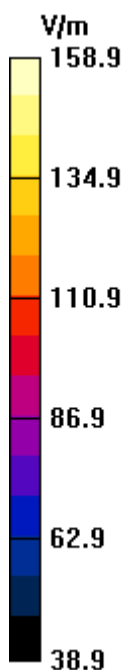

Date/Time: 2/4/2011 6:55:19 AM

## Test Laboratory: Motorola - Feb-04-2011 H-Field 835 MHz

**DUT: HAC-Dipole 835 MHz; Type: CD835V3; Serial: 1076; FCC ID: IHDT56MH1**

Procedure Notes: 835 MHz HAC Validation; Dipole Sn# 1076; Input Power = 100 mW

Communication System: CW - HAC; Frequency: 835 MHz; Duty Cycle: 1:1

Medium: Air; Medium parameters used:  $\sigma = 0$  mho/m,  $\epsilon_r = 1$ ;  $\rho = 0$  kg/m<sup>3</sup>

DASY4 Configuration:

- Probe: H3DV6 - SN6078; ; Calibrated: 5/11/2010
- Sensor-Surface: 0mm (Fix Surface)Sensor-Surface: (Fix Surface)
- Electronics: DAE4 Sn650; Calibrated: 5/20/2010
- Phantom: R-3, HAC Test Arch (rev.2); Type: SD HAC P01 BA; Serial: 1071;
- Measurement SW: DASY4, V4.7 Build 80; Postprocessing SW: SEMCAD, V1.8 Build 186

### H Scan - Probe center 10mm above Dipole/Hearing Aid Compatibility Test (41x361x1):

Measurement grid: dx=5mm, dy=5mm; Probe Modulation Factor = 1.00

Device Reference Point: 0.000, 0.000, -6.30 mm; Reference Value = 0.478 A/m; Power Drift = 0.018 dB

**Maximum value of Total (interpolated) = 0.455 A/m**

Peak H-field in A/m

Grid 1 <b>0.375 M4</b>	Grid 2 <b>0.419 M4</b>	Grid 3 <b>0.409 M4</b>
Grid 4 <b>0.412 M4</b>	<b>Grid 5</b> <b>0.455 M4</b>	Grid 6 <b>0.445 M4</b>
Grid 7 <b>0.355 M4</b>	Grid 8 <b>0.391 M4</b>	Grid 9 <b>0.385 M4</b>

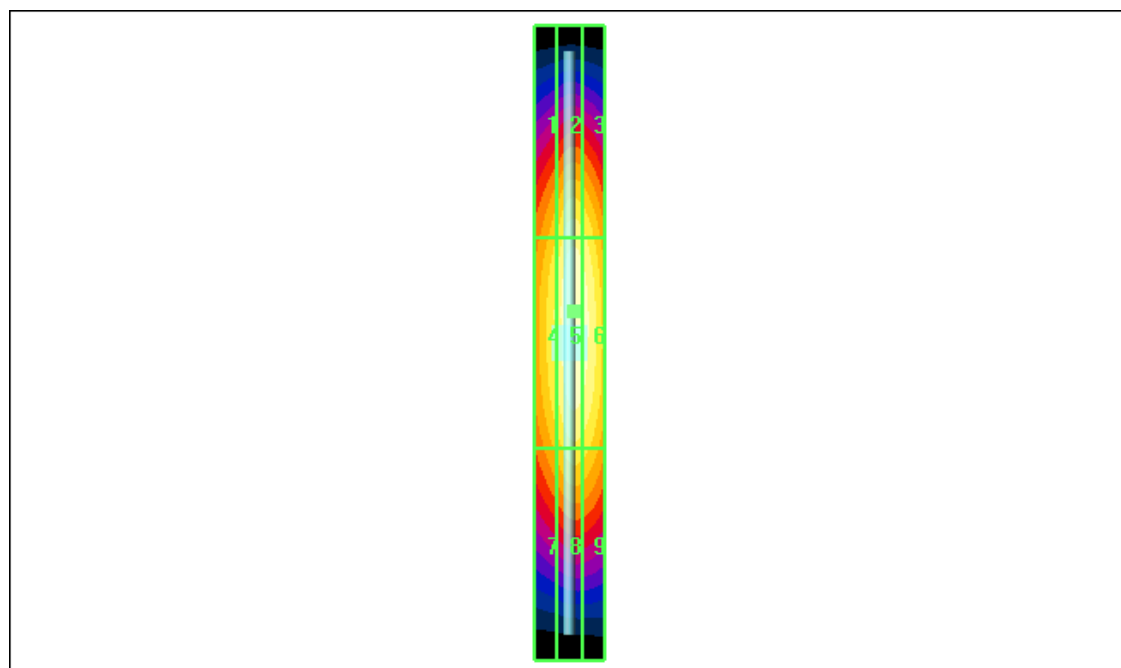
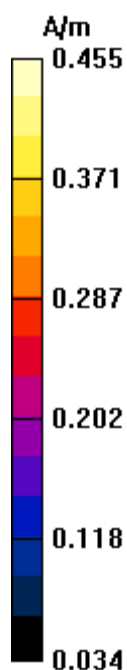

Date/Time: 2/4/2011 7:05:52 AM

## Test Laboratory: Motorola - Feb-04-2011 H-Field 898 MHz

**DUT: HAC-Dipole 898 MHz; Type: CD835V3; Serial: 1076; FCC ID: IHDT56MH1**

Procedure Notes: 898 MHz HAC Validation; Dipole Sn# 1076; Input Power = 100 mW

Communication System: CW - HAC; Frequency: 898 MHz; Duty Cycle: 1:1

Medium: Air; Medium parameters used:  $\sigma = 0$  mho/m,  $\epsilon_r = 1$ ;  $\rho = 0$  kg/m<sup>3</sup>

DASY4 Configuration:

- Probe: H3DV6 - SN6078; ; Calibrated: 5/11/2010
- Sensor-Surface: 0mm (Fix Surface)Sensor-Surface: (Fix Surface)
- Electronics: DAE4 Sn650; Calibrated: 5/20/2010
- Phantom: R-3, HAC Test Arch (rev.2); Type: SD HAC P01 BA; Serial: 1071;
- Measurement SW: DASY4, V4.7 Build 80; Postprocessing SW: SEMCAD, V1.8 Build 186

### H Scan - Probe center 10mm above Dipole/Hearing Aid Compatibility Test (41x361x1):

Measurement grid: dx=5mm, dy=5mm; Probe Modulation Factor = 1.00

Device Reference Point: 0.000, 0.000, -6.30 mm; Reference Value = 0.435 A/m; Power Drift = 0.038 dB

**Maximum value of Total (interpolated) = 0.428 A/m**

Peak H-field in A/m

Grid 1 <b>0.365 M4</b>	Grid 2 <b>0.407 M4</b>	Grid 3 <b>0.398 M4</b>
Grid 4 <b>0.388 M4</b>	<b>Grid 5</b> <b>0.428 M4</b>	Grid 6 <b>0.417 M4</b>
Grid 7 <b>0.344 M4</b>	Grid 8 <b>0.379 M4</b>	Grid 9 <b>0.372 M4</b>

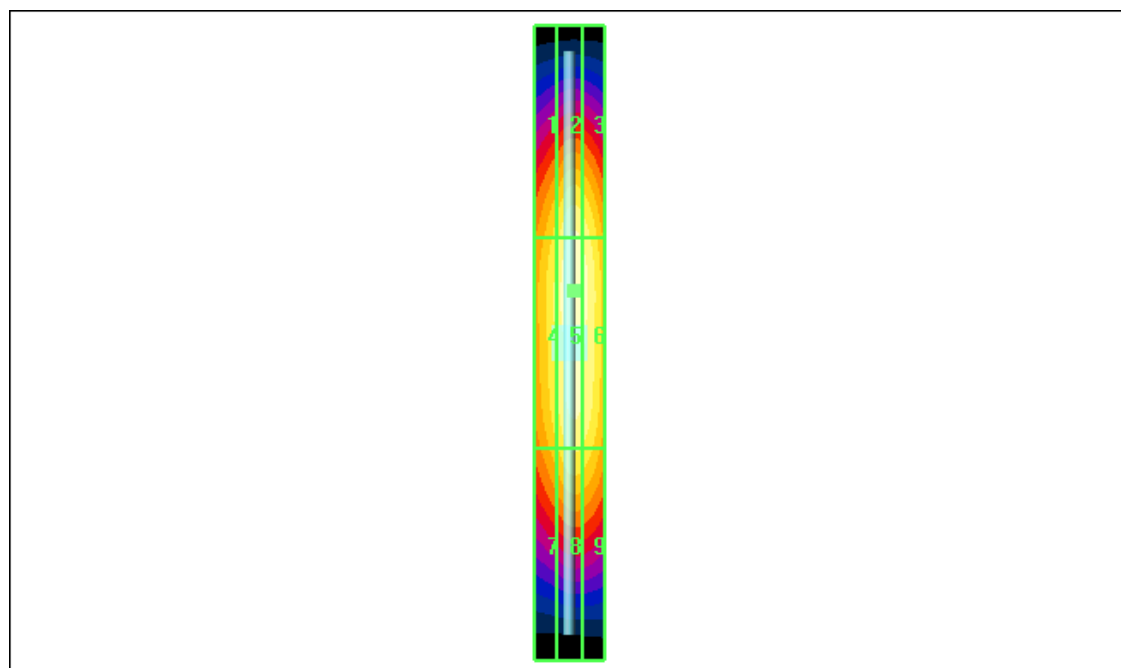
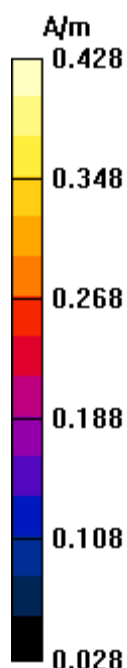

**Appendix 3**

**HAC distribution plots for E-Field and H-Field**

Date/Time: 2/4/2011 2:40:20 PM

## Test Laboratory: Motorola - iDEN 800 E-Field, 2:6 Vocoder

Serial: 364VLYK6TY; FCC ID: IHDT56MH1

Procedure Notes: Pwr Step: N/A; Antenna Position: Internal; Accessory Model #: N/A

Battery Model#: SNN5875A; Vocoder Rate: 2:6; Device Positioner: Polystyrene Block

Communication System: iDEN 800; Frequency: 824.98 MHz; Duty Cycle: 1:3

Medium: Air; Medium parameters used:  $\sigma = 0$  mho/m,  $\epsilon_r = 1$ ;  $\rho = 0$  kg/m<sup>3</sup>

DASY4 Configuration:

- Probe: ER3DV6R - SN2244; ConvF(1, 1, 1); Calibrated: 5/11/2010
- Sensor-Surface: (Fix Surface)
- Electronics: DAE4 Sn387; Calibrated: 5/19/2010
- Phantom: R-3, HAC Test Arch (rev.2); Type: SD HAC P01 BA; Serial: 1071;
- Measurement SW: DASY4, V4.7 Build 80; Postprocessing SW: SEMCAD, V1.8 Build 186

### E Scan - Sensor center 15mm above WD, Hearing Aid Compatibility Test (101x101x1):

Measurement grid: dx=5mm, dy=5mm

Maximum value of peak Total field = 277.0 V/m; Probe Modulation Factor = 3.53

Device Reference Point: 0.000, 0.000, -6.30 mm; Reference Value = 101.1 V/m; Power Drift = -0.042 dB

Hearing Aid Near-Field Category: **M3 (AWF 0 dB)**

Peak E-field in V/m

Grid 1 <b>246.7 M3</b>	Grid 2 <b>267.4 M3</b>	Grid 3 <b>257.8 M3</b>
Grid 4 <b>248.0 M3</b>	<b>Grid 5</b> <b>277.0 M3</b>	Grid 6 <b>272.6 M3</b>
Grid 7 <b>245.0 M3</b>	<b>Grid 8</b> <b>273.2 M3</b>	<b>Grid 9</b> <b>267.0 M3</b>

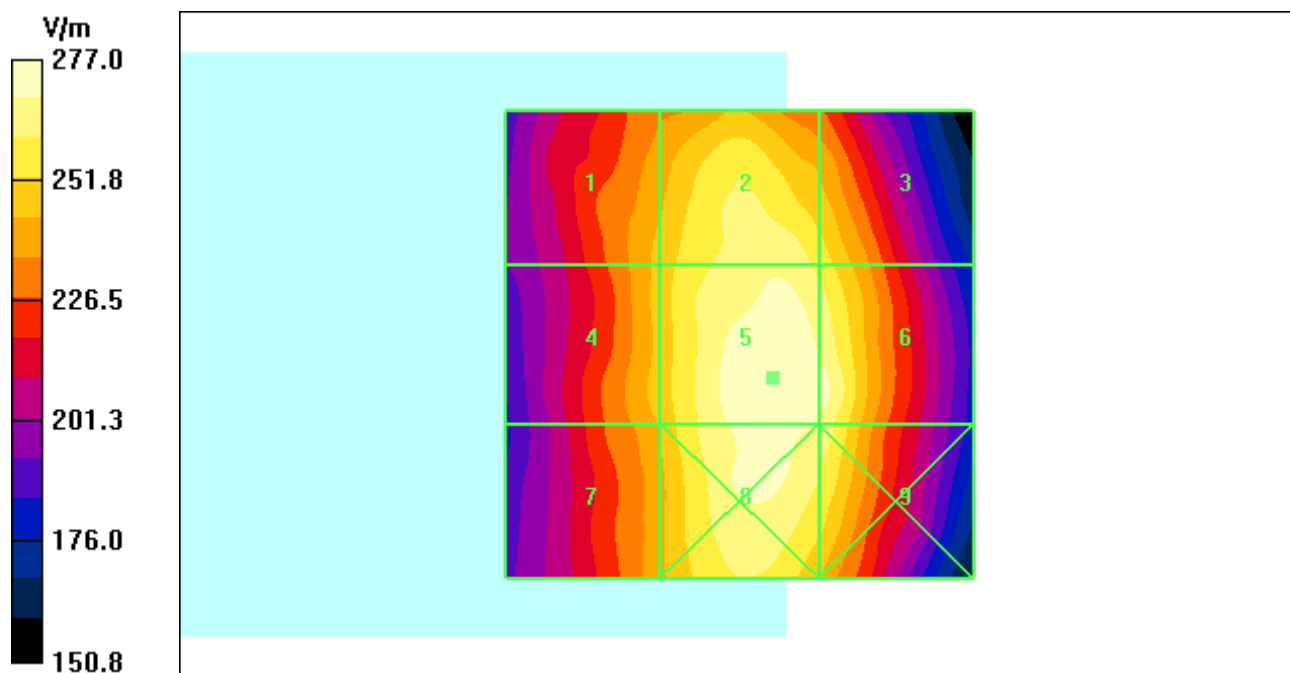

Date/Time: 2/4/2011 9:16:20 AM

## Test Laboratory: Motorola - iDEN 900 E-Field, 2:6 Vocoder

Serial: 364VLYK6TY; FCC ID: IHDT56MH1

Procedure Notes: Pwr Step: N/A; Antenna Position: Internal; Accessory Model #: N/A  
 Battery Model#: SNN5875A; Vocoder Rate: 2:6; Device Positioner: Polystyrene Block  
 Communication System: iDEN 900; Frequency: 901.98 MHz; Duty Cycle: 1:3  
 Medium: Air; Medium parameters used:  $\sigma = 0$  mho/m,  $\epsilon_r = 1$ ;  $\rho = 0$  kg/m<sup>3</sup>

DASY4 Configuration:

- Probe: ER3DV6R - SN2244; ConvF(1, 1, 1); Calibrated: 5/11/2010
- Sensor-Surface: (Fix Surface)
- Electronics: DAE4 Sn387; Calibrated: 5/19/2010
- Phantom: R-3, HAC Test Arch (rev.2); Type: SD HAC P01 BA; Serial: 1071;
- Measurement SW: DASY4, V4.7 Build 80; Postprocessing SW: SEMCAD, V1.8 Build 186

### E Scan - Sensor center 15mm above WD, Hearing Aid Compatibility Test (101x101x1):

Measurement grid: dx=5mm, dy=5mm

Maximum value of peak Total field = 254.5 V/m; Probe Modulation Factor = 3.40

Device Reference Point: 0.000, 0.000, -6.30 mm; Reference Value = 96.9 V/m; Power Drift = -0.171 dB

**Hearing Aid Near-Field Category: M3 (AWF 0 dB)**

Peak E-field in V/m

Grid 1 <b>226.7 M3</b>	Grid 2 <b>249.2 M3</b>	Grid 3 <b>235.6 M3</b>
Grid 4 <b>231.2 M3</b>	<b>Grid 5</b> <b>254.5 M3</b>	Grid 6 <b>242.1 M3</b>
Grid 7 <b>225.2 M3</b>	<b>Grid 8</b> <b>252.8 M3</b>	<b>Grid 9</b> <b>238.1 M3</b>

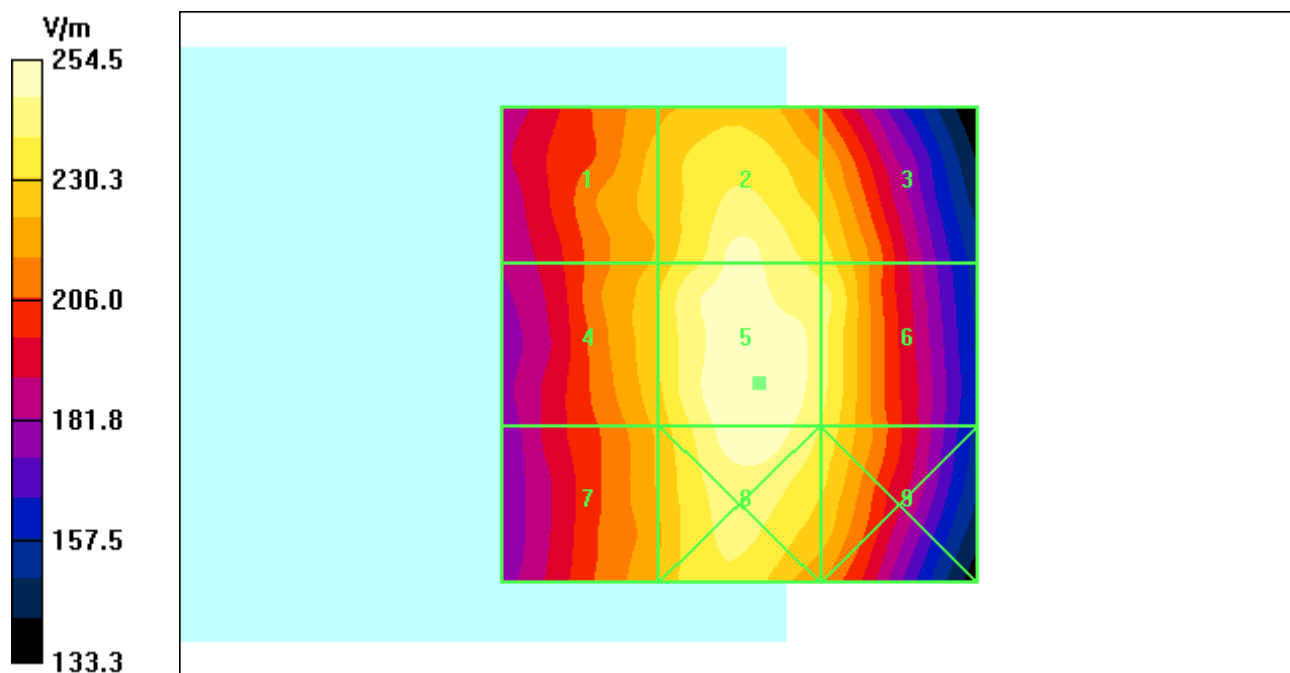

Date/Time: 2/4/2011 3:15:59 PM

## Test Laboratory: Motorola - iDEN 800 E-Field, 1:6 Vocoder

Serial: 364VLYK6TY; FCC ID: IHDT56MH1

Procedure Notes: Pwr Step: N/A; Antenna Position: Internal; Accessory Model #: N/A

Battery Model#: SNN5875A; Vocoder Rate: 1:6; Device Positioner: Polystyrene Block

Communication System: iDEN 800; Frequency: 824.98 MHz; Duty Cycle: 1:6

Medium: Air; Medium parameters used:  $\sigma = 0$  mho/m,  $\epsilon_r = 1$ ;  $\rho = 0$  kg/m<sup>3</sup>

DASY4 Configuration:

- Probe: ER3DV6R - SN2244; ConvF(1, 1, 1); Calibrated: 5/11/2010
- Sensor-Surface: (Fix Surface)
- Electronics: DAE4 Sn387; Calibrated: 5/19/2010
- Phantom: R-3, HAC Test Arch (rev.2); Type: SD HAC P01 BA; Serial: 1071;
- Measurement SW: DASY4, V4.7 Build 80; Postprocessing SW: SEMCAD, V1.8 Build 186

### E Scan - Sensor center 15mm above WD, Hearing Aid Compatibility Test (101x101x1):

Measurement grid: dx=5mm, dy=5mm

Maximum value of peak Total field = 278.2 V/m; Probe Modulation Factor = 5.03

Device Reference Point: 0.000, 0.000, -6.30 mm; Reference Value = 69.9 V/m; Power Drift = -0.023 dB

**Hearing Aid Near-Field Category: M3 (AWF 0 dB)**

Peak E-field in V/m

Grid 1 <b>245.2 M3</b>	Grid 2 <b>273.4 M3</b>	Grid 3 <b>264.8 M3</b>
Grid 4 <b>255.6 M3</b>	Grid 5 <b>278.2 M3</b>	Grid 6 <b>269.0 M3</b>
Grid 7 <b>248.6 M3</b>	Grid 8 <b>271.3 M3</b>	Grid 9 <b>261.4 M3</b>

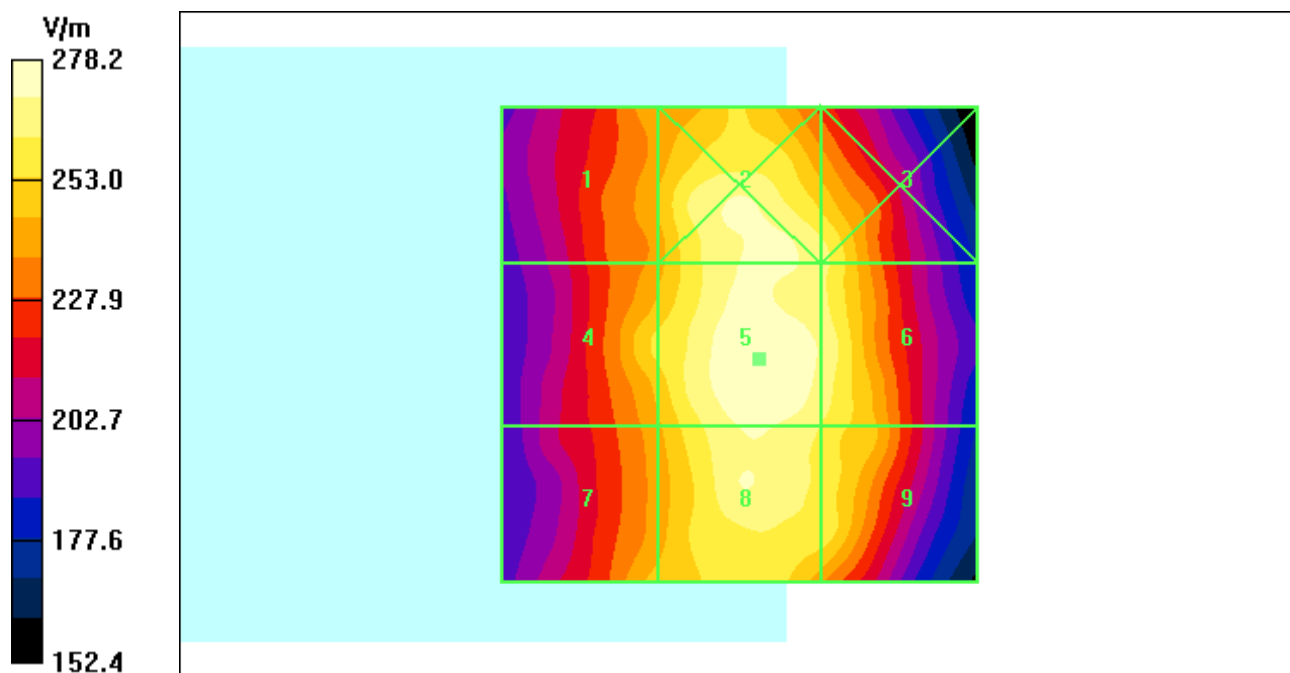

Date/Time: 2/4/2011 9:42:17 AM

## Test Laboratory: Motorola - iDEN 900 E-Field, 1:6 Vocoder

Serial: 364VLYK6TY; FCC ID: IHDT56MH1

Procedure Notes: Pwr Step: N/A; Antenna Position: Internal; Accessory Model #: N/A  
 Battery Model#: SNN5875A; Vocoder Rate: 1:6; Device Positioner: Polystyrene Block  
 Communication System: iDEN 900; Frequency: 901.98 MHz; Duty Cycle: 1:6  
 Medium: Air; Medium parameters used:  $\sigma = 0$  mho/m,  $\epsilon_r = 1$ ;  $\rho = 0$  kg/m<sup>3</sup>

DASY4 Configuration:

- Probe: ER3DV6R - SN2244; ConvF(1, 1, 1); Calibrated: 5/11/2010
- Sensor-Surface: (Fix Surface)
- Electronics: DAE4 Sn387; Calibrated: 5/19/2010
- Phantom: R-3, HAC Test Arch (rev.2); Type: SD HAC P01 BA; Serial: 1071;
- Measurement SW: DASY4, V4.7 Build 80; Postprocessing SW: SEMCAD, V1.8 Build 186

### E Scan - Sensor center 15mm above WD, Hearing Aid Compatibility Test (101x101x1):

Measurement grid: dx=5mm, dy=5mm

Maximum value of peak Total field = 258.4 V/m; Probe Modulation Factor = 4.85

Device Reference Point: 0.000, 0.000, -6.30 mm; Reference Value = 67.2 V/m; Power Drift = -0.007 dB

Hearing Aid Near-Field Category: **M3 (AWF 0 dB)**

Peak E-field in V/m

Grid 1 <b>236.7 M3</b>	Grid 2 <b>250.5 M3</b>	Grid 3 <b>241.8 M3</b>
Grid 4 <b>235.8 M3</b>	Grid 5 <b>258.4 M3</b>	Grid 6 <b>248.7 M3</b>
Grid 7 <b>231.6 M3</b>	Grid 8 <b>255.6 M3</b>	Grid 9 <b>246.5 M3</b>

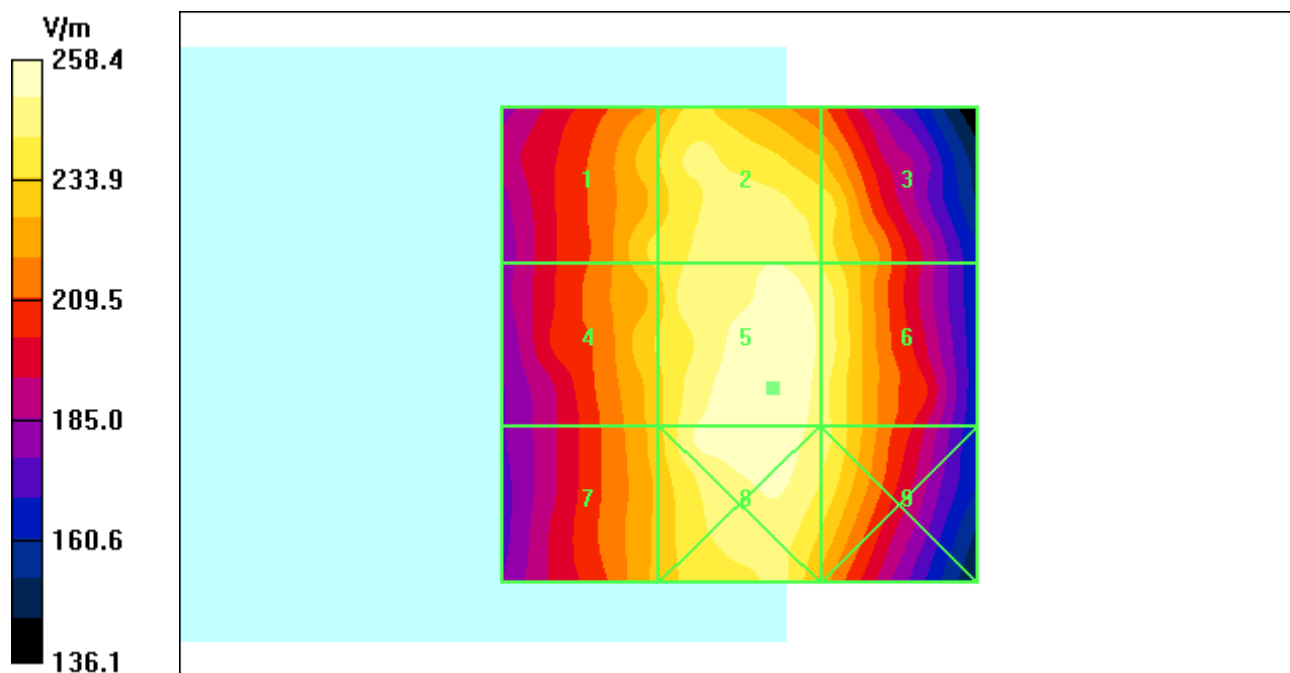

Date/Time: 2/4/2011 12:28:16 PM

## Test Laboratory: Motorola - iDEN 800 H-Field, 2:6 Vocoder

Serial: 364VLYK6TY; FCC ID: IHDT56MH1

Procedure Notes: Pwr Step: N/A; Antenna Position: Internal; Accessory Model #: N/A  
 Battery Model#: SNN5875A; Vocoder Rate: 2:6; Device Positioner: Polystyrene Block  
 Communication System: iDEN 800; Frequency: 824.98 MHz; Duty Cycle: 1:3  
 Medium: Air; Medium parameters used:  $\sigma = 0$  mho/m,  $\epsilon_r = 1$ ;  $\rho = 0$  kg/m<sup>3</sup>

DASY4 Configuration:

- Probe: H3DV6 - SN6078; ; Calibrated: 5/11/2010
- Sensor-Surface: (Fix Surface)
- Electronics: DAE4 Sn650; Calibrated: 5/20/2010
- Phantom: R-3, HAC Test Arch (rev.2); Type: SD HAC P01 BA; Serial: 1071;
- Measurement SW: DASY4, V4.7 Build 80; Postprocessing SW: SEMCAD, V1.8 Build 186

### H Scan - Sensor center 15mm above WD, Hearing Aid Compatibility Test (101x101x1):

Measurement grid: dx=5mm, dy=5mm

Maximum value of peak Total field = 0.323 A/m; Probe Modulation Factor = 3.08

Device Reference Point: 0.000, 0.000, -6.30 mm; Reference Value = 0.073 A/m; Power Drift = -0.073 dB

**Hearing Aid Near-Field Category: M4 (AWF 0 dB)**

Peak H-field in A/m

Grid 1 <b>0.460 M4</b>	Grid 2 <b>0.318 M4</b>	Grid 3 <b>0.187 M4</b>
Grid 4 <b>0.439 M4</b>	Grid 5 <b>0.296 M4</b>	Grid 6 <b>0.166 M4</b>
Grid 7 <b>0.469 M4</b>	Grid 8 <b>0.323 M4</b>	Grid 9 <b>0.188 M4</b>

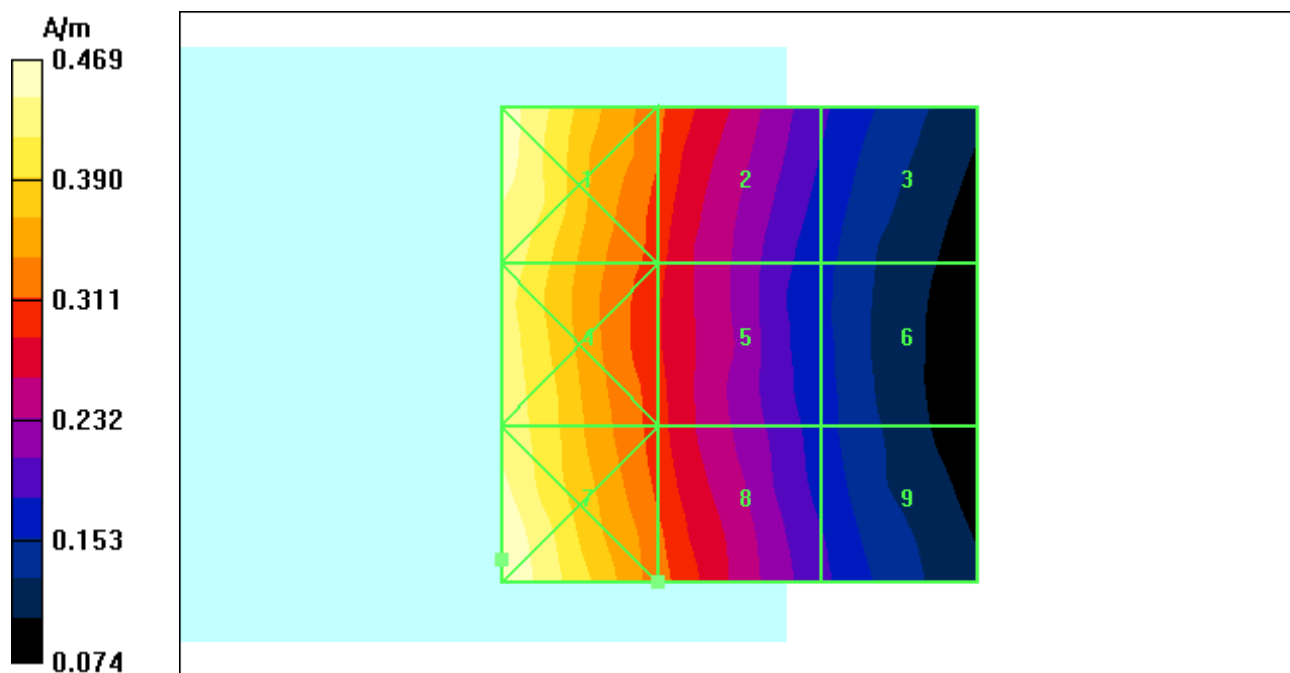

Date/Time: 2/4/2011 10:31:42 AM

## Test Laboratory: Motorola - iDEN 900 H-Field, 2:6 Vocoder

Serial: 364VLYK6TY; FCC ID: IHDT56MH1

Procedure Notes: Pwr Step: N/A; Antenna Position: Internal; Accessory Model #: N/A  
 Battery Model#: SNN5875A; Vocoder Rate: 2:6; Device Positioner: Polystyrene Block  
 Communication System: iDEN 900; Frequency: 896.02 MHz; Duty Cycle: 1:3  
 Medium: Air; Medium parameters used:  $\sigma = 0$  mho/m,  $\epsilon_r = 1$ ;  $\rho = 0$  kg/m<sup>3</sup>

DASY4 Configuration:

- Probe: H3DV6 - SN6078; ; Calibrated: 5/11/2010
- Sensor-Surface: (Fix Surface)
- Electronics: DAE4 Sn650; Calibrated: 5/20/2010
- Phantom: R-3, HAC Test Arch (rev.2); Type: SD HAC P01 BA; Serial: 1071;
- Measurement SW: DASY4, V4.7 Build 80; Postprocessing SW: SEMCAD, V1.8 Build 186

### H Scan - Sensor center 15mm above WD, Hearing Aid Compatibility Test (101x101x1):

Measurement grid: dx=5mm, dy=5mm

Maximum value of peak Total field = 0.327 A/m; Probe Modulation Factor = 3.02

Device Reference Point: 0.000, 0.000, -6.30 mm; Reference Value = 0.076 A/m; Power Drift = -0.113 dB

**Hearing Aid Near-Field Category: M4 (AWF 0 dB)**

Peak H-field in A/m

Grid 1 <b>0.471 M4</b>	Grid 2 <b>0.327 M4</b>	Grid 3 <b>0.189 M4</b>
Grid 4 <b>0.450 M4</b>	Grid 5 <b>0.303 M4</b>	Grid 6 <b>0.172 M4</b>
Grid 7 <b>0.462 M4</b>	Grid 8 <b>0.317 M4</b>	Grid 9 <b>0.178 M4</b>

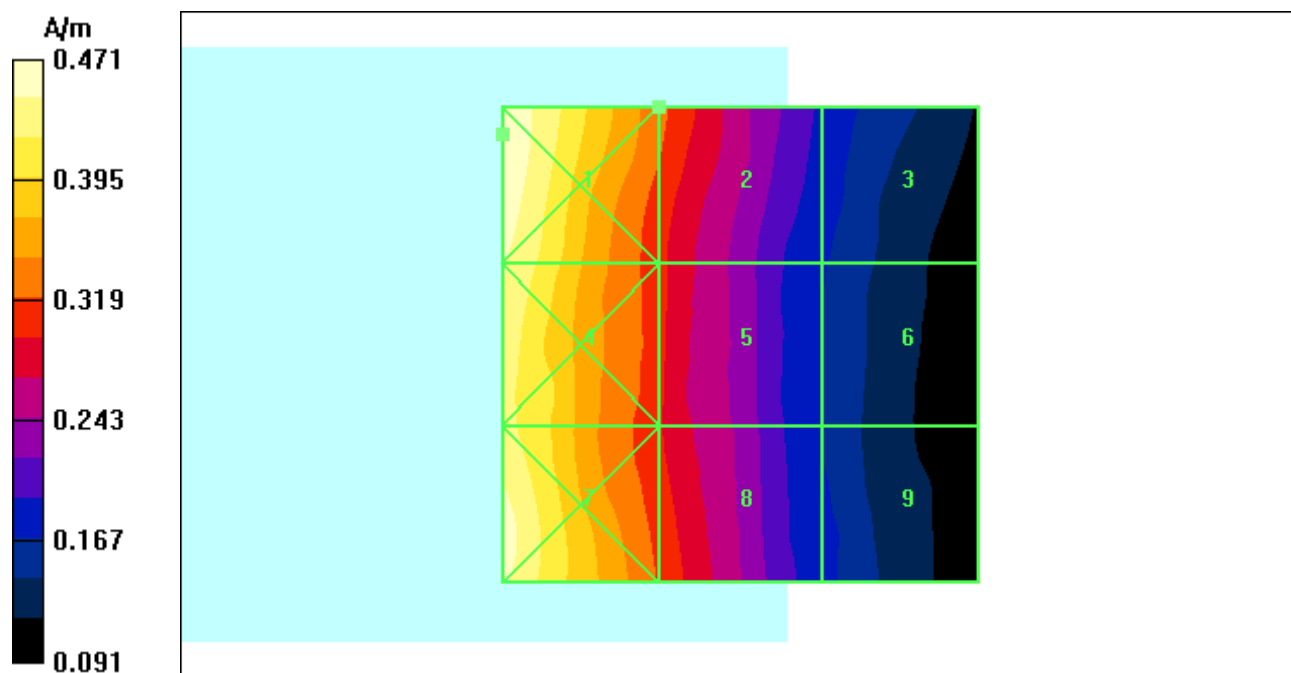

Date/Time: 2/4/2011 12:47:40 PM

## Test Laboratory: Motorola - iDEN 800 H-Field, 1:6 Vocoder

Serial: 364VLYK6TY; FCC ID: IHDT56MH1

Procedure Notes: Pwr Step: N/A; Antenna Position: Internal; Accessory Model #: N/A  
 Battery Model#: SNN5875A; Vocoder Rate: 1:6; Device Positioner: Polystyrene Block  
 Communication System: iDEN 800; Frequency: 806.01 MHz; Duty Cycle: 1:6  
 Medium: Air; Medium parameters used:  $\sigma = 0$  mho/m,  $\epsilon_r = 1$ ;  $\rho = 0$  kg/m<sup>3</sup>

DASY4 Configuration:

- Probe: H3DV6 - SN6078; ; Calibrated: 5/11/2010
- Sensor-Surface: (Fix Surface)
- Electronics: DAE4 Sn650; Calibrated: 5/20/2010
- Phantom: R-3, HAC Test Arch (rev.2); Type: SD HAC P01 BA; Serial: 1071;
- Measurement SW: DASY4, V4.7 Build 80; Postprocessing SW: SEMCAD, V1.8 Build 186

### H Scan - Sensor center 15mm above WD, Hearing Aid Compatibility Test (101x101x1):

Measurement grid: dx=5mm, dy=5mm

Maximum value of peak Total field = 0.327 A/m; Probe Modulation Factor = 4.35

Device Reference Point: 0.000, 0.000, -6.30 mm; Reference Value = 0.052 A/m; Power Drift = -0.153 dB

**Hearing Aid Near-Field Category: M4 (AWF 0 dB)**

Peak H-field in A/m

Grid 1 <b>0.477 M4</b>	Grid 2 <b>0.315 M4</b>	Grid 3 <b>0.189 M4</b>
Grid 4 <b>0.453 M4</b>	Grid 5 <b>0.303 M4</b>	Grid 6 <b>0.169 M4</b>
Grid 7 <b>0.477 M4</b>	Grid 8 <b>0.327 M4</b>	Grid 9 <b>0.192 M4</b>

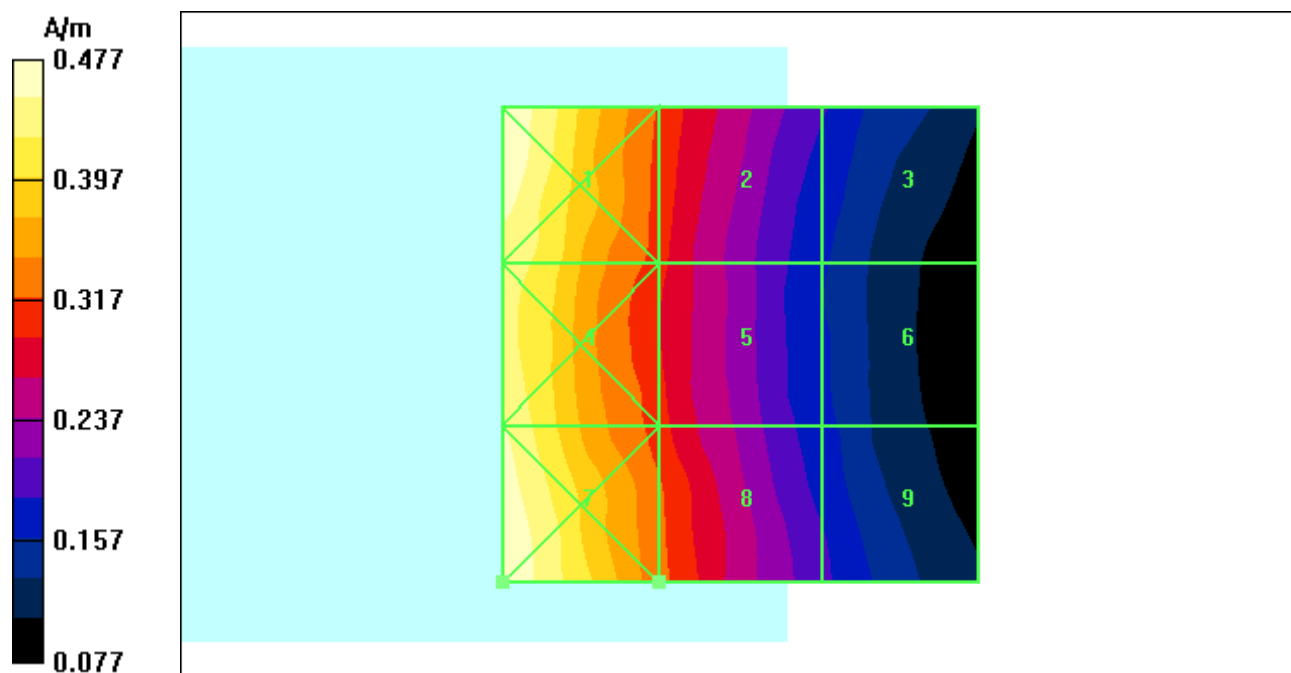

Date/Time: 2/4/2011 10:11:30 AM

## Test Laboratory: Motorola - iDEN 900 H-Field, 1:6 Vocoder

Serial: 364VLYK6TY; FCC ID: IHDT56MH1

Procedure Notes: Pwr Step: N/A; Antenna Position: Internal; Accessory Model #: N/A  
 Battery Model#: SNN5875A; Vocoder Rate: 1:6; Device Positioner: Polystyrene Block  
 Communication System: iDEN 900; Frequency: 901.98 MHz; Duty Cycle: 1:6  
 Medium: Air; Medium parameters used:  $\sigma = 0$  mho/m,  $\epsilon_r = 1$ ;  $\rho = 0$  kg/m<sup>3</sup>

DASY4 Configuration:

- Probe: H3DV6 - SN6078; ; Calibrated: 5/11/2010
- Sensor-Surface: (Fix Surface)
- Electronics: DAE4 Sn650; Calibrated: 5/20/2010
- Phantom: R-3, HAC Test Arch (rev.2); Type: SD HAC P01 BA; Serial: 1071;
- Measurement SW: DASY4, V4.7 Build 80; Postprocessing SW: SEMCAD, V1.8 Build 186

### H Scan - Sensor center 15mm above WD, Hearing Aid Compatibility Test (101x101x1):

Measurement grid: dx=5mm, dy=5mm

Maximum value of peak Total field = 0.341 A/m; Probe Modulation Factor = 4.30

Device Reference Point: 0.000, 0.000, -6.30 mm; Reference Value = 0.057 A/m; Power Drift = 0.086 dB

**Hearing Aid Near-Field Category: M4 (AWF 0 dB)**

Peak H-field in A/m

Grid 1 <b>0.521 M4</b>	Grid 2 <b>0.341 M4</b>	Grid 3 <b>0.204 M4</b>
Grid 4 <b>0.470 M4</b>	Grid 5 <b>0.322 M4</b>	Grid 6 <b>0.178 M4</b>
Grid 7 <b>0.482 M4</b>	Grid 8 <b>0.335 M4</b>	Grid 9 <b>0.190 M4</b>

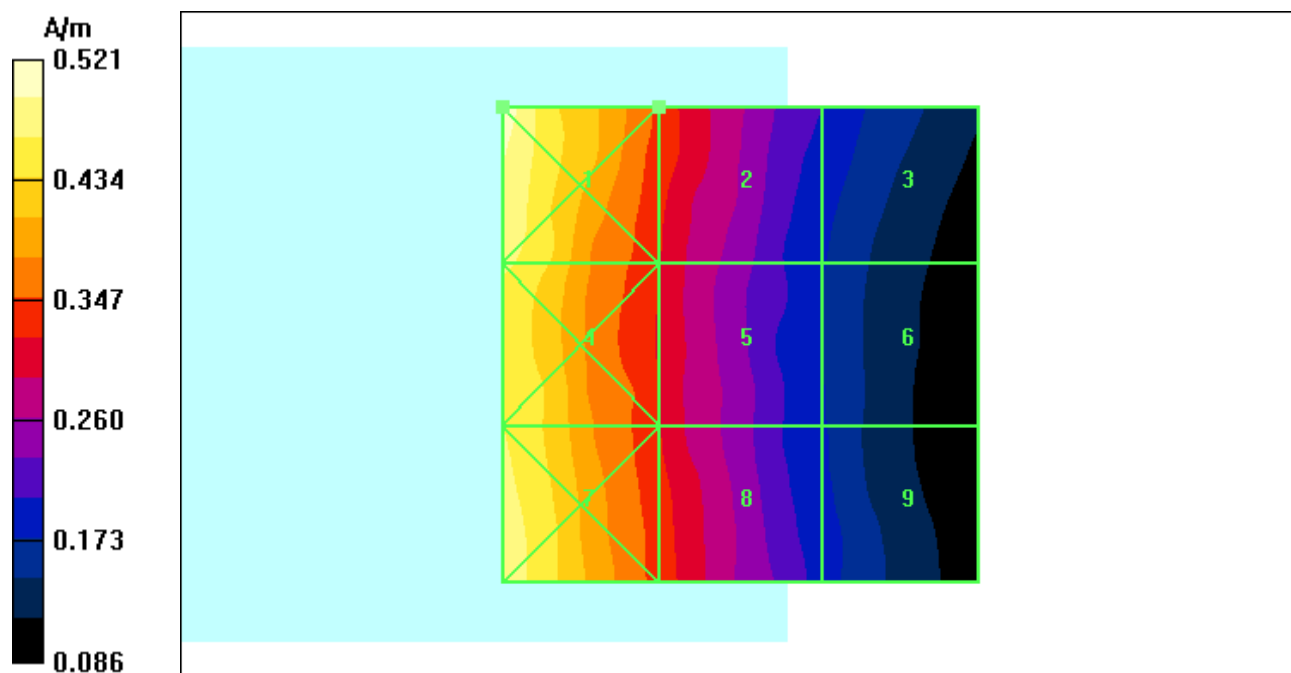

**Appendix 4**

**Measurement Uncertainty Budget**

**A4.1 Motorola Uncertainty Budget for RF HAC Testing**

**TABLE A4.1: Motorola Uncertainty Budget**

UNCERTAINTY DESCRIPTION	Uncertainty Value (± %)	Prob. Dist.	Div.	(ci) E	(ci) H	Std. Unc. E	Std. Unc. H
<b>MEASUREMENT SYSTEM</b>							
Probe Calibration	5.1%	N	1.0000	1	1	5.1%	5.1%
Axial Isotropy	7.8%	R	1.7321	1	0.786	4.5%	3.5%
Sensor Displacement	16.5%	R	1.7321	1	0.145	9.5%	1.4%
Test Arch	7.2%	R	1.7321	1	0	4.2%	0.0%
Linearity	4.7%	R	1.7321	1	1	2.7%	2.7%
Scaling to Peak Envelope Power	2.0%	R	1.7321	1	1	1.2%	1.2%
System Detection Limit	1.0%	R	1.7321	1	1	0.6%	0.6%
Readout Electronics	0.3%	N	1.0000	1	1	0.3%	0.3%
Response Time	0.8%	R	1.7321	1	1	0.5%	0.5%
Integration Time	2.6%	R	1.7321	1	1	1.5%	1.5%
RF Reflections	5.6%	R	1.7321	1	1	3.2%	3.2%
Probe Positioner	1.2%	R	1.7321	1	0.67	0.7%	0.5%
Probe Positioning	4.7%	R	1.7321	1	0.67	2.7%	1.8%
Extrap. & Interpolation	1.0%	R	1.7321	1	1	0.6%	0.6%
<b>TEST SAMPLE RELATED</b>							
Total Device Positioning	3.2%	R	1.7321	1	1.306	1.8%	2.4%
Device Holder & Phantom	2.4%	R	1.7321	1	1	1.4%	1.4%
Power Drift	5.0%	R	1.7321	1	1	2.9%	2.9%
<b>PHANTOM AND SETUP RELATED</b>							
Phantom Thickness	2.4%	R	1.7321	1	0.67	1.4%	0.9%
<b>Combined Std.Uncertainty on Power</b>						14.1%	9.1%
<b>Combined Std.Uncertainty on Field</b>						7.1%	4.6%
<b>Expanded Std. Uncertainty on Power</b>						28.3%	18.2%
<b>Expanded Std. Uncertainty on Field</b>						14.1%	9.1%

**A4.2 Probe Rotation Contributions to Isotropy Error**

Probe rotation data was taken “for special focus on spherical isotropicity in measurement uncertainty and perturbation of EM fields.” This data was taken at the interpolated maximum and directly accounted for in the uncertainty budget as “Axial Isotropy.” Thirteen mobile devices were used to determine the probe isotropy uncertainty factors in section A4.1. Based on the resulting 82 E-Field probe rotations and 82 H-Field probe rotations, the upper 95% confidence interval value was calculated for each. These values represent a conservative assessment of the effect of the probe isotropy and have been appropriately included in the respective E- and H-uncertainty budgets.

**TABLE A4.2: Probe Rotation Data Summary**

	AVE	ST. DEV	Sample Size (n)	2σ	(ci)	Standard Uncertainty
E-field	4.4%	1.7%	82	7.8%	1	4.5%
H-field	3.8%	1.2%	82	6.1%	0.786	3.5%

Isotropy error measurements were taken for 13 products across the respective frequency bands. The +2σ values of all measurements was used as a worst case value for the uncertainty budget. Any significant differences between bands were also evaluated.

**Appendix 5**

**Pictures of Test Setup**

See Exhibit 7B

**Appendix 6**  
**Probe Calibration Certificates**



Accredited by the Swiss Accreditation Service (SAS)  
The Swiss Accreditation Service is one of the signatories to the EA  
Multilateral Agreement for the recognition of calibration certificates

Accreditation No.: **SCS 108**

Client **Motorola MDb**

Certificate No: **ER3-2244\_May10**

**CALIBRATION CERTIFICATE**

Object **ER3DV6R - SN:2244**

Calibration procedure(s) **QA CAL-02.v5 and QA CAL-25.v2  
Calibration procedure for E-field probes optimized for close near field  
evaluations in air**

Calibration date: **May 11, 2010**

This calibration certificate documents the traceability to national standards, which realize the physical units of measurements (SI).  
The measurements and the uncertainties with confidence probability are given on the following pages and are part of the certificate.

All calibrations have been conducted in the closed laboratory facility: environment temperature (22 ± 3)°C and humidity < 70%.

Calibration Equipment used (M&TE critical for calibration)

Primary Standards	ID #	Cal Date (Certificate No.)	Scheduled Calibration
Power meter E4419B	GB41293874	1-Apr-10 (No. 217-01136)	Apr-11
Power sensor E4412A	MY41495277	1-Apr-10 (No. 217-01136)	Apr-11
Power sensor E4412A	MY41498087	1-Apr-10 (No. 217-01136)	Apr-11
Reference 3 dB Attenuator	SN: S5054 (3c)	30-Mar-10 (No. 217-01159)	Mar-11
Reference 20 dB Attenuator	SN: S5086 (20b)	30-Mar-10 (No. 217-01161)	Mar-11
Reference 30 dB Attenuator	SN: S5129 (30b)	30-Mar-10 (No. 217-01160)	Mar-11
Reference Probe ER3DV6	SN: 2328	3-Oct-09 (No. ER3-2328_Oct09)	Oct-10
DAE4	SN: 789	23-Dec-09 (No. DAE4-789_Dec09)	Dec-10

Secondary Standards	ID #	Check Date (in house)	Scheduled Check
RF generator HP 8648C	US3642U01700	4-Aug-99 (in house check Oct-09)	In house check: Oct-11
Network Analyzer HP 8753E	US37390585	18-Oct-01 (in house check Oct-09)	In house check: Oct10

Calibrated by:	<b>Claudio Leubler</b>	<b>Laboratory Technician</b>	
Approved by:	<b>Katja Pokovic</b>	<b>Technical Manager</b>	

Issued: May 12, 2010

This calibration certificate shall not be reproduced except in full without written approval of the laboratory.



Accredited by the Swiss Accreditation Service (SAS)

Accreditation No.: **SCS 108**

The Swiss Accreditation Service is one of the signatories to the EA  
Multilateral Agreement for the recognition of calibration certificates

### Glossary:

NORM <sub>x,y,z</sub>	sensitivity in free space
DCP	diode compression point
CF	crest factor (1/duty_cycle) of the RF signal
A, B, C	modulation dependent linearization parameters
Polarization $\varphi$	$\varphi$ rotation around probe axis
Polarization $\vartheta$	$\vartheta$ rotation around an axis that is in the plane normal to probe axis (at measurement center), i.e., $\vartheta = 0$ is normal to probe axis
Connector Angle	information used in DASY system to align probe sensor X to the robot coordinate system

### Calibration is Performed According to the Following Standards:

- IEEE Std 1309-2005, "IEEE Standard for calibration of electromagnetic field sensors and probes, excluding antennas, from 9 kHz to 40 GHz", December 2005.

### Methods Applied and Interpretation of Parameters:

- NORM<sub>x,y,z</sub>*: Assessed for E-field polarization  $\vartheta = 0$  for XY sensors and  $\vartheta = 90$  for Z sensor ( $f \leq 900$  MHz in TEM-cell;  $f > 1800$  MHz: R22 waveguide).
- NORM(f)<sub>x,y,z</sub>* = *NORM<sub>x,y,z</sub>* \* *frequency\_response* (see Frequency Response Chart).
- DCP<sub>x,y,z</sub>*: DCP are numerical linearization parameters assessed based on the data of power sweep with CW signal (no uncertainty required). DCP does not depend on frequency nor media.
- A<sub>x,y,z</sub>; B<sub>x,y,z</sub>; C<sub>x,y,z</sub>; VR<sub>x,y,z</sub>*: A, B, C are numerical linearization parameters assessed based on the data of power sweep for specific modulation signal. The parameters do not depend on frequency nor media. VR is the maximum calibration range expressed in RMS voltage across the diode.
- Spherical isotropy (3D deviation from isotropy)*: in a locally homogeneous field realized using an open waveguide setup.
- Sensor Offset*: The sensor offset corresponds to the offset of virtual measurement center from the probe tip (on probe axis). No tolerance required.
- Connector Angle*: The angle is assessed using the information gained by determining the *NORM<sub>x</sub>* (no uncertainty required).

# Probe ER3DV6R

## SN:2244

Manufactured:	February 1, 2000
Last calibrated:	September 22, 2008
Recalibrated:	May 11, 2010

Calibrated for DASY/EASY Systems

(Note: non-compatible with DASY2 system!)

**DASY/EASY - Parameters of Probe: ER3DV6R SN:2244****Basic Calibration Parameters**

	Sensor X	Sensor Y	Sensor Z	Unc (k=2)
Norm ( $\mu\text{V}/(\text{V}/\text{m})^2$ )	1.86	1.86	2.08	$\pm 10.1\%$
DCP (mV) <sup>A</sup>	94.2	94.4	96.2	

**Modulation Calibration Parameters**

UID	Communication System Name	PAR		A dB	B dBuV	C	VR mV	Unc <sup>E</sup> (k=2)
10000	CW	0.00	X	0.00	0.00	1.00	300	$\pm 1.5\%$
			Y	0.00	0.00	1.00	300	
			Z	0.00	0.00	1.00	300	

The reported uncertainty of measurement is stated as the standard uncertainty of measurement multiplied by the coverage factor  $k=2$ , which for a normal distribution corresponds to a coverage probability of approximately 95%.

<sup>A</sup> numerical linearization parameter: uncertainty not required

<sup>E</sup> Uncertainty is determined using the maximum deviation from linear response applying rectangular distribution and is expressed for the square of the field value.

# Frequency Response of E-Field

(TEM-Cell:ifi110 EXX, Waveguide R22)

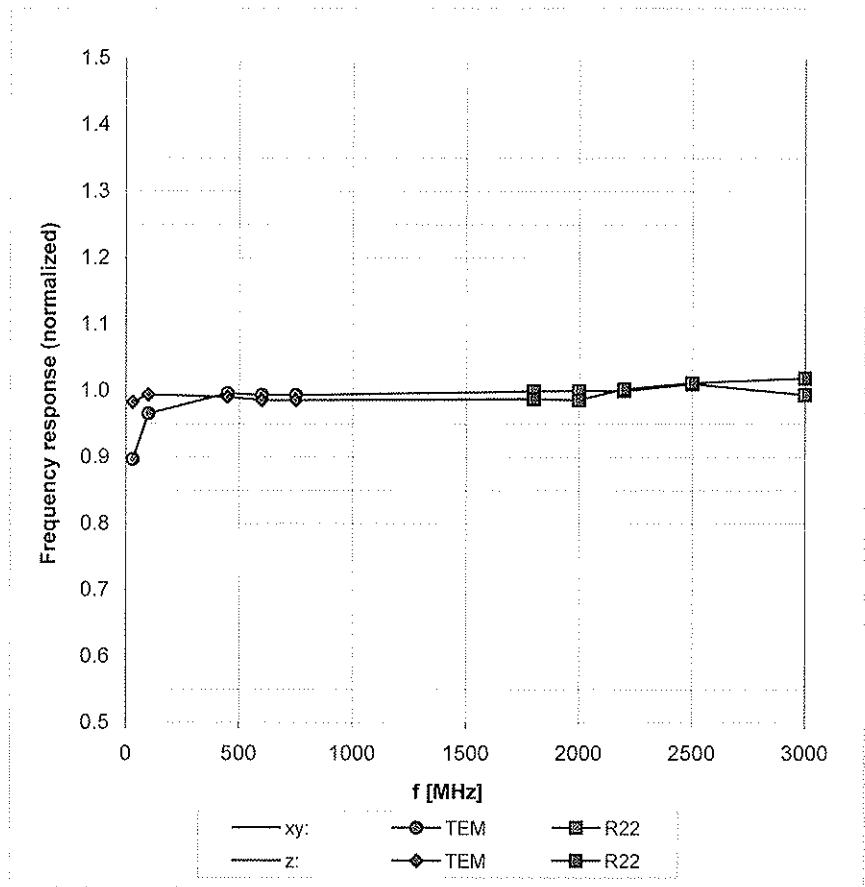

Uncertainty of Frequency Response of E-field:  $\pm 6.3\%$  (k=2)

### Receiving Pattern ( $\phi$ ), $\vartheta = 0^\circ$

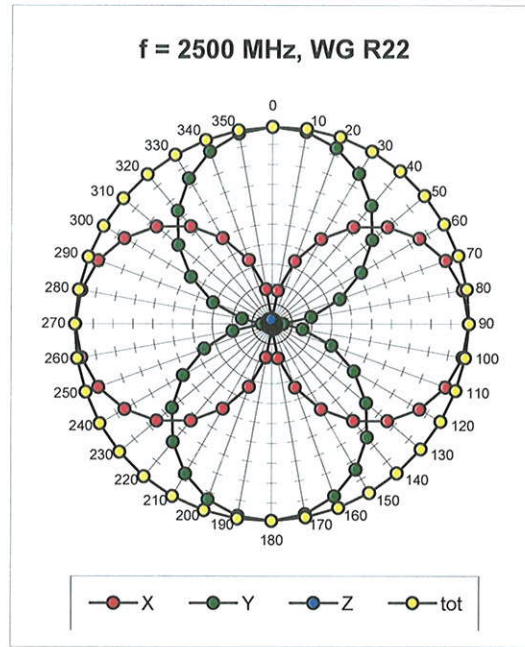
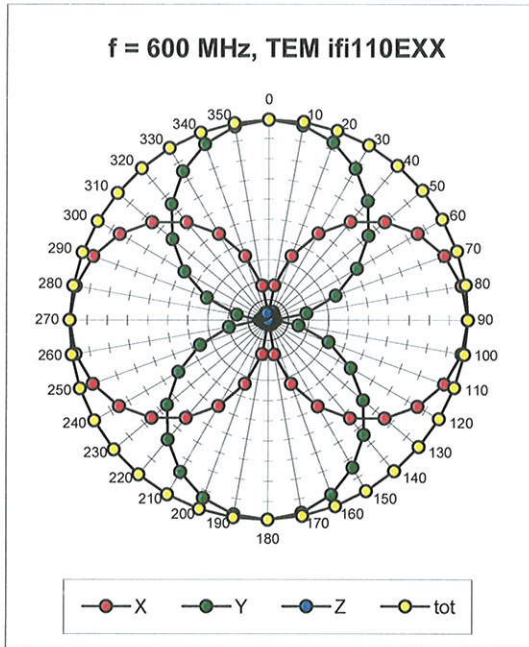

### Receiving Pattern ( $\phi$ ), $\vartheta = 90^\circ$

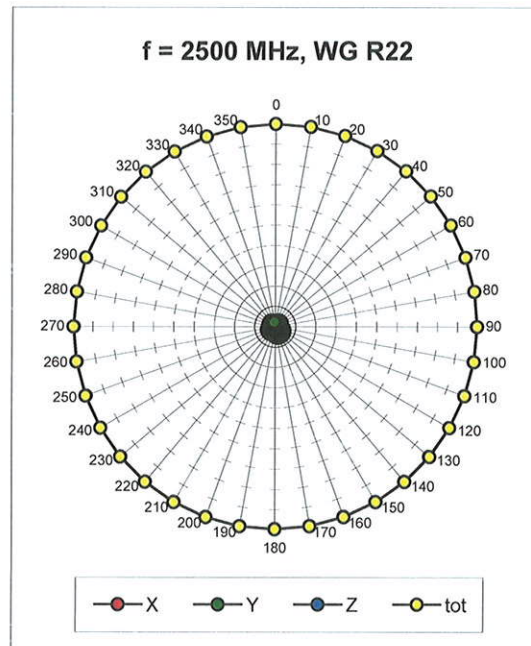
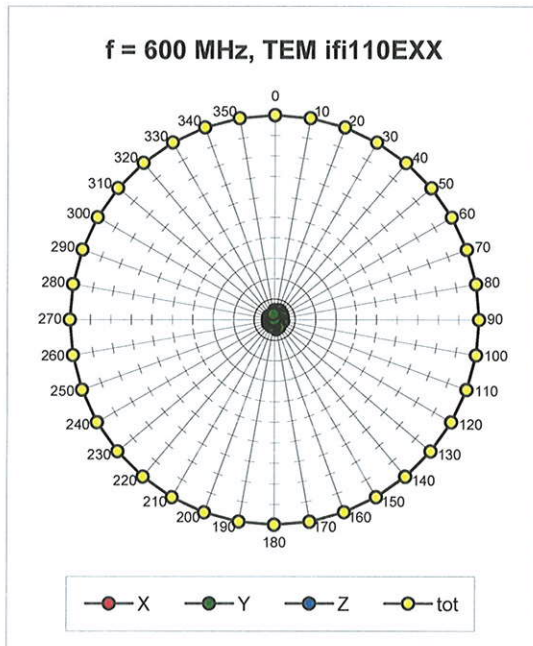

### Receiving Pattern ( $\phi$ ), $\vartheta = 0^\circ$

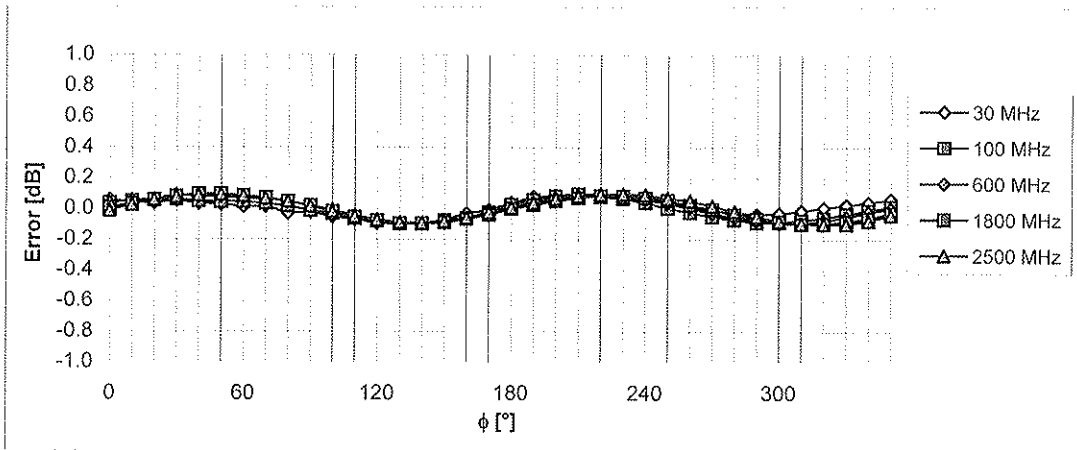

Uncertainty of Axial Isotropy Assessment:  $\pm 0.5\%$  ( $k=2$ )

### Receiving Pattern ( $\phi$ ), $\vartheta = 90^\circ$

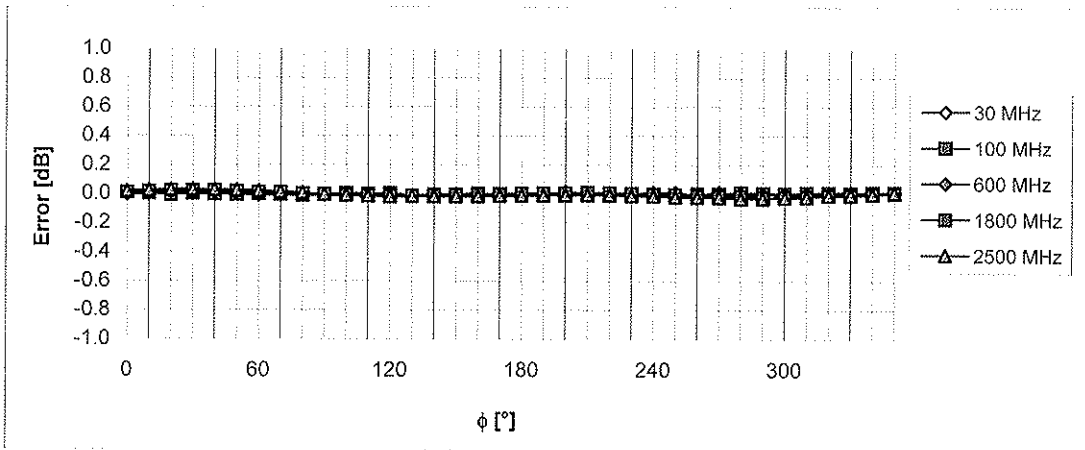

Uncertainty of Axial Isotropy Assessment:  $\pm 0.5\%$  ( $k=2$ )

### Dynamic Range f(E-field) (Waveguide R22, f = 1800 MHz)

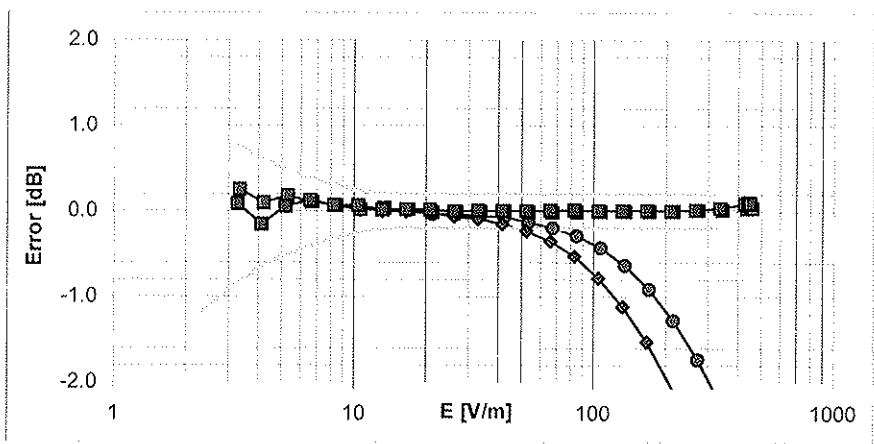
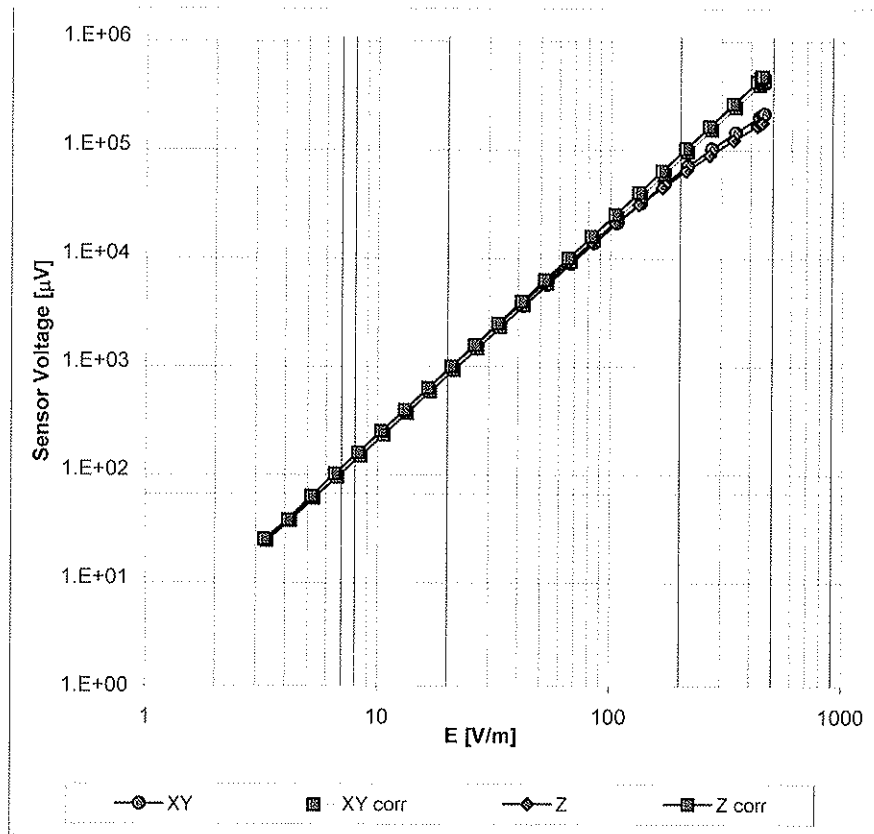

Uncertainty of Linearity Assessment:  $\pm 0.6\%$  ( $k=2$ )

### Deviation from Isotropy in Air Error ( $\phi, \vartheta$ ), $f = 900$ MHz

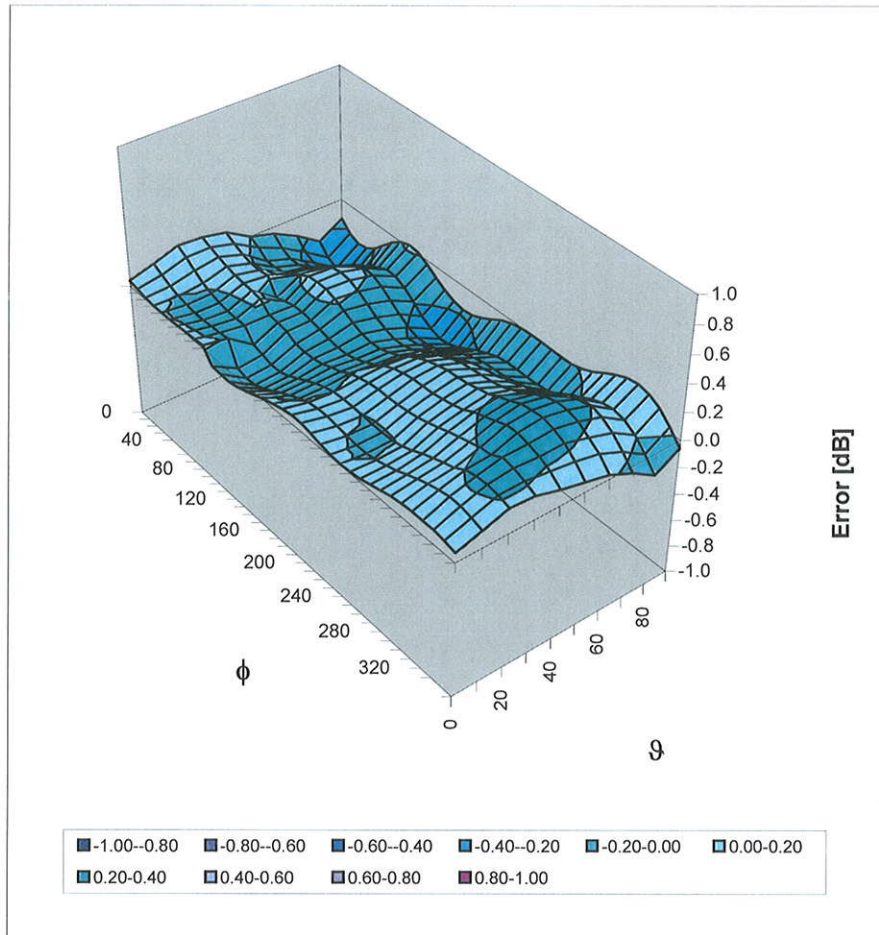

Uncertainty of Spherical Isotropy Assessment:  $\pm 2.6\%$  ( $k=2$ )

## Other Probe Parameters

Sensor Arrangement	Rectangular
Connector Angle (°)	25.0
Mechanical Surface Detection Mode	enabled
Optical Surface Detection Mode	disabled
Probe Overall Length	337 mm
Probe Body Diameter	10 mm
Tip Length	10 mm
Tip Diameter	8.0 mm
Probe Tip to Sensor X Calibration Point	2.5 mm
Probe Tip to Sensor Y Calibration Point	2.5 mm
Probe Tip to Sensor Z Calibration Point	2.5 mm



Accredited by the Swiss Accreditation Service (SAS)  
The Swiss Accreditation Service is one of the signatories to the EA  
Multilateral Agreement for the recognition of calibration certificates

Accreditation No.: **SCS 108**

Client **Motorola MDb**

Certificate No: **H3-6078\_May10**

**CALIBRATION CERTIFICATE**

Object **H3DV6 - SN:6078**

Calibration procedure(s) **QA CAL-03.v5 and QA CAL-25.v2  
Calibration procedure for H-field probes optimized for close near field  
evaluations in air**

Calibration date: **May 11, 2010**

This calibration certificate documents the traceability to national standards, which realize the physical units of measurements (SI).  
The measurements and the uncertainties with confidence probability are given on the following pages and are part of the certificate.

All calibrations have been conducted in the closed laboratory facility: environment temperature (22 ± 3)°C and humidity < 70%.

Calibration Equipment used (M&TE critical for calibration)

Primary Standards	ID #	Cal Date (Certificate No.)	Scheduled Calibration
Power meter E4419B	GB41293874	1-Apr-10 (No. 217-01136)	Apr-11
Power sensor E4412A	MY41495277	1-Apr-10 (No. 217-01136)	Apr-11
Power sensor E4412A	MY41498087	1-Apr-10 (No. 217-01136)	Apr-11
Reference 3 dB Attenuator	SN: S5054 (3c)	30-Mar-10 (No. 217-01159)	Mar-11
Reference 20 dB Attenuator	SN: S5086 (20b)	30-Mar-10 (No. 217-01161)	Mar-11
Reference 30 dB Attenuator	SN: S5129 (30b)	30-Mar-10 (No. 217-01160)	Mar-11
Reference Probe H3DV6	SN: 6182	3-Oct-09 (No. H3-6182_Oct09)	Oct-10
DAE4	SN: 789	23-Dec-09 (No. DAE4-789_Dec09)	Dec-10
Secondary Standards	ID #	Check Date (in house)	Scheduled Check
RF generator HP 8648C	US3642U01700	4-Aug-99 (in house check Oct-09)	In house check: Oct-11
Network Analyzer HP 8753E	US37390585	18-Oct-01 (in house check Oct-09)	In house check: Oct10

Calibrated by:	<b>Claudio Leubler</b>	<b>Laboratory Technician</b>	
Approved by:	<b>Katja Pokovic</b>	<b>Technical Manager</b>	

Issued: May 12, 2010

This calibration certificate shall not be reproduced except in full without written approval of the laboratory.



Accredited by the Swiss Accreditation Service (SAS)  
The Swiss Accreditation Service is one of the signatories to the EA  
Multilateral Agreement for the recognition of calibration certificates

Accreditation No.: **SCS 108**

**Glossary:**

NORM <sub>x,y,z</sub>	sensitivity in free space
DCP	diode compression point
CF	crest factor (1/duty_cycle) of the RF signal
A, B, C	modulation dependent linearization parameters
Polarization $\varphi$	$\varphi$ rotation around probe axis
Polarization $\vartheta$	$\vartheta$ rotation around an axis that is in the plane normal to probe axis (at measurement center), i.e., $\vartheta = 0$ is normal to probe axis
Connector Angle	information used in DASY system to align probe sensor X to the robot coordinate system

**Calibration is Performed According to the Following Standards:**

- a) IEEE Std 1309-2005, "IEEE Standard for calibration of electromagnetic field sensors and probes, excluding antennas, from 9 kHz to 40 GHz", December 2005.

**Methods Applied and Interpretation of Parameters:**

- *NORM<sub>x,y,z</sub>*: Assessed for E-field polarization  $\vartheta = 0$  for XY sensors and  $\vartheta = 90$  for Z sensor ( $f \leq 900$  MHz in TEM-cell;  $f > 1800$  MHz: R22 waveguide).
- *X, Y, Z(f)\_a0a1a2* = *X, Y, Z\_a0a1a2* \* *frequency\_response* (see Frequency Response Chart).
- *DCP<sub>x,y,z</sub>*: DCP are numerical linearization parameters assessed based on the data of power sweep with CW signal (no uncertainty required). DCP does not depend on frequency nor media.
- *A<sub>x,y,z</sub>; B<sub>x,y,z</sub>; C<sub>x,y,z</sub>; VR<sub>x,y,z</sub>; A, B, C* are numerical linearization parameters assessed based on the data of power sweep for specific modulation signal. The parameters do not depend on frequency nor media. *VR* is the maximum calibration range expressed in RMS voltage across the diode.
- *Spherical isotropy (3D deviation from isotropy)*: in a locally homogeneous field realized using an open waveguide setup.
- *Sensor Offset*: The sensor offset corresponds to the offset of virtual measurement center from the probe tip (on probe axis). No tolerance required.
- *Connector Angle*: The angle is assessed using the information gained by determining the *X\_a0a1a2* (no uncertainty required).

# Probe H3DV6

## SN:6078

Manufactured:	October 2, 2000
Last calibrated:	September 22, 2008
Recalibrated:	May 11, 2010

Calibrated for DASY/EASY Systems

(Note: non-compatible with DASY2 system!)

**DASY/EASY - Parameters of Probe: H3DV6 SN:6078****Basic Calibration Parameters**

		Sensor X	Sensor Y	Sensor Z	Unc (k=2)
Norm (A/m / $\sqrt{(\mu V)}$ )	a0	2.79E-3	2.70E-3	3.08E-3	$\pm 5.1\%$
Norm (A/m / $\sqrt{(\mu V)}$ )	a1	-1.88E-4	-1.37E-4	-2.79E-4	$\pm 5.1\%$
Norm (A/m / $\sqrt{(\mu V)}$ )	a2	2.70E-5	3.64E-6	5.11E-6	$\pm 5.1\%$
DCP (mV) <sup>A</sup>		89.9	83.3	83.1	

**Modulation Calibration Parameters**

UID	Communication System Name	PAR		A dB	B dBuV	C	VR mV	Unc <sup>E</sup> (k=2)
10000	CW	0.00	X	0.00	0.00	1.00	300	$\pm 1.5\%$
			Y	0.00	0.00	1.00	300	
			Z	0.00	0.00	1.00	300	

The reported uncertainty of measurement is stated as the standard uncertainty of measurement multiplied by the coverage factor  $k=2$ , which for a normal distribution corresponds to a coverage probability of approximately 95%.

<sup>A</sup> numerical linearization parameter: uncertainty not required

<sup>E</sup> Uncertainty is determined using the maximum deviation from linear response applying recatangular distribution and is expressed for the square of the field value.

### Frequency Response of H-Field (TEM-Cell:ifi110 EXX, Waveguide R22)

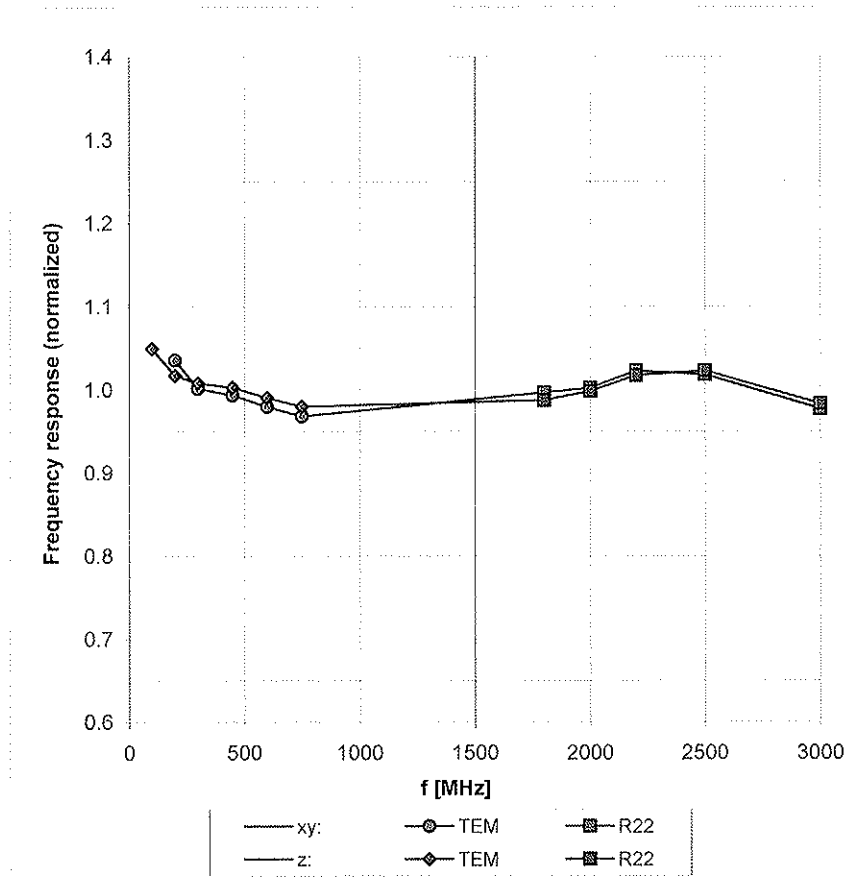

Uncertainty of Frequency Response of H-field:  $\pm 6.3\%$  (k=2)

### Receiving Pattern ( $\phi$ ), $\vartheta = 90^\circ$

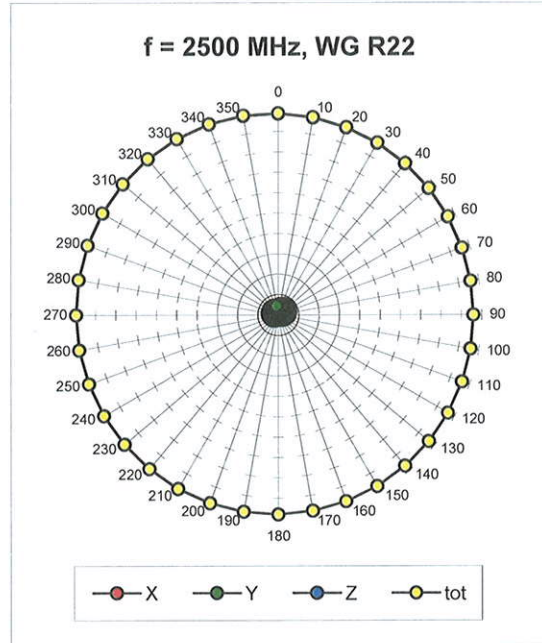
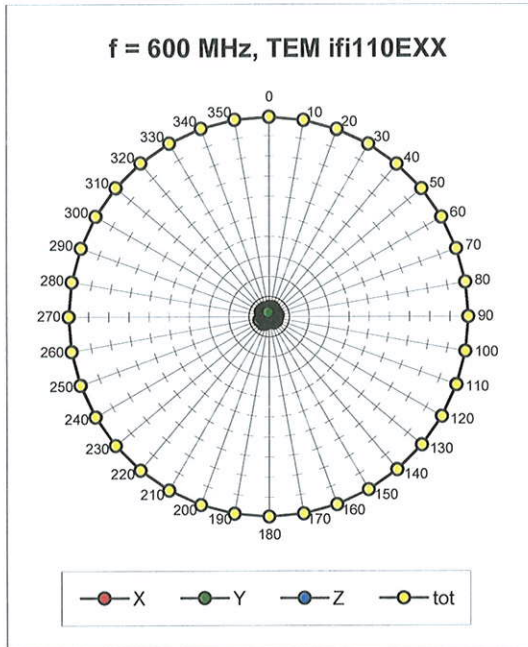

### Receiving Pattern ( $\phi$ ), $\vartheta = 0^\circ$

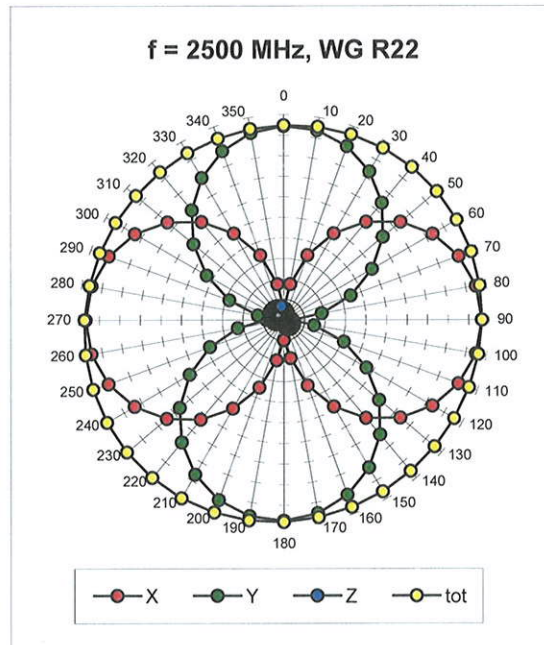
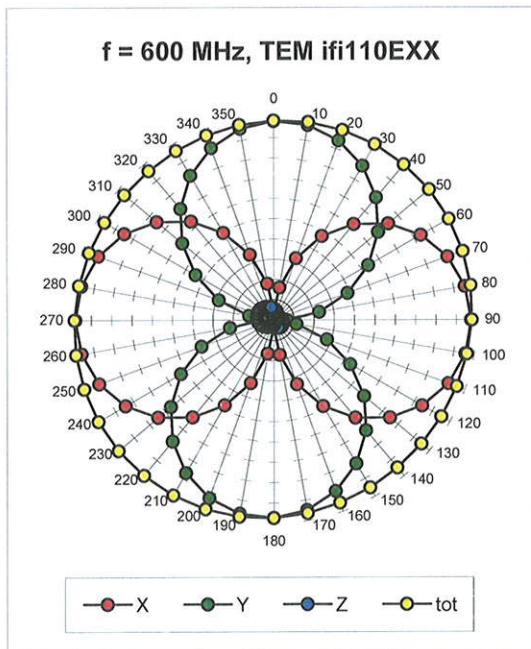

### Receiving Pattern ( $\phi$ ), $\vartheta = 90^\circ$

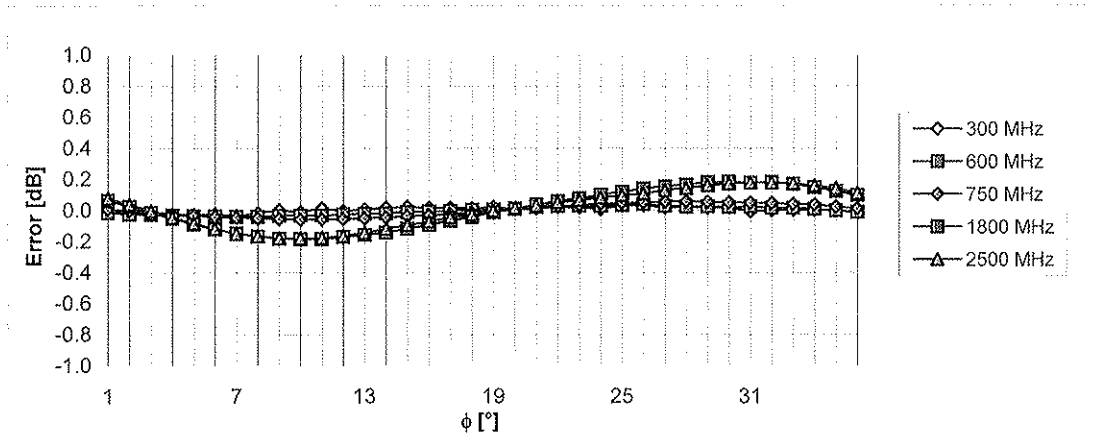

Uncertainty of Axial Isotropy Assessment:  $\pm 0.5\%$  ( $k=2$ )

### Receiving Pattern ( $\phi$ ), $\vartheta = 0^\circ$

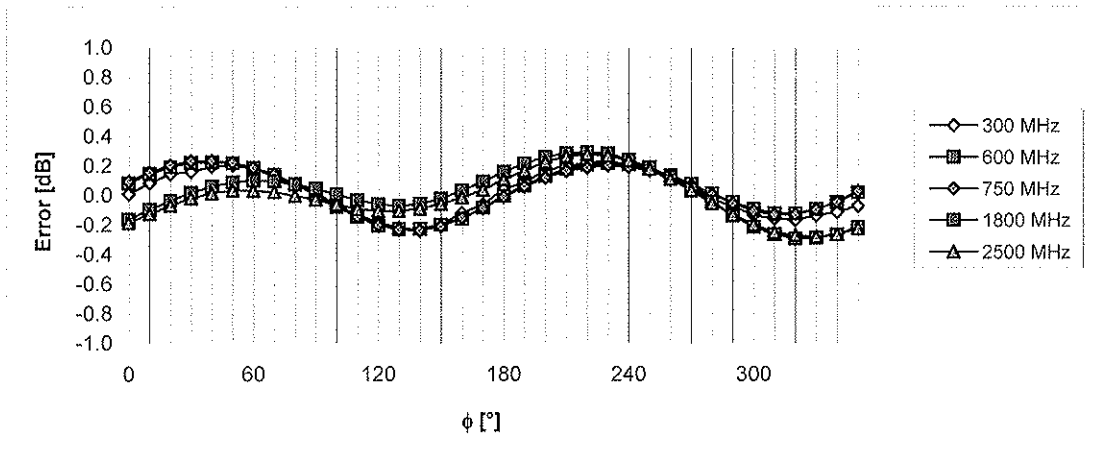

Uncertainty of Axial Isotropy Assessment:  $\pm 0.5\%$  ( $k=2$ )

### Dynamic Range f(H-field) (Waveguide R22, f = 1800 MHz)

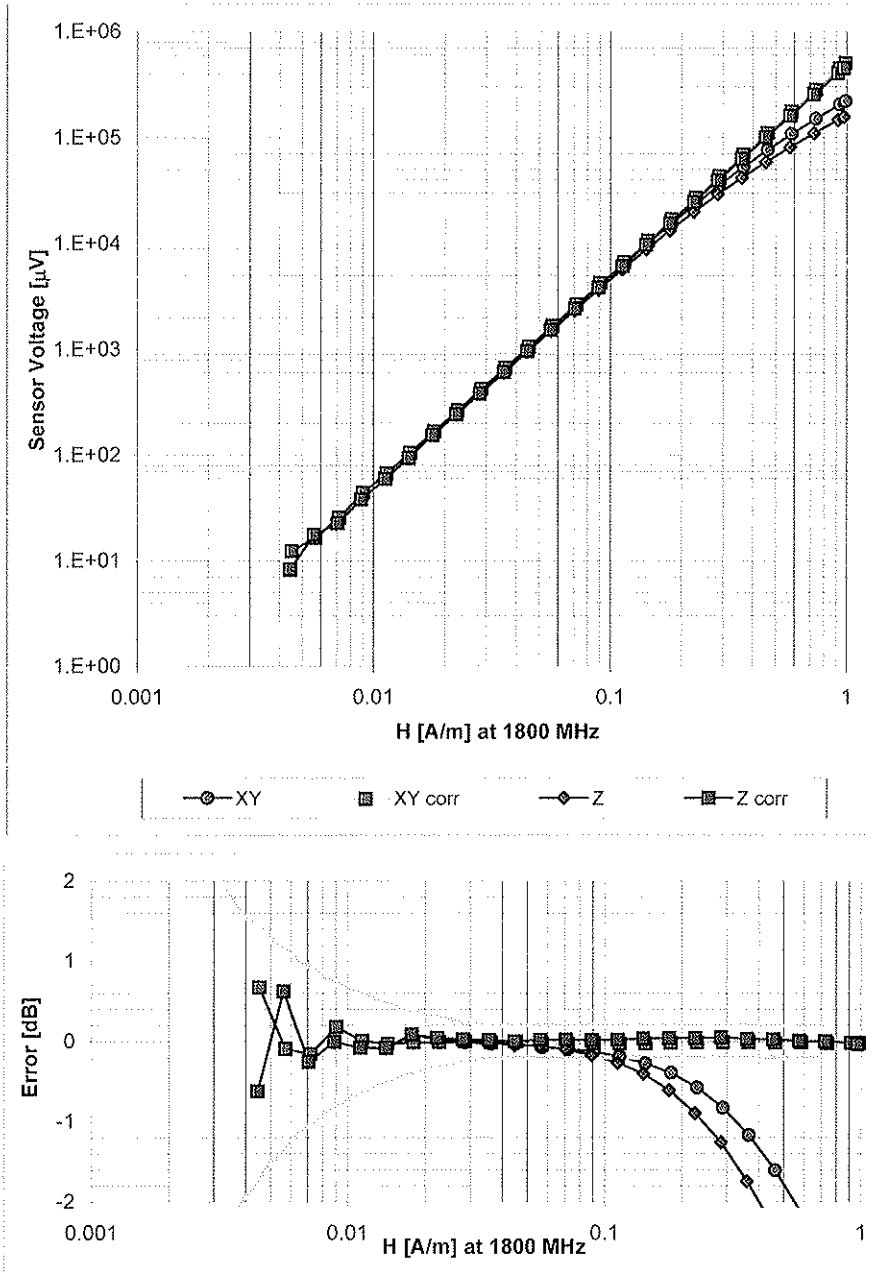

Uncertainty of Linearity Assessment:  $\pm 0.6\%$  ( $k=2$ )

### Deviation from Isotropy in Air Error ( $\phi, \vartheta$ ), $f = 900$ MHz

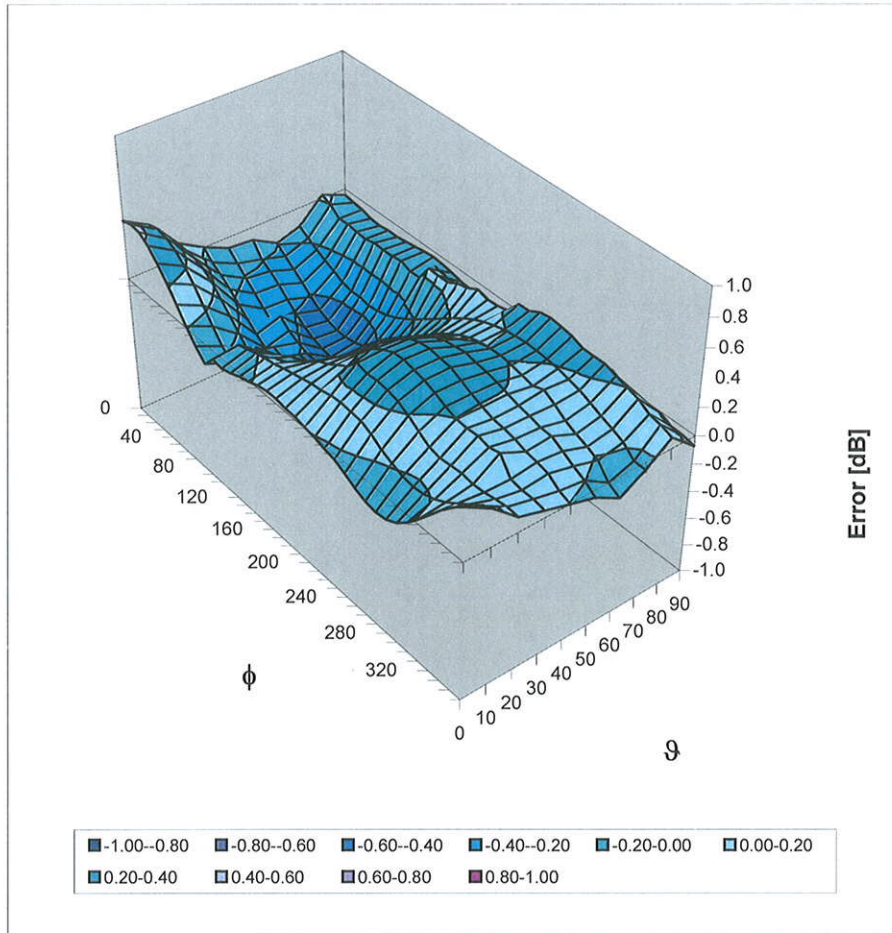

Uncertainty of Spherical Isotropy Assessment:  $\pm 2.6\%$  ( $k=2$ )

## Other Probe Parameters

Sensor Arrangement	Rectangular
Connector Angle (°)	-220.3
Mechanical Surface Detection Mode	enabled
Optical Surface Detection Mode	disabled
Probe Overall Length	337 mm
Probe Body Diameter	10 mm
Tip Length	20 mm
Tip Diameter	6.0 mm
Probe Tip to Sensor X Calibration Point	3 mm
Probe Tip to Sensor Y Calibration Point	3 mm
Probe Tip to Sensor Z Calibration Point	3 mm

**Appendix 7**

**Dipole Characterization Certificates**



Accredited by the Swiss Accreditation Service (SAS)  
The Swiss Accreditation Service is one of the signatories to the EA  
Multilateral Agreement for the recognition of calibration certificates

Accreditation No.: **SCS 108**

Client **Motorola MDb**

Certificate No: **CD835V3-1076\_Feb10**

## CALIBRATION CERTIFICATE

Object **CD835V3 - SN: 1076**

Calibration procedure(s) **QA CAL-20.v5  
Calibration procedure for dipoles in air**

Calibration date: **February 16, 2010**

This calibration certificate documents the traceability to national standards, which realize the physical units of measurements (SI).  
All calibrations have been conducted in the closed laboratory facility: environment temperature (22 ± 3)°C and humidity < 70%.

Calibration Equipment used (M&TE critical for calibration)

Primary Standards	ID #	Cal Date (Certificate No.)	Scheduled Calibration
Power meter EPM-442A	GB37480704	06-Oct-09 (No. 217-01086)	Oct-10
Power sensor HP 8481A	US37292783	06-Oct-09 (No. 217-01086)	Oct-10
Probe ER3DV6	SN: 2336	30-Dec-09 (No. ER3-2336_Dec09)	Dec-10
Probe H3DV6	SN: 6065	30-Dec-09 (No. H3-6065_Dec09)	Dec-10
DAE4	SN: 781	22-Jan-10 (No. DAE4-781_Jan10)	Jan-11
Secondary Standards	ID #	Check Date (in house)	Scheduled Check
Power meter Agilent 4419B	SN: GB42420191	09-Oct-09 (in house check Oct-09)	In house check: Oct-10
Power sensor HP 8482H	SN: 3318A09450	09-Oct-09 (in house check Oct-09)	In house check: Oct-10
Power sensor HP 8482A	SN: US37295597	09-Oct-09 (in house check Oct-09)	In house check: Oct-10
Network Analyzer HP 8753E	US37390585	18-Oct-01 (in house check Oct-09)	In house check: Oct-10
RF generator E4433B	MY 41000675	03-Nov-04 (in house check Oct-09)	In house check: Oct-11

Calibrated by:	Name <b>Claudio Leubler</b>	Function <b>Laboratory Technician</b>	Signature 
Approved by:	Name <b>Fin Bomholt</b>	Function <b>Technical Director</b>	Signature 

Issued: February 23, 2010

This calibration certificate shall not be reproduced except in full without written approval of the laboratory.



Accredited by the Swiss Accreditation Service (SAS)  
The Swiss Accreditation Service is one of the signatories to the EA  
Multilateral Agreement for the recognition of calibration certificates

Accreditation No.: **SCS 108**

## References

- [1] ANSI-C63.19-2006  
American National Standard for Methods of Measurement of Compatibility between Wireless Communications Devices and Hearing Aids.
- [2] ANSI-C63.19-2007  
American National Standard for Methods of Measurement of Compatibility between Wireless Communications Devices and Hearing Aids.

## Methods Applied and Interpretation of Parameters:

- *Coordinate System:* y-axis is in the direction of the dipole arms. z-axis is from the basis of the antenna (mounted on the table) towards its feed point between the two dipole arms. x-axis is normal to the other axes. In coincidence with the standards [1, 2], the measurement planes (probe sensor center) are selected to be at a distance of 10 mm above the top edge of the dipole arms.
- *Measurement Conditions:* Further details are available from the hardcopies at the end of the certificate. All figures stated in the certificate are valid at the frequency indicated. The forward power to the dipole connector is set with a calibrated power meter connected and monitored with an auxiliary power meter connected to a directional coupler. While the dipole under test is connected, the forward power is adjusted to the same level.
- *Antenna Positioning:* The dipole is mounted on a HAC Test Arch phantom using the matching dipole positioner with the arms horizontal and the feeding cable coming from the floor. The measurements are performed in a shielded room with absorbers around the setup to reduce the reflections. It is verified before the mounting of the dipole under the Test Arch phantom, that its arms are perfectly in a line. It is installed on the HAC dipole positioner with its arms parallel below the dielectric reference wire and able to move elastically in vertical direction without changing its relative position to the top center of the Test Arch phantom. The vertical distance to the probe is adjusted after dipole mounting with a DASY5 Surface Check job. Before the measurement, the distance between phantom surface and probe tip is verified. The proper measurement distance is selected by choosing the matching section of the HAC Test Arch phantom with the proper device reference point (upper surface of the dipole) and the matching grid reference point (tip of the probe) considering the probe sensor offset. The vertical distance to the probe is essential for the accuracy.
- *Feed Point Impedance and Return Loss:* These parameters are measured using a HP 8753E Vector Network Analyzer. The impedance is specified at the SMA connector of the dipole. The influence of reflections was eliminating by applying the averaging function while moving the dipole in the air, at least 70cm away from any obstacles.
- *E- field distribution:* E field is measured in the x-y-plane with an isotropic ER3D-field probe with 100 mW forward power to the antenna feed point. In accordance with [1, 2], the scan area is 20mm wide, its length exceeds the dipole arm length (180 or 90mm). The sensor center is 10 mm (in z) above the top of the dipole arms. Two 3D maxima are available near the end of the dipole arms. Assuming the dipole arms are perfectly in one line, the average of these two maxima (in subgrid 2 and subgrid 8) is determined to compensate for any non-parallelity to the measurement plane as well as the sensor displacement. The E-field value stated as calibration value represents the maximum of the interpolated 3D-E-field, 10mm above the dipole surface.
- *H-field distribution:* H-field is measured with an isotropic H-field probe with 100mW forward power to the antenna feed point, in the x-y-plane. The scan area and sensor distance is equivalent to the E-field scan. The maximum of the field is available at the center (subgrid 5) above the feed point. The H-field value stated as calibration value represents the maximum of the interpolated H-field, 10mm above the dipole surface at the feed point.

## 1 Measurement Conditions

DASY system configuration, as far as not given on page 1.

<b>DASY Version</b>	DASY5	V5.2 B162
<b>DASY PP Version</b>	SEMCAD X	V14.0 B57
<b>Phantom</b>	HAC Test Arch	SD HAC P01 BA, #1070
<b>Distance Dipole Top - Probe Center</b>	10 mm	
<b>Scan resolution</b>	dx, dy = 5 mm	area = 20 x 180 mm
<b>Frequency</b>	<b>835 MHz ± 1 MHz</b>	
<b>Forward power at dipole connector</b>	20.0 dBm = 100mW	
<b>Input power drift</b>	< 0.05 dB	

## 2 Maximum Field values

<b>H-field 10 mm above dipole surface</b>	condition	<b>interpolated maximum</b>
Maximum measured	100 mW forward power	<b>0.459 A/m</b>

Uncertainty for H-field measurement: 8.2% (k=2)

<b>E-field 10 mm above dipole surface</b>	condition	<b>Interpolated maximum</b>
Maximum measured above high end-	100 mW forward power	170.0 V/m
Maximum measured above low end	100 mW forward power	159.5 V/m
Averaged maximum above arm	100 mW forward power	<b>164.8 V/m</b>

Uncertainty for E-field measurement: 12.8% (k=2)

## 3 Appendix

### 3.1 Antenna Parameters

<b>Frequency</b>	<b>Return Loss</b>	<b>Impedance</b>
800 MHz	16.1 dB	( 44.1 – j13.7 ) Ohm
<b>835 MHz</b>	<b>28.4 dB</b>	<b>( 49.6 + j3.8 ) Ohm</b>
900 MHz	17.7 dB	( 56.0 – j12.6 ) Ohm
950 MHz	22.0 dB	( 47.9 + j7.5 ) Ohm
960 MHz	16.1 dB	( 54.7 + j16.0 ) Ohm

### 3.2 Antenna Design and Handling

The calibration dipole has a symmetric geometry with a built-in two stub matching network, which leads to the enhanced bandwidth.

The dipole is built of standard semirigid coaxial cable. The internal matching line is open ended. The antenna is therefore open for DC signals.

Do not apply force to dipole arms, as they are liable to bend. The soldered connections near the feedpoint may be damaged. After excessive mechanical stress or overheating, check the impedance characteristics to ensure that the internal matching network is not affected.

After long term use with 40W radiated power, only a slight warming of the dipole near the feedpoint can be measured.

### 3.3 Measurement Sheets

X

#### 3.3.1 Return Loss and Smith Chart

22 Feb 2010 12:12:51

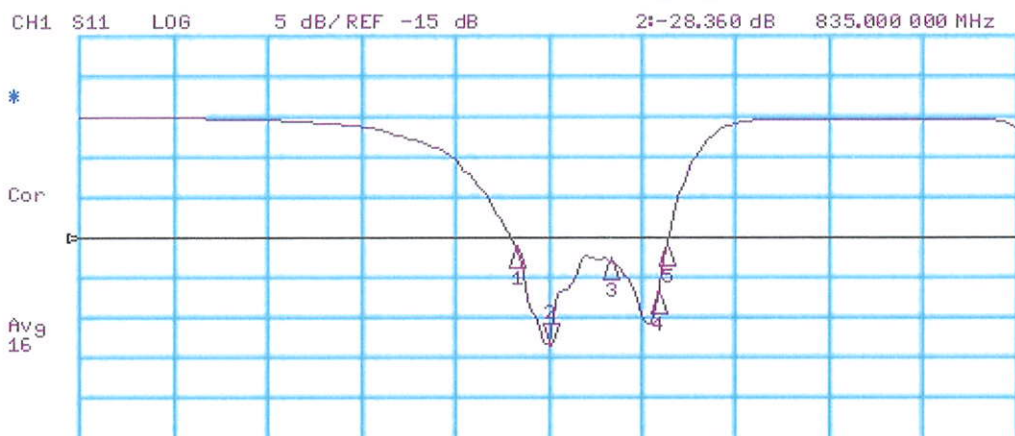

CH1 Markers

- 1:-16.117 dB  
800.000 MHz
- 3:-17.696 dB  
900.000 MHz
- 4:-22.005 dB  
950.000 MHz
- 5:-16.063 dB  
960.000 MHz

CH2 S11 1 U FS 2: 49.643  $\Omega$  3: 7871  $\Omega$  721.84  $\mu\text{H}$  835.000 000 MHz

Del

Cor

Avg  
16

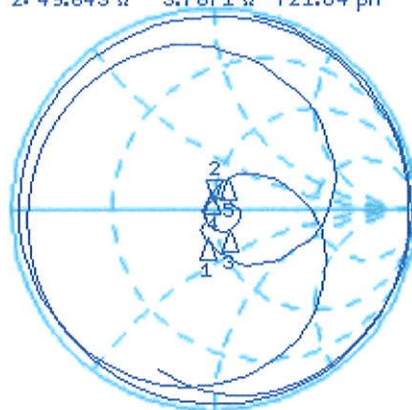

CH2 Markers

- 1: 44.145  $\Omega$   
-13.676  $\Omega$   
800.000 MHz
- 3: 55.979  $\Omega$   
-12.564  $\Omega$   
900.000 MHz
- 4: 47.889  $\Omega$   
7.5020  $\Omega$   
950.000 MHz
- 5: 54.656  $\Omega$   
15.992  $\Omega$   
960.000 MHz

START 335.000 000 MHz

STOP 1 335.000 000 MHz

**3.3.2 DASY4 H-field Result**

Date/Time: 16.02.2010 13:12:57

Test Laboratory: SPEAG Lab2

**HAC RF\_CD835\_1076\_100216\_H\_CL**

**DUT: HAC-Dipole 835 MHz; Type: CD835V3; Serial: 1076**

Communication System: CW; Frequency: 835 MHz;

Medium parameters used:  $\sigma = 0$  mho/m,  $\epsilon_r = 1$ ;  $\rho = 1$  kg/m<sup>3</sup>

Phantom section: RF Section

Measurement Standard: DASY5 (IEEE/IEC/ANSI C63.19-2007)

DASY5 Configuration:

- Probe: H3DV6 - SN6065; ; Calibrated: 30.12.2009
- Sensor-Surface: (Fix Surface)
- Electronics: DAE4 Sn781; Calibrated: 22.01.2010
- Phantom: HAC Test Arch with AMCC; Type: SD HAC P01 BA; Serial: 1070
- Measurement SW: DASY5, V5.2 Build 162; SEMCAD X Version 14.0 Build 57

**Dipole H-Field measurement @ 835MHz/H Scan - measurement distance from the probe sensor center to CD835 Dipole = 10mm/Hearing Aid Compatibility Test (41x361x1):**

Measurement grid: dx=5mm, dy=5mm

Maximum value of peak Total field = 0.459 A/m

Probe Modulation Factor = 1

Device Reference Point: 0, 0, -6.3 mm

Reference Value = 0.487 A/m; Power Drift = 0.013 dB

**Hearing Aid Near-Field Category: M4 (AWF 0 dB)**

Peak H-field in A/m

Grid 1 <b>0.386</b> <b>M4</b>	Grid 2 <b>0.399</b> <b>M4</b>	Grid 3 <b>0.371</b> <b>M4</b>
Grid 4 <b>0.441</b> <b>M4</b>	Grid 5 <b>0.459</b> <b>M4</b>	Grid 6 <b>0.430</b> <b>M4</b>
Grid 7 <b>0.395</b> <b>M4</b>	Grid 8 <b>0.414</b> <b>M4</b>	Grid 9 <b>0.388</b> <b>M4</b>

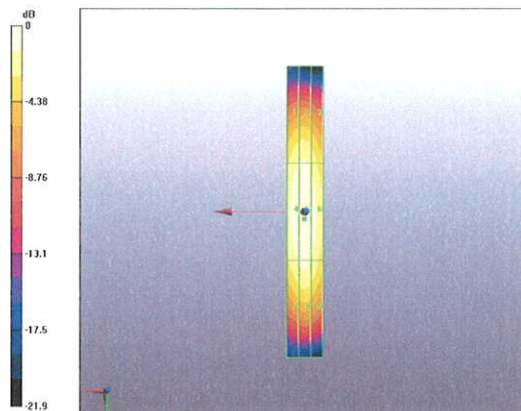

0 dB = 0.459A/m

### 3.3.3 DASY4 E-field Result

Date/Time: 16.02.2010 17:03:10

Test Laboratory: SPEAG Lab2

**HAC RF\_CD835\_1076\_100216\_E\_CL**

**DUT: HAC-Dipole 835 MHz; Type: CD835V3; Serial: 1076**

Communication System: CW; Frequency: 835 MHz;

Medium parameters used:  $\sigma = 0$  mho/m,  $\epsilon_r = 1$ ;  $\rho = 1000$  kg/m<sup>3</sup>

Phantom section: RF Section

Measurement Standard: DASY5 (IEEE/IEC/ANSI C63.19-2007)

DASY5 Configuration:

- Probe: ER3DV6 - SN2336; ConvF(1, 1, 1); Calibrated: 30.12.2009
- Sensor-Surface: (Fix Surface)
- Electronics: DAE4 Sn781; Calibrated: 22.01.2010
- Phantom: HAC Test Arch with AMCC; Type: SD HAC P01 BA; Serial: 1070
- Measurement SW: DASY5, V5.2 Build 162; SEMCAD X Version 14.0 Build 57

**Dipole E-Field measurement @ 835MHz/E Scan - measurement distance from the probe sensor center to CD835 Dipole = 10mm/Hearing Aid Compatibility Test (41x361x1):**

Measurement grid: dx=5mm, dy=5mm

Maximum value of peak Total field = 170.0 V/m

Probe Modulation Factor = 1

Device Reference Point: 0, 0, -6.3 mm

Reference Value = 106.0 V/m; Power Drift = 0.014 dB

**Hearing Aid Near-Field Category: M4 (AWF 0 dB)**

Peak E-field in V/m

Grid 1 <b>156.9</b> M4	Grid 2 <b>159.5</b> M4	Grid 3 <b>154.8</b> M4
Grid 4 <b>88.6</b> M4	Grid 5 <b>90</b> M4	Grid 6 <b>86.5</b> M4
Grid 7 <b>161.9</b> M4	Grid 8 <b>170.0</b> M4	Grid 9 <b>166.6</b> M4

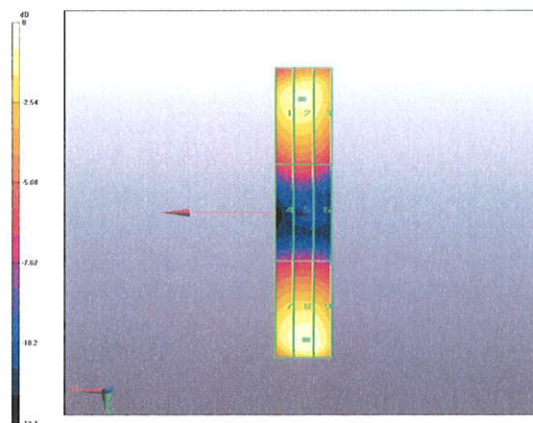

0 dB = 170.0V/m

## 4. Additional Measurements

### 4.1 Measurement Conditions

DASY system configuration, as far as not given on page 1.

<b>DASY Version</b>	DASY5	V5.2 B162
<b>DASY PP Version</b>	SEMCAD X	V14.0 B57
<b>Phantom</b>	HAC Test Arch	SD HAC P01 BA, #1070
<b>Distance Dipole Top - Probe Center</b>	10 mm	
<b>Scan resolution</b>	dx, dy = 5 mm	area = 20 x 180 mm
<b>Frequency</b>	<b>813 MHz ± 1 MHz</b>	
<b>Forward power at dipole connector</b>	20.0 dBm = 100mW	
<b>Input power drift</b>	< 0.05 dB	

#### 4.1.1 Maximum Field values

<b>H-field 10 mm above dipole surface</b>	condition	<b>interpolated maximum</b>
Maximum measured	100 mW forward power	<b>0.471 A/m</b>

Uncertainty for H-field measurement: 8.2% (k=2)

<b>E-field 10 mm above dipole surface</b>	condition	<b>Interpolated maximum</b>
Maximum measured above high end-	100 mW forward power	169.1 V/m
Maximum measured above low end	100 mW forward power	168.6 V/m
Averaged maximum above arm	100 mW forward power	<b>168.9 V/m</b>

Uncertainty for E-field measurement: 12.8% (k=2)

4.1.2 DASY4 H-field result

Date/Time: 16.02.2010 12:50:00

Test Laboratory: SPEAG Lab2

HAC RF\_CD835\_1076\_100216\_H\_CL

DUT: HAC-Dipole 835 MHz; Type: CD835V3; Serial: 1076

Communication System: CW; Frequency: 813 MHz;

Medium parameters used:  $\sigma = 0$  mho/m,  $\epsilon_r = 1$ ;  $\rho = 1$  kg/m<sup>3</sup>

Phantom section: RF Section

Measurement Standard: DASY5 (IEEE/IEC/ANSI C63.19-2007)

DASY5 Configuration:

- Probe: H3DV6 - SN6065; ; Calibrated: 30.12.2009
- Sensor-Surface: (Fix Surface)
- Electronics: DAE4 Sn781; Calibrated: 22.01.2010
- Phantom: HAC Test Arch with AMCC; Type: SD HAC P01 BA; Serial: 1070
- Measurement SW: DASY5, V5.2 Build 162; SEMCAD X Version 14.0 Build 57

**Dipole H-Field measurement @ 813MHz/H Scan - measurement distance from the probe sensor center to CD835 (813MHz) Dipole = 10mm/Hearing Aid Compatibility Test (41x361x1):**

Measurement grid: dx=5mm, dy=5mm

Maximum value of peak Total field = 0.471 A/m

Probe Modulation Factor = 1

Device Reference Point: 0, 0, -6.3 mm

Reference Value = 0.500 A/m; Power Drift = -0.00617 dB

**Hearing Aid Near-Field Category: M4 (AWF 0 dB)**

Peak H-field in A/m

Grid 1 <b>0.387</b> <b>M4</b>	Grid 2 <b>0.403</b> <b>M4</b>	Grid 3 <b>0.378</b> <b>M4</b>
Grid 4 <b>0.452</b> <b>M4</b>	Grid 5 <b>0.471</b> <b>M4</b>	Grid 6 <b>0.440</b> <b>M4</b>
Grid 7 <b>0.403</b> <b>M4</b>	Grid 8 <b>0.420</b> <b>M4</b>	Grid 9 <b>0.390</b> <b>M4</b>

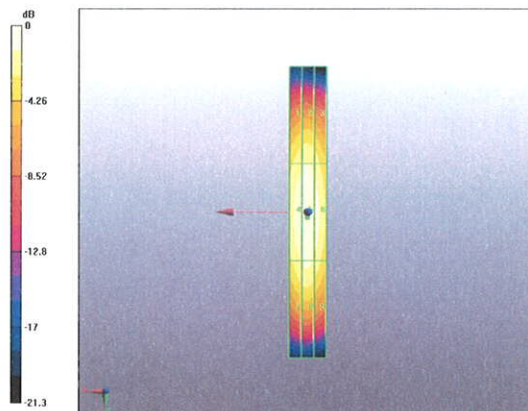

0 dB = 0.471A/m

4.1.3 DASY4 E-field result

Date/Time: 16.02.2010 16:47:06

Test Laboratory: SPEAG Lab2

HAC RF\_CD835\_1076\_100216\_E\_CL

DUT: HAC-Dipole 835 MHz; Type: CD835V3; Serial: 1076

Communication System: CW; Frequency: 813 MHz

Medium parameters used:  $\sigma = 0$  mho/m,  $\epsilon_r = 1$ ;  $\rho = 1000$  kg/m<sup>3</sup>

Phantom section: RF Section

Measurement Standard: DASY5 (IEEE/IEC/ANSI C63.19-2007)

DASY5 Configuration:

- Probe: ER3DV6 - SN2336; ConvF(1, 1, 1); Calibrated: 30.12.2009
- Sensor-Surface: (Fix Surface)
- Electronics: DAE4 Sn781; Calibrated: 22.01.2010
- Phantom: HAC Test Arch with AMCC; Type: SD HAC P01 BA; Serial: 1070
- Measurement SW: DASY5, V5.2 Build 162; SEMCAD X Version 14.0 Build 57

**Dipole E-Field measurement @ 813MHz/E Scan - measurement distance from the probe sensor center to CD835 (813MHz) Dipole = 10mm/Hearing Aid Compatibility Test (41x361x1):**

Measurement grid: dx=5mm, dy=5mm

Maximum value of peak Total field = 169.1 V/m

Probe Modulation Factor = 1

Device Reference Point: 0, 0, -6.3 mm

Reference Value = 109.2 V/m; Power Drift = 0.013 dB

**Hearing Aid Near-Field Category: M4 (AWF 0 dB)**

Peak E-field in V/m

Grid 1 <b>165.2</b> <b>M4</b>	Grid 2 <b>168.6</b> <b>M4</b>	Grid 3 <b>164.0</b> <b>M4</b>
Grid 4 <b>94.5</b> <b>M4</b>	Grid 5 <b>96.4</b> <b>M4</b>	Grid 6 <b>92.9</b> <b>M4</b>
Grid 7 <b>161.6</b> <b>M4</b>	Grid 8 <b>169.1</b> <b>M4</b>	Grid 9 <b>165.2</b> <b>M4</b>

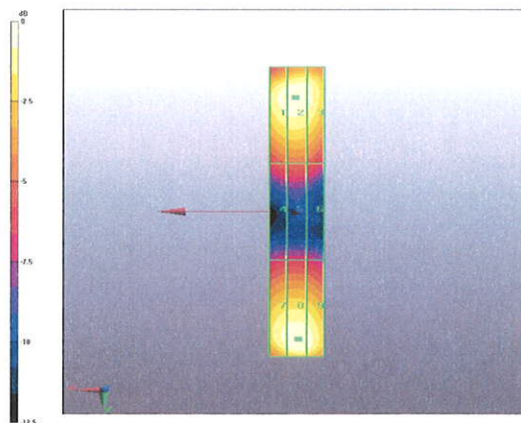

0 dB = 169.1V/m

## 4.2. Measurement Conditions

DASY system configuration, as far as not given on page 1.

<b>DASY Version</b>	DASY5	V5.2 B162
<b>DASY PP Version</b>	SEMCAD X	V14.0 B57
<b>Phantom</b>	HAC Test Arch	SD HAC P01 BA, #1070
<b>Distance Dipole Top - Probe Center</b>	10 mm	
<b>Scan resolution</b>	dx, dy = 5 mm	area = 20 x 180 mm
<b>Frequency</b>	<b>898 MHz ± 1 MHz</b>	
<b>Forward power at dipole connector</b>	20.0 dBm = 100mW	
<b>Input power drift</b>	< 0.05 dB	

### 4.2.1 Maximum Field values

<b>H-field 10 mm above dipole surface</b>	condition	<b>interpolated maximum</b>
Maximum measured	100 mW forward power	<b>0.434 A/m</b>

Uncertainty for H-field measurement: 8.2% (k=2)

<b>E-field 10 mm above dipole surface</b>	condition	<b>Interpolated maximum</b>
Maximum measured above high end-	100 mW forward power	160.5 V/m
Maximum measured above low end	100 mW forward power	150.0 V/m
Averaged maximum above arm	100 mW forward power	<b>155.3 V/m</b>

Uncertainty for E-field measurement: 12.8% (k=2)

4.2.2 DASY4 H-field result

Date/Time: 16.02.2010 12:25:41

Test Laboratory: SPEAG Lab2

HAC RF\_CD835\_1076\_100216\_H\_CL

DUT: HAC-Dipole 835 MHz; Type: CD835V3; Serial: 1076

Communication System: CW; Frequency: 898 MHz;

Medium parameters used:  $\sigma = 0$  mho/m,  $\epsilon_r = 1$ ;  $\rho = 1$  kg/m<sup>3</sup>

Phantom section: RF Section

Measurement Standard: DASY5 (IEEE/IEC/ANSI C63.19-2007)

DASY5 Configuration:

- Probe: H3DV6 - SN6065; ; Calibrated: 30.12.2009
- Sensor-Surface: (Fix Surface)
- Electronics: DAE4 Sn781; Calibrated: 22.01.2010
- Phantom: HAC Test Arch with AMCC; Type: SD HAC P01 BA; Serial: 1070
- Measurement SW: DASY5, V5.2 Build 162; SEMCAD X Version 14.0 Build 57

**Dipole H-Field measurement @ 898MHz/H Scan - measurement distance from the probe sensor center to CD835 (898MHz) Dipole = 10mm/Hearing Aid Compatibility Test (41x361x1):**

Measurement grid: dx=5mm, dy=5mm

Maximum value of peak Total field = 0.434 A/m

Probe Modulation Factor = 1

Device Reference Point: 0, 0, -6.3 mm

Reference Value = 0.455 A/m; Power Drift = -0.014 dB

**Hearing Aid Near-Field Category: M4 (AWF 0 dB)**

Peak H-field in A/m

Grid 1 <b>0.389</b> <b>M4</b>	Grid 2 <b>0.403</b> <b>M4</b>	Grid 3 <b>0.375</b> <b>M4</b>
Grid 4 <b>0.418</b> <b>M4</b>	Grid 5 <b>0.434</b> <b>M4</b>	Grid 6 <b>0.404</b> <b>M4</b>
Grid 7 <b>0.390</b> <b>M4</b>	Grid 8 <b>0.408</b> <b>M4</b>	Grid 9 <b>0.381</b> <b>M4</b>

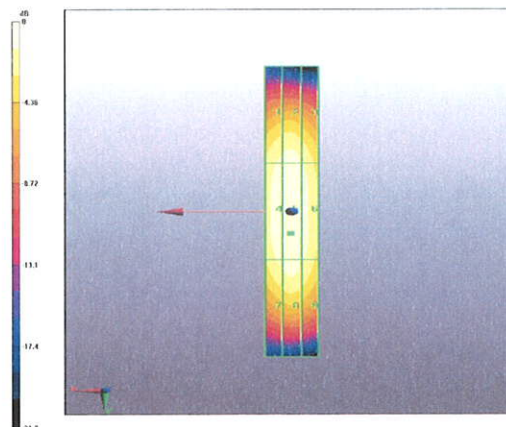

0 dB = 0.434A/m

4.2.3 DASY4 E-field result

Date/Time: 16.02.2010 15:45:32

Test Laboratory: SPEAG Lab2

HAC RF\_CD835\_1076\_100216\_E\_CL

DUT: HAC-Dipole 835 MHz; Type: CD835V3; Serial: 1076

Communication System: CW; Frequency: 898 MHz;

Medium parameters used:  $\sigma = 0$  mho/m,  $\epsilon_r = 1$ ;  $\rho = 1000$  kg/m<sup>3</sup>

Phantom section: RF Section

Measurement Standard: DASY5 (IEEE/IEC/ANSI C63.19-2007)

DASY5 Configuration:

- Probe: ER3DV6 - SN2336; ConvF(1, 1, 1); Calibrated: 30.12.2009
- Sensor-Surface: (Fix Surface)
- Electronics: DAE4 Sn781; Calibrated: 22.01.2010
- Phantom: HAC Test Arch with AMCC; Type: SD HAC P01 BA; Serial: 1070
- Measurement SW: DASY5, V5.2 Build 162; SEMCAD X Version 14.0 Build 57

**Dipole E-Field measurement @ 898MHz/E Scan - measurement distance from the probe sensor center to CD835 (898MHz) Dipole = 10mm/Hearing Aid Compatibility Test (41x361x1):**

Measurement grid: dx=5mm, dy=5mm

Maximum value of peak Total field = 160.5 V/m

Probe Modulation Factor = 1

Device Reference Point: 0, 0, -6.3 mm

Reference Value = 86.1 V/m; Power Drift = -0.00063 dB

**Hearing Aid Near-Field Category: M4 (AWF 0 dB)**

Peak E-field in V/m

Grid 1 <b>149.9</b> M4	Grid 2 <b>150.0</b> M4	Grid 3 <b>137.3</b> M4
Grid 4 <b>81</b> M4	Grid 5 <b>81</b> M4	Grid 6 <b>73.9</b> M4
Grid 7 <b>156.7</b> M4	Grid 8 <b>160.5</b> M4	Grid 9 <b>148.9</b> M4

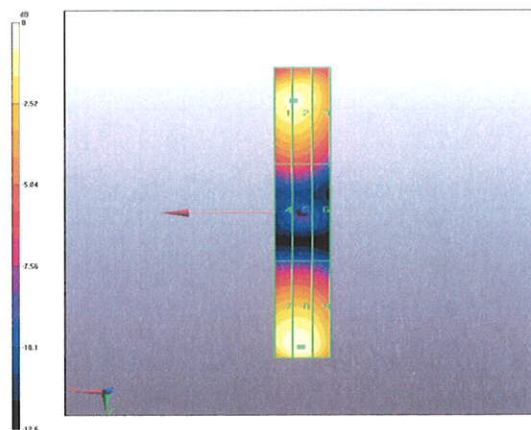

0 dB = 160.5V/m

**END OF REPORT**