



MOTOROLA

HAC Test Report for Near Field Emissions IHDT56LD1

Tests Requested By: Motorola Mobile Devices
600 N. US Highway 45
Libertyville, IL 60048

Date of Tests: Jul-16-2010, Jul-22-2010
Date of Report: Jul-29-2010

Test Laboratory: Motorola Mobile Devices Business Product Safety & Compliance Laboratory
600 N. US Highway 45
Libertyville, Illinois 60048

Report Author: Thomas Knipple
Senior RF Engineer

Statement of Compliance: Motorola declares under its sole responsibility that portable cellular telephone FCC ID IHDT56LD1 to which this declaration relates, complies with recommendations and guidelines per FCC 47 CFR §20.19. The measurements were performed to ensure compliance to ANSI C63.19-2007. It also declares that the product was tested in accordance with the appropriate measurement standards, guidelines and recommended practices. Any deviations from these standards, guidelines and recommended practices are noted below:

(none)

Results Summary: M Category = M3

©Motorola, Inc. 2010

This test report shall not be reproduced except in full, without written approval of the laboratory.

The results and statements contained herein relate only to the items tested. The names of individuals involved may be mentioned only in connection with the statements or results from this report.

Motorola encourages all feedback, both positive and negative, on this test report.

Table of Contents

1. INTRODUCTION3

2. DESCRIPTION OF THE DEVICE UNDER TEST.....3

3. TEST EQUIPMENT USED.....4

4. VALIDATION5

5. PROBE MODULATION FACTOR6

6. TEST RESULTS.....8

7. MEASUREMENTS FOR CERTIFICATION OF 3G DEVICES.....11

Appendix 1: Details justifying the conversion to peak
 A1.1 Procedure for PMF measurements
 A1.2 0-span spectrum plots for PMF measurements

Appendix 2: HAC Distribution Plots for Validation

Appendix 3: HAC Distribution Plots for E-Field and H-Field

Appendix 4: Motorola Uncertainty Budget
 A4.1 Motorola Uncertainty Budget for RF HAC testing
 A4.2 Probe Rotation Contributions to Isotropy Error

Appendix 5: Pictures of Test Setup

Appendix 6: Probe Calibration Certificates

Appendix 7: Dipole Characterization Certificates

1. Introduction

The Motorola Mobile Devices Business Product Safety Laboratory has performed Hearing Aid Compatibility (HAC) measurements for the portable cellular phone (FCC ID IHDT56LD1). The portable cellular phone was tested in accordance with the ANSI C63.19-2007 standard. The test results presented herein clearly demonstrate compliance per FCC 47 CFR § 20.19. This report demonstrates compliance for near-field emissions only and not for Telecoil HAC performance compliance.

2. Description of the Device Under Test

Table 1: Information for the Device Under Test

Serial Number(s)	358342030037299							
Mode(s) of Operation	GSM 850	GSM 900	GSM 1800	GSM 1900	WCDMA 850	WCDMA 1900	Wi-Fi 802.11b/g/n	Bluetooth
Modulation Mode(s)	GSMK	GSMK	GSMK	GSMK	QPSK	QPSK	BPSK	GFSK
Maximum Output Power Setting	33.0 dBm	33.0 dBm	31.0 dBm	31.0 dBm	24.0 dBm	24.0 dBm	20.5 dBm	10 dBm
Duty Cycle	1:8	1:8	1:8	1:8	1:1	1:1	1:1	1:1
Transmitting Frequency Range(s)	824.2 - 848.8 MHz	880.2 - 914.8 MHz	1710.2 - 1784.8 MHz	1850.2 - 1909.8 MHz	826.4 - 846.6 MHz	1852.4 - 1907.6 MHz	2412.0 - 2462.5 MHz	2402.0 - 2483.5 MHz
Production Unit or Identical Prototype (47 CFR §2.908)	Identical Prototype							
Device Category	Portable							
RF Exposure Limits	General Population / Uncontrolled							

Note: No Bluetooth profile exists in this phone that will allow a Bluetooth link while in a cellular call that passes audio to the earpiece. If the user had Bluetooth enabled and a link established, they could not be listening to the phone through the earpiece.

Note: Wi-Fi capability is included in this phone without measurements for hearing aid compatibility based on the interim ruling by the FCC according to paragraph 37 of the Federal Register, Volume 3, Number 89, as of May 7, 2008. Users shall be informed of this via the product user guide per the same FCC ruling.

3. Test Equipment Used

The Motorola Mobile Devices Business Product Safety & Compliance Laboratory utilizes a Dosimetric Assessment System (DASY4™ v4.7) manufactured by Schmid & Partner Engineering AG (SPEAG™), of Zurich Switzerland. All the HAC measurements are taken within a shielded enclosure. The measurement uncertainty budget is given in Appendix 4. The list of calibrated equipment used for the measurements is shown below.

Table 2: Dosimetric System Equipment

Description	Serial Number	Cal Due Date
E-Field Probe ER3DV6R	2244	May-11-2011
DAE3	387	May-19-2011
H-Field Probe H3DV6	6078	May-11-2011
DAE4	650	May-20-2011
835 MHz Dipole CD835V3	1076	Feb-17-2012
1880 MHz Dipole CD1880V3	1034	Feb-17-2012

Table 3: Additional Test Equipment

Description	Serial Number	Cal Due Date
Power Supply 6623A	US37360826	Aug-22-2010
Signal Generator E4438C	MY45090104	Aug-22-2011
Amplifier ZHL-42-SMA	1040	
3 dB Attenuator 8491A	50581	Sep-04-2010
Directional Coupler 778D	18621	Sep-05-2010
Power Meter E4417A	MY45100481	Sep-01-2011
Power Sensor #1 – E9323A	MY44420341	Aug-25-2010
Power Sensor #2 - E9323A	MY44420342	Aug-25-2010
10 dB Attenuator 8491A	3929M50702	Oct-17-2010
Spectrum Analyzer E4403B	US39440480	Sep-12-2010
Power Splitter ZAPD-21-S(+)	SU327300437	

4. Validation

Validations of the DASY4 v4.7 test system were performed using the measurement equipment listed in Section 3.1. All validations occur in free space using the DASY4 test arch. Note that the 10 mm probe-to-dipole separation is measured from the top edge of the dipole to the calibration reference point of the probe. SPEAG uses the center point of the probe sensor(s) as the reference point when establishing targets for their dipoles. Therefore, because SPEAG’s dipoles and targets are used, it is appropriate to measure the 10 mm separation distance to the center of the sensors as they do. This reference point was used for validation only. Validations were performed at 835 MHz and/or 1880 MHz. These frequencies are within each operating band and are within 2 MHz of the mid-band frequency of the test device. The results obtained from the validations are displayed in the table below. The field contour plots are included in Appendix 2.

Validations were performed to verify that measured E-field and H-field values are within ±25% from the target reference values provided by the manufacturer (Ref: Appendix 7). Per Section 4.3.2.1 of the C63.19 standard, “Values within ±25% are acceptable, of which 12% is deviation and 13% is measurement uncertainty”. Therefore, the E-field and H-field dipole verification results shown in Table 4 are in accordance with the acceptable parameters defined by the standard.

Table 4: Dipole Measurement Summary

Date	f (MHz)	Dipole	Protocol	Input Power (mW)	E-Field Results (V/m)	Target for Dipole (V/m)	% Deviation
Jul-16-2010	835	1076	CW	100	167.00	164.8	+1.3%
Jul-22-2010	835	1076	CW	100	164.15	164.8	-0.4%
Jul-22-2010	1880	1034	CW	100	133.10	137.9	-3.5%

Date	f (MHz)	Dipole	Protocol	Input Power (mW)	E-Field Results (A/m)	Target for Dipole (A/m)	% Deviation
Jul-16-2010	835	1076	CW	100	0.466	0.459	+1.5%
Jul-16-2010	1880	1034	CW	100	0.449	0.468	-4.1%
Jul-22-2010	1880	1034	CW	100	0.459	0.468	-1.9%

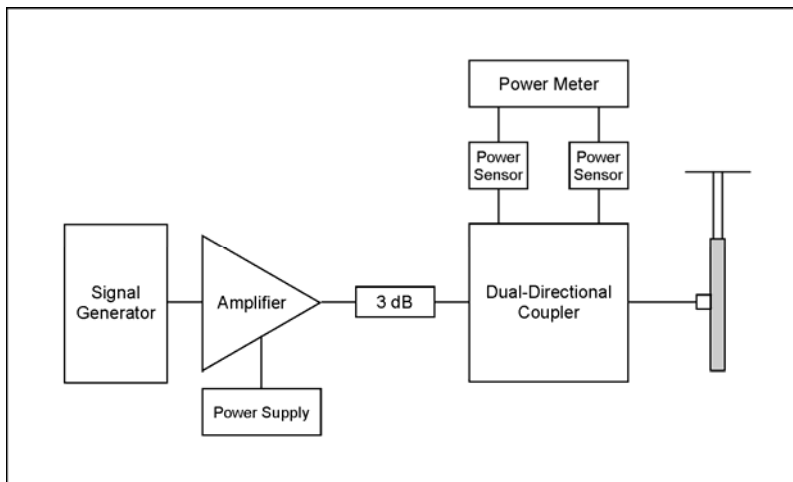

Figure 1: Setup for Validation measurements

5. Probe Modulation Factor

After every probe calibration, the response of the probe to each applicable modulated signal (CDMA, GSM, etc) must be assessed at the frequencies of operation. The response of the probe system to a CW field at each frequency of interest is compared to its response to a modulated signal with equal peak amplitude. For each PMF assessment, a signal generator was used to replace the original CW signal with the desired modulated signal. The PMF results applicable to this test document are shown in Table 5.

RF Field Probe Modulation Response was measured with the field probe and associated measurement equipment. The PMF was measured using a signal generator as follows:

1. Illuminate a dipole with a CW signal at the intended measured frequency.
2. Fix the probe at a set location relative to the dipole, typically located at the field reference point.
3. Record the reading of the probe measurement system of the CW signal.
4. Substitute a modulated signal of the same amplitude, using the same modulation as that used by the intended WD for the CW signal.
5. Record the reading of the probe measurement system of the modulated signal.
6. The ratio of the CW to modulated signal reading is the probe modulation factor.

Using a dual-directional coupler, the forward power and reverse power are measured and adjusted when connected to the dipole and spectrum analyzer through a power splitter and matched cables. The spectrum analyzer is used to set the peak amplitude of the modulated signal equal to the amplitude of the CW signal. The procedure used to ensure that the amplitudes are the same is given in Appendix 1. 0-Span spectrum plots for each signal type measured are also provided in Appendix 1.

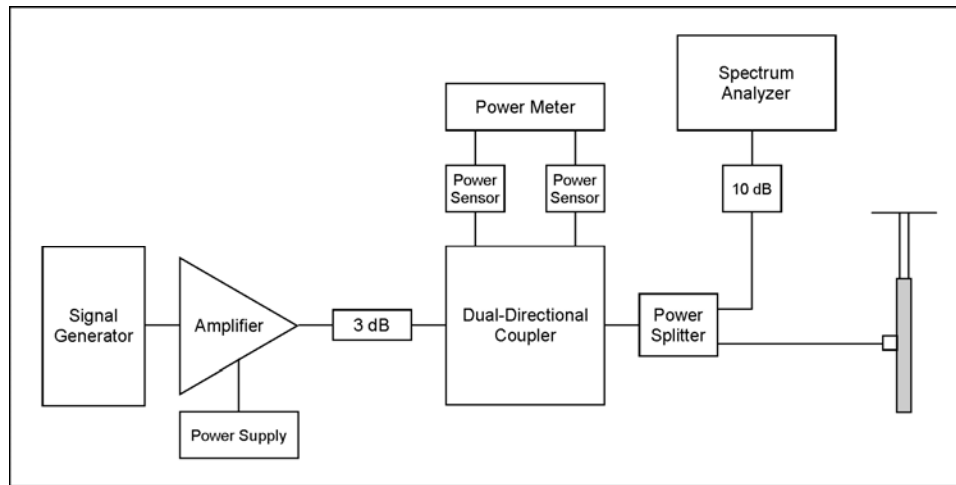

Figure 2: Setup for PMF measurements

When measuring PMFs for a GSM signal, a power level which results in a measured field strength approximately equal to the M3 category limit is used.

To measure the PMF for a CDMA, WCDMA, or iDEN signal, the modulated signal is injected into the dipole. When the peak power level produces a field strength less than or equal to the M3 category limit, this power level is used. If this peak power level produces a field strength much greater than the M3 category limit, a power level which produces a field strength approximately equal to the M3 category limit is used instead.

Table 5: PMF Measurement Summary

f (MHz)	Protocol	E-Field Probe SN 2248		H-Field Probe SN 6074	
		E-Field (V/m)	E-Field Modulation Factor	H-Field (A/m)	H-Field Modulation Factor
835	CW	338.3		0.8596	
	GSM	120.8	2.80	0.3650	2.36
1880	CW	85.51		0.2636	
	GSM	29.70	2.88	0.1023	2.58

f (MHz)	Protocol	E-Field Probe SN 2248		H-Field Probe SN 6074	
		E-Field (V/m)	E-Field Modulation Factor	H-Field (A/m)	H-Field Modulation Factor
835	CW	205.2		0.8170	
	WCDMA	228.2	0.90	0.9138	0.89
1880	CW	103.3		0.3584	
	WCDMA	115.0	0.90	0.3920	0.91

f (MHz)	Protocol	E-Field Probe SN 2248		H-Field Probe SN 6074	
		E-Field (V/m)	E-Field Modulation Factor	H-Field (A/m)	H-Field Modulation Factor
835	CW	129.4		0.5217	
	80% AM	80.82	1.60	0.3439	1.52
1880	CW	147.4		0.5088	
	80% AM	92.38	1.60	0.3520	1.45

6. Test Results

The phone was tested in normal configurations for the ear use. When applicable, configurations are tested with the antenna in its fully-extended position. These test configurations are tested at the high, middle and low frequency channels of each applicable operating band and mode; for example, GSM, CDMA, WCDMA, or iDEN.

The DUT's signal is the typical GMSK modulated signal used for GSM calls and connections in a cellular network. The signal was set up by creating and maintaining an over-the-air connection between the DUT and an Agilent 8960 Wireless Communications Test Set. This allows direct control over the DUT's cellular band, transmit channel and power step.

For Wideband CDMA, the signal was set up by creating and maintaining an over-the-air connection between the DUT and an Agilent 8960 Wireless Communications Test Set. The test equipment was configured to all "1's" for 12.2 kbps AMR.

The cellular phone model tested in this report uses the following default battery:

Battery #1 – SNN5819A – 1130 mAH Battery

The phone is placed in the HAC measurement system with a fully charged battery. At the end of each test the DASY™ system measures the drift of the field strength at a fixed reference point to ensure that the DUT has not changed in transmitter power.

The DASY4 v4.7 measurement system specified in section 3.1 was utilized within the intended operations as set by the SPEAG™ setup. The default settings for the grid spacing of the scan were set to 5mm as shown in the Field plots included in Appendix 2 and 3. The 5 cm x 5 cm area measurement grid is centered on the acoustic output of the device. The Test Arch provided by SPEAG is used to position the DUT. The pictures of the setup are included in Appendix 5. The WD reference plane is parallel to the device and contains the highest point on its contour in the area of the phone that normally rests against the user's ear. The measurement plane contains the center point of the probe sensor(s). The device is positioned such that the WD reference plane is located 15 mm from, and parallel to, the measurement plane. This is in accordance with section 4.4 of the standard, which states that "The WD reference plane is a plane parallel with the front "face" of the WD and containing the highest point on its contour in the area of the phone that normally rests against the user's ear."

During testing, the DUT is placed into a polystyrene block (3-pound expanded polystyrene) which is machined to precisely fit the DUT's shape. The test positioner, provided by SPEAG, is used to grip the block. This positioning conforms to the specifications given in the paragraph above. The addition of the block does not increase the uncertainty budget, which is provided in Appendix 4. The pictures of the measurement setup are included in Appendix 5.

The HAC Rating results for E-Field and H-field are shown in Tables 6 through 9. Also shown are the measured GSM-mode conducted output powers, the measured drifts, excluded areas, and the peak field values. PMF measurements are taken from Section 5. The worst-case test conditions are indicated with **bold numbers** in the tables and are detailed in Appendix 3: HAC distribution plots for E-Field and H-Field.

Drift was measured using the typical DASY4 v4.7 measurement routines. The field is measured at the reference location (center of the ear piece) at the beginning of the test. After completion of the E-field or H-field measurement, the probe returns to the same reference location and takes another measurement. The drift is the delta between these two values and is included in the test report scans.

Per SPEAG's recommendation, the phone plots in Appendix 3 use the following standard transmitter ratios as "Duty Cycle": 1:8 for GSM transmitters; 1:1 for full-rate CDMA and 1:8 for 1/8th rate CDMA; 1:1 for WCDMA; 1:6 for 1:6th rate iDEN and 1:3 for 2:6th rate iDEN. Per SPEAG's recommendation, in order to account for probe modulation response, PMF is applied during post-processing of the measured data in SEMCAD. PMF also appears in the phone plots in Appendix 3.

DUT Emissions Limits (AWF = -5) f < 960 MHz		DUT Emissions Limits (AWF = -5) f > 960 MHz	
Rating	E-Field	Rating	E-Field
M3	149.6 – 266.1 V/m	M3	47.3 – 84.1 V/m
M4	< 149.6 V/m	M4	< 47.3 V/m

Table 6: HAC E-Field measurement results for the portable cellular telephone at highest possible output power.

Frequency Band (MHz)	Channel Setting	Conducted Output Power (dBm)	Measured PMF	Drift (dB)	Excluded Cells	Peak Field (V/m)	Rating
GSM 850	128	33.02	2.80	0.067	8,9	180.1	M3
	190	32.87		0.058	8,9	178.0	M3
	251	32.89		0.000	8,9	185.8	M3
GSM 1900	512	31.04	2.88	0.048	8,9	81.0	M3
	661	30.95		-0.029	8,9	80.7	M3
	810	30.83		0.027	8,9	75.9	M3

DUT Emissions Limits (AWF = 0) f < 960 MHz		DUT Emissions Limits (AWF = 0) f > 960 MHz	
Rating	E-Field	Rating	E-Field
M3	199.5 – 354.8 V/m	M3	63.1 – 112.2 V/m
M4	< 199.5 V/m	M4	< 63.1 V/m

Table 7: HAC E-Field measurement results for the portable cellular telephone at highest possible output power.

Frequency Band (MHz)	Channel Setting	Measured PMF	Drift (dB)	Excluded Cells	Peak Field (V/m)	Rating
WCDMA 850	4132	0.90	0.050	8,9	58.7	M4
	4180		-0.061	8,9	68.2	M4
	4233		0.024	8,9	65.5	M4
WCDMA 1900	9262	0.90	-0.146	8,9	34.1	M4
	9400		-0.142	8,9	41.9	M4
	9538		-0.057	8,9	42.7	M4

DUT Emissions Limits (AWF = -5) f < 960 MHz		DUT Emissions Limits (AWF = -5) f > 960 MHz	
Rating	H-Field	Rating	H-Field
M3	0.45 – 0.80 A/m	M3	0.14 – 0.25 A/m
M4	< 0.45 A/m	M4	< 0.14 A/m

Table 8: HAC H-Field measurement results for the portable cellular telephone at highest possible output power.

Frequency Band (MHz)	Channel Setting	Conducted Output Power (dBm)	Measured PMF	Drift (dB)	Excluded Cells	Peak Field (A/m)	Rating
GSM 850	128	33.02	2.36	-0.172	1,4,7	0.197	M4
	190	32.87		-0.051	1,4,7	0.199	M4
	251	32.89		0.072	1,4,7	0.211	M4
GSM 1900	512	31.04	2.58	0.046	1,2,3	0.213	M3
	661	30.95		-0.011	1,2,3	0.204	M3
	810	30.83		-0.009	1,2,3	0.181	M3

DUT Emissions Limits (AWF = 0) f < 960 MHz		DUT Emissions Limits (AWF = 0) f > 960 MHz	
Rating	H-Field	Rating	H-Field
M3	0.60 – 1.07 A/m	M3	0.19 – 0.34 A/m
M4	< 0.60 A/m	M4	< 0.19 A/m

Table 9: HAC H-Field measurement results for the portable cellular telephone at highest possible output power.

Frequency Band (MHz)	Channel Setting	Measured PMF	Drift (dB)	Excluded Cells	Peak Field (V/m)	Rating
WCDMA 850	4132	0.89	0.034	1,4,7	0.070	M4
	4180		-0.249	1,4,7	0.083	M4
	4233		-0.049	1,4,7	0.083	M4
WCDMA 1900	9262	0.91	0.122	1,2,3	0.102	M4
	9400		0.038	1,2,3	0.102	M4
	9538		-0.031	1,2,3	0.103	M4

7. Measurements for Certification of 3G Devices

For WCDMA devices, 12.2 kbps RMC and 12.2 kbps AMR modes are considered. The conducted power measurements for each mode are shown in the table below.

Conducted power (dBm) for WCDMA modes			
	Channel	RMC	AMR
WCDMA 850	4132	24.05	24.14
	4180	23.99	24.01
	4233	23.90	23.81
WCDMA 1900	9262	24.08	23.99
	9400	23.91	23.81
	9538	23.81	23.64

Appendix 1

Details justifying the conversion to peak

A1.1 Procedure for PMF measurements

1. Set up and calibrate the HAC validation rack as noted in Figure 2; a power splitter is connected to the dual-directional coupler, which is then connected to both the spectrum analyzer and dipole on the output side of the splitter using matched cables. This cabling arrangement will remain in place throughout the following steps.
2. Command the HAC validation rack as you would for a normal CW HAC validation with forward power per Table A1 for the mode, frequency, and field probe type of interest.
3. Set up the dipole and phantom as you would for a normal CW HAC validation.
4. In the DASY software, open appropriate job template and verify the following parameters:
Medium = "Air";
Communication System = "HAC – Dipole";
Ensure the proper probe & DAE are installed and laser aligned
5. **Measure the CW signal:** With the CW signal transmitting through the dipole, command the DASY system to run the appropriate field measurement job.
6. Do **not** turn off the signal generator power.
7. **Setting the CW Reference Level on the Spectrum Analyzer:**
 - a. Set up the Spectrum Analyzer for the following Settings:
Frequency: Freq. being tested (EX: 835/1880)
Span: Zero Span
Res BW: iDEN – 100 kHz; GSM – 300 kHz; CDMA – 3 MHz; WCDMA – 5 MHz;
Video BW: iDEN – 300 kHz; GSM – 1MHz; CDMA and WCDMA – 30 kHz**;
Sweep Time: 20 ms; 120 ms for iDEN
Scale: 1 dB
Detector: PEAK / Manual
 - b. Adjust the REF level until the CW signal is aligned with the Center Line (approx. 15 dB). NOTE: After this point, the Reference Line must remain fixed. Do not change it.
8. **Measure the modulated signal(s):**
 - a. Command the signal generator to the desired modulation.
 - b. Set the Spectrum Analyzer Sweep Time to 20 ms.
 - c. Adjust the amplitude of the power on the signal generator so that the PEAK of the modulated signal is at the CW Reference Line:
 - i. On the Spectrum Analyzer, press the [View Trace] button and then select (Max Hold), this will show only the Peak output.
 - ii. Press (Clear Write) and then (Max Hold) each time an amplitude adjustment is made.
 - d. Allow the Max Hold line to stabilize. Then check that the highest peak of the Max Hold line corresponds with the CW Reference Line (without going over). If not correct, repeat the steps beginning with step 8c.
9. Command the DASY system to run the appropriate field measurement job.
10. Repeat steps 2 through 9 until all PMF measurements have been completed.

**The use of 30 kHz VBW is validated. The power measurements are verified using an average power meter.

Table A1: PMF Measurement, CW Signal Dipole Input Power

Mode	f (MHz)	Field Probe Type	Dipole Input Power	Notes
80% AM	813	E and H	100 mW	
	835			
	898			
	1730			
	1880			
CDMA (Full & 1/8 th)	835	E and H	320 mW	1
	1730		50 mW	2
	1880		50 mW	2
WCDMA	835	E and H	250 mW	1
	1730		50 mW	2
	1880		50 mW	2
GSM	835	E-Field	690 mW	2
		H-Field	270 mW	2
	1880	E-Field	35 mW	2
		H-Field	27 mW	2
iDEN (1:6 & 2:6)	813	E-Field	640 mW	1
		H-Field	460 mW	2
	898	E-Field	640 mW	1
		H-Field	580 mW	2

Note 1: The power level shown represents the typical DUT peak power level for this configuration.

Note 2: The typical peak power level for this configuration results in a field strength significantly higher than the relevant M3 category limit field strength, and is therefore not realistic. The power level shown results in a field strength approximating the M3 category limit value.

A1.2 0-Span Spectrum Plots for PMF measurements

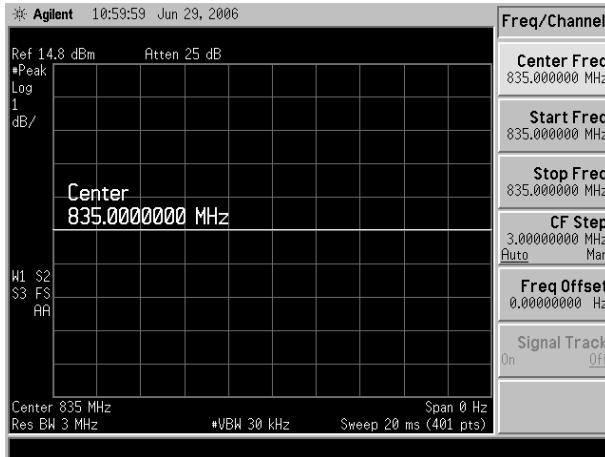

CW 835 MHz

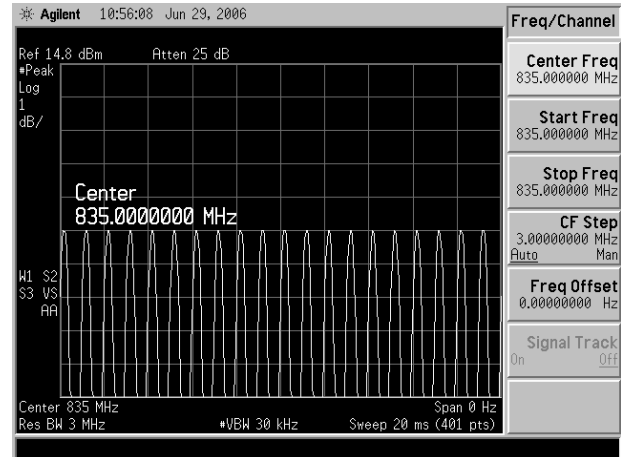

80% AM 835 MHz

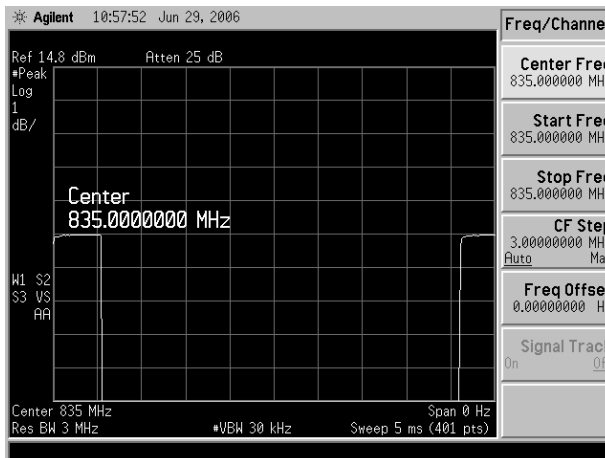

GSM 835 MHz

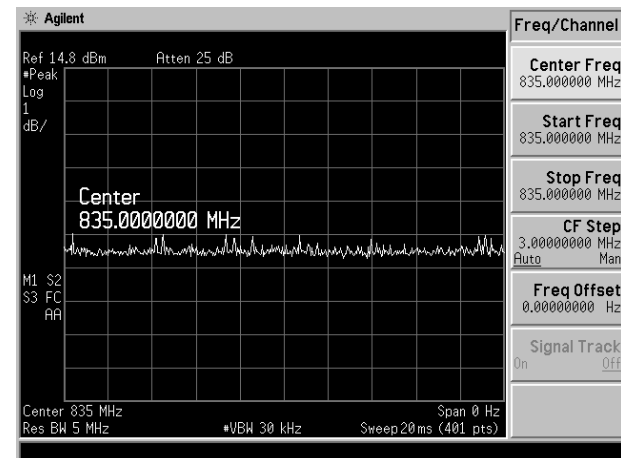

WCDMA 835 MHz

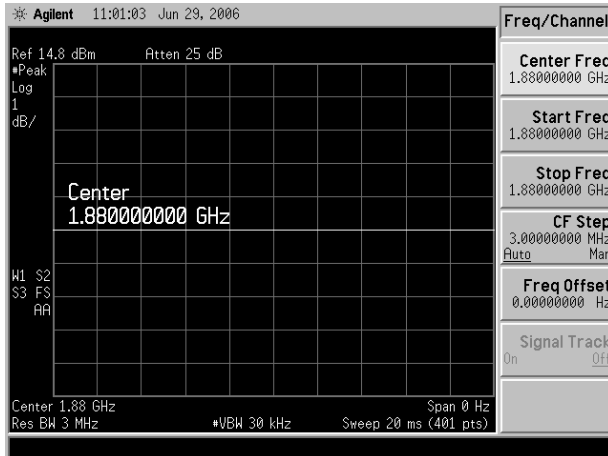

CW 1880 MHz

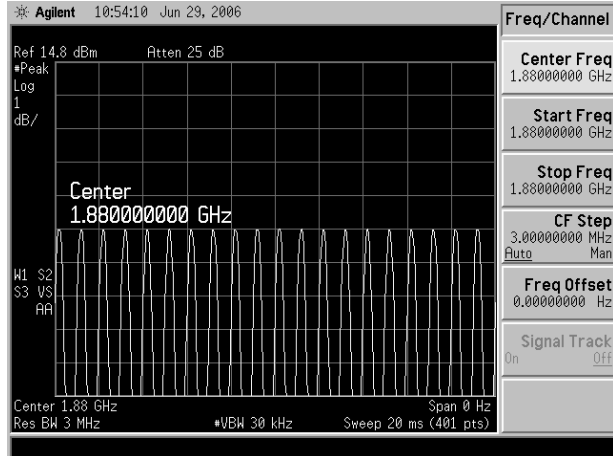

80% AM 1880 MHz

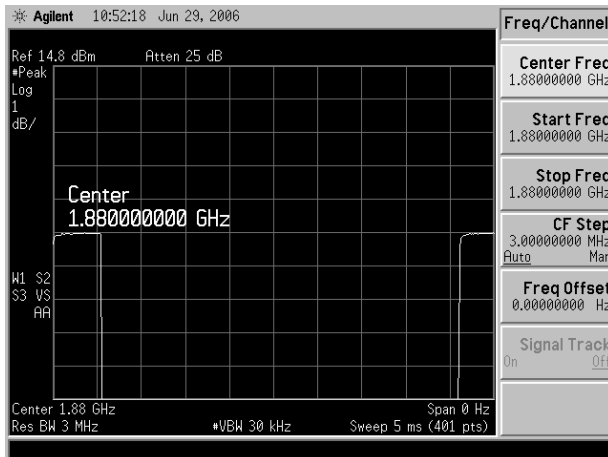

GSM 1880 MHz

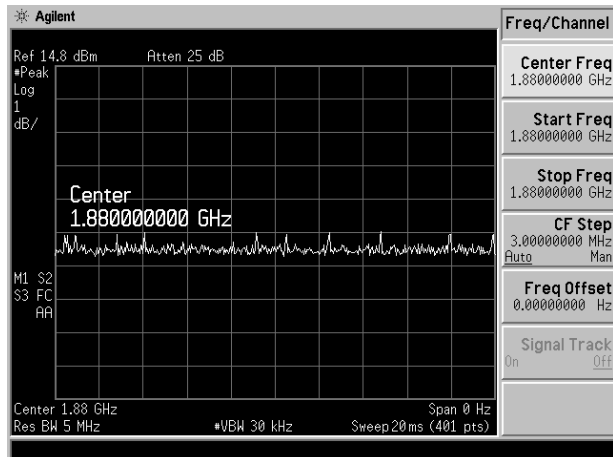

WCDMA 1880 MHz

Appendix 2

HAC distribution plots for Validation

Test Laboratory: Motorola - Jul-16-2010 835 MHz E-Field

DUT: HAC-Dipole 835 MHz; Type: CD835V3; Serial: 1076; FCC ID: IHDT56LD1

Procedure Notes: 835 MHz HAC Validation; Dipole Sn# 1076; Input Power = 100 mW

Communication System: CW - HAC; Frequency: 835 MHz; Duty Cycle: 1:1

Medium: Air; Medium parameters used: $\sigma = 0$ mho/m, $\epsilon_r = 1$; $\rho = 0$ kg/m³

DASY4 Configuration:

- Probe: ER3DV6R - SN2244; ConvF(1, 1, 1); Calibrated: 5/11/2010
- Sensor-Surface: 0mm (Fix Surface)Sensor-Surface: (Fix Surface)
- Electronics: DAE4 Sn387; Calibrated: 5/19/2010
- Phantom: R-3, HAC Test Arch (rev.2); Type: SD HAC P01 BA; Serial: 1071;
- Measurement SW: DASY4, V4.7 Build 80; Postprocessing SW: SEMCAD, V1.8 Build 186

E Scan - Probe center 10mm above Dipole/Hearing Aid Compatibility Test (41x361x1):

Measurement grid: dx=5mm, dy=5mm; Probe Modulation Factor = 1.00

Device Reference Point: 0.000, 0.000, -6.30 mm; Reference Value = 106.2 V/m; Power Drift = 0.000 dB

Maximum value of Total (interpolated) = 174.8 V/m

Average value of Total (interpolated) = $(174.8 + 159.2) / 2 = 167.0$ V/m

Peak E-field in V/m

Grid 1 156.5 M4	Grid 2 159.2 M4	Grid 3 156.8 M4
Grid 4 84.4 M4	Grid 5 85.9 M4	Grid 6 83.1 M4
Grid 7 159.4 M4	Grid 8 174.8 M4	Grid 9 174.4 M4

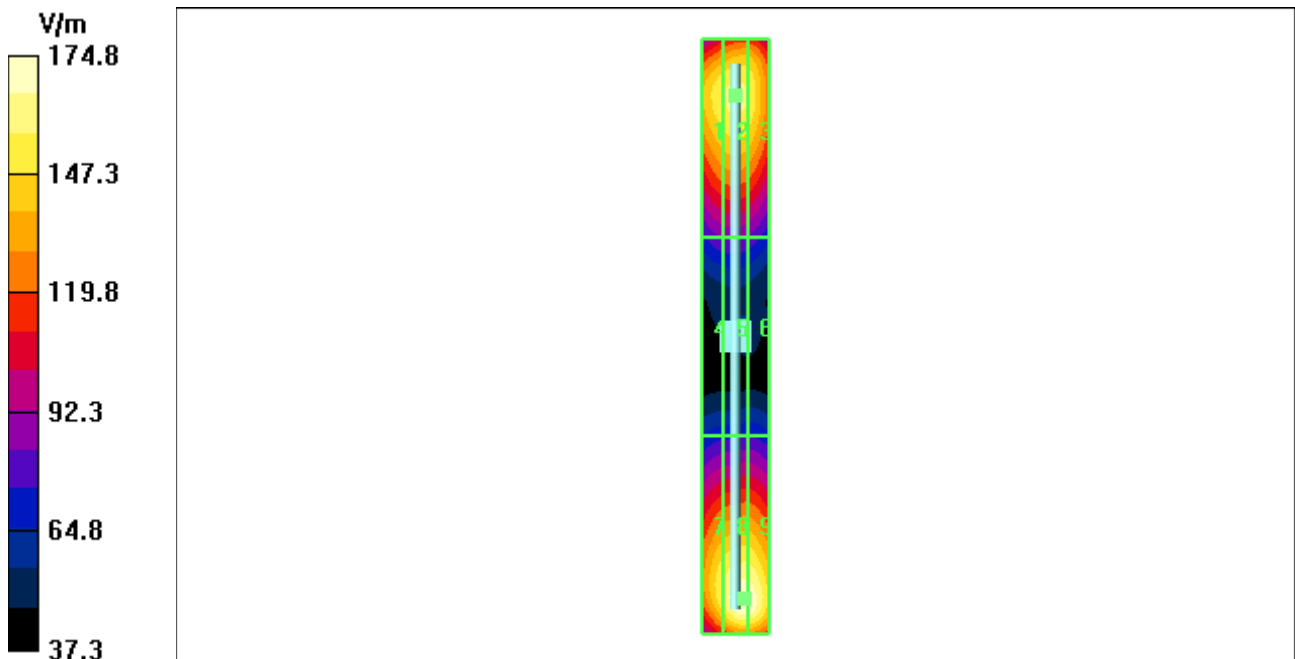

Test Laboratory: Motorola - Jul-22-2010 835 MHz E-Field

DUT: HAC-Dipole 835 MHz; Type: CD835V3; Serial: 1076; FCC ID: IHDT56LD1

Procedure Notes: 835 MHz HAC Validation; Dipole Sn# 1076; Input Power = 100 mW

Communication System: CW - HAC; Frequency: 835 MHz; Duty Cycle: 1:1

Medium: Air; Medium parameters used: $\sigma = 0$ mho/m, $\epsilon_r = 1$; $\rho = 0$ kg/m³

DASY4 Configuration:

- Probe: ER3DV6R - SN2244; ConvF(1, 1, 1); Calibrated: 5/11/2010
- Sensor-Surface: 0mm (Fix Surface)Sensor-Surface: (Fix Surface)
- Electronics: DAE4 Sn387; Calibrated: 5/19/2010
- Phantom: R-3, HAC Test Arch (rev.2); Type: SD HAC P01 BA; Serial: 1071;
- Measurement SW: DASY4, V4.7 Build 80; Postprocessing SW: SEMCAD, V1.8 Build 186

E Scan - Probe center 10mm above Dipole/Hearing Aid Compatibility Test (41x361x1):

Measurement grid: dx=5mm, dy=5mm; Probe Modulation Factor = 1.00

Device Reference Point: 0.000, 0.000, -6.30 mm; Reference Value = 101.7 V/m; Power Drift = -0.046 dB

Maximum value of Total (interpolated) = 166.4 V/m

Average value of Total (interpolated) = $(166.4 + 161.9) / 2 = 164.15$ V/m

Peak E-field in V/m

Grid 1 159.5 M4	Grid 2 161.9 M4	Grid 3 159.3 M4
Grid 4 85.1 M4	Grid 5 86.5 M4	Grid 6 83.8 M4
Grid 7 152.5 M4	Grid 8 166.4 M4	Grid 9 165.9 M4

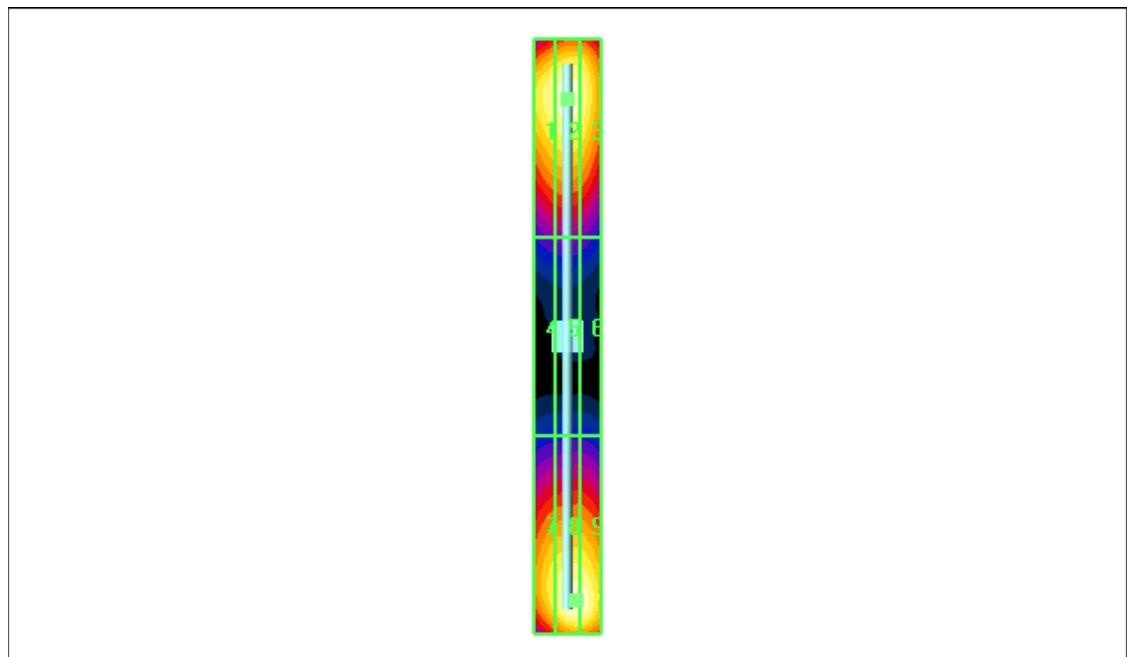
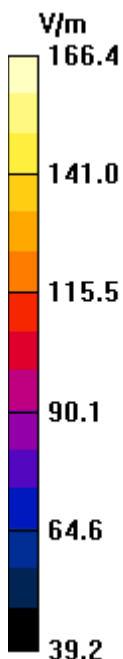

Test Laboratory: Motorola - Jul-22-2010 1800 MHz E-Field

DUT: HAC Dipole 1880 MHz; Type: CD1880V3; Serial: 1034; FCC ID: IHDT56LD1

Procedure Notes: 1880 MHz HAC Validation; Dipole Sn# 1034; Input Power = 100 mW

Communication System: CW - HAC; Frequency: 1880 MHz; Duty Cycle: 1:1

Medium: Air; Medium parameters used: $\sigma = 0$ mho/m, $\epsilon_r = 1$; $\rho = 0$ kg/m³

DASY4 Configuration:

- Probe: ER3DV6R - SN2244; ConvF(1, 1, 1); Calibrated: 5/11/2010
- Sensor-Surface: 0mm (Fix Surface)Sensor-Surface: (Fix Surface)
- Electronics: DAE4 Sn387; Calibrated: 5/19/2010
- Phantom: R-3, HAC Test Arch (rev.2); Type: SD HAC P01 BA; Serial: 1071;
- Measurement SW: DASY4, V4.7 Build 80; Postprocessing SW: SEMCAD, V1.8 Build 186

E Scan - Probe center 10mm above Dipole/Hearing Aid Compatibility Test (41x181x1):

Measurement grid: dx=5mm, dy=5mm; Probe Modulation Factor = 1.00

Device Reference Point: 0.000, 0.000, -6.30 mm; Reference Value = 156.5 V/m; Power Drift = 0.012 dB

Maximum value of Total (interpolated) = 138.4 V/m

Average value of Total (interpolated) = $(138.4 + 127.8) / 2 = 133.1$ V/m

Peak E-field in V/m

Grid 1 124.9 M2	Grid 2 127.8 M2	Grid 3 125.4 M2
Grid 4 87.0 M3	Grid 5 89.0 M3	Grid 6 86.2 M3
Grid 7 129.0 M2	Grid 8 138.4 M2	Grid 9 136.8 M2

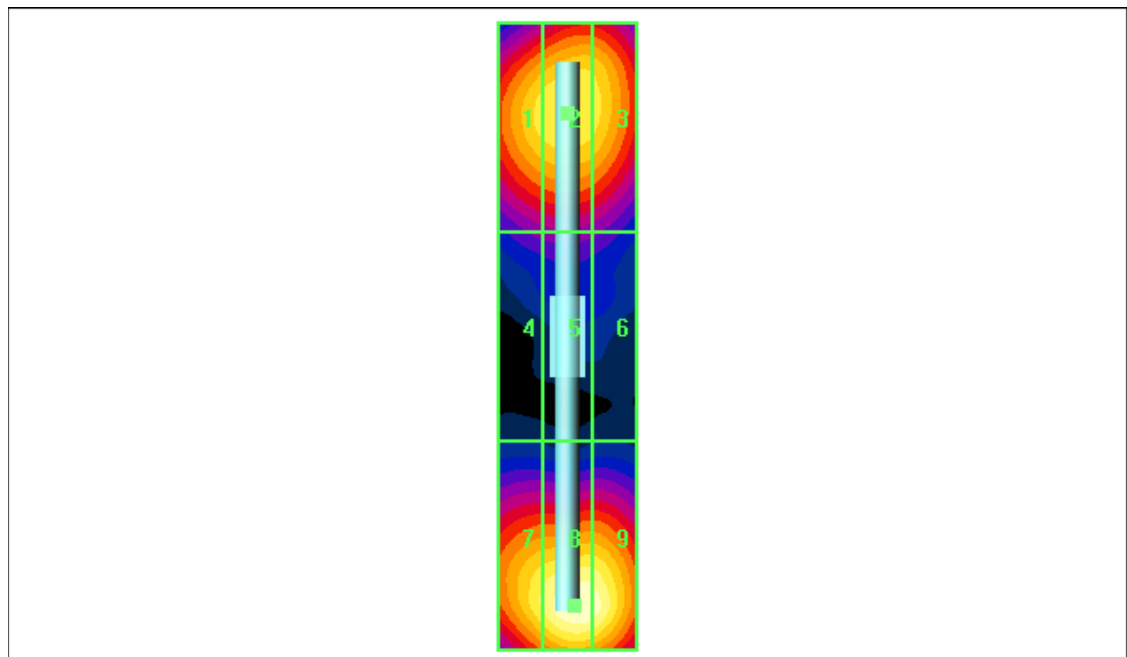
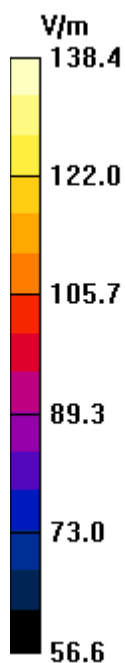

Test Laboratory: Motorola - Jul-16-2010 835 MHz H-Field

DUT: HAC-Dipole 835 MHz; Type: CD835V3; Serial: 1076; FCC ID: IHDT56LD1

Procedure Notes: 835 MHz HAC Validation; Dipole Sn# 1076; Input Power = 100 mW

Communication System: CW - HAC; Frequency: 835 MHz; Duty Cycle: 1:1

Medium: Air; Medium parameters used: $\sigma = 0$ mho/m, $\epsilon_r = 1$; $\rho = 0$ kg/m³

DASY4 Configuration:

- Probe: H3DV6 - SN6078; ; Calibrated: 5/11/2010
- Sensor-Surface: 0mm (Fix Surface)Sensor-Surface: (Fix Surface)
- Electronics: DAE4 Sn650; Calibrated: 5/20/2010
- Phantom: R-3, HAC Test Arch (rev.2); Type: SD HAC P01 BA; Serial: 1071;
- Measurement SW: DASY4, V4.7 Build 80; Postprocessing SW: SEMCAD, V1.8 Build 186

H Scan - Probe center 10mm above Dipole/Hearing Aid Compatibility Test (41x361x1):

Measurement grid: dx=5mm, dy=5mm; Probe Modulation Factor = 1.00

Device Reference Point: 0.000, 0.000, -6.30 mm; Reference Value = 0.489 A/m; Power Drift = 0.008 dB

Maximum value of Total (interpolated) = 0.466 A/m

Peak H-field in A/m

Grid 1 0.384 M4	Grid 2 0.422 M4	Grid 3 0.412 M4
Grid 4 0.420 M4	Grid 5 0.466 M4	Grid 6 0.458 M4
Grid 7 0.371 M4	Grid 8 0.415 M4	Grid 9 0.406 M4

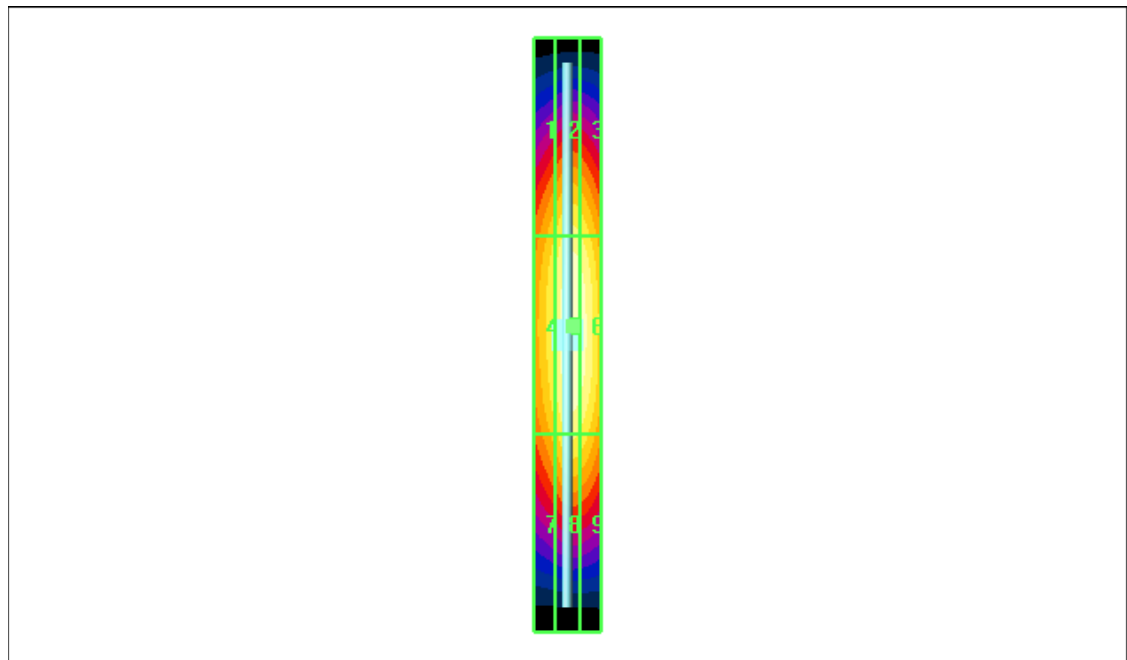
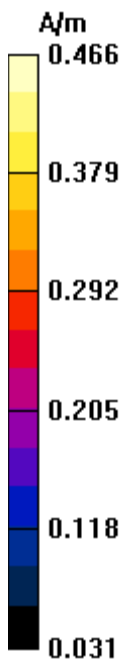

Test Laboratory: Motorola - Jul-16-2010 1880 MHz H-Field

DUT: HAC Dipole 1880 MHz; Type: CD1880V3; Serial: 1034; FCC ID: IHDT56LD1

Procedure Notes: 1880 MHz HAC Validation; Dipole Sn# 1034; Input Power = 100 mW

Communication System: CW - HAC; Frequency: 1880 MHz; Duty Cycle: 1:1

Medium: Air; Medium parameters used: $\sigma = 0$ mho/m, $\epsilon_r = 1$; $\rho = 0$ kg/m³

DASY4 Configuration:

- Probe: H3DV6 - SN6078; ; Calibrated: 5/11/2010
- Sensor-Surface: 0mm (Fix Surface)Sensor-Surface: (Fix Surface)
- Electronics: DAE4 Sn650; Calibrated: 5/20/2010
- Phantom: R-3, HAC Test Arch (rev.2); Type: SD HAC P01 BA; Serial: 1071;
- Measurement SW: DASY4, V4.7 Build 80; Postprocessing SW: SEMCAD, V1.8 Build 186

H Scan - Probe center 10mm above Dipole/Hearing Aid Compatibility Test (41x181x1):

Measurement grid: dx=5mm, dy=5mm; Probe Modulation Factor = 1.00

Device Reference Point: 0.000, 0.000, -6.30 mm; Reference Value = 0.470 A/m; Power Drift = -0.010 dB

Maximum value of Total (interpolated) = 0.449 A/m

Peak H-field in A/m

Grid 1 0.385 M2	Grid 2 0.417 M2	Grid 3 0.409 M2
Grid 4 0.413 M2	Grid 5 0.449 M2	Grid 6 0.441 M2
Grid 7 0.368 M2	Grid 8 0.401 M2	Grid 9 0.392 M2

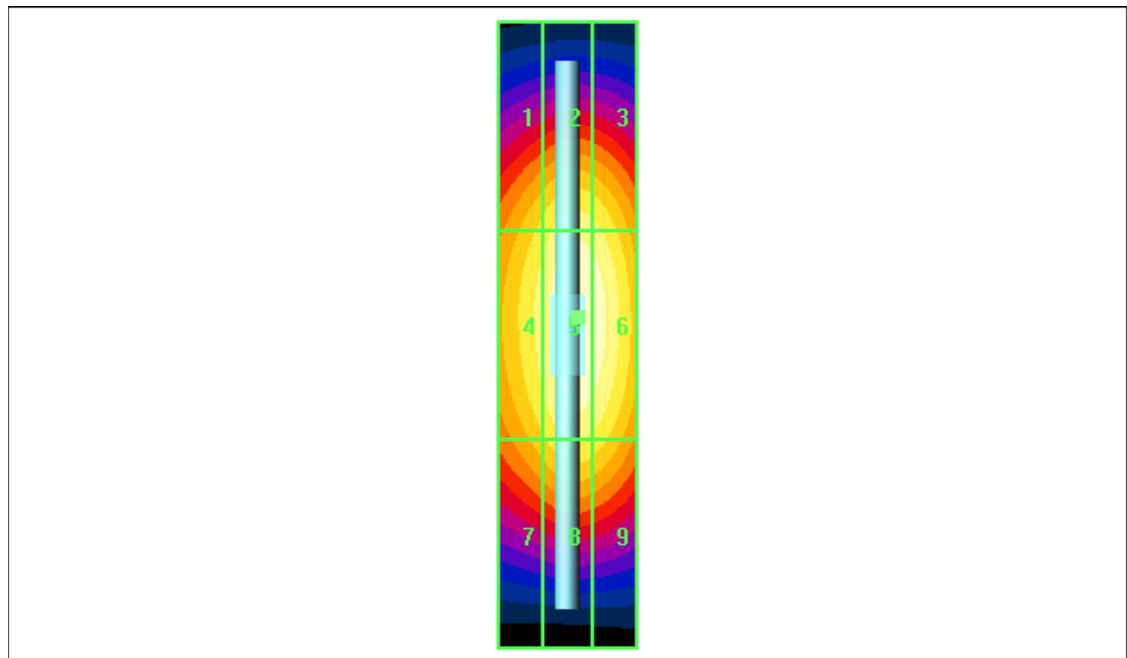
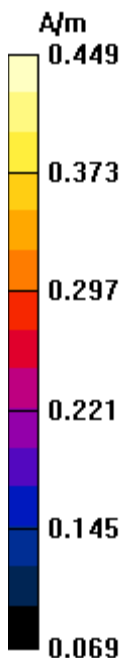

Test Laboratory: Motorola - Jul-22-2010 1880 MHz H-Field

DUT: HAC Dipole 1880 MHz; Type: CD1880V3; Serial: 1034; FCC ID: IHDT56LD1

Procedure Notes: 1880 MHz HAC Validation; Dipole Sn# 1034; Input Power = 100 mW

Communication System: CW - HAC; Frequency: 1880 MHz; Duty Cycle: 1:1

Medium: Air; Medium parameters used: $\sigma = 0$ mho/m, $\epsilon_r = 1$; $\rho = 0$ kg/m³

DASY4 Configuration:

- Probe: H3DV6 - SN6078; ; Calibrated: 5/11/2010
- Sensor-Surface: 0mm (Fix Surface)Sensor-Surface: (Fix Surface)
- Electronics: DAE4 Sn650; Calibrated: 5/20/2010
- Phantom: R-3, HAC Test Arch (rev.2); Type: SD HAC P01 BA; Serial: 1071;
- Measurement SW: DASY4, V4.7 Build 80; Postprocessing SW: SEMCAD, V1.8 Build 186

H Scan - Probe center 10mm above Dipole/Hearing Aid Compatibility Test (41x181x1):

Measurement grid: dx=5mm, dy=5mm; Probe Modulation Factor = 1.00

Device Reference Point: 0.000, 0.000, -6.30 mm; Reference Value = 0.484 A/m; Power Drift = -0.004 dB

Maximum value of Total (interpolated) = 0.459 A/m

Peak H-field in A/m

Grid 1 0.398 M2	Grid 2 0.427 M2	Grid 3 0.417 M2
Grid 4 0.426 M2	Grid 5 0.459 M2	Grid 6 0.447 M2
Grid 7 0.379 M2	Grid 8 0.410 M2	Grid 9 0.398 M2

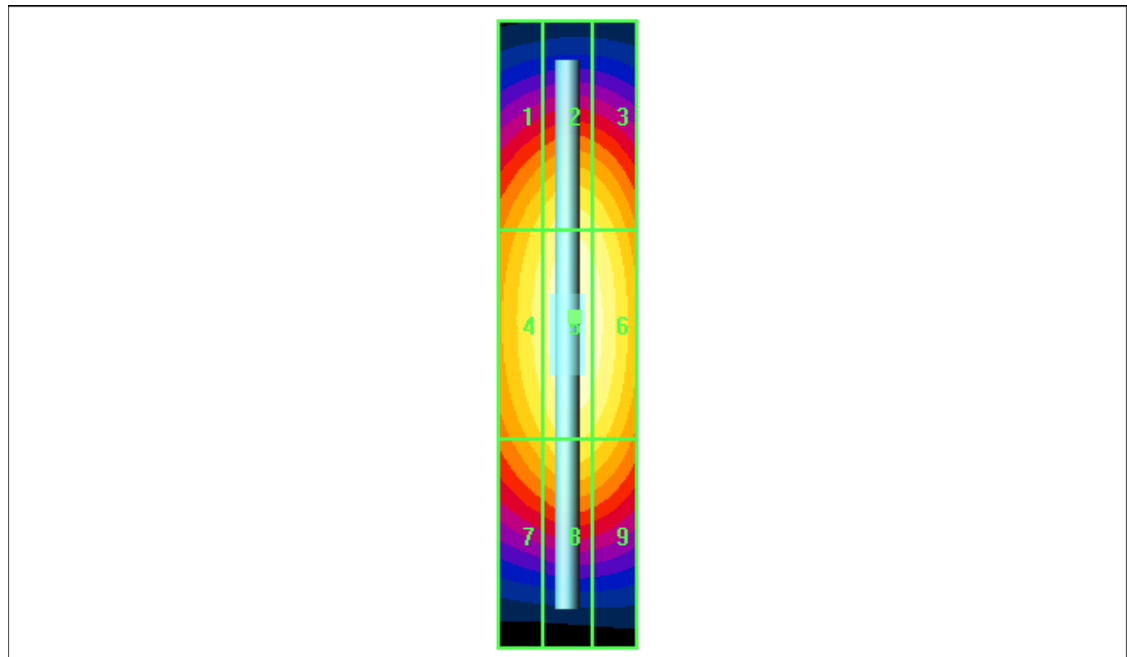
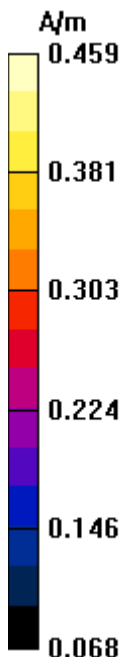

Appendix 3

HAC distribution plots for E-Field and H-Field

Test Laboratory: Motorola - GSM 850 E-Field

Serial: 358342030037299; FCC ID: IHDT56LD1

Procedure Notes: Pwr Step: 5; Antenna Position: Internal; Accessory Model #: N/A

Battery Model #: SNN5819B; PMF Value: 2.76; Positioner: Polystyrene Block

Communication System: GSM 850; Frequency: 848.8 MHz; Channel Number: 251; Duty Cycle: 1:8.3

Medium: Air; Medium parameters used: $\sigma = 0$ mho/m, $\epsilon_r = 1$; $\rho = 0$ kg/m³

DASY4 Configuration:

- Probe: ER3DV6R - SN2244; ConvF(1, 1, 1); Calibrated: 5/11/2010
- Sensor-Surface: (Fix Surface)
- Electronics: DAE4 Sn387; Calibrated: 5/19/2010
- Phantom: R-3, HAC Test Arch (rev.2); Type: SD HAC P01 BA; Serial: 1071;
- Measurement SW: DASY4, V4.7 Build 80; Postprocessing SW: SEMCAD, V1.8 Build 186

E Scan - Sensor center 15mm above WD, Hearing Aid Compatibility Test (101x101x1):

Measurement grid: dx=5mm, dy=5mm

Maximum value of peak Total field = 185.8 V/m; Probe Modulation Factor = 2.76

Device Reference Point: 0.000, 0.000, -6.30 mm; Reference Value = 83.2 V/m; Power Drift = 0.000 dB

Hearing Aid Near-Field Category: **M3 (AWF -5 dB)**

Peak E-field in V/m

Grid 1 155.3 M3	Grid 2 178.7 M3	Grid 3 177.5 M3
Grid 4 162.1 M3	Grid 5 185.8 M3	Grid 6 184.7 M3
Grid 7 166.2 M3	Grid 8 185.1 M3	Grid 9 184.1 M3

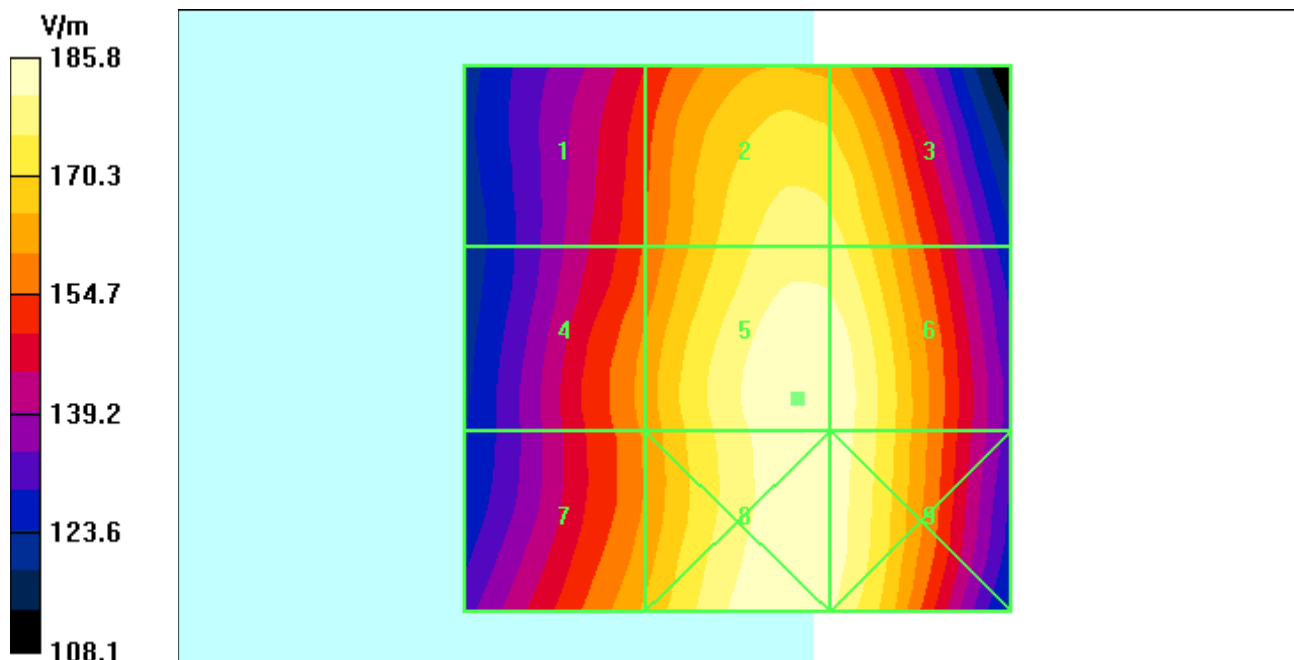

Test Laboratory: Motorola - GSM 1900 E-Field

Serial: 358342030037299; FCC ID: IHDT56LD1

Procedure Notes: Pwr Step: 0; Antenna Position: Internal; Accessory Model #: N/A

Battery Model #: SNN5819B; PMF Value: 2.84; Positioner: Polystyrene Block

Communication System: GSM 1900; Frequency: 1850.2 MHz; Channel Number: 512; Duty Cycle: 1:8.3

Medium: Air; Medium parameters used: $\sigma = 0$ mho/m, $\epsilon_r = 1$; $\rho = 0$ kg/m³

DASY4 Configuration:

- Probe: ER3DV6R - SN2244; ConvF(1, 1, 1); Calibrated: 5/11/2010
- Sensor-Surface: (Fix Surface)
- Electronics: DAE4 Sn387; Calibrated: 5/19/2010
- Phantom: R-3, HAC Test Arch (rev.2); Type: SD HAC P01 BA; Serial: 1071;
- Measurement SW: DASY4, V4.7 Build 80; Postprocessing SW: SEMCAD, V1.8 Build 186

E Scan - Sensor center 15mm above WD, Hearing Aid Compatibility Test (101x101x1):

Measurement grid: dx=5mm, dy=5mm

Maximum value of peak Total field = 81.0 V/m; Probe Modulation Factor = 2.84

Device Reference Point: 0.000, 0.000, -6.30 mm; Reference Value = 24.4 V/m; Power Drift = 0.048 dB

Hearing Aid Near-Field Category: M3 (AWF -5 dB)

Peak E-field in V/m

Grid 1	Grid 2	Grid 3
74.6 M3	81.0 M3	80.3 M3
Grid 4	Grid 5	Grid 6
48.5 M3	75.5 M3	76.4 M3
Grid 7	Grid 8	Grid 9
60.2 M3	88.5 M2	88.5 M2

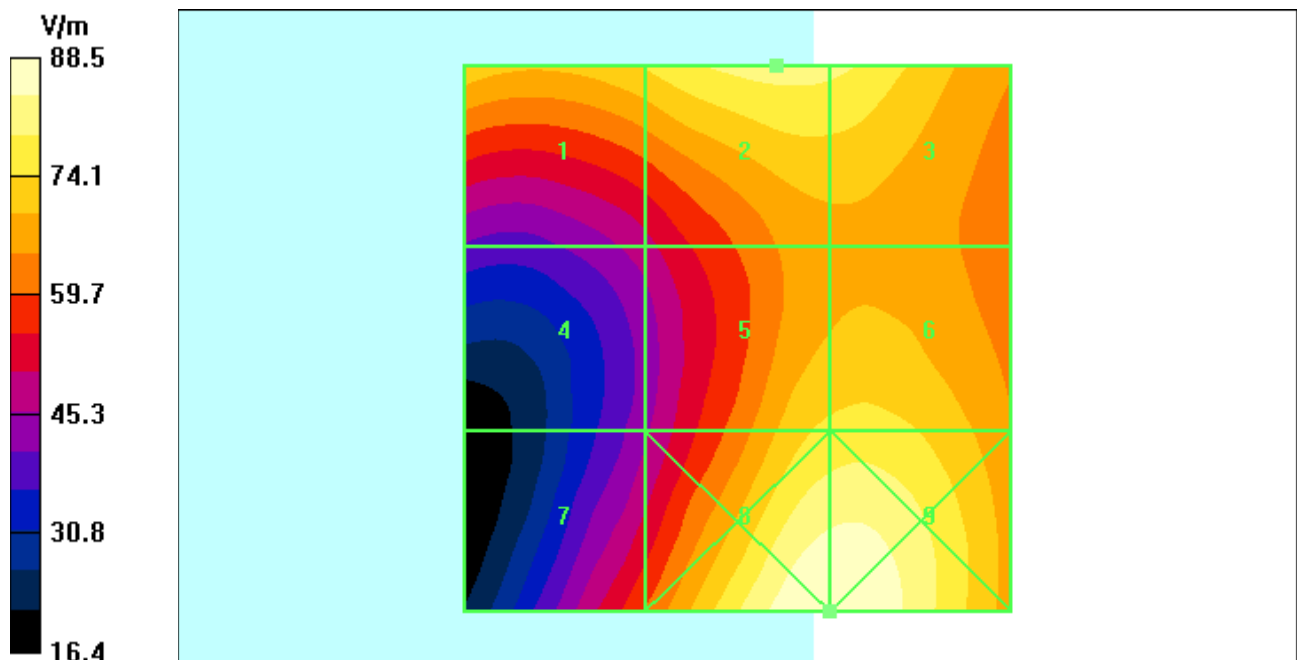

Test Laboratory: Motorola - WCDMA 850 E-Field

Serial: 358342030037299; FCC ID: IHDT56LD1

Procedure Notes: Pwr Step: All up Bits; Antenna Position: Internal; Accessory Model #: N/A

Battery Model #: SNN5819B; PMF Value: 0.91; Positioner: Polystyrene Block

Communication System: WCDMA 850; Frequency: 836 MHz; Channel Number: 4180; Duty Cycle: 1:1

Medium: Air; Medium parameters used: $\sigma = 0$ mho/m, $\epsilon_r = 1$; $\rho = 0$ kg/m³

DASY4 Configuration:

- Probe: ER3DV6R - SN2244; ConvF(1, 1, 1); Calibrated: 5/11/2010
- Sensor-Surface: (Fix Surface)
- Electronics: DAE4 Sn387; Calibrated: 5/19/2010
- Phantom: R-3, HAC Test Arch (rev.2); Type: SD HAC P01 BA; Serial: 1071;
- Measurement SW: DASY4, V4.7 Build 80; Postprocessing SW: SEMCAD, V1.8 Build 186

E Scan - Sensor center 15mm above WD, Hearing Aid Compatibility Test (101x101x1):

Measurement grid: dx=5mm, dy=5mm

Maximum value of peak Total field = 68.2 V/m; Probe Modulation Factor = 0.910

Device Reference Point: 0.000, 0.000, -6.30 mm; Reference Value = 91.2 V/m; Power Drift = -0.061 dB

Hearing Aid Near-Field Category: M4 (AWF 0 dB)

Peak E-field in V/m

Grid 1 58.2 M4	Grid 2 66.1 M4	Grid 3 65.9 M4
Grid 4 59.9 M4	Grid 5 68.2 M4	Grid 6 67.9 M4
Grid 7 60.2 M4	Grid 8 67.8 M4	Grid 9 67.4 M4

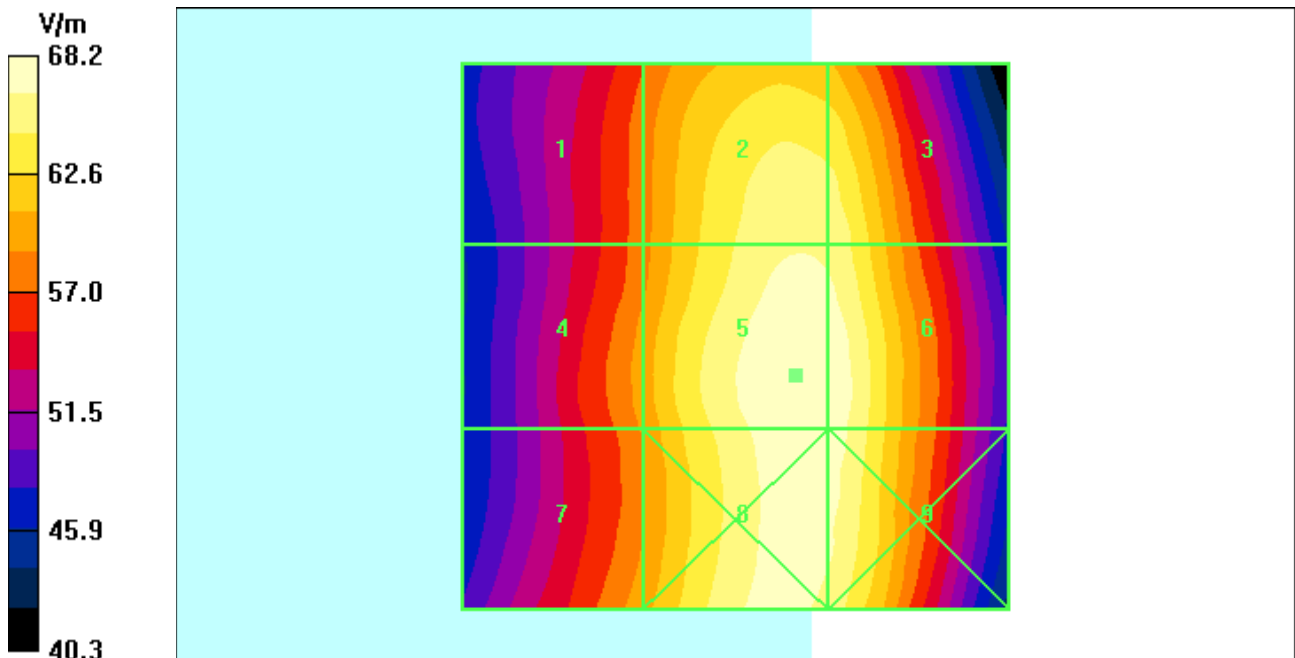

Test Laboratory: Motorola - WCDMA 1900 E-Field

Serial: 358342030037299; FCC ID: IHDT56LD1

Procedure Notes: Pwr Step: All up Bits; Antenna Position: Internal; Accessory Model #: N/A

Battery Model #: SNN5819B; PMF Value: 0.93; Positioner: Polystyrene Block

Communication System: WCDMA 1900; Frequency: 1907.5 MHz; Channel Number: 9538; Duty Cycle: 1:1

Medium: Air; Medium parameters used: $\sigma = 0$ mho/m, $\epsilon_r = 1$; $\rho = 0$ kg/m³

DASY4 Configuration:

- Probe: ER3DV6R - SN2244; ConvF(1, 1, 1); Calibrated: 5/11/2010
- Sensor-Surface: (Fix Surface)
- Electronics: DAE4 Sn387; Calibrated: 5/19/2010
- Phantom: R-3, HAC Test Arch (rev.2); Type: SD HAC P01 BA; Serial: 1071;
- Measurement SW: DASY4, V4.7 Build 80; Postprocessing SW: SEMCAD, V1.8 Build 186

E Scan - Sensor center 15mm above WD, Hearing Aid Compatibility Test (101x101x1):

Measurement grid: dx=5mm, dy=5mm

Maximum value of peak Total field = 42.7 V/m; Probe Modulation Factor = 0.930

Device Reference Point: 0.000, 0.000, -6.30 mm; Reference Value = 44.7 V/m; Power Drift = -0.057 dB

Hearing Aid Near-Field Category: M4 (AWF 0 dB)

Peak E-field in V/m

Grid 1	Grid 2	Grid 3
38.5 M4	42.3 M4	41.9 M4
Grid 4	Grid 5	Grid 6
26.6 M4	42.4 M4	42.7 M4
Grid 7	Grid 8	Grid 9
30.3 M4	46.1 M4	46.1 M4

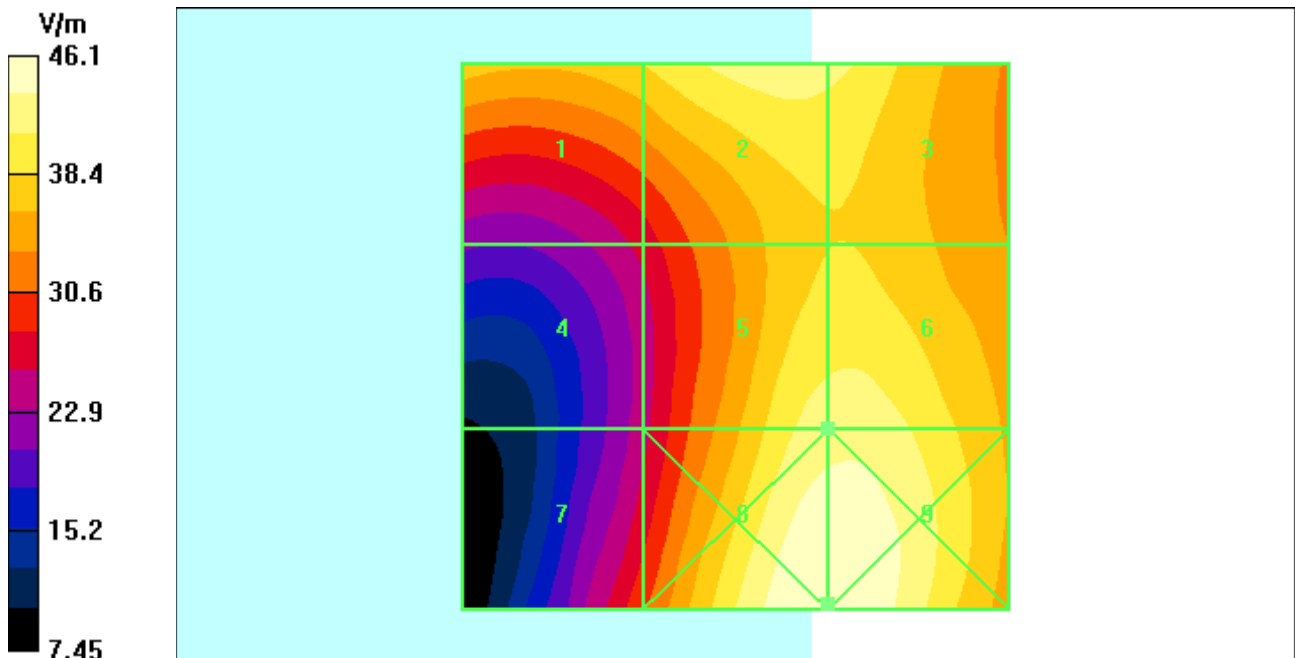

Test Laboratory: Motorola - GSM 850 H-Field

Serial: 358342030037299; FCC ID: IHDT56LD1

Procedure Notes: Pwr Step: 5; Antenna Position: Internal; Accessory Model #: N/A

Battery Model #: SNN5819B; PMF Value: 2.46; Positioner: Polystyrene Block

Communication System: GSM 850; Frequency: 848.8 MHz; Channel Number: 251; Duty Cycle: 1:8.3

Medium: Air; Medium parameters used: $\sigma = 0$ mho/m, $\epsilon_r = 1$; $\rho = 0$ kg/m³

DASY4 Configuration:

- Probe: H3DV6 - SN6078; ; Calibrated: 5/11/2010
- Sensor-Surface: (Fix Surface)
- Electronics: DAE4 Sn650; Calibrated: 5/20/2010
- Phantom: R-3, HAC Test Arch (rev.2); Type: SD HAC P01 BA; Serial: 1071;
- Measurement SW: DASY4, V4.7 Build 80; Postprocessing SW: SEMCAD, V1.8 Build 186

H Scan - Sensor center 15mm above WD, Hearing Aid Compatibility Test (101x101x1):

Measurement grid: dx=5mm, dy=5mm

Maximum value of peak Total field = 0.211 A/m; Probe Modulation Factor = 2.46

Device Reference Point: 0.000, 0.000, -6.30 mm; Reference Value = 0.054 A/m; Power Drift = 0.072 dB

Hearing Aid Near-Field Category: M4 (AWF -5 dB)

Peak H-field in A/m

Grid 1 0.290 M4	Grid 2 0.202 M4	Grid 3 0.118 M4
Grid 4 0.266 M4	Grid 5 0.186 M4	Grid 6 0.097 M4
Grid 7 0.301 M4	Grid 8 0.211 M4	Grid 9 0.121 M4

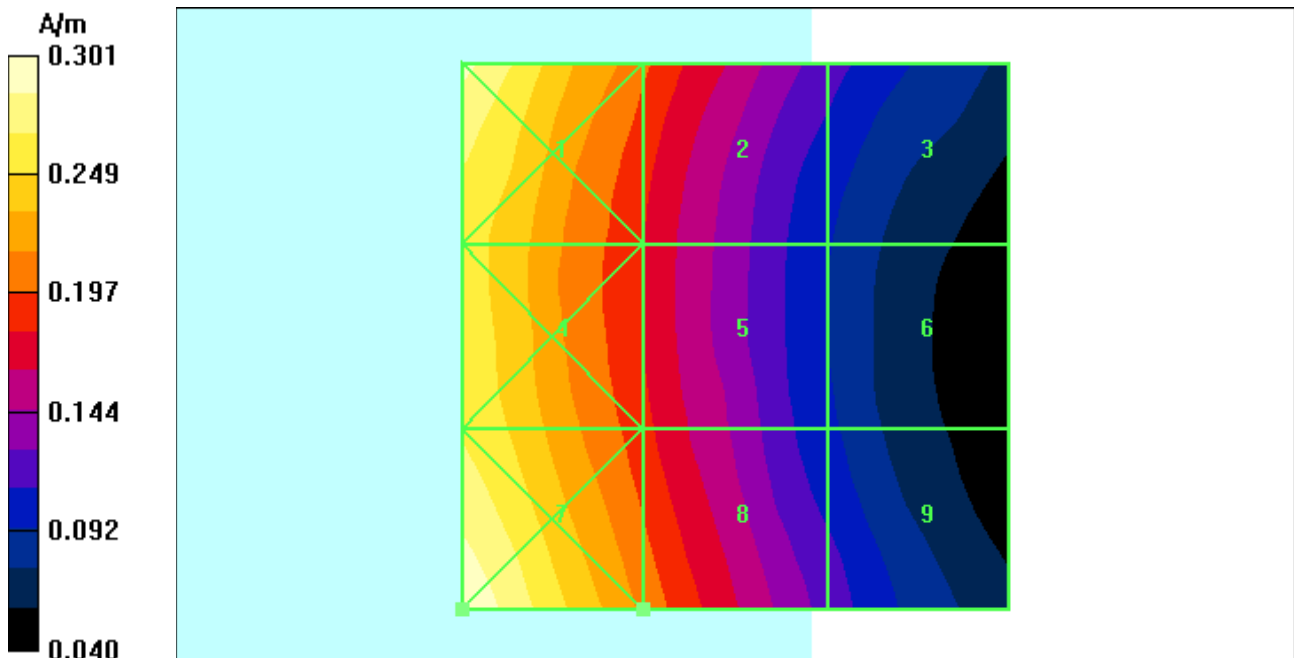

Test Laboratory: Motorola - GSM 1900 H-Field

Serial: 358342030037299; FCC ID: IHDT56LD1

Procedure Notes: Pwr Step: 0; Antenna Position: Internal; Accessory Model #: N/A

Battery Model #: SNN5819B; PMF Value: 2.58; Positioner: Polystyrene Block

Communication System: GSM 1900; Frequency: 1850.2 MHz; Channel Number: 512; Duty Cycle: 1:8.3

Medium: Air; Medium parameters used: $\sigma = 0$ mho/m, $\epsilon_r = 1$; $\rho = 0$ kg/m³

DASY4 Configuration:

- Probe: H3DV6 - SN6078; ; Calibrated: 5/11/2010
- Sensor-Surface: (Fix Surface)
- Electronics: DAE4 Sn650; Calibrated: 5/20/2010
- Phantom: R-3, HAC Test Arch (rev.2); Type: SD HAC P01 BA; Serial: 1071;
- Measurement SW: DASY4, V4.7 Build 80; Postprocessing SW: SEMCAD, V1.8 Build 186

H Scan - Sensor center 15mm above WD, Hearing Aid Compatibility Test (101x101x1):

Measurement grid: dx=5mm, dy=5mm

Maximum value of peak Total field = 0.213 A/m; Probe Modulation Factor = 2.58

Device Reference Point: 0.000, 0.000, -6.30 mm; Reference Value = 0.079 A/m; Power Drift = 0.046 dB

Hearing Aid Near-Field Category: M3 (AWF -5 dB)

Peak H-field in A/m

Grid 1 0.240 M3	Grid 2 0.227 M3	Grid 3 0.222 M3
Grid 4 0.191 M3	Grid 5 0.213 M3	Grid 6 0.213 M3
Grid 7 0.151 M3	Grid 8 0.158 M3	Grid 9 0.157 M3

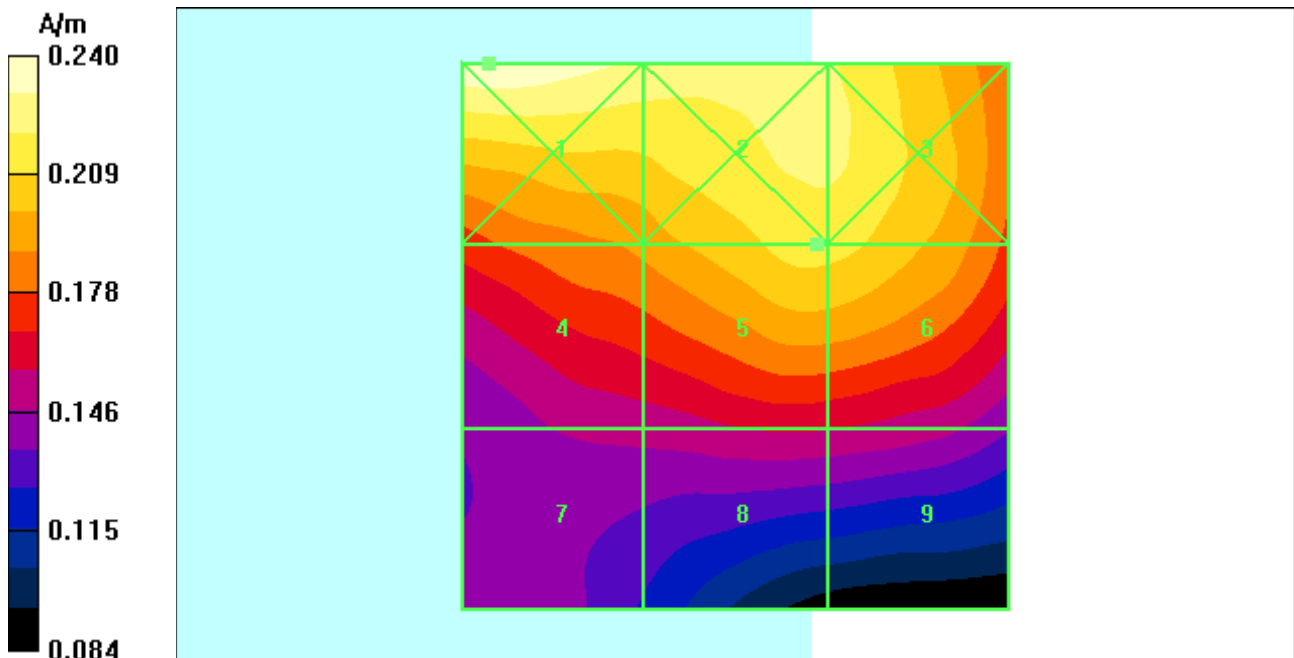

Test Laboratory: Motorola - WCDMA 850 H-Field

Serial: 358342030037299; FCC ID: IHDT56LD1

Procedure Notes: Pwr Step: All up Bits; Antenna Position: Internal; Accessory Model #: N/A

Battery Model #: SNN5819B; PMF Value: 0.91; Positioner: Polystyrene Block

Communication System: WCDMA 850; Frequency: 836 MHz; Channel Number: 4180; Duty Cycle: 1:1

Medium: Air; Medium parameters used: $\sigma = 0$ mho/m, $\epsilon_r = 1$; $\rho = 0$ kg/m³

DASY4 Configuration:

- Probe: H3DV6 - SN6078; ; Calibrated: 5/11/2010
- Sensor-Surface: (Fix Surface)
- Electronics: DAE4 Sn650; Calibrated: 5/20/2010
- Phantom: R-3, HAC Test Arch (rev.2); Type: SD HAC P01 BA; Serial: 1071;
- Measurement SW: DASY4, V4.7 Build 80; Postprocessing SW: SEMCAD, V1.8 Build 186

H Scan - Sensor center 15mm above WD, Hearing Aid Compatibility Test (101x101x1):

Measurement grid: dx=5mm, dy=5mm

Maximum value of peak Total field = 0.083 A/m; Probe Modulation Factor = 0.910

Device Reference Point: 0.000, 0.000, -6.30 mm; Reference Value = 0.056 A/m; Power Drift = -0.249 dB

Hearing Aid Near-Field Category: **M4 (AWF 0 dB)**

Peak H-field in A/m

Grid 1 0.111 M4	Grid 2 0.076 M4	Grid 3 0.043 M4
Grid 4 0.101 M4	Grid 5 0.071 M4	Grid 6 0.037 M4
Grid 7 0.116 M4	Grid 8 0.083 M4	Grid 9 0.049 M4

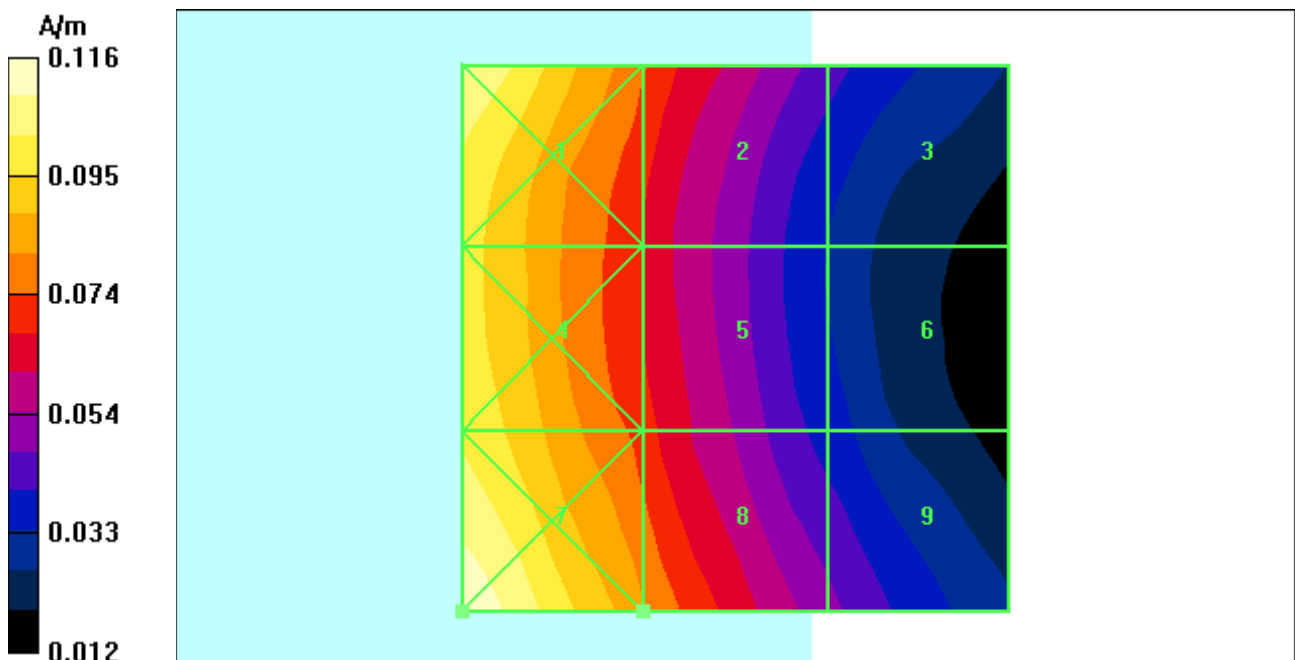

Test Laboratory: Motorola - WCDMA 1900 H-Field

Serial: 358342030037299; FCC ID: IHDT56LD1

Procedure Notes: Pwr Step: All up Bits; Antenna Position: Internal; Accessory Model #: N/A

Battery Model #: SNN5819B; PMF Value: 0.91; Positioner: Polystyrene Block

Communication System: WCDMA 1900; Frequency: 1907.5 MHz; Channel Number: 9538; Duty Cycle: 1:1

Medium: Air; Medium parameters used: $\sigma = 0$ mho/m, $\epsilon_r = 1$; $\rho = 0$ kg/m³

DASY4 Configuration:

- Probe: H3DV6 - SN6078; ; Calibrated: 5/11/2010
- Sensor-Surface: (Fix Surface)
- Electronics: DAE4 Sn650; Calibrated: 5/20/2010
- Phantom: R-3, HAC Test Arch (rev.2); Type: SD HAC P01 BA; Serial: 1071;
- Measurement SW: DASY4, V4.7 Build 80; Postprocessing SW: SEMCAD, V1.8 Build 186

H Scan - Sensor center 15mm above WD, Hearing Aid Compatibility Test (101x101x1):

Measurement grid: dx=5mm, dy=5mm

Maximum value of peak Total field = 0.103 A/m; Probe Modulation Factor = 0.910

Device Reference Point: 0.000, 0.000, -6.30 mm; Reference Value = 0.108 A/m; Power Drift = -0.031 dB

Hearing Aid Near-Field Category: **M4 (AWF 0 dB)**

Peak H-field in A/m

Grid 1 0.122 M4	Grid 2 0.114 M4	Grid 3 0.108 M4
Grid 4 0.098 M4	Grid 5 0.103 M4	Grid 6 0.102 M4
Grid 7 0.088 M4	Grid 8 0.082 M4	Grid 9 0.075 M4

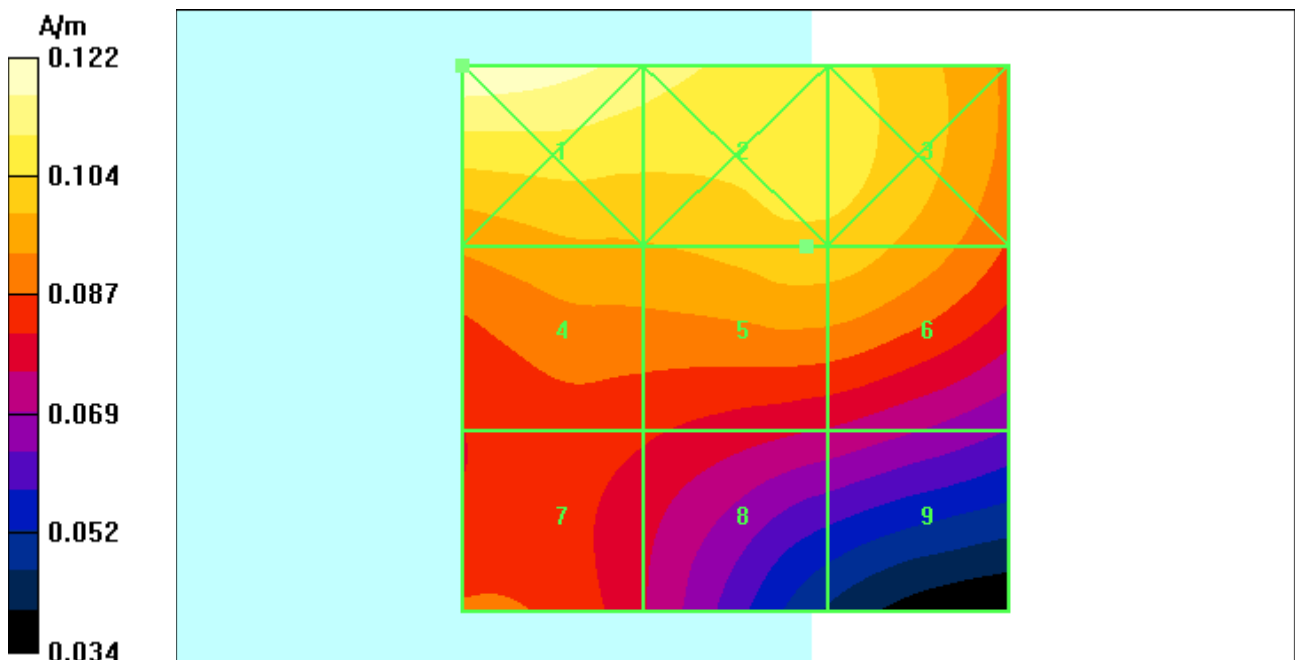

Appendix 4

Measurement Uncertainty Budget

A4.1 Motorola Uncertainty Budget for RF HAC Testing

TABLE A4.1: Motorola Uncertainty Budget

UNCERTAINTY DESCRIPTION	Uncertainty Value (± %)	Prob. Dist.	Div.	(ci) E	(ci) H	Std. Unc. E	Std. Unc. H
MEASUREMENT SYSTEM							
Probe Calibration	5.1%	N	1.0000	1	1	5.1%	5.1%
Axial Isotropy	7.8%	R	1.7321	1	0.786	4.5%	3.5%
Sensor Displacement	16.5%	R	1.7321	1	0.145	9.5%	1.4%
Test Arch	7.2%	R	1.7321	1	0	4.2%	0.0%
Linearity	4.7%	R	1.7321	1	1	2.7%	2.7%
Scaling to Peak Envelope Power	2.0%	R	1.7321	1	1	1.2%	1.2%
System Detection Limit	1.0%	R	1.7321	1	1	0.6%	0.6%
Readout Electronics	0.3%	N	1.0000	1	1	0.3%	0.3%
Response Time	0.8%	R	1.7321	1	1	0.5%	0.5%
Integration Time	2.6%	R	1.7321	1	1	1.5%	1.5%
RF Reflections	5.6%	R	1.7321	1	1	3.2%	3.2%
Probe Positioner	1.2%	R	1.7321	1	0.67	0.7%	0.5%
Probe Positioning	4.7%	R	1.7321	1	0.67	2.7%	1.8%
Extrap. & Interpolation	1.0%	R	1.7321	1	1	0.6%	0.6%
TEST SAMPLE RELATED							
Total Device Positioning	3.2%	R	1.7321	1	1.306	1.8%	2.4%
Device Holder & Phantom	2.4%	R	1.7321	1	1	1.4%	1.4%
Power Drift	5.0%	R	1.7321	1	1	2.9%	2.9%
PHANTOM AND SETUP RELATED							
Phantom Thickness	2.4%	R	1.7321	1	0.67	1.4%	0.9%
Combined Std.Uncertainty on Power						14.1%	9.1%
Combined Std.Uncertainty on Field						7.1%	4.6%
Expanded Std. Uncertainty on Power						28.3%	18.2%
Expanded Std. Uncertainty on Field						14.1%	9.1%

A4.2 Probe Rotation Contributions to Isotropy Error

Probe rotation data was taken “for special focus on spherical isotropicity in measurement uncertainty and perturbation of EM fields.” This data was taken at the interpolated maximum and directly accounted for in the uncertainty budget as “Axial Isotropy.” Thirteen mobile devices were used to determine the probe isotropy uncertainty factors in section A4.1. Based on the resulting 82 E-Field probe rotations and 82 H-Field probe rotations, the upper 95% confidence interval value was calculated for each. These values represent a conservative assessment of the effect of the probe isotropy and have been appropriately included in the respective E- and H-uncertainty budgets.

TABLE A4.2: Probe Rotation Data Summary

	AVE	ST. DEV	Sample Size (n)	2σ	(ci)	Standard Uncertainty
E-field	4.4%	1.7%	82	7.8%	1	4.5%
H-field	3.8%	1.2%	82	6.1%	0.786	3.5%

Isotropy error measurements were taken for 13 products across the respective frequency bands. The +2σ values of all measurements was used as a worst case value for the uncertainty budget. Any significant differences between bands were also evaluated.

Appendix 5
Pictures of Test Setup

See Exhibit 7B

Appendix 6
Probe Calibration Certificates



Accredited by the Swiss Accreditation Service (SAS)
The Swiss Accreditation Service is one of the signatories to the EA
Multilateral Agreement for the recognition of calibration certificates

Accreditation No.: **SCS 108**

Client **Motorola MDb**

Certificate No: **ER3-2244_May10**

CALIBRATION CERTIFICATE

Object **ER3DV6R - SN:2244**

Calibration procedure(s) **QA CAL-02.v5 and QA CAL-25.v2
Calibration procedure for E-field probes optimized for close near field
evaluations in air**

Calibration date: **May 11, 2010**

This calibration certificate documents the traceability to national standards, which realize the physical units of measurements (SI).
The measurements and the uncertainties with confidence probability are given on the following pages and are part of the certificate.

All calibrations have been conducted in the closed laboratory facility: environment temperature (22 ± 3)°C and humidity < 70%.

Calibration Equipment used (M&TE critical for calibration)

Primary Standards	ID #	Cal Date (Certificate No.)	Scheduled Calibration
Power meter E4419B	GB41293874	1-Apr-10 (No. 217-01136)	Apr-11
Power sensor E4412A	MY41495277	1-Apr-10 (No. 217-01136)	Apr-11
Power sensor E4412A	MY41498087	1-Apr-10 (No. 217-01136)	Apr-11
Reference 3 dB Attenuator	SN: S5054 (3c)	30-Mar-10 (No. 217-01159)	Mar-11
Reference 20 dB Attenuator	SN: S5086 (20b)	30-Mar-10 (No. 217-01161)	Mar-11
Reference 30 dB Attenuator	SN: S5129 (30b)	30-Mar-10 (No. 217-01160)	Mar-11
Reference Probe ER3DV6	SN: 2328	3-Oct-09 (No. ER3-2328_Oct09)	Oct-10
DAE4	SN: 789	23-Dec-09 (No. DAE4-789_Dec09)	Dec-10

Secondary Standards	ID #	Check Date (in house)	Scheduled Check
RF generator HP 8648C	US3642U01700	4-Aug-99 (in house check Oct-09)	In house check: Oct-11
Network Analyzer HP 8753E	US37390585	18-Oct-01 (in house check Oct-09)	In house check: Oct10

Calibrated by:	Name Claudio Leubler	Function Laboratory Technician	Signature
Approved by:	Name Katja Pokovic	Function Technical Manager	Signature

Issued: May 12, 2010

This calibration certificate shall not be reproduced except in full without written approval of the laboratory.



Accredited by the Swiss Accreditation Service (SAS)

Accreditation No.: **SCS 108**

The Swiss Accreditation Service is one of the signatories to the EA
Multilateral Agreement for the recognition of calibration certificates

Glossary:

NORM _{x,y,z}	sensitivity in free space
DCP	diode compression point
CF	crest factor (1/duty_cycle) of the RF signal
A, B, C	modulation dependent linearization parameters
Polarization φ	φ rotation around probe axis
Polarization ϑ	ϑ rotation around an axis that is in the plane normal to probe axis (at measurement center), i.e., $\vartheta = 0$ is normal to probe axis
Connector Angle	information used in DASY system to align probe sensor X to the robot coordinate system

Calibration is Performed According to the Following Standards:

- IEEE Std 1309-2005, "IEEE Standard for calibration of electromagnetic field sensors and probes, excluding antennas, from 9 kHz to 40 GHz", December 2005.

Methods Applied and Interpretation of Parameters:

- NORM_{x,y,z}*: Assessed for E-field polarization $\vartheta = 0$ for XY sensors and $\vartheta = 90$ for Z sensor ($f \leq 900$ MHz in TEM-cell; $f > 1800$ MHz: R22 waveguide).
- NORM(f)_{x,y,z}* = *NORM_{x,y,z}* * *frequency_response* (see Frequency Response Chart).
- DCP_{x,y,z}*: DCP are numerical linearization parameters assessed based on the data of power sweep with CW signal (no uncertainty required). DCP does not depend on frequency nor media.
- A_{x,y,z}; B_{x,y,z}; C_{x,y,z}; VR_{x,y,z}*: A, B, C are numerical linearization parameters assessed based on the data of power sweep for specific modulation signal. The parameters do not depend on frequency nor media. VR is the maximum calibration range expressed in RMS voltage across the diode.
- Spherical isotropy (3D deviation from isotropy)*: in a locally homogeneous field realized using an open waveguide setup.
- Sensor Offset*: The sensor offset corresponds to the offset of virtual measurement center from the probe tip (on probe axis). No tolerance required.
- Connector Angle*: The angle is assessed using the information gained by determining the *NORM_x* (no uncertainty required).

Probe ER3DV6R

SN:2244

Manufactured:	February 1, 2000
Last calibrated:	September 22, 2008
Recalibrated:	May 11, 2010

Calibrated for DASY/EASY Systems

(Note: non-compatible with DASY2 system!)

DASY/EASY - Parameters of Probe: ER3DV6R SN:2244**Basic Calibration Parameters**

	Sensor X	Sensor Y	Sensor Z	Unc (k=2)
Norm ($\mu\text{V}/(\text{V}/\text{m})^2$)	1.86	1.86	2.08	$\pm 10.1\%$
DCP (mV) ^A	94.2	94.4	96.2	

Modulation Calibration Parameters

UID	Communication System Name	PAR		A dB	B dBuV	C	VR mV	Unc ^E (k=2)
10000	CW	0.00	X	0.00	0.00	1.00	300	$\pm 1.5\%$
			Y	0.00	0.00	1.00	300	
			Z	0.00	0.00	1.00	300	

The reported uncertainty of measurement is stated as the standard uncertainty of measurement multiplied by the coverage factor $k=2$, which for a normal distribution corresponds to a coverage probability of approximately 95%.

^A numerical linearization parameter: uncertainty not required

^E Uncertainty is determined using the maximum deviation from linear response applying rectangular distribution and is expressed for the square of the field value.

Frequency Response of E-Field

(TEM-Cell:ifi110 EXX, Waveguide R22)

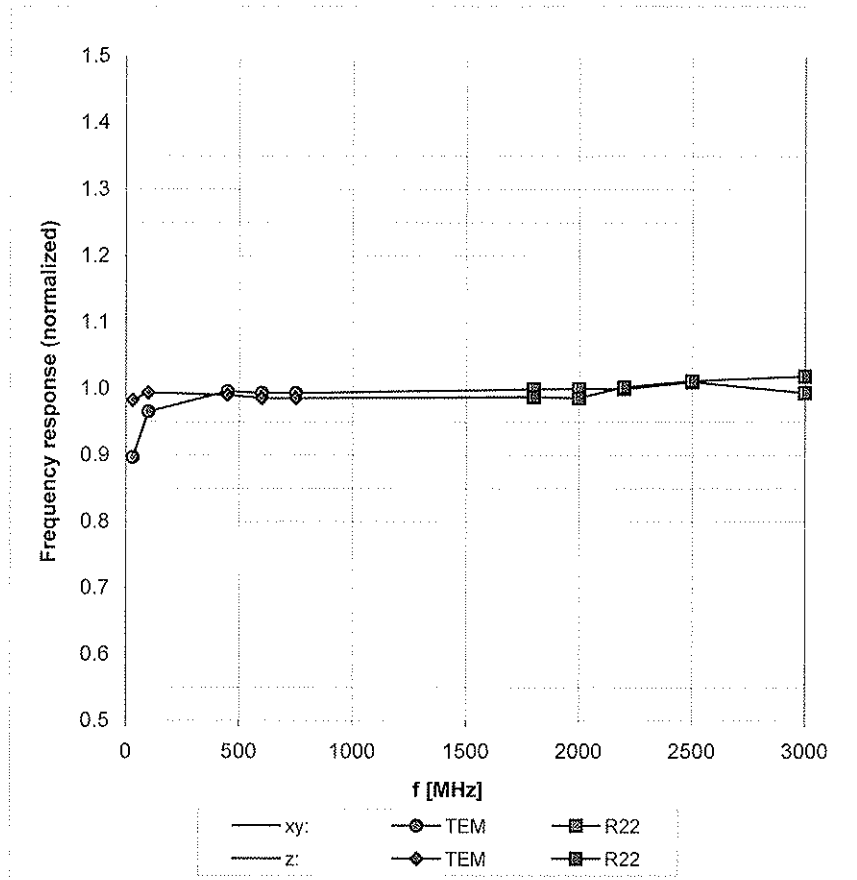

Uncertainty of Frequency Response of E-field: $\pm 6.3\%$ (k=2)

Receiving Pattern (ϕ), $\vartheta = 0^\circ$

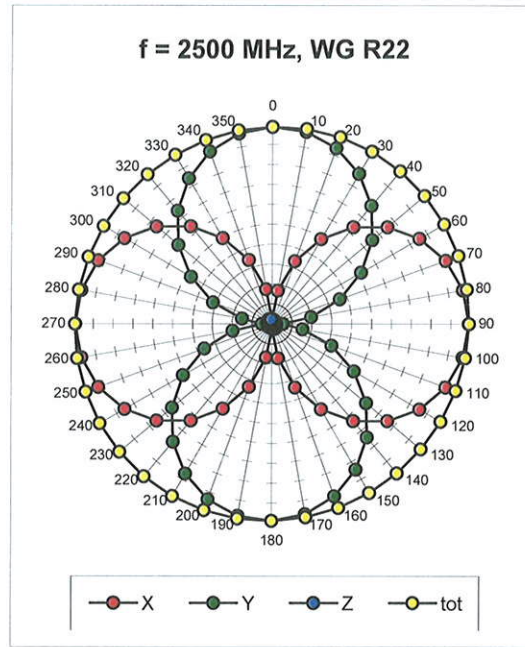
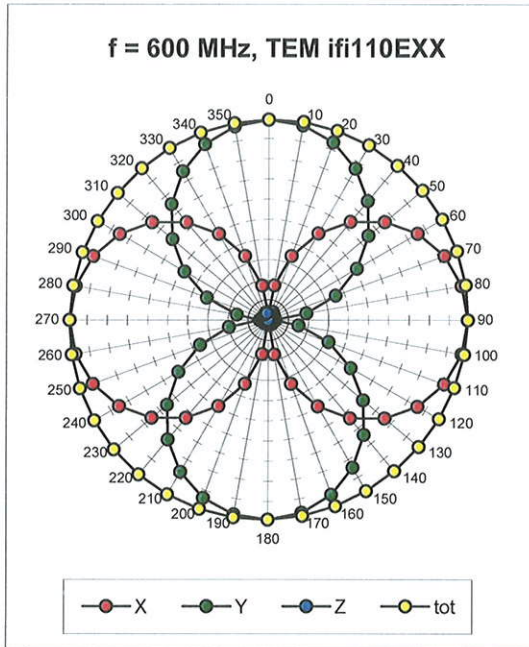

Receiving Pattern (ϕ), $\vartheta = 90^\circ$

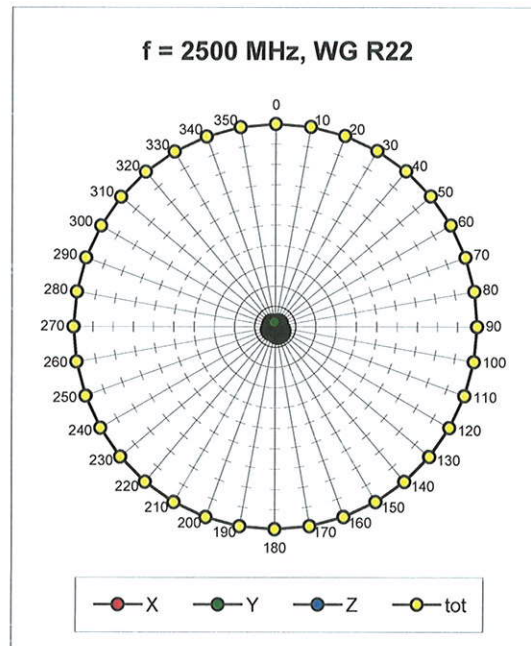
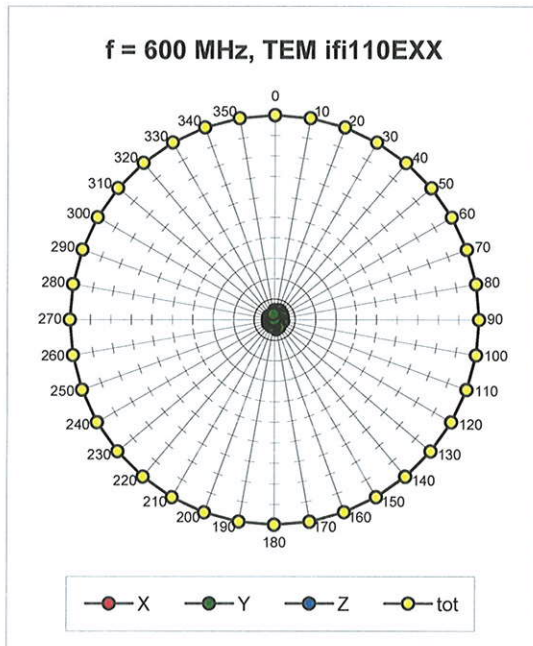

Receiving Pattern (ϕ), $\vartheta = 0^\circ$

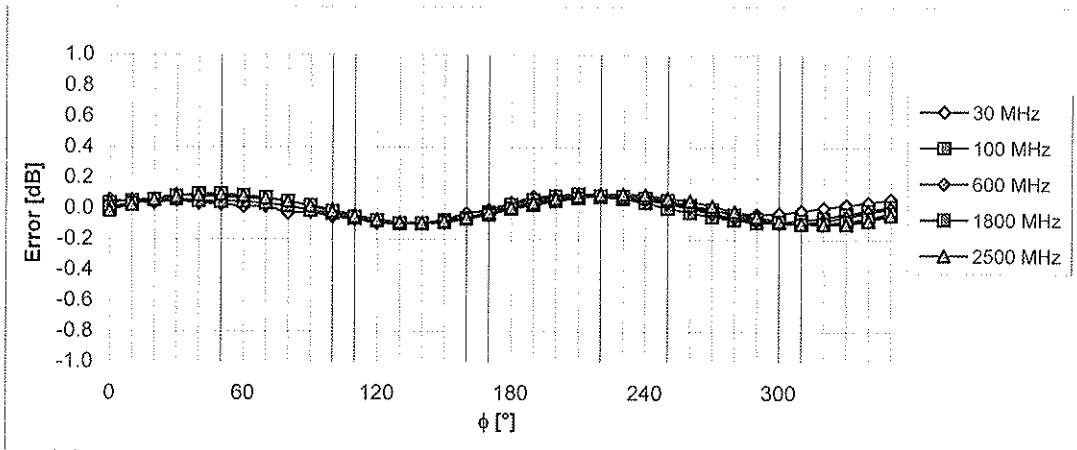

Uncertainty of Axial Isotropy Assessment: $\pm 0.5\%$ ($k=2$)

Receiving Pattern (ϕ), $\vartheta = 90^\circ$

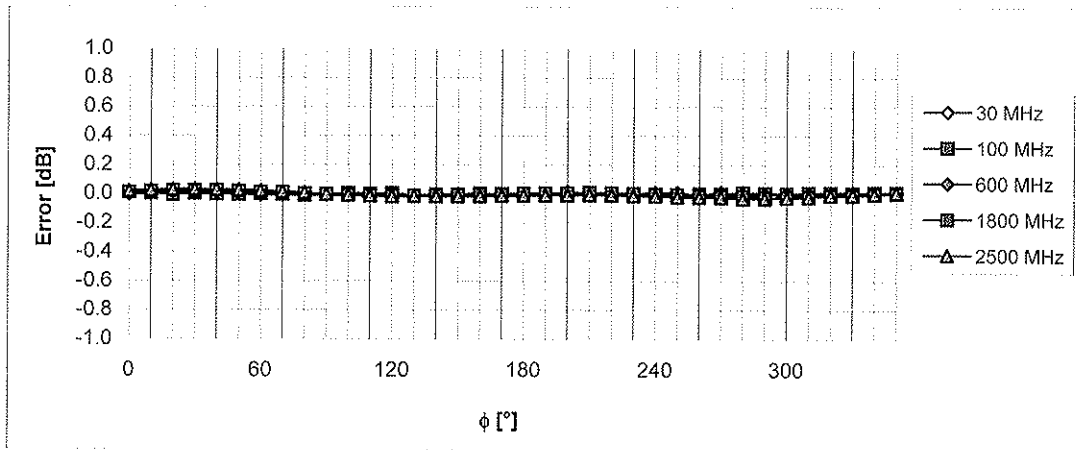

Uncertainty of Axial Isotropy Assessment: $\pm 0.5\%$ ($k=2$)

Dynamic Range f(E-field) (Waveguide R22, f = 1800 MHz)

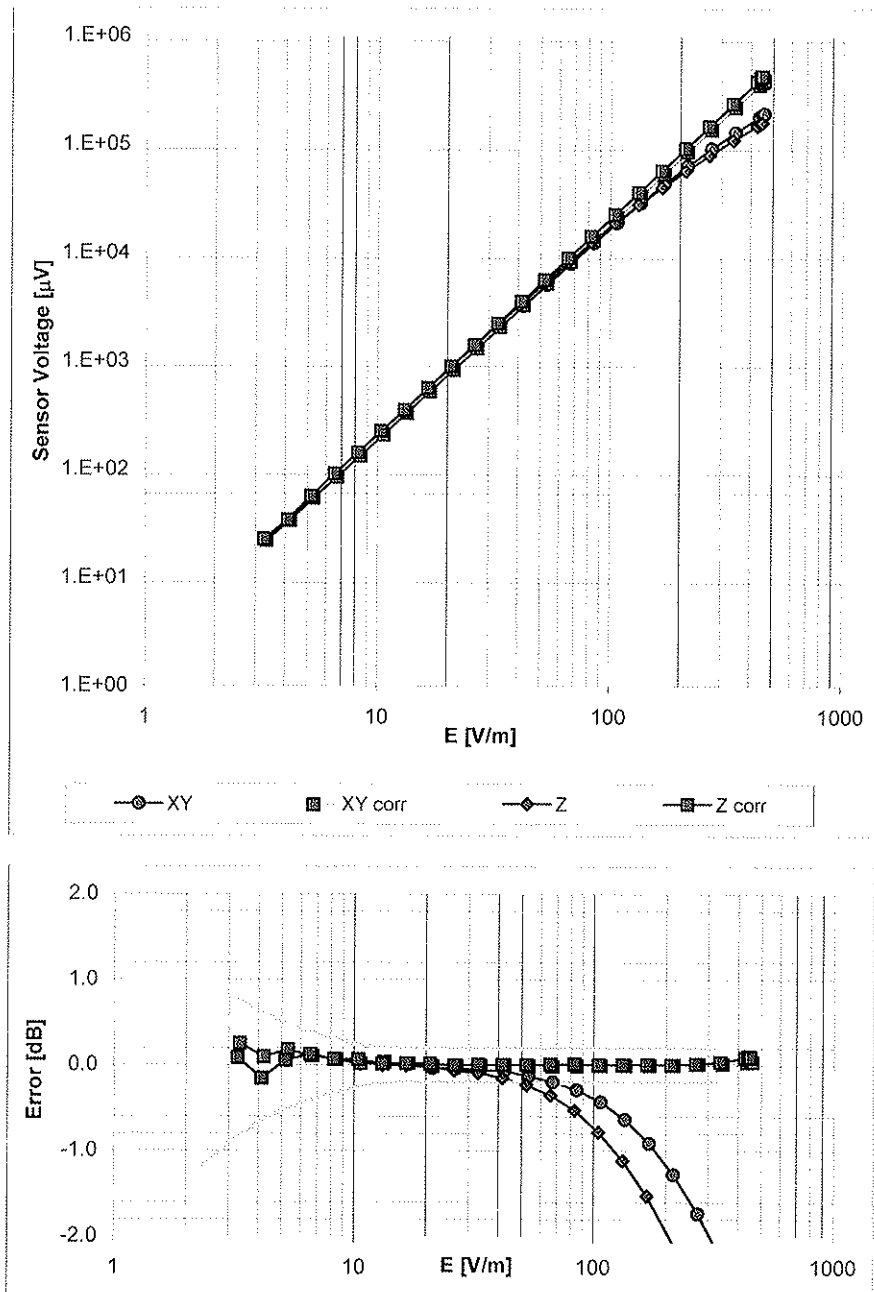

Uncertainty of Linearity Assessment: $\pm 0.6\%$ ($k=2$)

Deviation from Isotropy in Air Error (ϕ, ϑ), $f = 900$ MHz

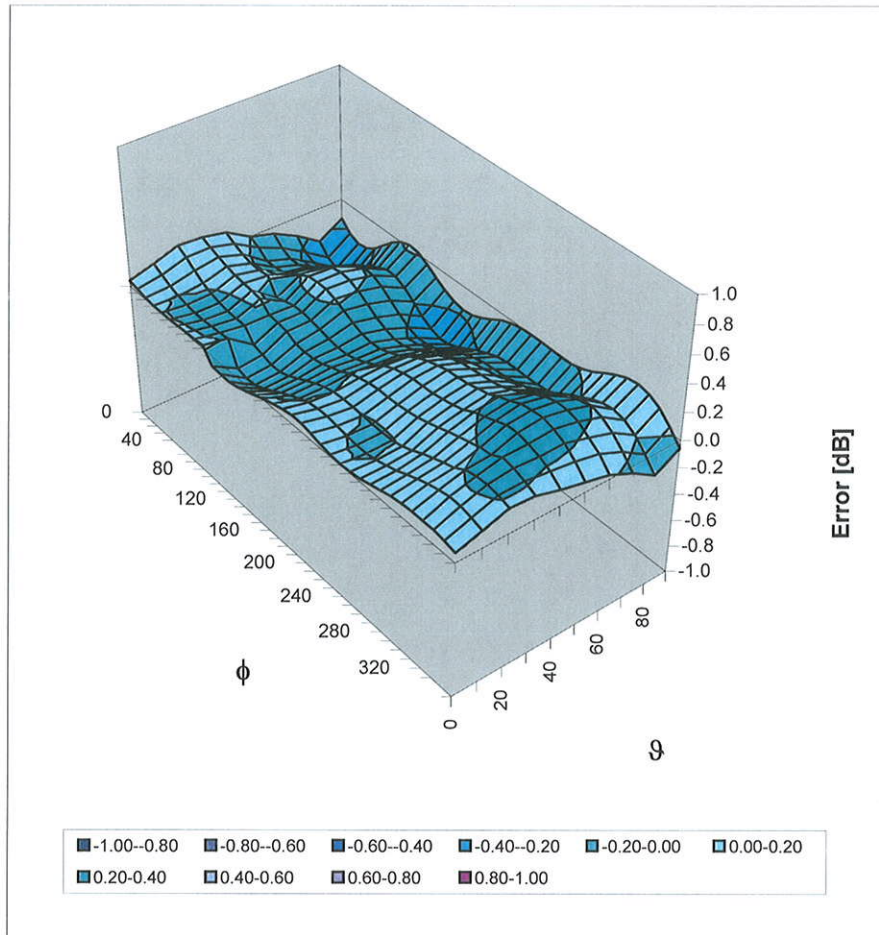

Uncertainty of Spherical Isotropy Assessment: $\pm 2.6\%$ ($k=2$)

Other Probe Parameters

Sensor Arrangement	Rectangular
Connector Angle (°)	25.0
Mechanical Surface Detection Mode	enabled
Optical Surface Detection Mode	disabled
Probe Overall Length	337 mm
Probe Body Diameter	10 mm
Tip Length	10 mm
Tip Diameter	8.0 mm
Probe Tip to Sensor X Calibration Point	2.5 mm
Probe Tip to Sensor Y Calibration Point	2.5 mm
Probe Tip to Sensor Z Calibration Point	2.5 mm



Accredited by the Swiss Accreditation Service (SAS)
The Swiss Accreditation Service is one of the signatories to the EA
Multilateral Agreement for the recognition of calibration certificates

Accreditation No.: **SCS 108**

Client **Motorola MDb**

Certificate No: **H3-6078_May10**

CALIBRATION CERTIFICATE

Object **H3DV6 - SN:6078**

Calibration procedure(s) **QA CAL-03.v5 and QA CAL-25.v2
Calibration procedure for H-field probes optimized for close near field
evaluations in air**

Calibration date: **May 11, 2010**

This calibration certificate documents the traceability to national standards, which realize the physical units of measurements (SI).
The measurements and the uncertainties with confidence probability are given on the following pages and are part of the certificate.

All calibrations have been conducted in the closed laboratory facility: environment temperature (22 ± 3)°C and humidity < 70%.

Calibration Equipment used (M&TE critical for calibration)

Primary Standards	ID #	Cal Date (Certificate No.)	Scheduled Calibration
Power meter E4419B	GB41293874	1-Apr-10 (No. 217-01136)	Apr-11
Power sensor E4412A	MY41495277	1-Apr-10 (No. 217-01136)	Apr-11
Power sensor E4412A	MY41498087	1-Apr-10 (No. 217-01136)	Apr-11
Reference 3 dB Attenuator	SN: S5054 (3c)	30-Mar-10 (No. 217-01159)	Mar-11
Reference 20 dB Attenuator	SN: S5086 (20b)	30-Mar-10 (No. 217-01161)	Mar-11
Reference 30 dB Attenuator	SN: S5129 (30b)	30-Mar-10 (No. 217-01160)	Mar-11
Reference Probe H3DV6	SN: 6182	3-Oct-09 (No. H3-6182_Oct09)	Oct-10
DAE4	SN: 789	23-Dec-09 (No. DAE4-789_Dec09)	Dec-10
Secondary Standards	ID #	Check Date (in house)	Scheduled Check
RF generator HP 8648C	US3642U01700	4-Aug-99 (in house check Oct-09)	In house check: Oct-11
Network Analyzer HP 8753E	US37390585	18-Oct-01 (in house check Oct-09)	In house check: Oct10

Calibrated by:	Claudio Leubler	Laboratory Technician	
Approved by:	Katja Pokovic	Technical Manager	

Issued: May 12, 2010

This calibration certificate shall not be reproduced except in full without written approval of the laboratory.



Accredited by the Swiss Accreditation Service (SAS)
The Swiss Accreditation Service is one of the signatories to the EA
Multilateral Agreement for the recognition of calibration certificates

Accreditation No.: **SCS 108**

Glossary:

NORM _{x,y,z}	sensitivity in free space
DCP	diode compression point
CF	crest factor (1/duty_cycle) of the RF signal
A, B, C	modulation dependent linearization parameters
Polarization φ	φ rotation around probe axis
Polarization ϑ	ϑ rotation around an axis that is in the plane normal to probe axis (at measurement center), i.e., $\vartheta = 0$ is normal to probe axis
Connector Angle	information used in DASY system to align probe sensor X to the robot coordinate system

Calibration is Performed According to the Following Standards:

- a) IEEE Std 1309-2005, "IEEE Standard for calibration of electromagnetic field sensors and probes, excluding antennas, from 9 kHz to 40 GHz", December 2005.

Methods Applied and Interpretation of Parameters:

- *NORM_{x,y,z}*: Assessed for E-field polarization $\vartheta = 0$ for XY sensors and $\vartheta = 90$ for Z sensor ($f \leq 900$ MHz in TEM-cell; $f > 1800$ MHz: R22 waveguide).
- *X, Y, Z(f)_a0a1a2* = *X, Y, Z_a0a1a2* * *frequency_response* (see Frequency Response Chart).
- *DCP_{x,y,z}*: DCP are numerical linearization parameters assessed based on the data of power sweep with CW signal (no uncertainty required). DCP does not depend on frequency nor media.
- *A_{x,y,z}; B_{x,y,z}; C_{x,y,z}; VR_{x,y,z}; A, B, C* are numerical linearization parameters assessed based on the data of power sweep for specific modulation signal. The parameters do not depend on frequency nor media. *VR* is the maximum calibration range expressed in RMS voltage across the diode.
- *Spherical isotropy (3D deviation from isotropy)*: in a locally homogeneous field realized using an open waveguide setup.
- *Sensor Offset*: The sensor offset corresponds to the offset of virtual measurement center from the probe tip (on probe axis). No tolerance required.
- *Connector Angle*: The angle is assessed using the information gained by determining the *X_a0a1a2* (no uncertainty required).

Probe H3DV6

SN:6078

Manufactured:	October 2, 2000
Last calibrated:	September 22, 2008
Recalibrated:	May 11, 2010

Calibrated for DASY/EASY Systems

(Note: non-compatible with DASY2 system!)

DASY/EASY - Parameters of Probe: H3DV6 SN:6078**Basic Calibration Parameters**

		Sensor X	Sensor Y	Sensor Z	Unc (k=2)
Norm (A/m / $\sqrt{(\mu V)}$)	a0	2.79E-3	2.70E-3	3.08E-3	$\pm 5.1\%$
Norm (A/m / $\sqrt{(\mu V)}$)	a1	-1.88E-4	-1.37E-4	-2.79E-4	$\pm 5.1\%$
Norm (A/m / $\sqrt{(\mu V)}$)	a2	2.70E-5	3.64E-6	5.11E-6	$\pm 5.1\%$
DCP (mV) ^A		89.9	83.3	83.1	

Modulation Calibration Parameters

UID	Communication System Name	PAR		A dB	B dBuV	C	VR mV	Unc ^E (k=2)
10000	CW	0.00	X	0.00	0.00	1.00	300	$\pm 1.5\%$
			Y	0.00	0.00	1.00	300	
			Z	0.00	0.00	1.00	300	

The reported uncertainty of measurement is stated as the standard uncertainty of measurement multiplied by the coverage factor $k=2$, which for a normal distribution corresponds to a coverage probability of approximately 95%.

^A numerical linearization parameter: uncertainty not required

^E Uncertainty is determined using the maximum deviation from linear response applying recatangular distribution and is expressed for the square of the field value.

Frequency Response of H-Field (TEM-Cell:ifi110 EXX, Waveguide R22)

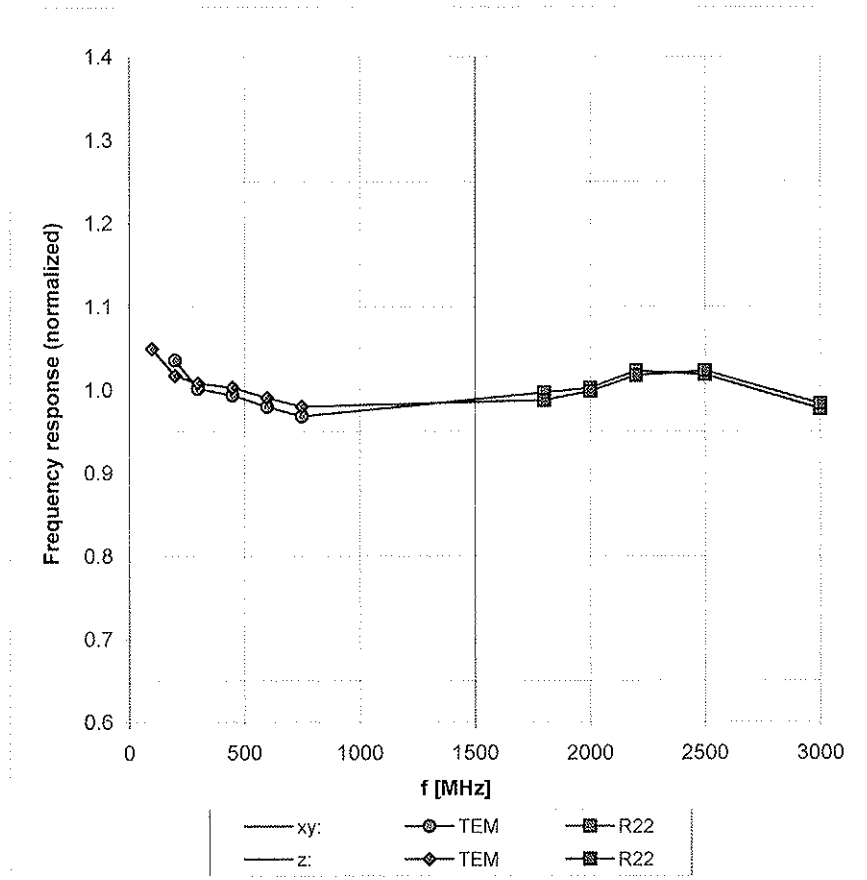

Uncertainty of Frequency Response of H-field: $\pm 6.3\%$ (k=2)

Receiving Pattern (ϕ), $\vartheta = 90^\circ$

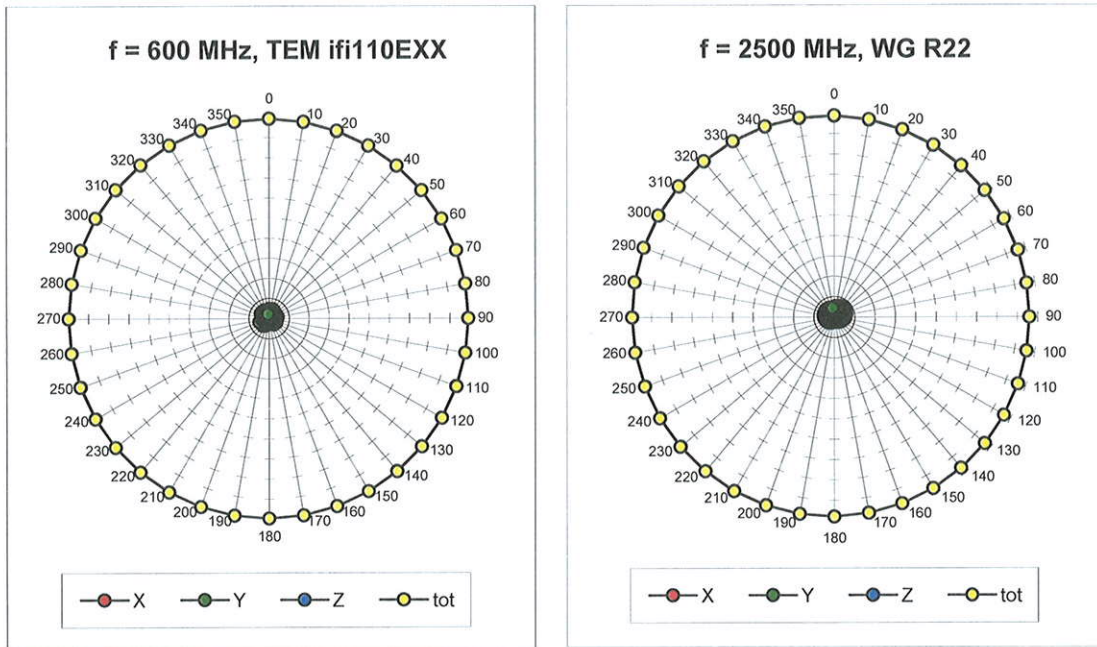

Receiving Pattern (ϕ), $\vartheta = 0^\circ$

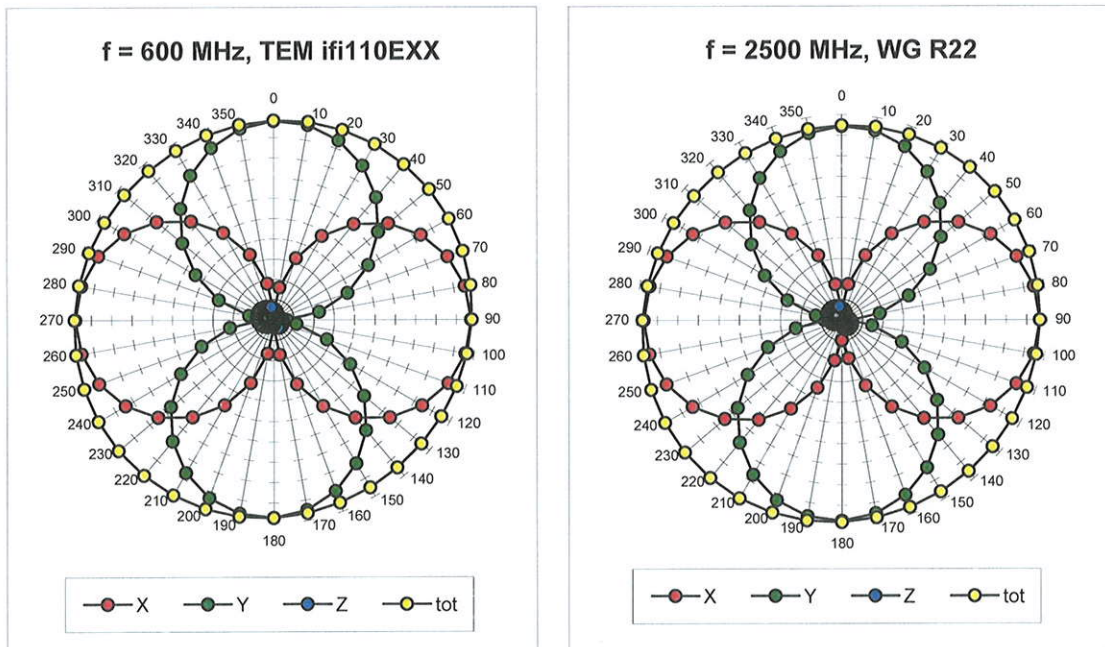

Receiving Pattern (ϕ), $\vartheta = 90^\circ$

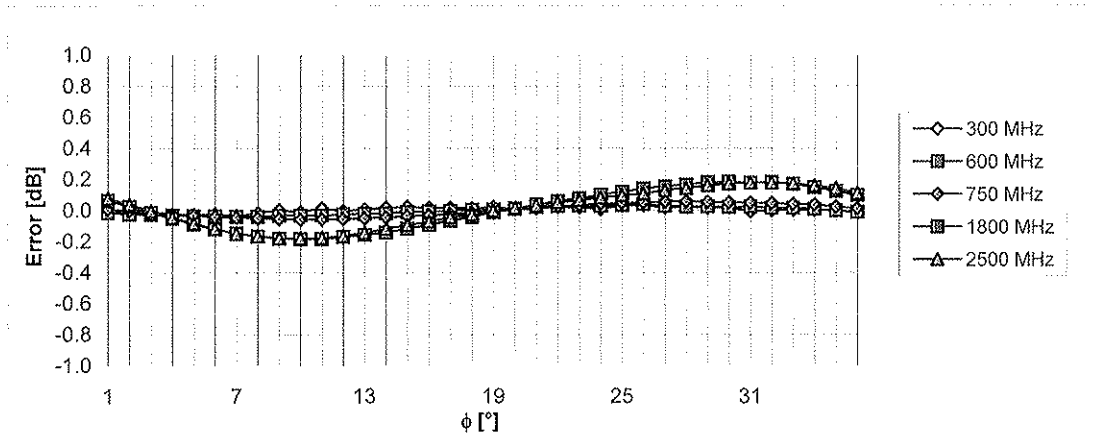

Uncertainty of Axial Isotropy Assessment: $\pm 0.5\%$ ($k=2$)

Receiving Pattern (ϕ), $\vartheta = 0^\circ$

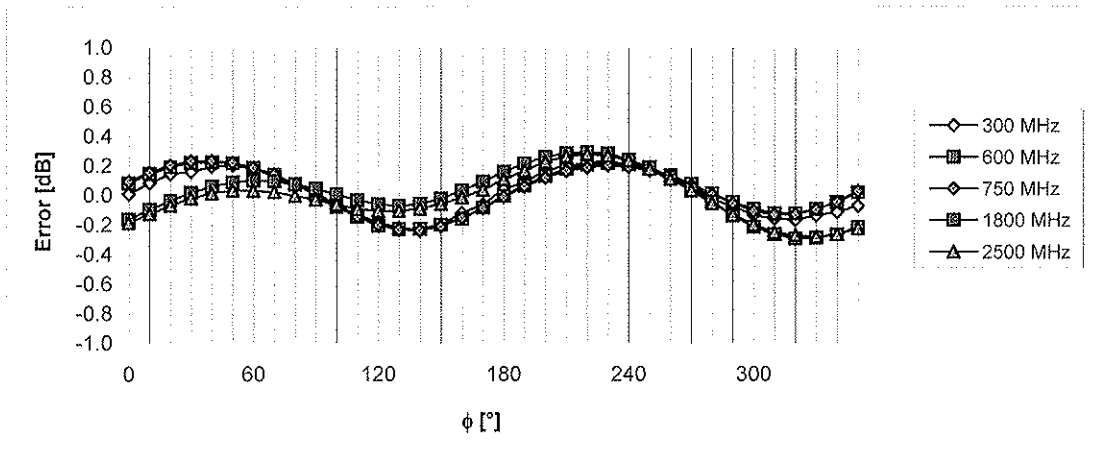

Uncertainty of Axial Isotropy Assessment: $\pm 0.5\%$ ($k=2$)

Dynamic Range f(H-field) (Waveguide R22, f = 1800 MHz)

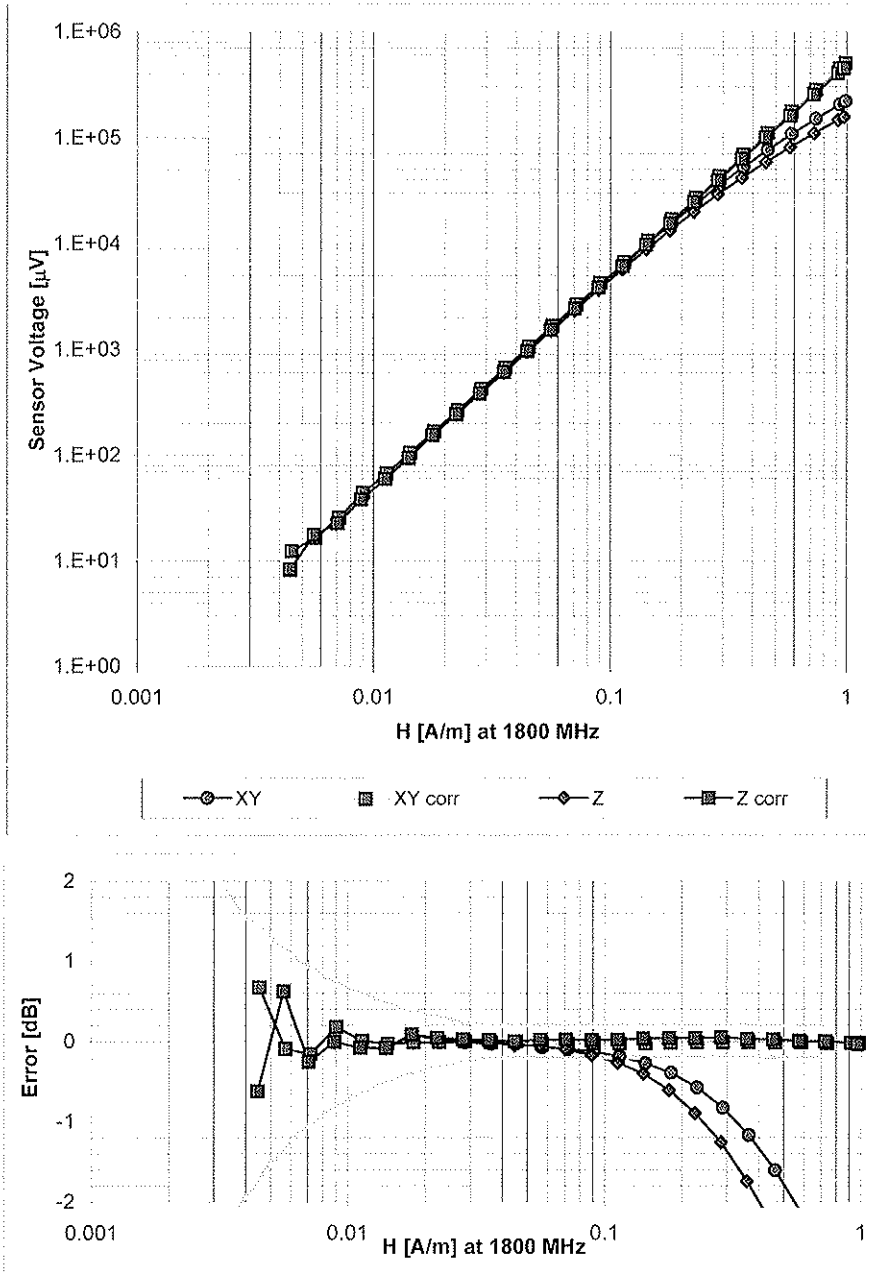

Uncertainty of Linearity Assessment: $\pm 0.6\%$ ($k=2$)

Deviation from Isotropy in Air Error (ϕ, ϑ), $f = 900$ MHz

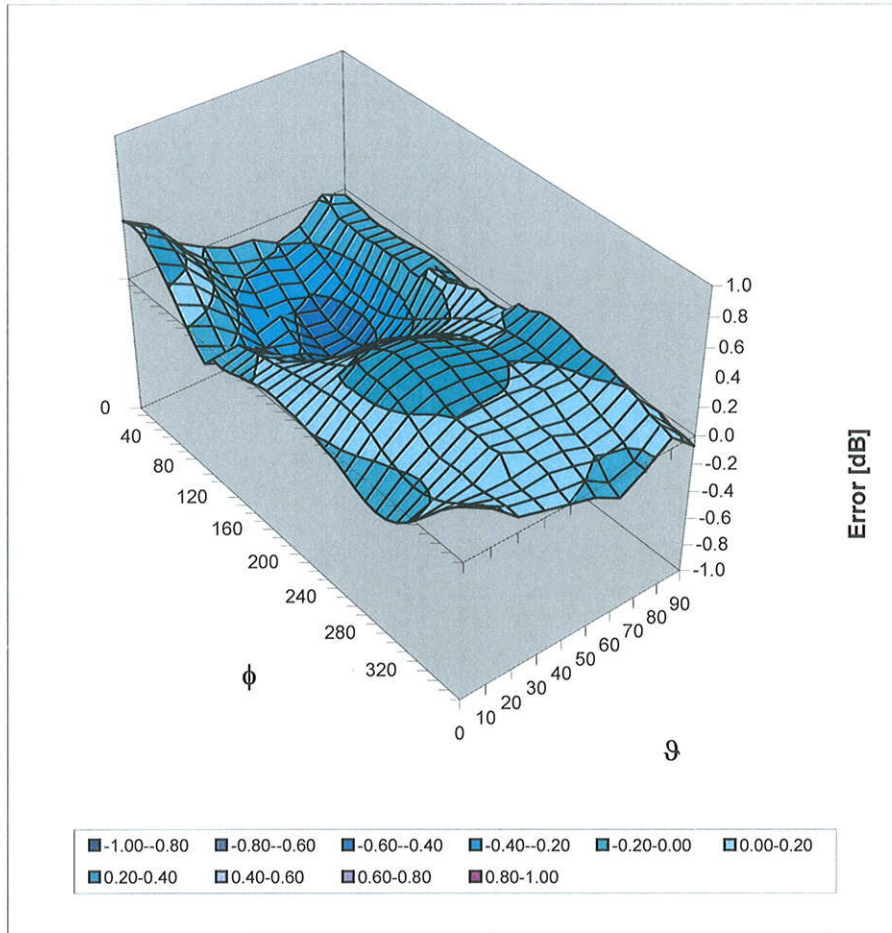

Uncertainty of Spherical Isotropy Assessment: $\pm 2.6\%$ ($k=2$)

Other Probe Parameters

Sensor Arrangement	Rectangular
Connector Angle (°)	-220.3
Mechanical Surface Detection Mode	enabled
Optical Surface Detection Mode	disabled
Probe Overall Length	337 mm
Probe Body Diameter	10 mm
Tip Length	20 mm
Tip Diameter	6.0 mm
Probe Tip to Sensor X Calibration Point	3 mm
Probe Tip to Sensor Y Calibration Point	3 mm
Probe Tip to Sensor Z Calibration Point	3 mm

Appendix 7

Dipole Characterization Certificates



Accredited by the Swiss Accreditation Service (SAS)
The Swiss Accreditation Service is one of the signatories to the EA
Multilateral Agreement for the recognition of calibration certificates

Accreditation No.: **SCS 108**

Client **Motorola MDb**

Certificate No: **CD835V3-1076_Feb10**

CALIBRATION CERTIFICATE

Object **CD835V3 - SN: 1076**

Calibration procedure(s) **QA CAL-20.v5
Calibration procedure for dipoles in air**

Calibration date: **February 16, 2010**

This calibration certificate documents the traceability to national standards, which realize the physical units of measurements (SI).
All calibrations have been conducted in the closed laboratory facility: environment temperature (22 ± 3)°C and humidity < 70%.

Calibration Equipment used (M&TE critical for calibration)

Primary Standards	ID #	Cal Date (Certificate No.)	Scheduled Calibration
Power meter EPM-442A	GB37480704	06-Oct-09 (No. 217-01086)	Oct-10
Power sensor HP 8481A	US37292783	06-Oct-09 (No. 217-01086)	Oct-10
Probe ER3DV6	SN: 2336	30-Dec-09 (No. ER3-2336_Dec09)	Dec-10
Probe H3DV6	SN: 6065	30-Dec-09 (No. H3-6065_Dec09)	Dec-10
DAE4	SN: 781	22-Jan-10 (No. DAE4-781_Jan10)	Jan-11
Secondary Standards	ID #	Check Date (in house)	Scheduled Check
Power meter Agilent 4419B	SN: GB42420191	09-Oct-09 (in house check Oct-09)	In house check: Oct-10
Power sensor HP 8482H	SN: 3318A09450	09-Oct-09 (in house check Oct-09)	In house check: Oct-10
Power sensor HP 8482A	SN: US37295597	09-Oct-09 (in house check Oct-09)	In house check: Oct-10
Network Analyzer HP 8753E	US37390585	18-Oct-01 (in house check Oct-09)	In house check: Oct-10
RF generator E4433B	MY 41000675	03-Nov-04 (in house check Oct-09)	In house check: Oct-11

Calibrated by:	Name Claudio Leubler	Function Laboratory Technician	Signature
Approved by:	Name Fin Bomholt	Function Technical Director	Signature

Issued: February 23, 2010

This calibration certificate shall not be reproduced except in full without written approval of the laboratory.



Accredited by the Swiss Accreditation Service (SAS)
The Swiss Accreditation Service is one of the signatories to the EA
Multilateral Agreement for the recognition of calibration certificates

Accreditation No.: **SCS 108**

References

- [1] ANSI-C63.19-2006
American National Standard for Methods of Measurement of Compatibility between Wireless Communications Devices and Hearing Aids.
- [2] ANSI-C63.19-2007
American National Standard for Methods of Measurement of Compatibility between Wireless Communications Devices and Hearing Aids.

Methods Applied and Interpretation of Parameters:

- *Coordinate System:* y-axis is in the direction of the dipole arms. z-axis is from the basis of the antenna (mounted on the table) towards its feed point between the two dipole arms. x-axis is normal to the other axes. In coincidence with the standards [1, 2], the measurement planes (probe sensor center) are selected to be at a distance of 10 mm above the top edge of the dipole arms.
- *Measurement Conditions:* Further details are available from the hardcopies at the end of the certificate. All figures stated in the certificate are valid at the frequency indicated. The forward power to the dipole connector is set with a calibrated power meter connected and monitored with an auxiliary power meter connected to a directional coupler. While the dipole under test is connected, the forward power is adjusted to the same level.
- *Antenna Positioning:* The dipole is mounted on a HAC Test Arch phantom using the matching dipole positioner with the arms horizontal and the feeding cable coming from the floor. The measurements are performed in a shielded room with absorbers around the setup to reduce the reflections. It is verified before the mounting of the dipole under the Test Arch phantom, that its arms are perfectly in a line. It is installed on the HAC dipole positioner with its arms parallel below the dielectric reference wire and able to move elastically in vertical direction without changing its relative position to the top center of the Test Arch phantom. The vertical distance to the probe is adjusted after dipole mounting with a DASY5 Surface Check job. Before the measurement, the distance between phantom surface and probe tip is verified. The proper measurement distance is selected by choosing the matching section of the HAC Test Arch phantom with the proper device reference point (upper surface of the dipole) and the matching grid reference point (tip of the probe) considering the probe sensor offset. The vertical distance to the probe is essential for the accuracy.
- *Feed Point Impedance and Return Loss:* These parameters are measured using a HP 8753E Vector Network Analyzer. The impedance is specified at the SMA connector of the dipole. The influence of reflections was eliminating by applying the averaging function while moving the dipole in the air, at least 70cm away from any obstacles.
- *E- field distribution:* E field is measured in the x-y-plane with an isotropic ER3D-field probe with 100 mW forward power to the antenna feed point. In accordance with [1, 2], the scan area is 20mm wide, its length exceeds the dipole arm length (180 or 90mm). The sensor center is 10 mm (in z) above the top of the dipole arms. Two 3D maxima are available near the end of the dipole arms. Assuming the dipole arms are perfectly in one line, the average of these two maxima (in subgrid 2 and subgrid 8) is determined to compensate for any non-parallelity to the measurement plane as well as the sensor displacement. The E-field value stated as calibration value represents the maximum of the interpolated 3D-E-field, 10mm above the dipole surface.
- *H-field distribution:* H-field is measured with an isotropic H-field probe with 100mW forward power to the antenna feed point, in the x-y-plane. The scan area and sensor distance is equivalent to the E-field scan. The maximum of the field is available at the center (subgrid 5) above the feed point. The H-field value stated as calibration value represents the maximum of the interpolated H-field, 10mm above the dipole surface at the feed point.

1 Measurement Conditions

DASY system configuration, as far as not given on page 1.

DASY Version	DASY5	V5.2 B162
DASY PP Version	SEMCAD X	V14.0 B57
Phantom	HAC Test Arch	SD HAC P01 BA, #1070
Distance Dipole Top - Probe Center	10 mm	
Scan resolution	dx, dy = 5 mm	area = 20 x 180 mm
Frequency	835 MHz ± 1 MHz	
Forward power at dipole connector	20.0 dBm = 100mW	
Input power drift	< 0.05 dB	

2 Maximum Field values

H-field 10 mm above dipole surface	condition	interpolated maximum
Maximum measured	100 mW forward power	0.459 A/m

Uncertainty for H-field measurement: 8.2% (k=2)

E-field 10 mm above dipole surface	condition	Interpolated maximum
Maximum measured above high end-	100 mW forward power	170.0 V/m
Maximum measured above low end	100 mW forward power	159.5 V/m
Averaged maximum above arm	100 mW forward power	164.8 V/m

Uncertainty for E-field measurement: 12.8% (k=2)

3 Appendix

3.1 Antenna Parameters

Frequency	Return Loss	Impedance
800 MHz	16.1 dB	(44.1 – j13.7) Ohm
835 MHz	28.4 dB	(49.6 + j3.8) Ohm
900 MHz	17.7 dB	(56.0 – j12.6) Ohm
950 MHz	22.0 dB	(47.9 + j7.5) Ohm
960 MHz	16.1 dB	(54.7 + j16.0) Ohm

3.2 Antenna Design and Handling

The calibration dipole has a symmetric geometry with a built-in two stub matching network, which leads to the enhanced bandwidth.

The dipole is built of standard semirigid coaxial cable. The internal matching line is open ended. The antenna is therefore open for DC signals.

Do not apply force to dipole arms, as they are liable to bend. The soldered connections near the feedpoint may be damaged. After excessive mechanical stress or overheating, check the impedance characteristics to ensure that the internal matching network is not affected.

After long term use with 40W radiated power, only a slight warming of the dipole near the feedpoint can be measured.

3.3 Measurement Sheets

X

3.3.1 Return Loss and Smith Chart

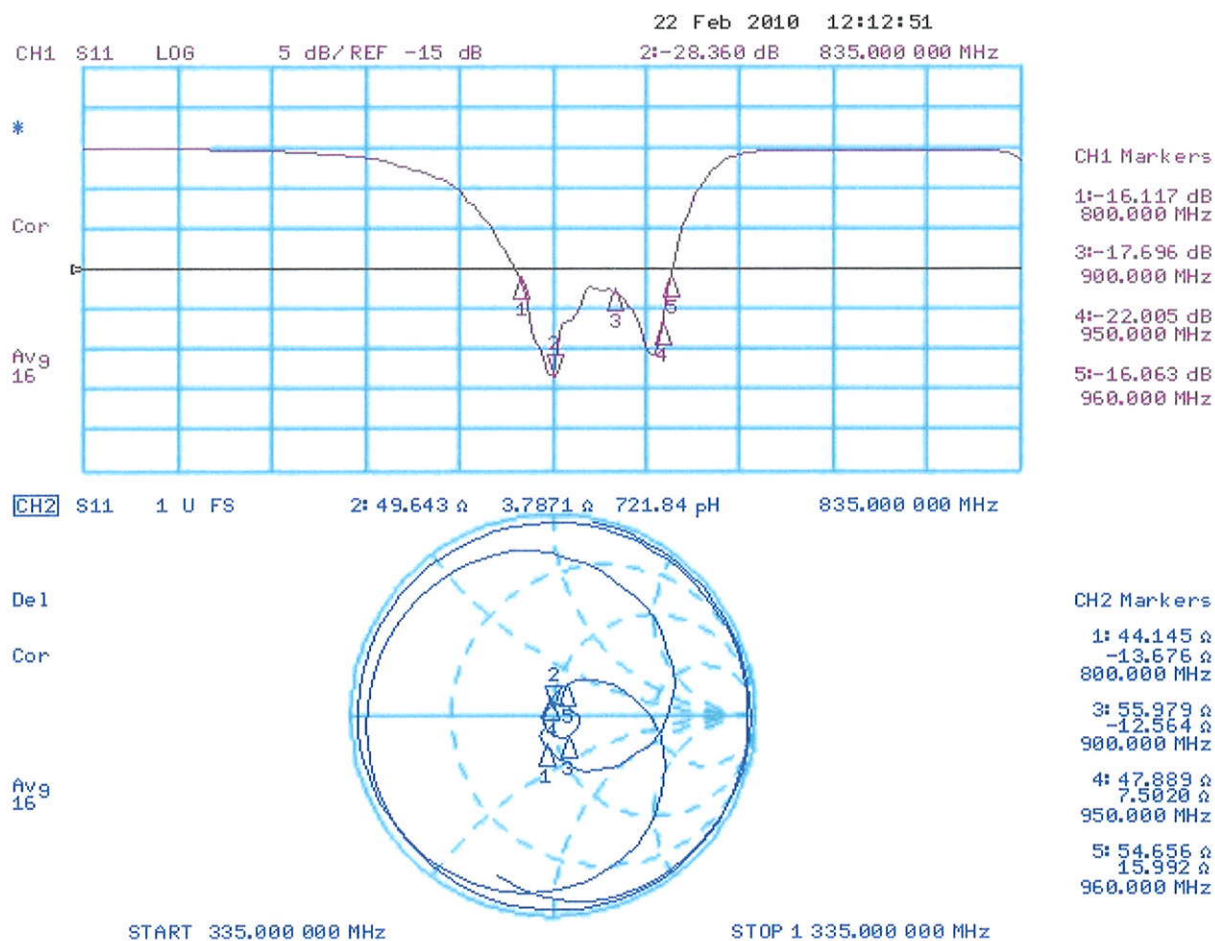

3.3.2 DASY4 H-field Result

Date/Time: 16.02.2010 13:12:57

Test Laboratory: SPEAG Lab2

HAC RF_CD835_1076_100216_H_CL

DUT: HAC-Dipole 835 MHz; Type: CD835V3; Serial: 1076

Communication System: CW; Frequency: 835 MHz;

Medium parameters used: $\sigma = 0$ mho/m, $\epsilon_r = 1$; $\rho = 1$ kg/m³

Phantom section: RF Section

Measurement Standard: DASY5 (IEEE/IEC/ANSI C63.19-2007)

DASY5 Configuration:

- Probe: H3DV6 - SN6065; ; Calibrated: 30.12.2009
- Sensor-Surface: (Fix Surface)
- Electronics: DAE4 Sn781; Calibrated: 22.01.2010
- Phantom: HAC Test Arch with AMCC; Type: SD HAC P01 BA; Serial: 1070
- Measurement SW: DASY5, V5.2 Build 162; SEMCAD X Version 14.0 Build 57

Dipole H-Field measurement @ 835MHz/H Scan - measurement distance from the probe sensor center to CD835 Dipole = 10mm/Hearing Aid Compatibility Test (41x361x1):

Measurement grid: dx=5mm, dy=5mm

Maximum value of peak Total field = 0.459 A/m

Probe Modulation Factor = 1

Device Reference Point: 0, 0, -6.3 mm

Reference Value = 0.487 A/m; Power Drift = 0.013 dB

Hearing Aid Near-Field Category: M4 (AWF 0 dB)

Peak H-field in A/m

Grid 1 0.386 M4	Grid 2 0.399 M4	Grid 3 0.371 M4
Grid 4 0.441 M4	Grid 5 0.459 M4	Grid 6 0.430 M4
Grid 7 0.395 M4	Grid 8 0.414 M4	Grid 9 0.388 M4

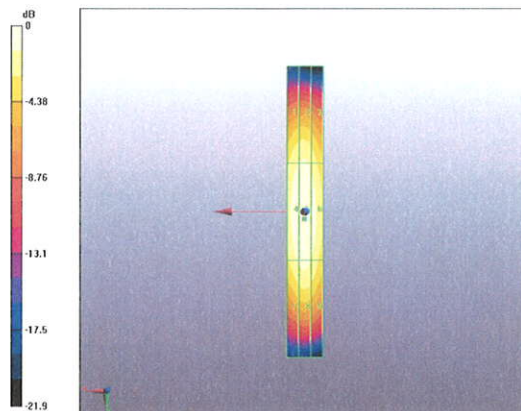

0 dB = 0.459A/m

3.3.3 DASY4 E-field Result

Date/Time: 16.02.2010 17:03:10

Test Laboratory: SPEAG Lab2

HAC RF_CD835_1076_100216_E_CL

DUT: HAC-Dipole 835 MHz; Type: CD835V3; Serial: 1076

Communication System: CW; Frequency: 835 MHz;

Medium parameters used: $\sigma = 0$ mho/m, $\epsilon_r = 1$; $\rho = 1000$ kg/m³

Phantom section: RF Section

Measurement Standard: DASY5 (IEEE/IEC/ANSI C63.19-2007)

DASY5 Configuration:

- Probe: ER3DV6 - SN2336; ConvF(1, 1, 1); Calibrated: 30.12.2009
- Sensor-Surface: (Fix Surface)
- Electronics: DAE4 Sn781; Calibrated: 22.01.2010
- Phantom: HAC Test Arch with AMCC; Type: SD HAC P01 BA; Serial: 1070
- Measurement SW: DASY5, V5.2 Build 162; SEMCAD X Version 14.0 Build 57

Dipole E-Field measurement @ 835MHz/E Scan - measurement distance from the probe sensor center to CD835 Dipole = 10mm/Hearing Aid Compatibility Test (41x361x1):

Measurement grid: dx=5mm, dy=5mm

Maximum value of peak Total field = 170.0 V/m

Probe Modulation Factor = 1

Device Reference Point: 0, 0, -6.3 mm

Reference Value = 106.0 V/m; Power Drift = 0.014 dB

Hearing Aid Near-Field Category: M4 (AWF 0 dB)

Peak E-field in V/m

Grid 1 156.9 M4	Grid 2 159.5 M4	Grid 3 154.8 M4
Grid 4 88.6 M4	Grid 5 90 M4	Grid 6 86.5 M4
Grid 7 161.9 M4	Grid 8 170.0 M4	Grid 9 166.6 M4

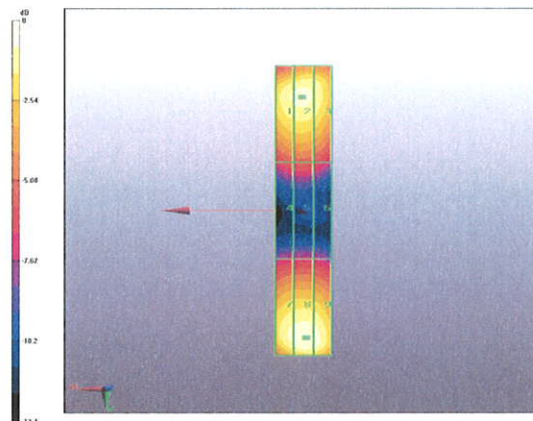

0 dB = 170.0V/m

4. Additional Measurements

4.1 Measurement Conditions

DASY system configuration, as far as not given on page 1.

DASY Version	DASY5	V5.2 B162
DASY PP Version	SEMCAD X	V14.0 B57
Phantom	HAC Test Arch	SD HAC P01 BA, #1070
Distance Dipole Top - Probe Center	10 mm	
Scan resolution	dx, dy = 5 mm	area = 20 x 180 mm
Frequency	813 MHz ± 1 MHz	
Forward power at dipole connector	20.0 dBm = 100mW	
Input power drift	< 0.05 dB	

4.1.1 Maximum Field values

H-field 10 mm above dipole surface	condition	interpolated maximum
Maximum measured	100 mW forward power	0.471 A/m

Uncertainty for H-field measurement: 8.2% (k=2)

E-field 10 mm above dipole surface	condition	Interpolated maximum
Maximum measured above high end-	100 mW forward power	169.1 V/m
Maximum measured above low end	100 mW forward power	168.6 V/m
Averaged maximum above arm	100 mW forward power	168.9 V/m

Uncertainty for E-field measurement: 12.8% (k=2)

4.1.2 DASY4 H-field result

Date/Time: 16.02.2010 12:50:00

Test Laboratory: SPEAG Lab2

HAC RF_CD835_1076_100216_H_CL

DUT: HAC-Dipole 835 MHz; Type: CD835V3; Serial: 1076

Communication System: CW; Frequency: 813 MHz;

Medium parameters used: $\sigma = 0$ mho/m, $\epsilon_r = 1$; $\rho = 1$ kg/m³

Phantom section: RF Section

Measurement Standard: DASY5 (IEEE/IEC/ANSI C63.19-2007)

DASY5 Configuration:

- Probe: H3DV6 - SN6065; ; Calibrated: 30.12.2009
- Sensor-Surface: (Fix Surface)
- Electronics: DAE4 Sn781; Calibrated: 22.01.2010
- Phantom: HAC Test Arch with AMCC; Type: SD HAC P01 BA; Serial: 1070
- Measurement SW: DASY5, V5.2 Build 162; SEMCAD X Version 14.0 Build 57

Dipole H-Field measurement @ 813MHz/H Scan - measurement distance from the probe sensor center to CD835 (813MHz) Dipole = 10mm/Hearing Aid Compatibility Test (41x361x1):

Measurement grid: dx=5mm, dy=5mm

Maximum value of peak Total field = 0.471 A/m

Probe Modulation Factor = 1

Device Reference Point: 0, 0, -6.3 mm

Reference Value = 0.500 A/m; Power Drift = -0.00617 dB

Hearing Aid Near-Field Category: M4 (AWF 0 dB)

Peak H-field in A/m

Grid 1 0.387 M4	Grid 2 0.403 M4	Grid 3 0.378 M4
Grid 4 0.452 M4	Grid 5 0.471 M4	Grid 6 0.440 M4
Grid 7 0.403 M4	Grid 8 0.420 M4	Grid 9 0.390 M4

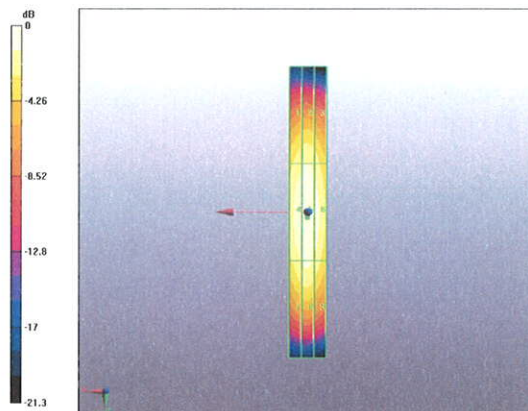

0 dB = 0.471A/m

4.1.3 DASY4 E-field result

Date/Time: 16.02.2010 16:47:06

Test Laboratory: SPEAG Lab2

HAC RF_CD835_1076_100216_E_CL

DUT: HAC-Dipole 835 MHz; Type: CD835V3; Serial: 1076

Communication System: CW; Frequency: 813 MHz

Medium parameters used: $\sigma = 0$ mho/m, $\epsilon_r = 1$; $\rho = 1000$ kg/m³

Phantom section: RF Section

Measurement Standard: DASY5 (IEEE/IEC/ANSI C63.19-2007)

DASY5 Configuration:

- Probe: ER3DV6 - SN2336; ConvF(1, 1, 1); Calibrated: 30.12.2009
- Sensor-Surface: (Fix Surface)
- Electronics: DAE4 Sn781; Calibrated: 22.01.2010
- Phantom: HAC Test Arch with AMCC; Type: SD HAC P01 BA; Serial: 1070
- Measurement SW: DASY5, V5.2 Build 162; SEMCAD X Version 14.0 Build 57

Dipole E-Field measurement @ 813MHz/E Scan - measurement distance from the probe sensor center to CD835 (813MHz) Dipole = 10mm/Hearing Aid Compatibility Test (41x361x1):

Measurement grid: dx=5mm, dy=5mm

Maximum value of peak Total field = 169.1 V/m

Probe Modulation Factor = 1

Device Reference Point: 0, 0, -6.3 mm

Reference Value = 109.2 V/m; Power Drift = 0.013 dB

Hearing Aid Near-Field Category: M4 (AWF 0 dB)

Peak E-field in V/m

Grid 1 165.2 M4	Grid 2 168.6 M4	Grid 3 164.0 M4
Grid 4 94.5 M4	Grid 5 96.4 M4	Grid 6 92.9 M4
Grid 7 161.6 M4	Grid 8 169.1 M4	Grid 9 165.2 M4

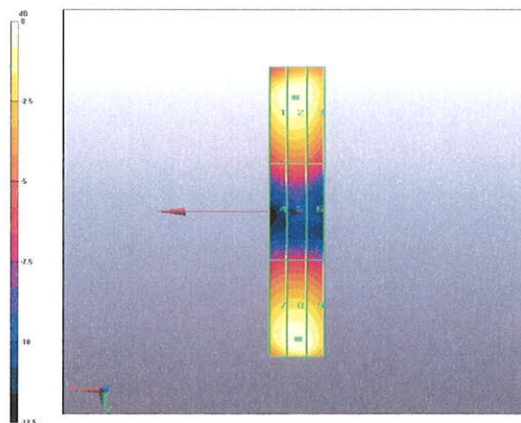

0 dB = 169.1V/m

4.2. Measurement Conditions

DASY system configuration, as far as not given on page 1.

DASY Version	DASY5	V5.2 B162
DASY PP Version	SEMCAD X	V14.0 B57
Phantom	HAC Test Arch	SD HAC P01 BA, #1070
Distance Dipole Top - Probe Center	10 mm	
Scan resolution	dx, dy = 5 mm	area = 20 x 180 mm
Frequency	898 MHz ± 1 MHz	
Forward power at dipole connector	20.0 dBm = 100mW	
Input power drift	< 0.05 dB	

4.2.1 Maximum Field values

H-field 10 mm above dipole surface	condition	interpolated maximum
Maximum measured	100 mW forward power	0.434 A/m

Uncertainty for H-field measurement: 8.2% (k=2)

E-field 10 mm above dipole surface	condition	Interpolated maximum
Maximum measured above high end-	100 mW forward power	160.5 V/m
Maximum measured above low end	100 mW forward power	150.0 V/m
Averaged maximum above arm	100 mW forward power	155.3 V/m

Uncertainty for E-field measurement: 12.8% (k=2)

4.2.2 DASY4 H-field result

Date/Time: 16.02.2010 12:25:41

Test Laboratory: SPEAG Lab2

HAC RF_CD835_1076_100216_H_CL

DUT: HAC-Dipole 835 MHz; Type: CD835V3; Serial: 1076

Communication System: CW; Frequency: 898 MHz;

Medium parameters used: $\sigma = 0$ mho/m, $\epsilon_r = 1$; $\rho = 1$ kg/m³

Phantom section: RF Section

Measurement Standard: DASY5 (IEEE/IEC/ANSI C63.19-2007)

DASY5 Configuration:

- Probe: H3DV6 - SN6065; ; Calibrated: 30.12.2009
- Sensor-Surface: (Fix Surface)
- Electronics: DAE4 Sn781; Calibrated: 22.01.2010
- Phantom: HAC Test Arch with AMCC; Type: SD HAC P01 BA; Serial: 1070
- Measurement SW: DASY5, V5.2 Build 162; SEMCAD X Version 14.0 Build 57

Dipole H-Field measurement @ 898MHz/H Scan - measurement distance from the probe sensor center to CD835 (898MHz) Dipole = 10mm/Hearing Aid Compatibility Test (41x361x1):

Measurement grid: dx=5mm, dy=5mm

Maximum value of peak Total field = 0.434 A/m

Probe Modulation Factor = 1

Device Reference Point: 0, 0, -6.3 mm

Reference Value = 0.455 A/m; Power Drift = -0.014 dB

Hearing Aid Near-Field Category: M4 (AWF 0 dB)

Peak H-field in A/m

Grid 1 0.389 M4	Grid 2 0.403 M4	Grid 3 0.375 M4
Grid 4 0.418 M4	Grid 5 0.434 M4	Grid 6 0.404 M4
Grid 7 0.390 M4	Grid 8 0.408 M4	Grid 9 0.381 M4

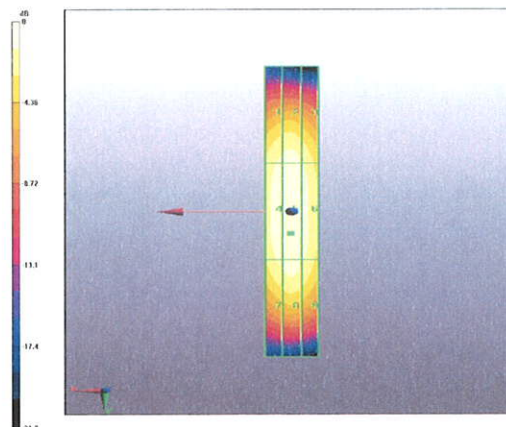

0 dB = 0.434A/m

4.2.3 DASY4 E-field result

Date/Time: 16.02.2010 15:45:32

Test Laboratory: SPEAG Lab2

HAC RF_CD835_1076_100216_E_CL

DUT: HAC-Dipole 835 MHz; Type: CD835V3; Serial: 1076

Communication System: CW; Frequency: 898 MHz;

Medium parameters used: $\sigma = 0$ mho/m, $\epsilon_r = 1$; $\rho = 1000$ kg/m³

Phantom section: RF Section

Measurement Standard: DASY5 (IEEE/IEC/ANSI C63.19-2007)

DASY5 Configuration:

- Probe: ER3DV6 - SN2336; ConvF(1, 1, 1); Calibrated: 30.12.2009
- Sensor-Surface: (Fix Surface)
- Electronics: DAE4 Sn781; Calibrated: 22.01.2010
- Phantom: HAC Test Arch with AMCC; Type: SD HAC P01 BA; Serial: 1070
- Measurement SW: DASY5, V5.2 Build 162; SEMCAD X Version 14.0 Build 57

Dipole E-Field measurement @ 898MHz/E Scan - measurement distance from the probe sensor center to CD835 (898MHz) Dipole = 10mm/Hearing Aid Compatibility Test (41x361x1):

Measurement grid: dx=5mm, dy=5mm

Maximum value of peak Total field = 160.5 V/m

Probe Modulation Factor = 1

Device Reference Point: 0, 0, -6.3 mm

Reference Value = 86.1 V/m; Power Drift = -0.00063 dB

Hearing Aid Near-Field Category: M4 (AWF 0 dB)

Peak E-field in V/m

Grid 1 149.9 M4	Grid 2 150.0 M4	Grid 3 137.3 M4
Grid 4 81 M4	Grid 5 81 M4	Grid 6 73.9 M4
Grid 7 156.7 M4	Grid 8 160.5 M4	Grid 9 148.9 M4

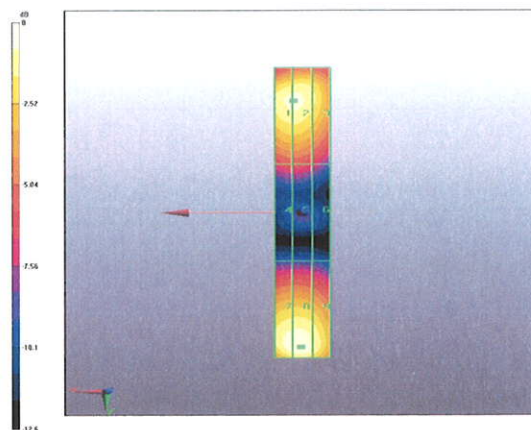

0 dB = 160.5V/m



Accredited by the Swiss Accreditation Service (SAS)
The Swiss Accreditation Service is one of the signatories to the EA
Multilateral Agreement for the recognition of calibration certificates

Accreditation No.: **SCS 108**

Client **Motorola MDb**

Certificate No: **CD1880V3-1034_Feb10**

CALIBRATION CERTIFICATE

Object **CD1880V3 - SN: 1034**

Calibration procedure(s) **QA CAL-20.v5
Calibration procedure for dipoles in air**

Calibration date: **February 17, 2010**

This calibration certificate documents the traceability to national standards, which realize the physical units of measurements (SI).
All calibrations have been conducted in the closed laboratory facility: environment temperature (22 ± 3)°C and humidity < 70%.

Calibration Equipment used (M&TE critical for calibration)

Primary Standards	ID #	Cal Date (Certificate No.)	Scheduled Calibration
Power meter EPM-442A	GB37480704	06-Oct-09 (No. 217-01086)	Oct-10
Power sensor HP 8481A	US37292783	06-Oct-09 (No. 217-01086)	Oct-10
Probe ER3DV6	SN: 2336	30-Dec-09 (No. ER3-2336_Dec09)	Dec-10
Probe H3DV6	SN: 6065	30-Dec-09 (No. H3-6065_Dec09)	Dec-10
DAE4	SN: 781	22-Jan-10 (No. DAE4-781_Jan10)	Jan-11

Secondary Standards	ID #	Check Date (in house)	Scheduled Check
Power meter Agilent 4419B	SN: GB42420191	09-Oct-09 (in house check Oct-09)	In house check: Oct-10
Power sensor HP 8482H	SN: 3318A09450	09-Oct-09 (in house check Oct-09)	In house check: Oct-10
Power sensor HP 8482A	SN: US37295597	09-Oct-09 (in house check Oct-09)	In house check: Oct-10
Network Analyzer HP 8753E	US37390585	18-Oct-01 (in house check Oct-09)	In house check: Oct-10
RF generator E4433B	MY 41000675	03-Nov-04 (in house check Oct-09)	In house check: Oct-11

Calibrated by: **Name** Mike Meili **Function** Laboratory Technician

Signature

Approved by: **Name** Fin Bomholt **Function** Technical Director

Issued: February 22, 2010

This calibration certificate shall not be reproduced except in full without written approval of the laboratory.



Accredited by the Swiss Accreditation Service (SAS)
The Swiss Accreditation Service is one of the signatories to the EA
Multilateral Agreement for the recognition of calibration certificates

Accreditation No.: **SCS 108**

References

- [1] ANSI-C63.19-2006
American National Standard for Methods of Measurement of Compatibility between Wireless Communications Devices and Hearing Aids.
- [2] ANSI-C63.19-2007
American National Standard for Methods of Measurement of Compatibility between Wireless Communications Devices and Hearing Aids.

Methods Applied and Interpretation of Parameters:

- *Coordinate System:* y-axis is in the direction of the dipole arms. z-axis is from the basis of the antenna (mounted on the table) towards its feed point between the two dipole arms. x-axis is normal to the other axes. In coincidence with the standards [1, 2], the measurement planes (probe sensor center) are selected to be at a distance of 10 mm above the top edge of the dipole arms.
- *Measurement Conditions:* Further details are available from the hardcopies at the end of the certificate. All figures stated in the certificate are valid at the frequency indicated. The forward power to the dipole connector is set with a calibrated power meter connected and monitored with an auxiliary power meter connected to a directional coupler. While the dipole under test is connected, the forward power is adjusted to the same level.
- *Antenna Positioning:* The dipole is mounted on a HAC Test Arch phantom using the matching dipole positioner with the arms horizontal and the feeding cable coming from the floor. The measurements are performed in a shielded room with absorbers around the setup to reduce the reflections. It is verified before the mounting of the dipole under the Test Arch phantom, that its arms are perfectly in a line. It is installed on the HAC dipole positioner with its arms parallel below the dielectric reference wire and able to move elastically in vertical direction without changing its relative position to the top center of the Test Arch phantom. The vertical distance to the probe is adjusted after dipole mounting with a DASY5 Surface Check job. Before the measurement, the distance between phantom surface and probe tip is verified. The proper measurement distance is selected by choosing the matching section of the HAC Test Arch phantom with the proper device reference point (upper surface of the dipole) and the matching grid reference point (tip of the probe) considering the probe sensor offset. The vertical distance to the probe is essential for the accuracy.
- *Feed Point Impedance and Return Loss:* These parameters are measured using a HP 8753E Vector Network Analyzer. The impedance is specified at the SMA connector of the dipole. The influence of reflections was eliminating by applying the averaging function while moving the dipole in the air, at least 70cm away from any obstacles.
- *E-field distribution:* E field is measured in the x-y-plane with an isotropic ER3D-field probe with 100 mW forward power to the antenna feed point. In accordance with [1, 2], the scan area is 20mm wide, its length exceeds the dipole arm length (180 or 90mm). The sensor center is 10 mm (in z) above the top of the dipole arms. Two 3D maxima are available near the end of the dipole arms. Assuming the dipole arms are perfectly in one line, the average of these two maxima (in subgrid 2 and subgrid 8) is determined to compensate for any non-parallelity to the measurement plane as well as the sensor displacement. The E-field value stated as calibration value represents the maximum of the interpolated 3D-E-field, 10mm above the dipole surface.
- *H-field distribution:* H-field is measured with an isotropic H-field probe with 100mW forward power to the antenna feed point, in the x-y-plane. The scan area and sensor distance is equivalent to the E-field scan. The maximum of the field is available at the center (subgrid 5) above the feed point. The H-field value stated as calibration value represents the maximum of the interpolated H-field, 10mm above the dipole surface at the feed point.

1. Measurement Conditions

DASY system configuration, as far as not given on page 1.

DASY Version	DASY5	V5.2 B162
DASY PP Version	SEMCAD X	V14.0 B59
Phantom	HAC Test Arch	SD HAC P01 BA, #1070
Distance Dipole Top - Probe Center	10 mm	
Scan resolution	dx, dy = 5 mm	area = 20 x 90 mm
Frequency	1880 MHz ± 1 MHz	
Forward power at dipole connector	20.0 dBm = 100mW	
Input power drift	< 0.05 dB	

2. Maximum Field values

H-field 10 mm above dipole surface	condition	Interpolated maximum
Maximum measured	100 mW forward power	0.468 A/m

Uncertainty for H-field measurement: 8.2% (k=2)

E-field 10 mm above dipole surface	condition	Interpolated maximum
Maximum measured above high end	100 mW forward power	138.7 V/m
Maximum measured above low end	100 mW forward power	137.0 V/m
Averaged maximum above arm	100 mW forward power	137.9 V/m

Uncertainty for E-field measurement: 12.8% (k=2)

3. Appendix

3.1 Antenna Parameters

Frequency	Return Loss	Impedance
1710 MHz	18.4 dB	(47.4 + j11.5) Ohm
1880 MHz	21.4 dB	(52.9 + j8.3) Ohm
1900 MHz	21.9 dB	(55.1 + j6.7) Ohm
1950 MHz	28.4 dB	(53.6 – j1.6) Ohm
2000 MHz	19.6 dB	(40.5 + j0.8) Ohm

3.2 Antenna Design and Handling

The calibration dipole has a symmetric geometry with a built-in two stub matching network, which leads to the enhanced bandwidth.

The dipole is built of standard semirigid coaxial cable. The internal matching line is open ended. The antenna is therefore open for DC signals.

Do not apply force to dipole arms, as they are liable to bend. The soldered connections near the feedpoint may be damaged. After excessive mechanical stress or overheating, check the impedance characteristics to ensure that the internal matching network is not affected.

After long term use with 40W radiated power, only a slight warming of the dipole near the feedpoint can be measured.

3.3 Measurement Sheets

3.3.1 Return Loss and Smith Chart

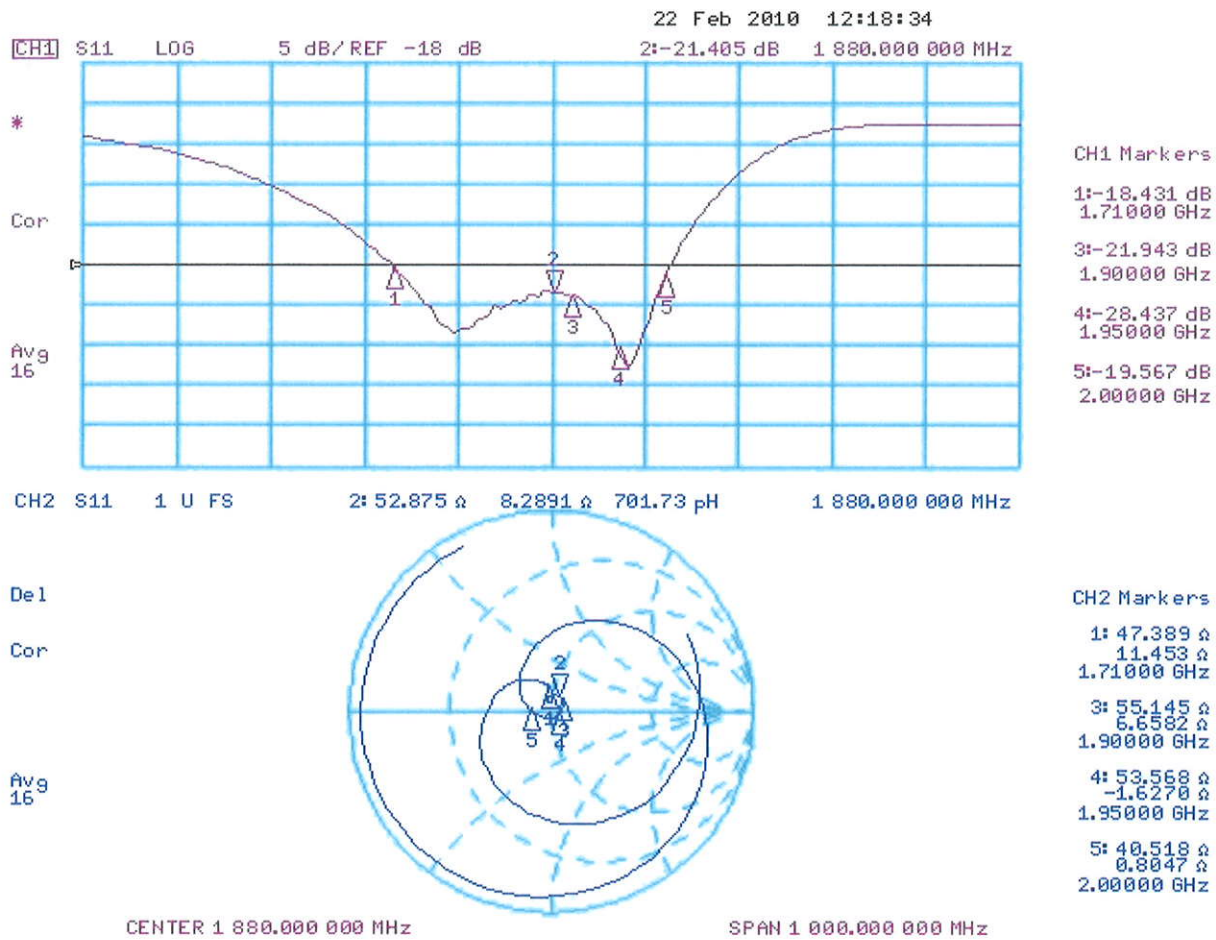

3.3.2 DASYS H-Field Result

Date/Time: 17.02.2010 12:17:14

Test Laboratory: SPEAG Lab2

DUT: HAC Dipole 1880 MHz; Type: CD1880V3; Serial: 1034

Communication System: CW; Communication System Band: CD1880 (1880.0 MHz); Frequency: 1880 MHz;

Communication System PAR: 0 dB

Medium parameters used: $\sigma = 0$ mho/m, $\epsilon_r = 1$; $\rho = 1$ kg/m³

Phantom section: RF Section

Measurement Standard: DASYS (IEEE/IEC/ANSI C63.19-2007)

DASY5 Configuration:

- Probe: H3DV6 - SN6065; ; Calibrated: 30.12.2009
- Sensor-Surface: (Fix Surface)
- Electronics: DAE4 Sn781; Calibrated: 22.01.2010
- Phantom: HAC Test Arch with AMCC; Type: SD HAC P01 BA; Serial: 1070
- Measurement SW: DASYS, V5.2 Build 162; SEMCAD X Version 14.0 Build 59

Dipole H-Field measurement @ 1880MHz/H Scan - measurement distance from the probe sensor center to CD1880

Dipole = 10mm/Hearing Aid Compatibility Test (41x181x1): Measurement grid: dx=5mm, dy=5mm

Maximum value of peak Total field = 0.468 A/m

Probe Modulation Factor = 1

Device Reference Point: 0, 0, -6.3 mm

Reference Value = 0.496 A/m; Power Drift = 0.000739 dB

Hearing Aid Near-Field Category: M2 (AWF 0 dB)

Peak H-field in A/m

Grid 1 0.400 M2	Grid 2 0.419 M2	Grid 3 0.399 M2
Grid 4 0.445 M2	Grid 5 0.468 M2	Grid 6 0.448 M2
Grid 7 0.414 M2	Grid 8 0.437 M2	Grid 9 0.416 M2

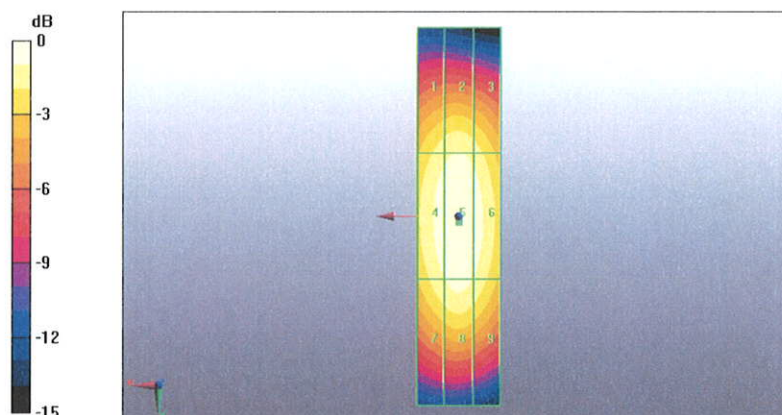

0 dB = 0.468A/m

3.3.3 DASY4 E-Field Result

Date/Time: 17.02.2010 13:39:03

Test Laboratory: SPEAG Lab2

DUT: HAC Dipole 1880 MHz; Type: CD1880V3; Serial: 1034

Communication System: CW; Communication System Band: CD1880 (1880.0 MHz); Frequency: 1880 MHz;

Communication System PAR: 0 dB

Medium parameters used: $\sigma = 0$ mho/m, $\epsilon_r = 1$; $\rho = 1000$ kg/m³

Phantom section: RF Section

Measurement Standard: DASY5 (IEEE/IEC/ANSI C63.19-2007)

DASY5 Configuration:

- Probe: ER3DV6 - SN2336; ConvF(1, 1, 1); Calibrated: 30.12.2009
- Sensor-Surface: (Fix Surface)
- Electronics: DAE4 Sn781; Calibrated: 22.01.2010
- Phantom: HAC Test Arch with AMCC; Type: SD HAC P01 BA; Serial: 1070
- Measurement SW: DASY5, V5.2 Build 162; SEMCAD X Version 14.0 Build 59

Dipole E-Field measurement @ 1880MHz/E Scan - measurement distance from the probe sensor center to CD1880

Dipole = 10mm/Hearing Aid Compatibility Test (41x181x1): Measurement grid: dx=5mm, dy=5mm

Maximum value of peak Total field = 138.7 V/m

Probe Modulation Factor = 1

Device Reference Point: 0, 0, -6.3 mm

Reference Value = 155.7 V/m; Power Drift = -0.015 dB

Hearing Aid Near-Field Category: M2 (AWF 0 dB)

Peak E-field in V/m

Grid 1 134.0 M2	Grid 2 137.0 M2	Grid 3 132.7 M2
Grid 4 90.3 M3	Grid 5 92 M3	Grid 6 87.8 M3
Grid 7 131.8 M2	Grid 8 138.7 M2	Grid 9 135.1 M2

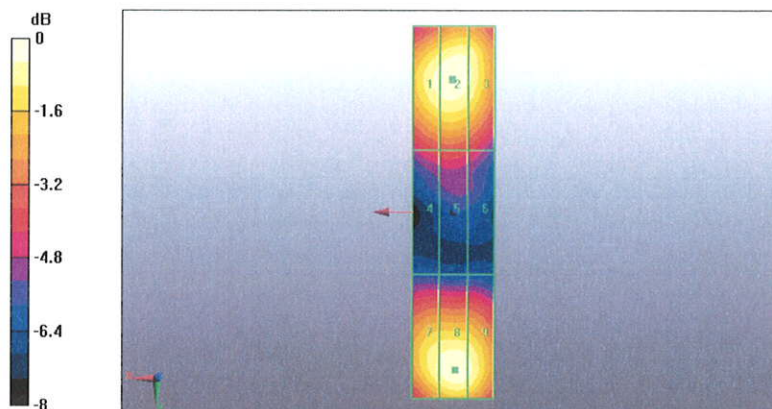

0 dB = 138.7V/m

4. Additional Measurements

4.1 Measurement Conditions

DASY system configuration, as far as not given on page 1.

DASY Version	DASY5	V5.2 B162
DASY PP Version	SEMCAD X	V14.0 B59
Phantom	HAC Test Arch	SD HAC P01 BA, #1070
Distance Dipole Top - Probe Center	10 mm	
Scan resolution	dx, dy = 5 mm	area = 20 x 90 mm
Frequency	1730 MHz ± 1 MHz	
Forward power at dipole connector	20.0 dBm = 100mW	
Input power drift	< 0.05 dB	

4.1.1 Maximum Field values

H-field 10 mm above dipole surface	condition	interpolated maximum
Maximum measured	100 mW forward power	0.484 A/m

Uncertainty for H-field measurement: 8.2% (k=2)

E-field 10 mm above dipole surface	condition	Interpolated maximum
Maximum measured above high end	100 mW forward power	150.0 V/m
Maximum measured above low end	100 mW forward power	145.2 V/m
Averaged maximum above arm	100 mW forward power	147.6 V/m

Uncertainty for E-field measurement: 12.8% (k=2)

4.1.2 DASY4 H-field result

Date/Time: 17.02.2010 12:30:53

Test Laboratory: SPEAG Lab2

DUT: HAC Dipole 1880 MHz; Type: CD1880V3; Serial: 1034

Communication System: CW; Communication System Band: CD1880 (1880.0 MHz); Frequency: 1730

MHz; Communication System PAR: 0 dB

Medium parameters used: $\sigma = 0$ mho/m, $\epsilon_r = 1$; $\rho = 1$ kg/m³

Phantom section: RF Section

Measurement Standard: DASY5 (IEEE/IEC/ANSI C63.19-2007)

DASY5 Configuration:

- Probe: H3DV6 - SN6065; ; Calibrated: 30.12.2009
- Sensor-Surface: (Fix Surface)
- Electronics: DAE4 Sn781; Calibrated: 22.01.2010
- Phantom: HAC Test Arch with AMCC; Type: SD HAC P01 BA; Serial: 1070
- Measurement SW: DASY5, V5.2 Build 162; SEMCAD X Version 14.0 Build 59

Dipole H-Field measurement @ 1880MHz/H Scan - measurement distance from the probe sensor center to CD1880

Dipole = 10mm @ 1730 MHz/Hearing Aid Compatibility Test (41x181x1): Measurement grid: dx=5mm, dy=5mm

Maximum value of peak Total field = 0.484 A/m

Probe Modulation Factor = 1

Device Reference Point: 0, 0, -6.3 mm

Reference Value = 0.516 A/m; Power Drift = -0.014 dB

Hearing Aid Near-Field Category: M2 (AWF 0 dB)

Peak H-field in A/m

Grid 1 0.394 M2	Grid 2 0.414 M2	Grid 3 0.395 M2
Grid 4 0.456 M2	Grid 5 0.484 M2	Grid 6 0.464 M2
Grid 7 0.411 M2	Grid 8 0.437 M2	Grid 9 0.416 M2

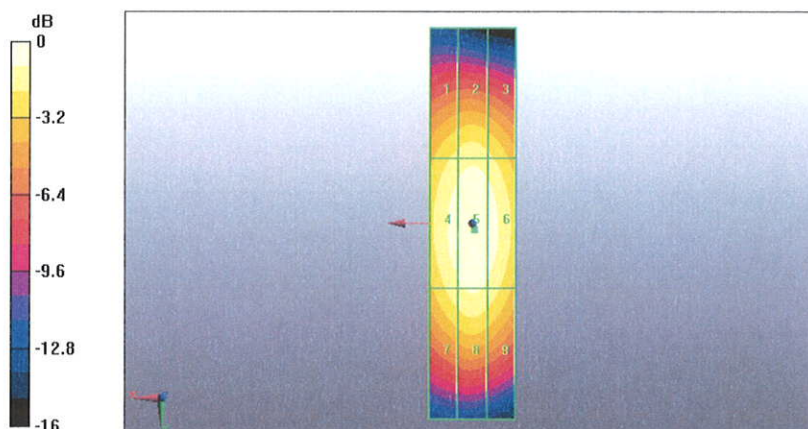

0 dB = 0.484A/m

4.1.3 DASY4 E-field result

Date/Time: 17.02.2010 14:08:16

Test Laboratory: SPEAG Lab2

DUT: HAC Dipole 1880 MHz; Type: CD1880V3; Serial: 1034

Communication System: CW; Communication System Band: CD1880 (1880.0 MHz); Frequency: 1730 MHz; Communication System PAR: 0 dB

Medium parameters used: $\sigma = 0$ mho/m, $\epsilon_r = 1$; $\rho = 1000$ kg/m³

Phantom section: RF Section

Measurement Standard: DASY5 (IEEE/IEC/ANSI C63.19-2007)

DASY5 Configuration:

- Probe: ER3DV6 - SN2336; ConvF(1, 1, 1); Calibrated: 30.12.2009
- Sensor-Surface: (Fix Surface)
- Electronics: DAE4 Sn781; Calibrated: 22.01.2010
- Phantom: HAC Test Arch with AMCC; Type: SD HAC P01 BA; Serial: 1070
- Measurement SW: DASY5, V5.2 Build 162; SEMCAD X Version 14.0 Build 59

Dipole E-Field measurement @ 1880MHz/E Scan - measurement distance from the probe sensor center to CD1880

Dipole = 10mm @ 1730 MHz/Hearing Aid Compatibility Test (41x181x1): Measurement grid: dx=5mm, dy=5mm

Maximum value of peak Total field = 150.0 V/m

Probe Modulation Factor = 1

Device Reference Point: 0, 0, -6.3 mm

Reference Value = 168.8 V/m; Power Drift = 0.012 dB

Hearing Aid Near-Field Category: M2 (AWF 0 dB)

Peak E-field in V/m

Grid 1 141.5 M2	Grid 2 145.2 M2	Grid 3 141.6 M2
Grid 4 101.0 M3	Grid 5 103.4 M3	Grid 6 99.2 M3
Grid 7 141.7 M2	Grid 8 150.0 M2	Grid 9 146.8 M2

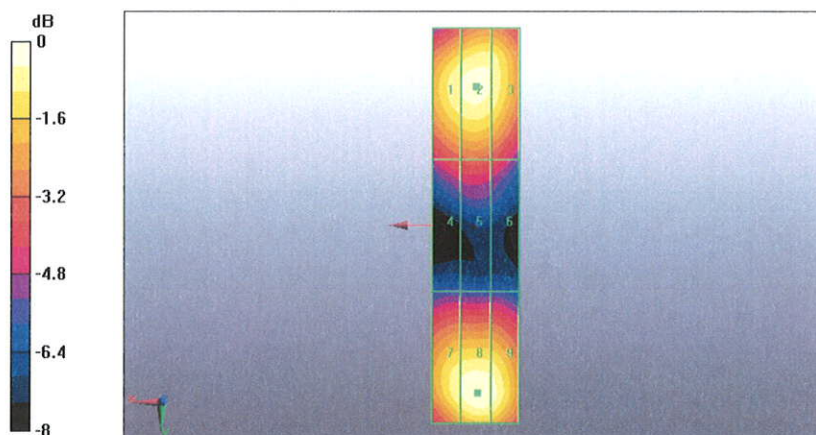

0 dB = 150.0V/m

END OF REPORT