



## HAC Test Report for Telecoil IHDT56LB1

**Date of test:** Mar-10-2010

**Date of Report:** Mar-11-2010

**Laboratory:** Motorola Mobile Devices Business Product Safety & Compliance Laboratory  
600 N. US Highway 45  
Libertyville, Illinois 60048

**Test Responsible:** Thomas Knipple  
Senior RF Engineer

**Statement of Compliance:** Motorola declares under its sole responsibility that portable cellular telephone FCC IHDT56LB1 to which this declaration relates, complies with recommendations and guidelines FCC 47 CFR §20.19. The measurements were performed to ensure compliance to the ANSI C63.19-2007. It also declares that the product was tested in accordance with the appropriate measurement standards, guidelines and recommended practices. Any deviations from these standards, guidelines and recommended practices are noted below:

(none)

**Results Summary:** T Category = T3

©Motorola, Inc. 2010

This test report shall not be reproduced except in full, without written approval of the laboratory.

The results and statements contained herein relate only to the items tested. The names of individuals involved may be mentioned only in connection with the statements or results from this report.

Motorola encourages all feedback, both positive and negative, on this test report.

### Table of Contents

**1. INTRODUCTION .....3**

**2. DESCRIPTION OF THE DEVICE UNDER TEST.....3**

**3. TEST EQUIPMENT USED.....4**

**4. SIGNAL VERIFICATION.....7**

**5. TEST RESULTS.....8**

**5.1 Telecoil SNR Results .....8**

**5.2 Telecoil Environment Results.....11**

**6. MEASUREMENTS FOR CERTIFICATION OF 3G DEVICES.....13**

**APPENDIX 1: CONTOUR PLOTS.....14**

**APPENDIX 2: AMBIENT NOISE SPECTRUM PLOTS .....19**

**APPENDIX 3: DETAILS ON THE MEASUREMENT SYSTEMS.....22**

**APPENDIX 4: PICTURES OF TEST SETUP .....29**

**APPENDIX 5: MOTOROLA UNCERTAINTY BUDGET .....30**

**APPENDIX 6: AUDIO MAGNETIC PROBE CERTIFICATE .....32**

**APPENDIX 7: AMCC CERTIFICATE (HELMHOLZ COIL).....33**

**APPENDIX 8: HAC DISTRIBUTION PLOTS FOR E-FIELD AND H-FIELD .....34**

## 1. Introduction

The Motorola Mobile Devices Business Product Safety Laboratory has performed Hearing Aid Compatibility (HAC) measurements for the portable cellular phone (FCC ID IHDT56LB1). The portable cellular phone was tested in accordance with ANSI/IEEE standard C63.19-2007. The test results presented herein clearly demonstrate compliance FCC 47 CFR § 20.19. This report demonstrates compliance for Telecoil performance only and not for RF near-field emissions.

## 2. Description of the Device Under Test

**Table 1: Information for the Device Under Test**

Serial Number(s)	LSOV290121, LSOV290109					
Mode(s) of Operation	CDMA 800	CDMA 1900	EV-DO Rev. A 800	EV-DO Rev. A 1900	Wi-Fi 802.11b/g/n	Bluetooth
Modulation Mode(s)	QPSK	QPSK	QPSK	QPSK	BPSK	GFSK
Maximum Output Power Setting	25.0 dBm	25.0 dBm	25.0 dBm	25.0 dBm	20.5 dBm	10 dBm
Duty Cycle	1:1	1:1	1:1	1:1	1:1	1:1
Transmitting Frequency Range(s)	824.70 - 848.31 MHz	1851.20 - 1908.75 MHz	824.70 - 848.31 MHz	1851.20 - 1908.75 MHz	2412.0 - 2462.5 MHz	2402.0 - 2483.5 MHz
Production Unit or Identical Prototype (47 CFR §2.908)	Identical Prototype					
Device Category	Portable					
RF Exposure Limits	General Population / Uncontrolled					

Note: No Bluetooth profile exists in this phone that will allow a Bluetooth link while in a cellular call that passes audio to the earpiece. If the user had Bluetooth enabled and a link established, they could not be listening to the phone through the earpiece.

Note: Wi-Fi capability is included in this phone without measurements for hearing aid compatibility based on the interim ruling by the FCC according to paragraph 37 of the Federal Register, Volume 3, Number 89, as of May 7, 2008. Users shall be informed of this via the product user guide per the same FCC ruling.

### 3. Test Equipment Used

The Motorola Mobile Devices Business Product Safety & Compliance Laboratory utilizes a Dosimetric Assessment System (Dasy4™ v4.7) manufactured by Schmid & Partner Engineering AG (SPEAG™) of Zurich, Switzerland. All Telecoil measurements are taken within a shielded enclosure. The measurement uncertainty budget is given in Appendix 5. The list of calibrated equipment used for the measurements is shown in Table 2.

**Table 2: Test Equipment**

	Description	Serial Number	Cal Due Date
<b>Dosimetric System Equipment</b>	DAE3	639	Sep-17-2010
	Audio Magnetic 1D Field Probe AM1DV2	1049	
	AMMI SE UMS 010 AA	1005	
	AMCC SD HAC P02 AB	1005	
	Test Arch SD HAC P01 BA	1073	
<b>Additional Test Equipment</b>	Rohde & Schwarz CMU 200	110518	Aug-22-2010

**Figure 1: Telecoil setup and cabling (pictures from DASY manual)**

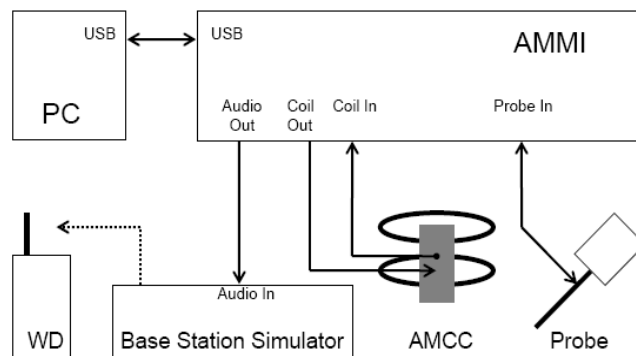

AMMI (Audio Magnetic Measurement Instrument) is a desktop unit containing a sampling unit, a waveform generator for test, calibration signals and a USB interface. Front connectors include: Audio Out - predefined or user definable audio signals for injection into the WD; Probe In - the probe signal is evaluated by AMMI; Coil Out - test and calibration signal to the AMCC; Coil In - monitor signal from the AMCC.

Audio Magnetic Probe (AM1DV2) is an active probe with a single sensor. The same probe coil is used to measure three orthogonal field components (axial, radial 1, radial 2). The probe is rotated to properly orient the coil for each field component. Probe's frequency response, linearity and other characteristics are given in the certificate in Appendix 6.

AMCC (Audio Magnetic Calibration Coil) is a Helmholtz coil for calibration of the AM1D probe. The two horizontal coils create a homogeneous magnetic field in the z direction. Refer to Appendix 7 for more details on AMCC coil.

The probe is calibrated in AMCC coil. The frequency response and sensitivity are measured and stored. Sensitivity includes both probe sensitivity and pre-amplifier sensitivity.

**Graph 1: Frequency Response measured in AMCC**

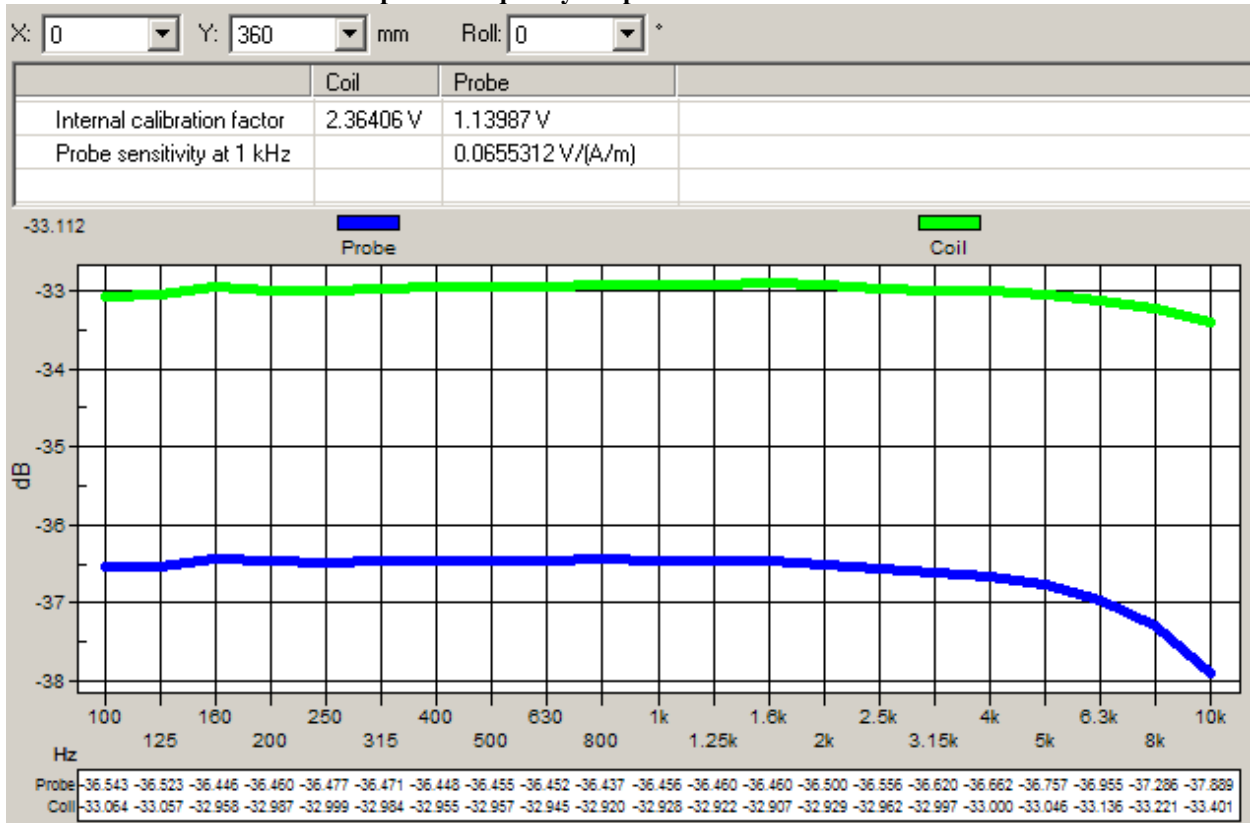

Sensitivity measured in AMCC:  $0.0655312 \text{ V}/_{(A/m)}$

The sensitivity is for 1 kHz sine signal. The sensitivity includes both probe sensitivity and pre-amplifier sensitivity. It is the total calibration, and there are no additional probe calibration factors. The voltage into the Helmholtz coil is across the shunt resistor.

#### 4. Signal Verification

An Input Level is measured to verify that it is within  $\pm 0.2$  dB from the Reference Input Level in section 6.3.2.1 of ANSI/IEEE C63.19-2007.

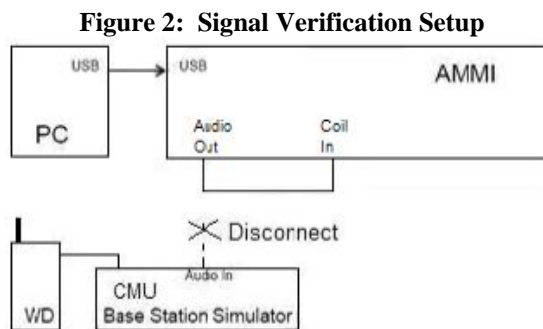

In Figure 2 setup, “Audio Out” of the AMMI is connected to the “Coil In” of the AMMI. The “Audio Out” of the AMMI is measured using 1 V as the reference.

Section 6.3.2.1 of ANSI/IEEE C63.19-2007 specifies the reference input level to be -18 for CDMA. Each CMU has a slightly different “0dBm0 Input Reference” value that must be measured. When the CMU box is replaced or externally re-calibrated, an internal calibration procedure must be completed in each transmission mode. On the CMU 200 (SN 110518), the 0dBm0 Input Reference value is 0.73 V for CDMA. For more information on “0dBm0 Input Reference” measurements, refer to Appendix 3-5.

The Target Level for “Audio Out” of the AMMI is shown in Table 3. This target level takes into account the difference between the AMMI’s and CMU’s reference levels.

**Table 3: Measured Input Level**

Modulation	Reference Input Level from ANSI C63.19 (dBm0)	CMU’s 0dBm0 Input Reference Value (dB)	Target Level for “Audio Out” of AMMI (dBm0)
CDMA	-18	-2.73	-20.73

The signal level for “Audio Out” of the AMMI is measured. Signal Verification has been conducted on the same days as DUT measurements. If it is not within  $\pm 0.2$  dB, the gain settings in the DASY template are adjusted. The obtained results are displayed in Table 4.

**Table 4: Measured Input Level**

Modulation	Measured date	Signal	Measured Level for “Audio Out” of AMMI (dBm0)	Target Level for “Audio Out” of AMMI (dBm0)
CDMA	Mar-10-2010	Narrowband	-20.70	-20.73
		Broadband	-20.76	

## 5. Test Results

### 5.1 Telecoil SNR Results

The phone was tested in normal configurations for against-the-ear use. The DASY4 v4.7 measurement system specified in section 3.1 was utilized within the intended operations as set by the SPEAG™ setup. The Test Arch provided by SPEAG is used to position the DUT. All tests are done via conducted setup with CMU 200. The volume on the phone is adjusted to maximum. Backlight was off during testing, and HAC compliance will be explained in the manual.

The tests are performed with a software telecoil function enabled. To enable the telecoil function, select:  
*Main Menu → Settings → Call Settings → Hearing Aids → [Mark Box to Enable]*

The Cellular Phone model covered by this report has the following battery options:  
 Battery #1: SNN5846A - 1390 mAh Battery

The distance is established by positioning the device beneath the test arch phantom so that it is touching the frame. The location and thickness of the arch, and the location/orientation of the coil within the probe housing, are precisely known values in the DASY software. The height of the measurement plane is further fine-tuned by performing a Surface Detection job at the beginning of each test. The end result is that the probe sensor is very precisely located 10 mm above the device reference plane.

ABM2 investigation has been carried out to determine the highest channel / frequency of each applicable frequency band. At the location of the Telecoil source, ABM2 is measured in the axial probe position for each frequency (Table 5). For each band, the channel with the highest ABM2 measurement is highlighted in **bold**.

**Table 5: ABM2 measurements across the frequency band for the portable cellular telephone at highest possible output power.**

ABM2 Measurements (dB A/m)		
CDMA 800	Ch 1013	-40.6194
	Ch 384	-41.5830
	Ch 777	<b>-40.4437</b>
CDMA 1900	Ch 25	-40.2981
	Ch 600	<b>-39.7451</b>
	Ch 1175	-40.0112

For the channels highlighted in bold in Table 5, Telecoil SNR measurements are shown in Table 6. The sequence of the Telecoil SNR measurement is listed in steps below.

- a) Geometry & signal check
- b) Background noise measurement. The background noise is measured at the center of the listening area.
- c) Coarse resolution axial scan (narrowband signal, 1 s measurement times, 50 x 50 mm grid with 5.55 mm spacing). Only ABM1 is measured in order to find the location of the Telecoil source.
- d) Fine resolution axial, radial-transverse, & radial-longitudinal scans, positioned appropriately based on optimal ABM1 of coarse resolution axial scan (narrowband signal, 1 s measurement times, variable grid size with 2 mm spacing). Both ABM1 and ABM2 are measured in order to find the location of the SNR point.
- e) ABM1 & ABM2 point measurements in axial, radial-transverse, & radial-longitudinal coil orientations, positioned appropriately based on optimal signal quality of fine resolution scans (narrowband signal, 2 s measurement times). SNR is calculated for each coil orientation.
- f) Frequency Response point measurement in axial coil orientation, positioned appropriately based on optimal signal quality of fine resolution axial scan (broadband signal, 12 s measurement time)

The ABM1, SNR and Telecoil Rating results are shown in Table 6. Also shown are the location of the measured point, noise and ABM2. The delta between Ambient Noise measurement and ABM2 measurement should be greater than 10 dB. However, in cases where ABM2 is very low, it is suitable for the delta to be less than 10 dB. For the three probe positions, contour plots for the lowest SNR, indicated in **bold numbers**, are given in Appendix 1. For the three probe positions, noise spectrum plots for the highest ambient noise, indicated with **bold numbers**, are given in Appendix 2. These noise spectrum plots are half band integrated with an A-weight filter applied.

Telecoil SNR Limits		
ABM 1	Greater or equal to -18 dB A/m	
SNR	T3	Greater than 20 dB
	T4	Greater than 30 dB

**Table 6: Telecoil SNR measurement results for the portable cellular telephone at highest possible output power**

Probe Position	Frequency Band (MHz)	Channel	Measured Point Location (x mm, y mm)	Ambient Noise (dB A/m)	ABM2 (dB A/m)	ABM2 – Ambient Noise (dB)	ABM1 (dB A/m)	SNR (dB)	Telecoil SNR Rating
Axial	CDMA 800	777	-1.2, -1.2	-58.0525	-29.1148	28.9377	0.1481	29.26	T3
	CDMA 1900	600	-0.4, -2.8	<b>-56.6211</b>	-27.1170	29.5041	0.7778	<b>27.89</b>	T3
Radial 1	CDMA 800	777	10.8, -1.2	-58.3432	-34.5242	23.8190	-10.6700	<b>23.86</b>	T3
	CDMA 1900	600	11.6, 3.2	<b>-56.9840</b>	-38.0524	18.9316	-12.4894	25.56	T3
Radial 2	CDMA 800	777	-3.2, -9.2	<b>-57.4060</b>	-48.6625	8.7435	-9.1380	<b>39.52</b>	T4
	CDMA 1900	600	-6.4, -8.8	-58.8546	-53.0888	5.7658	-11.2300	41.86	T4

**Graph 2: CDMA 800 Frequency Response**

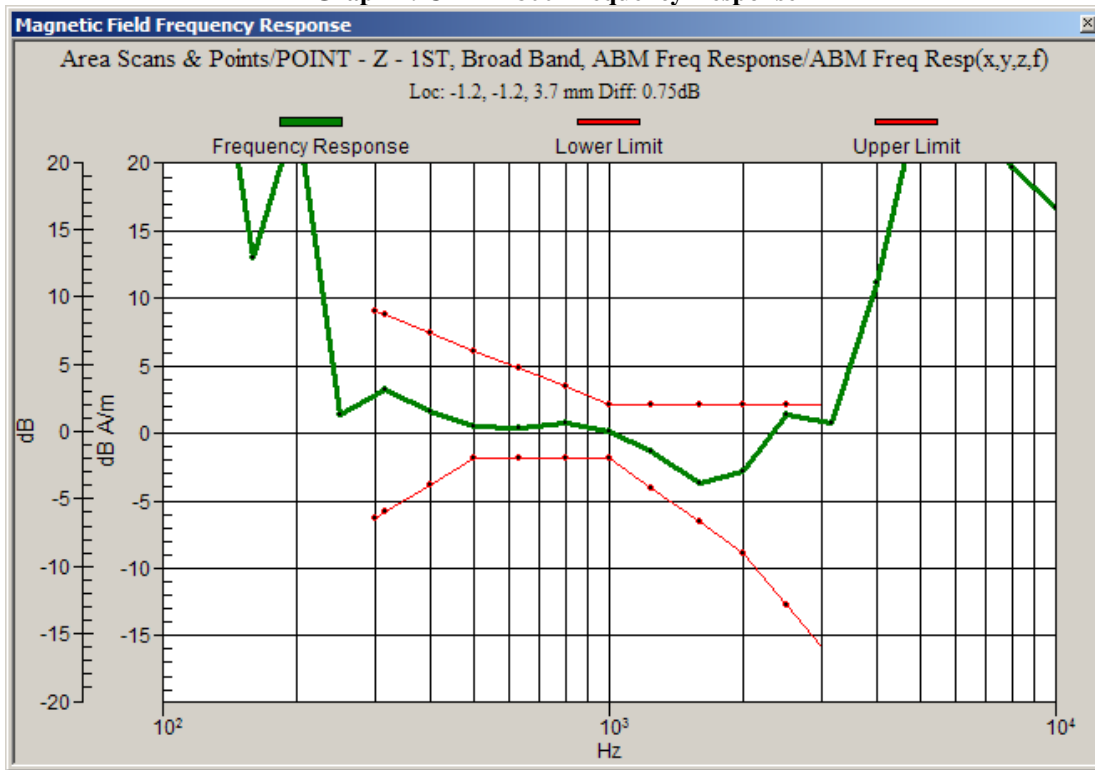

**Graph 3: CDMA 1900 Frequency Response**

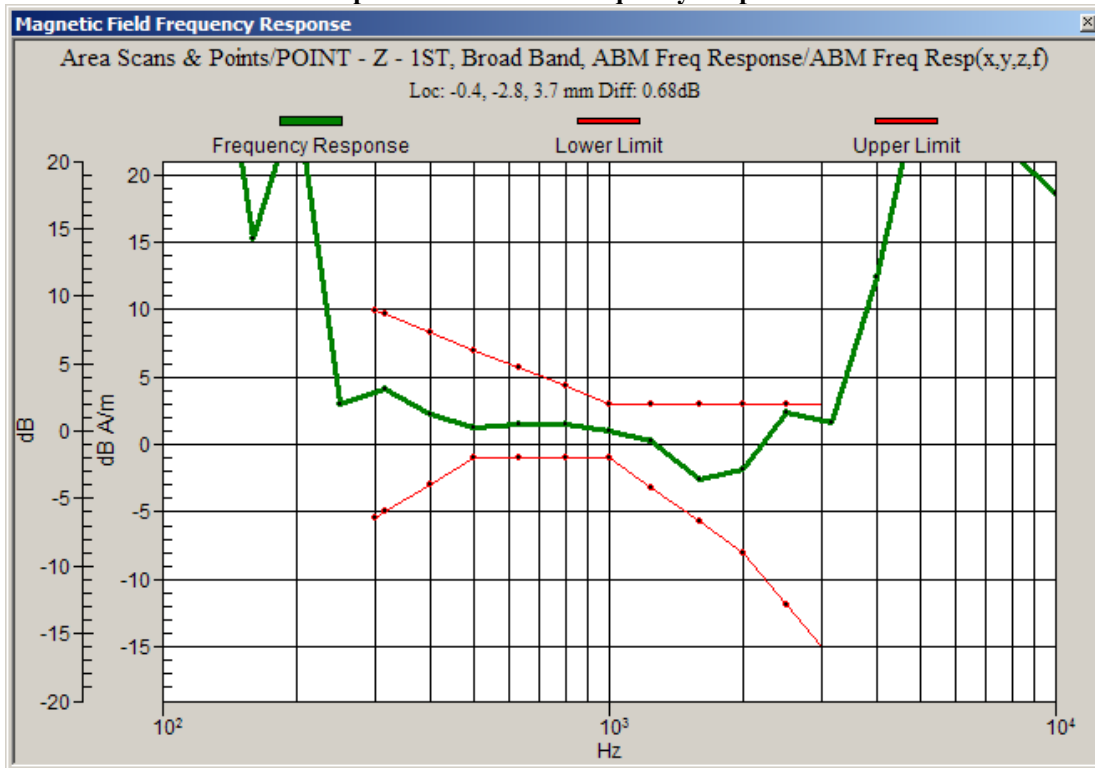

## 5.2 Telecoil Environment Results

Telecoil Environment is determined by analysis of both E-Field scan and H-Field scans in the area of the Telecoil location. The Telecoil location is the earpiece speaker area. The 5 cm x 5 cm measurement grid is centered on the acoustic output of the device. The probe is raised 15 mm from the highest point of the phone's contour to the center point of the probe element. The phone was tested in normal configurations for the ear use. These configurations are tested at the high, middle and low frequency channels of each applicable frequency band. For more information on the RF near-field measurements on the unit LSOV390121, refer to "HAC Test Report for Near Field Emissions IHDT56LB1" from March 11<sup>th</sup>, 2010.

The worst-case test conditions are indicated with **bold numbers** in the tables and are detailed in Appendix 8: HAC distribution plots for E-Field and H-Field.

**Table 7: Telecoil Environment measurement results for the portable cellular telephone at highest possible output power.**

**Table 7a: HAC E-Field measurement results for the portable cellular telephone at highest possible output power (Full Rate).**

Frequency Band (MHz)	Channel Setting	Measured PMF	Drift (dB)	Excluded Cells	Peak Field (V/m)	Rating
CDMA 800	1013	1.04	-0.116	8,9	83.5	M4
	384		<b>-0.010</b>	<b>8,9</b>	<b>98.7</b>	<b>M4</b>
	777		0.058	8,9	83.9	M4
CDMA 1900	25	1.05	0.116	1,2,3	29.1	M4
	600		-0.149	1,2,3	33.7	M4
	1175		<b>-0.274</b>	<b>1,2,3</b>	<b>38.1</b>	<b>M4</b>

**Table 7b: HAC E-Field measurement results for the portable cellular telephone at highest possible output power (1/8 Rate).**

Frequency Band (MHz)	Channel Setting	Measured PMF	Drift (dB)	Excluded Cells	Peak Field (V/m)	Rating
CDMA 800	1013	2.81	-0.116	8,9	89.6	M4
	384		<b>0.034</b>	<b>8,9</b>	<b>98.9</b>	<b>M4</b>
	777		0.008	8,9	87.5	M4
CDMA 1900	25	2.90	-0.051	1,2,3	28.5	M4
	600		-0.136	1,2,3	34.0	M4
	1175		<b>-0.028</b>	<b>1,2,3</b>	<b>39.1</b>	<b>M4</b>

**Table 7c: HAC H-Field measurement results for the portable cellular telephone at highest possible output power (Full Rate).**

Frequency Band (MHz)	Channel Setting	Measured PMF	Drift (dB)	Excluded Cells	Peak Field (A/m)	Rating
CDMA 800	1013	1.02	-0.155	1,4,7	0.123	M4
	384		<b>0.051</b>	<b>1,4,7</b>	<b>0.144</b>	<b>M4</b>
	777		0.007	1,4,7	0.130	M4
CDMA 1900	25	1.02	0.012	1,2,3	0.070	M4
	600		-0.107	1,2,4	0.109	M4
	1175		<b>-0.169</b>	<b>1,2,4</b>	<b>0.120</b>	<b>M4</b>

**Table 7d: HAC H-Field measurement results for the portable cellular telephone at highest possible output power (1/8 Rate).**

Frequency Band (MHz)	Channel Setting	Measured PMF	Drift (dB)	Excluded Cells	Peak Field (A/m)	Rating
CDMA 800	1013	2.40	0.009	1,4,7	0.111	M4
	384		<b>-0.036</b>	<b>1,4,7</b>	<b>0.126</b>	<b>M4</b>
	777		-0.175	1,4,7	0.117	M4
CDMA 1900	25	2.46	-0.028	1,2,3	0.064	M4
	600		0.097	1,2,4	0.095	M4
	1175		<b>-0.130</b>	<b>1,2,4</b>	<b>0.104</b>	<b>M4</b>

**6. Measurements for Certification of 3G Devices**

For CDMA devices, RC1 and RC3 CDMA modes are considered in S055 service option. In addition, RC1 and RC3 modes are considered in S02 service option. The conducted power measurements for each mode are shown in the table below.

Conducted Power (dBm) for CDMA modes					
	Channel	RC1		RC3	
		S02	S055	S02	S055
CDMA 800	1013	24.91	24.90	25.09	24.98
	384	24.92	24.93	25.07	25.02
	777	24.81	24.81	24.94	24.92
CDMA 1900	25	24.84	24.84	24.90	24.95
	600	24.84	24.81	24.91	24.90
	1175	24.91	24.85	24.99	24.98

For CDMA devices, RC1 S03 mode is used for Telecoil compliance evaluation. This RC1 S03 is used for measurements in Table 5 and Table 6. As per the recent presentation by Qualcomm to the FCC on March 15, 2007, RC1 S03 combination represents the appropriate configuration for Telecoil testing. Please refer to the ATIS filing which includes Qualcomm’s presentation. This filing can be found at:  
<http://www.atis.org/legal/Docs/MISC/ATIS%2006-203%20Ex%20Parte%20Letter%203-16-07%20w-attach.pdf>

**Appendix 1**  
**Contour Plots**

Z-Axial Signal Scan

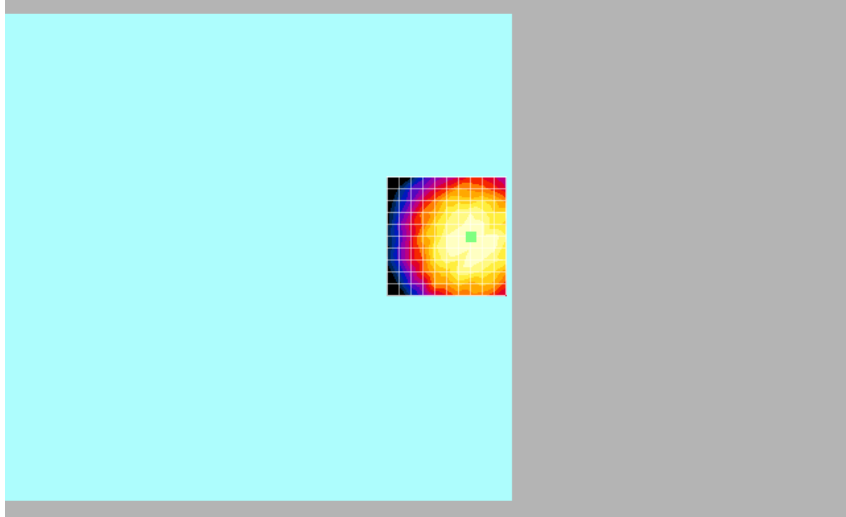

X-Radial Signal Scan

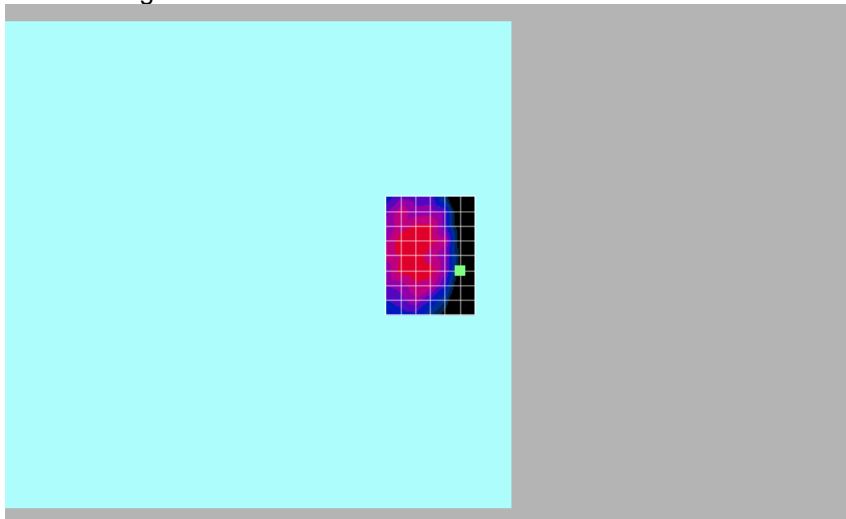

Y-Radial Signal Scan

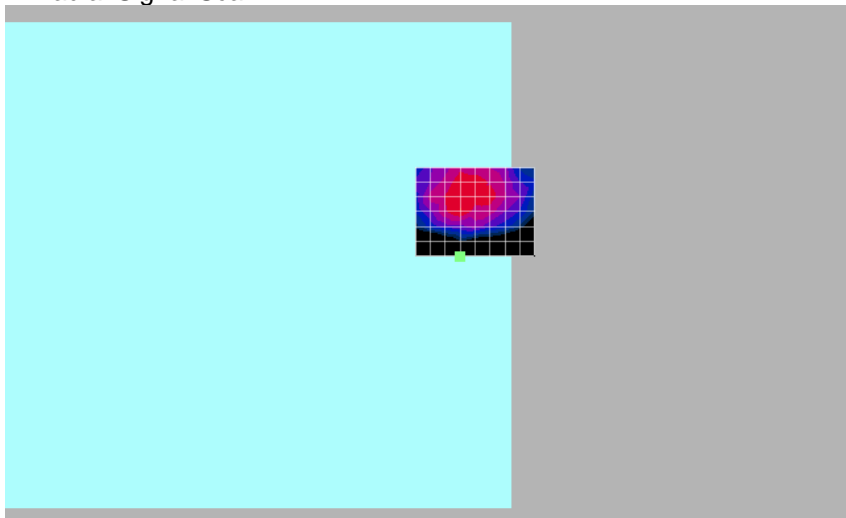

Note: The green square designates the device reference point.

Axial – ABM1

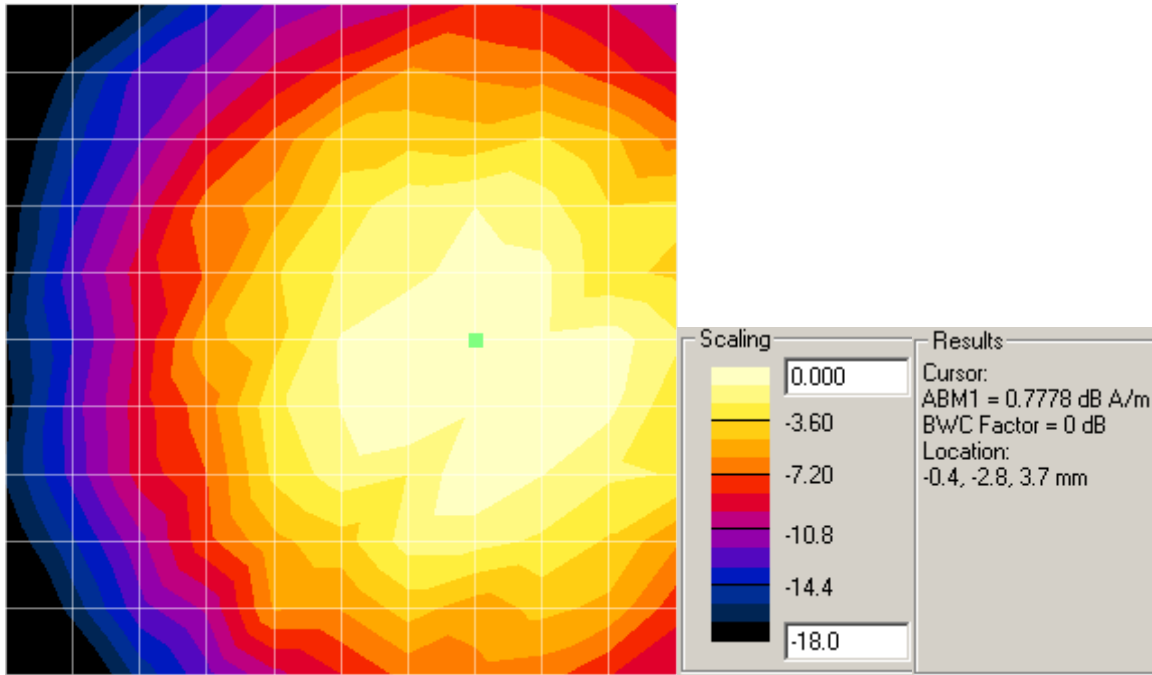

Axial – SNR

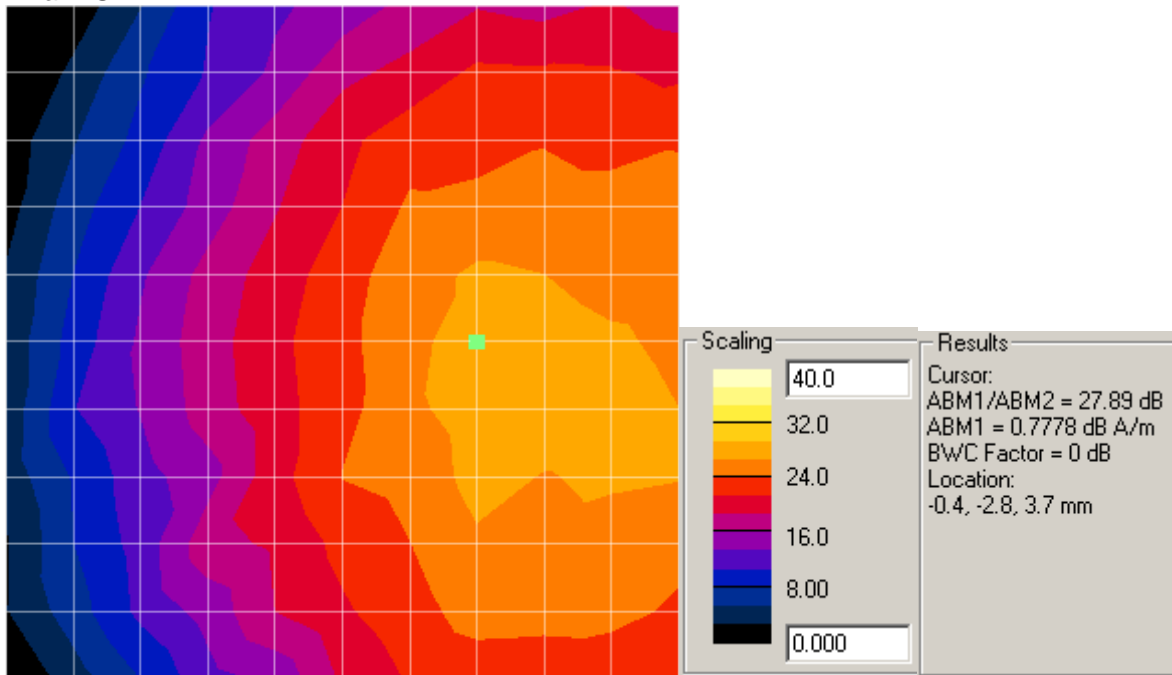

Radial1 – ABM1

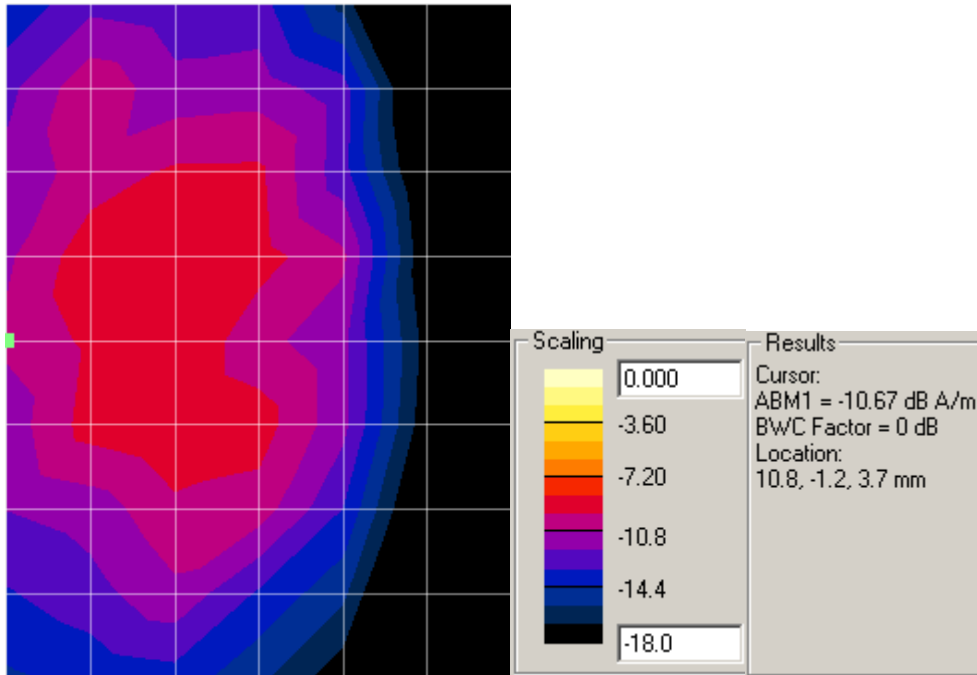

Radial1 – SNR

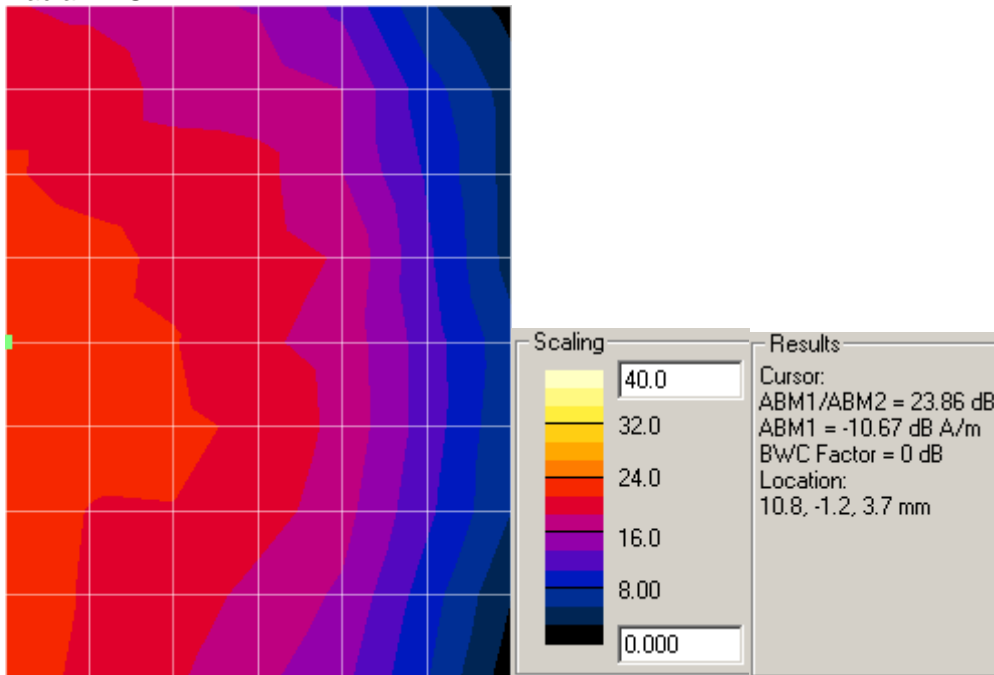

Radial2 – ABM1

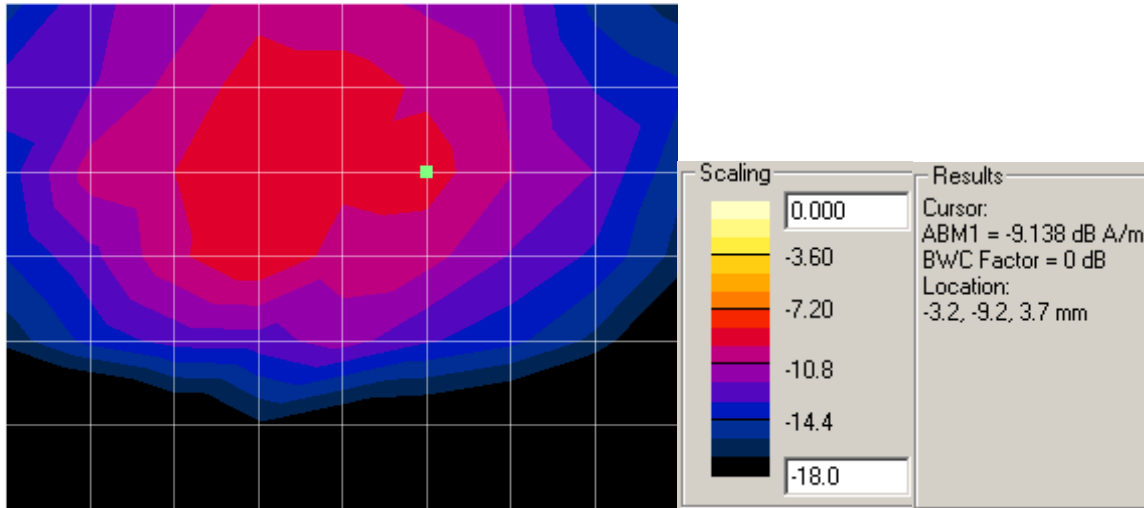

Radial2 – SNR

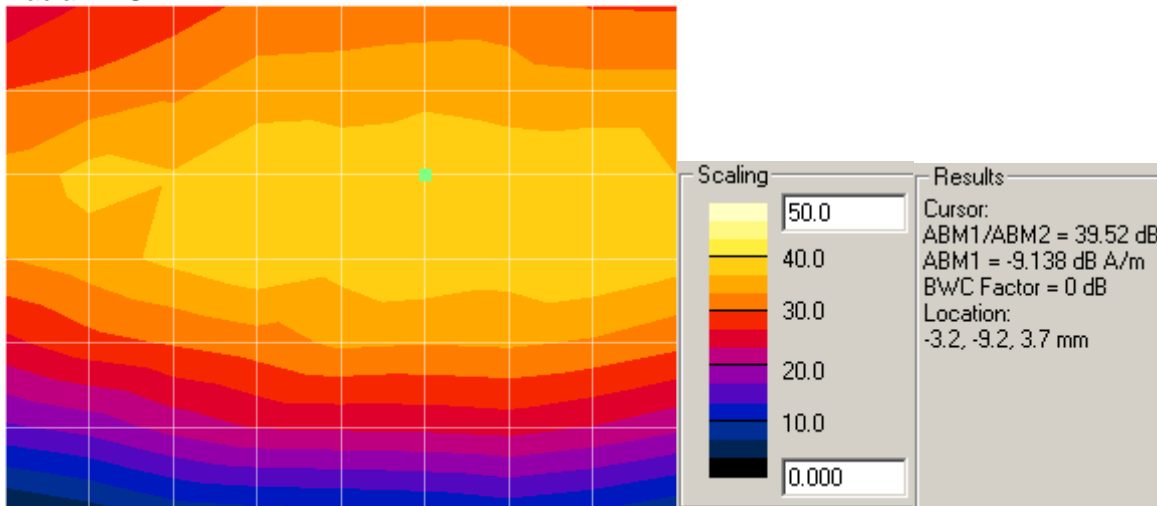

**Appendix 2**  
**Ambient Noise Spectrum Plots**

**Graph A2-1. Axial Position Ambient Noise Spectrum Plot**

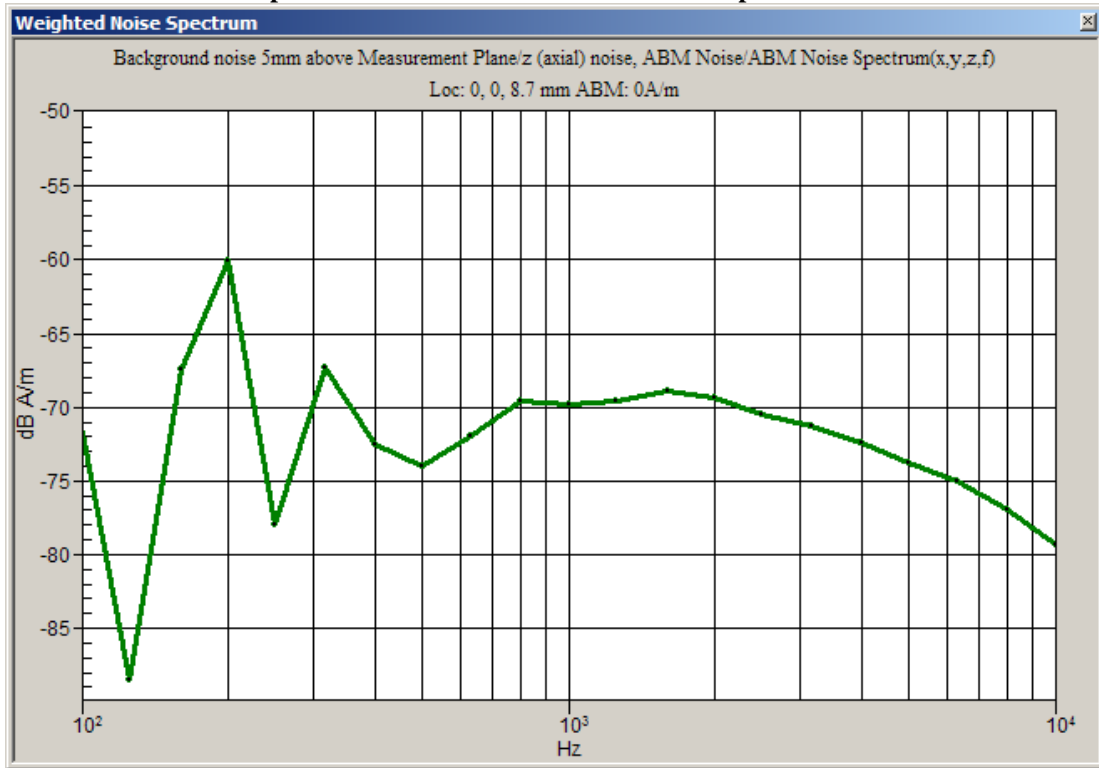

**Graph A2-2. Radial 1 Position Ambient Noise Spectrum Plot**

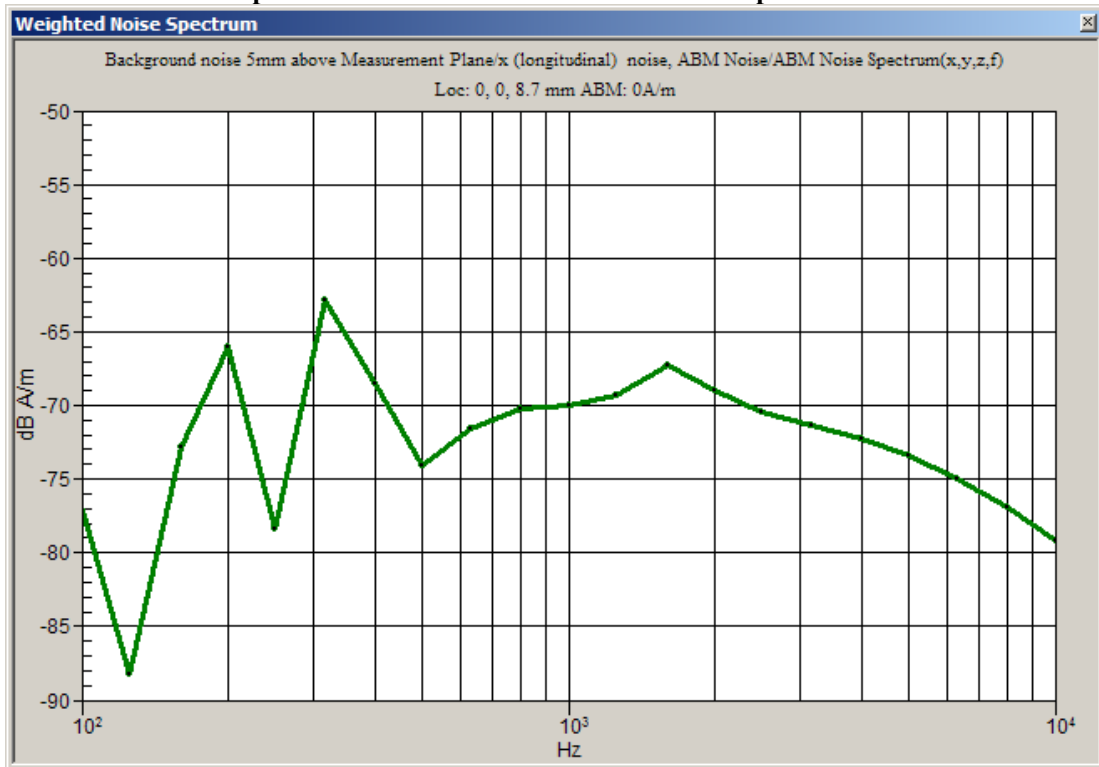

Graph A2-3. Radial 2 Position Ambient Noise Spectrum Plot

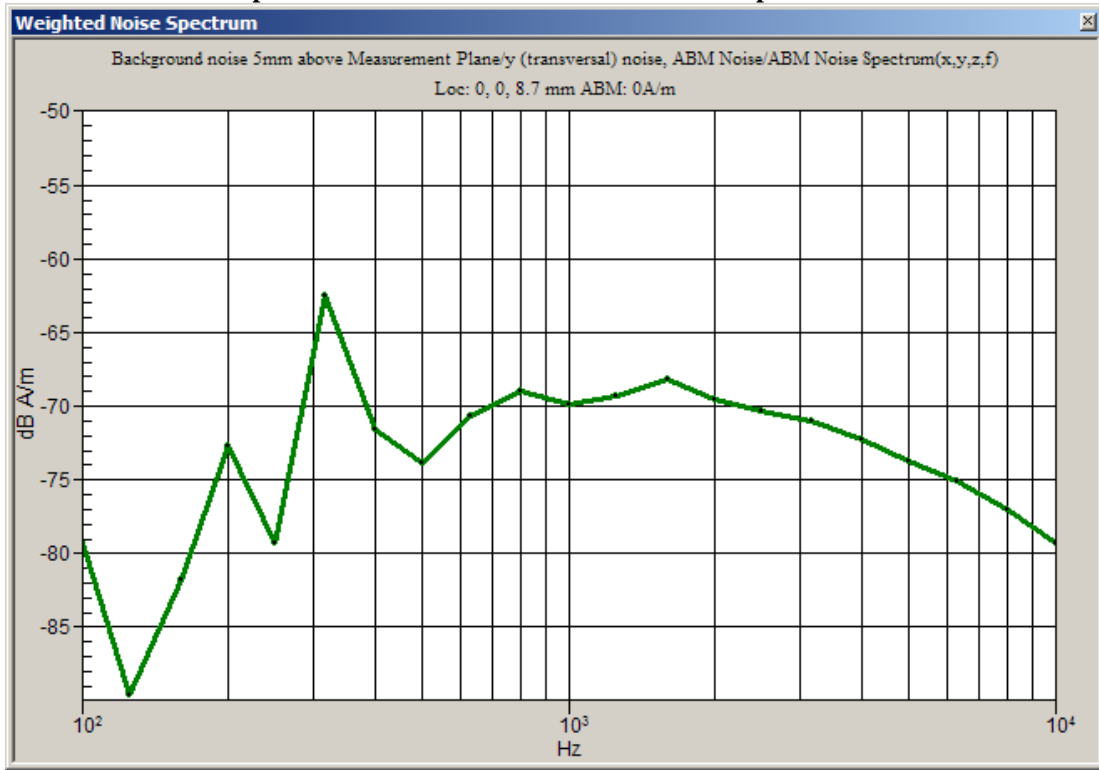

## **Appendix 3**

### **Details on the Measurement Systems**

**3-1) Details on ABM2 measurements by the system**

**(Description provided by Schmid & Partner Engineering, AG):**

The processing applies a convolution in the time-domain. This filtering is composed of integrator (straight-forward), Half-Band filter (first-order filter) and A-weighting. The convolved data stream is then integrated over the desired period and represented and stored numerically in DASY4 as the ABM Noise (= ABM2).

During the validation process of our system, the functionality of this process has been verified by debugging the filters step-by-step progressive and comparing the results also with a Rohde & Schwarz UPL Analyzer. The intermediate steps are not accessible in the final software code operated by the end user. In addition, the following verification has been made, using a single frequency (sine) signal: At the reference frequency of 1 kHz, the signal is equivalent to ABM1. ABM1 is visible from the calibration job, inclusive its frequency slope from 100Hz to 5kHz. This function (conversion of the coil voltage to the field) is the same integration function.

The verification of the probe linearity and the linearity of the integrator has been determined and documented in the certificate 880-SP AM1 001 A, inclusive the integrator, over the required frequency range (exceeding 5 kHz). The additional frequency slope of the Half-Band filter and the A-weighting have also been tested by changing the applied frequency over the full range. The attenuation was verified for each third-octave-band and up to > 10 kHz. In addition, the correct processing of multiple sine-wave signals was verified.

The convolutions work over the full frequency range available in the analog path, only limited by AC-coupling at the low end and anti-aliasing filter at the high frequency end. White noise signal without band limitation has not been used for filter measurements. Pink noise, decreasing with frequency, resulting in a frequency independent response of the third-octave filter bank was used to optically verify the correct filtering function. Precision measurements were however made with pure sine signals.

Frequency components beyond the visible range of 5 kHz are contained in the ABM2 figure.

**(Measurements made by Motorola):**

Comparison of 1kHz narrowband signal driven externally into TMFS coil

ABM1 @ 1kHz	ABM2 @ 1kHz	difference
-25.122	-25.124	0.002 dB

Frequency dependent ABM1 - ABM2 with broadband noise and narrowband tones driven externally into TMFS coil

Frequency	dB difference ABM1-ABM2 broadband signal	dB difference ABM1-ABM2 single frequency signals	ideal value for ABM1-ABM2	variance from ideal broadband	variance from ideal single frequencies
200		22.062	22.35		0.288
250			17.89		
315			14.03		
400		10.371	10.39		0.019
500	6.852		7.18	0.328	
630	4.228		4.36	0.132	
800	1.587	1.881	1.88	0.293	-0.001
1000	0.013	0.013	0	-0.013	-0.013
1250	-1.473		-1.46	0.013	
1600	-2.72		-2.58	0.14	
2000	-3.535	-3.235	-3.24	0.295	-0.005
2500	-3.736		-3.67	0.068	
3150	-3.837		-3.79	0.047	
4000	-3.733	-3.744	-3.75	-0.017	-0.006
5000	-3.283	-3.336	-3.34	-0.057	-0.004
<b>maximum variation from ideal:</b>				<b>0.328 dB</b>	

### **3-2) Details on the compliancy of the frequency and linearity response**

**(Description provided by Schmid & Partner Engineering, AG):**

See also probe certificate of conformity in Appendix 6, titled 880-SP AM1 001 A-A

See also coil certificate of conformity in Appendix 7, titled 880-SD HAC P02A-A

Frequency response has been tested to be within +/- 0.5 dB of ideal differentiator from 100 Hz to 10 kHz. The test was made with the real integrator and deducting the ideal integrator values. Reference signal was the Helmholtz calibration coil current which is equivalent to the field. The coil is qualified according to certificate 880-SD HAC P02 A-A.

The test data up to 5 kHz are visible directly in the calibration job result (coil current / shunt voltage, and probe voltage). Separate measurements were made for a very wide frequency range, including higher frequencies. For the third-octave bands up to 5 kHz do not exceed 0.05 dB and decay by < 0.2 dB to 5 kHz and by < 0.5 dB to 10 kHz, as required.

Linearity has also been tested and is stated in the certificate. Deviation was not measurable from 5 dB below limitation to 26 dB above noise level. For lower levels, the deviation increased to 0.1 dB at 16 dB above noise level, which corresponds to the theoretical value of 0.11 dB expected at that noise suppression level.

Significant noise contribution beyond 10 kHz will be attenuated by the convoluting A-filter as explained in answer #2. Such interferences contribute also to ABM2 represented as numerical value from the integration.

**3-3) Details on Measurements by the systems**

Details regarding timing and averaging of the reported final measured points are as follows:

	Narrowband Signal	Broadband Signal
Signal Length (sec):	1	2
Total Data Acquisition Time per Location (sec):	2	12
	Averaging is over 2 signal repetitions	Averaging is over 6 signal repetitions

The broadband signal utilized is shown in the following plot:

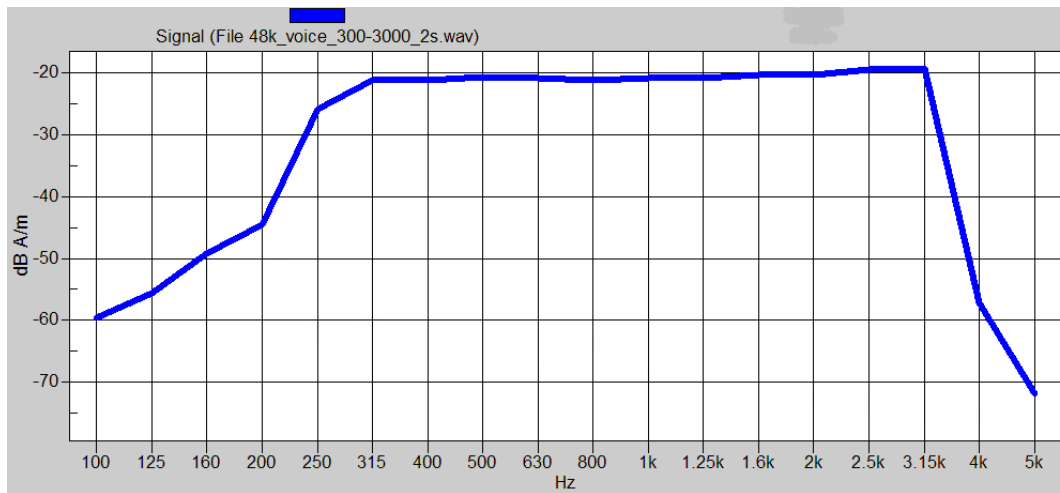

Mathematical processing is not required because the preferred method (as described in IEEE ANSI C63.19-2007 section 6.3) is utilized. The broadband audio signal is used only for assessment of frequency response. The DASY4 system corrects for the spectral response after measurement since it knows the spectrum of the input signal. However, please note that for the signal that we use, the spectrum is flat when measured in 1/3 octave bands, covering the range up to 3 kHz.

The narrowband signal utilized is shown in the following plot:

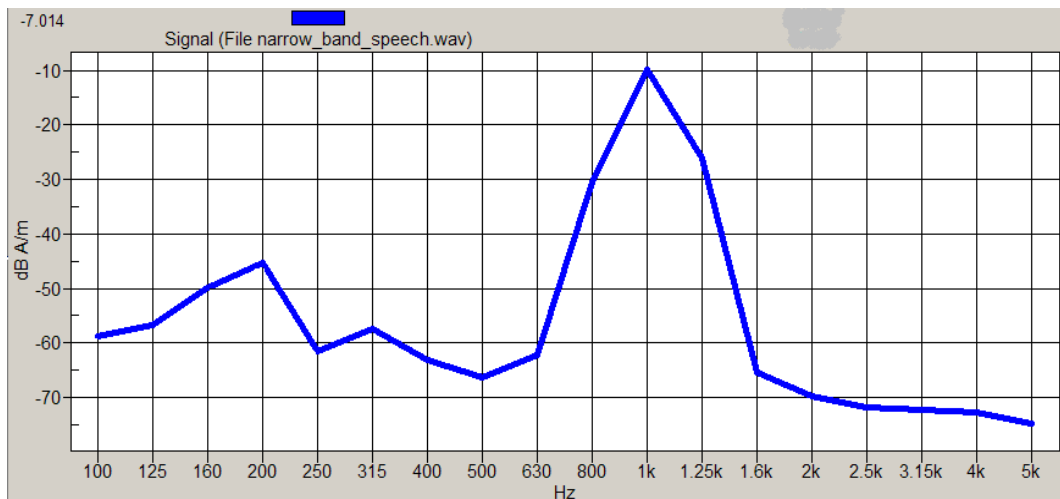

### **3-4) Details of the source audio signals for all aspects of the test**

Here is the temporal response of the narrow band signal. The signal is one second of the standard P.50 speech band limited to the ANSI 1 kHz 1/3 octave band. The signal is Hann windowed to ensure continuity of the signal.

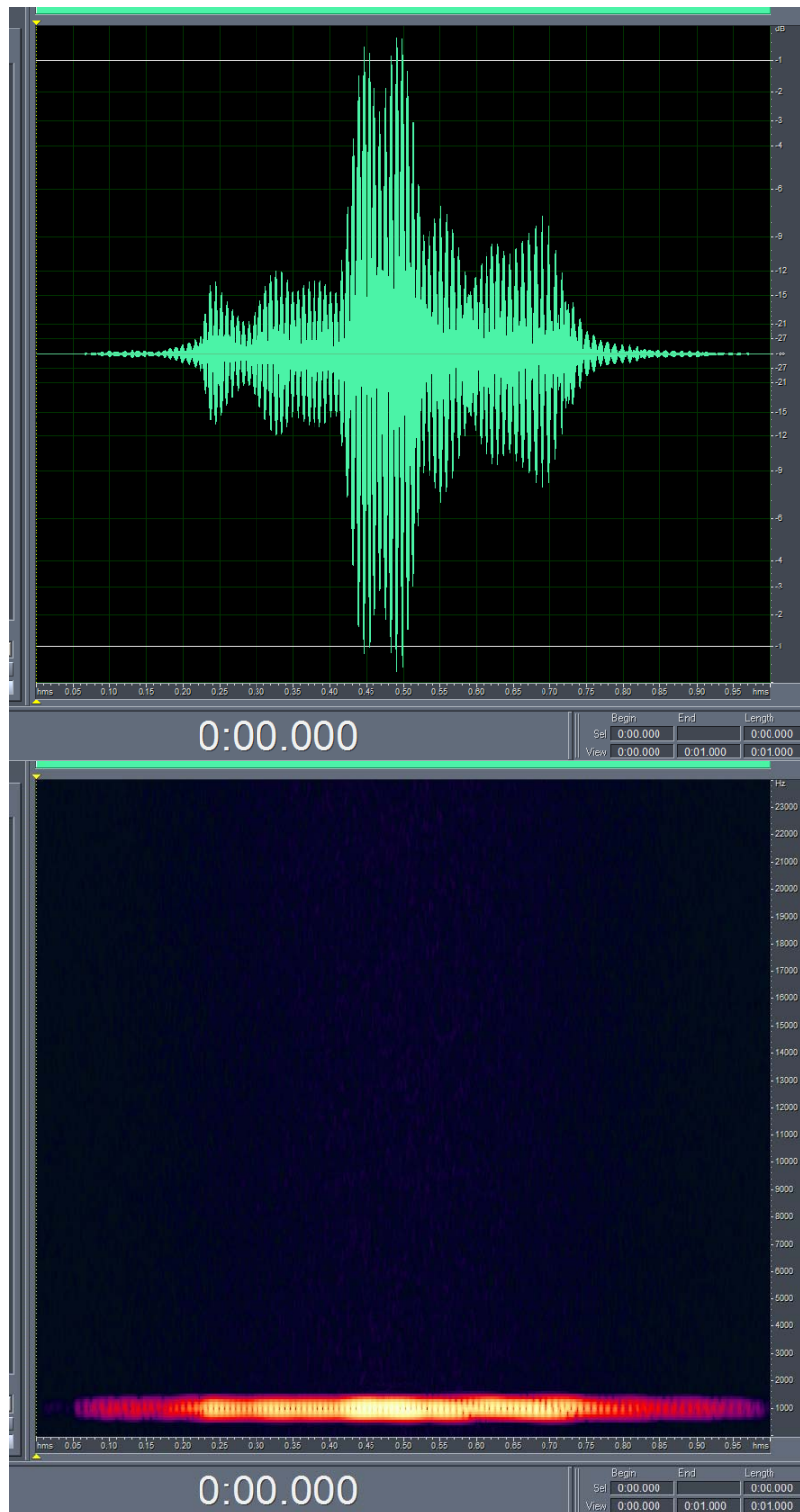

Here is the temporal response of the 300 Hz-3 kHz broadband signal. The signal is a 2 second segment of the standard P.50 speech that is equalized flat (for ANSI 1/3 octaves) over the 300 Hz to 3 kHz range. The signal is Hann windowed to ensure continuity of the signal.

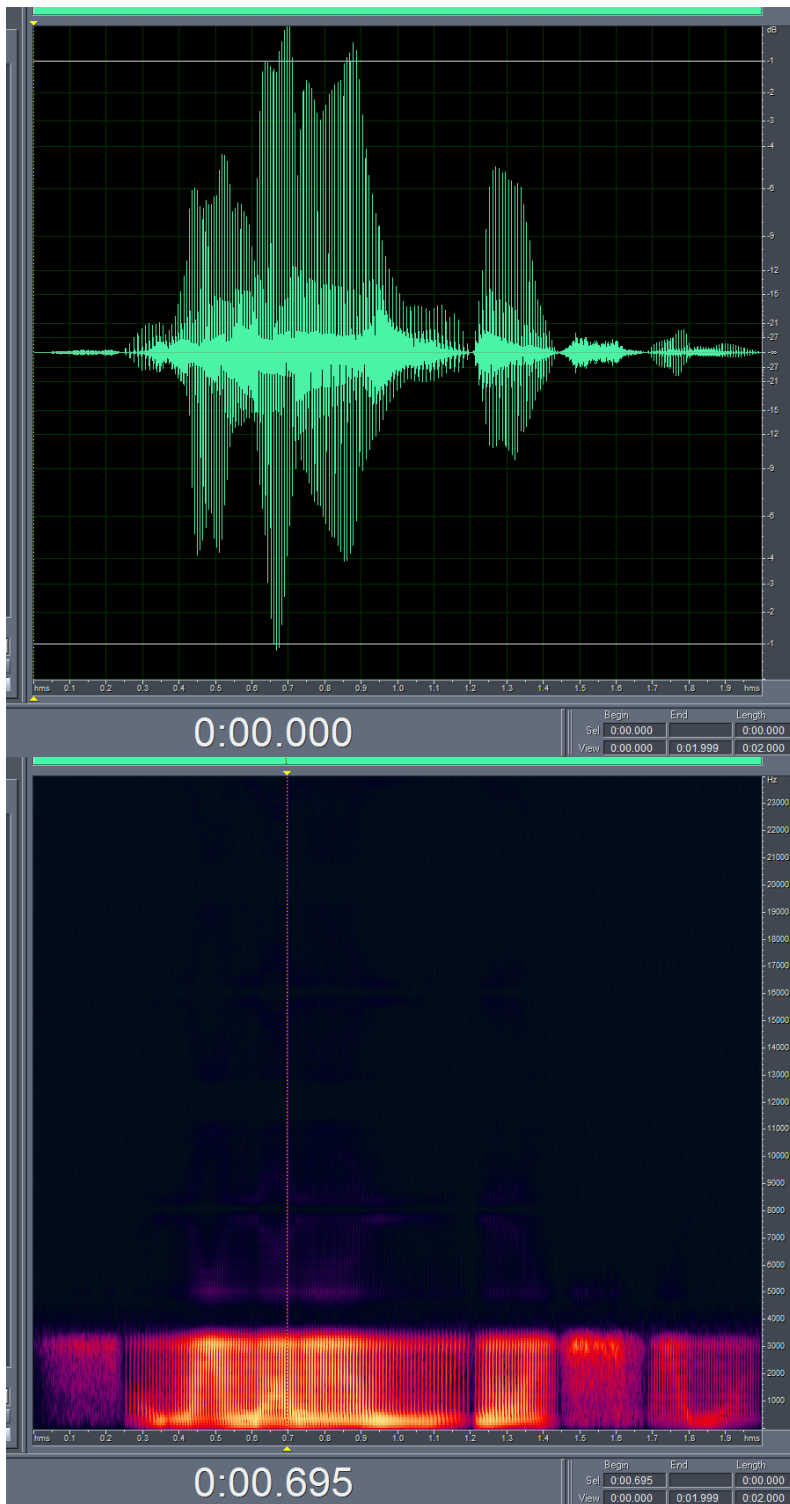

**3-5) Details of the CMU-200 “0dBm0 Input Reference value”****Measure “Ref Input Level”**

- a) Generate a 1 kHz Sine Signal using AMMI.
- b) Capture a signal level using AMMI.
- c) Record the value as the "Ref Input Level"

**Measure Value “X”**

- d) Connect CMU to AMMI.
- e) Connect a phone which operates in the desired modulation to the CMU. Establish a call to the CMU. Select Decoder Cal on CMU.
- f) Capture a signal level from CMU using AMMI.
- g) Record the value as the "Value X".

**Measure Value “M”**

- h) Make another connection from AMMI to CMU. Change to Encoder Cal on CMU.
- i) Generate a 1 kHz Sine Signal using AMMI
- j) Capture a signal from CMU using AMMI.
- k) Record the value as the "Value M".

Calculate the resulting Input Correction Factor & the 0dBm0 Input Reference

**Relevant Equations:**

Measured values from above: Ref Input Level, X, M

Input Correction Factor = Ref Input Level + X – M

0dBm0 Input Reference =  $10^{(\text{Input Corr Factor}/20)}$  \* CMU-200 manual ref value

**Appendix 4**  
**Pictures of Test Setup**

See Exhibit 7B

**Appendix 5**  
**Motorola Uncertainty Budget**

**Table A5-1: Telecoil Uncertainty Budget, provided by SPEAG**

Error Description	Uncertainty value (%)	Prob. Dist.	Div.	c ABM1	c ABM2	St.Unc ABM1 (%)	St.Unc ABM2 (%)
<b>PROBE SENSITIVITY</b>							
Reference level	3.0	N	1	1	1	3.0	3.0
AMCC geometry	0.4	R	1.7	1	1	0.2	0.2
AMCC current	0.6	R	1.7	1	1	0.4	0.4
Probe positioning during calibration	0.1	R	1.7	1	1	0.1	0.1
Noise contribution	0.7	R	1.7	0.0143	1	0.0	0.4
Frequency slope	5.9	R	1.7	0.1	1	0.3	3.5
<b>PROBE SYSTEM</b>							
Repeatability / Drift	1.0	R	1.7	1	1	0.6	0.6
Linearity / Dynamic range	0.6	R	1.7	1	1	0.4	0.4
Acoustic noise	1.0	R	1.7	0.1	1	0.1	0.6
Probe angle	2.3	R	1.7	1	1	1.4	1.4
Spectral processing	0.9	R	1.7	1	1	0.5	0.5
Integration time	0.6	N	1	1	5	0.6	3.0
Field disturbance	0.2	R	1.7	1	1	0.1	0.1
<b>TEST SIGNAL</b>							
Reference signal spectral response	0.6	R	1.7	0	1	0.0	0.4
<b>POSITIONING</b>							
Probe positioning	1.9	R	1.7	1	1	1.1	1.1
Phantom thickness	0.9	R	1.7	1	1	0.5	0.5
DUT positioning **	4.0	R	1.7	1	1	2.4	2.4
<b>EXTERNAL CONTRIBUTIONS</b>							
RF interference	0.0	R	1.7	1	1	0.0	0.0
Test signal variation	2.0	R	1.7	1	1	1.2	1.2
<b>COMBINED UNCERTAINTY</b>							
<b>Combined Std.Uncert. (ABM field)</b>						4.6	6.5
<b>Expanded Std. Uncertainty, k=2 (%)</b>						9.1	12.9

\*\* based on repeat measurements of reference unit

## **Appendix 6**

### **Audio Magnetic Probe Certificate**

**Client**

Motorola MD6

**Certificate of test and configuration**

Item	AM1DV2 Audio Magnetic 1D Field Probe
Type No	SP AM1 001 AF
Series No	1049
Manufacturer / Origin	Schmid & Partner Engineering AG, Zürich, Switzerland

**Description of the item**

The Audio Magnetic Field Probe is a fully shielded magnetic field probe for the frequency range from 100 Hz to 20 kHz. The pickup coil is compliant with the dimensional requirements of [1]. The probe includes a symmetric 40dB low noise amplifier for the signal available at the shielded 3 pin connector at the side. Power is supplied via the same connector (phantom power supply) and monitored via the LED near the connector. The 7 pin connector at the end of the probe does not carry any signals, but determines the angle of the sensor when mounted on the DAE. The probe supports mechanical detection of the surface. The single sensor in the probe is arranged in a tilt angle allowing measurement of 3 orthogonal field components when rotating the probe by 120° around its axis. It is aligned with the perpendicular component of the field, if the probe axis is tilted 35.3° above the measurement plane, using the connector rotation and Sensor angle stated below.

The probe is fully RF shielded when operated with the matching signal cable (shielded) and allows measurement of audio magnetic fields in the close vicinity of RF emitting wireless devices according to [1] without additional shielding.

**Handling of the item**

The probe is manufactured from stainless steel. In order to maintain the performance and calibration of the probe, it must not be opened. The probe is designed for operation in air and shall not be exposed to humidity or liquids. For proper operation of the surface detection and emergency stop functions in the DASY4 system, the probe must be operated with the special probe cup provided (larger diameter).

**Functional test, configuration data and sensitivity**

The probe configuration data were evaluated after a functional test including noise level and RF immunity. Connector rotation, sensor angle and sensitivity are specific for this probe.

**DASY4 configuration data for the probe**

Configuration item	Condition	Configuration Data	Dimension
Overall length	mounted on DAE in DASY4 system	296	mm
Tip diameter	at the cylindrical part	6	mm
Sensor offset	center of sensor, from tip	3	mm
Connector rotation	Evaluated in homogeneous 1 kHz magnetic field generated with AMCC Helmholtz Calibration Coil	-39.6	°
Sensor angle		0.06	°
Sensitivity	at 1 kHz	0.0660	V / (A/m)

**Standards**

[1] ANSI-C63.19-2006

**Test date** 23.04.2007 / MM**Issue date** 24.04.2007**Signature**

M. Meik

**Appendix 7**

**AMCC Certificate (Helmholz Coil)**

**Certificate of conformity**

Item	Audio Magnetic Calibration Coil AMCC
Type No	SD HAC P02 A
Series No	1001 ff.
Manufacturer / Origin	Schmid & Partner Engineering AG Zurich, Switzerland

**Description of the item**

The Audio Magnetic Calibration coil (AMCC) is a Helmholtz Coil designed according to standard [1], section D.9 for calibration of the AM1D probe. Two horizontal coils are positioned above a non-metallic base plate and generate a homogeneous magnetic field in the z direction (normal to it).

**Configuration**

The AMCC consists of two parallel coils of 20 turns with radius 143 mm connected in parallel in a distance of 143 mm. With this design, a current of 10 mA produces a field of 1 A/m. The DC input resistance at the input BNC socket is adjusted by a series resistor to a DC resistance of approximately 50 Ohm. The voltage required to produce a field of 1 A/m is consequently approx. 500 mV.

The current through the coil is monitored via a shunt resistor of 10 Ohm +/- 1%. The voltage is available on a BNO socket with 100 mV corresponding to 1 A/m.

**Handling of the item**

The coil shall be positioned in a non-metallic environment to avoid distortion of the magnetic field.

**Tests**

Test	Requirement	Details	Units tested
Number of turns	N = 20 per coil	Resistance measurement	all
Orientation of coils	parallel coils with same direction of windings	Magnetic field variation in the AMCC axis	all
Coil radius	r = 143 mm	mechanical dimension	First article
Coil distance	d = 143 mm distance between coil centers	mechanical dimension	First article
Input resistance	51.7 +/- 2 Ohm	DC resistance at BNC input connector	all
Shunt resistance	R = 10.0 Ohm +/- 1 %	DC resistance at BNO output connector	all
Shunt sensitivity	Hc = 1 A/m per 100 mV according to formula $H_c = (U / R) * N / r / (1.25^{*1.5})$	Field measurement compared with Narda ELT400 + BN2300/90.10	First article

**Standards**

[1] ANSI PC63.19-2006 Draft 3.12

**Conformity**

Based on the tests above, we certify that this item is in compliance with the requirements of [1].

Date

22.5.2006

Stamp / Signature

**s p e a g**

Schmid & Partner Engineering AG  
 Zeughausstrasse 43, 8004 Zurich, Switzerland  
 Phone +41 1 245 9700, Fax +41 1 245 9779  
 info@speag.com, http://www.speag.com

## **Appendix 8**

### **HAC Distribution plots for E-Field and H-Field**

# Test Laboratory: Motorola - CDMA 800 E-Field, Full Rate Vocoder

Serial: LSOV290121; FCC ID: IHDT56LB1

Procedure Notes: Pwr Step: All up Bits; Antenna Position: Internal; Accessory Model #: N/A  
 Battery Model #: SNN5865A; Vocoder Rate: Full; PMF Value: 1.04; Positioner: Polystyrene Block  
 Communication System: CDMA 835; Frequency: 836.52 MHz; Channel Number: 384; Duty Cycle: 1:1  
 Medium: Air; Medium parameters used:  $\sigma = 0$  mho/m,  $\epsilon_r = 1$ ;  $\rho = 0$  kg/m<sup>3</sup>

## DASY4 Configuration:

- Probe: ER3DV6R - SN2248; ConvF(1, 1, 1); Calibrated: 7/16/2009
- Sensor-Surface: (Fix Surface)
- Electronics: DAE4 Sn376; Calibrated: 3/11/2009
- Phantom: R-3, HAC Test Arch (rev.2); Type: SD HAC P01 BA; Serial: 1071;
- Measurement SW: DASY4, V4.7 Build 80; Postprocessing SW: SEMCAD, V1.8 Build 186

## E Scan - Sensor center 15mm above WD, Hearing Aid Compatibility Test (101x101x1):

Measurement grid: dx=5mm, dy=5mm

Maximum value of peak Total field = 98.7 V/m; Probe Modulation Factor = 1.04

Device Reference Point: 0.000, 0.000, -6.30 mm; Reference Value = 120.6 V/m; Power Drift = -0.010 dB

### Hearing Aid Near-Field Category: M4 (AWF 0 dB)

Peak E-field in V/m

Grid 1 <b>87.0 M4</b>	Grid 2 <b>97.1 M4</b>	Grid 3 <b>97.1 M4</b>
Grid 4 <b>88.2 M4</b>	<b>Grid 5</b> <b>98.7 M4</b>	Grid 6 <b>98.5 M4</b>
Grid 7 <b>88.4 M4</b>	<b>Grid 8</b> <b>98.9 M4</b>	<b>Grid 9</b> <b>96.8 M4</b>

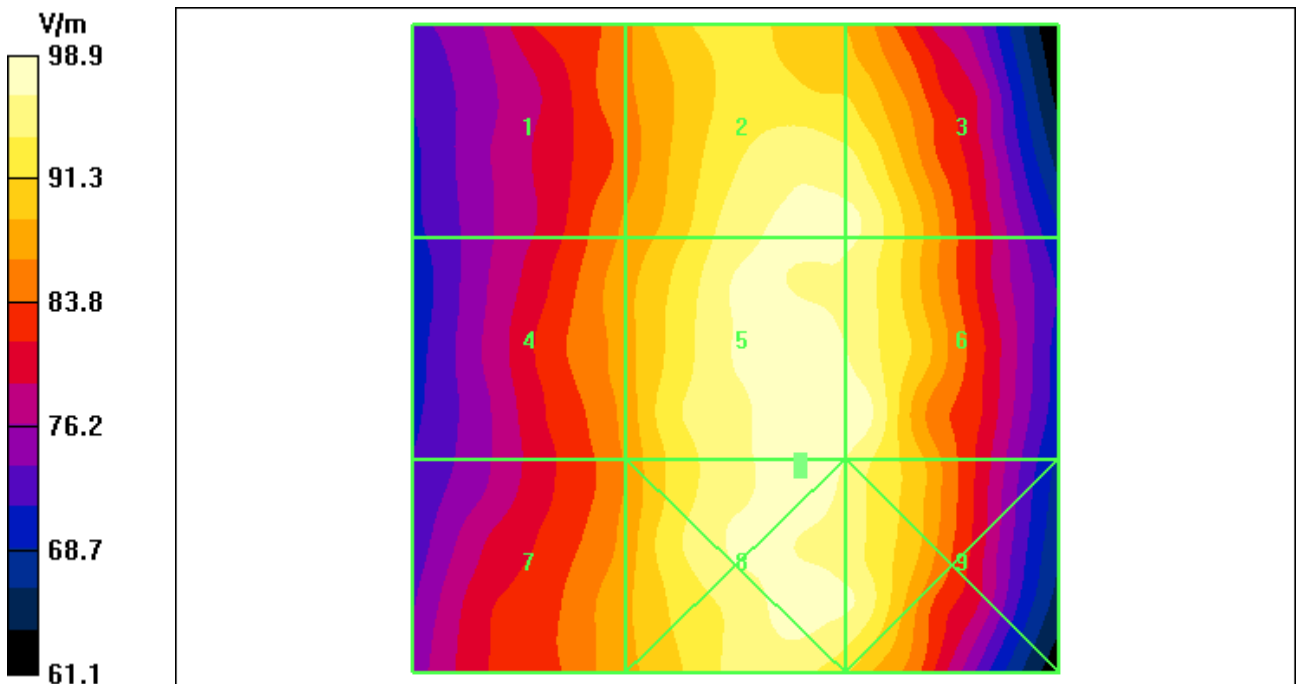

# Test Laboratory: Motorola - CDMA 1900 E-Field, Full Rate Vocoder

Serial: LSOV290121; FCC ID: IHDT56LB1

Procedure Notes: Pwr Step: All up Bits; Antenna Position: Internal; Accessory Model #: N/A  
 Battery Model #: SNN5865A; Vocoder Rate: Full; PMF Value: 1.05; Positioner: Polystyrene Block  
 Communication System: CDMA 1900; Frequency: 1908.75 MHz; Channel Number: 1175; Duty Cycle: 1:1  
 Medium: Air; Medium parameters used:  $\sigma = 0$  mho/m,  $\epsilon_r = 1$ ;  $\rho = 0$  kg/m<sup>3</sup>

## DASY4 Configuration:

- Probe: ER3DV6R - SN2248; ConvF(1, 1, 1); Calibrated: 7/16/2009
- Sensor-Surface: (Fix Surface)
- Electronics: DAE4 Sn376; Calibrated: 3/11/2009
- Phantom: R-3, HAC Test Arch (rev.2); Type: SD HAC P01 BA; Serial: 1071;
- Measurement SW: DASY4, V4.7 Build 80; Postprocessing SW: SEMCAD, V1.8 Build 186

## E Scan - Sensor center 15mm above WD, Hearing Aid Compatibility Test (101x101x1):

Measurement grid: dx=5mm, dy=5mm

Maximum value of peak Total field = 38.1 V/m; Probe Modulation Factor = 1.05

Device Reference Point: 0.000, 0.000, -6.30 mm; Reference Value = 35.1 V/m; Power Drift = -0.274 dB

### Hearing Aid Near-Field Category: M4 (AWF 0 dB)

Peak E-field in V/m

Grid 1 <b>49.8 M4</b>	Grid 2 <b>52.5 M4</b>	Grid 3 <b>50.3 M4</b>
Grid 4 <b>28.8 M4</b>	Grid 5 <b>38.1 M4</b>	Grid 6 <b>38.1 M4</b>
Grid 7 <b>22.1 M4</b>	Grid 8 <b>34.1 M4</b>	Grid 9 <b>34.3 M4</b>

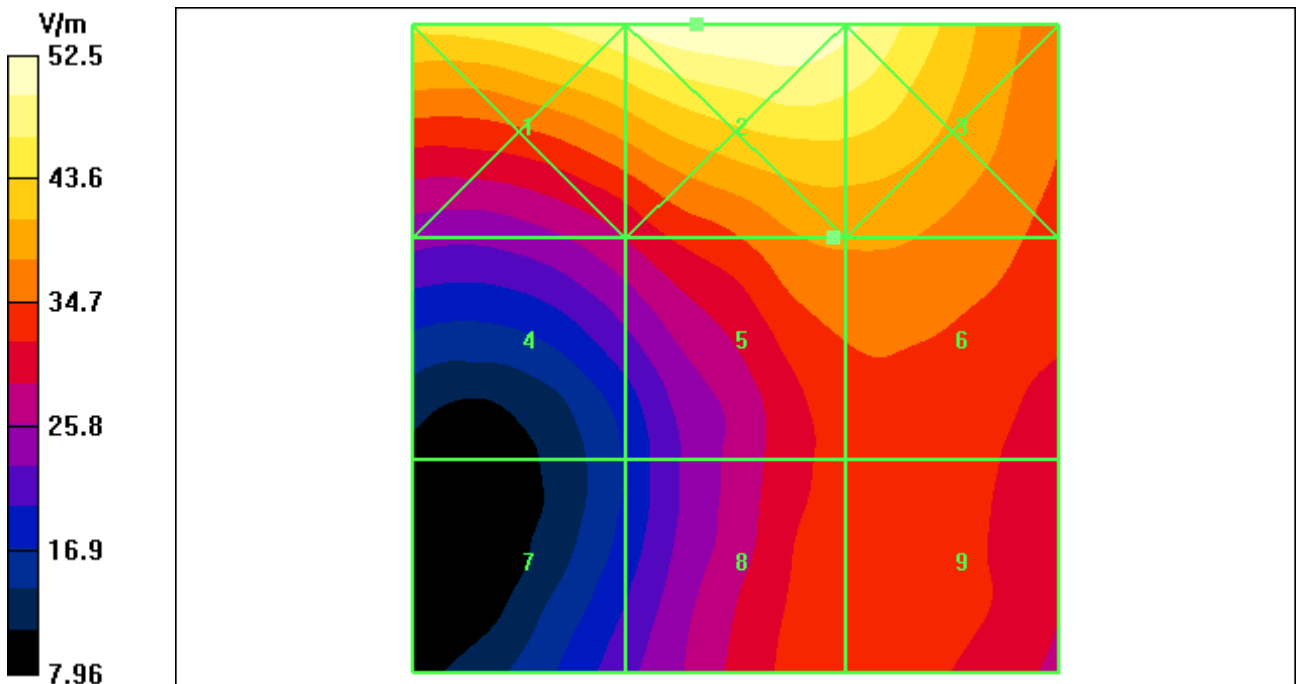

# Test Laboratory: Motorola - CDMA 800 E-Field, 1/8th Rate Vocoder

Serial: LSOV290121; FCC ID: IHDT56LB1

Procedure Notes: Pwr Step: All up Bits; Antenna Position: Internal; Accessory Model #: N/A

Battery Model #: SNN5865A; Vocoder Rate: 1/8th; PMF Value: 2.81; Positioner: Polystyrene Block

Communication System: CDMA 835; Frequency: 836.52 MHz; Channel Number: 384; Duty Cycle: 1:8

Medium: Air; Medium parameters used:  $\sigma = 0$  mho/m,  $\epsilon_r = 1$ ;  $\rho = 0$  kg/m<sup>3</sup>

## DASY4 Configuration:

- Probe: ER3DV6R - SN2248; ConvF(1, 1, 1); Calibrated: 7/16/2009
- Sensor-Surface: (Fix Surface)
- Electronics: DAE4 Sn376; Calibrated: 3/11/2009
- Phantom: R-3, HAC Test Arch (rev.2); Type: SD HAC P01 BA; Serial: 1071;
- Measurement SW: DASY4, V4.7 Build 80; Postprocessing SW: SEMCAD, V1.8 Build 186

## E Scan - Sensor center 15mm above WD, Hearing Aid Compatibility Test (101x101x1):

Measurement grid: dx=5mm, dy=5mm

Maximum value of peak Total field = 98.9 V/m; Probe Modulation Factor = 2.81

Device Reference Point: 0.000, 0.000, -6.30 mm; Reference Value = 44.3 V/m; Power Drift = 0.034 dB

### Hearing Aid Near-Field Category: M4 (AWF 0 dB)

Peak E-field in V/m

Grid 1 <b>87.0 M4</b>	Grid 2 <b>96.8 M4</b>	Grid 3 <b>96.1 M4</b>
Grid 4 <b>88.7 M4</b>	<b>Grid 5</b> <b>98.9 M4</b>	Grid 6 <b>98.6 M4</b>
Grid 7 <b>90.1 M4</b>	<b>Grid 8</b> <b>98.8 M4</b>	<b>Grid 9</b> <b>97.2 M4</b>

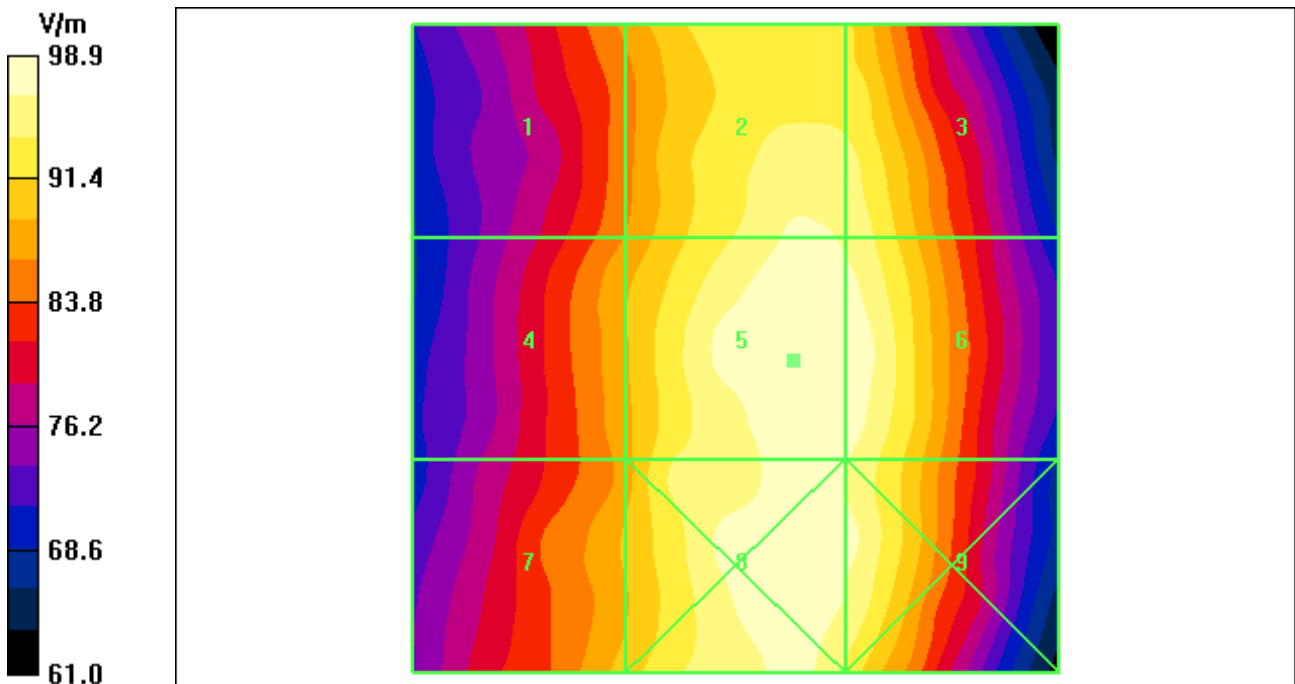

# Test Laboratory: Motorola - CDMA 1900 E-Field, 1/8th Rate Vocoder

Serial: LSOV290121; FCC ID: IHDT56LB1

Procedure Notes: Pwr Step: All up Bits; Antenna Position: Internal; Accessory Model #: N/A  
 Battery Model #: SNN5865A; Vocoder Rate: 1/8th; PMF Value: 2.90; Positioner: Polystyrene Block  
 Communication System: CDMA 1900; Frequency: 1908.75 MHz; Channel Number: 1175; Duty Cycle: 1:8  
 Medium: Air; Medium parameters used:  $\sigma = 0$  mho/m,  $\epsilon_r = 1$ ;  $\rho = 0$  kg/m<sup>3</sup>

## DASY4 Configuration:

- Probe: ER3DV6R - SN2248; ConvF(1, 1, 1); Calibrated: 7/16/2009
- Sensor-Surface: (Fix Surface)
- Electronics: DAE4 Sn376; Calibrated: 3/11/2009
- Phantom: R-3, HAC Test Arch (rev.2); Type: SD HAC P01 BA; Serial: 1071;
- Measurement SW: DASY4, V4.7 Build 80; Postprocessing SW: SEMCAD, V1.8 Build 186

## E Scan - Sensor center 15mm above WD, Hearing Aid Compatibility Test (101x101x1):

Measurement grid: dx=5mm, dy=5mm

Maximum value of peak Total field = 39.1 V/m; Probe Modulation Factor = 2.90

Device Reference Point: 0.000, 0.000, -6.30 mm; Reference Value = 12.6 V/m; Power Drift = -0.028 dB

### Hearing Aid Near-Field Category: M4 (AWF 0 dB)

Peak E-field in V/m

Grid 1 <b>49.0 M4</b>	Grid 2 <b>52.9 M4</b>	Grid 3 <b>50.5 M4</b>
Grid 4 <b>27.9 M4</b>	Grid 5 <b>38.9 M4</b>	Grid 6 <b>39.1 M4</b>
Grid 7 <b>22.7 M4</b>	Grid 8 <b>35.0 M4</b>	Grid 9 <b>35.2 M4</b>

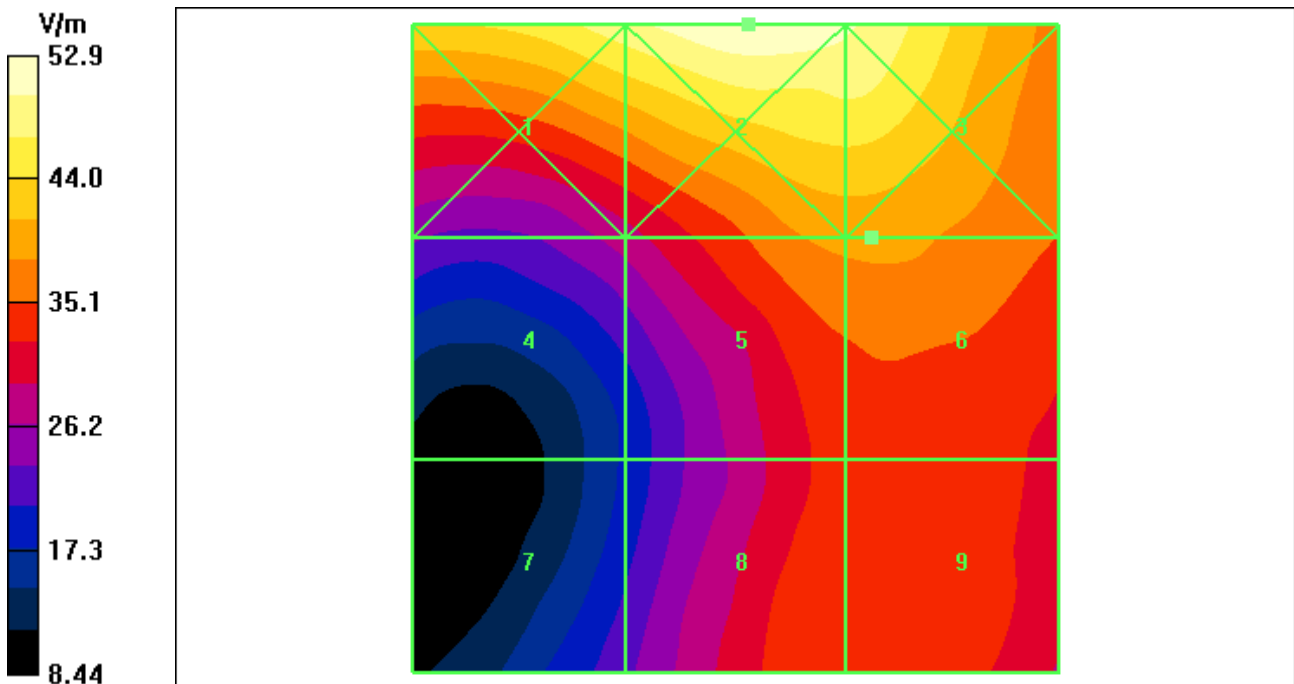

# Test Laboratory: Motorola - CDMA 800 H-Field, Full Rate Vocoder

Serial: LSOV290121; FCC ID: IHDT56LB1

Procedure Notes: Pwr Step: All up Bits; Antenna Position: Internal; Accessory Model #: N/A  
 Battery Model #: SNN5865A; Vocoder Rate: Full; PMF Value: 1.02; Positioner: Polystyrene Block  
 Communication System: CDMA 835; Frequency: 836.52 MHz; Channel Number: 384; Duty Cycle: 1:1  
 Medium: Air; Medium parameters used:  $\sigma = 0$  mho/m,  $\epsilon_r = 1$ ;  $\rho = 0$  kg/m<sup>3</sup>

## DASY4 Configuration:

- Probe: H3DV6 - SN6074; ; Calibrated: 7/16/2009
- Sensor-Surface: (Fix Surface)
- Electronics: DAE4 Sn699; Calibrated: 4/27/2009
- Phantom: R-3, HAC Test Arch (rev.2); Type: SD HAC P01 BA; Serial: 1071;
- Measurement SW: DASY4, V4.7 Build 80; Postprocessing SW: SEMCAD, V1.8 Build 186

## H Scan - Sensor center 15mm above WD, Hearing Aid Compatibility Test (101x101x1):

Measurement grid: dx=5mm, dy=5mm

Maximum value of peak Total field = 0.144 A/m; Probe Modulation Factor = 1.02

Device Reference Point: 0.000, 0.000, -6.30 mm; Reference Value = 0.099 A/m; Power Drift = 0.051 dB

### Hearing Aid Near-Field Category: M4 (AWF 0 dB)

Peak H-field in A/m

Grid 1 <b>0.194 M4</b>	Grid 2 <b>0.138 M4</b>	Grid 3 <b>0.086 M4</b>
Grid 4 <b>0.180 M4</b>	Grid 5 <b>0.133 M4</b>	Grid 6 <b>0.076 M4</b>
Grid 7 <b>0.199 M4</b>	Grid 8 <b>0.144 M4</b>	Grid 9 <b>0.088 M4</b>

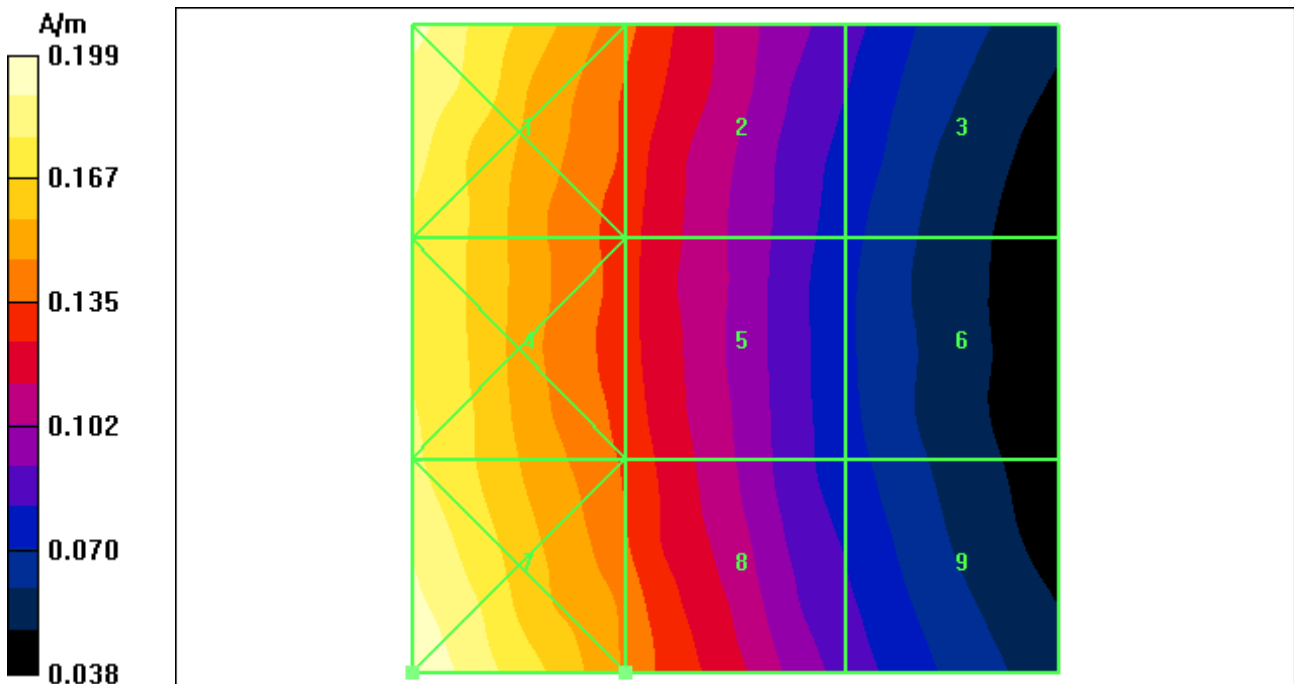

# Test Laboratory: Motorola - CDMA 1900 H-Field, Full Rate Vocoder

Serial: LSOV290121; FCC ID: IHDT56LB1

Procedure Notes: Pwr Step: All up Bits; Antenna Position: Internal; Accessory Model #: N/A  
 Battery Model #: SNN5865A; Vocoder Rate: Full; PMF Value: 1.02; Positioner: Polystyrene Block  
 Communication System: CDMA 1900; Frequency: 1908.75 MHz; Channel Number: 1175; Duty Cycle: 1:1  
 Medium: Air; Medium parameters used:  $\sigma = 0$  mho/m,  $\epsilon_r = 1$ ;  $\rho = 0$  kg/m<sup>3</sup>

## DASY4 Configuration:

- Probe: H3DV6 - SN6074; ; Calibrated: 7/16/2009
- Sensor-Surface: (Fix Surface)
- Electronics: DAE4 Sn699; Calibrated: 4/27/2009
- Phantom: R-3, HAC Test Arch (rev.2); Type: SD HAC P01 BA; Serial: 1071;
- Measurement SW: DASY4, V4.7 Build 80; Postprocessing SW: SEMCAD, V1.8 Build 186

## H Scan - Sensor center 15mm above WD, Hearing Aid Compatibility Test (101x101x1):

Measurement grid: dx=5mm, dy=5mm

Maximum value of peak Total field = 0.120 A/m; Probe Modulation Factor = 1.02

Device Reference Point: 0.000, 0.000, -6.30 mm; Reference Value = 0.127 A/m; Power Drift = -0.169 dB

### Hearing Aid Near-Field Category: M4 (AWF 0 dB)

Peak H-field in A/m

Grid 1 <b>0.154 M4</b>	Grid 2 <b>0.130 M4</b>	Grid 3 <b>0.112 M4</b>
Grid 4 <b>0.121 M4</b>	Grid 5 <b>0.120 M4</b>	Grid 6 <b>0.112 M4</b>
Grid 7 <b>0.104 M4</b>	Grid 8 <b>0.106 M4</b>	Grid 9 <b>0.098 M4</b>

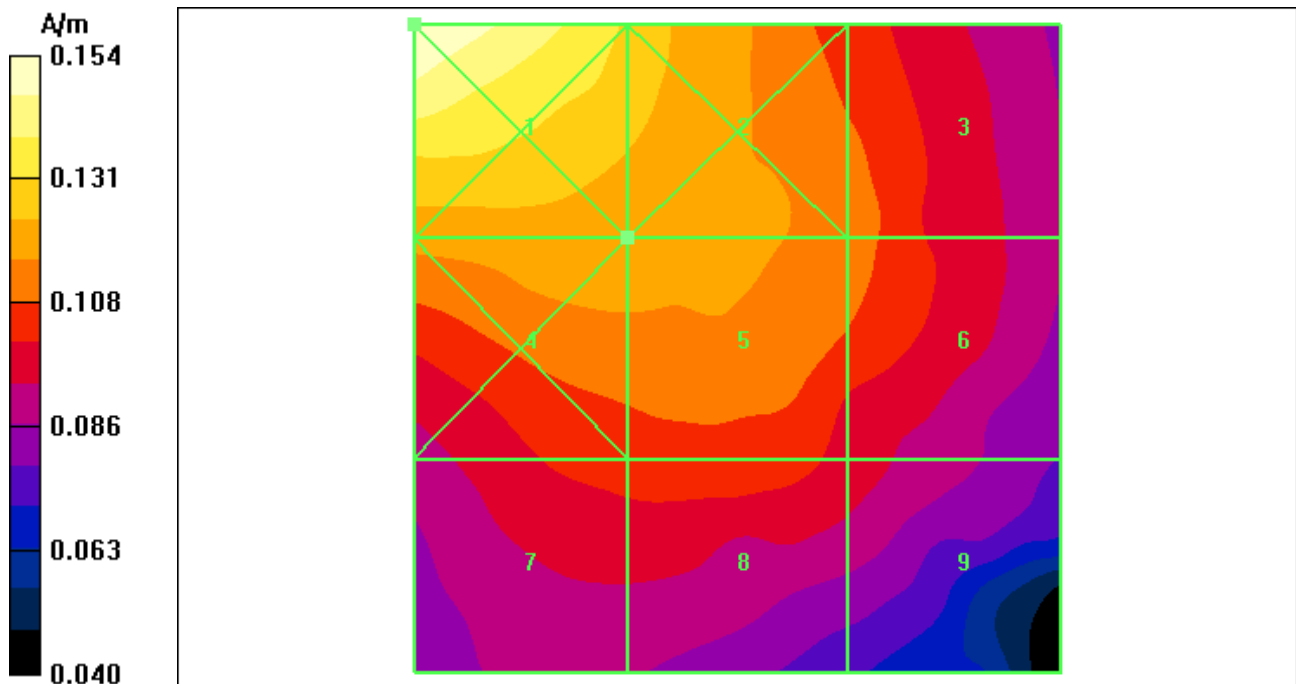

# Test Laboratory: Motorola - CDMA 800 H-Field, 1/8th Rate Vocoder

Serial: LSOV290121; FCC ID: IHDT56LB1

Procedure Notes: Pwr Step: All up Bits; Antenna Position: Internal; Accessory Model #: N/A

Battery Model #: SNN5865A; Vocoder Rate: 1/8th; PMF Value: 2.40; Positioner: Polystyrene Block|

Communication System: CDMA 835; Frequency: 836.52 MHz; Channel Number: 384; Duty Cycle: 1:8

Medium: Air; Medium parameters used:  $\sigma = 0$  mho/m,  $\epsilon_r = 1$ ;  $\rho = 0$  kg/m<sup>3</sup>

## DASY4 Configuration:

- Probe: H3DV6 - SN6074; ; Calibrated: 7/16/2009
- Sensor-Surface: (Fix Surface)
- Electronics: DAE4 Sn699; Calibrated: 4/27/2009
- Phantom: R-3, HAC Test Arch (rev.2); Type: SD HAC P01 BA; Serial: 1071;
- Measurement SW: DASY4, V4.7 Build 80; Postprocessing SW: SEMCAD, V1.8 Build 186

## H Scan - Sensor center 15mm above WD, Hearing Aid Compatibility Test (101x101x1):

Measurement grid: dx=5mm, dy=5mm

Maximum value of peak Total field = 0.126 A/m; Probe Modulation Factor = 2.40

Device Reference Point: 0.000, 0.000, -6.30 mm; Reference Value = 0.036 A/m; Power Drift = -0.036 dB

### Hearing Aid Near-Field Category: M4 (AWF 0 dB)

Peak H-field in A/m

Grid 1 <b>0.172 M4</b>	Grid 2 <b>0.121 M4</b>	Grid 3 <b>0.074 M4</b>
Grid 4 <b>0.154 M4</b>	Grid 5 <b>0.112 M4</b>	Grid 6 <b>0.064 M4</b>
Grid 7 <b>0.176 M4</b>	Grid 8 <b>0.126 M4</b>	Grid 9 <b>0.077 M4</b>

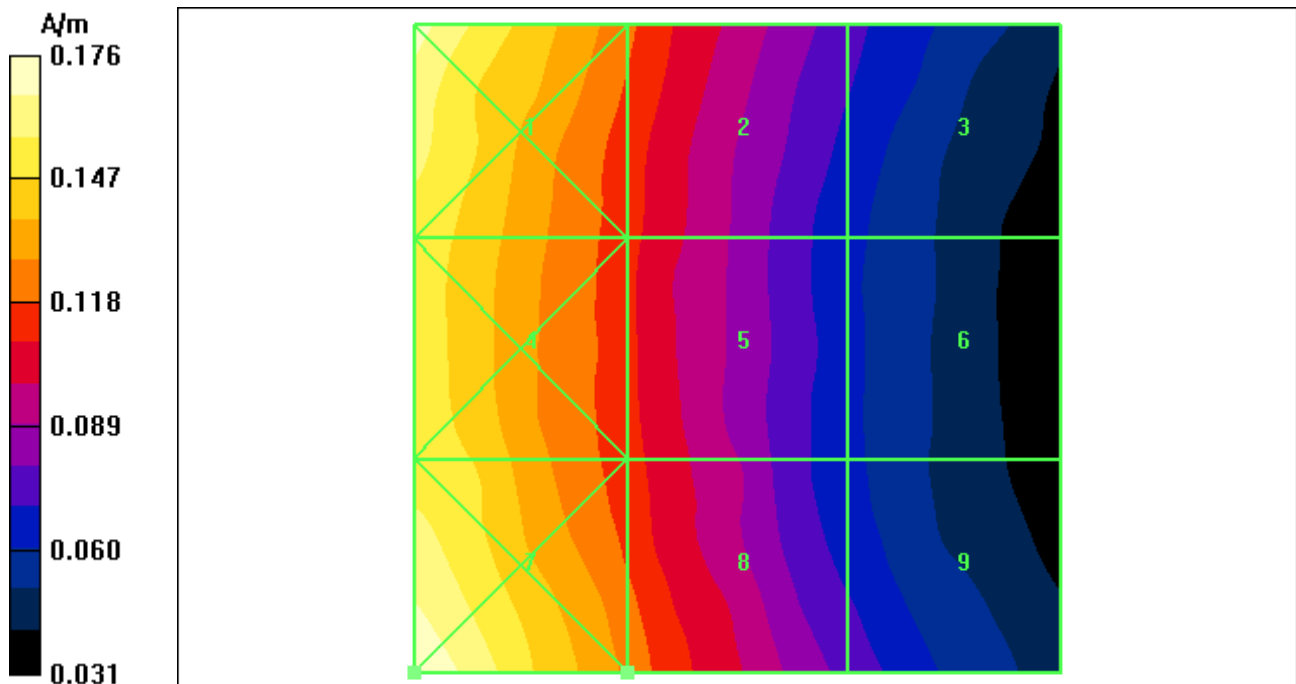

# Test Laboratory: Motorola- CDMA 1900 H-Field, 1/8th Rate Vocoder

Serial: LSOV290121; FCC ID: IHDT56LB1

Procedure Notes: Pwr Step: All up Bits; Antenna Position: Internal; Accessory Model #: N/A  
 Battery Model #: SNN5865A; Vocoder Rate: 1/8th; PMF Value: 2.46; Positioner: Polystyrene Block  
 Communication System: CDMA 1900; Frequency: 1908.75 MHz; Channel Number: 1175; Duty Cycle: 1:8  
 Medium: Air; Medium parameters used:  $\sigma = 0$  mho/m,  $\epsilon_r = 1$ ;  $\rho = 0$  kg/m<sup>3</sup>

## DASY4 Configuration:

- Probe: H3DV6 - SN6074; ; Calibrated: 7/16/2009
- Sensor-Surface: (Fix Surface)
- Electronics: DAE4 Sn699; Calibrated: 4/27/2009
- Phantom: R-3, HAC Test Arch (rev.2); Type: SD HAC P01 BA; Serial: 1071;
- Measurement SW: DASY4, V4.7 Build 80; Postprocessing SW: SEMCAD, V1.8 Build 186

## H Scan - Sensor center 15mm above WD, Hearing Aid Compatibility Test (101x101x1):

Measurement grid: dx=5mm, dy=5mm

Maximum value of peak Total field = 0.104 A/m; Probe Modulation Factor = 2.46

Device Reference Point: 0.000, 0.000, -6.30 mm; Reference Value = 0.046 A/m; Power Drift = -0.130 dB

### Hearing Aid Near-Field Category: M4 (AWF 0 dB)

Peak H-field in A/m

Grid 1 <b>0.137 M4</b>	Grid 2 <b>0.114 M4</b>	Grid 3 <b>0.097 M4</b>
Grid 4 <b>0.105 M4</b>	Grid 5 <b>0.104 M4</b>	Grid 6 <b>0.097 M4</b>
Grid 7 <b>0.091 M4</b>	Grid 8 <b>0.097 M4</b>	Grid 9 <b>0.084 M4</b>

