



**MOTOROLA**

*Mobile Devices business  
iDEN Mobile Devices Operations*

# RF Test Report

FCC Rule Parts: 90S and 24D

Industry Canada: RSS-Gen, RSS-119, RSS-134

**Product Name: i890**

**FCC ID: IHDT56KQ1**

**IC ID: 1090-KQ1**

Date: September 25, 2009

# Table of Contents

Test Report Details	6a.0-1
Transmitter Output Power	6a.1-1
Modulation Characteristics	6a.2-1
Radiated Spurious Emissions	TIMCO Report
Power Line Conducted Spurious Voltage	TIMCO Report
Frequency Stability	6a.5-1
Effective Radiated Power (ERP)	6a.6-1

## Test Report Details

Tests Performed by: Motorola EMC Laboratory  
 Plantation, Florida  
 8000 W. Sunrise Blvd  
 Plantation, Florida 33322  
 Phone: (954) 723-5480  
 FAX: (954) 723-3803

FCC Registration Number: **91932**  
 Industry Canada Number: **IC109U-1**

---

TIMCO Engineering  
 Laboratory details in report

FCC Registration Number: **95517**  
 Industry Canada Number: **2056A**

Product Type: Cellular Phone

Signaling Capabilities: iDEN 800 MHz, iDEN 900 MHz

FCC ID: IHDT56KQ1

IC ID: 1090-KQ1

## Applicable Standards

All tests and measurements indicated in this document were performed in accordance with the United States Code of Federal Regulations, Title 47 Part 2, Sub-part J, as well as the following parts:

- X   Part 90 Subpart S – Private Land Mobile Radio Service.
- X   Part 24 Subpart D – Personal Communications Services.
- X   RSS-119 – Land Mobile and Fixed Radio Transmitters and Receivers Operating in the Frequency Range 27.41-960 MHz.
- X   RSS-134 – 900 MHz Narrowband Personal Communications Services.

Applicable Standards: TIA/EIA-603-A, TIA/EIA-603-B, and ANSI C63.4-2003

## **Exhibit 6a.1. Part 90/Part 24 Measured Data -- Pursuant 47 CFR. 2.1046; RSS-Gen Section 3, RSS-119 Section 5.4, RSS-134 Section 6.2.**

### **6a.1.1 Land Mobile Transmitter Power**

The transmitter is a variable power type used in a SMR trunking system. Output power (as defined in 47 CFR 90.7 and/or §24.132) is dynamically controlled as described in Exhibit 12.

### **6a.1.2 Maximum Output Power Rating -- Pursuant 47 CFR 2.1033(c)(7), §90.635(d), and §24.132(a)**

Maximum output power rating: 640 milliwatts (28.06 dBm), pulse average power. Output power will vary from 0.22 to 640 milliwatts (pulse average power).

*Note 1: Nominal output power rating: 600 milliwatts (27.78 dBm) (Pulse average power).*

*Note 2: These ratings are compliant with the FCC maximum of 100 watts (50 dBm) for Mobile stations operating under Part 90.*

*Note 3: These ratings are compliant with the FCC maximum of 7 watts ERP for Mobile stations operating under Part 24.*

*Note 4: The term pulse average power is used to specify the power that would be measured during the intervals of recurrent TDM transmission pulses by an average responding RF power meter. Power expressed in this manner is independent of the TDM duty cycle, and facilitates RF system coverage analysis.*

### **6a.1.3 Operating output power range -- Pursuant 47 CFR 2.1033(c)(6)**

Maximum tuned output power will vary over a range of 500 to 640 milliwatts (maximum pulse average power) to a minimum power of 34 dB below maximum tuned output power.

### **6a.1.4 DC power used by final amplifier device -- Pursuant 47 CFR 2.1033(c)(8)**

In order to prevent the malfunctions that can occur due to directly measuring the DC characteristics of the final RF amplifying stage, data was obtained by measuring the entire radio DC current and is reported herein for the entire radio.

The DC current and the RF output power was measured with a special RF/DC test fixture set to supply the radio with the nominal battery voltage of 4V. The characteristics were measured during a transmission pulse and are listed in the Table below.

Characteristics	800 MHz		900 MHz		901.5 MHz	
	minimum	maximum	minimum	maximum	minimum	maximum
<b>DC Voltage (Volts)</b>	4.0	4.0	4.0	4.0	4.0	4.0
<b>DC Current (A)</b>	0.61	1.76	0.57	1.86	0.58	1.87
<b>Output Power (mW)</b>	0.22	640	0.22	640	0.22	640

**Table 6a.1-1 Characteristics for 800 and 900 MHz SMR bands, and NBPCS Band**

### 6a.2. Modulation Characteristics and Necessary Bandwidth -- Pursuant 47 CFR §2.1047(d), §2.1049, §2.202, §90.210(g), §90.669(a), and §90.691; RSS-Gen Section 3, RSS-119 Section 4.2.

#### 6a.2.1 Emission Designator 18K3D7W - iDEN 800 MHz Band Measured data

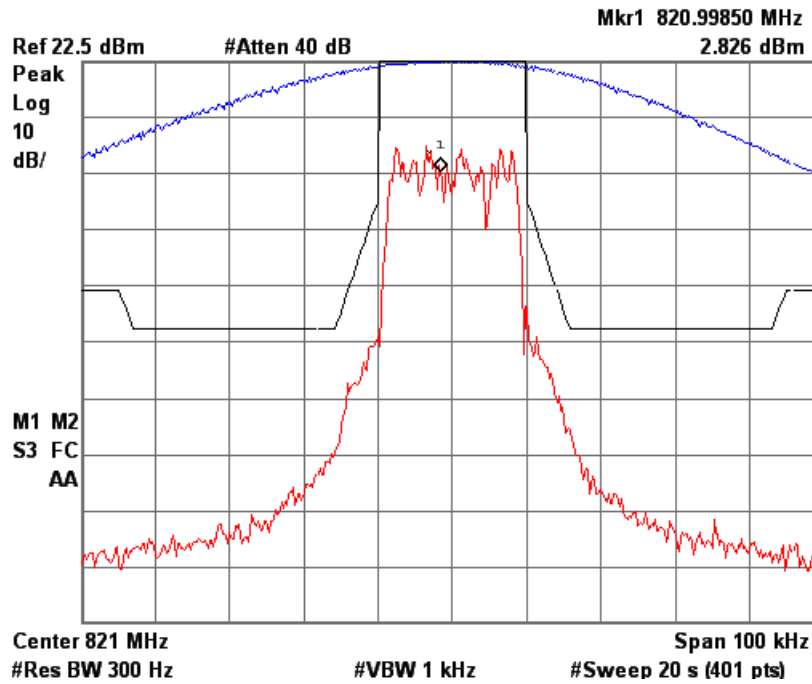


Figure 6a-2.1.1. iDEN 800 MHz Band, QPSK, Maximum Power, Emission Mask G

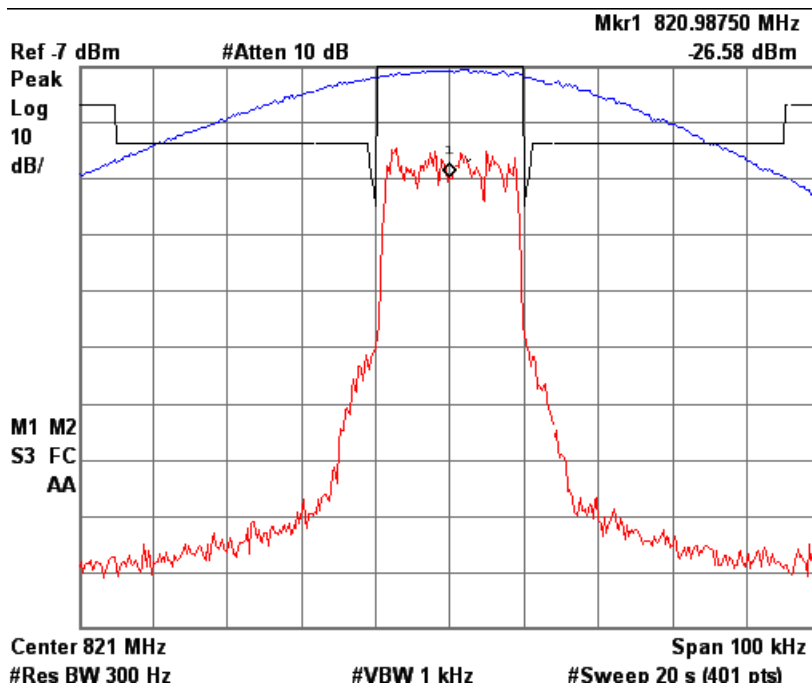


Figure 6a-2.1.2. iDEN 800 MHz Band, QPSK, Minimum Power, Emission Mask G

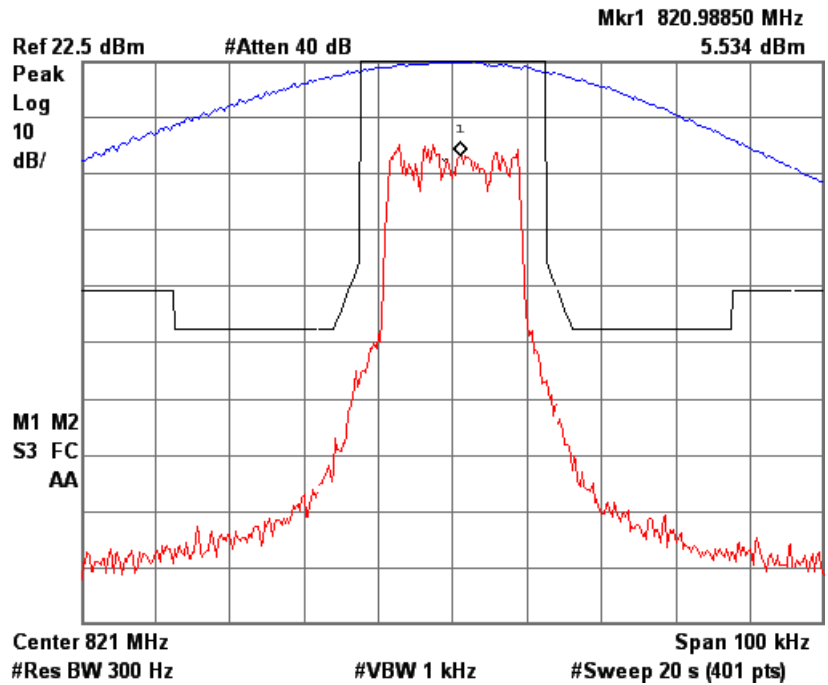


Figure 6a-2.1.3. iDEN 800 MHz Band, Quad-QPSK, Maximum Power, EA Emission Mask

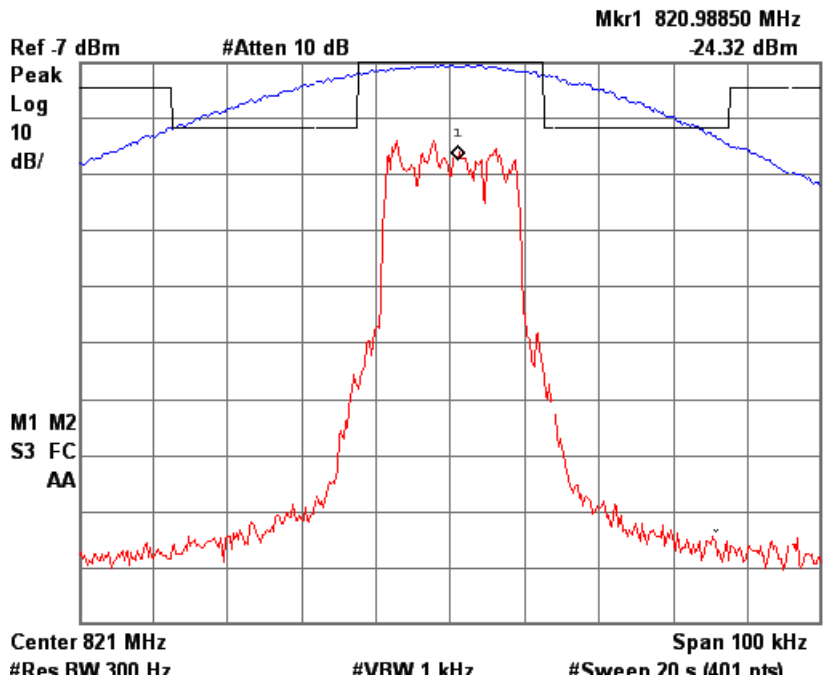


Figure 6a-2.1.4. iDEN 800 MHz Band, QPSK, Minimum Power, EA Emission Mask

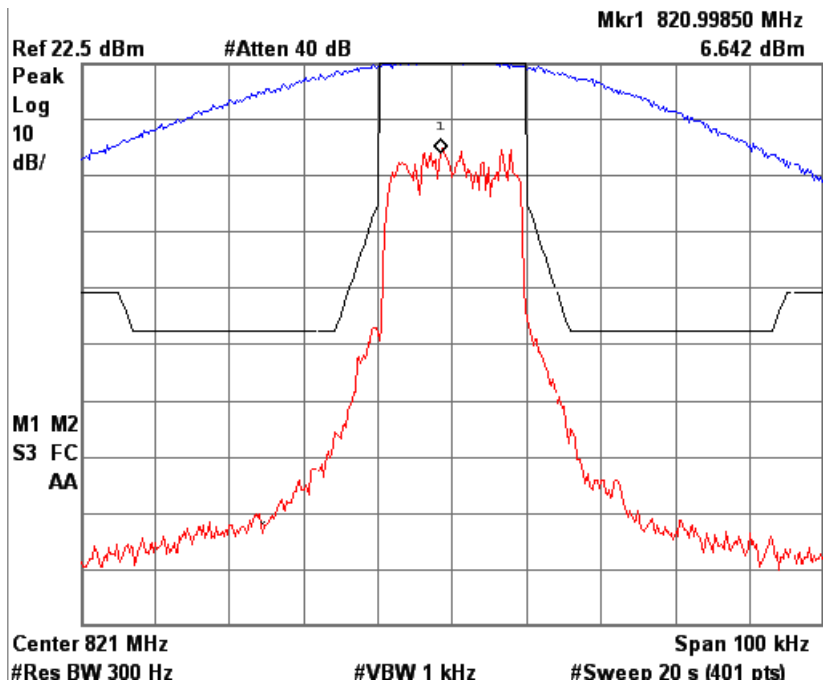


Figure 6a-2.1.5. iDEN 800 MHz Band, QAM16, Maximum Power, Emission Mask G

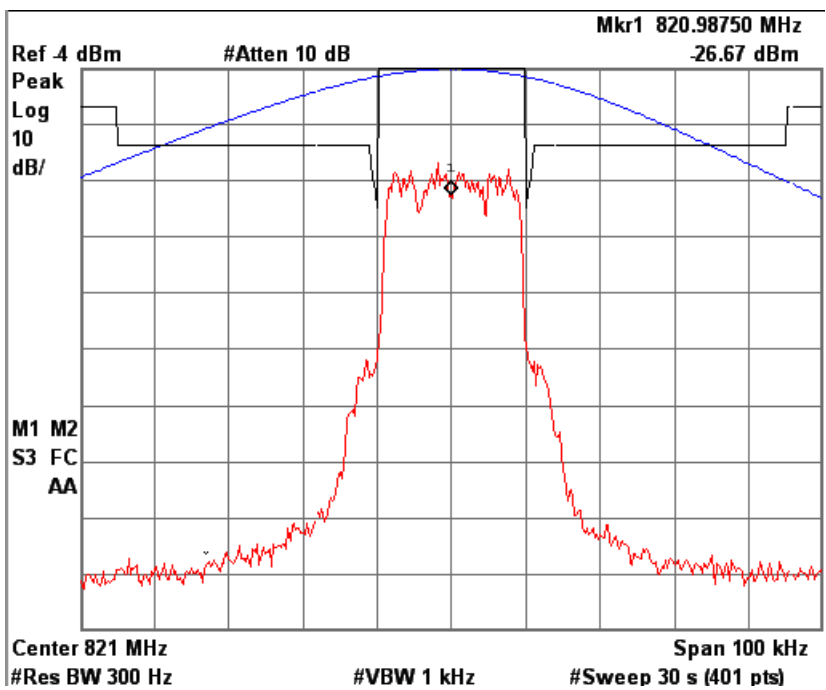


Figure 6a-2.1.6. iDEN 800 MHz Band, QAM16, Minimum Power, Emission Mask G

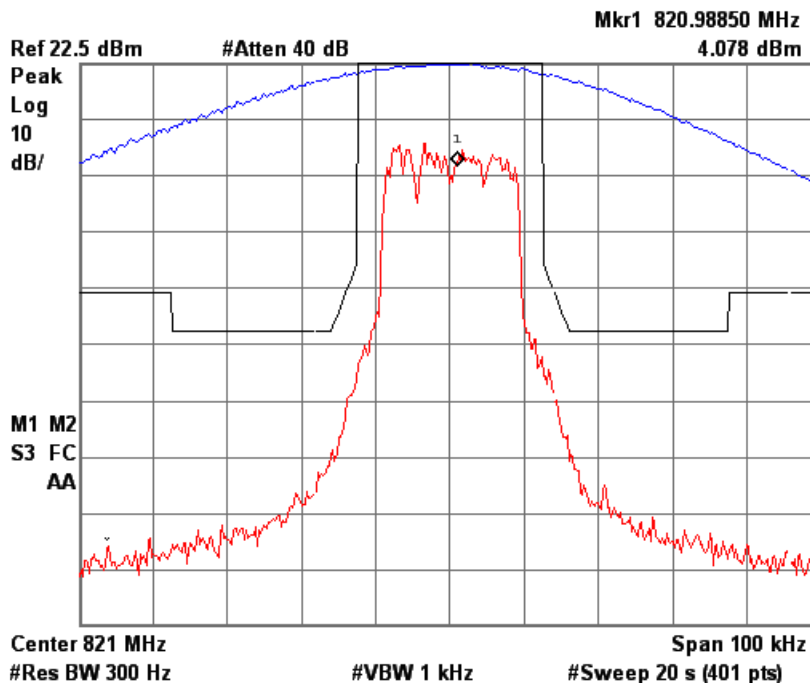


Figure 6a-2.1.7. iDEN 800 MHz Band, QAM16, Maximum Power, EA Emission Mask

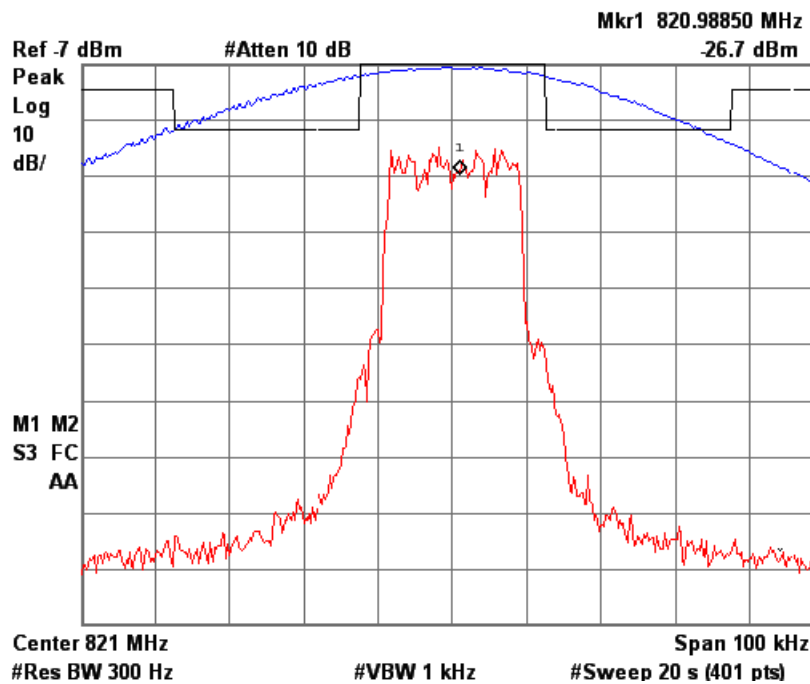


Figure 6a-2.1.8. iDEN 800 MHz Band, QAM16, Minimum Power, EA Emission Mask

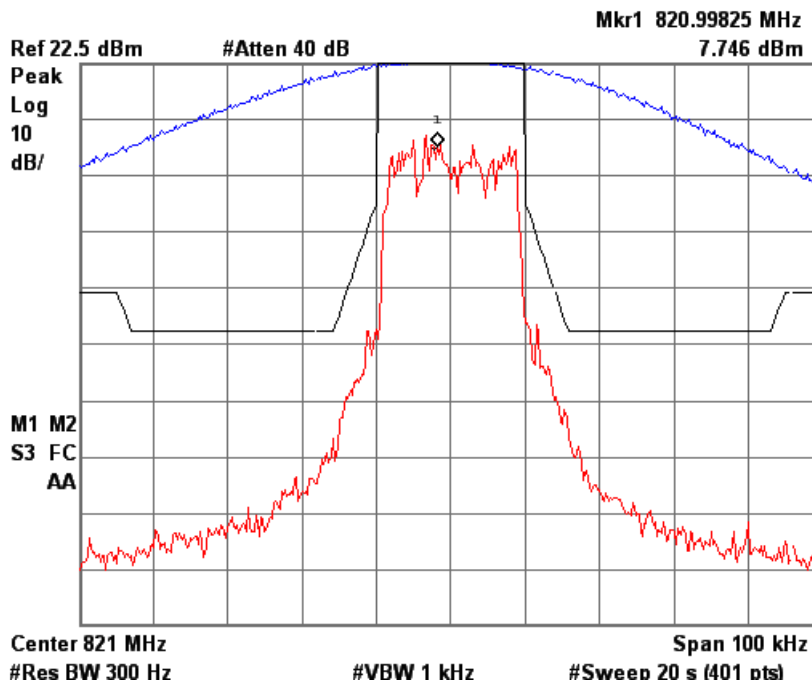


Figure 6a-2.1.9. iDEN 800 MHz Band, QAM64, Maximum Power, Emission Mask G

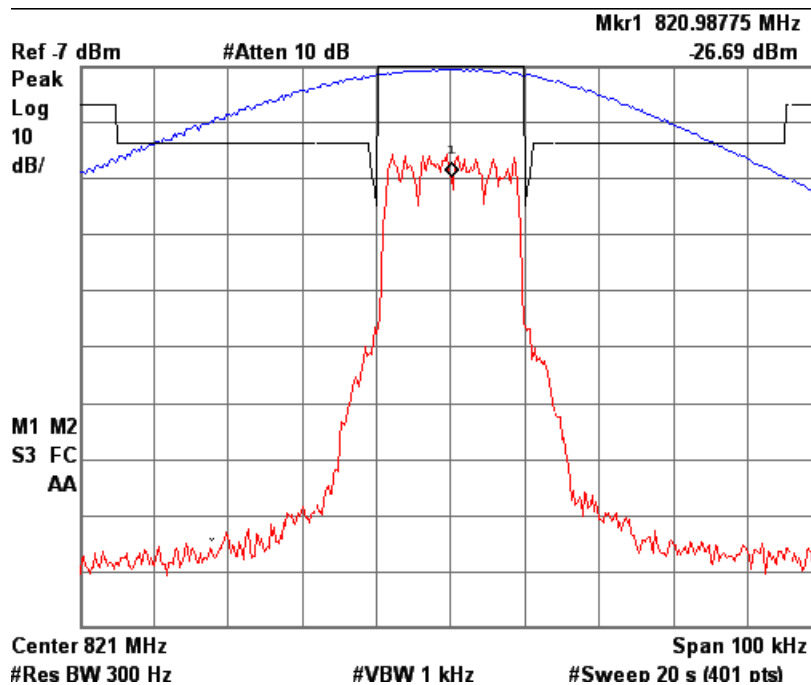


Figure 6a-2.1.10. iDEN 800 MHz Band, QAM64, Minimum Power, Emission Mask G

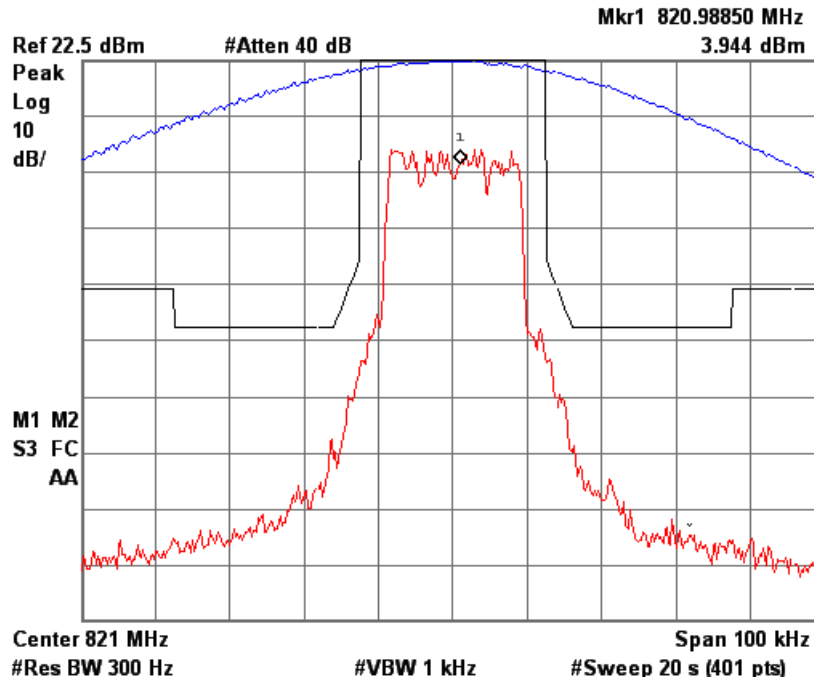


Figure 6a-2.1.11. iDEN 800 MHz Band, QAM64, Maximum Power, EA Emission Mask

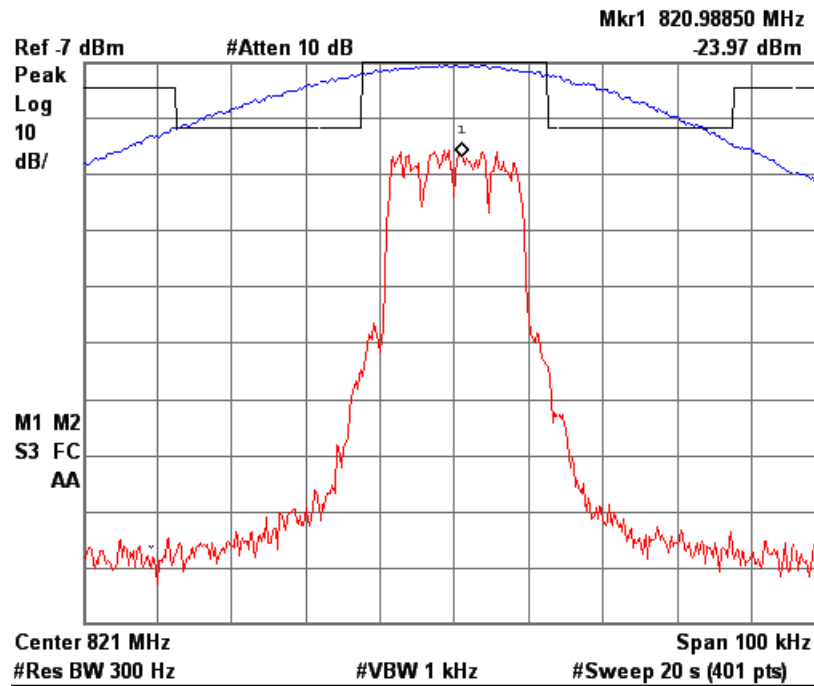


Figure 6a-2.1.12. iDEN 800 MHz Band, QAM64, Minimum Power, EA Emission Mask

### 6a.2.2. Emission Designator 18K3D7W - iDEN 900 MHz Band Measured Data

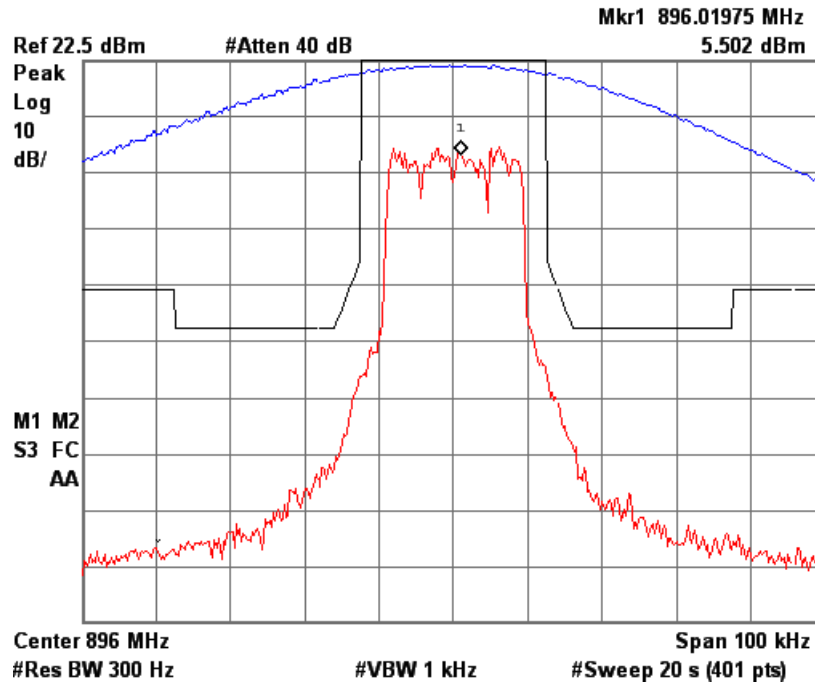


Figure 6a-2.2.1. iDEN 900 MHz Band, Quad-QPSK, Maximum Power, Emission Mask G

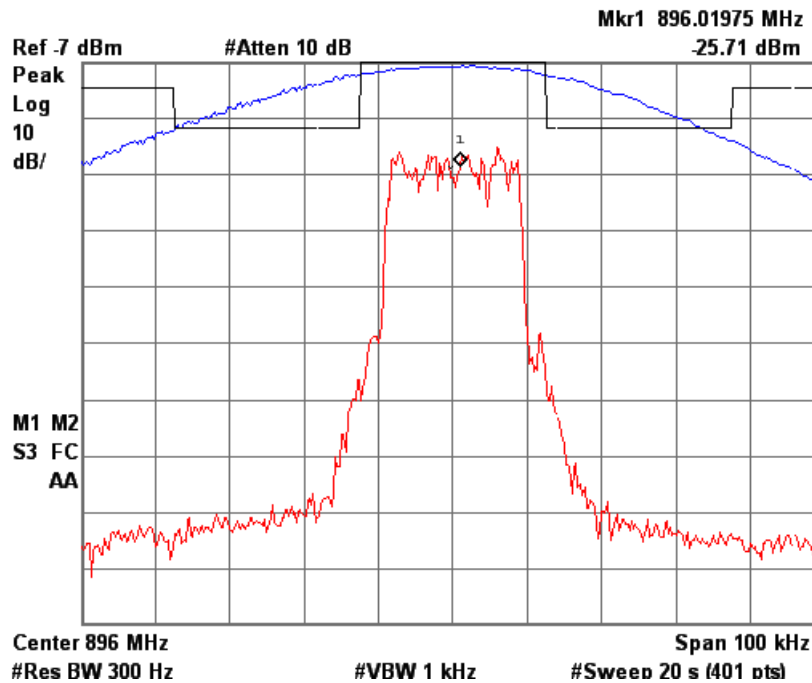


Figure 6a-2.2.2. iDEN 900 MHz Band, Quad-QPSK, Minimum Power, Emission Mask G

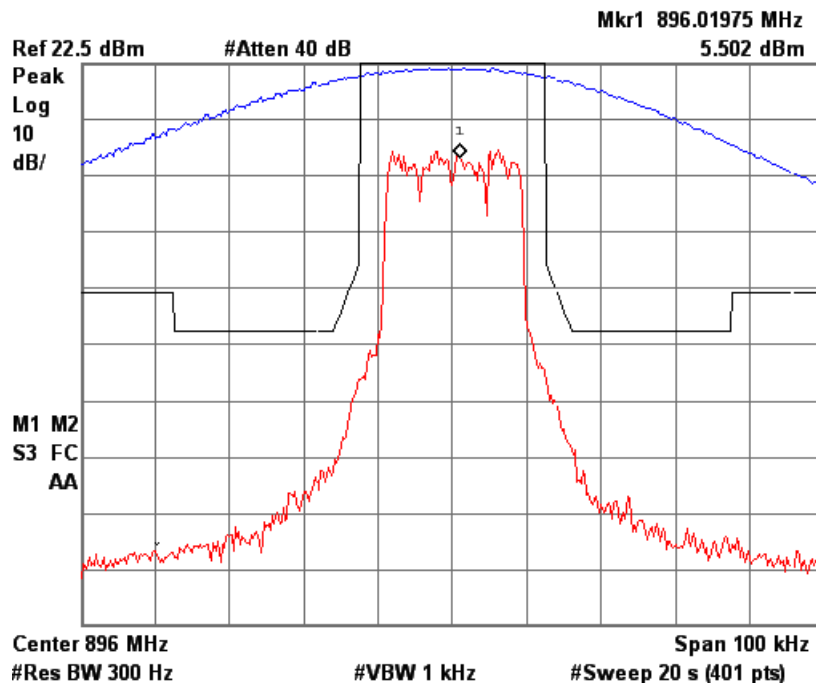


Figure 6a-2.2.3. iDEN 900 MHz Band, Quad-QPSK, Maximum Power, EA Emission Mask

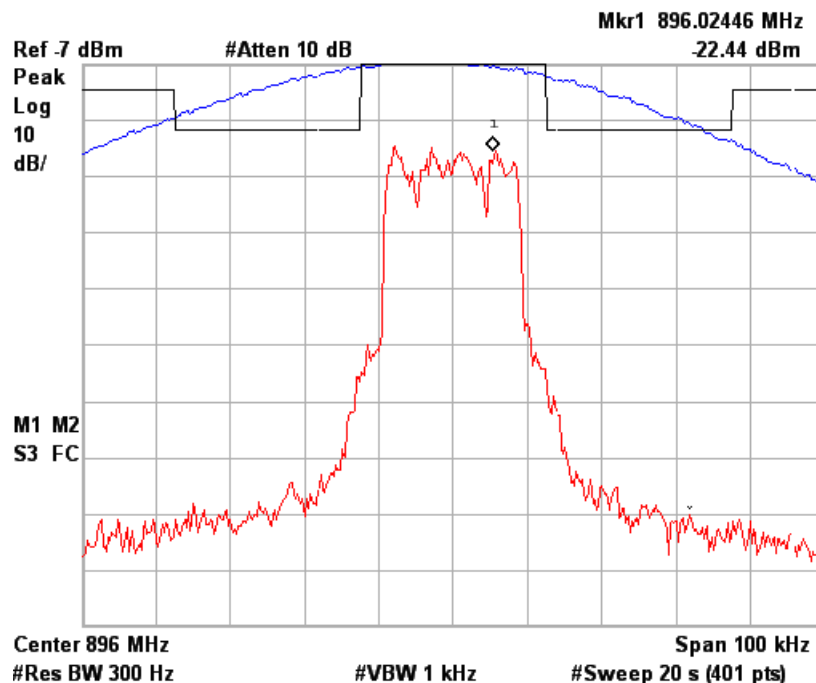


Figure 6a-2.2.4. iDEN 900 MHz Band, Quad-QPSK, Minimum Power, EA Emission Mask

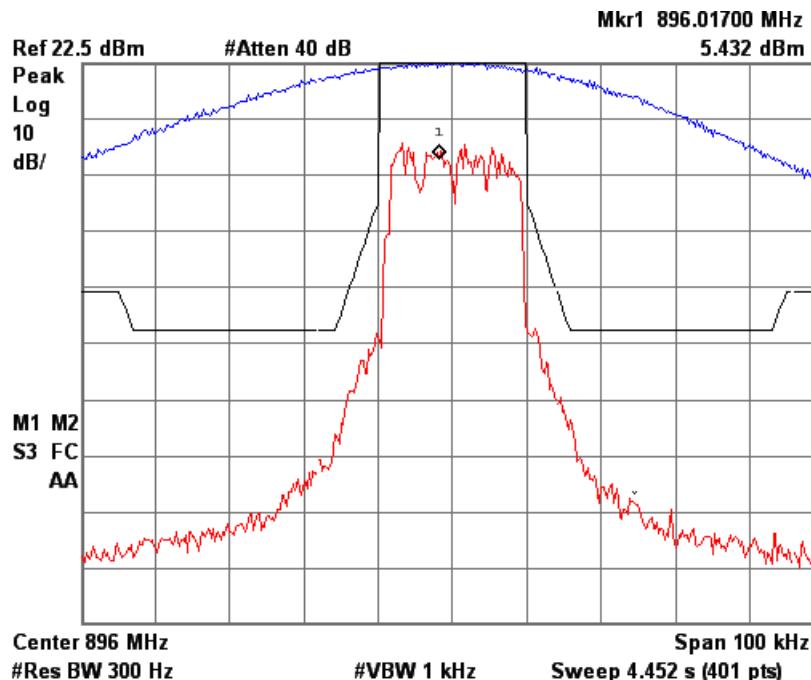


Figure 6a-2.2.5. iDEN 900 MHz Band, QAM16, Maximum Power, Emission Mask G

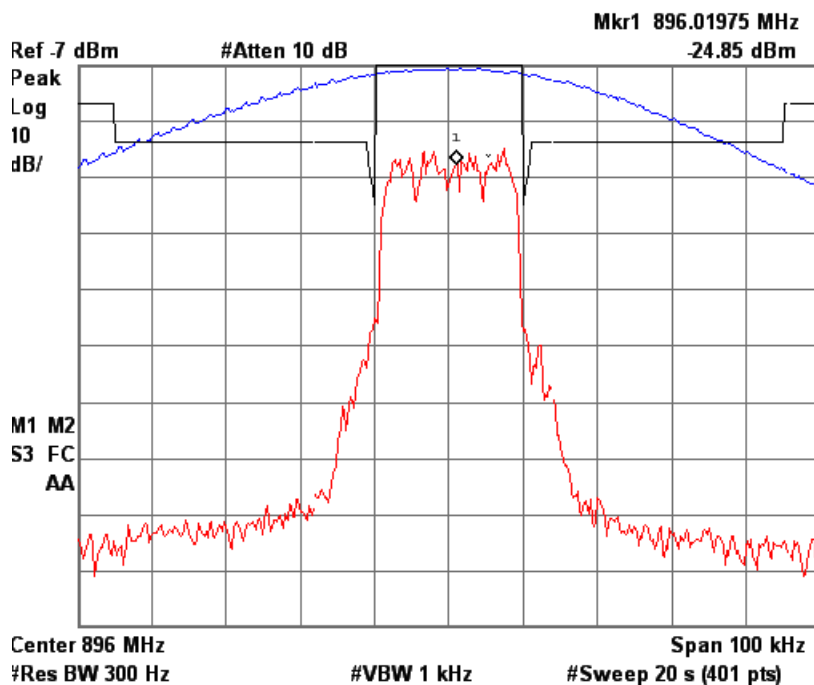


Figure 6a-2.2.6. iDEN 900 MHz Band, QAM16, Minimum Power, Emission Mask G

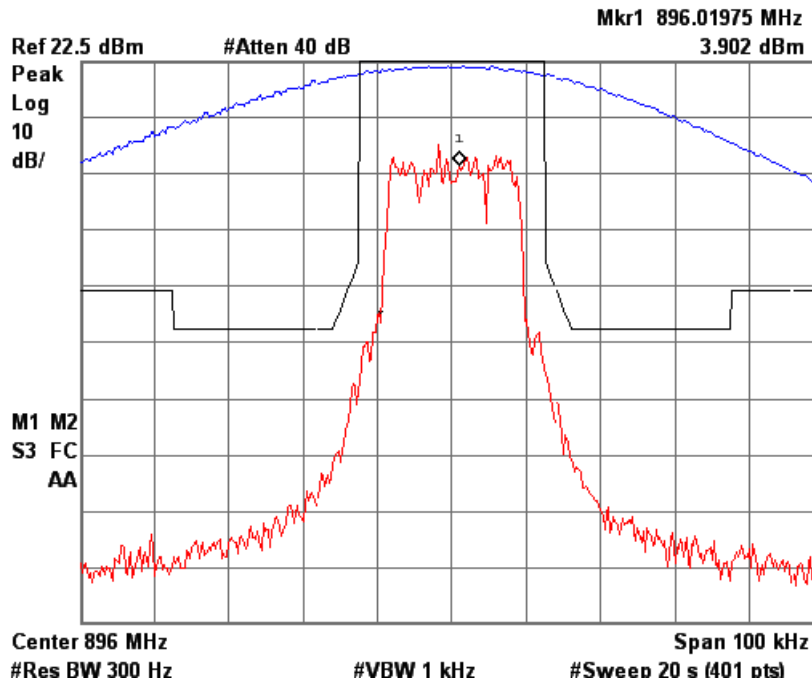


Figure 6a-2.2.7. iDEN 900 MHz Band, QAM16, Maximum Power, EA Emission Mask

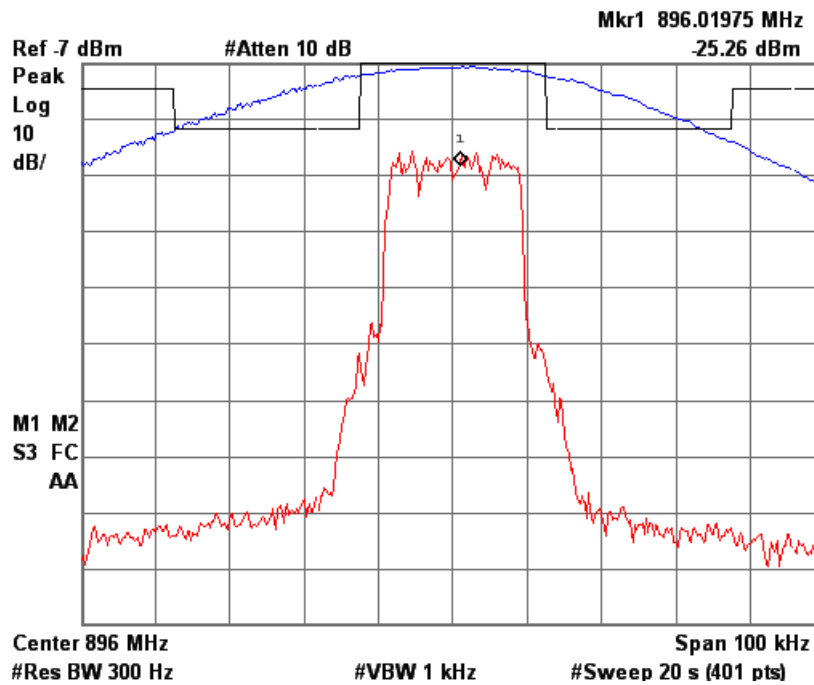


Figure 6a-2.2.8. iDEN 900 MHz Band, QAM16, Minimum Power, EA Emission Mask

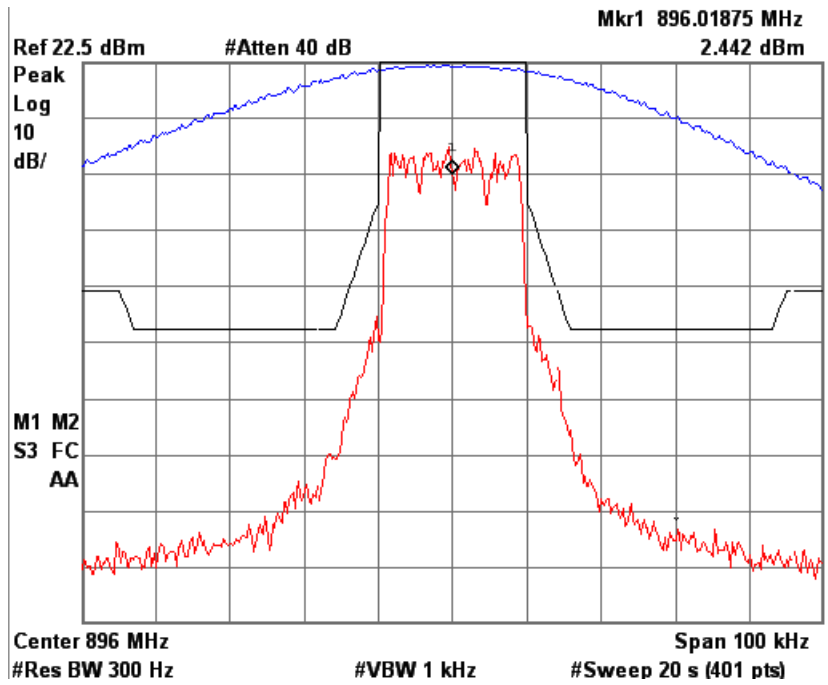


Figure 6a-2.2.9. iDEN 900 MHz Band, QAM64, Maximum Power, Emission Mask G

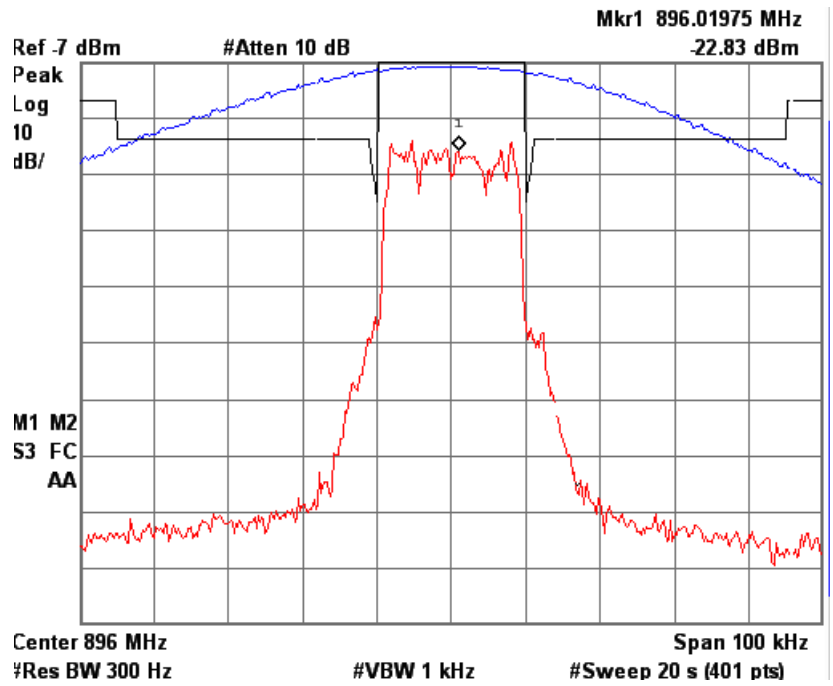


Figure 6a-2.2.10. iDEN 900 MHz Band, QAM64, Minimum Power, Emission Mask G

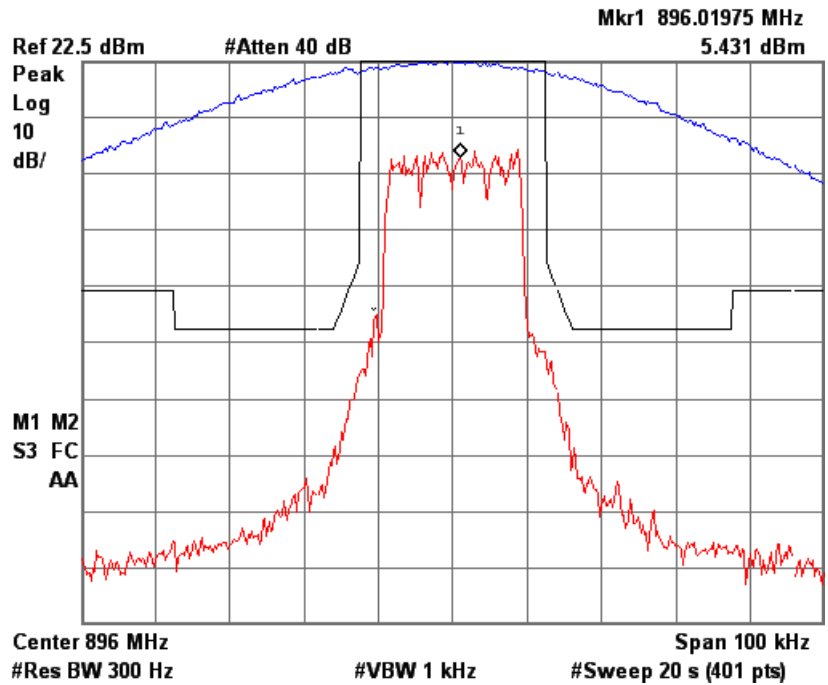


Figure 6a-2.2.11. iDEN 900 MHz Band, QAM64, Maximum Power, EA Emission Mask

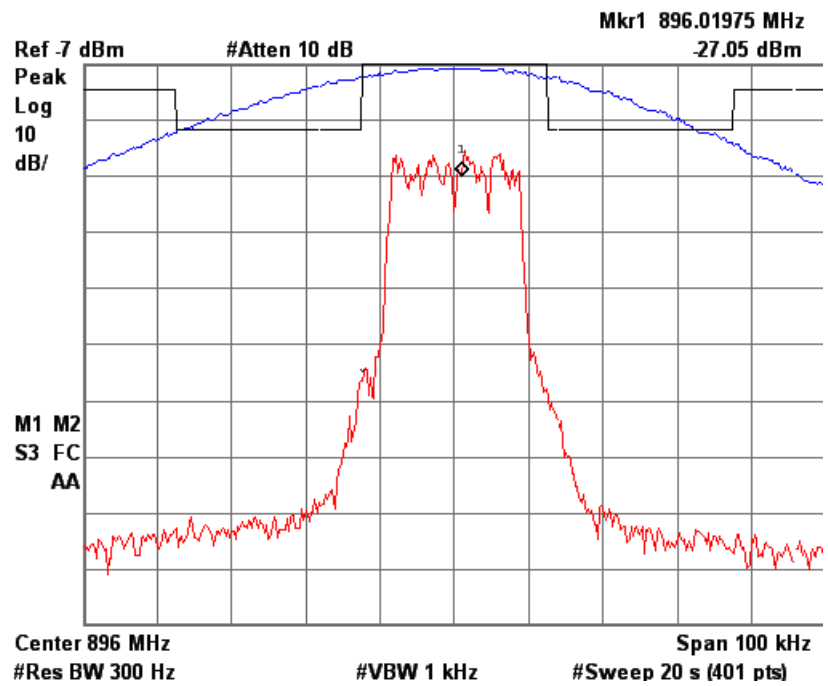
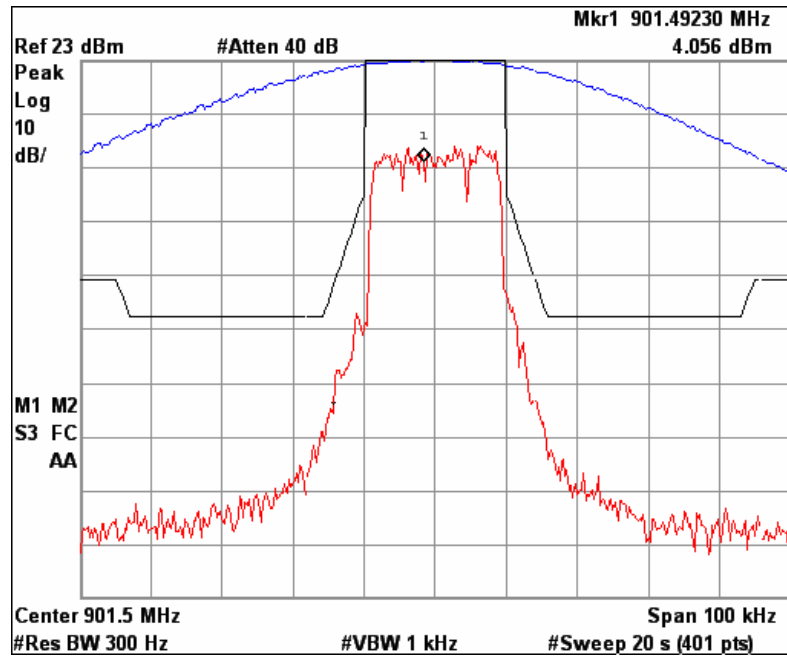


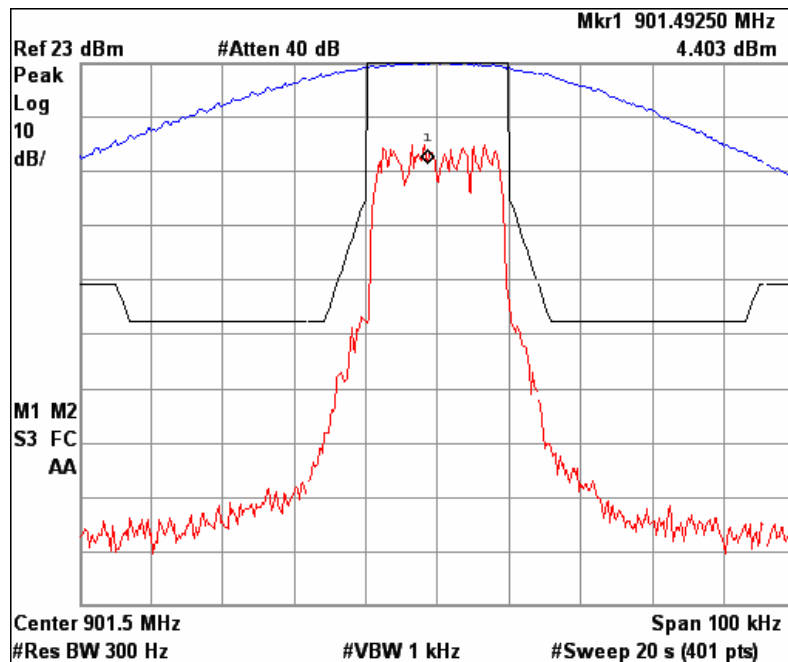
Figure 6a-2.2.12. iDEN 900 MHz Band, QAM64, Minimum Power, EA Emission Mask

**6b.2. Modulation Characteristics and Necessary Bandwidth -- Pursuant 47 CFR 2.1033(c)(13), §2.1047(d), §2.1049, §2.202, §24.131, and §24.133(a)(1); RSS-Gen Section 3, RSS-134 Section 6.3.**

**6b.2.1 Emission Designator 18K3D7W - NBPCS iDEN Measured data**

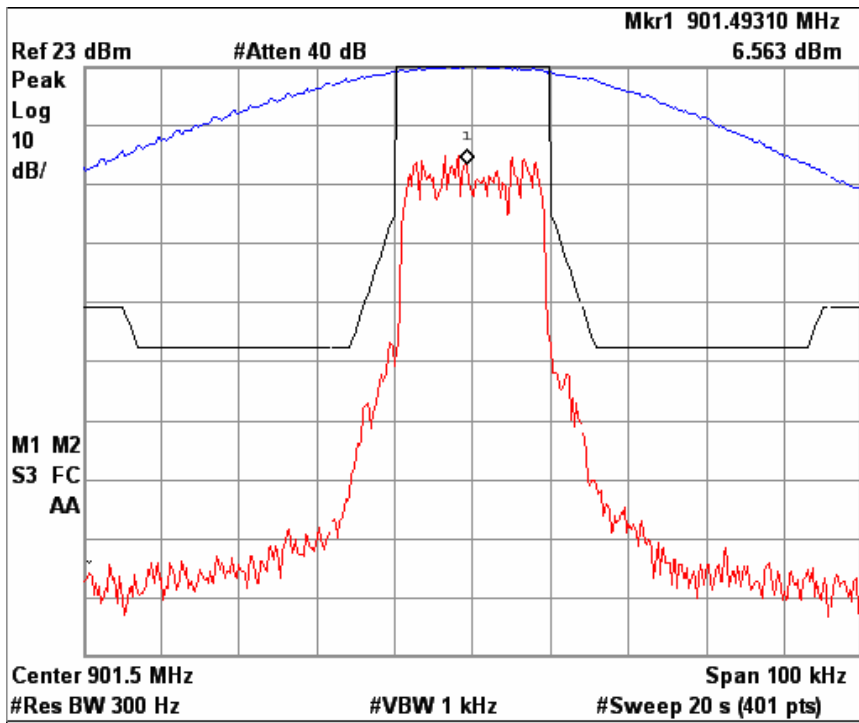


**Figure 6b.2.1-1 iDEN NBPCS Band, Occupied Bandwidth, Quad-QPSK, Maximum Power.**



**Figure 6b.2.1-2 iDEN NBPCS Band, Occupied Bandwidth, Quad-16QAM, Maximum**

**Power.**



**Figure 6b.2.1-3 iDEN NBPCS Band, Occupied Bandwidth, Quad-64QAM, Maximum Power.**

1.

## 6a.5 Land Mobile Frequency Stability -- Pursuant to 47 CFR 2.1055(a)(1), §2.1055(d)(2), and §24.135; RSS-Gen Section 3.2, RSS-119 Section 5.3, RSS-134 Section 7.

Frequency stability measurements were made as described in paragraph 7.4. Because of the transmitter's dependence on the stability of the base station oscillator, it is not possible to provide stability data for this transmitter as is commonly supplied for certification per 47 CFR 2.1055 for a radio with a locally stabilized oscillator. The following data was collected in a setup comprising of a base station simulator and it represents the absolute frequency error of the transceiver under test versus the base station frequency reference.

<b>Frequency Stability (in ppm) at 813.5125 MHz, Voltage = 4V<sub>DC</sub></b>		
<b>TEMP (°C)</b>	<b>Frequency Error (Hz)</b>	<b>Error (ppm)</b>
-30	34.59	0.043
-20	67.16	0.083
-10	18.91	0.023
0	65.12	0.080
10	81.42	0.100
20	11.15	0.014
30	79.82	0.098
40	136.25	0.167
50	84.94	0.104
60	47.82	0.059

**Table 6a.5-1. Transmitter Frequency Stability vs. Temperature in 800 MHz SMR Band.**

<b>Frequency Stability in PPM at 899.98125 MHz, Voltage = 4V<sub>DC</sub></b>		
<b>TEMP (°C)</b>	<b>Frequency Error (Hz)</b>	<b>Error (ppm)</b>
-30	82.67	0.092
-20	152.36	0.170
-10	45.28	0.051
0	106.32	0.119
10	131.19	0.146
20	47.59	0.053
30	123.93	0.138
40	183.56	0.205
50	138.49	0.155
60	82.38	0.092

**Table 6a.5-2. Transmitter Frequency Stability vs. Temperature in 900 MHz SMR Band.**

<b>Frequency Stability in PPM at 900.98125 MHz, Voltage = 4V<sub>DC</sub></b>		
<b>TEMP (°C)</b>	<b>Frequency Error (Hz)</b>	<b>Error (ppm)</b>
-30	82.67	0.092
-20	152.36	0.170
-10	45.28	0.051
0	106.32	0.119
10	131.19	0.146
20	47.59	0.053
30	123.93	0.138
40	183.56	0.205
50	138.49	0.155
60	82.38	0.092

**Table 6a.5-3. Transmitter Frequency Stability vs. Temperature in 900 MHz NBPCS Band.**

<b>Frequency Stability in PPM at 813.5125 MHz, Temperature = 25°C</b>		
<b>Power Supply Output Voltage</b>	<b>Frequency Error in Hz</b>	<b>PPM</b>
3.55	43.68	0.054
3.6	39.51	0.049
3.7	67.52	0.083
3.8	70.28	0.086
3.9	68.49	0.084
4.0	55.85	0.069
4.1	58.75	0.072
4.2	39.25	0.048

**Table 6a.5-4. Transmitter Frequency Stability vs. Voltage in 800 MHz SMR Band.**

<b>Frequency Stability in PPM at 900.98125 MHz, Temperature = 25°C</b>		
<b>Power Supply Output Voltage</b>	<b>Frequency Error in Hz</b>	<b>PPM</b>
3.55	87.16	0.107
3.6	76.91	0.095
3.7	121.35	0.135
3.8	134.51	0.150
3.9	119.05	0.133
4.0	125.81	0.140
4.1	107.21	0.120
4.2	85.94	0.096

**Table 6a.5-5. Transmitter Frequency Stability vs. Voltage in 900 MHz SMR Band.**

<b>Frequency Stability in PPM at 900.98125 MHz, Temperature = 25°C</b>		
<b>Power Supply Output Voltage</b>	<b>Frequency Error in Hz</b>	<b>PPM</b>
3.55	87.16	0.107
3.6	76.91	0.095
3.7	121.35	0.135
3.8	134.51	0.15
3.9	119.05	0.133
4.0	125.81	0.14
4.1	107.21	0.12
4.2	85.94	0.096

**Table 6a.5-6. Transmitter Frequency Stability vs. Voltage in 900 MHz NBPCS Band.**

## 6a.6 Effective Radiated Power (ERP) -- Pursuant 47 CFR 2.1046 and §24.132(b); RSS-Gen Section 3.2, RSS-119 Section 5.4, RSS-134 Section 6.2.

The ERP characteristic was measured while a radio was set to transmit a test mode signal at the maximum rated output power (+/- 5%) and was vertically mounted on a non-conducting platform/turntable in a spherical RF Anechoic Chamber. The power at the receive antenna was recorded on a power meter with the unit rotating about the z-axis. The azimuth of receiving antenna is rotated 180 degrees while the UUT is rotating producing a spiral antenna measurement. For this ERP test, the phi cuts were taken in 15 degree increments or slices and the theta spins used about 200 measurements per rotation. ERP data is extracted from the phi= 90 degree cut. The power recorded from the meter is then corrected to compensate for path loss, cable losses, and amplifier and antenna gains at the given frequencies resulting in absolute radiated power.

The following calculations show how the reported scaled max ERP was determined.

### **For 800 MHz SMR band operation,**

$$\begin{aligned} \text{Measured MaxERP, dBm} &= 10 * \log(\text{measured output power, mW}) + \text{measured antenna gain, dBd} \\ &= 27.40 \text{ dBm} \end{aligned}$$

The resulting max ERP was converted to mW:

$$\begin{aligned} \text{MeasuredMaxERP, mW} &= 10^{\left(\frac{\text{Measured MaxERP, dBm}}{10}\right)} \\ &= 549.5 \text{ mW} \end{aligned}$$

Since the measured max ERP was not determined at the production maximum output power, a simple scaling is performed to 640 mW:

$$\begin{aligned} \text{Scaled MaxERP, mW} &= \text{Measured MaxERP, mW} * \left(\frac{640\text{mW}}{\text{measured output power, mW}}\right) \\ &= 590.2 \text{ mW} \end{aligned}$$

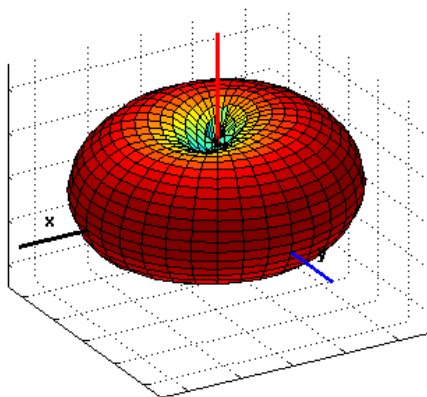


Figure 6a.6-1 Antenna pattern in the 800 MHz SMR frequency band (Flip Open).

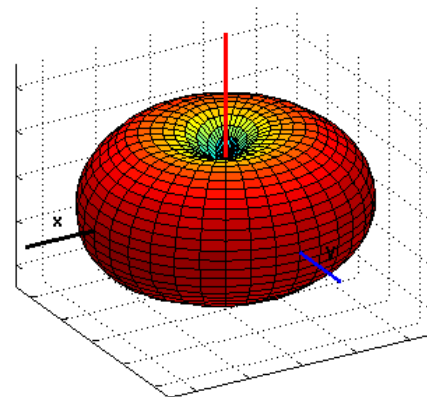


Figure 6a.6-2 Antenna pattern in the 800 MHz SMR frequency band (Flip Closed).

**For 900 MHz SMR band operation,**

$$\begin{aligned} \text{Measured MaxERP, dBm} &= 10 * \log(\text{measured output power, mW}) + \text{measured antenna gain, dBd} \\ &= 27.70 \text{ dBm} \end{aligned}$$

The resulting max ERP was converted to mW:

$$\begin{aligned} \text{MeasuredMaxERP, mW} &= 10^{\left(\frac{\text{Measured MaxERP, dBm}}{10}\right)} \\ &= 588.8 \text{ mW} \end{aligned}$$

Since the measured ERP was not determined at the production maximum output power, a simple scaling is performed to 640 mW:

$$\begin{aligned} \text{Scaled MaxERP, mW} &= \text{Measured MaxERP, mW} * \left(\frac{640\text{mW}}{\text{measured output power, mW}}\right) \\ &= 633.9 \text{ mW} \end{aligned}$$

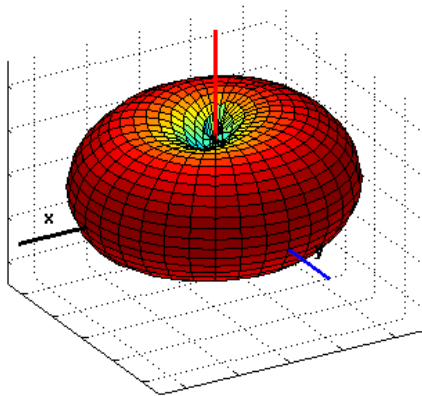


Figure 6a.6-3 Antenna pattern in the 900 MHz SMR frequency band (Flip Open).

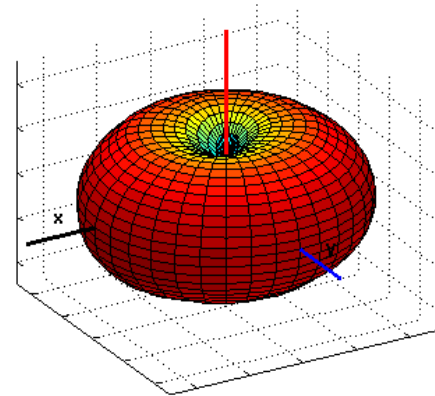


Figure 6a.6-4 Antenna pattern in the 900 MHz SMR frequency band (Flip Closed).

**For 900 MHz NBPCS band operation,**

$$\begin{aligned} \text{Measured MaxERP, dBm} &= 10 * \log(\text{measured output power, mW}) + \text{measured antenna gain, dBd} \\ &= 27.70 \text{ dBm} \end{aligned}$$

The resulting max ERP was converted to mW:

$$\begin{aligned} \text{MeasuredMaxERP, mW} &= 10^{\left(\frac{\text{Measured MaxERP, dBm}}{10}\right)} \\ &= 588.8 \text{ mW} \end{aligned}$$

Since the measured ERP was not determined at the production maximum output power, a simple scaling is performed to 640 mW:

$$\begin{aligned} \text{Scaled MaxERP, mW} &= \text{Measured MaxERP, mW} * \left(\frac{640\text{mW}}{\text{measured output power, mW}}\right) \\ &= 633.9 \text{ mW} \end{aligned}$$

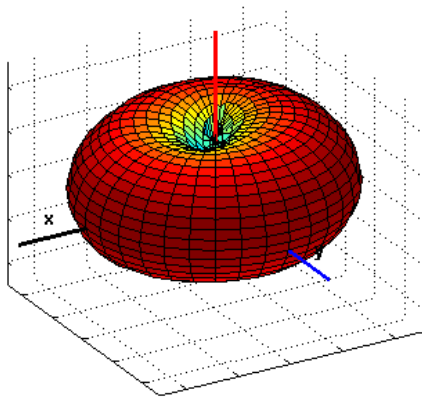


Figure 6a.6-5 Antenna pattern in the 900 MHz NBPCS frequency band (Flip Open).

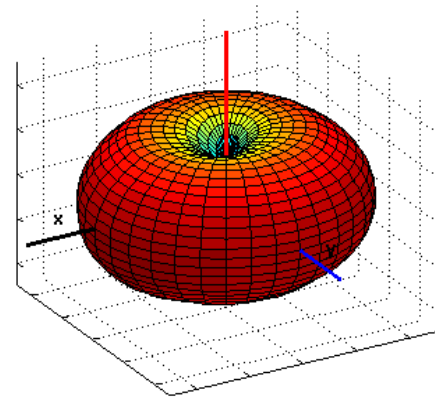


Figure 6a.6-6 Antenna pattern in the 900 MHz NBPCS frequency band (Flip Closed).