



**MOTOROLA**

## HAC Test Report for Near Field Emissions IHDT56GS1

**Date of test:** August 20 & 21, 2006  
**Date of Report:** September 5, 2006

**Laboratory:** Motorola Mobile Devices Business Product Safety & Compliance Laboratory  
600 N. US Highway 45  
Room: MW113  
Libertyville, Illinois 60048

**Test Responsible:** Katerina Royzen  
Engineer

**Statement of Compliance:** Motorola declares under its sole responsibility that portable cellular telephone FCC IHDT56GS1 to which this declaration relates, complies with recommendations and guidelines FCC 47 CFR §20.19. The measurements were performed to ensure compliance to the ANSI C63.19-2006. It also declares that the product was tested in accordance with the appropriate measurement standards, guidelines and recommended practices. Any deviations from these standards, guidelines and recommended practices are noted below:

(none)

**Results Summary:** M Category = M4

©Motorola, Inc. 2006

This test report shall not be reproduced except in full, without written approval of the laboratory.

The results and statements contained herein relate only to the items tested. The names of individuals involved may be mentioned only in connection with the statements or results from this report.

Motorola encourages all feedback, both positive and negative, on this test report.

**Table of Contents**

**1. INTRODUCTION .....3**

**2. DESCRIPTION OF THE DEVICE UNDER TEST.....3**

**3. TEST EQUIPMENT USED.....4**

**4. VALIDATION .....5**

**5. PROBE MODULATION FACTOR .....6**

**6. TEST RESULTS.....7**

**APPENDIX 1: DETAILS OF THE WD'S SIGNAL .....11**

**APPENDIX 2: DETAILS JUSTIFYING THE CONVERSION TO PEAK .....14**

**A2.1 Procedure for PMF measurements .....15**

**A2.2 0 Span Spectrum Plots for PMF measurements .....16**

**APPENDIX 3: HAC DISTRIBUTION PLOTS FOR VALIDATION .....18**

**APPENDIX 4: HAC DISTRIBUTION PLOTS FOR E-FIELD AND H-FIELD .....19**

**APPENDIX 5: MOTOROLA UNCERTAINTY BUDGET .....20**

**A5.1 Motorola Uncertainty Budget for RF HAC Testing .....21**

**A5.2 Probe Rotation Contributions to Isotropy Error .....21**

**APPENDIX 6: PICTURES OF TEST SETUP .....22**

**APPENDIX 7: PROBE CALIBRATION CERTIFICATES .....25**

**APPENDIX 8: DIPOLE CHARACTERIZATION CERTIFICATE .....26**

**1. Introduction**

The Motorola Mobile Devices Business Product Safety Laboratory has performed Hearing Aid Compatibility (HAC) measurements for the portable cellular phone (FCC ID IHDT56GS1). The portable cellular phone was tested in accordance with ANSI PC63.19-2006 standard. The test results presented herein clearly demonstrate compliance FCC 47 CFR § 20.19. This report demonstrates compliance for near field emissions only and not for the T-coil performance compliance.

**2. Description of the Device Under Test**

**Table 1: Information for the Device Under Test**

<b>Serial number</b>	1B172464			
<b>Mode(s) of Operation</b>	800 AMPS	800 CDMA	1900 CDMA	Bluetooth
<b>Modulation Mode(s)</b>	FM	QPSK	QPSK	GFSK
<b>Maximum Output Power Setting</b>	27.80 dBm	25.00 dBm	25.00 dBm	4.0 dBm
<b>Duty Cycle</b>	1:1	1:1	1:1	1:1
<b>Transmitting Frequency Rang(s)</b>	824-849MHz	824-849MHz	1851-1909MHz	2400.0-2483.5 MHz
<b>Production Unit or Identical Prototype (47 CFR §2.908)</b>	Identical Prototype			
<b>Device Category</b>	Portable			

Note: No Bluetooth profile exists in this phone that will allow a Bluetooth link while in a cellular call that passes audio to the earpiece. If the user had Bluetooth enabled and a link established, they could not be listening to the phone through the earpiece.

**3. Test Equipment Used**

The Motorola Mobile Devices Business Product Safety & Compliance Laboratory utilizes a Dosimetric Assessment System (Dasy4™ v4.7) manufactured by Schmid & Partner Engineering AG (SPEAG™), of Zurich Switzerland. All the HAC measurements are taken within a shielded enclosure. The measurement uncertainty budget is given in Appendix 5. The list of calibrated equipment used for the measurements is shown below.

**Table 2: Dosimetric System Equipment**

Description	Serial Number	Cal Due Date
E-Field Probe ER3DV6R	SN 2247	Apr/28/2007
H-Field Probe H3DV6	SN 6074	Apr/27/2007
DAE3	SN 387	Mar/23/2007
DAE3	SN 639	Nov/15/2006
835 MHz Dipole CD835V3	SN 1051	May/05/2007
1880 MHz Dipole CD1880V3	SN 1043	Nov/04/2006

**Table 3: Additional Test Equipment**

Description	Serial Number	Cal Due Date
Power Supply 6632B	US37360829	3/7/2007
Signal Generator E4438C	MY45090104	8/8/2007
Amplifier ZHL-42-SMA	N120299-24	
3db Attenuator 8491A	50577	6/30/2007
Directional Coupler 778D	18610	6/30/2007
Power Meter E4417A	MY45100501	6/26/2007
Power Sensor #1 – E9323A	MY44420845	7/25/07
Power Sensor #2 - E9323A	MY44420850	7/25/07
10db attenuator 8491A	MY39263039	5/24/07
Spectrum Analyzer E4403B	US39440471	11/23/2006

**4. Validation**

Validations of the DASY4 v4.7 test system were performed using the measurement equipment listed in Section 3.1. All validations occur in free space using the DASY4 test arch. Note that the 10 mm probe to dipole separation is measured from the top edge of the dipole to the calibration reference point of the probe. SPEAG uses the center point of the probe sensor(s) as the reference point when establishing targets for their dipoles. Therefore, because SPEAG’s dipoles and targets are used, it is appropriate to measure the 10 mm separation distance to the center of the sensors as they do. This reference point was used for validation only. Validations were performed at 835 MHz and/or 1880 MHz. These frequencies are within each operating band and are within 2MHz of the mid-band frequency of the test device. The obtained results from the validations are displayed in the table below. The field contour plots are included in Appendix 3.

Validations were performed to verify that measured E-field and H-field values are within +/- 25% from the target reference values provided by the manufacturer (Ref: Appendix 8). Per Section 4.3.2.1 of the C63.19 standard, “Values within +/-25% are acceptable, of which 12% is deviation and 13% is measurement uncertainty.” Therefore, the E- and H-Field dipole verification results, shown in Table 4, are in accordance with the acceptable parameters defined by the standard.

**Table 4: Dipole Measurement Summary**

Dipole	F (MHz)	Protocol	Input Power (mW)	E-Field Results (V/m)	Target for Dipole (V/m)	% Deviation
SN 1051	835	CW	100	166.6	166.9	-0.2
SN 1043	1880	CW	100	130.8	133.5	-2.0

Dipole	F (MHz)	Protocol	Input Power (mW)	H-Field Results (A/m)	Target for Dipole (A/m)	% Deviation
SN 1051	835	CW	100	0.472	0.448	5.3
SN 1043	1880	CW	100	0.454	0.447	1.6

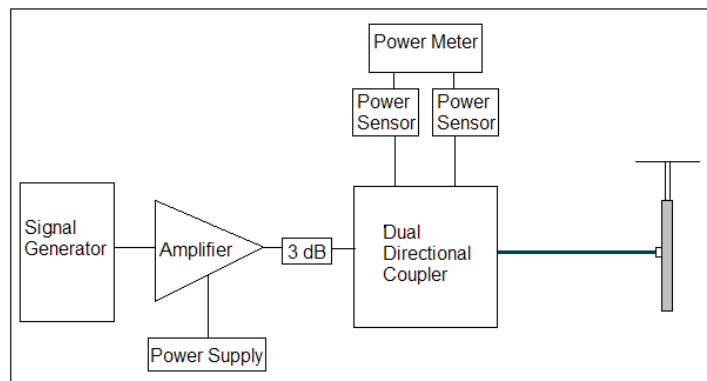

**Figure 1: Setup for Validation**

**5. Probe Modulation Factor**

After every probe calibration, the response of the probe to each applicable modulated signal (CDMA, GSM, etc) must be assessed at both 835 MHz and 1880 MHz. The response of the probe system to a CW field at the frequency(s) of interest is compared to its response to a modulated signal with equal peak amplitude. For each PMF assessment, a Signal Generator was used to replace the original CW signal with the desired modulated signal. The PMF results applicable to this test document are shown in Tables 5.

RF Field Probe Modulation Response was measured with the field probe and associated measurement equipment. The PMF was measured using a signal generator as follows:

1. Illuminate a dipole with a CW signal at the intended measured frequency.
2. Fix the probe at a set location relative to the dipole; typically located at the field reference point.
3. Record the reading of the probe measurement system of the CW signal.
4. Substitute a modulated signal of the same amplitude, using the same modulation as that used by the intended WD for the CW signal.
5. Record the reading of the probe measurement system of the modulated signal.
6. The ratio of the CW to modulated signal reading is the probe modulation factor.

Using dual directional coupler, the forward power and reverse power are measured and adjusted in order for the Input Power to equal 100 mW when connected to the dipole.

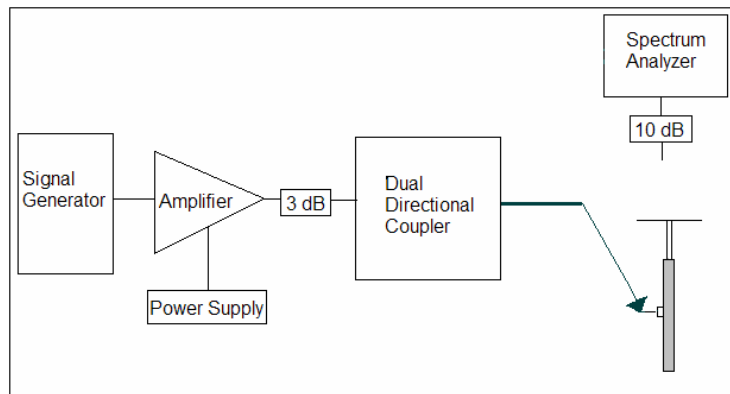

**Figure 2a: Setup to Dipole**

A spectrum analyzer was then used to set the peak amplitude of the modulated signal equal to the amplitude of the CW signal. The procedure, used to ensure that the amplitude is the same, is shown in Appendix 2. The 0 span spectrum plots are also provided in Appendix 2.

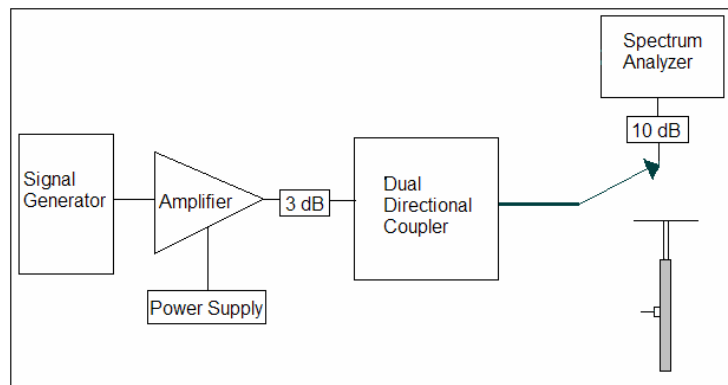

**Figure 2b: Setup for Desired Peak Power using Spectrum Analyzer**

**Table 5: PMF Measurement Summary**

f (MHz)	Protocol	Peak Power (mW)	E-Field Probe SN 2247		H-Field Probe SN 6074	
			E-Field (V/m)	E-Field Modulation Factor	H-Field (A/m)	H-Field Modulation Factor
835	CW	100	105.4		0.4938	
	CDMA full rate	100	99.33	1.06	0.4705	1.05
	CDMA 1/8 rate	100	37.18	2.83	0.1826	2.70
	80% AM	100	66.61	1.58	0.3215	1.54
1880	CW	100	154.6		0.4841	
	CDMA full rate	100	148.5	1.04	0.4814	1.01
	CDMA 1/8 rate	100	53.87	2.87	0.2185	2.22
	80% AM	100	98.02	1.58	0.3348	1.45

Note: PMF measurements were verified at WD’s power as an input to the dipole (using signal generator).

**6. Test Results**

Per the “Preliminary Guidance for Reviewing Applications for Certifications of 3G Devices” released on May 9, 2006, both RC1 and RC3 CDMA modes are considered (steps 3 & 4 of section 4.4.5.2 of 3GPP2 C.5.011 / TIA -98-E). The conducted power measurements show that the portable cellular phone FCC ID IHDT56GS1 has the same output conducted power for both CDMA modes.

Conducted Output Power (dBm):

	Channel	RC1		RC3	
		SO2	SO55	SO2	SO55
800CDMA	1013	25.13	25.10	25.02	25.07
	384	25.13	25.20	25.11	25.14
	777	25.00	24.98	24.94	24.93
1900CDMA	25	24.82	24.89	24.90	24.92
	600	24.85	24.94	25.00	25.04
	1175	24.90	24.94	24.91	24.95

The Cellular Phone model covered by this report has the following battery options:

- Battery #1 – SNN5771A is 850 mAH Battery
- Battery #2 – SNN5782A is 1100 mAH Battery

The phone was tested in all normal configurations for the ear use. When applicable, configurations are tested with the antenna in its fully extended position. These test configurations are tested at the high, middle and low frequency channels of each applicable operating mode; for example, GSM, CDMA, and TDMA.

The signal was setup by creating and maintaining an over the air connection between the DUT and an Agilent 8960 Wireless Communications Test Set. The CDMA radio is available on CDMA 2000(1X) and IS-95. The test equipment was configured to use “all up bits” for RC1 / SO2 on J-STD-008 for CDMA 1900 and TSB-84 for CDMA 800 MHz. The wideband and 0 span spectrum analyzer plots are shown in Appendix 1.

The DASY4 v4.7 measurement system specified in section 3.1 was utilized within the intended operations as set by the SPEAG™ setup. The default settings for the grid spacing of the scan were set to 5mm as shown in the Field plots included in Appendix 3 and 4. The 5cm x 5cm area measurement grid is centered on the acoustic output of the device. The Test Arch provided by SPEAG is used to position the DUT. The WD reference plane is parallel to the device and contains the highest point on its contour in the area of the phone that normally rests against the user's ear. The measurement plane contains the nearest point on the probe sensor(s) relative to the WD. The pictures of the setup are included in Appendix 6.

The device is positioned such that the WD reference plane is located 10mm from, and parallel to, the measurement plane. This is in accordance with section 4.4 of the standard, which states that “The WD reference plane is a plane parallel with the front "face" of the WD and containing the highest point on its contour in the area of the phone that normally rests against the user's ear.”

The following figure shows the position of the measurement grid with respect to the device under test.

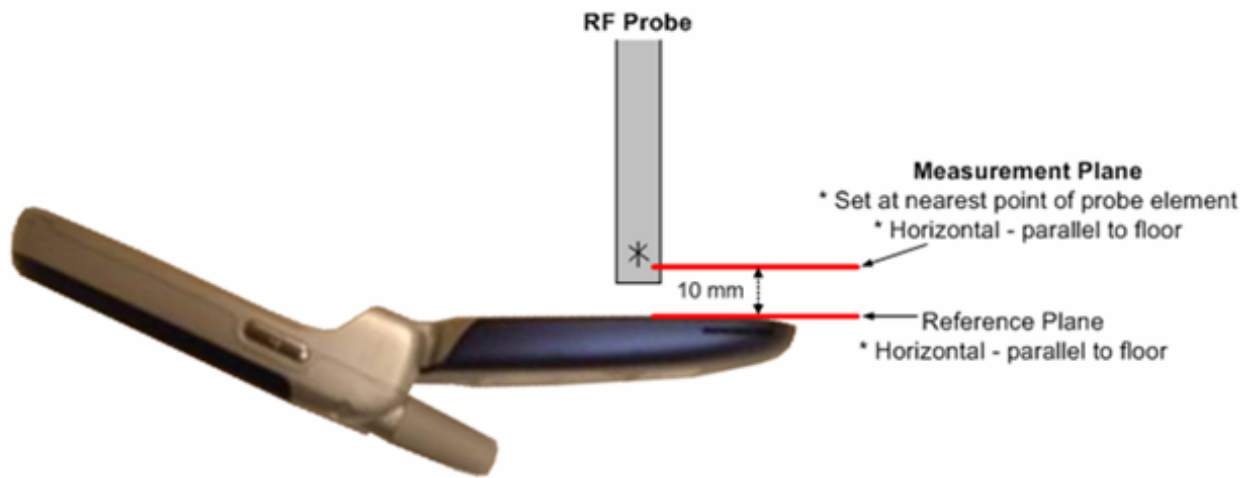

**Figure 4: Clarification of Figure A-2 from the Standard**

The HAC Rating results for E-Field and H-field are shown in Tables 6 and 9. Also shown are the measured conducted output powers, the measured drifts, excluded areas, and the peak fields. PMF measurements are taken from Section 5. The worst-case test conditions are indicated with **bold numbers** in the tables and are detailed in Appendix 4: HAC distribution plots for E-Field and H-Field.

Drift was measured using the typical DASY4 v4.7 measurement routines. The field is measured at the reference location (center of the ear piece) at the beginning of the test. Then after completion of the E or H field measurement, the probe returns to the same reference location and takes another measurement. The drift is the delta between these two values and is included in the test report scans.

Per SPEAG’s recommendation, the phone plots in Appendix 4 use the standard GSM transmitter ratio 1:8 and standard CDMA transmitter ratio 1:1 as “Duty Cycle.” Per SPEAG’s recommendation, in order to account for probe modulation response, PMF is applied during the SEMCAD (post-processing) portion. PMF also appears in the phone plots in Appendix 4.

CDMA 800 Emissions Limits	
Rating	E-Field
M3	199.5 – 354.8 V/m
M4	< 199.5 V/m

CDMA 1900 Emissions Limits	
Rating	E-Field
M3	63.1 – 112.2 V/m
M4	< 63.1 V/m

**Table 6: HAC E-Field measurement results for the portable cellular telephone at highest possible output power (Full Rate).**

Frequency Band (MHz)	Antenna position	Channel Setting	Measured PMF	Drift (dB)	Excluded Cells	Peak Field (V/m)	Rating
CDMA 800MHz	Extended	1013	1.06	0.03	6,9	67.5	M4
		384		0.04	6,9	70.1	M4
		777		-0.07	3,6	64.6	M4
		w/ Bat 2		0.07	6,9	69.3	M4
CDMA 1900MHz	Extended	25	1.04	0.13	2,3	47.0	M4
		600		-0.06	2,3	46.6	M4
		1175		0.14	2,3	44.1	M4
		w/ Bat 2		-0.06	2,3	47.5	M4

**Table 7: HAC E-Field measurement results for the portable cellular telephone at highest possible output power (1/8 Rate).**

Frequency Band (MHz)	Antenna position	Channel Setting	Measured PMF	Drift (dB)	Excluded Cells	Peak Field (V/m)	Rating
CDMA 800MHz	Extended	1013	2.83	<b>-0.10</b>	<b>2,3</b>	<b>71.1</b>	<b>M4</b>
		384		-0.02	8,9	66.5	M4
		777		-0.12	2,3	63.8	M4
		w/ Bat 2		0.01	8,9	66.1	M4
CDMA 1900MHz	Extended	25	2.87	<b>-0.11</b>	<b>2,3</b>	<b>51.5</b>	<b>M4</b>
		600		0.03	2,3	45.9	M4
		1175		0.04	2,3	47.6	M4
		w/ Bat 2		-0.11	2,3	50.0	M4

CDMA 800 Emissions Limits	
Rating	H-Field
M3	0.60 – 1.07 A/m
M4	< 0.60 A/m

CDMA 1900 Emissions Limits	
Rating	H-Field
M3	0.19 – 0.34 A/m
M4	< 0.19 A/m

**Table 8: HAC H-Field measurement results for the portable cellular telephone at highest possible output power (Full Rate).**

Frequency Band (MHz)	Antenna position	Channel Setting	Measured PMF	Drift (dB)	Excluded Cells	Peak Field (A/m)	Rating
CDMA 800MHz	Extended	1013	1.05	0.01	1,4,7	0.103	M4
		384		-0.01	1,4,7	0.119	M4
		777		-0.05	1,4,7	0.110	M4
		w/ Bat 2		<b>0.03</b>	<b>1,4,7</b>	<b>0.121</b>	<b>M4</b>
CDMA 1900MHz	Extended	25	1.01	<b>-0.09</b>	<b>7,8,9</b>	<b>0.110</b>	<b>M4</b>
		600		-0.21	6,8,9	0.108	M4
		1175		-0.24	7,8,9	0.105	M4
		w/ Bat 2		-0.09	7,8,9	0.110	M4

**Table 9: HAC H-Field measurement results for the portable cellular telephone at highest possible output power (1/8 Rate).**

Frequency Band (MHz)	Antenna position	Channel Setting	Measured PMF	Drift (dB)	Excluded Cells	Peak Field (A/m)	Rating
CDMA 800MHz	Extended	1013	2.70	0.05	1,4,7	0.096	M4
		384		0.09	1,4,7	0.111	M4
		777		-0.02	1,4,7	0.103	M4
		w/ Bat 2		0.09	1,4,7	0.111	M4
CDMA 1900MHz	Extended	25	2.22	0.05	7,8,9	0.092	M4
		600		0.13	6,8,9	0.087	M4
		1175		0.23	6,8,9	0.089	M4
		w/ Bat 2		-0.04	6,8,9	0.090	M4

**Appendix 1**

**Details of the WD's signal**

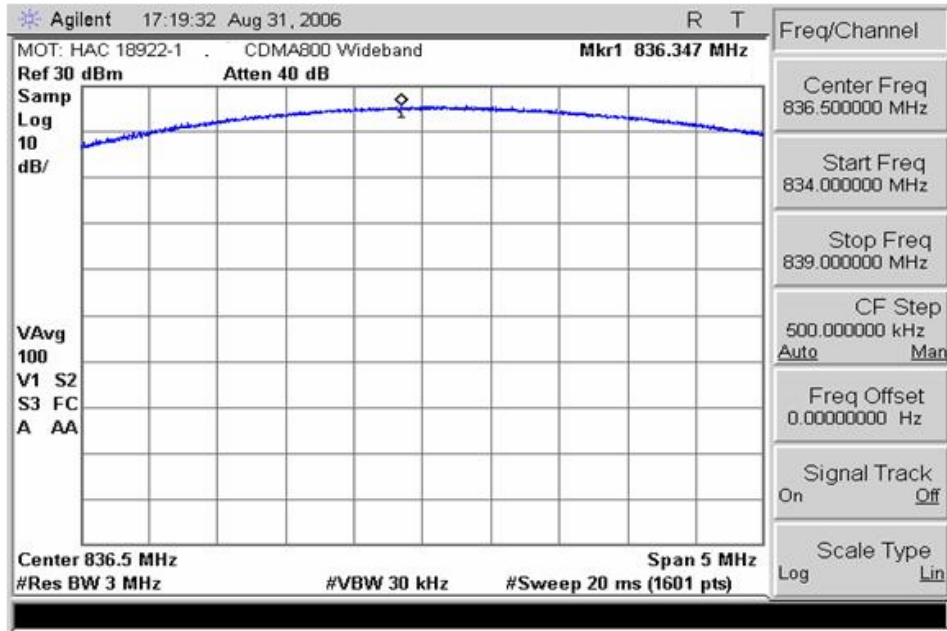

836.52 MHz (wideband)

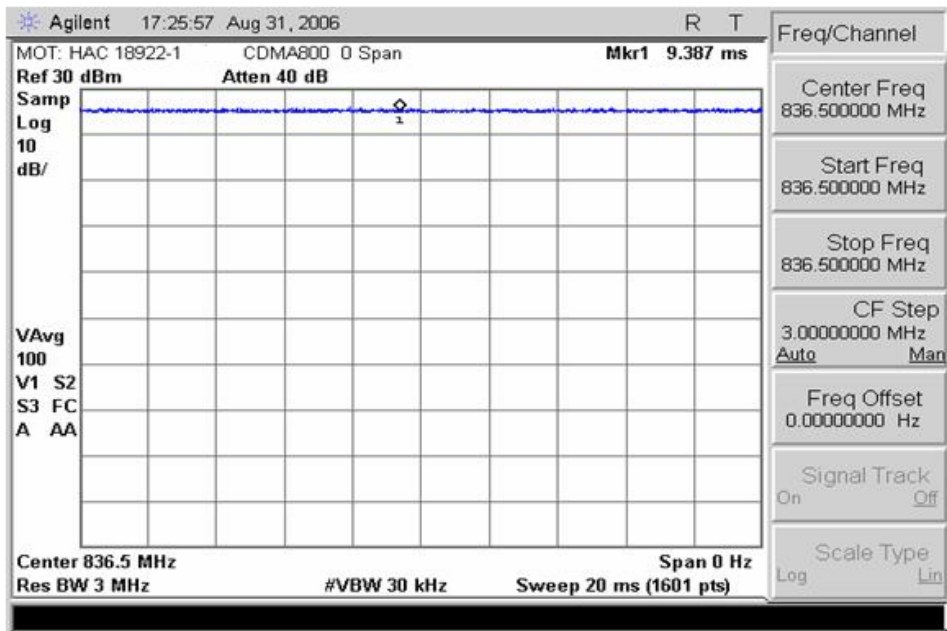

836.52 MHz (0 span)

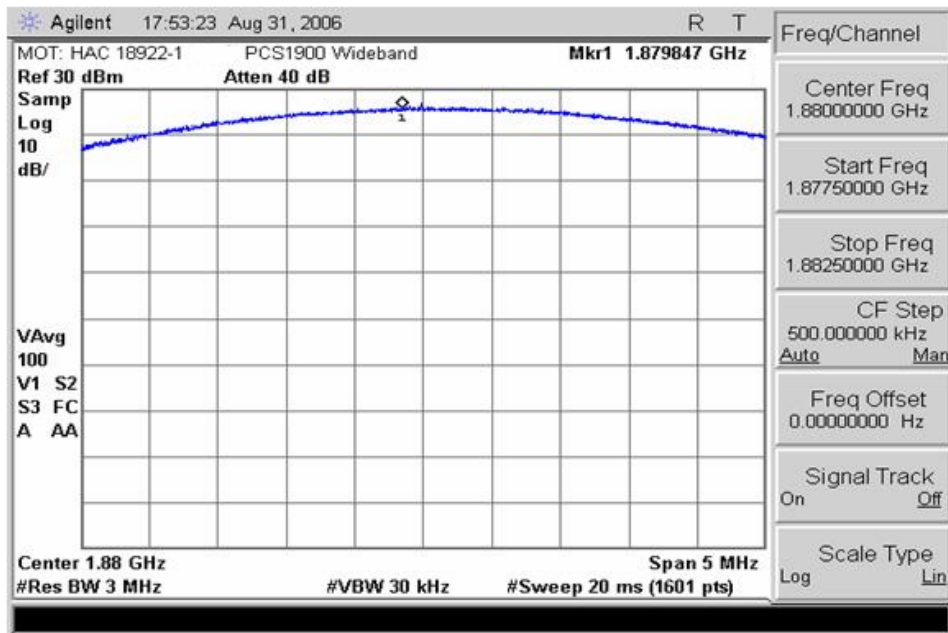

1882.5 MHz (wideband)

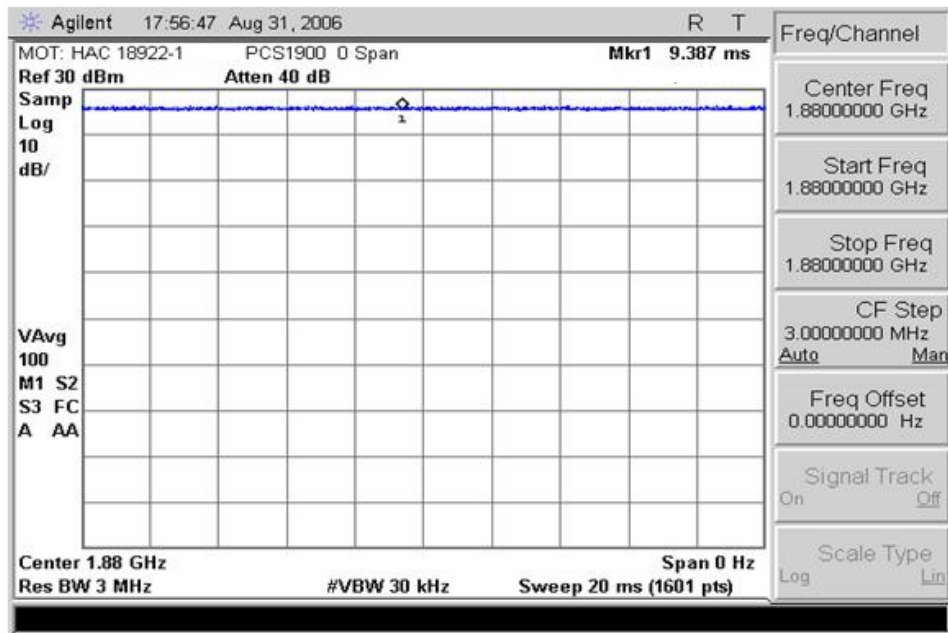

1882.5 MHz (0 span)

**Appendix 2**

**Details justifying the conversion to peak**

**A2.1 Procedure for PMF measurements**

1. Setup the HAC validation rack as you would for a normal CW HAC validation with forward power = 100mW
2. Setup the dipole and phantom as you would for a normal CW HAC validation.
3. Open the "HAC Probe Mod Factor" template and verify the following parameters:  
 Medium = "Air";  
 Communication System = "HAC – Dipole";  
 Ensure the proper probe & DAE are installed and laser aligned
4. **MEASURE CW:** Using the original CW signal, run the jobs in the "CW Measurement" procedure.
5. Do **not** turn off the signal generator power
6. **Setting the CW Reference Level on the Spectrum Analyzer:** To set the Reference level on the Spectrum Analyzer, remove the Validation Rack's Main Cable from the dipole and connect to the Spectrum Analyzer INPUT using a 10 dB attenuator and an adapter.
7. Set-Up the Spectrum Analyzer for the following Settings:  
 Frequency: Freq. being tested (EX: 835/1880)  
 Span: Zero Span  
 Res BW: 3 MHz  
 Video BW: 30 KHz \*\*  
 Sweep Time: same as the table in step 9.2  
 Scale: 1dB  
 Detector: PEAK / Manual
8. Adjust REF level until the CW signal is aligned with the Center Line (approx. 15dB). NOTE: After this point, the Reference Line must remain fixed. Do not change it.
9. **MEASURE THE MODULATED SIGNAL(S):**
  - 9.1. Change the signal generator to the desired modulation.
  - 9.2. Set the Spectrum Analyzer Sweep Time to the appropriate setting.
 

Modulation	Sweep Time
CW	20 msec
GSM	5 msec
CDMA	5 msec
TDMA	20 msec
80%AM	20 msec
  - 9.3. With the Main cable still connected to the Spectrum Analyzer, adjust the amplitude of the power on the signal generator so that the PEAK of the modulated signal is at the CW Reference Line:
    - 9.3.1 On the Spectrum Analyzer, press the [View Trace] button and then select (Max Hold), this will show only the Peak output.
    - 9.3.2 Press (Clear Write) and then (Max Hold) each time an amplitude adjustment is made.
  - 9.4. Allow the Max Hold line to stabilize. Then check that the highest peak of the Max Hold line corresponds with the CW Reference Line (without going over). If not correct, repeat section 6.
  - 9.5. Remove the validation main cable from the spectrum analyzer and re-connect it to the Dipole.
10. Repeat 9 until all remaining modulation(S) have been completed.

\*\* The use of 30 kHz VBW is validated. The power measurements are compared and verified using spectrum analyzer (VBW = 30 Hz) and average power meter.

**A2.2 0 Span Spectrum Plots for PMF measurements**

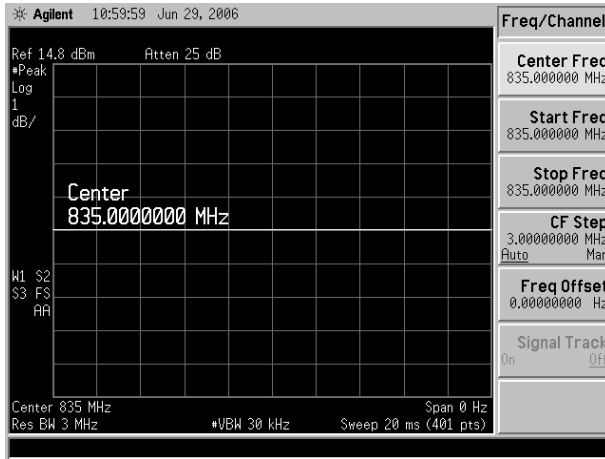

CW 835 MHz

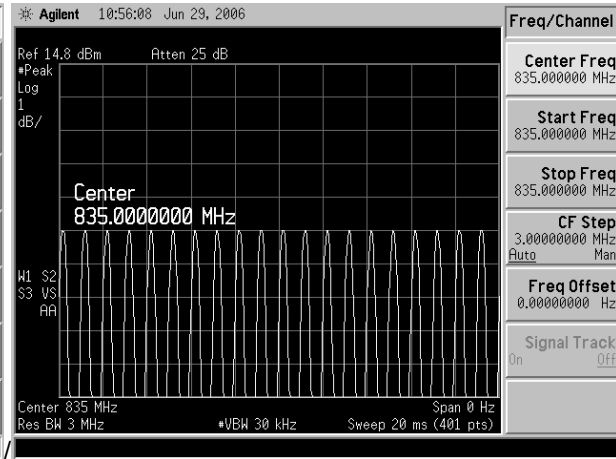

80% AM 835 MHz

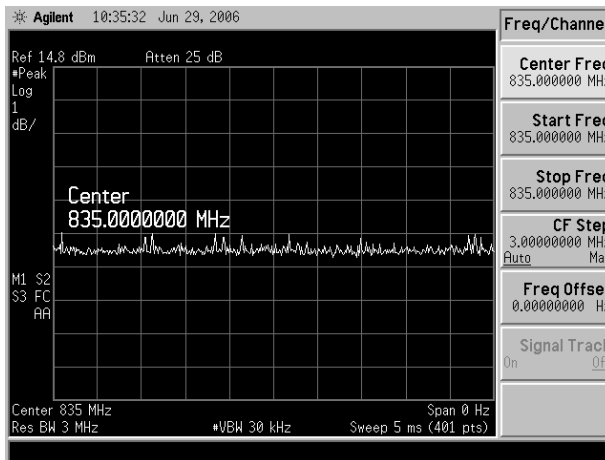

CDMA 835 MHz (full rate)

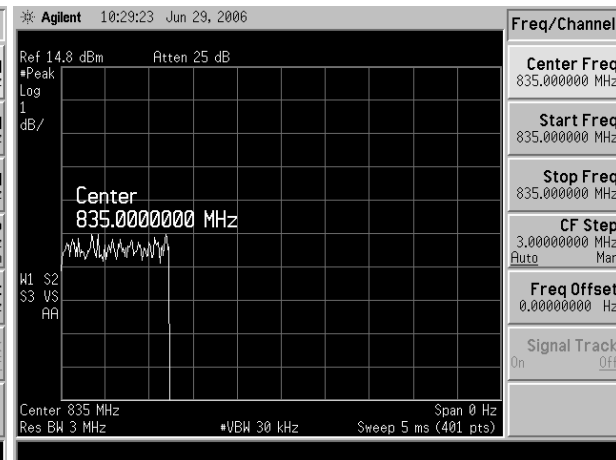

CDMA 835 MHz (1/8 rate)

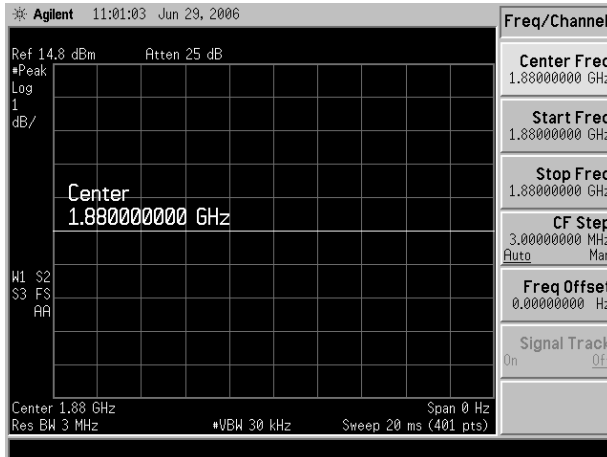

CW 1880 MHz

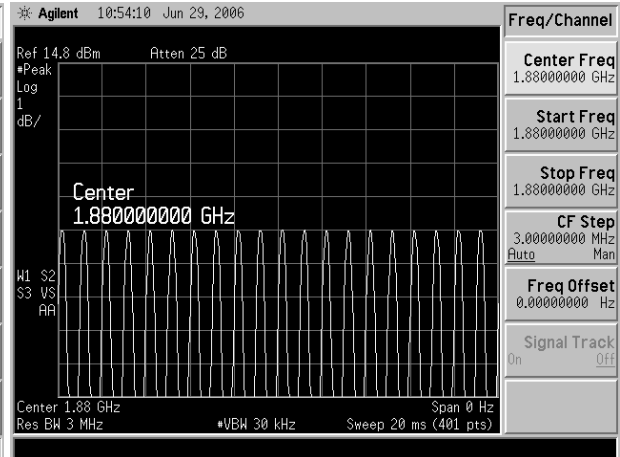

80% AM 1880 MHz

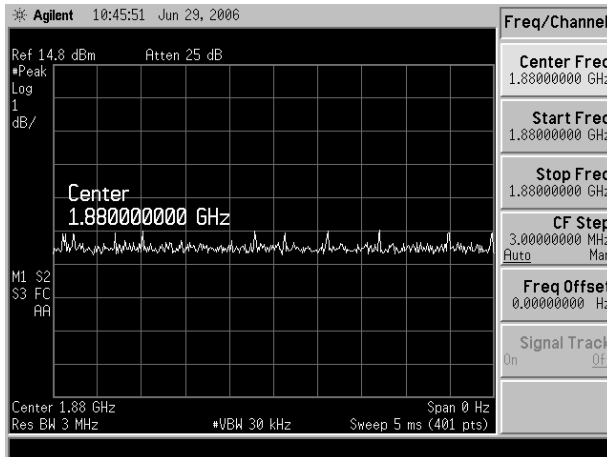

CDMA 1880 MHz (full rate)

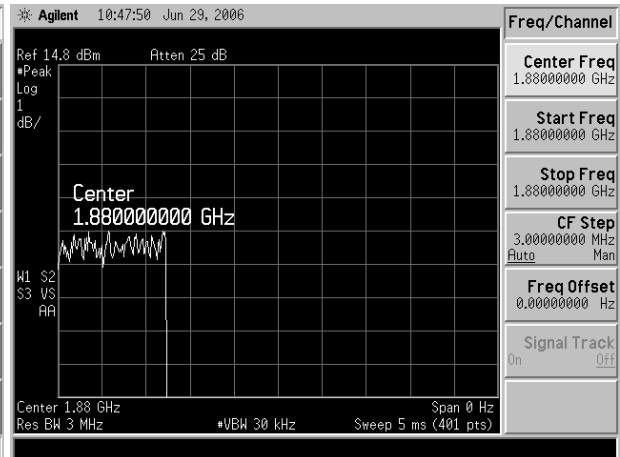

CDMA 1880 MHz (1/8 rate)

**Appendix 3**

**HAC distribution plots for Validation**

### Test Laboratory: Motorola

**DUT: HAC-Dipole 835 MHz; Type: D835V3;** Procedure Notes: 835 MHz HAC Validation / Dipole Sn# 1051; Input Power = 100 mW; Communication System: CW - HAC; Frequency: 835 MHz; Duty Cycle: 1:1; Medium: Air; Medium parameters used:  $\sigma = 0$  mho/m,  $\epsilon_r = 1$ ;  $\rho = 0$  kg/m<sup>3</sup>; DASY4 Configuration:

- Probe: ER3DV6R - SN2247; ConvF(1, 1, 1); Calibrated: 4/28/2006
- Sensor-Surface: 0mm (Fix Surface)Sensor-Surface: (Fix Surface)
- Electronics: DAE3 Sn387; Calibrated: 3/23/2006
- Phantom: HAC Test Arch with Coil; Type: SD HAC P01 BA; Serial: 1036;
- Measurement SW: DASY4, V4.7 Build 44; Postprocessing SW: SEMCAD, V1.8 Build 171

**E Scan - ER probe center 10mm above CD835 Dipole/Hearing Aid Compatibility Test (41x361x1):** Measurement grid: dx=5mm, dy=5mm; Probe Modulation Factor = 1.00; Reference Value = 109.3 V/m; Power Drift = 0.012 dB; Maximum value of Total (interpolated) = 175.8 V/m;

Average value of Total (interpolated) =  $( 157.4 + 175.8 ) / 2 = 166.6$  V/m

Peak E-field in V/m

Grid 1	Grid 2	Grid 3
<b>152.9</b>	<b>157.4</b>	<b>155.8</b>
Grid 4	Grid 5	Grid 6
<b>87.9</b>	<b>90.7</b>	<b>89.0</b>
Grid 7	Grid 8	Grid 9
<b>168.2</b>	<b>175.8</b>	<b>172.7</b>

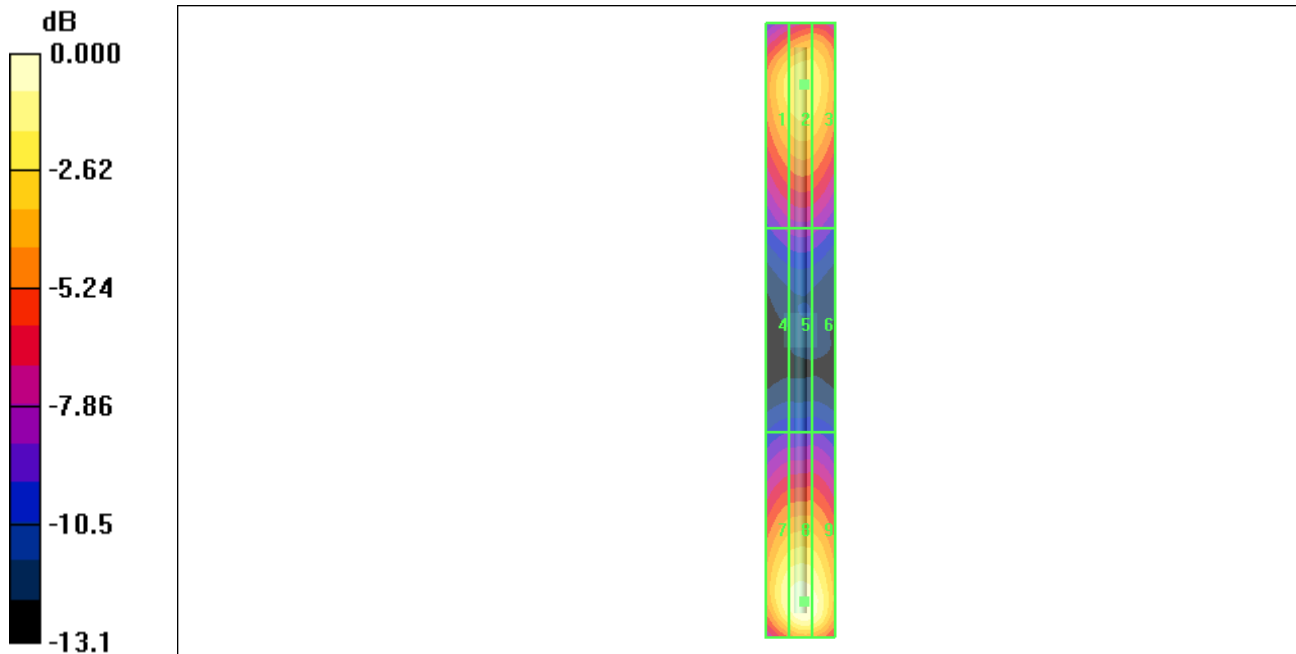

0 dB = 175.8V/m

**Test Laboratory: Motorola**

**DUT: HAC Dipole 1880 MHz; Type: CD1880V3;** Procedure Notes: 1880 MHz HAC Validation / Dipole Sn# 1043; Input Power = 100 mW; Communication System: CW - HAC; Frequency: 1880 MHz; Duty Cycle: 1:1; Medium: Air; Medium parameters used:  $\sigma = 0$  mho/m,  $\epsilon_r = 1$ ;  $\rho = 0$  kg/m<sup>3</sup> ; DASY4 Configuration:

- Probe: ER3DV6R - SN2247; ConvF(1, 1, 1); Calibrated: 4/28/2006
- Sensor-Surface: 0mm (Fix Surface)Sensor-Surface: (Fix Surface)
- Electronics: DAE3 Sn387; Calibrated: 3/23/2006
- Phantom: HAC Test Arch with Coil; Type: SD HAC P01 BA; Serial: 1036;
- Measurement SW: DASY4, V4.7 Build 44; Postprocessing SW: SEMCAD, V1.8 Build 171

**E Scan - ER probe center 10mm above CD1880 Dipole/Hearing Aid Compatibility Test (41x181x1):** Measurement grid: dx=5mm, dy=5mm; Probe Modulation Factor = 1.00; Reference Value = 149.6 V/m; Power Drift = -0.001 dB

Maximum value of Total (interpolated) = 133.2 V/m

Average value of Total (interpolated) = ( 128.4 + 133.2 ) / 2 = 130.8 V/m

Peak E-field in V/m

Grid 1	Grid 2	Grid 3
<b>123.9</b>	<b>128.4</b>	<b>126.5</b>
Grid 4	Grid 5	Grid 6
<b>88.0</b>	<b>90.3</b>	<b>87.5</b>
Grid 7	Grid 8	Grid 9
<b>125.0</b>	<b>133.2</b>	<b>131.8</b>

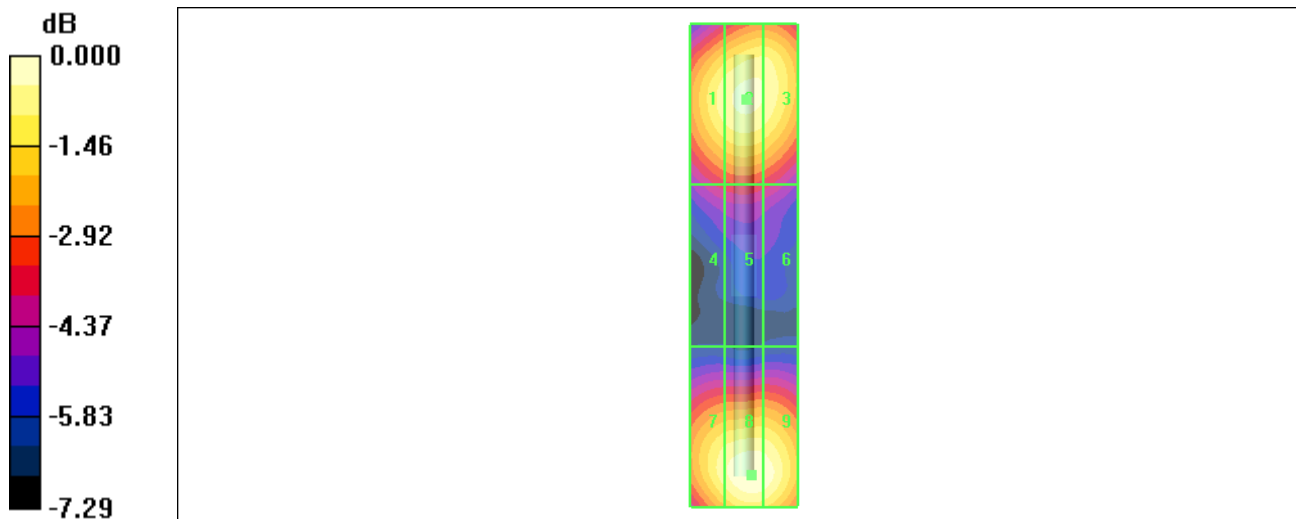

0 dB = 133.2V/m

**Test Laboratory: Motorola**

**DUT: HAC-Dipole 835 MHz; Type: D835V3;** Procedure Notes: 835 MHz HAC Validation / Dipole Sn# 1051; Input Power = 100 mW; Communication System: CW - HAC; Frequency: 835 MHz; Duty Cycle: 1:1; Medium: Air; Medium parameters used:  $\sigma = 0$  mho/m,  $\epsilon_r = 1$ ;  $\rho = 0$  kg/m<sup>3</sup> ; DASY4 Configuration:

- Probe: H3DV6 - SN6074; ; Calibrated: 4/27/2006
- Sensor-Surface: 0mm (Fix Surface)
- Electronics: DAE4 Sn639; Calibrated: 11/15/2005
- Phantom: HAC Test Arch with Coil; Type: SD HAC P01 BA; Serial: 1036;
- Measurement SW: DASY4, V4.7 Build 44; Postprocessing SW: SEMCAD, V1.8 Build 171

**H Scan - H3DV6 probe center 10mm above CD835 Dipole/Hearing Aid Compatibility Test (41x361x1):** Measurement grid: dx=5mm, dy=5mm; Probe Modulation Factor = 1.00; Reference Value = 0.501 A/m; Power Drift = -0.026 dB  
Maximum value of Total (interpolated) = 0.472 A/m

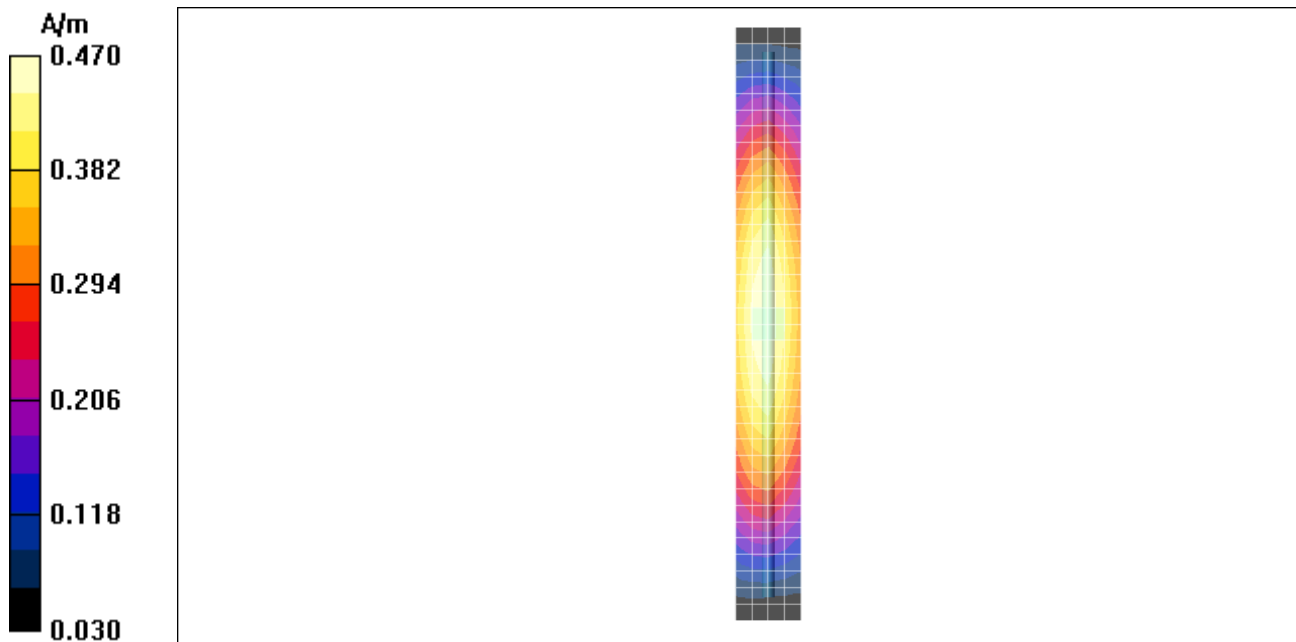

**Test Laboratory: Motorola**

**DUT: HAC Dipole 1880 MHz; Type: CD1880V3;** Procedure Notes: 1880 MHz HAC Validation / Dipole Sn# 1043; Input Power = 100 mW; Communication System: CW - HAC; Frequency: 1880 MHz; Duty Cycle: 1:1; Medium: Air; Medium parameters used:  $\sigma = 0$  mho/m,  $\epsilon_r = 1$ ;  $\rho = 0$  kg/m<sup>3</sup> ; DASY4 Configuration:

- Probe: H3DV6 - SN6074; ; Calibrated: 4/27/2006
- Sensor-Surface: 0mm (Fix Surface)
- Electronics: DAE4 Sn639; Calibrated: 11/15/2005
- Phantom: HAC Test Arch with Coil; Type: SD HAC P01 BA; Serial: 1036;
- Measurement SW: DASY4, V4.7 Build 44; Postprocessing SW: SEMCAD, V1.8 Build 171

**H Scan - H3DV6 probe center 10mm above CD1880 Dipole/Hearing Aid Compatibility Test (41x181x1):** Measurement grid: dx=5mm, dy=5mm; Probe Modulation Factor = 1.00; Reference Value = 0.482 A/m; Power Drift = -0.028 dB  
Maximum value of Total (interpolated) = 0.454 A/m

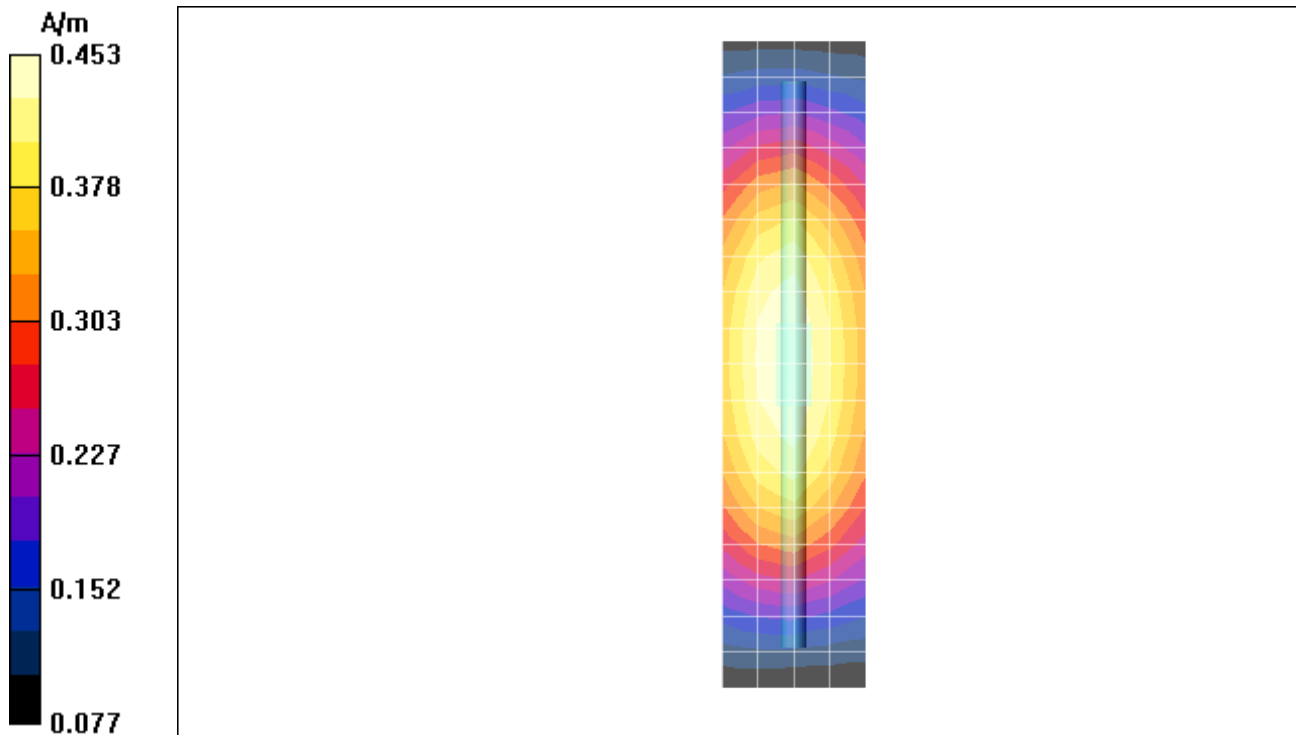

**Appendix 4**

**HAC distribution plots for E-Field and H-Field**

# Test Laboratory: Motorola

**Serial: 1B172464;** Procedure Notes: Pwr Step: Always UP; Antenna Position: EXT; Battery Model #: SNN5771A; Vocoder Rate: 1/8 Rate; Communication System: CDMA 835, 1/8 Vocoder (HAC); Frequency: 824.7 MHz; Communication System Channel Number: 1013; Duty Cycle: 1:8; Medium: Air; Medium parameters used:  $\sigma = 0$  mho/m,  $\epsilon_r = 1$ ;  $\rho = 0$  kg/m<sup>3</sup>; DASY4 Configuration:

- Probe: ER3DV6R - SN2247; ConvF(1, 1, 1); Calibrated: 4/28/2006
- Sensor-Surface: (Fix Surface)
- Electronics: DAE3 Sn387; Calibrated: 3/23/2006
- Phantom: HAC Test Arch with Coil; Type: SD HAC P01 BA; Serial: 1036;
- Measurement SW: DASY4, V4.7 Build 44; Postprocessing SW: SEMCAD, V1.8 Build 171

## E Scan - ER sensor tip 10mm above WD Ref/Hearing Aid Compatibility Test

**(101x101x1):** Measurement grid: dx=5mm, dy=5mm;  
 Maximum value of peak Total field = 71.1 V/m; Probe Modulation Factor = 2.83;  
 Reference Value = 24.1 V/m; Power Drift = -0.097 dB

**Hearing Aid Near-Field Category: M4 (AWF 0 dB)**

Peak E-field in V/m

Grid 1	Grid 2	Grid 3
<b>57.2</b>	<b>62.0</b>	<b>58.4</b>
Grid 4	Grid 5	Grid 6
<b>58.8</b>	<b>71.1</b>	<b>61.7</b>
Grid 7	Grid 8	Grid 9
<b>56.2</b>	<b>61.1</b>	<b>58.6</b>

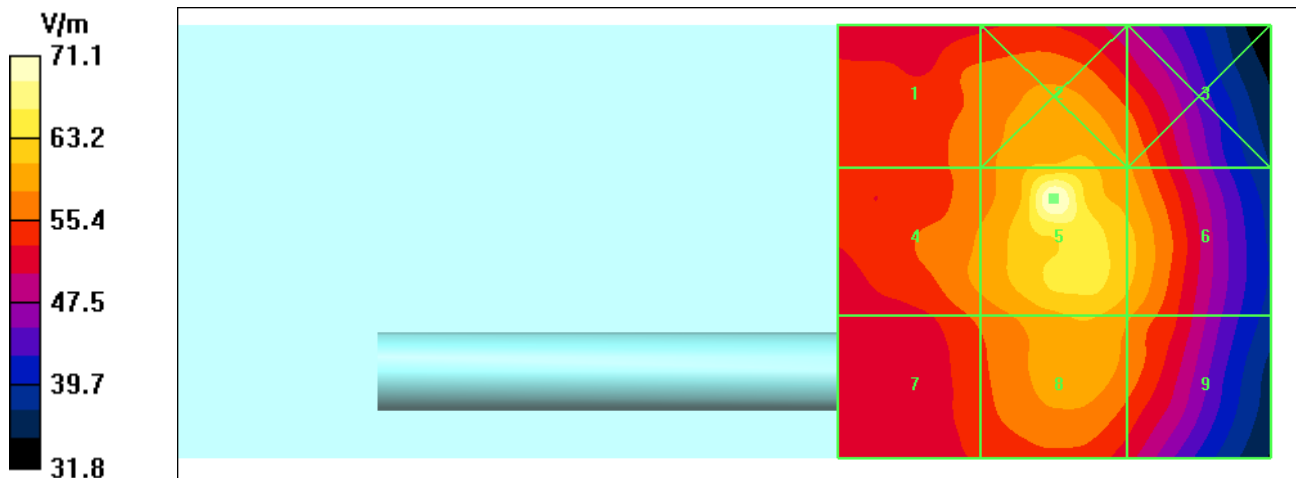

# Test Laboratory: Motorola

**Serial: 1B172464;** Procedure Notes: Pwr Step: Always UP; Antenna Position: EXT; Battery Model #: SNN5771A; Vocoder Rate: 1/8 Rate; Communication System: CDMA 1900, 8th Vocoder; Frequency: 1851.25 MHz; Communication System Channel Number: 25; Duty Cycle: 1:8; Medium: Air; Medium parameters used:  $\sigma = 0$  mho/m,  $\epsilon_r = 1$ ;  $\rho = 0$  kg/m<sup>3</sup>; DASY4 Configuration:

- Probe: ER3DV6R - SN2247; ConvF(1, 1, 1); Calibrated: 4/28/2006
- Sensor-Surface: (Fix Surface)
- Electronics: DAE3 Sn387; Calibrated: 3/23/2006
- Phantom: HAC Test Arch with Coil; Type: SD HAC P01 BA; Serial: 1036;
- Measurement SW: DASY4, V4.7 Build 44; Postprocessing SW: SEMCAD, V1.8 Build 171

## E Scan - ER sensor tip 10mm above WD Ref/Hearing Aid Compatibility Test

**(101x101x1):** Measurement grid: dx=5mm, dy=5mm

Maximum value of peak Total field = 51.5 V/m; Probe Modulation Factor = 2.87

Reference Value = 16.2 V/m; Power Drift = -0.112 dB

### Hearing Aid Near-Field Category: M4 (AWF 0 dB)

Peak E-field in V/m

Grid 1	Grid 2	Grid 3
<b>47.8</b>	<b>51.8</b>	<b>50.3</b>
Grid 4	Grid 5	Grid 6
<b>43.0</b>	<b>51.5</b>	<b>50.2</b>
Grid 7	Grid 8	Grid 9
<b>31.0</b>	<b>42.1</b>	<b>42.1</b>

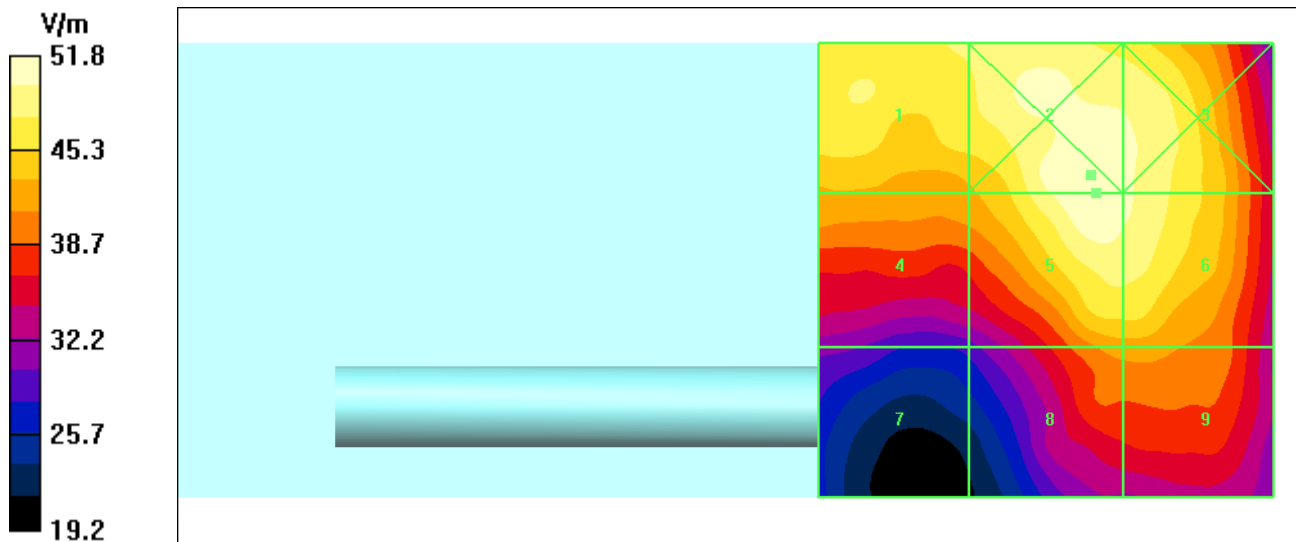

# Test Laboratory: Motorola

**Serial: 1B172464;** Procedure Notes: Pwr Step: ALWAYS UP; Antenna Position: EXTENDED; Battery Model #: SNN5782A; Communication System: CDMA 835; Frequency: 836.52 MHz; Communication System Channel Number: 384; Duty Cycle: 1:1; Medium: Air; Medium parameters used:  $\sigma = 0$  mho/m,  $\epsilon_r = 1$ ;  $\rho = 0$  kg/m<sup>3</sup> ; DASY4 Configuration:

- Probe: H3DV6 - SN6074; ; Calibrated: 4/27/2006
- Sensor-Surface: (Fix Surface)
- Electronics: DAE4 Sn639; Calibrated: 11/15/2005
- Phantom: HAC Test Arch with Coil; Type: SD HAC P01 BA; Serial: 1036;
- Measurement SW: DASY4, V4.7 Build 44; Postprocessing SW: SEMCAD, V1.8 Build 171

## H Scan - H3DV6 sensor tip 10mm above WD Ref/Hearing Aid Compatibility Test

**(101x101x1):** Measurement grid: dx=5mm, dy=5mm

Maximum value of peak Total field = 0.121 A/m; Probe Modulation Factor = 1.05

Reference Value = 0.086 A/m; Power Drift = 0.025 dB

**Hearing Aid Near-Field Category: M4 (AWF 0 dB)**

Peak H-field in A/m

Grid 1	Grid 2	Grid 3
<b>0.165</b>	<b>0.121</b>	<b>0.082</b>
Grid 4	Grid 5	Grid 6
<b>0.155</b>	<b>0.115</b>	<b>0.078</b>
Grid 7	Grid 8	Grid 9
<b>0.147</b>	<b>0.108</b>	<b>0.070</b>

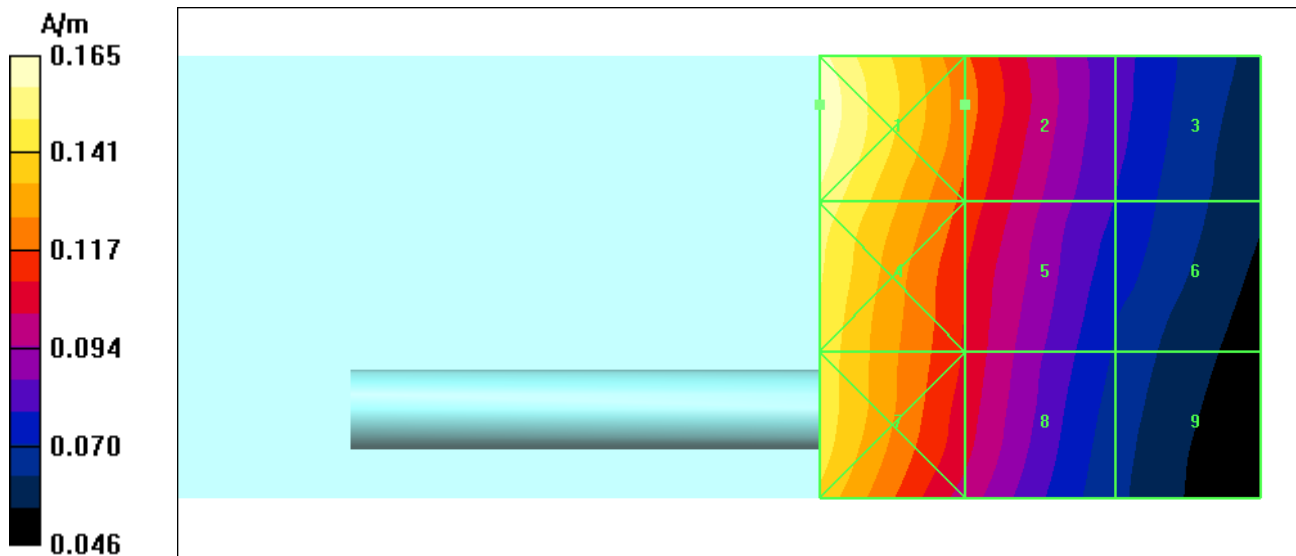

# Test Laboratory: Motorola

**Serial: 1B172464;** Procedure Notes: Pwr Step: always up; Antenna Position: extended; Battery Model #: SNN5771A; Communication System: CDMA 1900; Frequency: 1851.25 MHz; Communication System Channel Number: 25; Duty Cycle: 1:1; Medium: Air; Medium parameters used:  $\sigma = 0$  mho/m,  $\epsilon_r = 1$ ;  $\rho = 0$  kg/m<sup>3</sup> ; DASY4 Configuration:

- Probe: H3DV6 - SN6074; ; Calibrated: 4/27/2006
- Sensor-Surface: (Fix Surface)
- Electronics: DAE4 Sn639; Calibrated: 11/15/2005
- Phantom: HAC Test Arch with Coil; Type: SD HAC P01 BA; Serial: 1036;
- Measurement SW: DASY4, V4.7 Build 44; Postprocessing SW: SEMCAD, V1.8 Build 171

## H Scan - H3DV6 sensor tip 10mm above WD Ref/Hearing Aid Compatibility Test

**(101x101x1):** Measurement grid: dx=5mm, dy=5mm

Maximum value of peak Total field = 0.110 A/m; Probe Modulation Factor = 1.01

Reference Value = 0.098 A/m; Power Drift = -0.085 dB

**Hearing Aid Near-Field Category: M4 (AWF 0 dB)**

Peak H-field in A/m

Grid 1	Grid 2	Grid 3
<b>0.072</b>	<b>0.094</b>	<b>0.095</b>
Grid 4	Grid 5	Grid 6
<b>0.097</b>	<b>0.110</b>	<b>0.110</b>
Grid 7	Grid 8	Grid 9
<b>0.114</b>	<b>0.114</b>	<b>0.112</b>

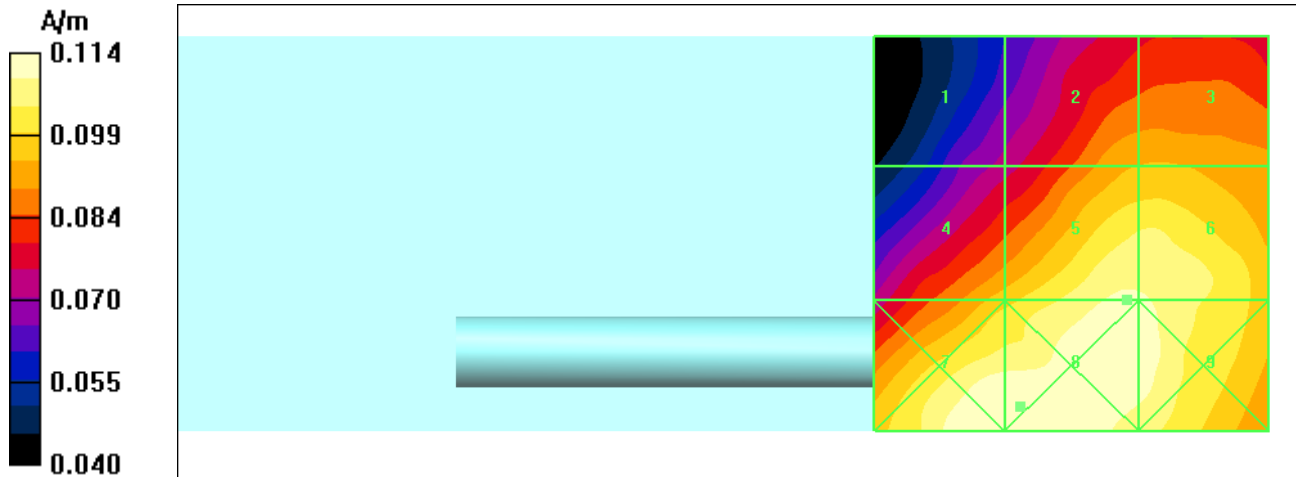

**Appendix 5**

**Measurement Uncertainty Budget**

**A5.1 Motorola Uncertainty Budget for RF HAC Testing**

**TABLE A5.1: Motorola Uncertainty Budget**

UNCERTAINTY DESCRIPTION	Uncertainty Value (+/- %)	Prob. Dist.	Div.	(ci) E	(ci) H	Std. Unc. E	Std. Unc. H
<b>MEASUREMENT SYSTEM</b>							
Probe Calibration	5.1%	N	1.0000	1	1	5.1%	5.1%
Axial Isotropy	7.8%	R	1.7321	1	0.786	4.5%	3.5%
Sensor Displacement	16.5%	R	1.7321	1	0.145	9.5%	1.4%
Boundary Effects	2.4%	R	1.7321	1	1	1.4%	1.4%
Linearity	4.7%	R	1.7321	1	1	2.7%	2.7%
Scaling to Peak Envelope Power	2.0%	R	1.7321	1	1	1.2%	1.2%
System Detection Limit	1.0%	R	1.7321	1	1	0.6%	0.6%
Readout Electronics	0.3%	N	1.0000	1	1	0.3%	0.3%
Response Time	0.8%	R	1.7321	1	1	0.5%	0.5%
Integration Time	2.6%	R	1.7321	1	1	1.5%	1.5%
RF Reflections	5.6%	R	1.7321	1	1	3.2%	3.2%
Probe Positioner	1.2%	R	1.7321	1	0.67	0.7%	0.5%
Probe Positioning	4.7%	R	1.7321	1	0.67	2.7%	1.8%
Extrap. & Interpolation	1.0%	R	1.7321	1	1	0.6%	0.6%
<b>TEST SAMPLE RELATED</b>							
Total Device Positioning	3.2%	R	1.7321	1	1.306	1.8%	2.4%
Device Holder & Phantom	2.4%	R	1.7321	1	1	1.4%	1.4%
Power Drift	5.0%	R	1.7321	1	1	2.9%	2.9%
<b>PHANTOM AND SETUP RELATED</b>							
Phantom Thickness	2.4%	R	1.7321	1	0.67	1.4%	0.9%
<b>Combined Std.Uncertainty</b>						<b>13.6%</b>	<b>9.2%</b>
<b>Expanded Std. Uncertainty on Power</b>						<b>27.2%</b>	<b>18.4%</b>

**A5.2 Probe Rotation Contributions to Isotropy Error**

Probe rotation data was taken “for special focus on spherical isotropicity in measurement uncertainty and perturbation of EM fields.” This data was taken at the interpolated maximum and directly accounted for in the uncertainty budget as “Axial Isotropy.” Thirteen mobile devices were used to determine the probe isotropy uncertainty factors in section A4.1. Based on the resulting 82 E-Field probe rotations and 82 H-Field probe rotations, the upper 95% confidence interval value was calculated for each. These values represent a conservative assessment of the effect of the probe isotropy and have been appropriately included in the respective E- and H-uncertainty budgets.

**TABLE A5.2: Probe Rotation Data Summary**

	AVE	ST.DEV	Sample Size (n)	2σ	(ci)	Standard Uncertainty
E-field	4.4%	1.7%	82	7.8%	1	4.5%
H-field	3.8%	1.2%	82	6.1%	0.786	3.5%

Isotropy error measurements were taken for 13 products across the respective frequency bands. The +2σ values of all measurements was used as a worst case value for the uncertainty budget. Any significant differences between bands were also evaluated.

**Appendix 6**

**Pictures of Test Setup**  
**>>>>>> MOVED TO FCC EXHIBIT 7**

**Appendix 7**

**Probe Calibration Certificates**



Accredited by the Swiss Federal Office of Metrology and Accreditation  
The Swiss Accreditation Service is one of the signatories to the EA  
Multilateral Agreement for the recognition of calibration certificates

Accreditation No.: **SCS 108**

Client **Motorola MDb**

Certificate No. **ER3-2247 Apr06**

## CALIBRATION CERTIFICATE

Object **ER3DV6R - SN: 2247**

Calibration procedure(s) **QA CAL-02 v4  
Calibration procedure for E-field probes optimized for close near field  
evaluations in air.**

Calibration date: **April 28, 2006**

Condition of the calibrated item **In Tolerance**

This calibration certificate documents the traceability to national standards, which realize the physical units of measurements (SI).  
The measurements and the uncertainties with confidence probability are given on the following pages and are part of the certificate.

All calibrations have been conducted in the closed laboratory facility: environment temperature (22 ± 3)°C and humidity < 70%.

Calibration Equipment used (M&TE critical for calibration)

Primary Standards	ID #	Cal Date (Calibrated by, Certificate No.)	Scheduled Calibration
Power meter E4419B	GB41293874	5-Apr-06 (METAS, No. 251-00557)	Apr-07
Power sensor E4412A	MY41495277	5-Apr-06 (METAS, No. 251-00557)	Apr-07
Power sensor E4412A	MY41498087	5-Apr-06 (METAS, No. 251-00557)	Apr-07
Reference 3 dB Attenuator	SN: S5054 (3c)	11-Aug-05 (METAS, No. 251-00499)	Aug-06
Reference 20 dB Attenuator	SN: S5086 (20b)	4-Apr-06 (METAS, No. 251-00558)	Apr-07
Reference 30 dB Attenuator	SN: S5129 (30b)	11-Aug-05 (METAS, No. 251-00500)	Aug-06
Reference Probe ER3DV6	SN: 2328	3-Oct-05 (SPEAG, No. ER3-2328_Oct05)	Oct-06
DAE4	SN: 654	2-Feb-06 (SPEAG, No. DAE4-654_Feb06)	Feb-07

Secondary Standards	ID #	Check Date (in house)	Scheduled Check
RF generator HP 8648C	US3642U01700	4-Aug-99 (SPEAG, in house check Nov-05)	In house check: Nov-07
Network Analyzer HP 8753E	US37390585	18-Oct-01 (SPEAG, in house check Nov-05)	In house check: Nov 06

	Name	Function	Signature
Calibrated by:	Katja Pokovic	Technical Manager	
Approved by:	Niels Kuster	Quality Manager	

Issued: May 2, 2006

This calibration certificate shall not be reproduced except in full without written approval of the laboratory.



Accredited by the Swiss Federal Office of Metrology and Accreditation  
The Swiss Accreditation Service is one of the signatories to the EA  
Multilateral Agreement for the recognition of calibration certificates

Accreditation No.: **SCS 108**

### Glossary:

NORM <sub>x,y,z</sub>	sensitivity in free space
DCP	diode compression point
Polarization $\phi$	$\phi$ rotation around probe axis
Polarization $\vartheta$	$\vartheta$ rotation around an axis that is in the plane normal to probe axis (at measurement center), i.e., $\vartheta = 0$ is normal to probe axis
Connector Angle	information used in DASY system to align probe sensor X to the robot coordinate system

### Calibration is Performed According to the Following Standards:

- IEEE Std 1309-1996, " IEEE Standard for calibration of electromagnetic field sensors and probes, excluding antennas, from 9 kHz to 40 GHz", 1996.

### Methods Applied and Interpretation of Parameters:

- NORM<sub>x,y,z</sub>**: Assessed for E-field polarization  $\vartheta = 0$  for XY sensors and  $\vartheta = 90$  for Z sensor ( $f \leq 900$  MHz in TEM-cell;  $f > 1800$  MHz: R22 waveguide).
- NORM(f)<sub>x,y,z</sub>** = NORM<sub>x,y,z</sub> \* frequency\_response (see Frequency Response Chart).
- DCP<sub>x,y,z</sub>**: DCP are numerical linearization parameters assessed based on the data of power sweep (no uncertainty required). DCP does not depend on frequency.
- Spherical isotropy (3D deviation from isotropy)**: in a locally homogeneous field realized using an open waveguide setup.
- Sensor Offset**: The sensor offset corresponds to the offset of virtual measurement center from the probe tip (on probe axis). No tolerance required.
- Connector Angle**: The angle is assessed using the information gained by determining the NORM<sub>x</sub> (no uncertainty required).

# Probe ER3DV6R

## SN:2247

Manufactured:	February 1, 2000
Last calibrated:	July 20, 2005
Recalibrated:	April 28, 2006

Calibrated for DASY Systems

(Note: non-compatible with DASY2 system!)

**DASY - Parameters of Probe: ER3DV6R SN:2247**Sensitivity in Free Space [ $\mu\text{V}/(\text{V}/\text{m})^2$ ]Diode Compression<sup>A</sup>NormX      **1.75 ± 10.1 % (k=2)**DCP X      **97 mV**NormY      **1.49 ± 10.1 % (k=2)**DCP Y      **97 mV**NormZ      **1.47 ± 10.1 % (k=2)**DCP Z      **96 mV**

Frequency Correction

X                      **0.0**Y                      **0.0**Z                      **0.0**

Sensor Offset

(Probe Tip to Sensor Center)

X                      **2.5 mm**Y                      **2.5 mm**Z                      **2.5 mm**

Connector Angle

**33 °**

**The reported uncertainty of measurement is stated as the standard uncertainty of measurement multiplied by the coverage factor k=2, which for a normal distribution corresponds to a coverage probability of approximately 95%.**

<sup>A</sup> numerical linearization parameter: uncertainty not required

# Frequency Response of E-Field

(TEM-Cell:ifi110 EXX, Waveguide R22)

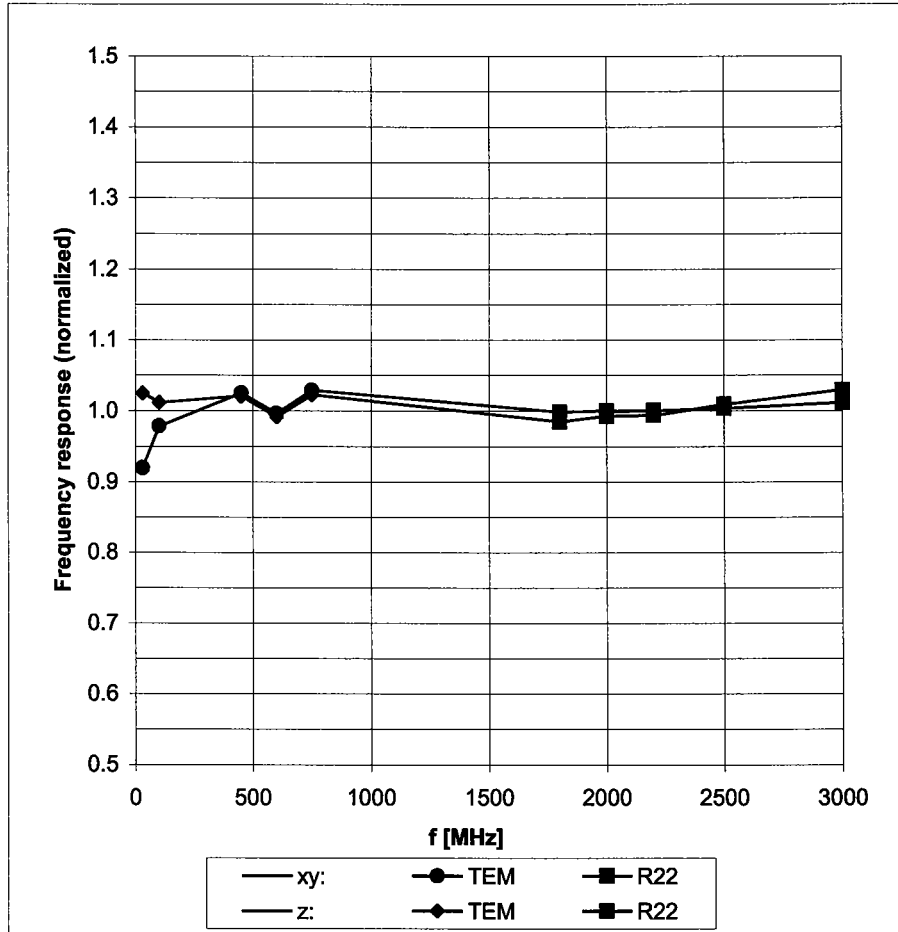

Uncertainty of Frequency Response of E-field:  $\pm 6.3\%$  ( $k=2$ )

### Receiving Pattern ( $\phi$ ), $\vartheta = 0^\circ$

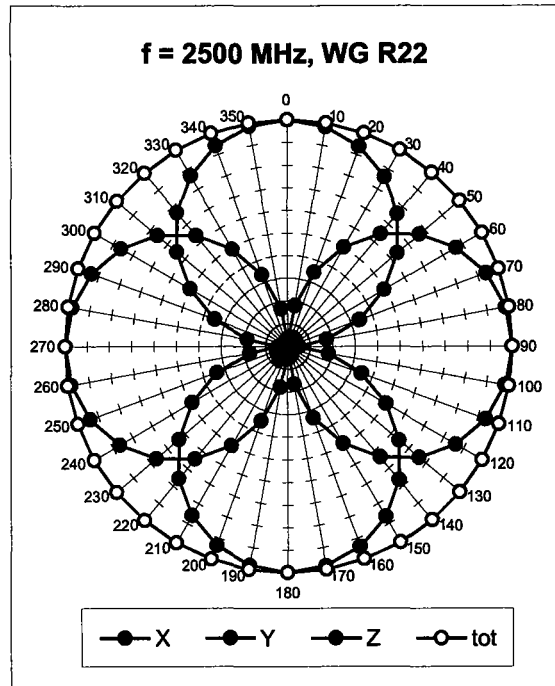
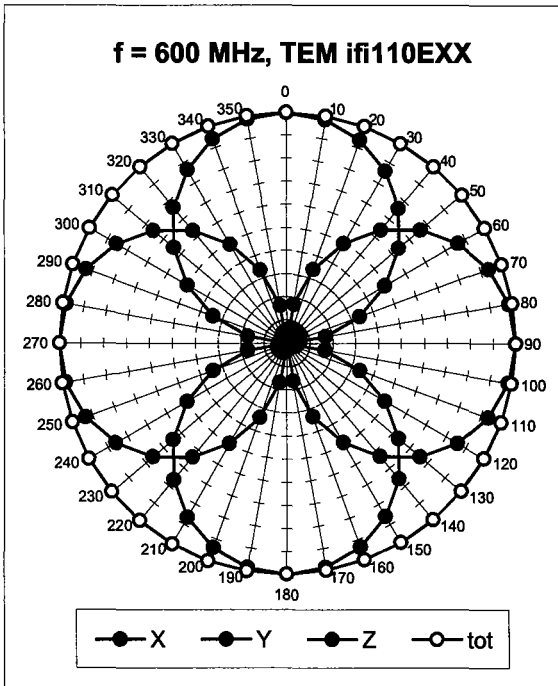

### Receiving Pattern ( $\phi$ ), $\vartheta = 90^\circ$

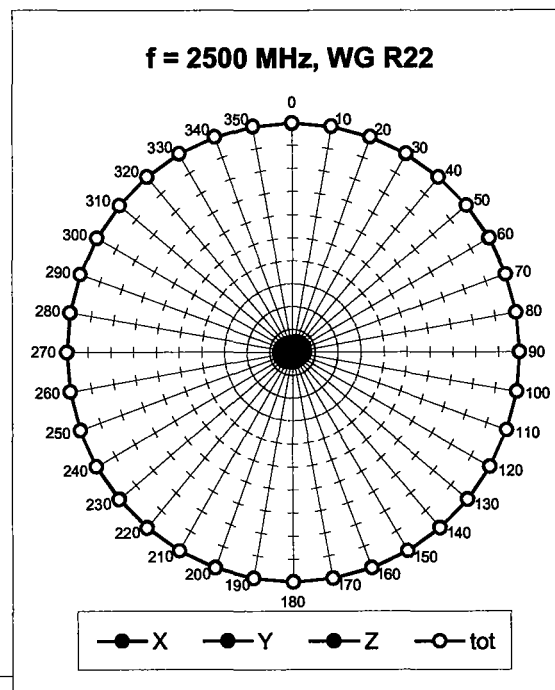
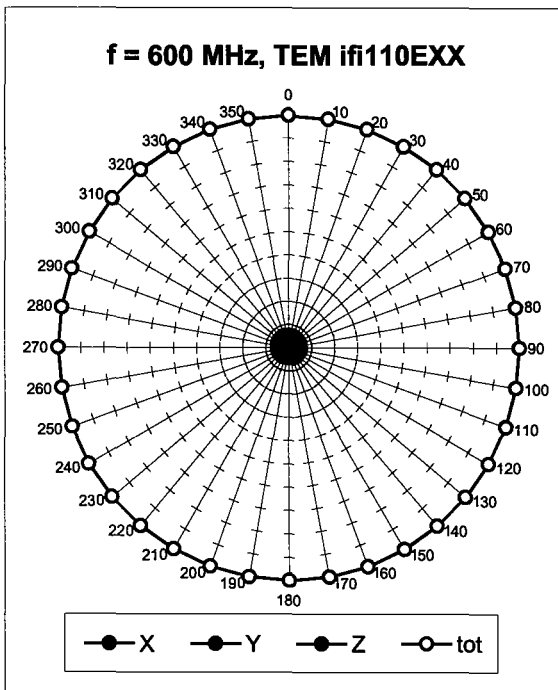

### Receiving Pattern ( $\phi$ ), $\vartheta = 0^\circ$

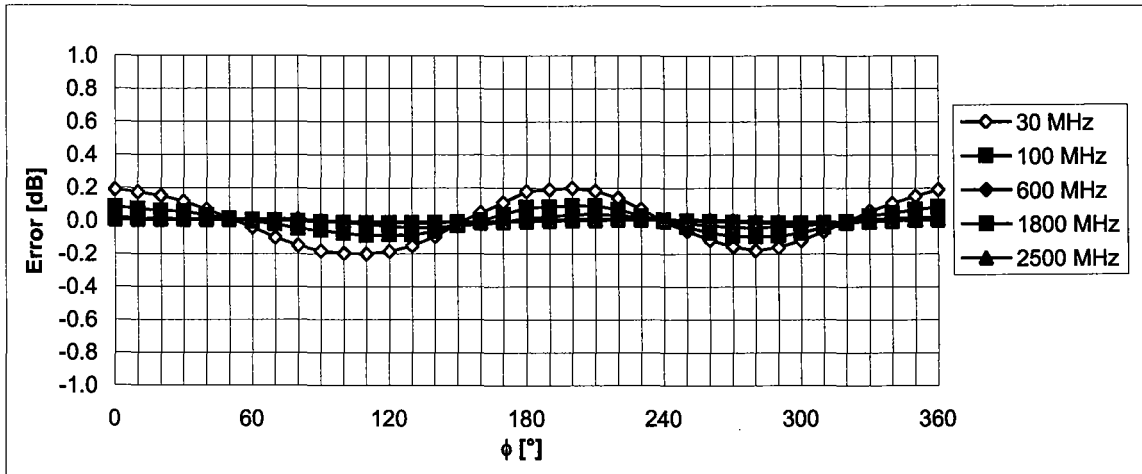

Uncertainty of Axial Isotropy Assessment:  $\pm 0.5\%$  ( $k=2$ )

### Receiving Pattern ( $\phi$ ), $\vartheta = 90^\circ$

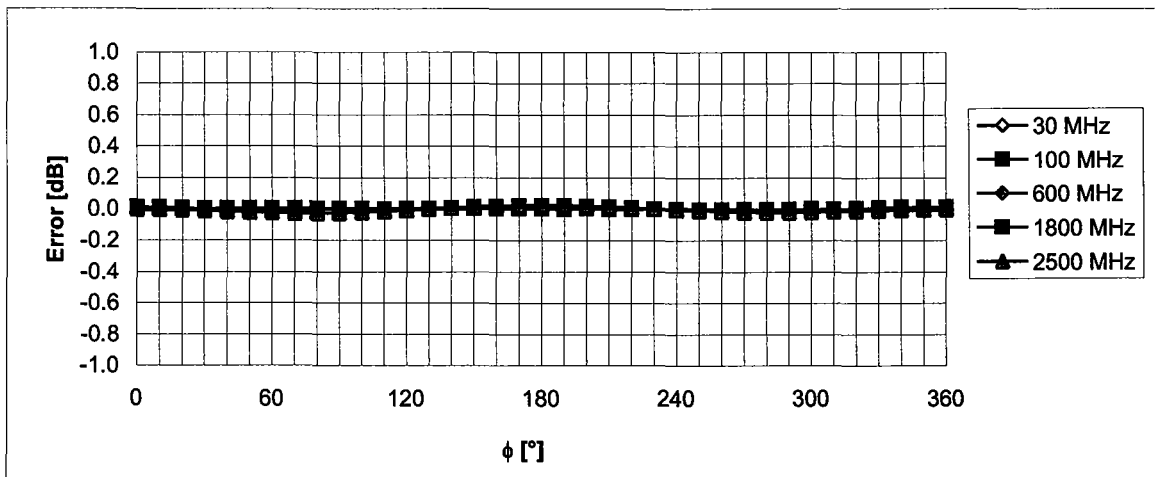

Uncertainty of Axial Isotropy Assessment:  $\pm 0.5\%$  ( $k=2$ )

### Dynamic Range f(E-field) (Waveguide R22, f = 1800 MHz)

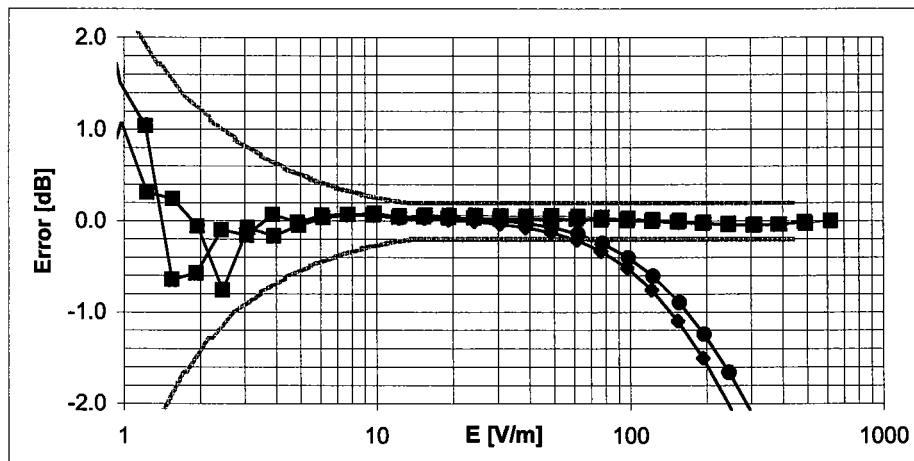
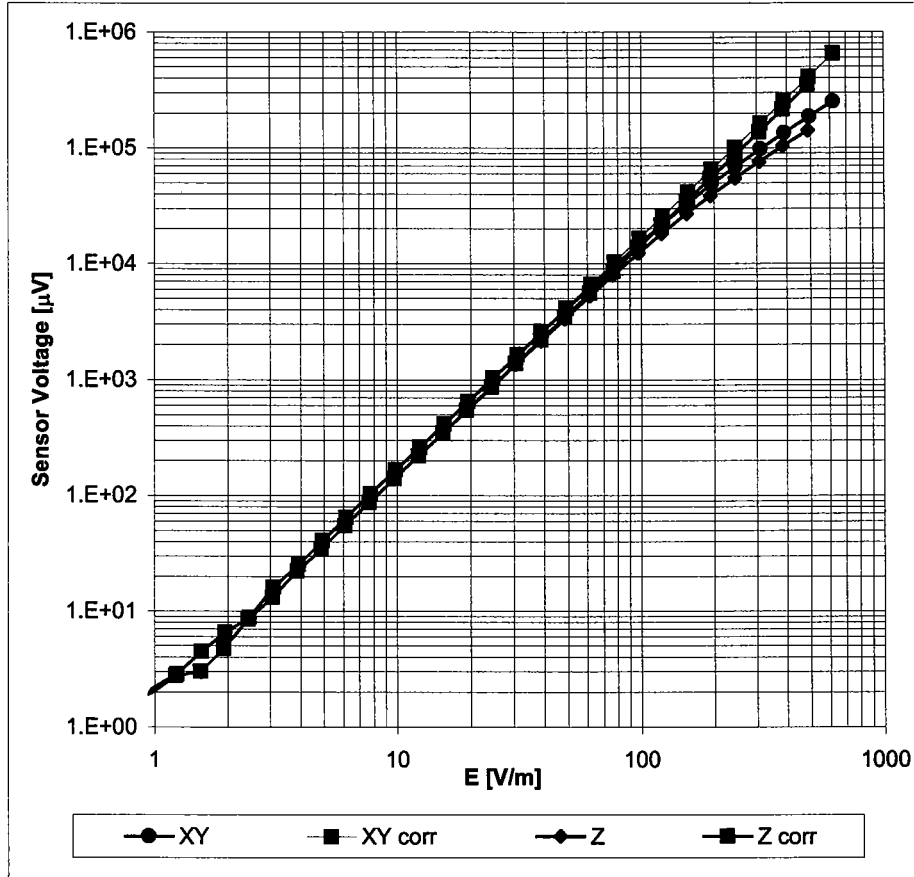

Uncertainty of Linearity Assessment:  $\pm 0.6\%$  (k=2)

### Deviation from Isotropy in Air Error ( $\phi, \vartheta$ ), $f = 900$ MHz

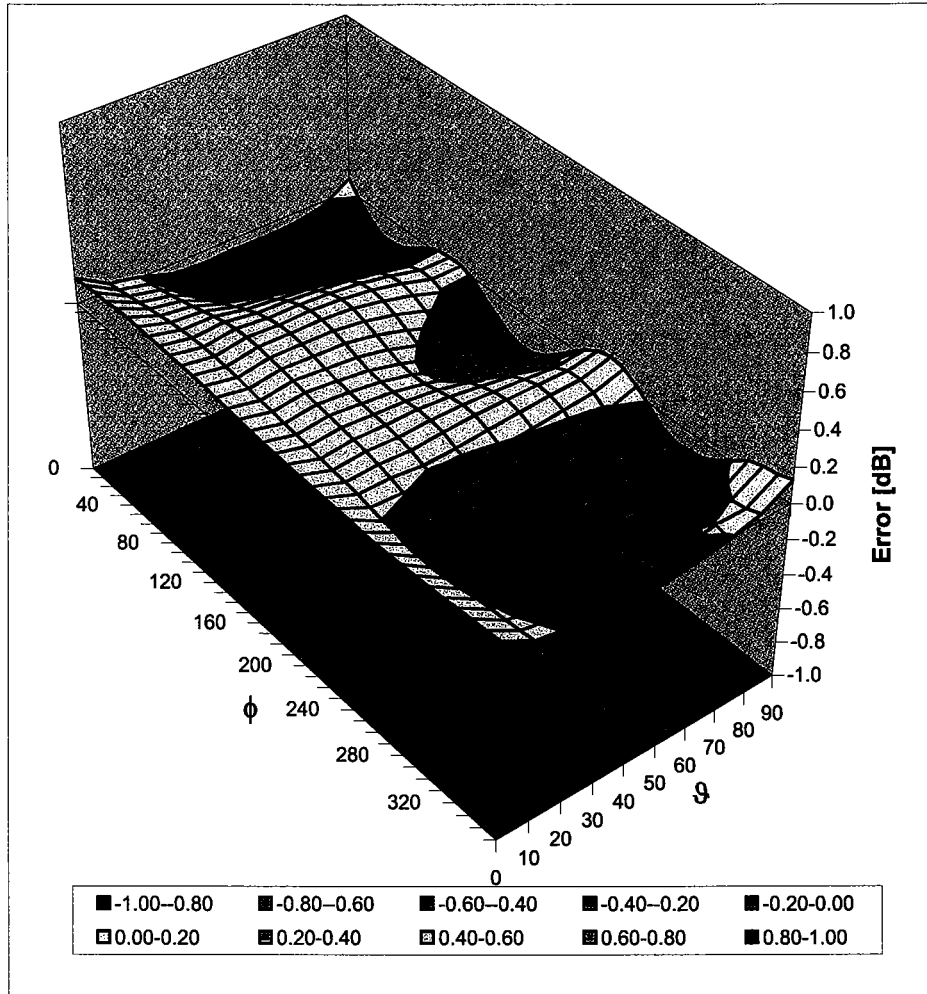

Uncertainty of Spherical Isotropy Assessment:  $\pm 2.6\%$  ( $k=2$ )



Accredited by the Swiss Federal Office of Metrology and Accreditation  
The Swiss Accreditation Service is one of the signatories to the EA  
Multilateral Agreement for the recognition of calibration certificates

Accreditation No.: **SCS 108**

Client **Motorola MDb**

Certificate No. **H3-6074\_Apr06**

## CALIBRATION CERTIFICATE

Object: **H3DV6 - SN: 6074**

Calibration procedure(s): **QA CAL-03 v4  
Calibration procedure for H-field probes optimized for close near field evaluations in air**

Calibration date: **April 27, 2006**

Condition of the calibrated item: **In Tolerance**

This calibration certificate documents the traceability to national standards, which realize the physical units of measurements (SI).  
The measurements and the uncertainties with confidence probability are given on the following pages and are part of the certificate.

All calibrations have been conducted in the closed laboratory facility: environment temperature ( $22 \pm 3$ )°C and humidity < 70%.

Calibration Equipment used (M&TE critical for calibration)

Primary Standards	ID #	Cal Date (Calibrated by, Certificate No.)	Scheduled Calibration
Power meter E4419B	GB41293874	5-Apr-06 (METAS, No. 251-00557)	Apr-07
Power sensor E4412A	MY41495277	5-Apr-06 (METAS, No. 251-00557)	Apr-07
Power sensor E4412A	MY41498087	5-Apr-06 (METAS, No. 251-00557)	Apr-07
Reference 3 dB Attenuator	SN: S5054 (3c)	11-Aug-05 (METAS, No. 251-00499)	Aug-06
Reference 20 dB Attenuator	SN: S5086 (20b)	4-Apr-06 (METAS, No. 251-00558)	Apr-07
Reference 30 dB Attenuator	SN: S5129 (30b)	11-Aug-05 (METAS, No. 251-00500)	Aug-06
Reference Probe H3DV6	SN: 6182	3-Oct-05 (SPEAG, No. H3-6182_Oct05)	Oct-06
DAE4	SN: 654	2-Feb-06 (SPEAG, No. DAE4-654_Feb06)	Feb-07
Secondary Standards	ID #	Check Date (in house)	Scheduled Check
RF generator HP 8648C	US3642U01700	4-Aug-99 (SPEAG, in house check Nov-05)	In house check: Nov-07
Network Analyzer HP 8753E	US37390585	18-Oct-01 (SPEAG, in house check Nov-05)	In house check: Nov 06

Calibrated by: **Katja Pokovic** (Name), **Technical Manager** (Function), *[Signature]* (Signature)

Approved by: **Niels Kuster** (Name), **Quality Manager** (Function), *[Signature]* (Signature)

Issued: May 2, 2006

This calibration certificate shall not be reproduced except in full without written approval of the laboratory.



Accredited by the Swiss Federal Office of Metrology and Accreditation  
The Swiss Accreditation Service is one of the signatories to the EA  
Multilateral Agreement for the recognition of calibration certificates

Accreditation No.: **SCS 108**

**Glossary:**

NORM <sub>x,y,z</sub>	sensitivity in free space
DCP	diode compression point
Polarization $\phi$	$\phi$ rotation around probe axis
Polarization $\vartheta$	$\vartheta$ rotation around an axis that is in the plane normal to probe axis (at measurement center), i.e., $\vartheta = 0$ is normal to probe axis
Connector Angle	information used in DASY system to align probe sensor X to the robot coordinate system

**Calibration is Performed According to the Following Standards:**

- a) IEEE Std 1309-1996, "IEEE Standard for calibration of electromagnetic field sensors and probes, excluding antennas, from 9 kHz to 40 GHz", 1996.

**Methods Applied and Interpretation of Parameters:**

- $X, Y, Z_{a0a1a2}$ : Assessed for E-field polarization  $\vartheta = 90$  for XY sensors and  $\vartheta = 0$  for Z sensor ( $f \leq 900$  MHz in TEM-cell;  $f > 1800$  MHz: R22 waveguide).
- $X, Y, Z(f)_{a0a1a2} = X, Y, Z_{a0a1a2} * \text{frequency\_response}$  (see Frequency Response Chart).
- $DCP_{x,y,z}$ : DCP are numerical linearization parameters assessed based on the data of power sweep (no uncertainty required). DCP does not depend on frequency.
- *Spherical isotropy (3D deviation from isotropy)*: in a locally homogeneous field realized using an open waveguide setup.
- *Sensor Offset*: The sensor offset corresponds to the offset of virtual measurement center from the probe tip (on probe axis). No tolerance required.
- *Connector Angle*: The angle is assessed using the information gained by determining the  $X_{a0a1a2}$  (no uncertainty required).

# Probe H3DV6

## SN:6074

Manufactured:	October 2, 2000
Last calibrated:	July 20, 2005
Recalibrated:	April 27, 2006

Calibrated for DASY Systems

(Note: non-compatible with DASY2 system!)

**DASY - Parameters of Probe: H3DV6 SN:6074**Sensitivity in Free Space [A/m /  $\sqrt{(\mu\text{V})}$ ]

	a0	a1	a2
X	2.622E-03	2.520E-5	5.519E-7 ± 5.1 % (k=2)
Y	2.661E-03	-7.609E-5	-6.451E-5 ± 5.1 % (k=2)
Z	3.173E-03	-2.612E-4	-2.508E-5 ± 5.1 % (k=2)

Diode Compression<sup>1</sup>

DCP X	85 mV
DCP Y	85 mV
DCP Z	86 mV

Sensor Offset (Probe Tip to Sensor Center)

X	3.0 mm
Y	3.0 mm
Z	3.0 mm

Connector Angle 12 °

The reported uncertainty of measurement is stated as the standard uncertainty of measurement multiplied by the coverage factor k=2, which for a normal distribution corresponds to a coverage probability of approximately 95%.

<sup>1</sup> numerical linearization parameter: uncertainty not required

# Frequency Response of H-Field

(TEM-Cell:ifi110, Waveguide R22)

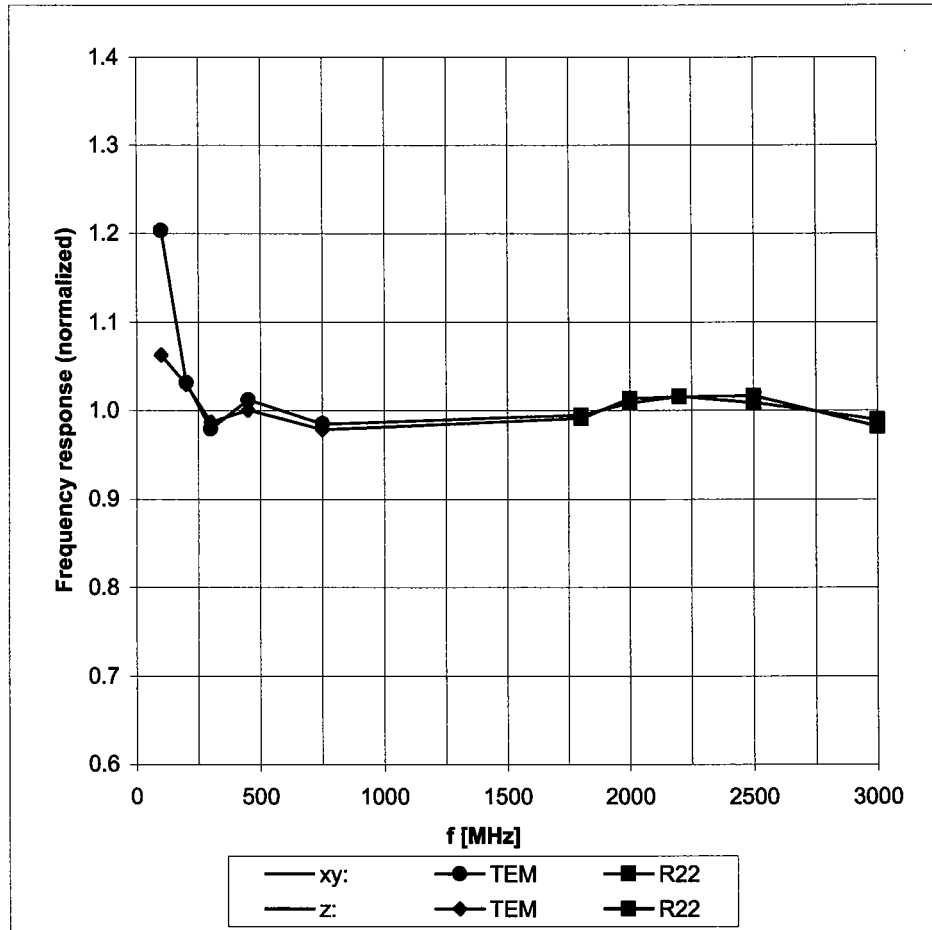

Uncertainty of Frequency Response of E-field:  $\pm 6.3\%$  (k=2)

### Receiving Pattern ( $\phi$ ), $\vartheta = 90^\circ$

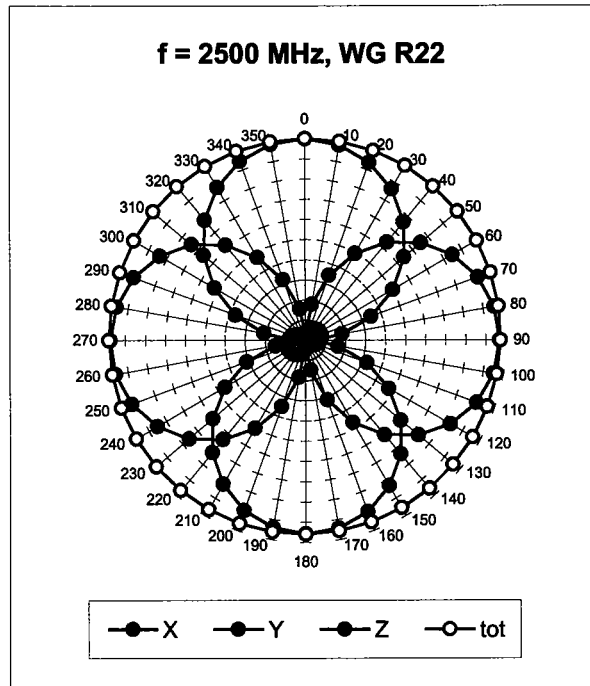
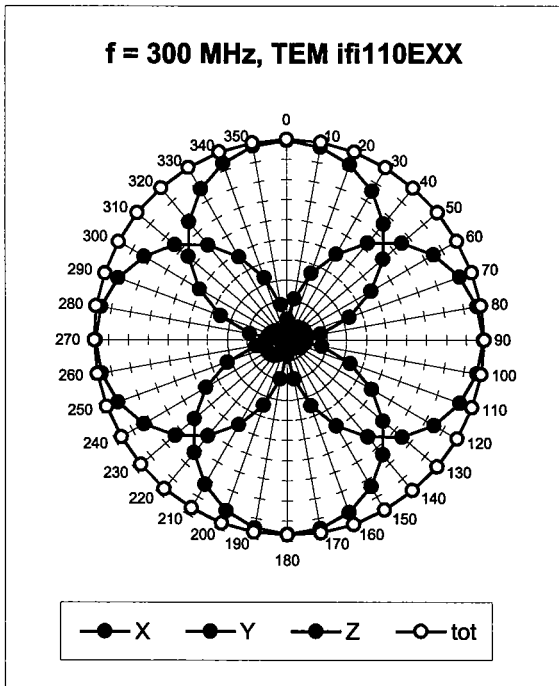

### Receiving Pattern ( $\phi$ ), $\vartheta = 0^\circ$

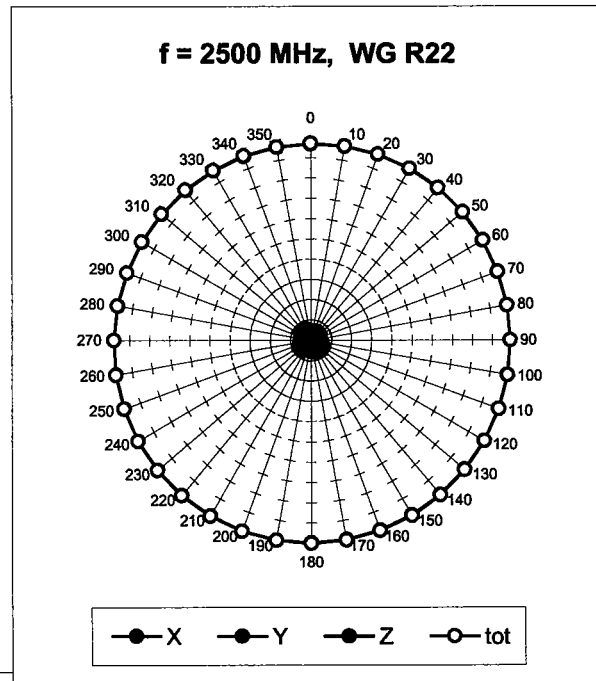
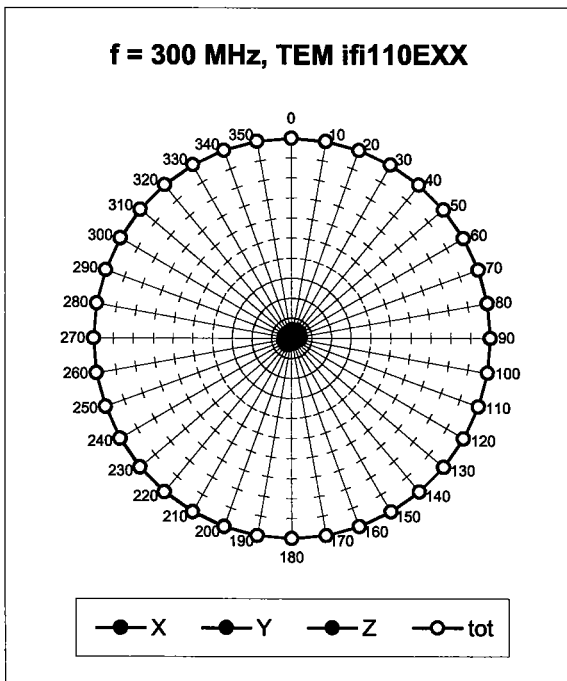

### Receiving Pattern ( $\phi$ ), $\vartheta = 90^\circ$

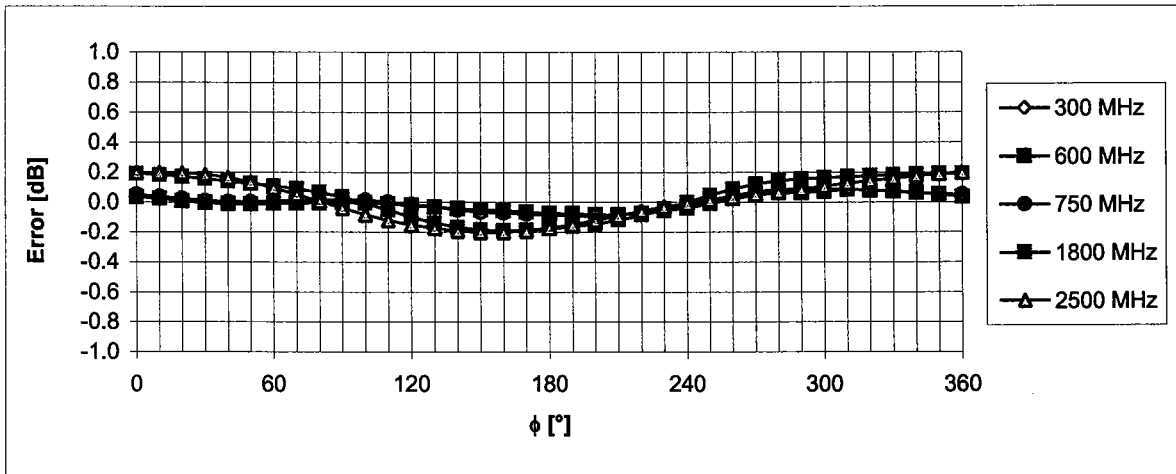

Uncertainty of Axial Isotropy Assessment:  $\pm 0.5\%$  ( $k=2$ )

### Receiving Pattern ( $\phi$ ), $\vartheta = 0^\circ$

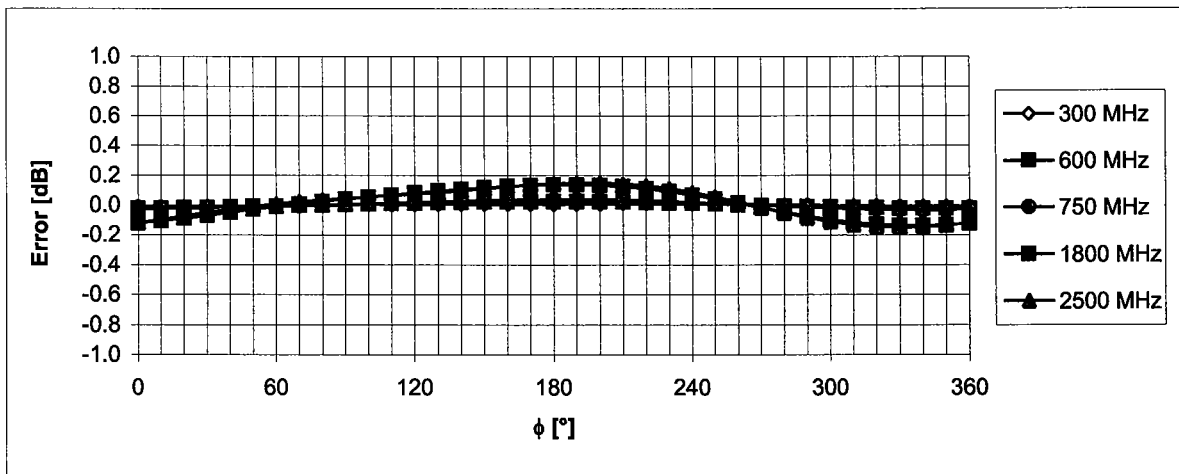

Uncertainty of Axial Isotropy Assessment:  $\pm 0.5\%$  ( $k=2$ )

### Dynamic Range f(H-field) (Waveguide R22, f = 1800 MHz)

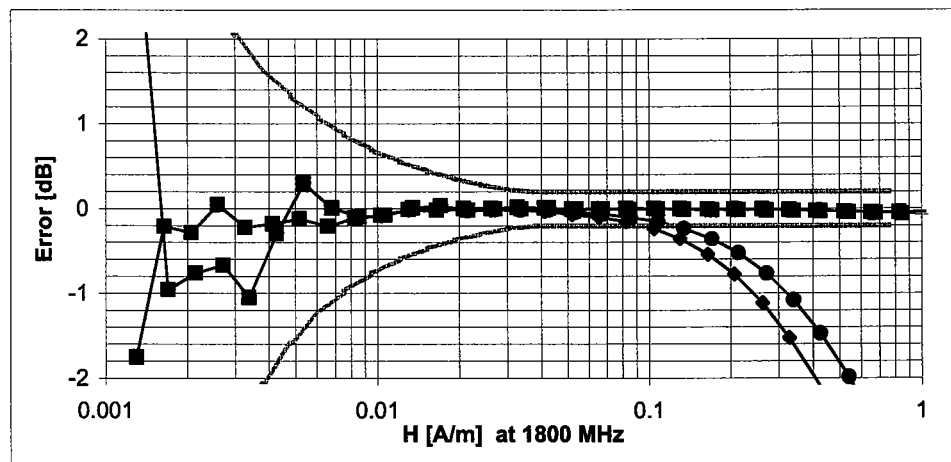
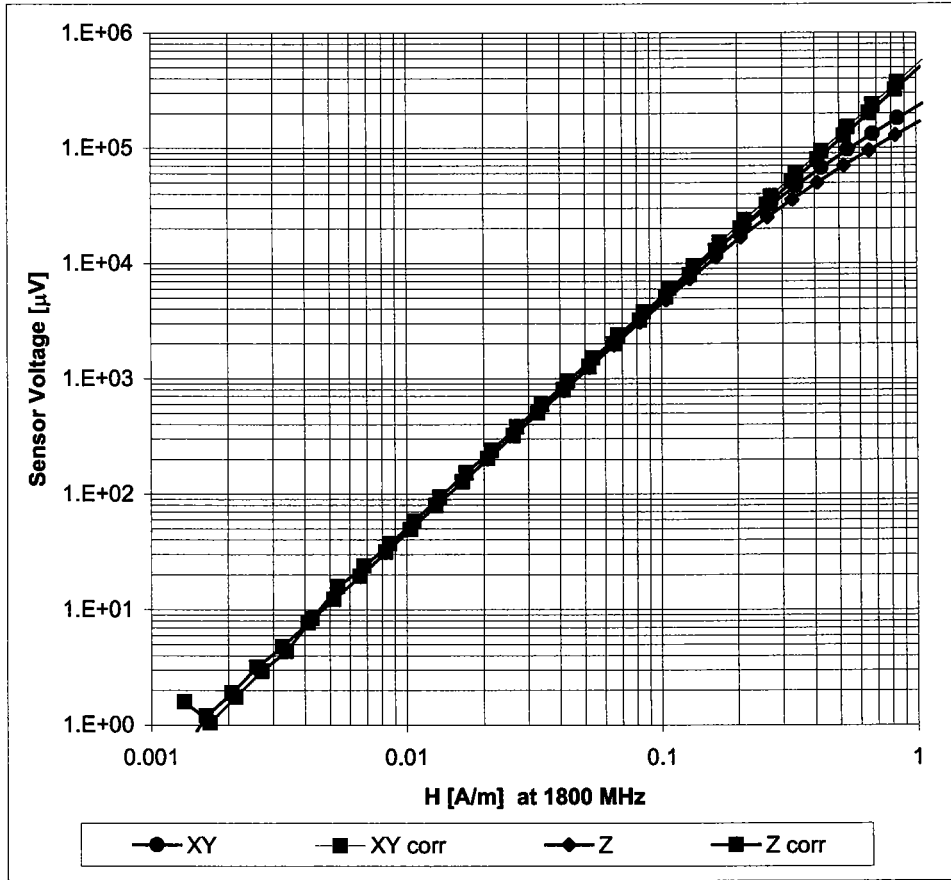

Uncertainty of Linearity Assessment:  $\pm 0.6\%$  (k=2)

**Appendix 8**

**Dipole Characterization Certificate**



Accredited by the Swiss Federal Office of Metrology and Accreditation  
The Swiss Accreditation Service is one of the signatories to the EA  
Multilateral Agreement for the recognition of calibration certificates

Accreditation No.: **SCS 108**

Client **Motorola MDb**

Certificate No: **CD835V3-1051\_May06**

## CALIBRATION CERTIFICATE

Object **CD835V3 - SN: 1051**

Calibration procedure(s) **QA CAL-20.v4  
Calibration procedure for dipoles in air**

Calibration date: **May 5, 2006**

Condition of the calibrated item **In Tolerance**

This calibration certificate documents the traceability to national standards, which realize the physical units of measurements (SI).  
All calibrations have been conducted in the closed laboratory facility: environment temperature ( $22 \pm 3$ )°C and humidity < 70%.

Calibration Equipment used (M&TE critical for calibration)

Primary Standards	ID #	Cal Date (Calibrated by, Certificate No.)	Scheduled Calibration
Power meter EPM-442A	GB37480704	04-Oct-05 (METAS, No. 251-00516)	Oct-06
Power sensor HP 8481A	US37292783	04-Oct-05 (METAS, No. 251-00516)	Oct-06
Reference 20 dB Attenuator	SN: 5086 (20g)	11-Aug-05 (METAS, No 251-00498)	Aug-06
Reference 10 dB Attenuator	SN: 5047.2 (10r)	11-Aug-05 (METAS, No 251-00498)	Aug-06

Secondary Standards	ID #	Check Date (in house)	Scheduled Check
Power sensor HP 8481A	MY41092317	18-Oct-02 (SPEAG, in house check Oct-05)	In house check: Oct-07
RF generator Agilent E4421B	MY41000675	11-May-05 (SPEAG, in house check Nov-05)	In house check: Nov-07
Network Analyzer HP 8753E	US37390585 S4206	18-Oct-01 (SPEAG, in house check Nov-05)	In house check: Nov-06
DAE4	SN: 660	1-Mar-06 (SPEAG, No. DAE4-660_Mar06)	Calibration, Mar-07
Probe ER3DV6	SN: 2336	20-Dec-05 (SPEAG, No. ER3-2336_Dec05)	Calibration, Dec-06
Probe H3DV6	SN: 6065	20-Dec-05 (SPEAG, No. H3-6065-Dec05)	Calibration, Dec-06

Calibrated by:	Name <b>Mike Meili</b>	Function Laboratory Technician	Signature 
Approved by:	Name <b>Katja Pokovic</b>	Function Technical Manager	Signature 

Issued: May 5, 2006

This calibration certificate shall not be reproduced except in full without written approval of the laboratory.



Accredited by the Swiss Federal Office of Metrology and Accreditation  
The Swiss Accreditation Service is one of the signatories to the EA  
Multilateral Agreement for the recognition of calibration certificates

Accreditation No.: **SCS 108**

## References

- [1] ANSI-PC63.19-2001 (Draft 3.x, 2005)  
American National Standard for Methods of Measurement of Compatibility between Wireless Communications Devices and Hearing Aids.

## Methods Applied and Interpretation of Parameters:

- *Coordinate System:* y-axis is in the direction of the dipole arms. z-axis is from the basis of the antenna (mounted on the table) towards its feed point between the two dipole arms. x-axis is normal to the other axes. In coincidence with standard [1], the measurement planes (probe sensor center) are selected to be at a distance of 10 mm above the top edge of the dipole arms.
- *Measurement Conditions:* Further details are available from the hardcopies at the end of the certificate. All figures stated in the certificate are valid at the frequency indicated. The forward power to the dipole connector is set with a calibrated power meter connected and monitored with an auxiliary power meter connected to a directional coupler. While the dipole under test is connected, the forward power is adjusted to the same level.
- *Antenna Positioning:* The dipole is mounted on a HAC Test Arch phantom using the matching dipole positioner with the arms horizontal and the feeding cable coming from the floor. The measurements are performed in a shielded room with absorbers around the setup to reduce the reflections. It is verified before the mounting of the dipole under the Test Arch phantom, that its arms are perfectly in a line. It is installed on the HAC dipole positioner with its arms parallel below the dielectric reference wire and able to move elastically in vertical direction without changing its relative position to the top center of the Test Arch phantom. The vertical distance to the probe is adjusted after dipole mounting with a DASY4 Surface Check job. Before the measurement, the distance between phantom surface and probe tip is verified. The proper measurement distance is selected by choosing the matching section of the HAC Test Arch phantom with the proper device reference point (upper surface of the dipole) and the matching grid reference point (tip of the probe) considering the probe sensor offset. The vertical distance to the probe is essential for the accuracy.
- *Feed Point Impedance and Return Loss:* These parameters are measured using a HP 8753E Vector Network Analyzer. The impedance is specified at the SMA connector of the dipole. The influence of reflections was eliminated by applying the averaging function while moving the dipole in the air, at least 70cm away from any obstacles.
- *E- field distribution:* E field is measured in the x-y-plane with an isotropic ER3D-field probe with 100 mW forward power to the antenna feed point. In accordance with [1], the scan area is 20mm wide, its length exceeds the dipole arm length (180 or 90mm). The sensor center is 10 mm (in z) above the top of the dipole arms. Two 3D maxima are available near the end of the dipole arms. Assuming the dipole arms are perfectly in one line, the average of these two maxima (in subgrid 2 and subgrid 8) is determined to compensate for any non-parallelity to the measurement plane as well as the sensor displacement. The E-field value stated as calibration value represents the maximum of the interpolated 3D-E-field, 10mm above the dipole surface.
- *H-field distribution:* H-field is measured with an isotropic H-field probe with 100mW forward power to the antenna feed point, in the x-y-plane. The scan area and sensor distance is equivalent to the E-field scan. The maximum of the field is available at the center (subgrid 5) above the feed point. The H-field value stated as calibration value represents the maximum of the interpolated H-field, 10mm above the dipole surface at the feed point.

## 1 Measurement Conditions

DASY system configuration, as far as not given on page 1.

<b>DASY Version</b>	DASY4	V4.7 B21
<b>DASY PP Version</b>	SEMCAD	V1.8 B165
<b>Phantom</b>	HAC Test Arch	SD HAC P01 BA, #1002
<b>Distance Dipole Top - Probe Center</b>	10 mm	
<b>Scan resolution</b>	dx, dy = 5 mm	area = 20 x 180 mm
<b>Frequency</b>	<b>835 MHz ± 1 MHz</b>	
<b>Forward power at dipole connector</b>	20.0 dBm = 100mW	
<b>Input power drift</b>	< 0.05 dB	

## 2 Maximum Field values

<b>H-field 10 mm above dipole surface</b>	condition	<b>interpolated maximum</b>
Maximum measured	100 mW forward power	<b>0.448 A/m</b>

Uncertainty for H-field measurement: 8.2% (k=2)

<b>E-field 10 mm above dipole surface</b>	condition	<b>Interpolated maximum</b>
Maximum measured above high end	100 mW forward power	167.4 V/m
Maximum measured above low end	100 mW forward power	166.4 V/m
Averaged maximum above arm	100 mW forward power	<b>166.9 V/m</b>

Uncertainty for E-field measurement: 12.8% (k=2)

## 3 Appendix

### 3.1 Antenna Parameters

<b>Frequency</b>	<b>Return Loss</b>	<b>Impedance</b>
800 MHz	17.6 dB	( 41.1 – j8.2 ) Ohm
<b>813 MHz</b>	<b>21.3 dB</b>	<b>( 42.8 – j3.5 ) Ohm</b>
<b>835 MHz</b>	<b>27.9 dB</b>	<b>( 50.1 + j4.0 ) Ohm</b>
<b>898 MHz</b>	<b>17.8 dB</b>	<b>( 51.8 – j13.0 ) Ohm</b>
960 MHz	13.9 dB	( 68.6 + j15.4 ) Ohm

### 3.2 Antenna Design and Handling

The calibration dipole has a symmetric geometry with a built-in two stub matching network, which leads to the enhanced bandwidth.

The dipole is built of standard semirigid coaxial cable. The internal matching line is open ended. The antenna is therefore open for DC signals.

Do not apply force to dipole arms, as they are liable to bend. The soldered connections near the feedpoint may be damaged. After excessive mechanical stress or overheating, check the impedance characteristics to ensure that the internal matching network is not affected.

After long term use with 40W radiated power, only a slight warming of the dipole near the feedpoint can be measured.

### 3.3 Measurement Sheets

#### 3.3.1 Return Loss and Smith Chart

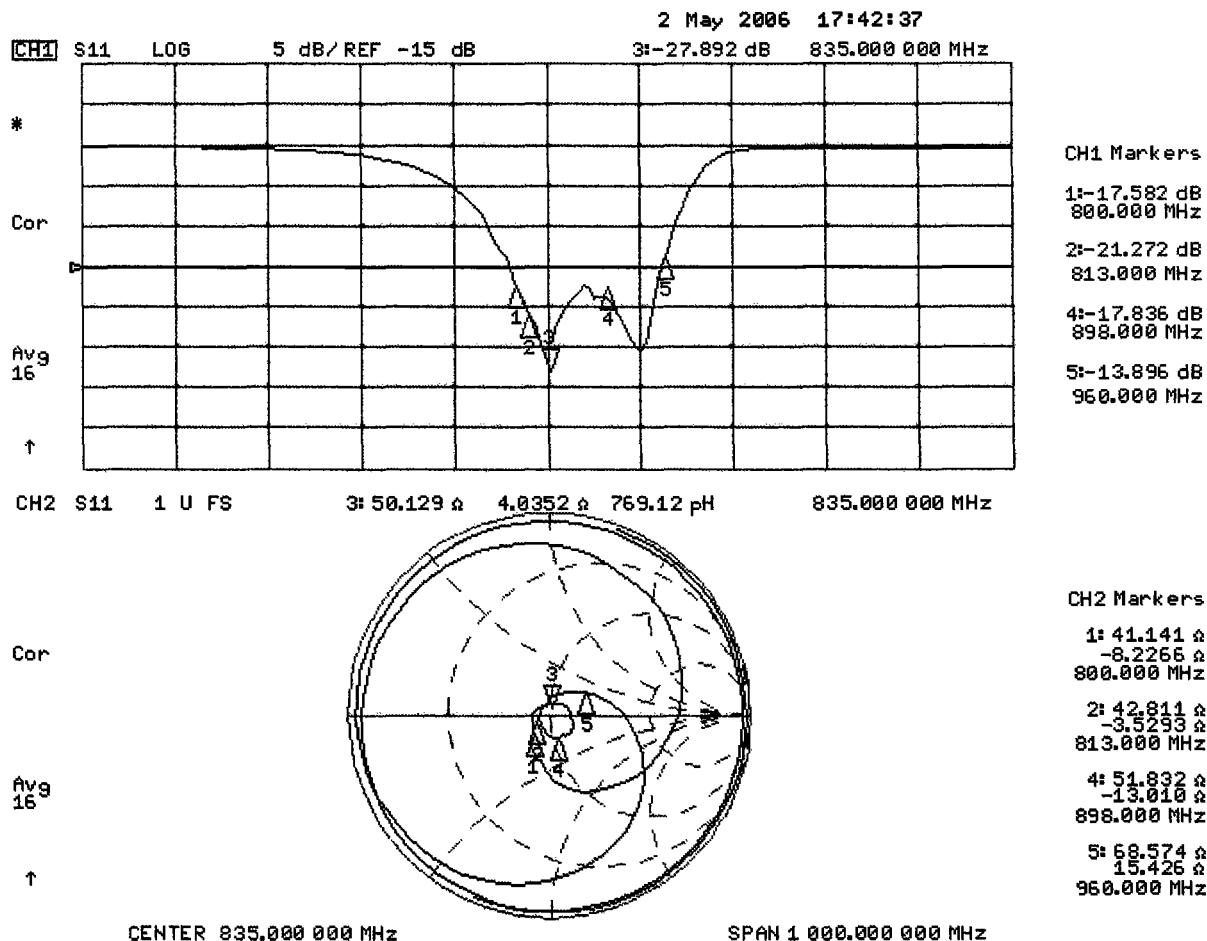

### 3.3.2 DASY4 H-field result

Date/Time: 02.05.2006 16:53:28

Test Laboratory: SPEAG, Zurich, Switzerland

**DUT: HAC-Dipole 835 MHz; Type: D835V3; Serial: 1051**

Communication System: CW; Frequency: 835 MHz; Duty Cycle: 1:1

Medium: Air

Medium parameters used:  $\sigma = 0$  mho/m,  $\epsilon_r = 1$ ;  $\rho = 1$  kg/m<sup>3</sup>

Phantom section: H Dipole Section

Measurement Standard: DASY4 (High Precision Assessment)

DASY4 Configuration:

- Probe: H3DV6 - SN6065; Calibrated: 20.12.2005
- Sensor-Surface: (Fix Surface)
- Electronics: DAE4 Sn660; Calibrated: 01.03.2006
- Phantom: HAC Test Arch 4.6; Type: SD HAC P01 BA
- Measurement SW: DASY4, V4.7 Build 21; Postprocessing SW: SEMCAD, V1.8 Build 165

**H Scan - Sensor Center 10mm above CD835 Dipole/Hearing Aid Compatibility Test (41x361x1):**

Measurement grid: dx=5mm, dy=5mm

Maximum value of peak Total field = 0.448 A/m

Probe Modulation Factor = 1.00

Reference Value = 0.476 A/m; Power Drift = 0.001 dB

**Hearing Aid Near-Field Category: M4 (AWF 0 dB)**

Peak H-field in A/m

Grid 1	Grid 2	Grid 3
0.376	0.399	0.378
Grid 4	Grid 5	Grid 6
0.430	0.448	0.422
Grid 7	Grid 8	Grid 9
0.383	0.395	0.366

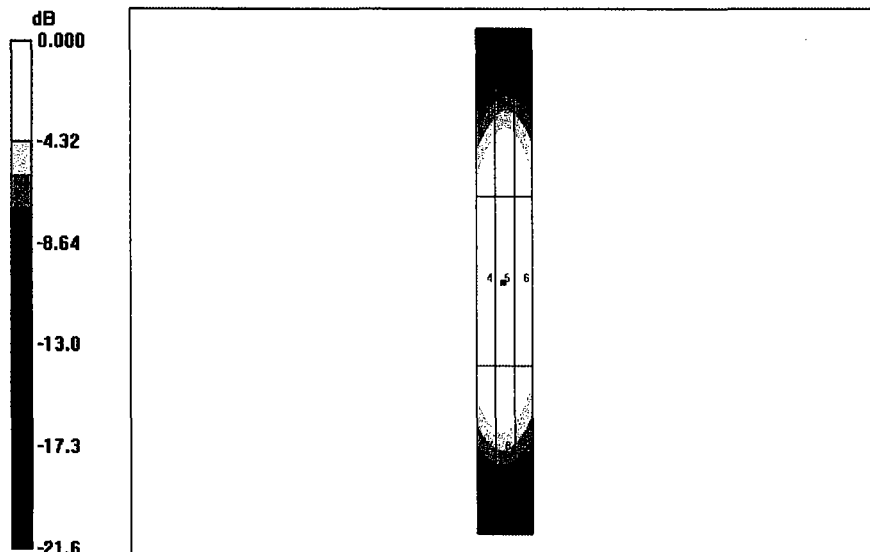

0 dB = 0.448A/m

### 3.3.3 DASY4 E-Field result

Date/Time: 02.05.2006 12:38:35

Test Laboratory: SPEAG, Zurich, Switzerland

**DUT: HAC-Dipole 835 MHz; Type: D835V3; Serial: 1051**

Communication System: CW; Frequency: 835 MHz; Duty Cycle: 1:1

Medium: Air

Medium parameters used:  $\sigma = 0$  mho/m,  $\epsilon_r = 1$ ;  $\rho = 1000$  kg/m<sup>3</sup>

Phantom section: E Dipole Section

Measurement Standard: DASY4 (High Precision Assessment)

DASY4 Configuration:

- Probe: ER3DV6 - SN2336; ConvF(1, 1, 1); Calibrated: 20.12.2005
- Sensor-Surface: (Fix Surface)
- Electronics: DAE4 Sn660; Calibrated: 01.03.2006
- Phantom: HAC Test Arch 4.6; Type: SD HAC P01 BA;
- Measurement SW: DASY4, V4.7 Build 21; Postprocessing SW: SEMCAD, V1.8 Build 165

**E Scan - Sensor Center 10mm above CD835 Dipole/Hearing Aid Compatibility Test (41x361x1):**

Measurement grid: dx=5mm, dy=5mm

Maximum value of peak Total field = 167.4 V/m

Probe Modulation Factor = 1.00

Reference Value = 126.0 V/m; Power Drift = -0.015 dB

**Hearing Aid Near-Field Category: M4 (AWF 0 dB)**

Peak E-field in V/m

Grid 1	Grid 2	Grid 3
161.0	167.4	163.5
Grid 4	Grid 5	Grid 6
89.9	91.3	88.4
Grid 7	Grid 8	Grid 9
164.9	166.4	159.9

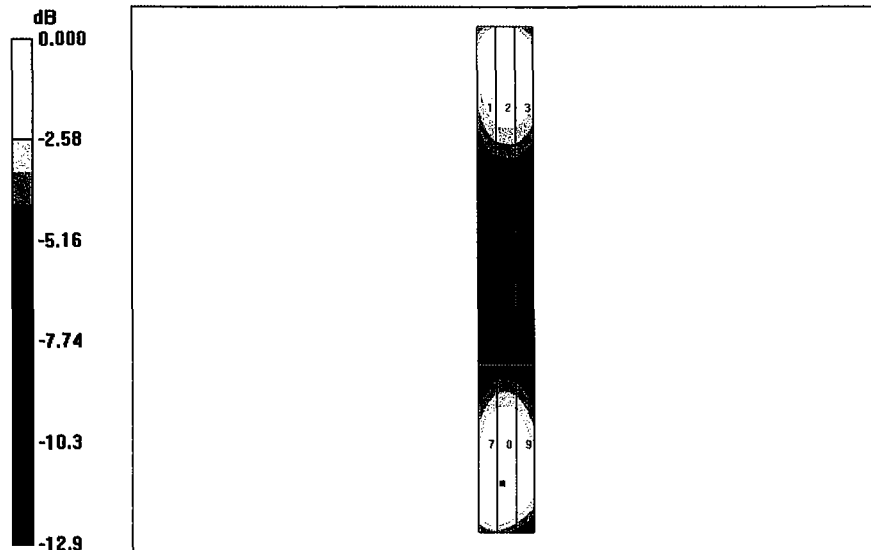

0 dB = 167.4V/m

#### 4. Additional Measurements

##### 4.1 Measurement Conditions

DASY system configuration, as far as not given on page 1.

<b>DASY Version</b>	DASY4	V4.7 B21
<b>DASY PP Version</b>	SEMCAD	V1.8 B165
<b>Phantom</b>	HAC Test Arch	SD HAC P01 BA, #1002
<b>Distance Dipole Top - Probe Center</b>	10 mm	
<b>Scan resolution</b>	dx, dy = 5 mm	area = 20 x 180 mm
<b>Frequency</b>	<b>813 MHz ± 1 MHz</b>	
<b>Forward power at dipole connector</b>	20.0 dBm = 100mW	
<b>Input power drift</b>	< 0.05 dB	

##### 4.1.1 Maximum Field values

<b>H-field 10 mm above dipole surface</b>	condition	<b>interpolated maximum</b>
Maximum measured	100 mW forward power	<b>0.468 A/m</b>

Uncertainty for H-field measurement: 8.2% (k=2)

<b>E-field 10 mm above dipole surface</b>	condition	<b>Interpolated maximum</b>
Maximum measured above high end	100 mW forward power	173.5 V/m
Maximum measured above low end	100 mW forward power	167.9 V/m
Averaged maximum above arm	100 mW forward power	<b>170.7 V/m</b>

Uncertainty for E-field measurement: 12.8% (k=2)

**4.1.2 DASY4 H-field result**

Date/Time: 05.05.2006 13:20:42

Test Laboratory: SPEAG, Zurich, Switzerland

**DUT: HAC-Dipole 835 MHz; Type: D835V3; Serial: 1051**

Communication System: CW; Frequency: 813 MHz; Duty Cycle: 1:1

Medium: Air

Medium parameters used:  $\sigma = 0$  mho/m,  $\epsilon_r = 1$ ;  $\rho = 1$  kg/m<sup>3</sup>

Phantom section: H Dipole Section

Measurement Standard: DASY4 (High Precision Assessment)

DASY4 Configuration:

- Probe: H3DV6 - SN6065; Calibrated: 20.12.2005
- Sensor-Surface: (Fix Surface)
- Electronics: DAE4 Sn660; Calibrated: 01.03.2006
- Phantom: HAC Test Arch 4.6; Type: SD HAC P01 BA
- Measurement SW: DASY4, V4.7 Build 21; Postprocessing SW: SEMCAD, V1.8 Build 165

**H Scan - Sensor Center 10mm above CD835 Dipole @ 813MHz/Hearing Aid Compatibility Test (41x361x1):**

Measurement grid: dx=5mm, dy=5mm

Maximum value of peak Total field = 0.468 A/m

Probe Modulation Factor = 1.00

Reference Value = 0.490 A/m; Power Drift = -0.009 dB

**Hearing Aid Near-Field Category: M4 (AWF 0 dB)**

Peak H-field in A/m

Grid 1	Grid 2	Grid 3
0.406	0.408	0.360
Grid 4	Grid 5	Grid 6
0.465	0.468	0.418
Grid 7	Grid 8	Grid 9
0.397	0.402	0.364

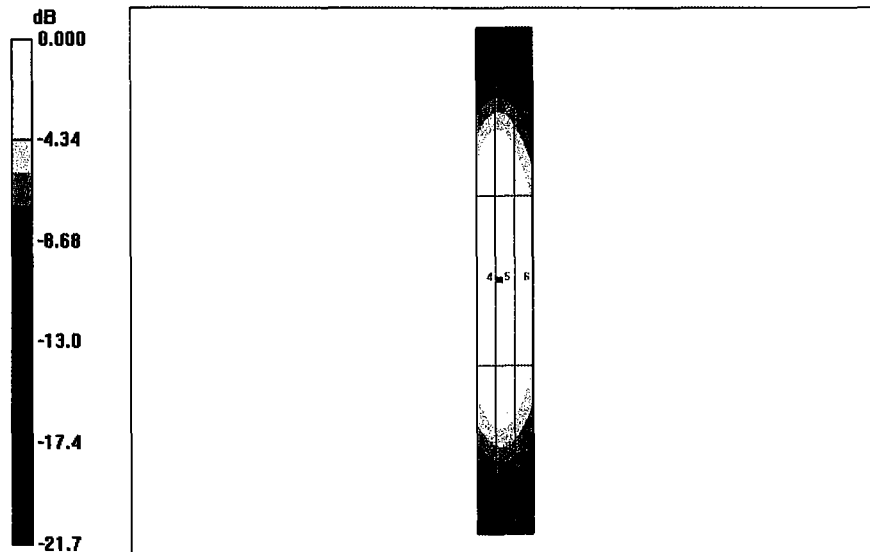

0 dB = 0.468A/m

**4.1.3 DASY4 E-field result**

Date/Time: 05.05.2006 15:50:29

Test Laboratory: SPEAG, Zurich, Switzerland

**DUT: HAC-Dipole 835 MHz; Type: D835V3; Serial: 1051**

Communication System: CW; Frequency: 813 MHz; Duty Cycle: 1:1

Medium: Air

Medium parameters used:  $\sigma = 0$  mho/m,  $\epsilon_r = 1$ ;  $\rho = 1000$  kg/m<sup>3</sup>

Phantom section: E Dipole Section

Measurement Standard: DASY4 (High Precision Assessment)

DASY4 Configuration:

- Probe: ER3DV6 - SN2336; ConvF(1, 1, 1); Calibrated: 20.12.2005
- Sensor-Surface: (Fix Surface)
- Electronics: DAE4 Sn660; Calibrated: 01.03.2006
- Phantom: HAC Test Arch 4.6; Type: SD HAC P01 BA
- Measurement SW: DASY4, V4.7 Build 21; Postprocessing SW: SEMCAD, V1.8 Build 165

**E Scan - Sensor Center 10mm above CD835 Dipole @ 813MHz/Hearing Aid Compatibility Test (41x361x1):**

Measurement grid: dx=5mm, dy=5mm

Maximum value of peak Total field = 173.5 V/m

Probe Modulation Factor = 1.00

Reference Value = 129.1 V/m; Power Drift = -0.002 dB

**Hearing Aid Near-Field Category: M4 (AWF 0 dB)**

Peak E-field in V/m

Grid 1	Grid 2	Grid 3
169.9	173.5	166.0
Grid 4	Grid 5	Grid 6
90.6	95.2	93.9
Grid 7	Grid 8	Grid 9
158.7	167.9	166.3

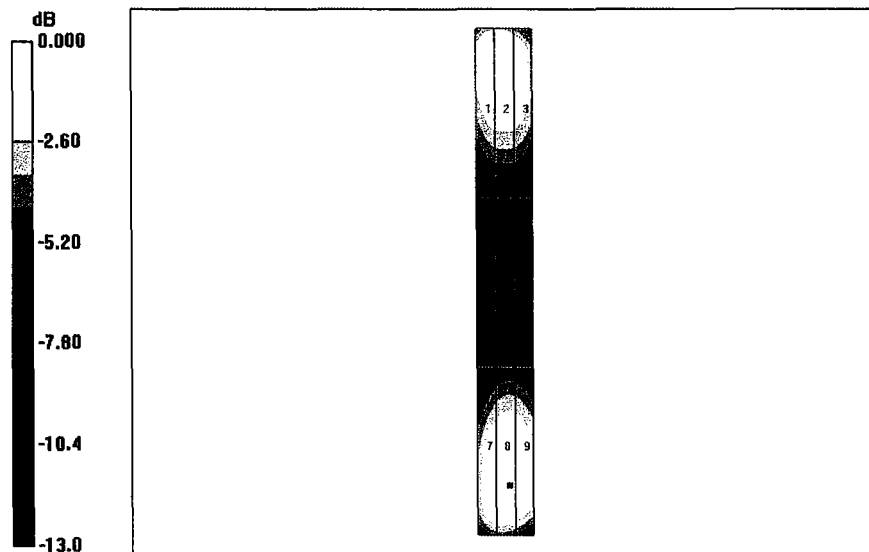

0 dB = 173.5V/m

## 4.2 Measurement Conditions

DASY system configuration, as far as not given on page 1.

<b>DASY Version</b>	DASY4	V4.7 B21
<b>DASY PP Version</b>	SEMCAD	V1.8 B165
<b>Phantom</b>	HAC Test Arch	SD HAC P01 BA, #1002
<b>Distance Dipole Top - Probe Center</b>	10 mm	
<b>Scan resolution</b>	dx, dy = 5 mm	area = 20 x 180 mm
<b>Frequency</b>	<b>898 MHz ± 1 MHz</b>	
<b>Forward power at dipole connector</b>	20.0 dBm = 100mW	
<b>Input power drift</b>	< 0.05 dB	

### 4.2.1 Maximum Field values

<b>H-field 10 mm above dipole surface</b>	condition	<b>interpolated maximum</b>
Maximum measured	100 mW forward power	<b>0.426 A/m</b>

Uncertainty for H-field measurement: 8.2% (k=2)

<b>E-field 10 mm above dipole surface</b>	condition	<b>Interpolated maximum</b>
Maximum measured above high end	100 mW forward power	155.6 V/m
Maximum measured above low end	100 mW forward power	151.7 V/m
Averaged maximum above arm	100 mW forward power	<b>153.7 V/m</b>

Uncertainty for E-field measurement: 12.8% (k=2)

## 4.2.2 DASY4 H-field result

Date/Time: 05.05.2006 14:09:15

Test Laboratory: SPEAG, Zurich, Switzerland

**DUT: HAC-Dipole 835 MHz; Type: D835V3; Serial: 1051**

Communication System: CW; Frequency: 898 MHz; Duty Cycle: 1:1

Medium: Air

Medium parameters used:  $\sigma = 0$  mho/m,  $\epsilon_r = 1$ ;  $\rho = 1$  kg/m<sup>3</sup>

Phantom section: H Dipole Section

Measurement Standard: DASY4 (High Precision Assessment)

DASY4 Configuration:

- Probe: H3DV6 - SN6065; Calibrated: 20.12.2005
- Sensor-Surface: (Fix Surface)
- Electronics: DAE4 Sn660; Calibrated: 01.03.2006
- Phantom: HAC Test Arch 4.6; Type: SD HAC P01 BA;
- Measurement SW: DASY4, V4.7 Build 21; Postprocessing SW: SEMCAD, V1.8 Build 165

**H Scan - Sensor Center 10mm above CD835 Dipole @ 898MHz/Hearing Aid Compatibility Test (41x361x1):**

Measurement grid: dx=5mm, dy=5mm

Maximum value of peak Total field = 0.426 A/m

Probe Modulation Factor = 1.00

Reference Value = 0.436 A/m; Power Drift = -0.001 dB

**Hearing Aid Near-Field Category: M4 (AWF 0 dB)**

Peak H-field in A/m

Grid 1	Grid 2	Grid 3
0.402	0.404	0.358
Grid 4	Grid 5	Grid 6
0.423	0.426	0.382
Grid 7	Grid 8	Grid 9
0.389	0.393	0.356

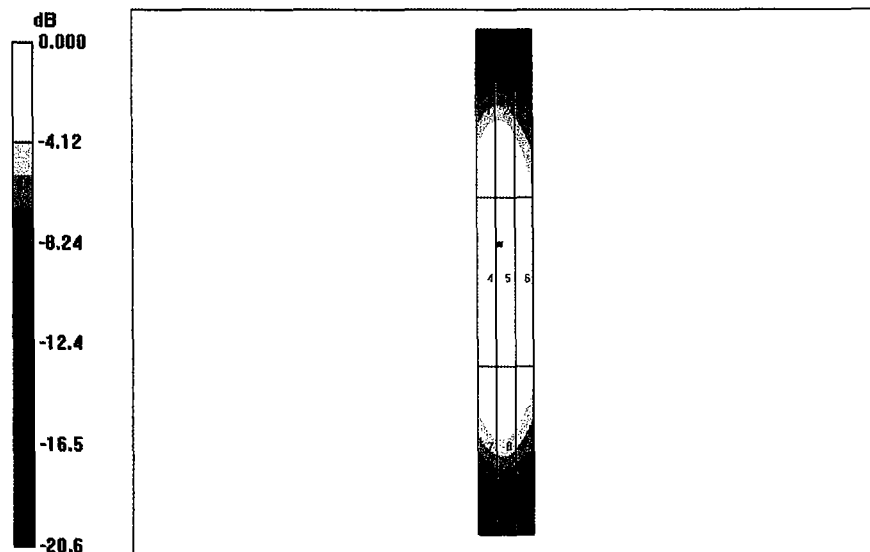

0 dB = 0.426A/m

### 4.2.3 DASY4 E-field result

Date/Time: 05.05.2006 17:50:52

Test Laboratory: SPEAG, Zurich, Switzerland

**DUT: HAC-Dipole 835 MHz; Type: D835V3; Serial: 1051**

Communication System: CW; Frequency: 835 MHz; Duty Cycle: 1:1

Medium: Air

Medium parameters used:  $\sigma = 0$  mho/m,  $\epsilon_r = 1$ ;  $\rho = 1000$  kg/m<sup>3</sup>

Phantom section: E Dipole Section

Measurement Standard: DASY4 (High Precision Assessment)

DASY4 Configuration:

- Probe: ER3DV6 - SN2336; ConvF(1, 1, 1); Calibrated: 20.12.2005
- Sensor-Surface: (Fix Surface)
- Electronics: DAE4 Sn660; Calibrated: 01.03.2006
- Phantom: HAC Test Arch 4.6; Type: SD HAC P01 BA
- Measurement SW: DASY4, V4.7 Build 21; Postprocessing SW: SEMCAD, V1.8 Build 165

**E Scan - Sensor Center 10mm above CD835 Dipole @ 898MHz/Hearing Aid Compatibility Test (41x361x1):**

Measurement grid: dx=5mm, dy=5mm

Maximum value of peak Total field = 155.6 V/m

Probe Modulation Factor = 1.00

Reference Value = 107.8 V/m; Power Drift = -0.008 dB

**Hearing Aid Near-Field Category: M4 (AWF 0 dB)**

Peak E-field in V/m

Grid 1	Grid 2	Grid 3
151.1	155.6	150.9
Grid 4	Grid 5	Grid 6
71.6	74.7	73.6
Grid 7	Grid 8	Grid 9
144.9	151.7	149.7

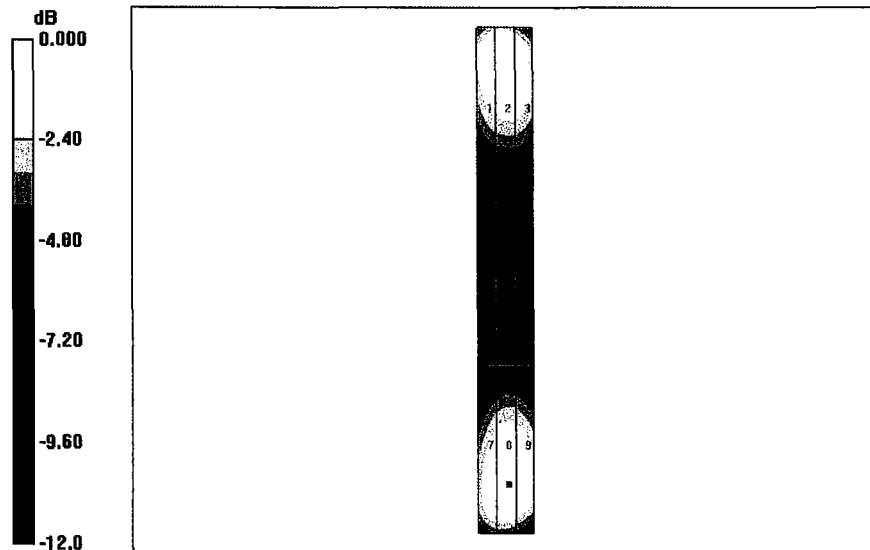

0 dB = 155.6V/m



Accredited by the Swiss Federal Office of Metrology and Accreditation  
The Swiss Accreditation Service is one of the signatories to the EA  
Multilateral Agreement for the recognition of calibration certificates

Accreditation No.: **SCS 108**

Client **Motorola MDb**

Certificate No: **CD1880V3-1043\_Nov05**

## CALIBRATION CERTIFICATE

Object **CD1880V3 - SN: 1043**

Calibration procedure(s) **QA CAL-20.v3  
Calibration procedure for dipoles in air**

Calibration date: **November 4, 2005**

Condition of the calibrated item **In Tolerance**

This calibration certificate documents the traceability to national standards, which realize the physical units of measurements (SI).  
The measurements and the uncertainties with confidence probability are given on the following pages and are part of the certificate.

All calibrations have been conducted in the closed laboratory facility: environment temperature (22 ± 3)°C and humidity < 70%.

Calibration Equipment used (M&TE critical for calibration)

Primary Standards	ID #	Cal Date (Calibrated by, Certificate No.)	Scheduled Calibration
Power meter EPM-442A	GB37480704	04-Oct-05 (METAS, No. 251-00516)	Oct-06
Power sensor HP 8481A	US37292783	04-Oct-05 (METAS, No. 251-00516)	Oct-06
20 dB Attenuator	SN: 5086 (20g)	11-Aug-05 (METAS, No 251-00498)	Aug-06
10 dB Attenuator	SN: 5047.2 (10r)	11-Aug-05 (METAS, No 251-00498)	Aug-06

Secondary Standards	ID #	Check Date (in house)	Scheduled Check
Power meter EPM-4419B	GB43310788	12-Aug-03 (SPEAG, in house check Oct-05)	In house check: Oct-06
Power sensor HP 8481A	MY41093312	10-Aug-03 (SPEAG, in house check Oct-05)	In house check: Oct-07
Power sensor HP 8481A	MY41093315	10-Aug-03 (SPEAG, in house check Oct-05)	In house check: Oct-06
Network Analyzer HP 8753E	US37390585	18-Oct-01 (SPEAG, in house check Nov-04)	In house check: Nov-05
RF generator R&S SMT06	SN: 100005	26-Jul-04 (SPEAG, in house check Jul-04)	In house check: Jan-06
DAE4	SN: 660	16-Dec-04 (SPEAG, No. DAE4-660_Dec04)	Calibration, Dec-05
Probe ER3DV6	SN: 2336	20-Jan-05 (SPEAG, No. ER3-2336_Jan05)	Calibration, Jan-06
Probe H3DV6	SN: 6065	10-Dec-04 (SPEAG, No. H3-6065-Dec04)	Calibration, Dec-05

Calibrated by: **Mike Meili**      Function: **Laboratory Technician**      Signature: *M. Meili*

Approved by: **Fin Bomholt**      Technical Director      *F. Bomholt*

Issued: December 9, 2005

This calibration certificate shall not be reproduced except in full without written approval of the laboratory.



Accredited by the Swiss Federal Office of Metrology and Accreditation  
The Swiss Accreditation Service is one of the signatories to the EA  
Multilateral Agreement for the recognition of calibration certificates

## References

- [1] ANSI-PC63.19-2001 (Draft 3.x, 2005)  
American National Standard for Methods of Measurement of Compatibility between Wireless Communications Devices and Hearing Aids.

## Methods Applied and Interpretation of Parameters:

- **Coordinate System:** y-axis is in the direction of the dipole arms. z-axis is from the basis of the antenna (mounted on the table) towards its feed point between the two dipole arms. x-axis is normal to the other axes. In coincidence with standard [1], the measurement planes (probe sensor center) are selected to be at a distance of 10 mm above the top edge of the dipole arms.
- **Measurement Conditions:** Further details are available from the hardcopies at the end of the certificate. All figures stated in the certificate are valid at the frequency indicated. The forward power to the dipole connector is set with a calibrated power meter connected and monitored with an auxiliary power meter connected to a directional coupler. While the dipole under test is connected, the forward power is adjusted to the same level.
- **Antenna Positioning:** The dipole is mounted on a HAC Test Arch phantom using the matching dipole positioner with the arms horizontal and the feeding cable coming from the floor. The measurements are performed in a shielded room with absorbers around the setup to reduce the reflections. It is verified before the mounting of the dipole under the Test Arch phantom, that its arms are perfectly in a line. It is installed on the HAC dipole positioner with its arms parallel below the dielectric reference wire and able to move elastically in vertical direction without changing its relative position to the top center of the Test Arch phantom. The vertical distance to the probe is adjusted after dipole mounting with a DASY4 Surface Check job. Before the measurement, the distance between phantom surface and probe tip is verified. The proper measurement distance is selected by choosing the matching section of the HAC Test Arch phantom with the proper device reference point (upper surface of the dipole) and the matching grid reference point (tip of the probe) considering the probe sensor offset. The vertical distance to the probe is essential for the accuracy.
- **Feed Point Impedance and Return Loss:** These parameters are measured using a HP 8753E Vector Network Analyzer. The impedance is specified at the SMA connector of the dipole. The influence of reflections was eliminating by applying the averaging function while moving the dipole in the air, at least 70cm away from any obstacles.
- **E-field distribution:** E field is measured in the x-y-plane with an isotropic ER3D-field probe with 100 mW forward power to the antenna feed point. In accordance with [1], the scan area is 20mm wide, its length exceeds the dipole arm length (180 or 90mm). The sensor center is 10 mm (in z) above the top of the dipole arms. Two 3D maxima are available near the end of the dipole arms. Assuming the dipole arms are perfectly in one line, the average of these two maxima (in subgrid 2 and subgrid 8) is determined to compensate for any non-parallelity to the measurement plane as well as the sensor displacement. The E-field value stated as calibration value represents the maximum of the interpolated 3D-E-field, 10mm above the dipole surface.
- **H-field distribution:** H-field is measured with an isotropic H-field probe with 100mW forward power to the antenna feed point, in the x-y-plane. The scan area and sensor distance is equivalent to the E-field scan. The maximum of the field is available at the center (subgrid 5) above the feed point. The H-field value stated as calibration value represents the maximum of the interpolated H-field, 10mm above the dipole surface at the feed point.

## 1 Measurement Conditions

DASY system configuration, as far as not given on page 1.

<b>DASY Version</b>	DASY4	V4.6 B23
<b>DASY PP Version</b>	SEMCAD	V1.8 B160
<b>Phantom</b>	HAC Test Arch	SD HAC P01 BA, #1002
<b>Distance Dipole Top - Probe Center</b>	10 mm	
<b>Scan resolution</b>	dx, dy = 5 mm	area = 20 x 90 mm
<b>Frequency</b>	1880 MHz $\pm$ 1 MHz	
<b>Forward power at dipole connector</b>	20.0 dBm = 100mW	
<b>Input power drift</b>	< 0.05 dB	

## 2 Maximum Field values

<b>H-field 10 mm above dipole surface</b>	<b>condition</b>	<b>interpolated maximum</b>
Maximum measured	100 mW forward power	<b>0.447 A/m</b>

Uncertainty for H-field measurement: 8.2% (k=2)

<b>E-field 10 mm above dipole surface</b>	<b>condition</b>	<b>Interpolated maximum</b>
Maximum measured above high end	100 mW forward power	134.6 V/m
Maximum measured above low end	100 mW forward power	132.4 V/m
Averaged maximum above arm	100 mW forward power	<b>133.5 V/m</b>

Uncertainty for E-field measurement: 12.8% (k=2)

## 3 Appendix

### 3.1 Antenna Parameters

<b>Frequency</b>	<b>Return Loss</b>	<b>Impedance</b>
1710 MHz	19.7 dB	( 57.8 + j8.0 ) Ohm
<b>1880 MHz</b>	<b>23.2 dB</b>	<b>( 57.1 + j2.0 ) Ohm</b>
1900 MHz	23.5 dB	( 57.2 - j0.4 ) Ohm
1950 MHz	27.7 dB	( 49.6 - j4.1 ) Ohm
2000 MHz	19.1 dB	( 42.8 + j7.4 ) Ohm

### 3.2 Antenna Design and Handling

The calibration dipole has a symmetric geometry with a built-in two stub matching network, which leads to the enhanced bandwidth.

The dipole is built of standard semirigid coaxial cable. The internal matching line is open ended. The antenna is therefore open for DC signals.

Do not apply force to dipole arms, as they are liable to bend. The soldered connections near the feedpoint may be damaged. After excessive mechanical stress or overheating, check the impedance characteristics to ensure that the internal matching network is not affected.

After long term use with 40W radiated power, only a slight warming of the dipole near the feedpoint can be measured.

### 3.3 Measurement Sheets

#### 3.3.1 Return Loss and Smith Chart

2 Nov 2005 11:42:43

CH1 S11 L06 5 dB/REF -18 dB 2:-23.217 dB 1 880.000 000 MHz

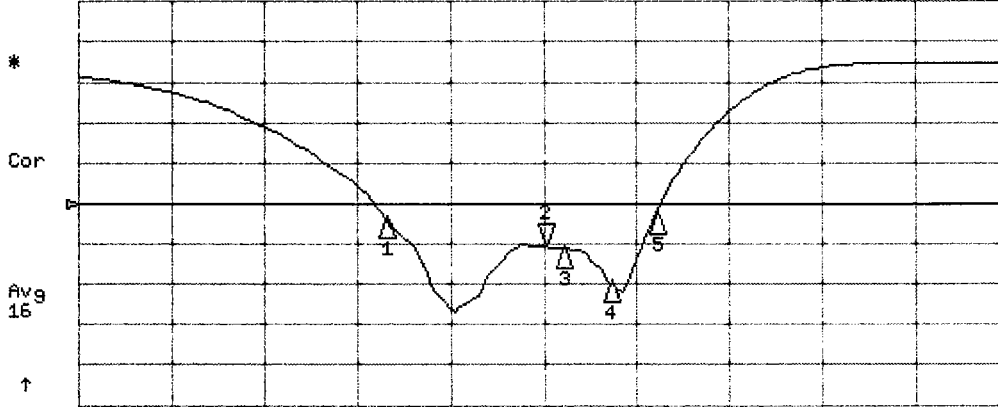

CH1 Markers

- 1:-19.695 dB  
1.71000 GHz
- 3:-23.454 dB  
1.90000 GHz
- 4:-27.674 dB  
1.95000 GHz
- 5:-19.123 dB  
2.00000 GHz

CH2 S11 1 U FS 2: 57.119 Ω 1.9922 Ω 158.65 pH 1 880.000 000 MHz

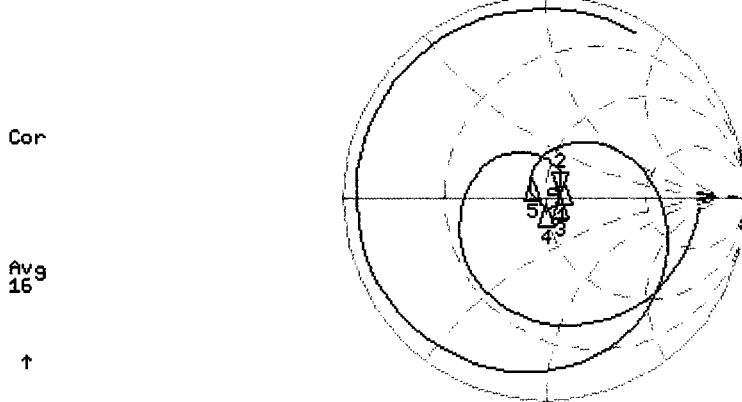

CH2 Markers

- 1: 57.791 Ω  
8.0391 Ω  
1.71000 GHz
- 3: 57.189 Ω  
-421.88 mΩ  
1.90000 GHz
- 4: 49.555 Ω  
-4.0918 Ω  
1.95000 GHz
- 5: 42.826 Ω  
7.3945 Ω  
2.00000 GHz

CENTER 1 880.000 000 MHz

SPAN 1 000.000 000 MHz

### 3.3.2 DASY4 H-field result

Date/Time: 11/4/2005 10:48:04 AM

Test Laboratory: SPEAG, Zurich, Switzerland

**DUT: HAC Dipole 1880 MHz; Type: CD1880V3; Serial: 1043**

Communication System: CW; Frequency: 1880 MHz; Duty Cycle: 1:1

Medium: Air

Medium parameters used:  $\sigma = 0$  mho/m,  $\epsilon_r = 1$ ;  $\rho = 1$  kg/m<sup>3</sup>

Phantom section: H Dipole Section

DASY4 Configuration:

- Probe: H3DV6 - SN6065; Calibrated: 12/10/2004
- Sensor-Surface: (Fix Surface)
- Electronics: DAE4 Sn660; Calibrated: 12/16/2004
- Phantom: HAC Test Arch; Type: SD HAC P01 BA; Serial: 1002
- Measurement SW: DASY4, V4.6 Build 23; Postprocessing SW: SEMCAD, V1.8 Build 160

**H Scan 10mm above CD1880V3/Hearing Aid Compatibility Test (41x181x1):**

Measurement grid: dx=5mm, dy=5mm

Maximum value of peak Total field = 0.447 A/m

Probe Modulation Factor = 1.00

Reference Value = 0.138 A/m; Power Drift = -0.028 dB

**Hearing Aid Near-Field Category: M2 (AWF 0 dB)**

Peak H-field in A/m

Grid 1	Grid 2	Grid 3
0.390	0.418	0.403
Grid 4	Grid 5	Grid 6
0.421	0.447	0.433
Grid 7	Grid 8	Grid 9
0.382	0.405	0.392

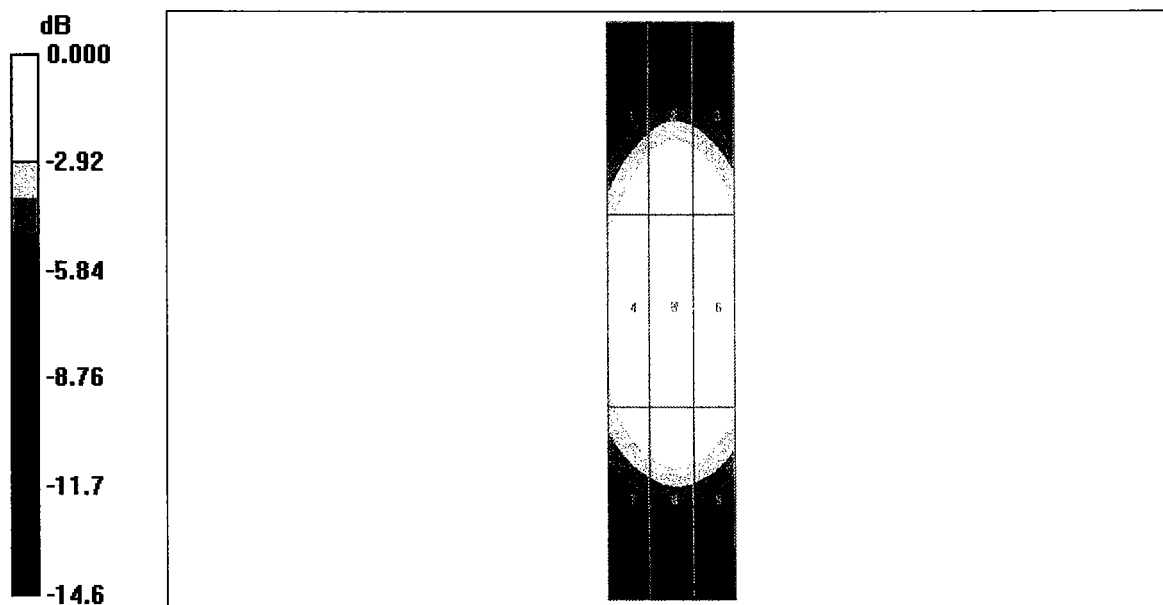

0 dB = 0.447A/m

### 3.3.3 DASY4 E-Field result

Date/Time: 11/4/2005 3:37:47 PM

Test Laboratory: SPEAG, Zurich, Switzerland

**DUT: HAC Dipole 1880 MHz; Type: CD1880V3; Serial: 1043**

Communication System: CW; Frequency: 1880 MHz; Duty Cycle: 1:1

Medium: Air

Medium parameters used:  $\sigma = 0$  mho/m,  $\epsilon_r = 1$ ;  $\rho = 1000$  kg/m<sup>3</sup>

Phantom section: E Dipole Section

DASY4 Configuration:

- Probe: ER3DV6 - SN2336; ConvF(1, 1, 1); Calibrated: 1/20/2005
- Sensor-Surface: (Fix Surface)
- Electronics: DAE4 Sn660; Calibrated: 12/16/2004
- Phantom: HAC Test Arch; Type: SD HAC P01 BA; Serial: 1002
- Measurement SW: DASY4, V4.6 Build 23; Postprocessing SW: SEMCAD, V1.8 Build 160

**E Scan 10mm above CD1880V3/Hearing Aid Compatibility Test (41x181x1):**

Measurement grid: dx=5mm, dy=5mm

Maximum value of peak Total field = 134.6 V/m

Probe Modulation Factor = 1.00

Reference Value = 149.4 V/m; Power Drift = 0.013 dB

**Hearing Aid Near-Field Category: M2 (AWF 0 dB)**

Peak E-field in V/m

Grid 1	Grid 2	Grid 3
127.1	132.4	130.9
Grid 4	Grid 5	Grid 6
85.0	87.5	85.0
Grid 7	Grid 8	Grid 9
128.3	134.6	131.5

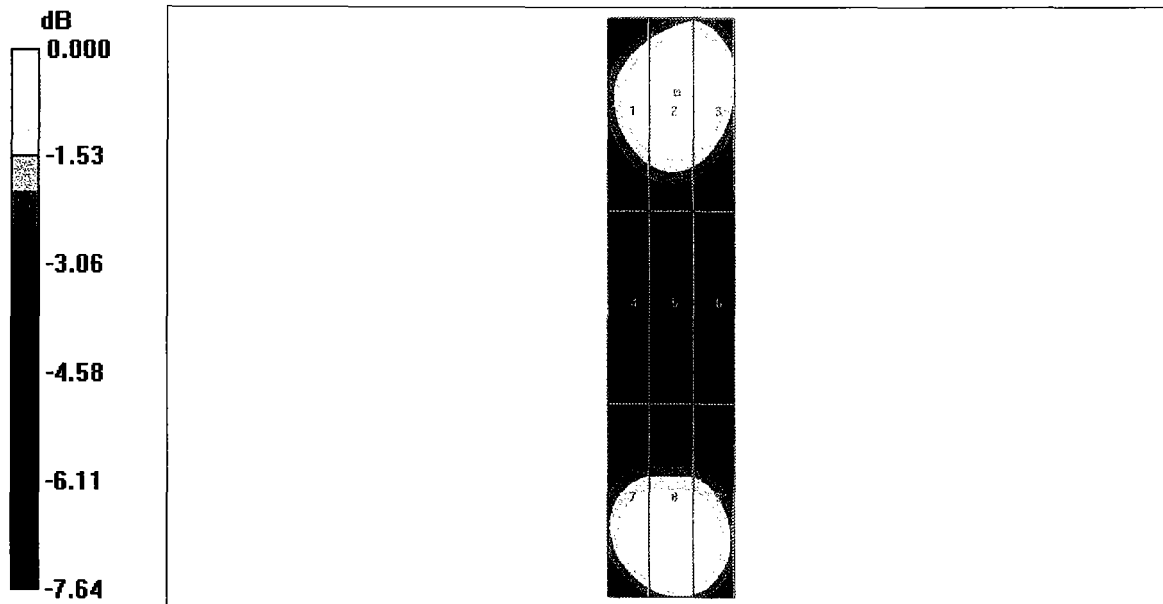

0 dB = 134.6V/m