



MOTOROLA

Exhibit 11: SAR Test Report IHDT56EQ1

Date of test: 02/12/2004 to 02/24/2004
Date of Report: 02/25/2004

Laboratory: Motorola Personal Communications Sector Product Safety & Compliance Laboratory
600 N. US Highway 45
Room: MW113
Libertyville, Illinois 60048

Test Responsible: Albert Patapack
Senior Staff Engineer

Accreditation: This laboratory is accredited to ISO/IEC 17025-1999 to perform the following tests:



Tests:
Electromagnetic Specific Absorption Rate

Procedures:
ANSI/IEEE C95.1-1992, 1999
(SAR) IEEE C95.3-1991
IEEE P1528 (*DRAFT*)
FCC OET Bulletin 65 (*including Supplements A, B, C*)
Australian Communications Authority Radio
Communications (Electromagnetic Radiation – Human
Exposure) Standard 1999
CENELEC EN 50361 (2001)
APP-0247
DOI-0876, 0900, 0902, 0904, 0915

Simulated Tissue Preparation
RF Power Measurement

On the following products or types of products:
Wireless Communications Devices (Examples): Two Way Radios; Portable Phones (including Cellular, Licensed Non-Broadcast and PCS); Low Frequency Readers; and Pagers

A2LA certificate #1651-01

Statement of Compliance:

Motorola declares under its sole responsibility that portable cellular telephone FCC ID IHDT56EQ1 to which this declaration relates, is in conformity with the appropriate General Population/Uncontrolled RF exposure standards, recommendations and guidelines (FCC 47 CFR §2.1093). It also declares that the product was tested in accordance with the appropriate measurement standards, guidelines and recommended practices. Any deviations from these standards, guidelines and recommended practices are noted below:

(none)

©Motorola, Inc. 2003

This test report shall not be reproduced except in full, without written approval of the laboratory.

The results and statements contained herein relate only to the items tested. The names of individuals involved may be mentioned only in connection with the statements or results from this report.

Motorola encourages all feedback, both positive and negative, on this test report.

Table of Contents

1. INTRODUCTION3

2. DESCRIPTION OF THE DEVICE UNDER TEST3

2.1 Antenna description 3

2.2 Device description 3

3. TEST EQUIPMENT USED4

3.1 Dosimetric System..... 4

3.2 Additional Equipment 4

4. ELECTRICAL PARAMETERS OF THE TISSUE SIMULATING LIQUID4

5. SYSTEM ACCURACY VERIFICATION5

6. TEST RESULTS6

6.1 Head Adjacent Test Results 7

6.2 Body Worn Test Results..... 9

APPENDIX 1: SAR DISTRIBUTION COMPARISON FOR SYSTEM ACCURACY VERIFICATION11

APPENDIX 2: SAR DISTRIBUTION PLOTS FOR PHANTOM HEAD ADJACENT USE.....12

APPENDIX 3: SAR DISTRIBUTION PLOTS FOR BODY WORN CONFIGURATION17

APPENDIX 4: PROBE CALIBRATION CERTIFICATE.....20

APPENDIX 5: DIPOLE CHARACTERIZATION CERTIFICATE21

APPENDIX 6: MEASUREMENT UNCERTAINTY BUDGET22

APPENDIX 7: PHOTOGRAPHS OF DEVICE UNDER TEST25

1. Introduction

The Motorola Personal Communications Sector Product Safety Laboratory has performed measurements of the maximum potential exposure to the user of portable cellular phone (FCC ID IHDT56EQ1). The Specific Absorption Rate (SAR) of this product was measured. The portable cellular phone was tested in accordance with FCC OET Bulletin 65 Supplement C 01-01.

2. Description of the Device Under Test

a. Antenna description

Type	Internal Antenna	
Location	Back of Phone	
Dimensions	Length	25mm
	Width	35mm

b. Device description

FCC ID Number	IHDT56EQ1							
Serial number	S50U31224X, S50U31224Z, S50U31224F & S50U3124QF							
Mode(s) of Operation	GSM 850	GSM 900	GSM 1800	GSM 1900	GPRS 850	GPRS 900	GPRS 1800	GPRS 1900
Modulation Mode(s)	GSM	GSM	GSM	GSM	GSM	GSM	GSM	GSM
Maximum Output Power Setting	33.00 dBm	32.50 dBm	30.00 dBm	30.00 dBm	33.00 dBm	32.50 dBm	30.00 dBm	30.00 dBm
Duty Cycle	1:08	1:08	1:08	1:08	2:08	2:08	2:08	2:08
Transmitting Frequency Rang(s)	824.2-848.8 MHz	880.2-914.8 MHz	1710.2-1784.8 MHz	1850.2 – 1909.8 Mhz	824.2-848.8 MHz	880.2-914.8 MHz	1710.2-1784.8 MHz	1850.2 – 1909.8 MHz
Production Unit or Identical Prototype (47 CFR §2.908)	Identical Prototype							
Device Category	Portable							
RF Exposure Limits	General Population / Uncontrolled							

3. Test Equipment Used

3.1 Dosimetric System

The Motorola Personal Communications Sector Product Safety & Compliance Laboratory utilizes a Dosimetric Assessment System (Dasy3™ v3.1d) manufactured by Schmid & Partner Engineering AG (SPEAG™), of Zurich Switzerland. All the SAR measurements are taken within a shielded enclosure. The overall RSS uncertainty of the measurement system is ±11.7% (K=1) with an expanded uncertainty of ±23.0% (K=2). The measurement uncertainty budget is given in Appendix 6. Per IEEE 1528, this uncertainty budget is applicable to the SAR range of 0.4 W/kg to 10 W/kg. The list of calibrated equipment used for the measurements is shown below.

Description	Serial Number	Cal Due Date
DASY3 DAE V1	375	11/25/04
E-Field Probe ET3DV6	1522	03/21/04
E-Field Probe ET3DV6	1514	07/31/04
Dipole Validation Kit, D900V2	78	06/24/04
S.A.M. Phantom used for 800MHz	TP-1106	
Dipole Validation Kit, D1800V2	273tr	06/24/04
S.A.M. Phantom used for 1900MHz	TP-1235	

3.2 Additional Equipment

Description	Serial Number	Cal Due Date
Signal Generator HP8648C	3847A04845	11/05/04
	3847A04822	02/06/05
Power Meter E4419B	US39250622	01/08/05
	GB39511088	05/18/04
Power Sensor #1 - E9301A	US39210918	08/05/04
	US39210915	08/05/04
Power Sensor #2 - E9301A	US39210917	08/05/04
	US29211009	08/05/04
Network Analyzer HP8753ES	US39171846	06/03/04
Dielectric Probe Kit HP85070B	US99360074	N/A

4. Electrical parameters of the tissue simulating liquid

Prior to conducting SAR measurements, the relative permittivity, ϵ_r , and the conductivity, σ , of the tissue simulating liquids were measured with the HP85070 Dielectric Probe Kit. These values, along with the temperature of the tissue simulate are shown in the table below. The recommended limits for maximum permittivity and minimum conductivity are also shown. These come from the Federal Communication Commission, OET Bulletin 65 Supplement C 01-01. It is seen that the measured parameters are satisfactory for compliance testing.

f (MHz)	Tissue type	Limits / Measured	Dielectric Parameters		
			ϵ_r	σ (S/m)	Temp (°C)
850	Head	Measured, 02/12/04	42.9	0.93	19.3
		Recommended Limits	41.5 ±5%	0.90 ±5%	18-25
	Body	Measured, 02/13/04	53.5	0.97	19.1
		Measured, 02/14/04	53.2	0.97	19.6
		Measured, 02/24/04	54.5	0.98	20.3
		Recommended Limits	55.2 ±5%	0.97 ±5%	18-25
1900	Head	Measured, 02/14/04	38.6	1.45	18.4
		Recommended Limits	40.0 ±5%	1.40 ±5%	18-25
	Body	Measured, 02/14/04	50.8	1.59	18.8
		Measured, 02/15/04	50.8	1.59	18.8
		Measured, 02/24/04	51.4	1.58	19.2
		Recommended Limits	53.3 ±5%	1.52 ±5%	18-25

The list of ingredients and the percent composition used for the tissue simulates are indicated in the table below.

Ingredient	800MHz Head	800MHz Body	1900MHz Head	1900MHz Body
Sugar	57.0	44.9	--	30.80
DGBE	--	--	47.0	--
Water	40.45	53.06	52.8	68.91
Salt	1.45	0.94	0.2	0.29
HEC	1.0	1.0	--	--
Bact.	0.1	0.1	--	--

5. System Accuracy Verification

A system accuracy verification of the DASY3 was performed using the measurement equipment listed in Section 3.1. The daily system accuracy verification occurs within center section of the SAM phantom.

A SAR measurement was performed to see if the measured SAR was within +/- 10% from the target SAR indicated on the dipole certification sheet. These tests were done at 900MHz and/or 1800MHz. These frequencies are within 100MHz of the mid-band frequency of the test device. This is within the allowable window given in Supplement C 01-01 *Appendix D System Verification* section item #5. The test was conducted on the same days as the measurement of the DUT. Recommended limits for maximum permittivity, minimum conductivity are shown in the table below. These come from the Federal Communication Commission, OET Bulletin 65 Supplement C 01-01. The obtained results from the system accuracy verification are displayed in the table below. The distributions of SAR compare well with those of the reference measurements (see Appendix 1). The tissue stimulant depth was verified to be 15.0cm ±0.5cm. Z-axis scans showing the SAR penetration are also included in Appendix 1. SAR values are normalized to 1W forward power delivered to the dipole.

f (MHz)	Description	SAR (W/kg), 1gram	Dielectric Parameters		Ambient Temp (°C)	Tissue Temp (°C)
			ϵ_r	σ (S/m)		
900	Measured, 02/12/04	11.31	42.0	0.99	20.0	19.7
	Measured, 02/13/04	11.62	41.6	0.98	20.0	19.6
	Measured, 02/14/04	11.30	41.6	0.98	20.0	19.5
	Measured, 02/24/04	11.00	41.4	0.96	20.0	20.2
	Recommended Limits	11.6	41.5 ±5%	0.97 ±5%	18-25	18-25
1800	Measured, 02/14/04	40.45	38.9	1.36	20.0	19.2
	Measured, 02/15/04	40.00	38.8	1.37	20.0	18.9
	Measured, 02/24/04	40.80	39.7	1.36	20.0	19.5
	Recommended Limits	39.7	40.0 ±5%	1.4 ±5%	18-25	18-25

The following probe conversion factors were used on the E-Field probe(s) used for the system accuracy verification measurements:

Description	Serial Number	f (MHz)	Conversion Factor	Cal Cert pg #
E-Field Probe ET3DV6	SN1522	900	4.7	2 of 10
		1800	3.4	2 of 10

6. Test Results

The test sample was operated in a test mode that allows control of the transmitter without the need to place actual phone calls. For the purposes of this test the unit is commanded to test mode and manually set to the proper channel, transmitter power level and transmit mode of operation. The phone was tested in the configurations stipulated in OET Bulletin 65 Supplement C 01-01. Motorola also followed the requirements in Supplement. C / Appendix D: SAR Measurement Procedures, section titled “Devices Operating Next To A Person’s Ear “. These directions state “The device should be tested on the left and right side of the head phantom in the “Cheek/Touch” and “Ear/Tilt” positions. When applicable, each configuration should be tested with the antenna in its fully extended and fully retracted positions. These test configurations should be tested at the high, middle and low frequency channels of each operating mode; for example, AMPS, CDMA, and TDMA. If the SAR measured at the middle channel for each test configuration (left, right, Cheek/Touch, Tile/Ear, extended and retracted) is at least 2.0 dB lower than the SAR limit, testing at the high and low channels is optional for such test configuration(s).“

The DASY v3.1d SAR measurement system specified in section 3.1 was utilized within the intended operations as set by the SPEAG™ setup. The phone was positioned into the measurement configurations using the positioner supplied with the DASY 3.1d SAR measurement system. The measured dielectric constant of the material used for the positioner is less than 2.9 and the loss tangent is less than 0.02 (± 30%) at 850MHz. The default settings for the “coarse” and “cube” scans were chosen and use for measurements. The grid spacing of the course scan was set to 15cm as shown in the SAR plots included in appendix 2 and 3. Please refer to the DASY manual for additional information on SAR scanning procedures and algorithms used.

The Cellular Phone (FCC ID IHDT56EQ1) has the following battery option: AAHN4285A - 820mAH Battery This battery was used to do all of the SAR testing. The phone was placed in the SAR measurement system with battery fully charged.

6.1 Head Adjacent Test Results

To aid in positioning repeatability, the ear reference line of the device and the axis reference line of the device have been physically added using a non-metallic marker.

- Per Figure 1, the "Ear Reference Line" is centered vertically through the center of the listening area (as defined by the speaker holes in the housing).
- The "Axis Reference Line" bisects the front surface of the device at its top and bottom edges.
- The intersection of these two lines defines the location of the "Ear Reference Point".

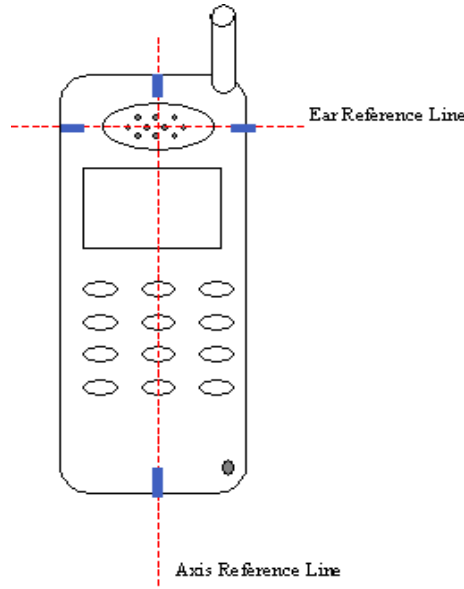

The lines drawn on the device extended to the outside edges, as shown in blue in the figure below, & wrap around the sides of the device.

The SAR results shown in tables 1 through 4 are maximum SAR values averaged over 1 gram of phantom tissue. Also shown are the measured conducted output powers, the temperature of the test facility during the test, the temperature of the tissue simulate after the test, the measured drift and the extrapolated SAR. The exact method of extrapolation is $New\ SAR = Old\ SAR * 10^{(-drift/10)}$. The SAR reported at the end of the measurement process by the DASY™ measurement system can be scaled up by the measured drift to determine the SAR at the beginning of the measurement process. This is the most conservative SAR because it corresponds to the average output power at the beginning of the SAR test. This extrapolation has been done because when the DUT is operating properly it may exhibit a slump in radiated power and SAR over time. This is verified by measuring the SAR drift after the test. The test conditions indicated as bold numbers in the following table are included in Appendix 2

The SAR measurements were performed using the SAM phantoms listed in section 3.1. Since same phantoms and tissue simulate are used for the system accuracy verification as the device SAR measurements, the Z-axis scans included in within Appendix 1 are applicable for verification of tissue simulate depth to be 15.0cm ±0.5cm. All other test conditions measured lower SAR values than those included in Appendix 2. Note that 800MHz digital mode SAR measurements were performed in accordance with Supplement C.

The following probe conversion factors were used on the E-Field probe(s) used for the head adjacent measurements:

Description	Serial Number	f (MHz)	Conversion Factor	Cal Cert pg #
E-Field Probe ET3DV6	SN1522	835	4.7	7 of 10
		1900	3.4	7 of 10

f (MHz)	Description	Conducted Output Power (dBm)	Left Head (Cheek / Touch Position)			
			Ant Fixed			
			Measured (W/kg)	Drift (dB)	Extrapolated (W/kg)	Simulate Temp (°C)
Digital 850MHz	Channel 128	33.00	0.915	-0.36	0.99	19.3
	Channel 190	33.00	1.11	-0.04	1.12	19.4
	Channel 251	33.00	1.06	-0.08	1.08	19.4
Digital 1900MHz	Channel 512	30.00				
	Channel 661	30.00	0.396	0.13	0.40	18.4
	Channel 810	30.00				

Table 1: SAR measurement results for the portable cellular telephone FCC ID IHDT56EQ1 at highest possible output power. Measured against the left head in the Cheek/Touch Position.

f (MHz)	Description	Conducted Output Power (dBm)	Right Head (Cheek / Touch Position)			
			Ant Fixed			
			Measured (W/kg)	Drift (dB)	Extrapolated (W/kg)	Simulate Temp (°C)
Digital 850MHz	Channel 128	33.00	0.921	-0.04	0.93	19.3
	Channel 190	33.00	1.15	-0.2	1.20	19.3
	Channel 251	33.00	1.14	-0.01	1.14	19.3
Digital 1900MHz	Channel 512	30.00				
	Channel 661	30.00	0.559	-0.1	0.57	18.5
	Channel 810	30.00				

Table 2: SAR measurement results for the portable cellular telephone FCC ID IHDT56EQ1 at highest possible output power. Measured against the right head in the Cheek/Touch Position.

f (MHz)	Description	Conducted Output Power (dBm)	Left Head (15° Tilt Position)			
			Ant Fixed			
			Measured (W/kg)	Drift (dB)	Extrapolated (W/kg)	Simulate Temp (°C)
Digital 850MHz	Channel 128	33.00				
	Channel 190	33.00	0.65	-0.01	0.65	19.3
	Channel 251	33.00				
Digital 1900MHz	Channel 512	30.00				
	Channel 661	30.00	0.437	-0.06	0.44	18.4
	Channel 810	30.00				

Table 3: SAR measurement results for the portable cellular telephone FCC ID IHDT56EQ1 at highest possible output power. Measured against the left head in the 15° Tilt Position.

f (MHz)	Description	Conducted Output Power (dBm)	Right Head (15° Tilt Position)			
			Ant Fixed			
			Measured (W/kg)	Drift (dB)	Extrapolated (W/kg)	Simulate Temp (°C)
Digital 850MHz	Channel 128	33.00				
	Channel 190	33.00	0.756	-0.03	0.76	19.3
	Channel 251	33.00				
Digital 1900MHz	Channel 512	30.00				
	Channel 661	30.00	0.579	-0.07	0.59	18.5
	Channel 810	30.00				

Table 4: SAR measurement results for the portable cellular telephone FCC ID IHDT56EQ1 at highest possible output power. Measured against the right head in the 15° Tilt Position.

6.2 Body Worn Test Results

The SAR results shown in table 5 and 6 are the maximum SAR values averaged over 1 gram of phantom tissue. Also shown are the measured conducted output powers, the temperature of the test facility during the test, the temperature of the tissue simulate after the test, the measured drift and the extrapolated SAR. The exact method of extrapolation is $New\ SAR = Old\ SAR * 10^{(-drift/10)}$. The SAR reported at the end of the measurement process by the DASY™ measurement system can be scaled up by the measured drift to determine the SAR at the beginning of the measurement process. This is the most conservative SAR because it corresponds to the average output power at the beginning of the SAR test. This extrapolation has been done because when the DUT is operating properly it may exhibit a slump in radiated power and SAR over time. This is verified by measuring the SAR drift after the test. The test conditions indicated as bold numbers in the following table are included in Appendix 3. Note that 800MHz digital mode SAR measurements were performed in accordance with OET Bulletin 65 Supplement C 01-01. All other test conditions measured lower SAR values than those included in Appendix 3.

A “flat” phantom was for the body-worn tests. This “flat” phantom is made out of 1” thick natural High Density Polyethylene with a thickness at the bottom equal to 2.0mm. It measures 52.7cm(long) x 26.7cm(wide) x 21.2cm(tall). The measured dielectric constant of the material used is less than 2.3 and the loss tangent is less than 0.0046 all the way up to 2.184GHz.

The tissue stimulant depth was verified to be 15.0cm ±0.5cm. The same device holder described in section 6 was used for positioning the phone. There are no Body-Worn Accessories available for this phone at the time of testing hence the device was tested per the supplement C testing guidelines for devices that do not have body worn accessories. The phone was placed a maximum of 1 inch away from a flat phantom per the supplement C standard guidelines to perform SAR measurement. The cellular phone was tested with a headset connected to the device for all body-worn SAR measurements

The following probe conversion factors were used on the E-Field probe(s) used for the body worn measurements:

Description	Serial Number	f (MHz)	Conversion Factor	Cal Cert pg #
E-Field Probe ET3DV6	SN1522	835	4.4	8 of 10
		1900	3.1	8 of 10
	SN1514	900	6.1	8 of 11
		1800	4.7	8 of 11

f (MHz)	Description	Conducted Output Power (dBm)	Body Worn							
			Front of phone 15 mm away from phantom				Back of phone 15 mm away from phantom			
			Measured (W/kg)	Drift (dB)	Extrapolated (W/kg)	Simulate Temp (°C)	Measured (W/kg)	Drift (dB)	Extrapolated (W/kg)	Simulate Temp (°C)
Digital 850MHz	Channel 128	33.00								
	Channel 190	33.00	0.146	0.02	0.15	19.1	0.215	-0.03	0.22	19.6
	Channel 251	33.00								
Digital 1900MHz	Channel 512	30.00								
	Channel 661	30.00	0.0518	0.17	0.05	18.8	0.458	-0.03	0.46	18.8
	Channel 810	30.00								

Table 5: SAR measurement results for the portable cellular telephone FCC ID IHDT56EQ1 at highest possible output power. Measured against the body.

f (MHz)	Description	Conducted Output Power (dBm)	Body Worn with GPRS Class 10 Back of phone 1in away from phantom			
			Measured (W/kg)	Drift (dB)	Extrapolated (W/kg)	Simulate Temp (°C)
Digital 850MHz	Channel 128	33.00	0.818	-0.09	0.84	20.3
	Channel 190	33.00	0.782	-0.12	0.80	20.3
	Channel 251	33.00	0.775	-0.12	0.80	18.9
Digital 1900MHz	Channel 512	30.00				
	Channel 661	30.00	0.463	-0.04	0.47	19.2
	Channel 810	30.00				

Table 6: SAR measurement results for the portable cellular telephone FCC ID IHDT56EQ1 at highest possible output power. Measured against the body.

Appendix 1

SAR distribution comparison for the system accuracy verification

Dipole 900 MHz

900 MHz System Performance Check / Dipole Sn# 78

Forward Power = 252mW Reflected Power = -21.20db

Room Temp at time of measurement = 20C. Simulant Temp at time of measurement = 19.7C.

R# 2 TP-1106 SUGAR SAM Expanded (Rev. 2)-9Jan03 Phantom; Flat Section; Position: (90°,90°); Frequency: 900 MHz

Probe: ET3DV6 - SN1522 - Validation2; ConvF(4.70,4.70,4.70); Crest factor: 1.0; 900 MHz VALIDATION: $\sigma = 0.99$ mho/m $\epsilon_r = 42.0$ $\rho = 1.00$ g/cm³Cubes (2): SAR (1g): 2.85 mW/g \pm 0.16 dB, SAR (10g): 1.80 mW/g \pm 0.15 dB, (Worst-case extrapolation)

Coarse: Dx = 15.0, Dy = 15.0, Dz = 10.0

Penetration depth: 11.4 (10.6, 12.6) [mm]

Powerdrift: 0.06 dB

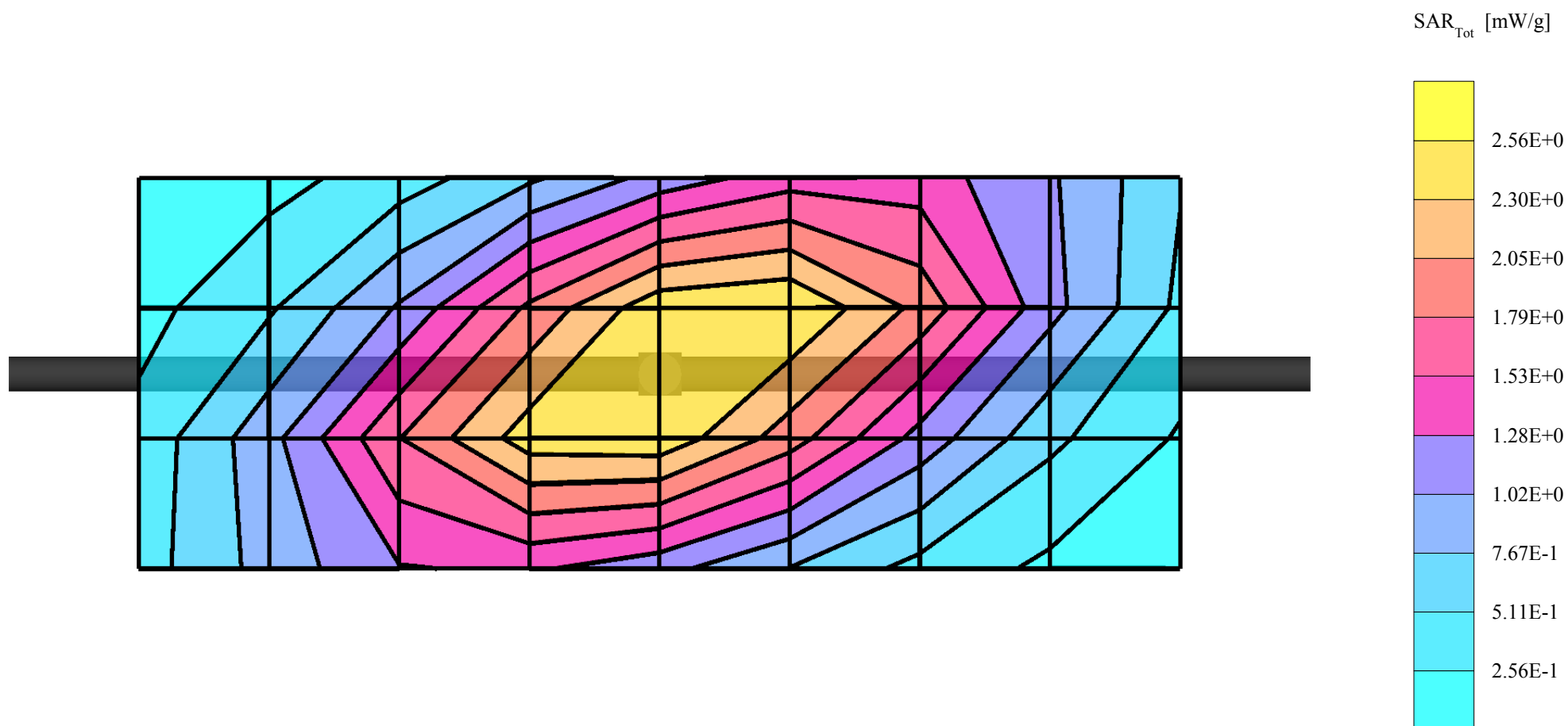

Dipole 900 MHz

900 MHz System Performance Check / Dipole Sn# 78

Forward Power = 252mW Reflected Power = -21.20db

Room Temp at time of measurement = 20C. Simulant Temp at time of measurement = 19.7C.

R# 2 TP-1106 SUGAR SAM Expanded (Rev. 2)-9Jan03 Phantom; Section; Position: ; Frequency: 900 MHz

Probe: ET3DV6 - SN1522 - Validation2; ConvF(4.70,4.70,4.70); Crest factor: 1.0; 900 MHz VALIDATION: $\sigma = 0.99$ mho/m $\epsilon_r = 42.0$ $\rho = 1.00$ g/cm³

:, ()

Z-Axis: Dx = 0.0, Dy = 0.0, Dz = 5.0

Penetration depth: 11.4 (10.7, 12.5) [mm]

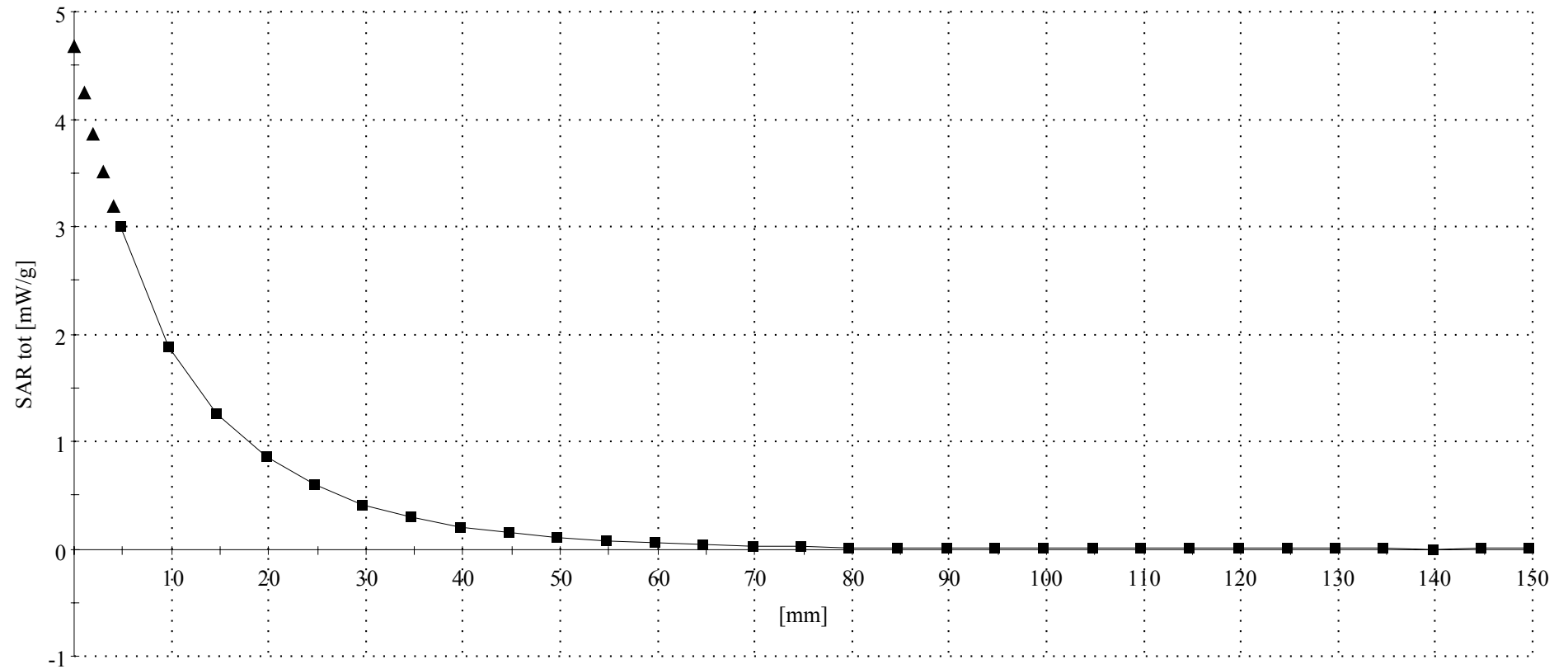

Dipole 900 MHz

900 MHz System Performance Check / Dipole Sn# 78

Forward Power = 252m/w Reflected Power = -21.05db

Room Temp at time of measurement = 20c Simulant Temp at time of measurement = 19.6c

R# 2 TP-1106 SUGAR SAM Expanded (Rev. 2)-9Jan03 Phantom; Flat Section; Position: (90°,90°); Frequency: 900 MHz

Probe: ET3DV6 - SN1522 - Validation2; ConvF(4.70,4.70,4.70); Crest factor: 1.0; 900 MHz VALIDATION: $\sigma = 0.98$ mho/m $\epsilon_r = 41.6$ $\rho = 1.00$ g/cm³

Cubes (2): SAR (1g): 2.93 mW/g ± 0.10 dB, SAR (10g): 1.85 mW/g ± 0.09 dB, (Worst-case extrapolation)

Coarse: Dx = 15.0, Dy = 15.0, Dz = 10.0

Penetration depth: 11.5 (10.7, 12.6) [mm]

Powerdrift: 0.08 dB

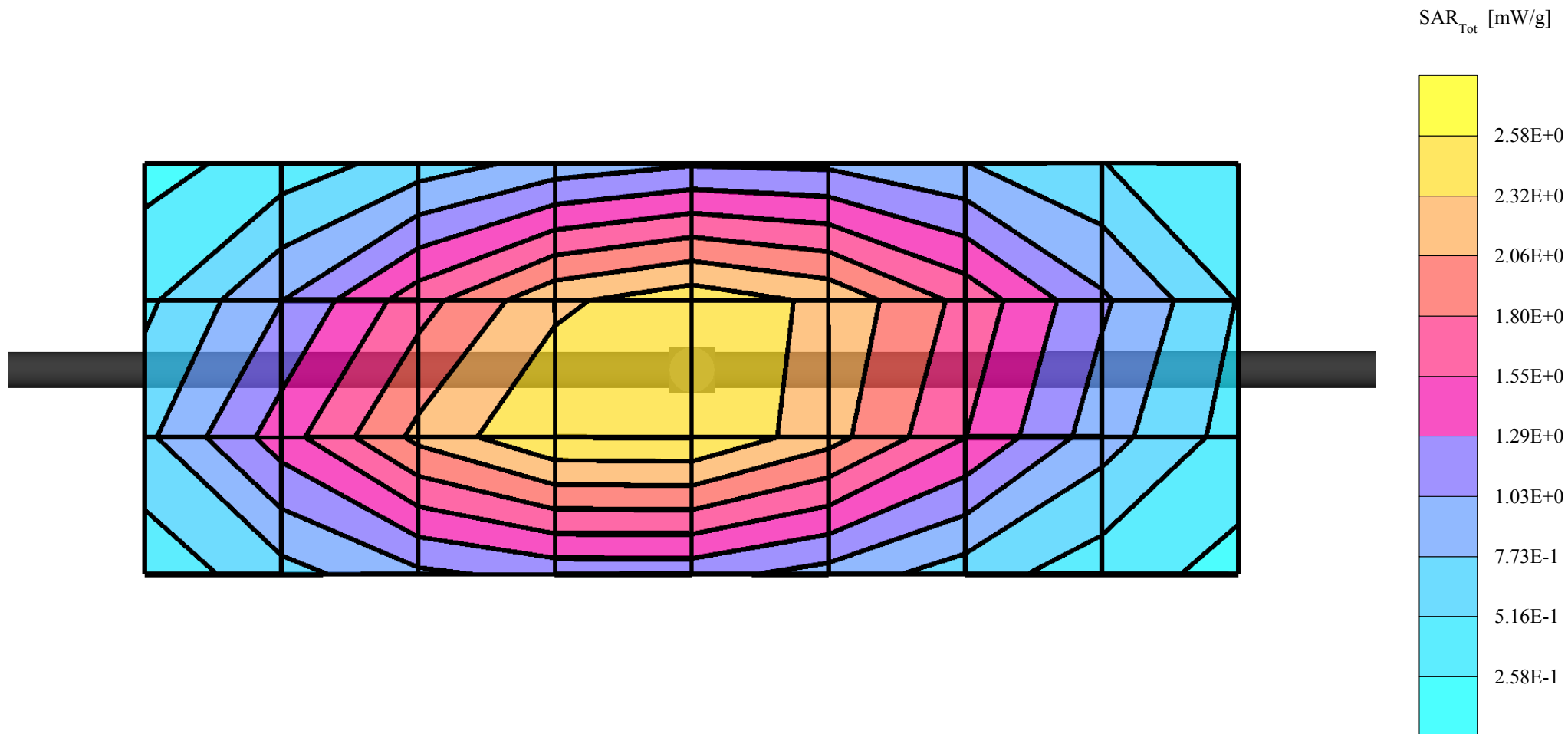

Dipole 900 MHz

900 MHz System Performance Check / Dipole Sn# 78

Forward Power = 252m/w Reflected Power = -21.05db

Room Temp at time of measurement = 20c Simulant Temp at time of measurement = 19.6c

R# 2 TP-1106 SUGAR SAM Expanded (Rev. 2)-9Jan03 Phantom; Section; Position: ; Frequency: 900 MHz

Probe: ET3DV6 - SN1522 - Validation2; ConvF(4.70,4.70,4.70); Crest factor: 1.0; 900 MHz VALIDATION: $\sigma = 0.98$ mho/m $\epsilon_r = 41.6$ $\rho = 1.00$ g/cm³

; , ()

Z-Axis: Dx = 0.0, Dy = 0.0, Dz = 5.0

Penetration depth: 11.4 (10.5, 12.6) [mm]

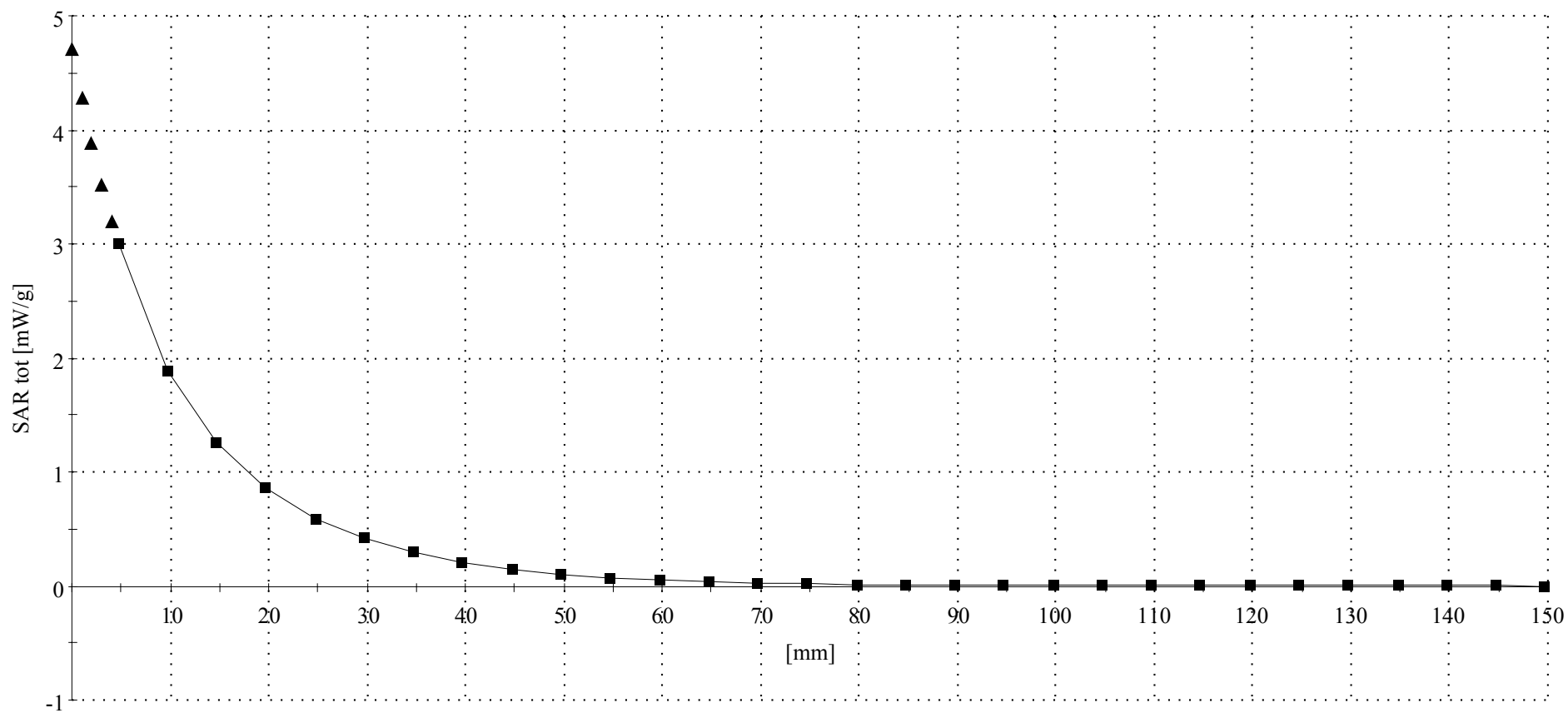

Dipole 900 MHz

900 MHz System Performance Check / Dipole Sn# 078

Forward Power = 250mw Reflected Power = -21.9db

Room Temp at time of measurement = 20*C Simulant Temp at time of measurement = 19.5*C

R# 2 TP-1106 SUGAR SAM Expanded (Rev. 2)-9Jan03 Phantom; Flat Section; Position: (90°,90°); Frequency: 900 MHz

Probe: ET3DV6 - SN1522 - Validation2; ConvF(4.70,4.70,4.70); Crest factor: 1.0; 900 MHz VALIDATION: $\sigma = 0.98$ mho/m $\epsilon_r = 41.6$ $\rho = 1.00$ g/cm³

Cubes (2): SAR (1g): 2.83 mW/g ± 0.09 dB, SAR (10g): 1.79 mW/g ± 0.09 dB, (Worst-case extrapolation)

Coarse: Dx = 15.0, Dy = 15.0, Dz = 10.0

Penetration depth: 11.6 (10.7, 12.7) [mm]

Powerdrift: 0.04 dB

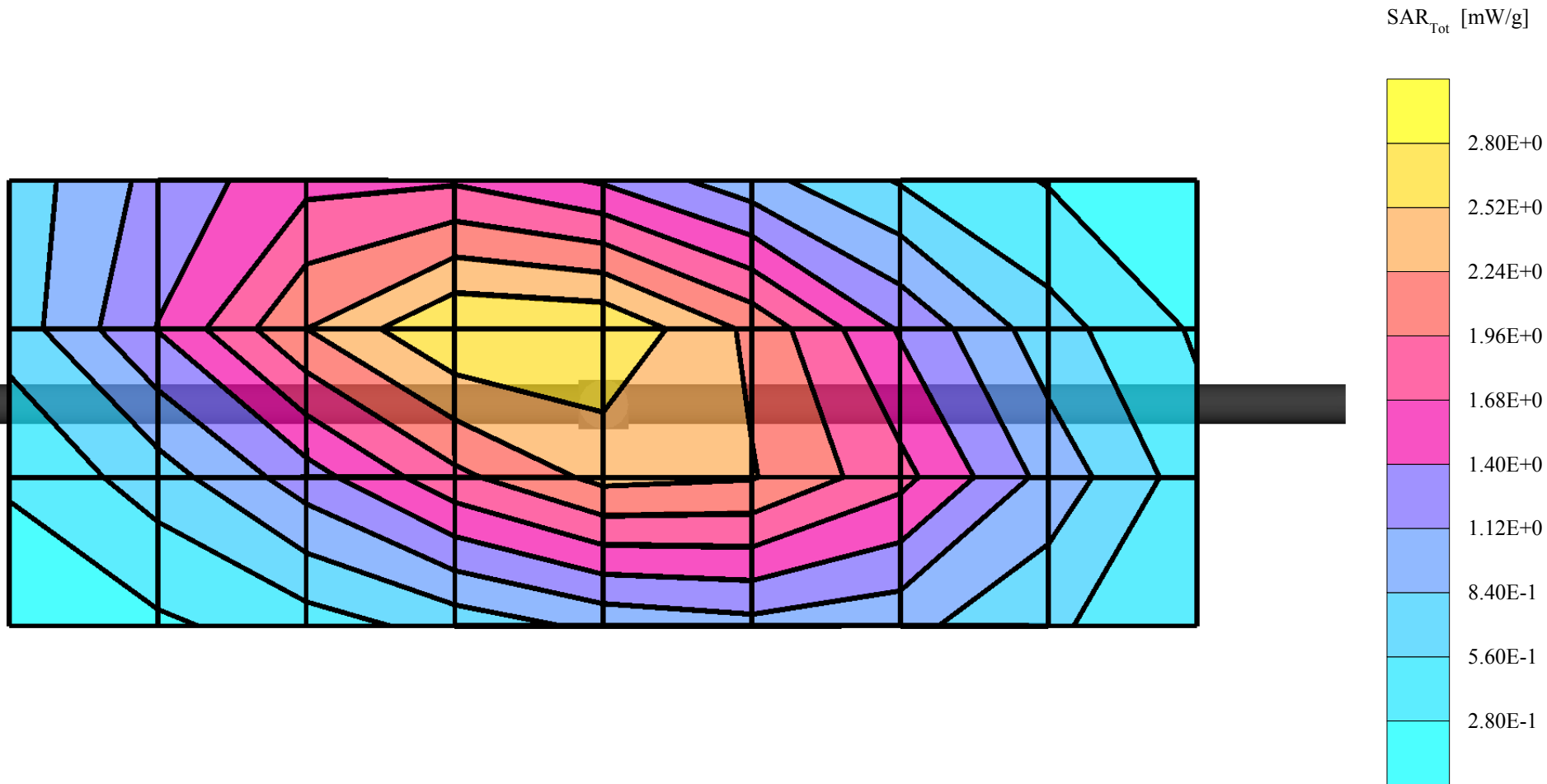

Dipole 900 MHz

900 MHz System Performance Check / Dipole Sn# 078

Forward Power = 250mw Reflected Power = -21.9db

Room Temp at time of measurement = 20*C Simulant Temp at time of measurement = 19.5*C

R# 2 TP-1106 SUGAR SAM Expanded (Rev. 2)-9Jan03 Phantom; Section; Position: ; Frequency: 900 MHz

Probe: ET3DV6 - SN1522 - Validation2; ConvF(4.70,4.70,4.70); Crest factor: 1.0; 900 MHz VALIDATION: $\sigma = 0.98$ mho/m $\epsilon_r = 41.6$ $\rho = 1.00$ g/cm³

; , ()

Z-Axis: Dx = 0.0, Dy = 0.0, Dz = 5.0

Penetration depth: 11.4 (10.5, 12.6) [mm]

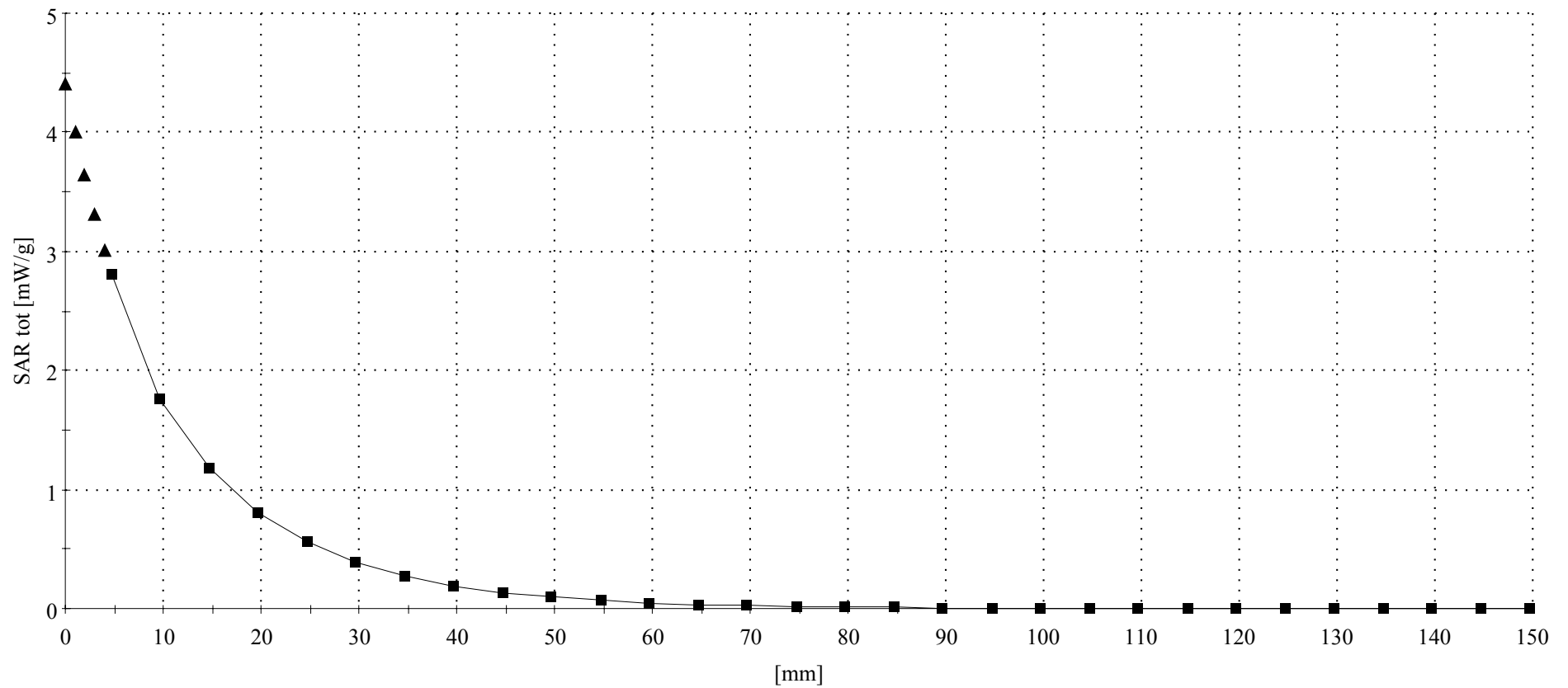

Dipole 1800 MHz

1800 MHz System Performance Check / Dipole Sn# 273tr

Forward Power = 247mw Reflected Power = -21.7db

Room Temp at time of measurement = 20°C Simulant Temp at time of measurement = 19.2°C

R# 2 TP-1235 GLYCOL SAM Expanded (Rev. 2)-9Jan03 Phantom; Flat Section; Position: (90°,90°); Frequency: 1800 MHz

Probe: ET3DV6 - SN1522 - Validation2; ConvF(3.40,3.40,3.40); Crest factor: 1.0; 1800 MHz VALIDATION: $\sigma = 1.36$ mho/m $\epsilon_r = 38.9$ $\rho = 1.00$ g/cm³

Cubes (2): SAR (1g): 9.99 mW/g \pm 0.03 dB, SAR (10g): 5.30 mW/g \pm 0.04 dB, (Worst-case extrapolation)

Coarse: Dx = 15.0, Dy = 15.0, Dz = 10.0

Penetration depth: 8.4 (8.1, 9.2) [mm]

Powerdrift: 0.02 dB

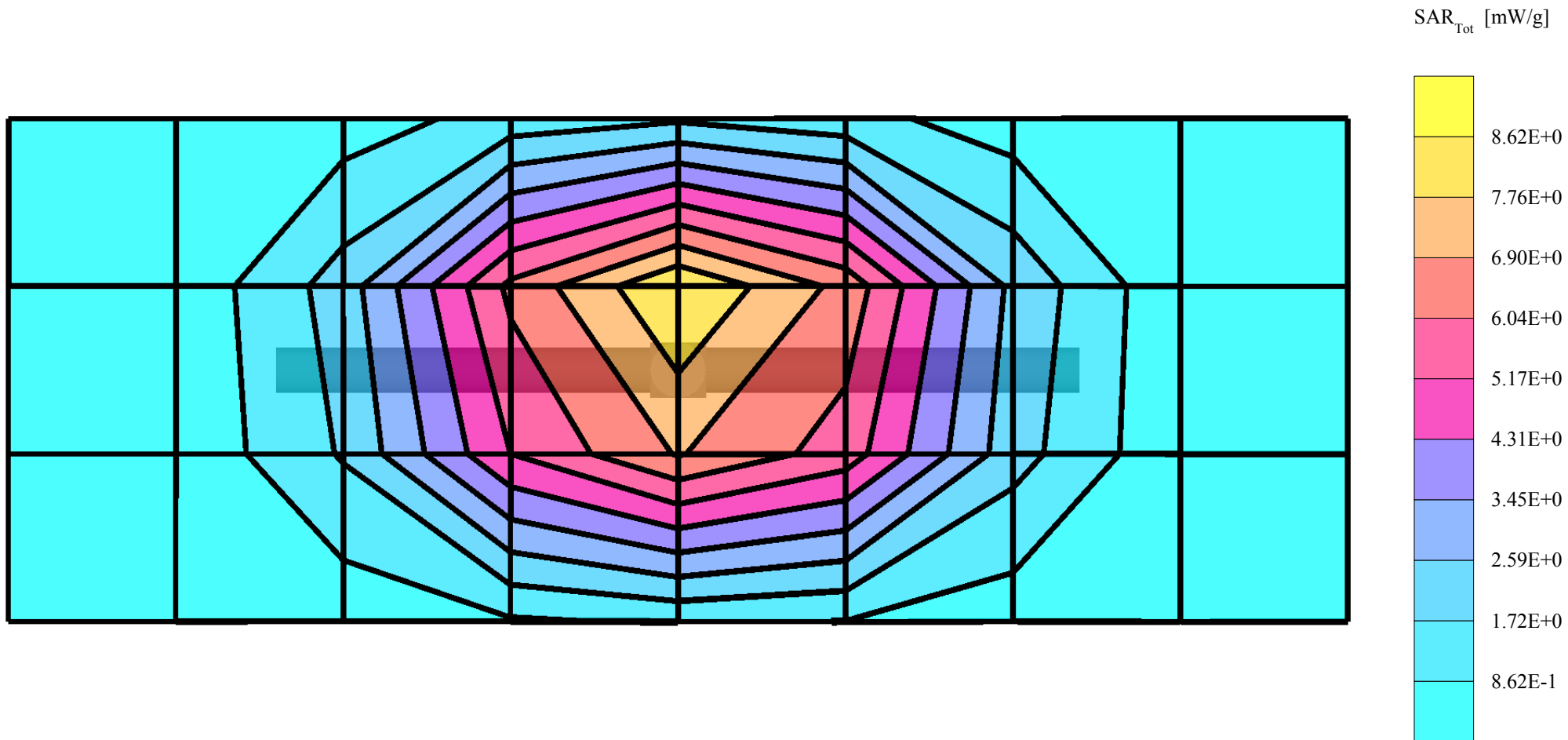

Dipole 1800 MHz

1800 MHz System Performance Check / Dipole Sn# 273tr

Forward Power = 247mw Reflected Power = -21.7db

Room Temp at time of measurement = 20*C Simulant Temp at time of measurement = 19.2*C

R# 2 TP-1235 GLYCOL SAM Expanded (Rev. 2)-9Jan03 Phantom; Section; Position: ; Frequency: 1800 MHz

Probe: ET3DV6 - SN1522 - Validation2; ConvF(3.40,3.40,3.40); Crest factor: 1.0; 1800 MHz VALIDATION: $\sigma = 1.36$ mho/m $\epsilon_r = 38.9$ $\rho = 1.00$ g/cm³

; , ()

Z-Axis: Dx = 0.0, Dy = 0.0, Dz = 5.0

Penetration depth: 8.2 (7.9, 9.1) [mm]

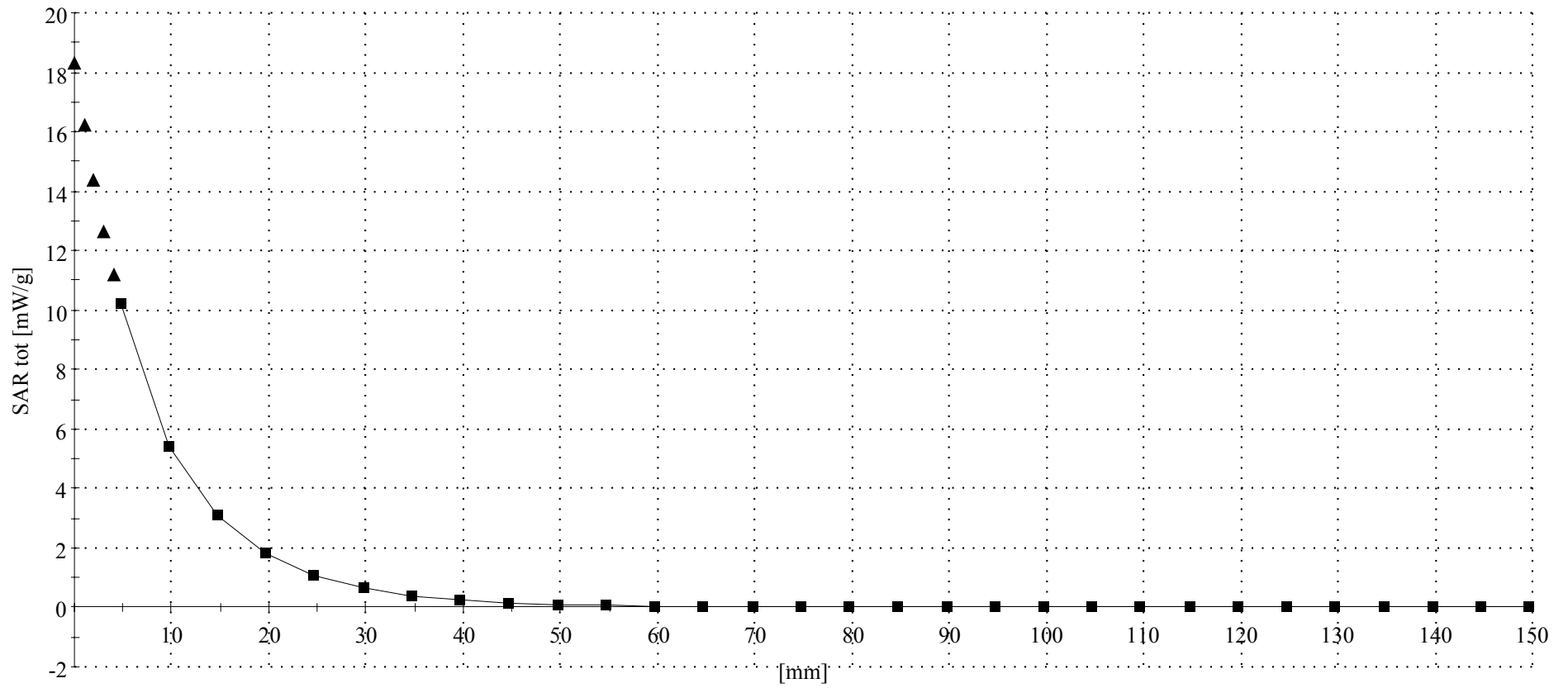

Dipole 1800 MHz

1800 MHz System Performance Check / Dipole Sn# 273tr

PM1 Power = 200mW

Refl.Pwr PM3= -21.12dB

Room Temp at time of measurement = 20°C Simulant Temp at time of measurement = 18.9°C

R# 2 TP-1235 GLYCOL SAM Expanded (Rev. 2)-9Jan03 Phantom; Flat Section; Position: (90°,90°); Frequency: 1800 MHz

Probe: ET3DV6 - SN1522 - Validation2; ConvF(3.40,3.40,3.40); Crest factor: 1.0; 1800 MHz VALIDATION: $\sigma = 1.37$ mho/m $\epsilon_r = 38.8$ $\rho = 1.00$ g/cm³

Cubes (2): SAR (1g): 8.00 mW/g ± 0.04 dB, SAR (10g): 4.23 mW/g ± 0.04 dB, (Worst-case extrapolation)

Coarse: Dx = 15.0, Dy = 15.0, Dz = 10.0

Penetration depth: 8.3 (8.0, 9.1) [mm]

Powerdrift: 0.03 dB

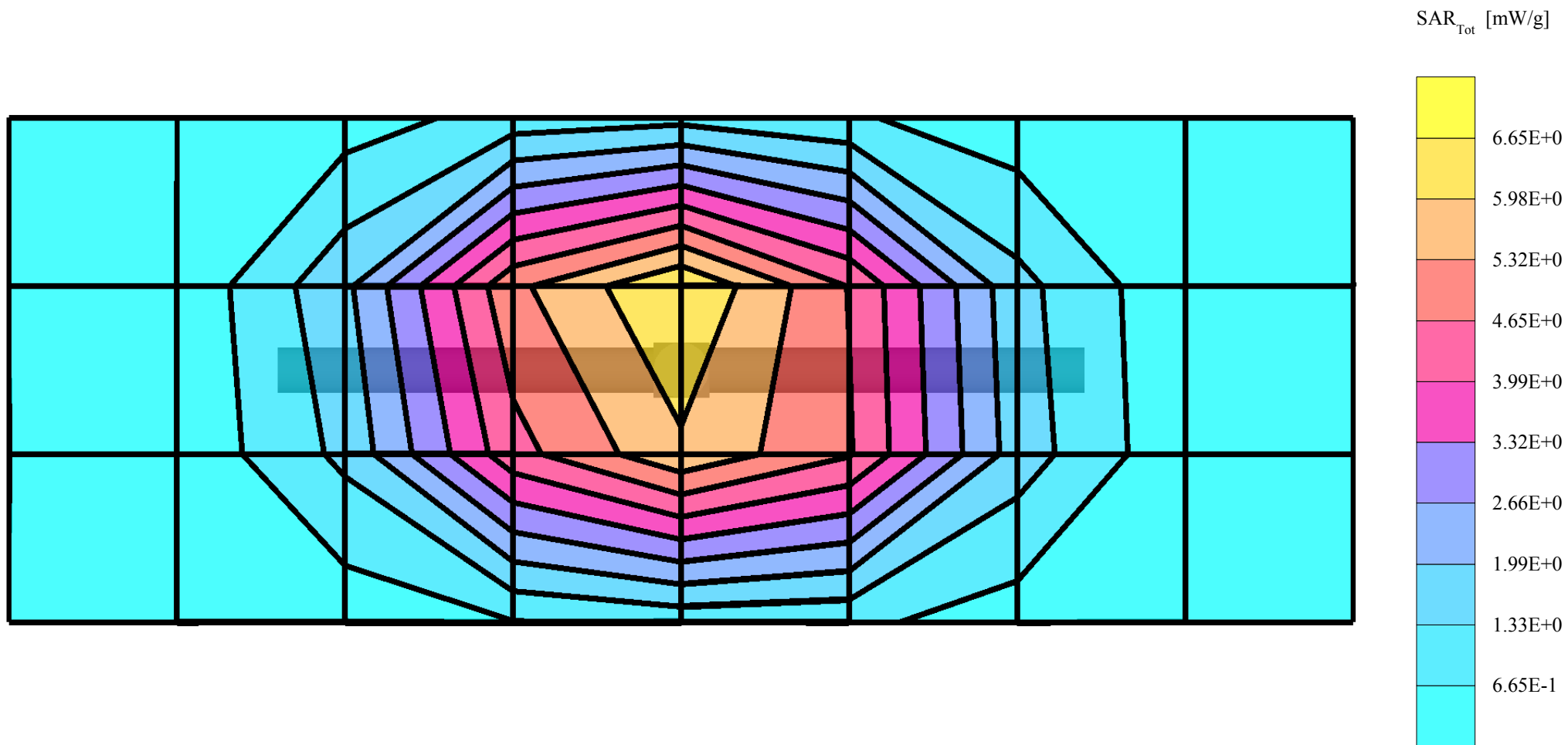

Dipole 1800 MHz

1800 MHz System Performance Check / Dipole Sn# 273tr

PM1 Power = 200mW Refl.Pwr PM3= -21.12dB

Room Temp at time of measurement = 20°C Simulant Temp at time of measurement = 18.9°C

R# 2 TP-1235 GLYCOL SAM Expanded (Rev. 2)-9Jan03 Phantom; Section; Position: ; Frequency: 1800 MHz

Probe: ET3DV6 - SN1522 - Validation2; ConvF(3.40,3.40,3.40); Crest factor: 1.0; 1800 MHz VALIDATION: $\sigma = 1.37$ mho/m $\epsilon_r = 38.8$ $\rho = 1.00$ g/cm³

: , ()

Z-Axis: Dx = 0.0, Dy = 0.0, Dz = 5.0

Penetration depth: 8.3 (7.9, 9.1) [mm]

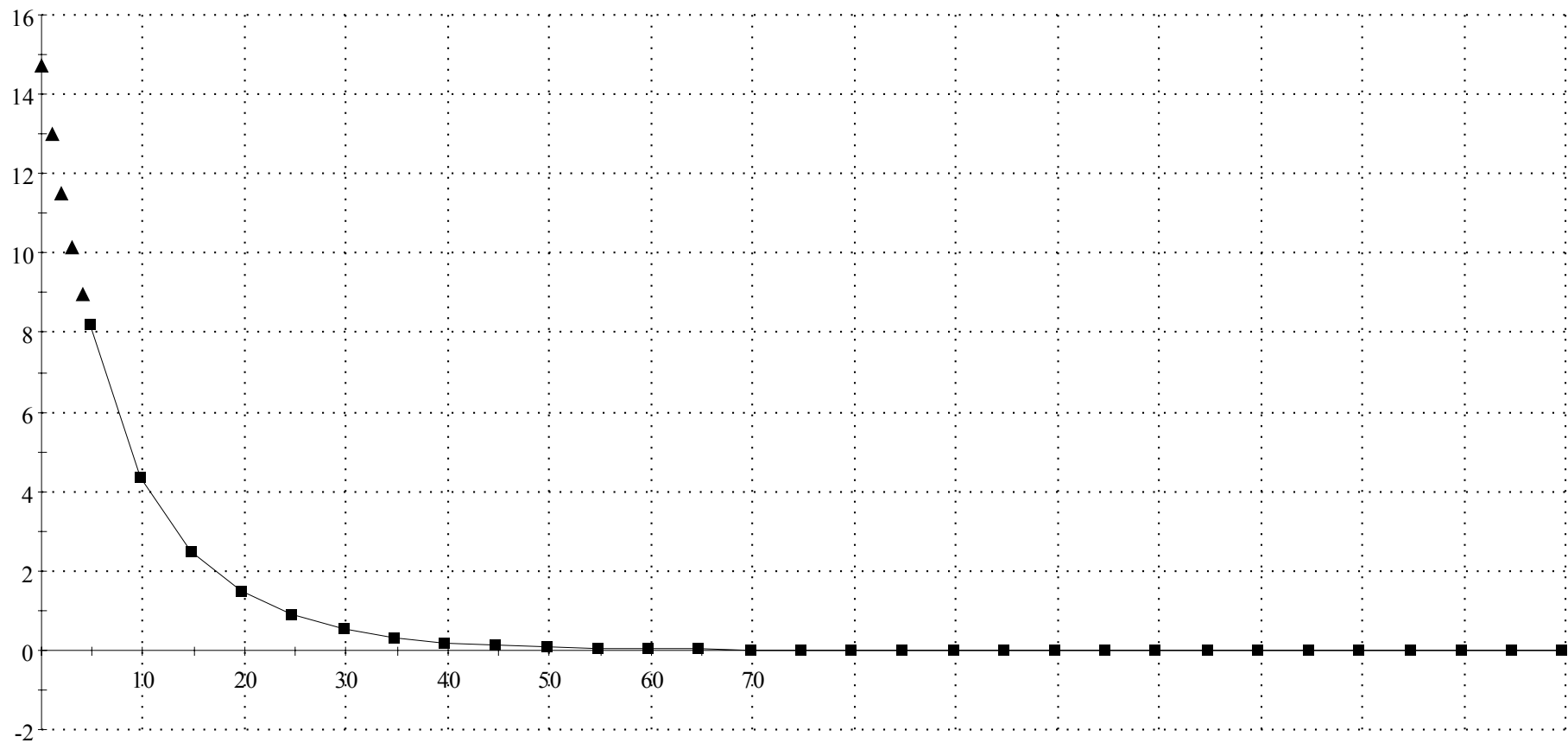

Dipole 900 MHz

900 MHz System Performance Check / Dipole Sn# 96

PM1 Power = 201mW Refl.Pwr PM3= -25.9dB

Room Temp at time of measurement = 20°C Simulant Temp at time of measurement = 20.2°C

R4 TP-1131 SUGAR sam expanded (Rev. 2)-9Jan03 Phantom; Flat Section; Position: (90°,90°); Frequency: 900 MHz

Probe: ET3DV6 - SN1514 - Validation.3; ConvF(6.30,6.30,6.30); Crest factor: 1.0; 900 MHz VALIDATION: $\sigma = 0.96$ mho/m $\epsilon_r = 41.4$ $\rho = 1.00$ g/cm³

Cubes (2): SAR (1g): 2.21 mW/g ± 0.04 dB, SAR (10g): 1.40 mW/g ± 0.03 dB, (Worst-case extrapolation)

Coarse: Dx = 15.0, Dy = 15.0, Dz = 10.0

Penetration depth: 11.5 (10.7, 12.6) [mm]

Powerdrift: -0.02 dB

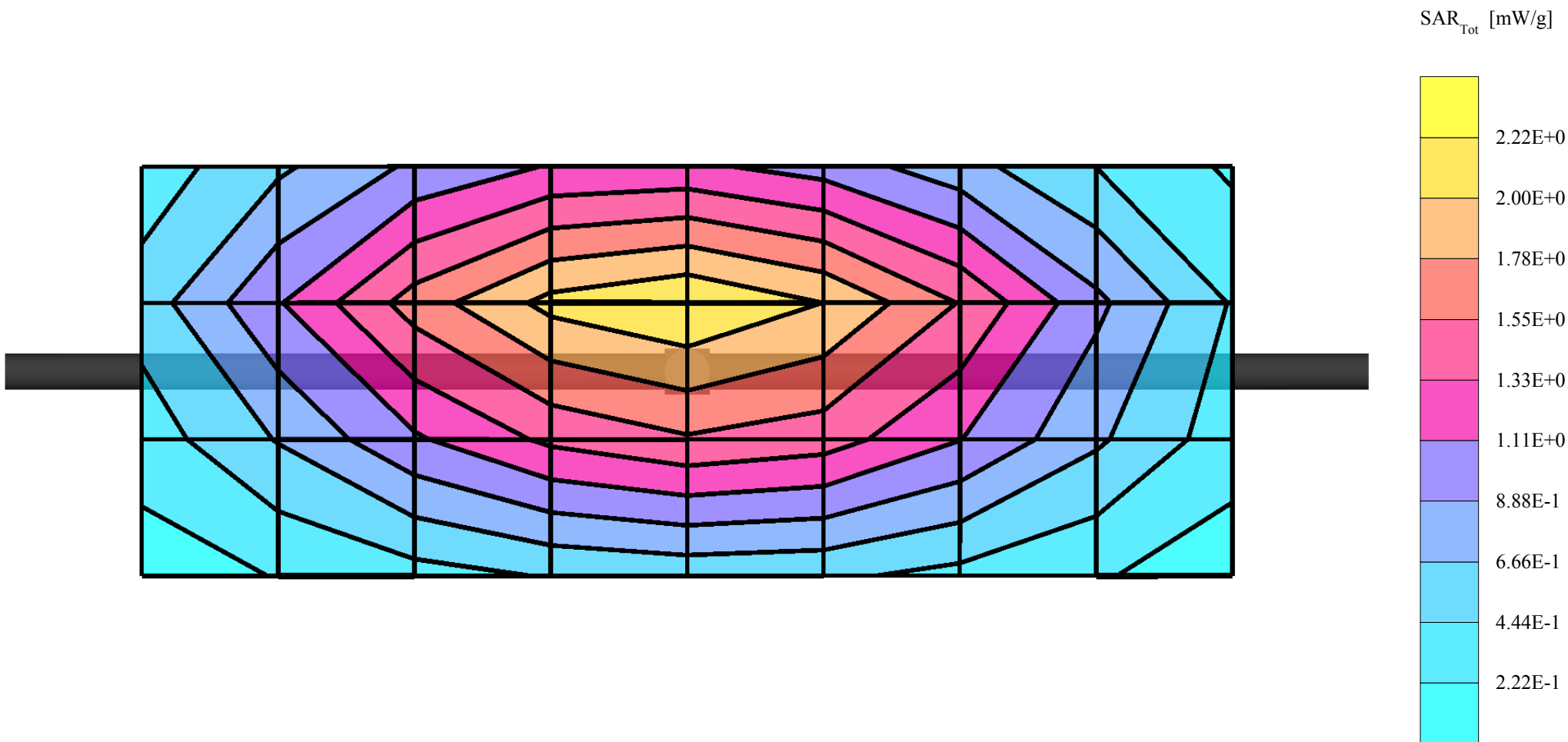

Dipole 900 MHz

900 MHz System Performance Check / Dipole Sn# 96

PM1 Power = 201mW Refl.Pwr PM3= -25.9dB

Room Temp at time of measurement = 20°C Simulant Temp at time of measurement = 20.2°C

R4 TP-1131 SUGAR sam expanded (Rev. 2)-9Jan03 Phantom; Section; Position: ; Frequency: 900 MHz

Probe: ET3DV6 - SN1514 - Validation.3; ConvF(6.30,6.30,6.30); Crest factor: 1.0; 900 MHz VALIDATION: $\sigma = 0.96$ mho/m $\epsilon_r = 41.4$ $\rho = 1.00$ g/cm³

; , ()

Z-Axis: Dx = 0.0, Dy = 0.0, Dz = 5.0

Penetration depth: 11.5 (10.6, 12.7) [mm]

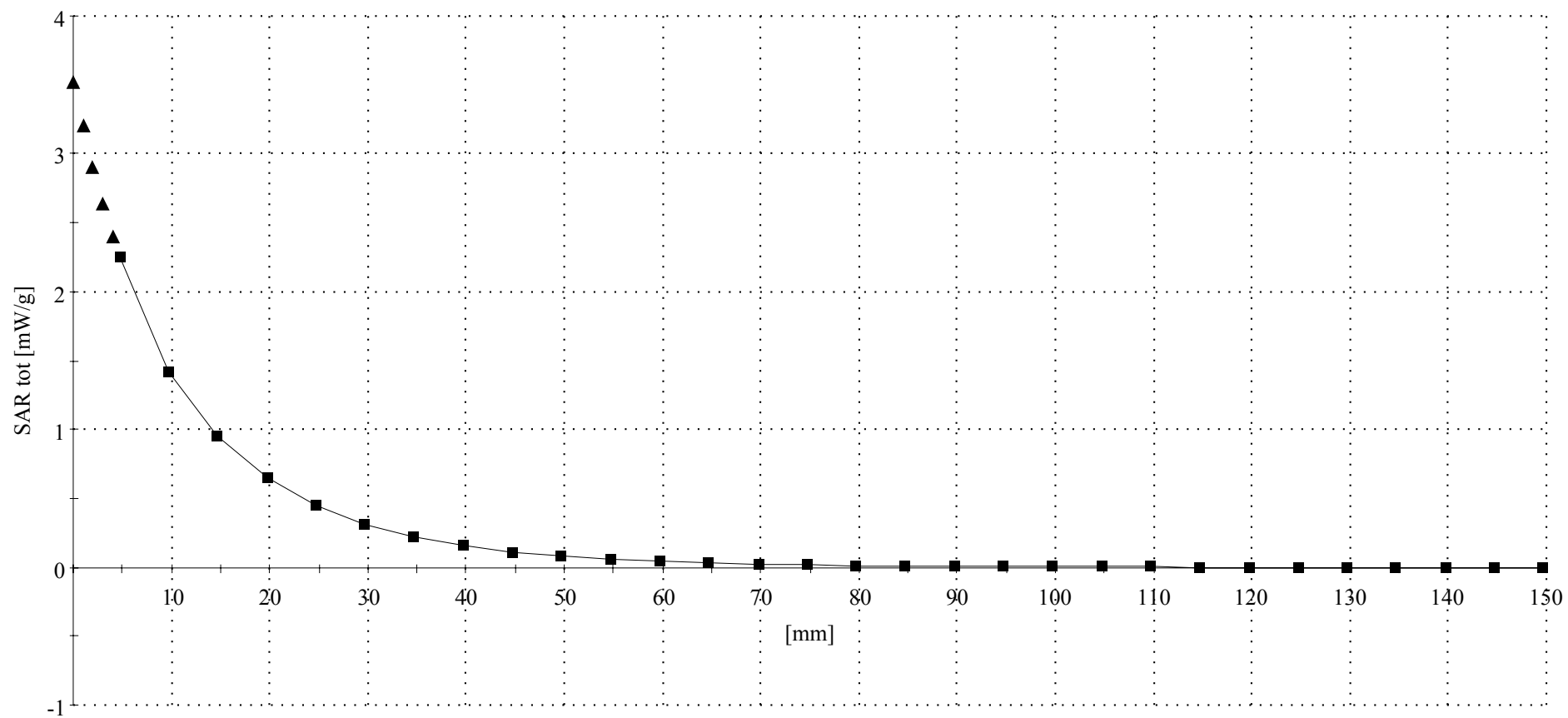

Dipole 1800 MHz

1800 MHz System Performance Check / Dipole Sn# 272tr

PM1 Power = 200mW Refl.Pwr PM3= -26.5dB

Room Temp at time of measurement = 20°C Simulant Temp at time of measurement = 19.5°C

R4 - Amy Twin Phantom Rev.4 (22Aug02) Phantom; section 2 Section; Position: (90°,90°); Frequency: 1800 MHz

Probe: ET3DV6 - SN1514 - Validation.3; ConvF(5.10,5.10,5.10); Crest factor: 1.0; 1800 MHz VALIDATION: $\sigma = 1.36$ mho/m $\epsilon_r = 39.7$ $\rho = 1.00$ g/cm³

Cubes (2): SAR (1g): 8.16 mW/g \pm 0.03 dB, SAR (10g): 4.29 mW/g \pm 0.04 dB, (Worst-case extrapolation)

Coarse: Dx = 15.0, Dy = 15.0, Dz = 10.0

Penetration depth: 8.4 (8.0, 9.3) [mm]

Powerdrift: -0.01 dB

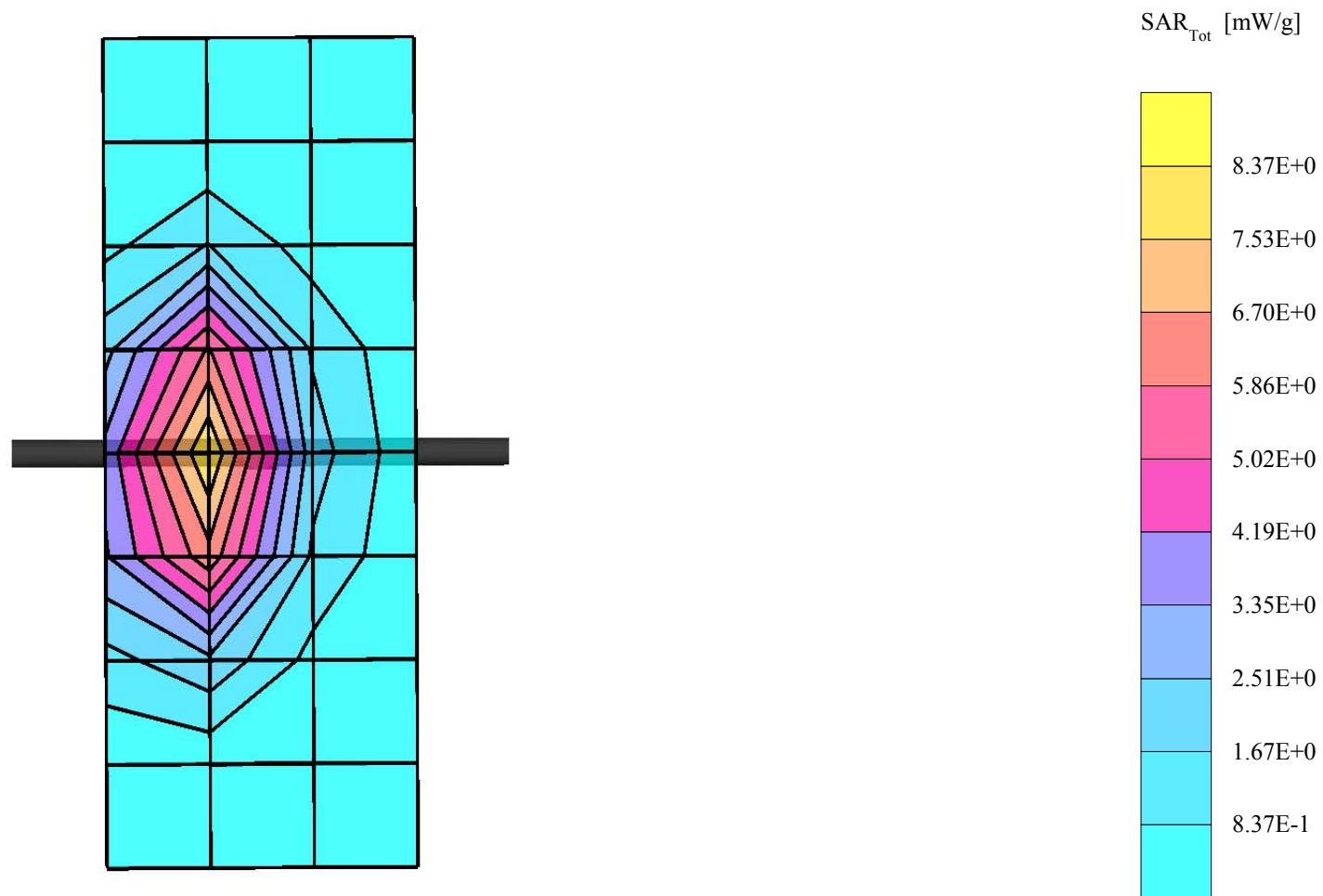

Dipole 1800 MHz

1800 MHz System Performance Check / Dipole Sn# 272tr

PM1 Power = 200mW Refl.Pwr PM3= -26.5dB

Room Temp at time of measurement = 20*C Simulant Temp at time of measurement = 19.5*C

R4 - Amy Twin Phantom Rev.4 (22Aug02) Phantom; Section; Position: ; Frequency: 1800 MHz

Probe: ET3DV6 - SN1514 - Validation.3; ConvF(5.10,5.10,5.10); Crest factor: 1.0; 1800 MHz VALIDATION: $\sigma = 1.36$ mho/m $\epsilon_r = 39.7$ $\rho = 1.00$ g/cm³

: , ()

Z-Axis: Dx = 0.0, Dy = 0.0, Dz = 5.0

Penetration depth: 8.3 (7.9, 9.2) [mm]

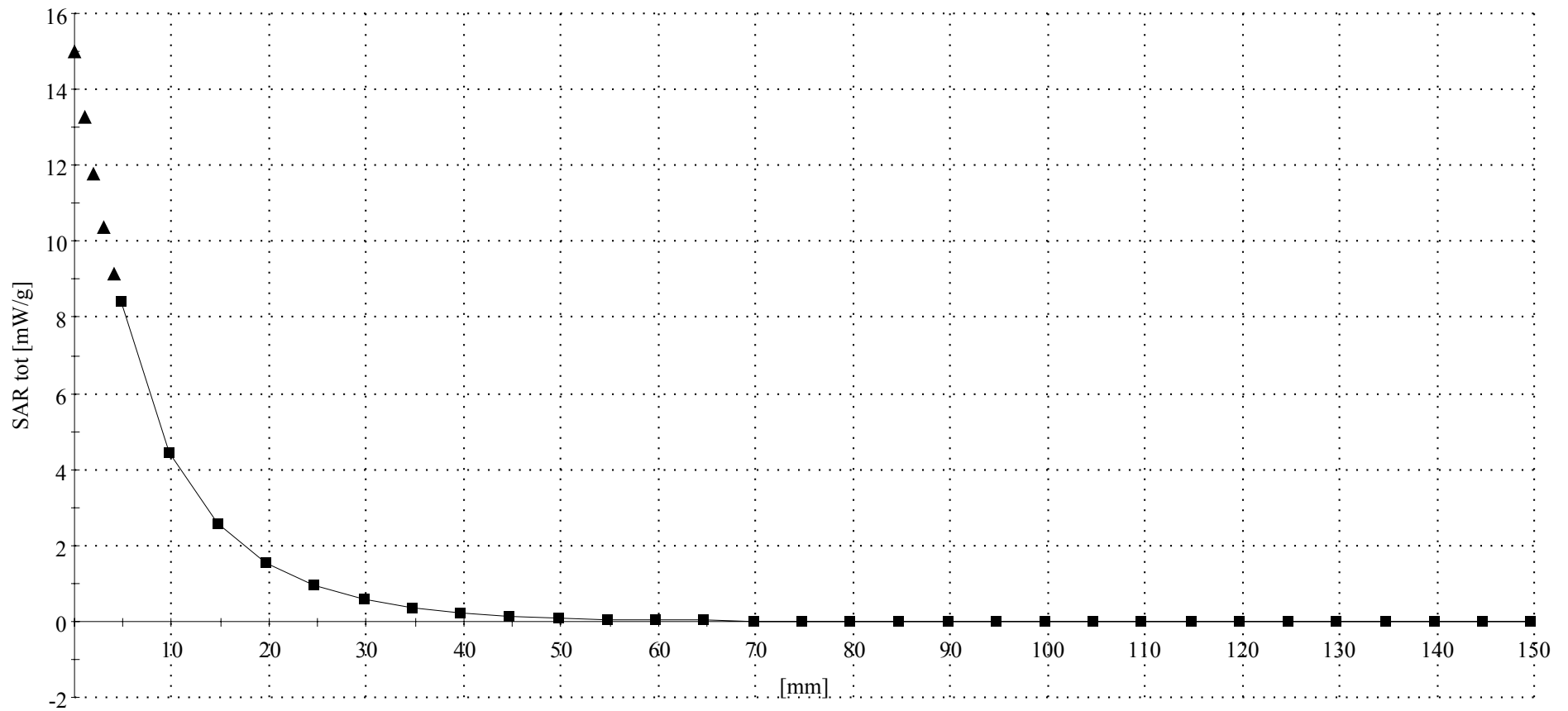

Appendix 2

SAR distribution plots for Phantom Head Adjacent Use

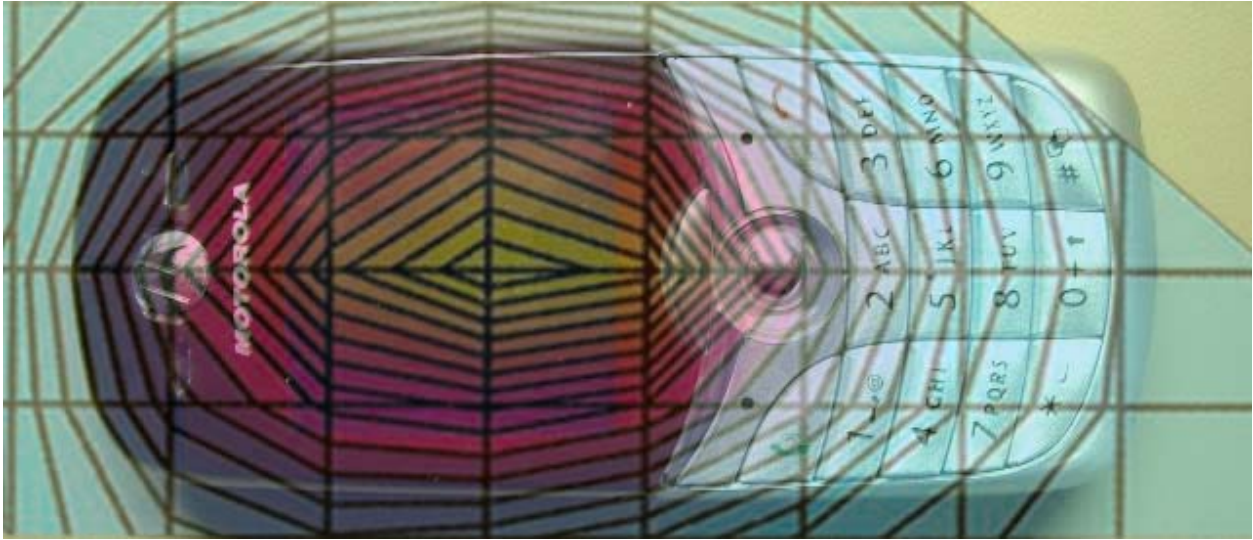

Figure 1. Typical 850MHz Left Head Adjacent Contour Overlaid on Phone with Antenna Fixed (Cheek Touch)

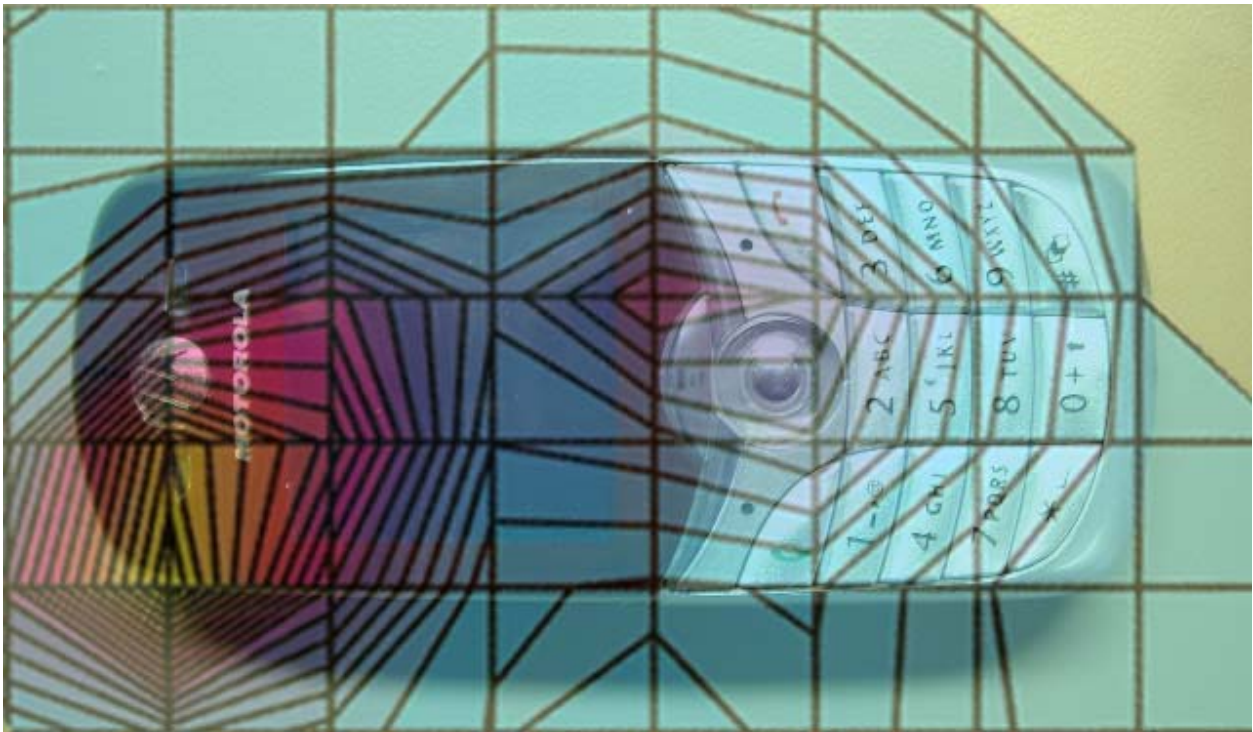

Figure 2. Typical 1900MHz Left Head Adjacent Contour Overlaid on Phone with Antenna Fixed (Cheek Touch)

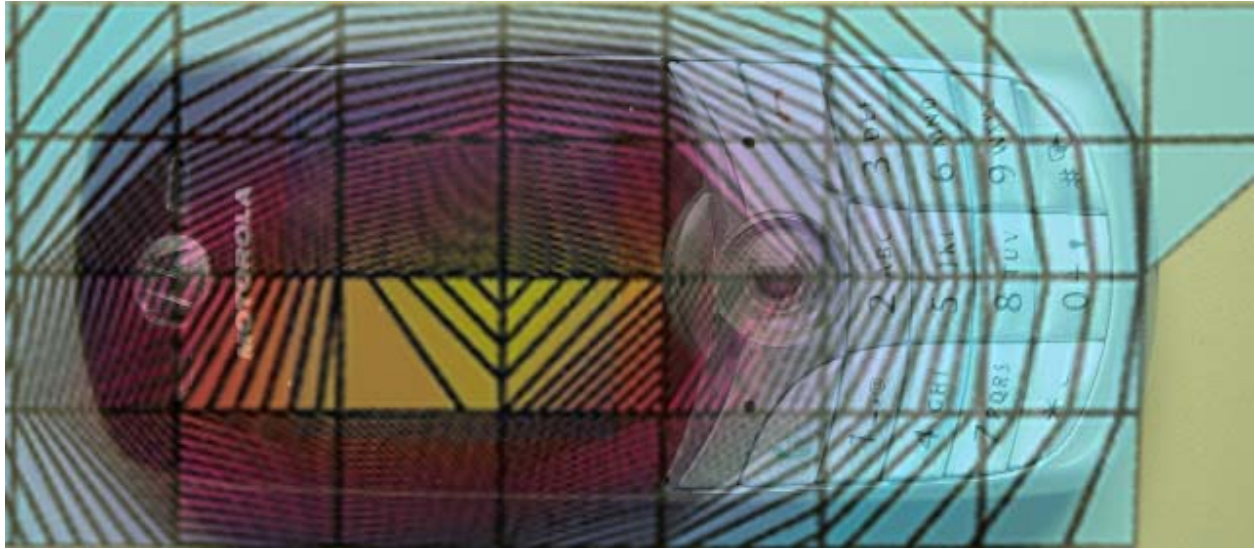

Figure 3. Typical 850MHz Right Head Adjacent Contour Overlaid on Phone with Antenna Fixed (Cheek Touch)

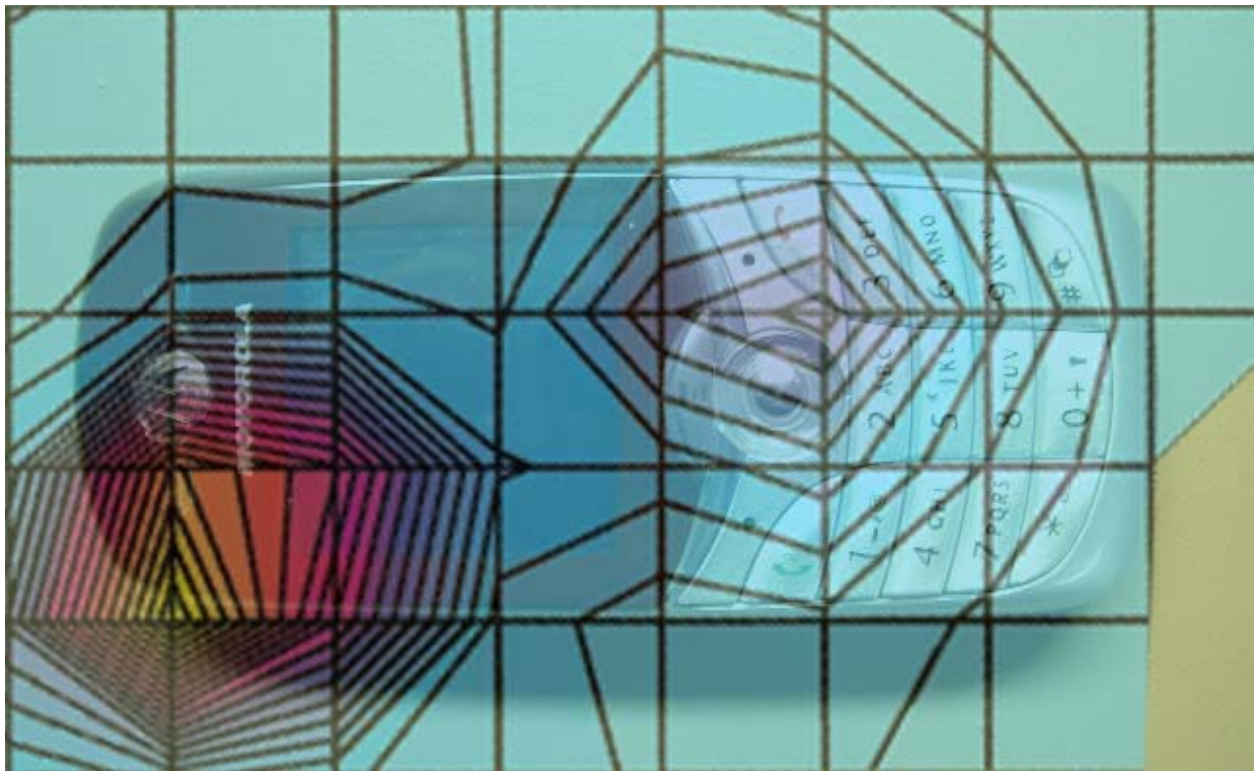

Figure 4. Typical 1900MHz Right Head Adjacent Contour Overlaid on Phone with Antenna Fixed (Cheek Touch)

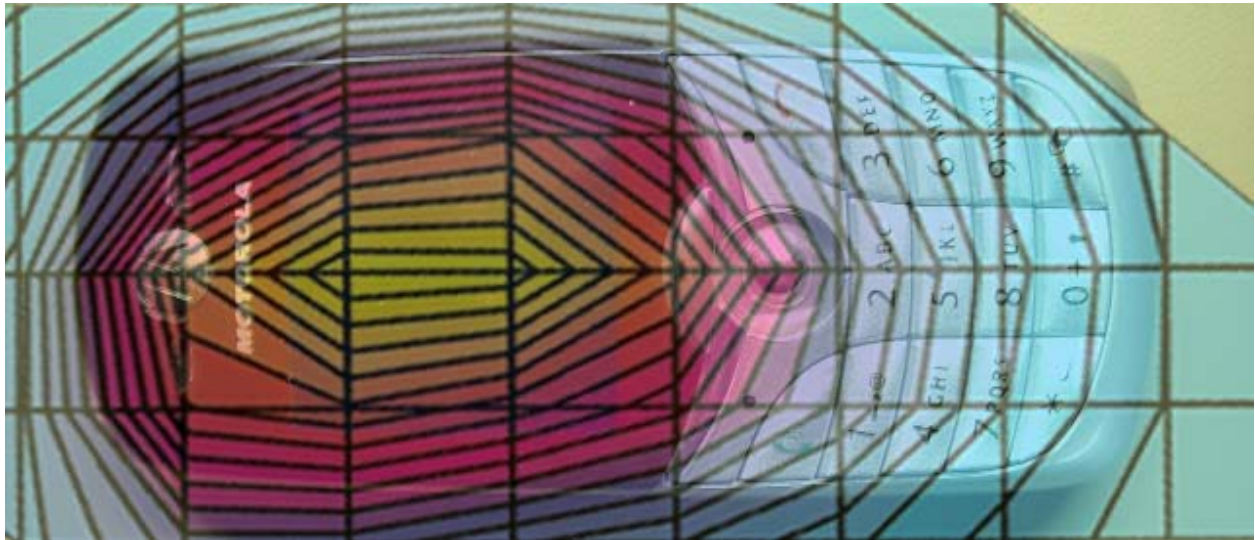

Figure 5. Typical 850MHz Left Head Adjacent Contour Overlaid on Phone with Antenna Fixed (15 ° Tilt)

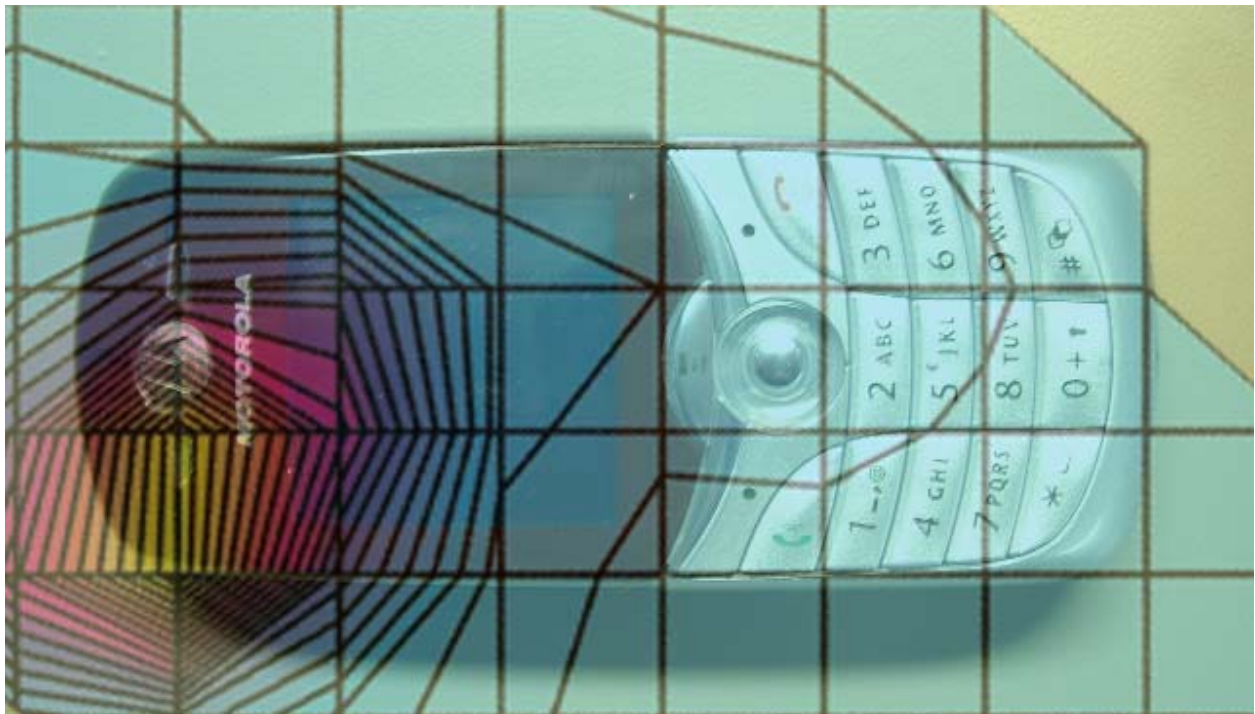

Figure 6. Typical 1900MHz Left Head Adjacent Contour Overlaid on Phone with Antenna Fixed (15 ° Tilt)

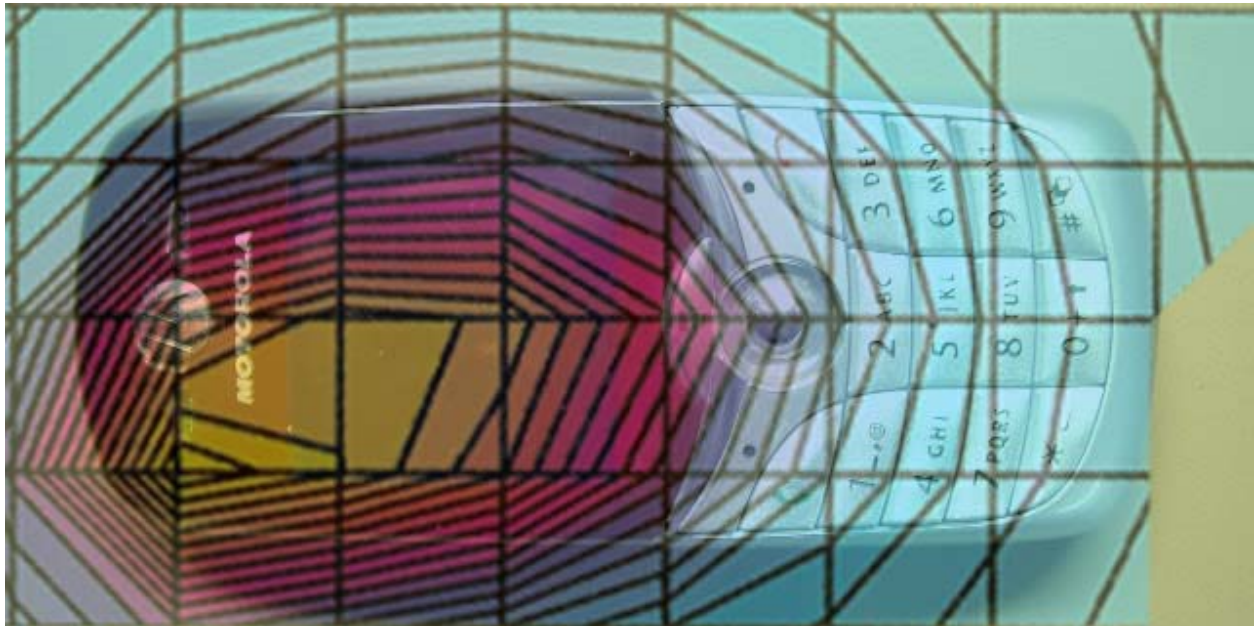

Figure 7. Typical 850MHz Right Head Adjacent Contour Overlaid on Phone with Antenna Fixed (15 ° Tilt)

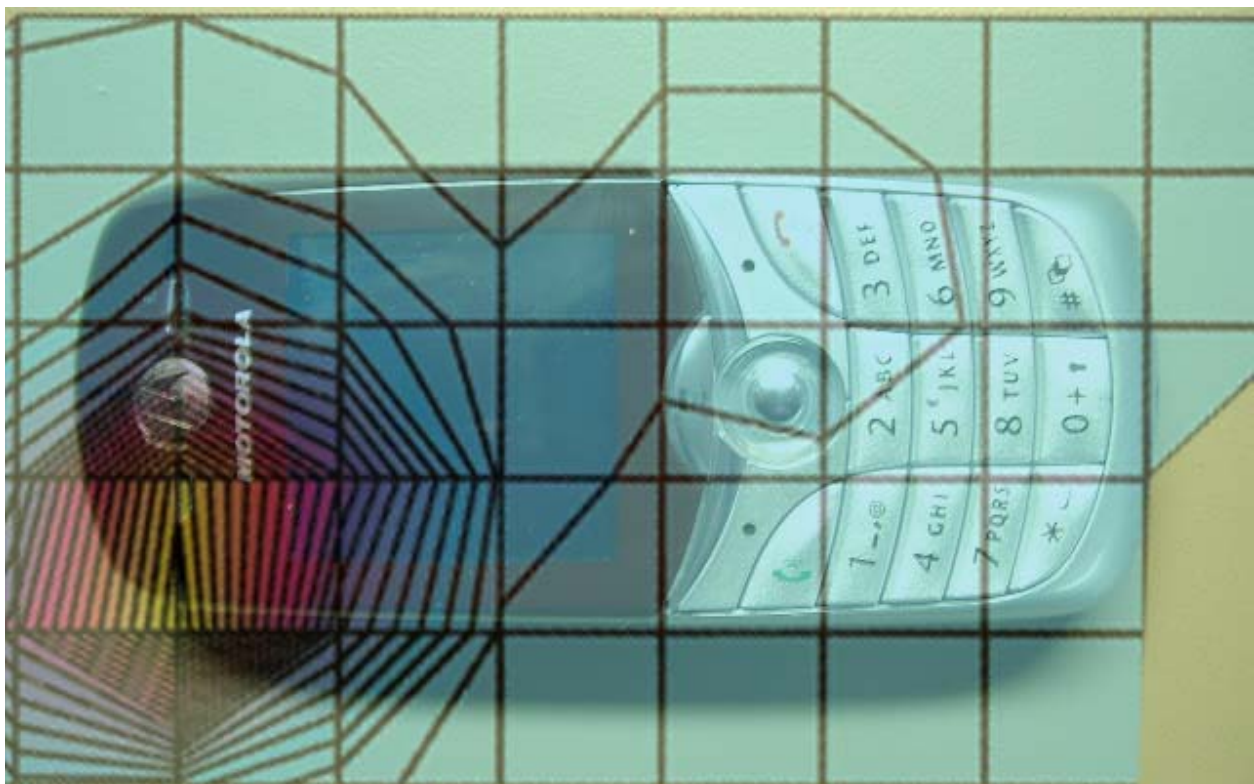

Figure 8. Typical 1900MHz Right Head Adjacent Contour Overlaid on Phone with Antenna Fixed (15 ° Tilt)

Appendix 3

SAR distribution plots for Body Worn Configuration

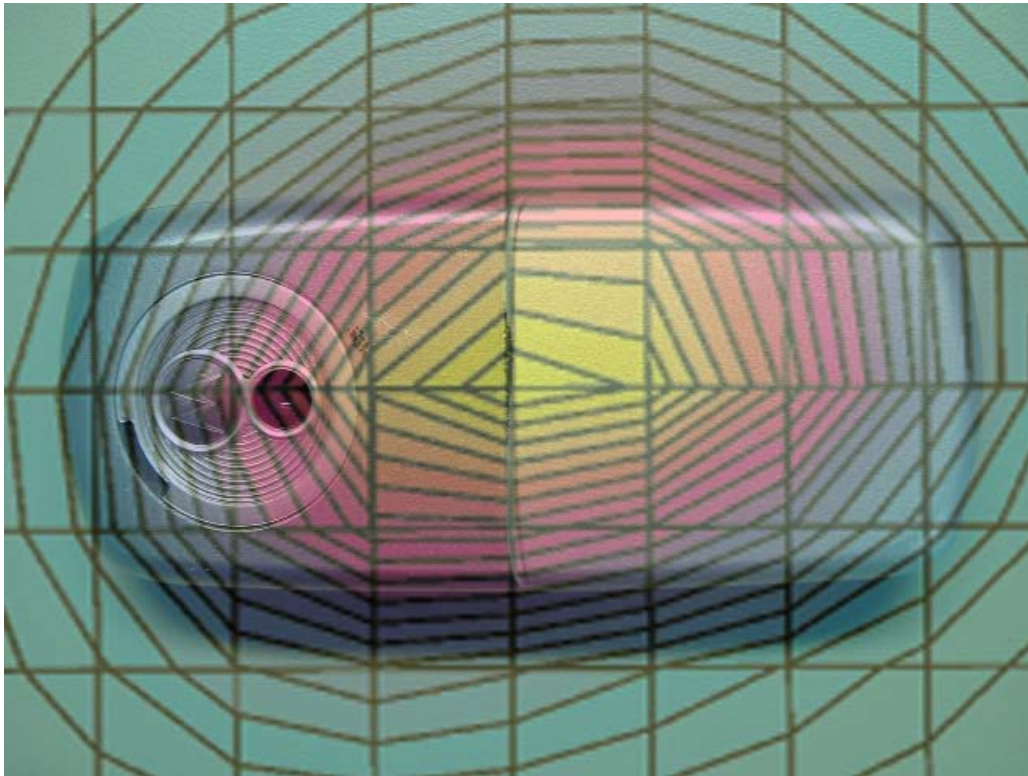

Figure 9. Typical 850 MHz Body-Worn Contour Overlaid on Phone in Voice Mode

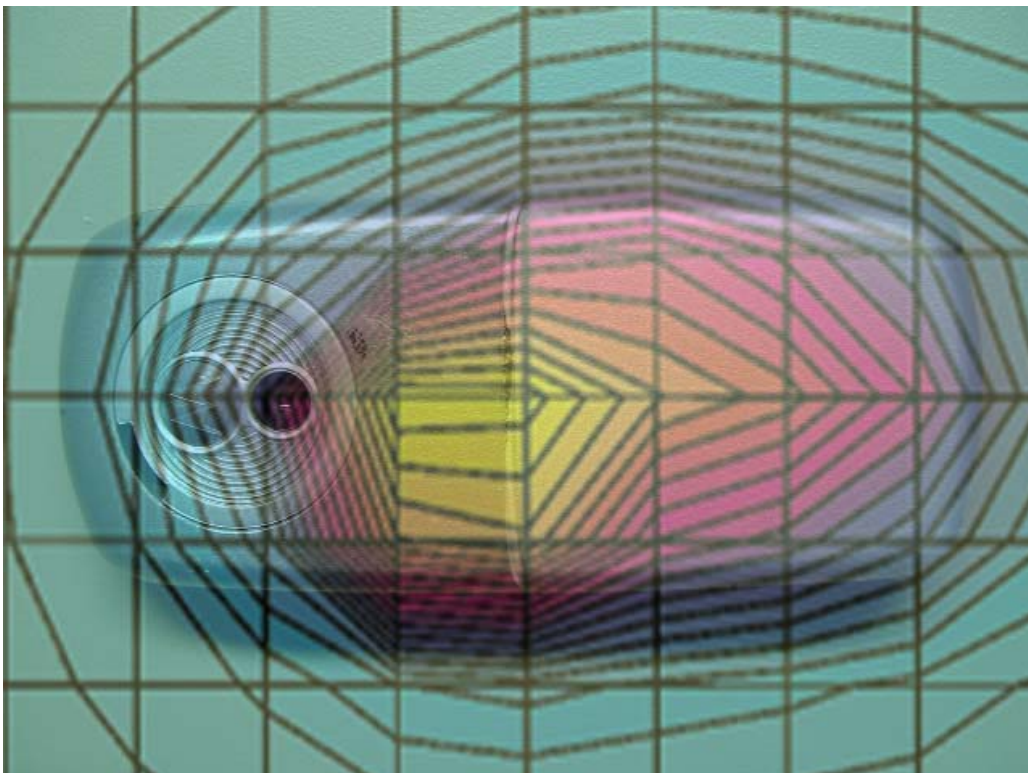

Figure 10. Typical 1900 MHz Body-Worn Contour Overlaid on Phone in Voice Mode

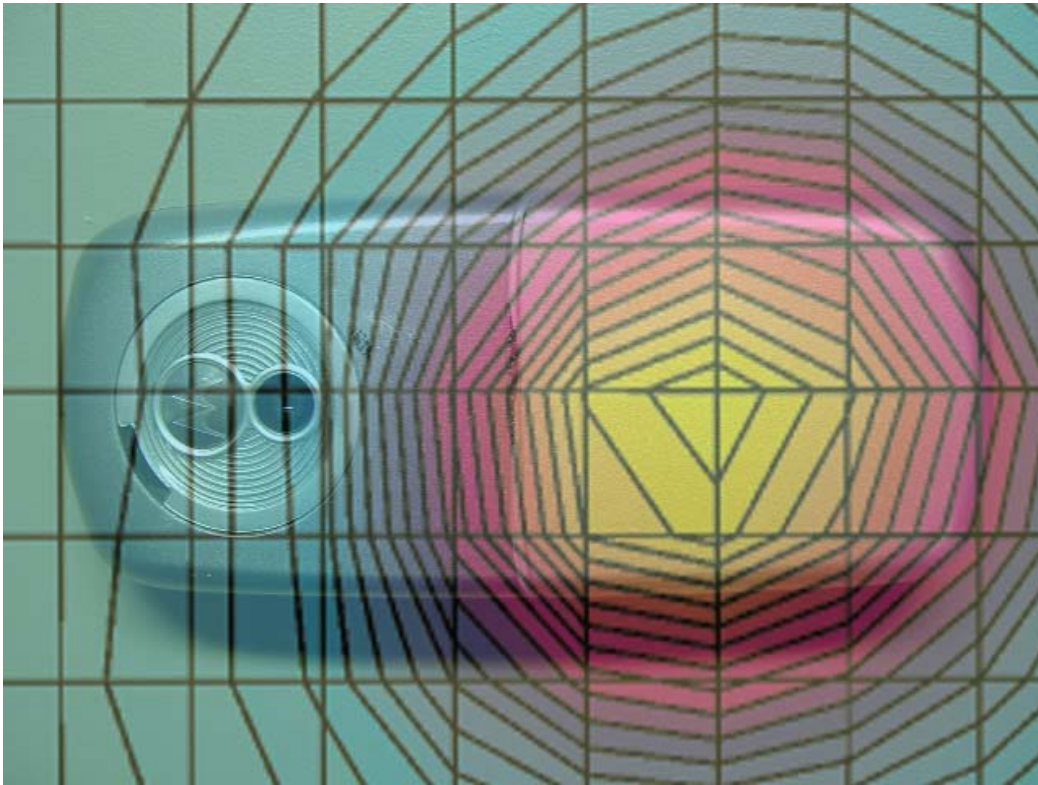

Figure 11. Typical 850 MHz Body-Worn Contour Overlaid on Phone in Data Mode

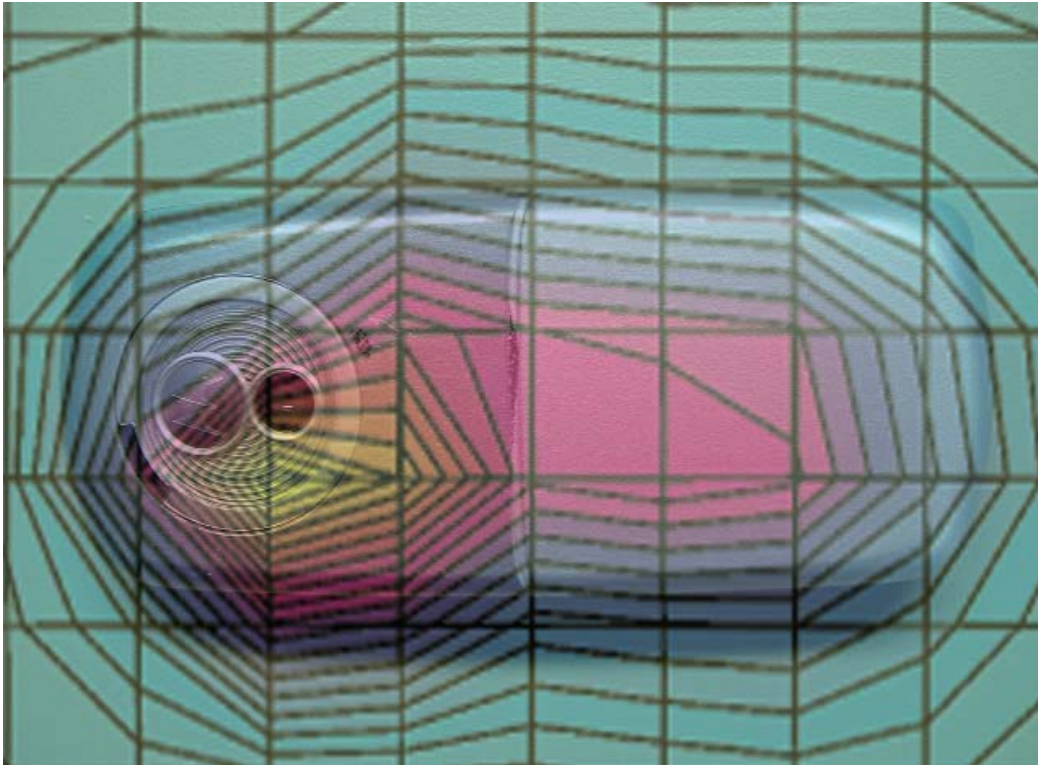

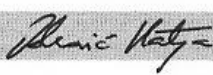

Figure 12. Typical 1900 MHz Body-Worn Contour Overlaid on Phone in Data Mode

Appendix 4
Probe Calibration Certificate

Client **Motorola MRO**

CALIBRATION CERTIFICATE			
Object(s)	ET3DV6 - SN:1522		
Calibration procedure(s)	QA CAL-01.v2 Calibration procedure for dosimetric E-field probes		
Calibration date:	March 21, 2003		
Condition of the calibrated item	In Tolerance (according to the specific calibration document)		
This calibration statement documents traceability of M&TE used in the calibration procedures and conformity of the procedures with the ISO/IEC 17025 international standard.			
All calibrations have been conducted in the closed laboratory facility: environment temperature 22 +/- 2 degrees Celsius and humidity < 75%.			
Calibration Equipment used (M&TE critical for calibration)			
Model Type	ID #	Cal Date	Scheduled Calibration
RF generator HP 8684C	US3642U01700	4-Aug-99 (in house check Aug-02)	In house check: Aug-05
Power sensor E4412A	MY41495277	Mar-02	Mar-03
Power sensor HP 8481A	MY41092180	18-Sep-02	Sep-03
Power meter EPM E4419B	GB41293874	13-Sep-02	Sep-03
Network Analyzer HP 8753E	US38432426	3-May-00	In house check: May 03
Fluke Process Calibrator Type 702	SN: 6295803	3-Sep-01	Sep-03
Calibrated by:	Name Nico Vetterli	Function Technician	Signature 
Approved by:	Name Katja Pokovic	Function Laboratory Director	Signature 
Date issued: March 21, 2003			
This calibration certificate is issued as an intermediate solution until the accreditation process (based on ISO/IEC 17025 International Standard) for Calibration Laboratory of Schmid & Partner Engineering AG is completed.			

Zeughausstrasse 43, 8004 Zurich, Switzerland
Phone +41 1 245 9700, Fax +41 1 245 9779
info@speag.com, <http://www.speag.com>

Probe ET3DV6R

SN:1522

Manufactured:	March 21, 2000
Last calibration:	April 25, 2002
Recalibrated:	March 21, 2003

Calibrated for DASY Systems

(Note: non-compatible with DASY2 system!)

DASY - Parameters of Probe: ET3DV6R SN:1522

Sensitivity in Free Space

NormX	1.41 $\mu\text{V}/(\text{V}/\text{m})^2$
NormY	1.23 $\mu\text{V}/(\text{V}/\text{m})^2$
NormZ	1.29 $\mu\text{V}/(\text{V}/\text{m})^2$

Diode Compression

DCP X	96	mV
DCP Y	96	mV
DCP Z	96	mV

Sensitivity in Tissue Simulating Liquid

Head	900 MHz	$\epsilon_r = 41.5 \pm 5\%$	$\sigma = 0.97 \pm 5\%$ mho/m
Head	835 MHz	$\epsilon_r = 41.5 \pm 5\%$	$\sigma = 0.90 \pm 5\%$ mho/m
ConvF X	4.7 $\pm 9.5\%$ (k=2)	Boundary effect:	
ConvF Y	4.7 $\pm 9.5\%$ (k=2)	Alpha	0.57
ConvF Z	4.7 $\pm 9.5\%$ (k=2)	Depth	1.94
Head	1800 MHz	$\epsilon_r = 40.0 \pm 5\%$	$\sigma = 1.40 \pm 5\%$ mho/m
Head	1900 MHz	$\epsilon_r = 40.0 \pm 5\%$	$\sigma = 1.40 \pm 5\%$ mho/m
ConvF X	3.4 $\pm 9.5\%$ (k=2)	Boundary effect:	
ConvF Y	3.4 $\pm 9.5\%$ (k=2)	Alpha	0.49
ConvF Z	3.4 $\pm 9.5\%$ (k=2)	Depth	3.01

Boundary Effect

Head	900 MHz	Typical SAR gradient: 5 % per mm	
	Probe Tip to Boundary	1 mm	2 mm
	SAR _{be} [%] Without Correction Algorithm	9.3	5.1
	SAR _{be} [%] With Correction Algorithm	0.1	0.2
Head	1800 MHz	Typical SAR gradient: 10 % per mm	
	Probe Tip to Boundary	1 mm	2 mm
	SAR _{be} [%] Without Correction Algorithm	16.1	12.0
	SAR _{be} [%] With Correction Algorithm	0.5	0.5

Sensor Offset

Probe Tip to Sensor Center	2.7	mm
----------------------------	-----	----

Receiving Pattern (ϕ), $\theta = 0^\circ$

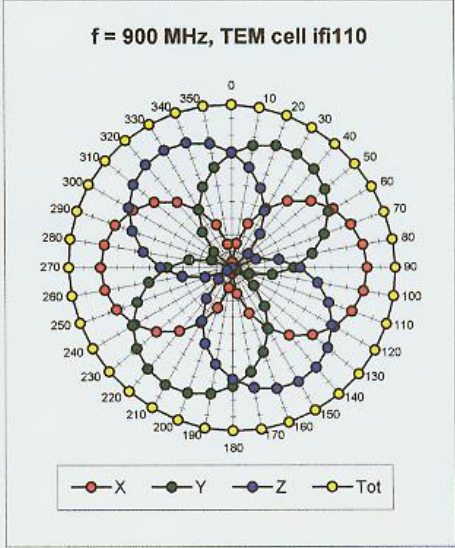
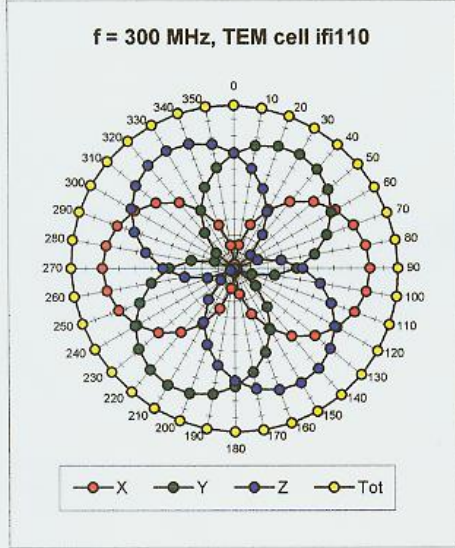
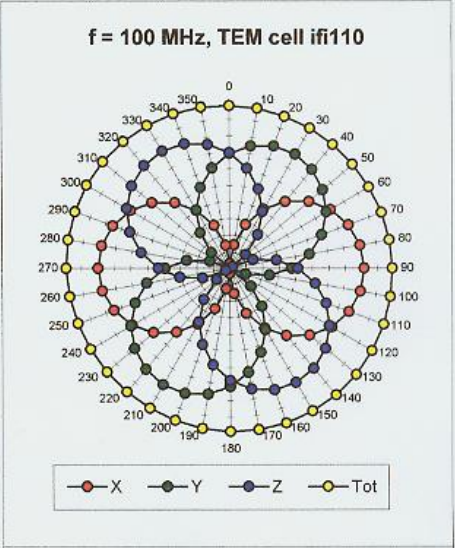
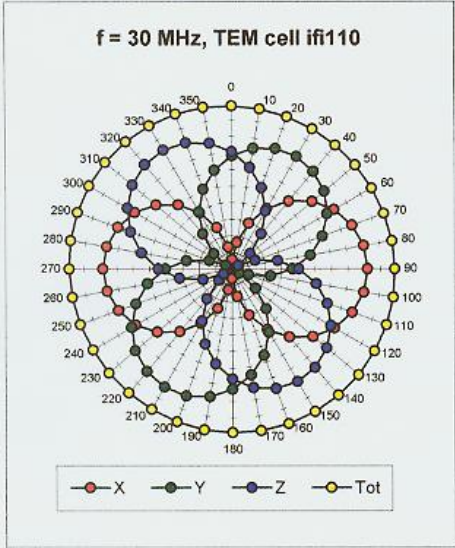

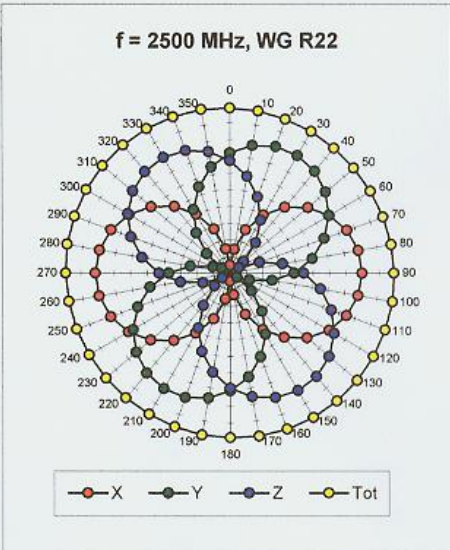
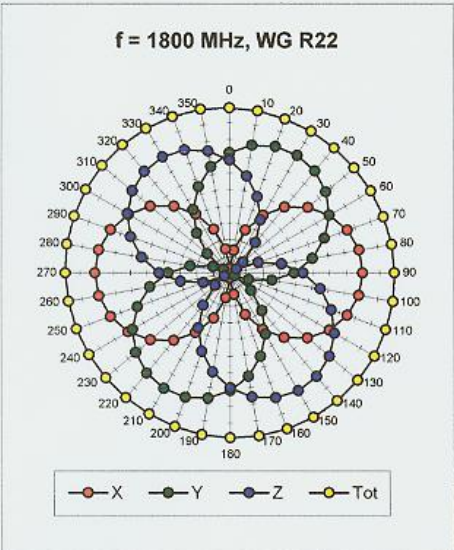

Isotropy Error (ϕ), $\theta = 0^\circ$

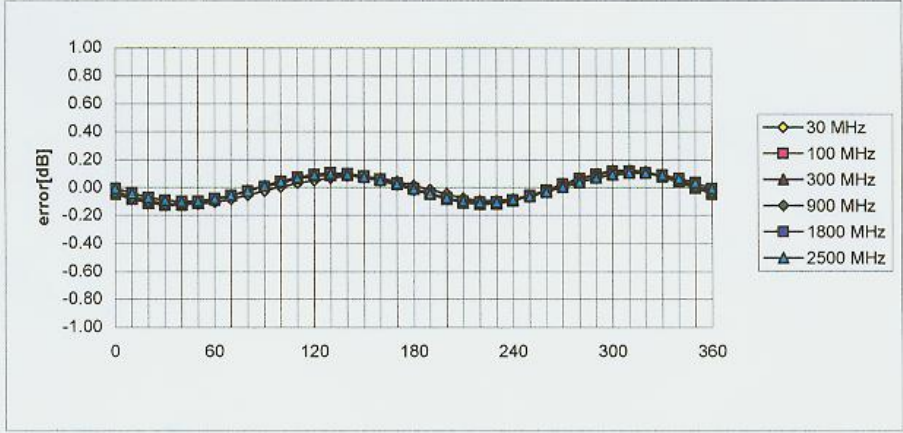

Frequency Response of E-Field

(TEM-Cell:ifi110, Waveguide R22)

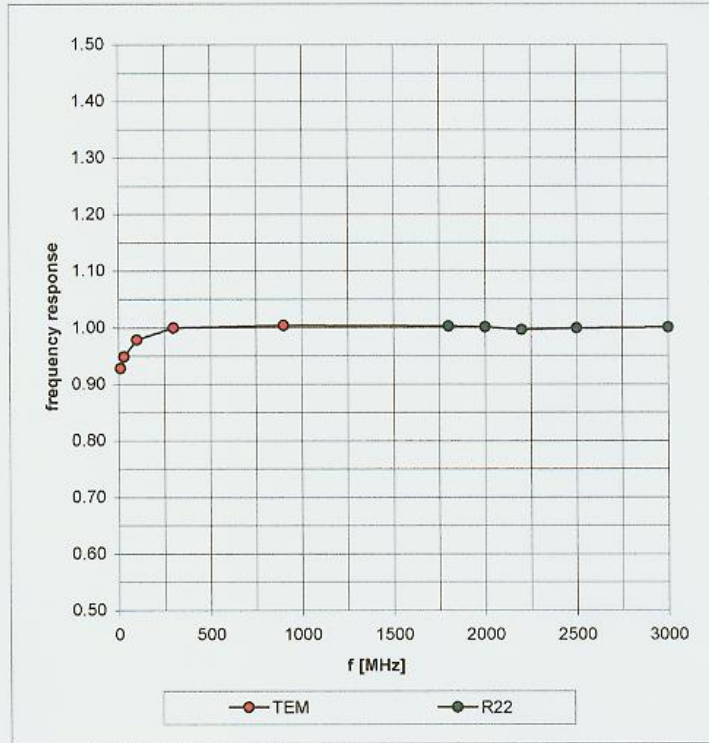

Dynamic Range $f(\text{SAR}_{\text{brain}})$

(Waveguide R22)

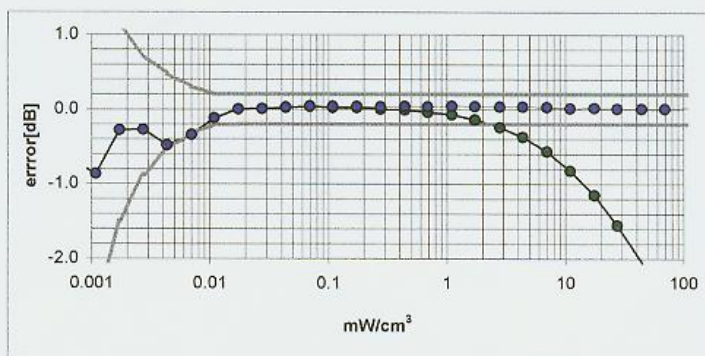
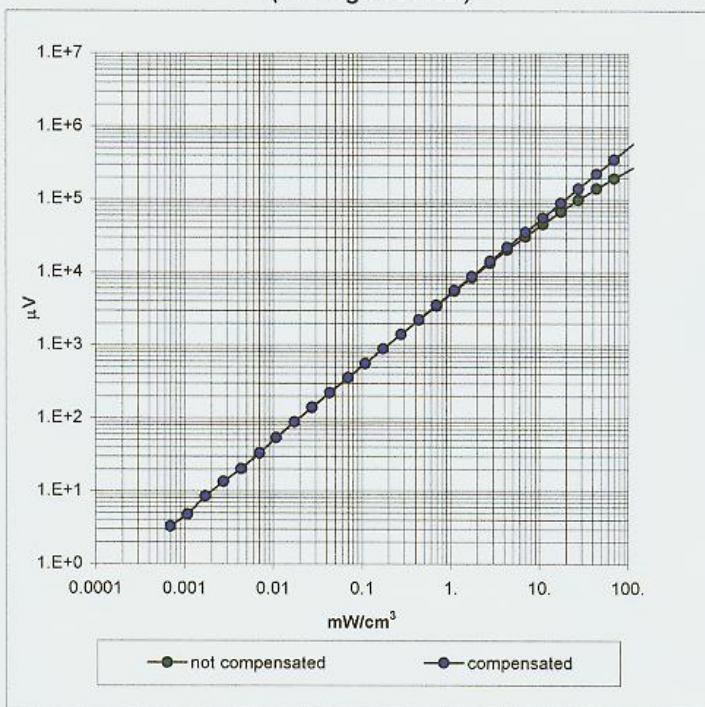

Conversion Factor Assessment

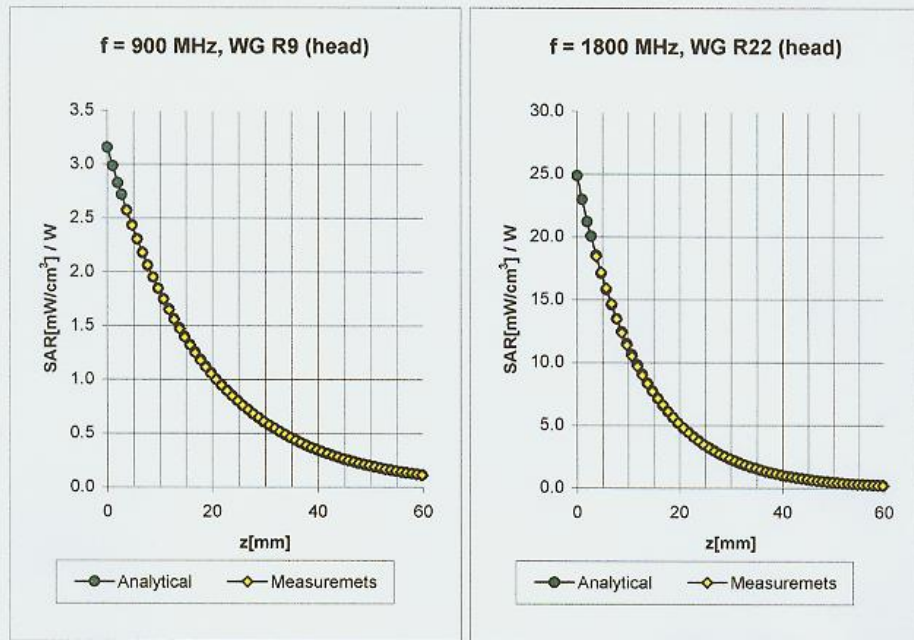

Head	900 MHz	$\epsilon_r = 41.5 \pm 5\%$	$\sigma = 0.97 \pm 5\%$ mho/m
Head	835 MHz	$\epsilon_r = 41.5 \pm 5\%$	$\sigma = 0.90 \pm 5\%$ mho/m
	ConvF X	4.7 $\pm 9.5\%$ (k=2)	Boundary effect:
	ConvF Y	4.7 $\pm 9.5\%$ (k=2)	Alpha 0.57
	ConvF Z	4.7 $\pm 9.5\%$ (k=2)	Depth 1.94
Head	1800 MHz	$\epsilon_r = 40.0 \pm 5\%$	$\sigma = 1.40 \pm 5\%$ mho/m
Head	1900 MHz	$\epsilon_r = 40.0 \pm 5\%$	$\sigma = 1.40 \pm 5\%$ mho/m
	ConvF X	3.4 $\pm 9.5\%$ (k=2)	Boundary effect:
	ConvF Y	3.4 $\pm 9.5\%$ (k=2)	Alpha 0.49
	ConvF Z	3.4 $\pm 9.5\%$ (k=2)	Depth 3.01

Conversion Factor Assessment

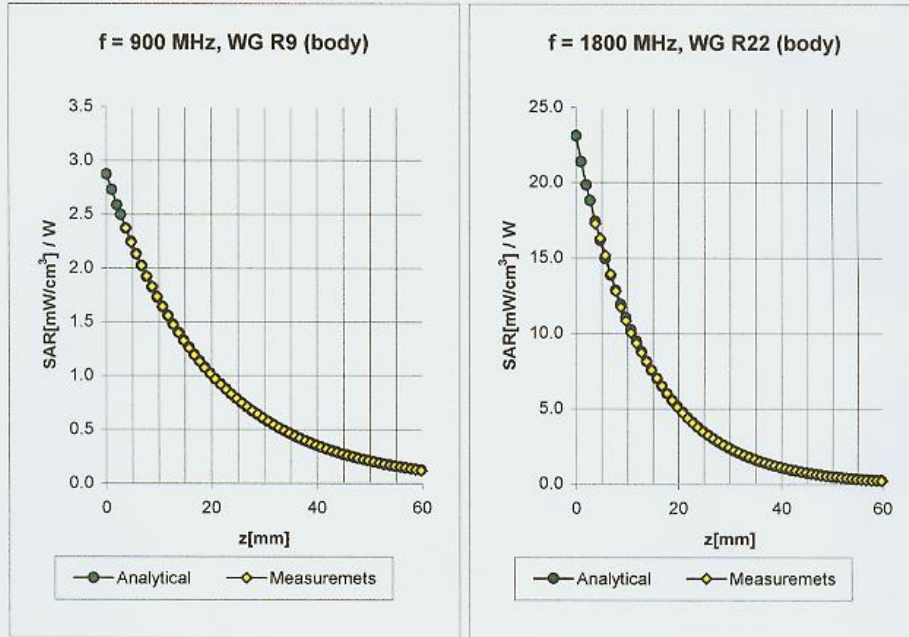

Body	900 MHz	$\epsilon_r = 55.0 \pm 5\%$	$\sigma = 1.05 \pm 5\% \text{ mho/m}$
Body	835 MHz	$\epsilon_r = 55.2 \pm 5\%$	$\sigma = 0.97 \pm 5\% \text{ mho/m}$
	ConvF X	4.4 $\pm 9.5\%$ (k=2)	Boundary effect:
	ConvF Y	4.4 $\pm 9.5\%$ (k=2)	Alpha 0.36
	ConvF Z	4.4 $\pm 9.5\%$ (k=2)	Depth 2.79
Body	1800 MHz	$\epsilon_r = 53.3 \pm 5\%$	$\sigma = 1.52 \pm 5\% \text{ mho/m}$
Body	1900 MHz	$\epsilon_r = 53.3 \pm 5\%$	$\sigma = 1.52 \pm 5\% \text{ mho/m}$
	ConvF X	3.1 $\pm 9.5\%$ (k=2)	Boundary effect:
	ConvF Y	3.1 $\pm 9.5\%$ (k=2)	Alpha 0.58
	ConvF Z	3.1 $\pm 9.5\%$ (k=2)	Depth 2.97

Conversion Factor Assessment

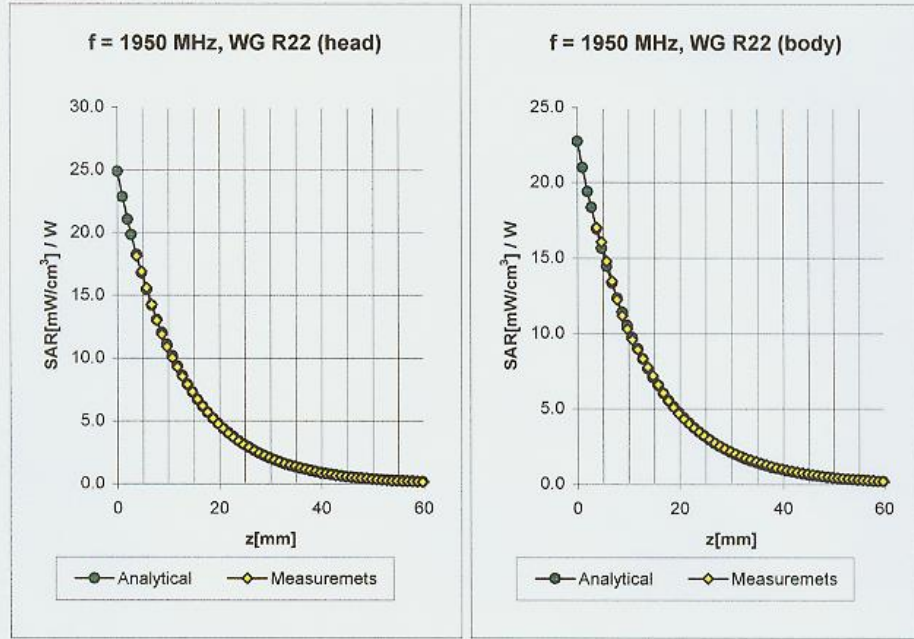

Head	1950	MHz	$\epsilon_r = 40.0 \pm 5\%$	$\sigma = 1.40 \pm 5\% \text{ mho/m}$	
	ConvF X		3.2 $\pm 8.9\%$ (k=2)		Boundary effect:
	ConvF Y		3.2 $\pm 8.9\%$ (k=2)		Alpha 0.55
	ConvF Z		3.2 $\pm 8.9\%$ (k=2)		Depth 2.95
Body	1950	MHz	$\epsilon_r = 53.3 \pm 5\%$	$\sigma = 1.52 \pm 5\% \text{ mho/m}$	
	ConvF X		2.7 $\pm 8.9\%$ (k=2)		Boundary effect:
	ConvF Y		2.7 $\pm 8.9\%$ (k=2)		Alpha 0.65
	ConvF Z		2.7 $\pm 8.9\%$ (k=2)		Depth 2.71

Deviation from Isotropy in HSL

Error (θ, ϕ), $f = 900$ MHz

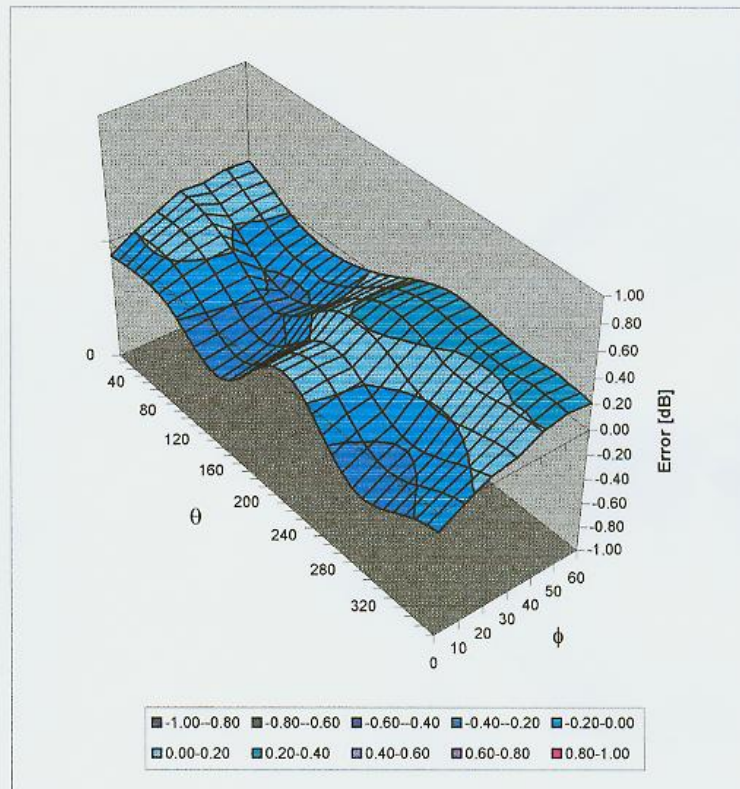

Client

Motorola MRO

CALIBRATION CERTIFICATE

Object(s)

ET3DV6 - SN 1514

Calibration procedure(s)

QA CAL-01 v2
 Calibration procedure for dosimetric E-field probes

Calibration date:

July 31, 2003

Condition of the calibrated item

In Tolerance (according to the specific calibration document)

This calibration statement documents traceability of M&TE used in the calibration procedures and conformity of the procedures with the ISO/IEC 17025 international standard.

All calibrations have been conducted in the closed laboratory facility: environment temperature 22 +/- 2 degrees Celsius and humidity < 75%.

Calibration Equipment used (M&TE critical for calibration)

Model Type	ID #	Cal Date (Calibrated by, Certificate No.)	Scheduled Calibration
RF generator HP 8684C	US3642U01700	4-Aug-99 (SPEAG, in house check Aug-02)	In house check: Aug-05
Power sensor E4412A	MY41495277	2-Apr-03 (METAS, No 252-0250)	Apr-04
Power sensor HP 8481A	MY41092180	18-Sep-02 (Agilent, No. 20020918)	Sep-03
Power meter EPM E4419B	GB41293874	2-Apr-03 (METAS, No 252-0250)	Apr-04
Network Analyzer HP 8753E	US37390585	18-Oct-01 (Agilent, No. 24BR1033101)	In house check: Oct 03
Fluke Process Calibrator Type 702	SN: 6295803	3-Sep-01 (ELCAL, No.2360)	Sep-03

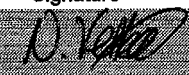
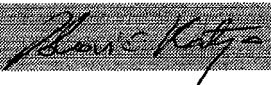
	Name	Function	Signature
Calibrated by:	Nico Vetterli	Technician	
Approved by:	Katja Pekoic	Laboratory Director	

Date issued: July 31, 2003

This calibration certificate is issued as an intermediate solution until the accreditation process (based on ISO/IEC 17025 International Standard) for Calibration Laboratory of Schmid & Partner Engineering AG is completed.

Probe ET3DV6

SN:1514

Manufactured:	November 24, 1999
Last calibration:	July 25, 2002
Recalibrated:	July 31, 2003

Calibrated for DASYS Systems

(Note: non-compatible with DASYS2 system!)

DASY - Parameters of Probe: ET3DV6 SN:1514

Sensitivity in Free Space

NormX	1.70 $\mu\text{V}/(\text{V}/\text{m})^2$
NormY	1.86 $\mu\text{V}/(\text{V}/\text{m})^2$
NormZ	1.79 $\mu\text{V}/(\text{V}/\text{m})^2$

Diode Compression

DCP X	93	mV
DCP Y	93	mV
DCP Z	93	mV

Sensitivity in Tissue Simulating Liquid

Head **900 MHz** $\epsilon_r = 41.5 \pm 5\%$ $\sigma = 0.97 \pm 5\%$ mho/m
Valid for f=800-1000 MHz with Head Tissue Simulating Liquid according to EN 50361, P1528-200X

ConvF X	6.3 $\pm 9.5\%$ (k=2)	Boundary effect:
ConvF Y	6.3 $\pm 9.5\%$ (k=2)	Alpha 0.58
ConvF Z	6.3 $\pm 9.5\%$ (k=2)	Depth 1.95

Head **1800 MHz** $\epsilon_r = 40.0 \pm 5\%$ $\sigma = 1.40 \pm 5\%$ mho/m
Valid for f=1710-1910 MHz with Head Tissue Simulating Liquid according to EN 50361, P1528-200X

ConvF X	5.1 $\pm 9.5\%$ (k=2)	Boundary effect:
ConvF Y	5.1 $\pm 9.5\%$ (k=2)	Alpha 0.55
ConvF Z	5.1 $\pm 9.5\%$ (k=2)	Depth 2.48

Boundary Effect

Head **900 MHz** **Typical SAR gradient: 5 % per mm**

Probe Tip to Boundary		1 mm	2 mm
SAR _{be} [%] Without Correction Algorithm		9.7	5.1
SAR _{be} [%] With Correction Algorithm		0.2	0.4

Head **1800 MHz** **Typical SAR gradient: 10 % per mm**

Probe Tip to Boundary		1 mm	2 mm
SAR _{be} [%] Without Correction Algorithm		13.9	9.0
SAR _{be} [%] With Correction Algorithm		0.1	0.0

Sensor Offset

Probe Tip to Sensor Center	2.7	mm
Optical Surface Detection	0.8 \pm 0.2	mm

Receiving Pattern (ϕ , $\theta = 0^\circ$)

f = 30 MHz, TEM cell ifi110

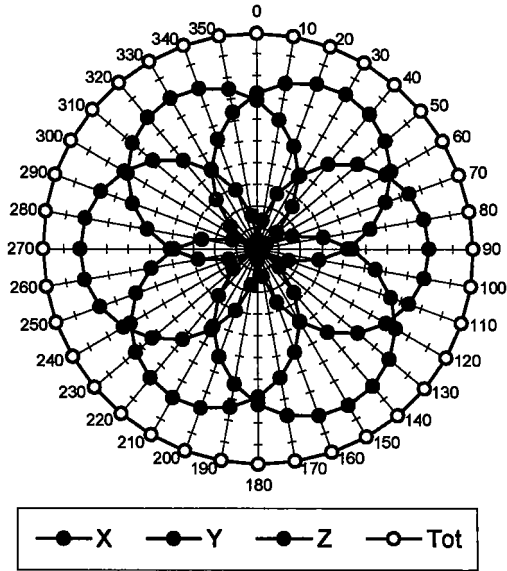

f = 100 MHz, TEM cell ifi110

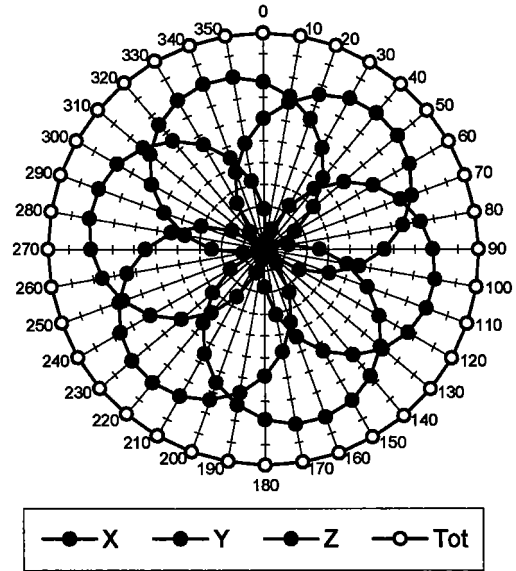

f = 300 MHz, TEM cell ifi110

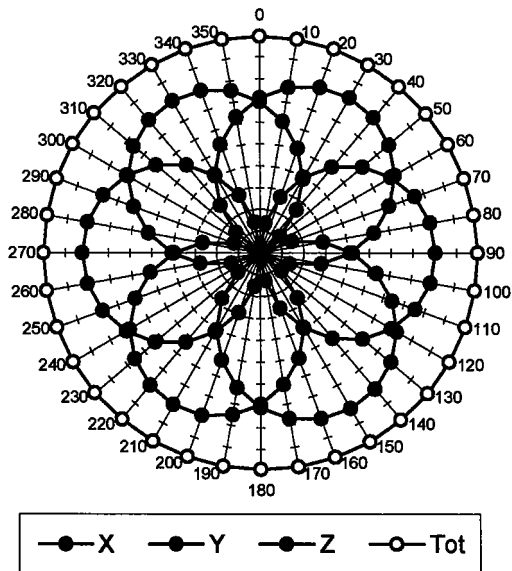

f = 900 MHz, TEM cell ifi110

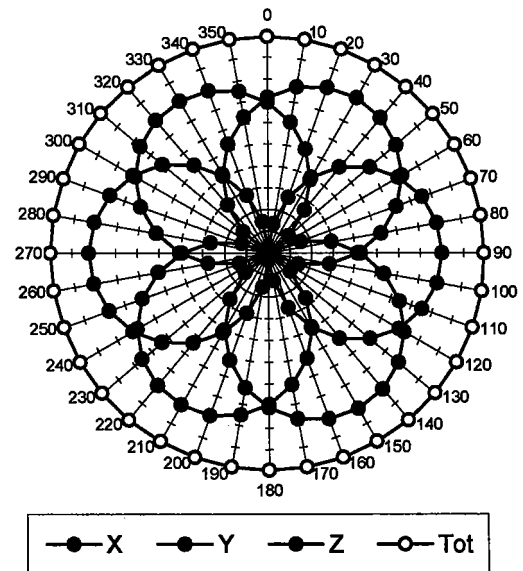

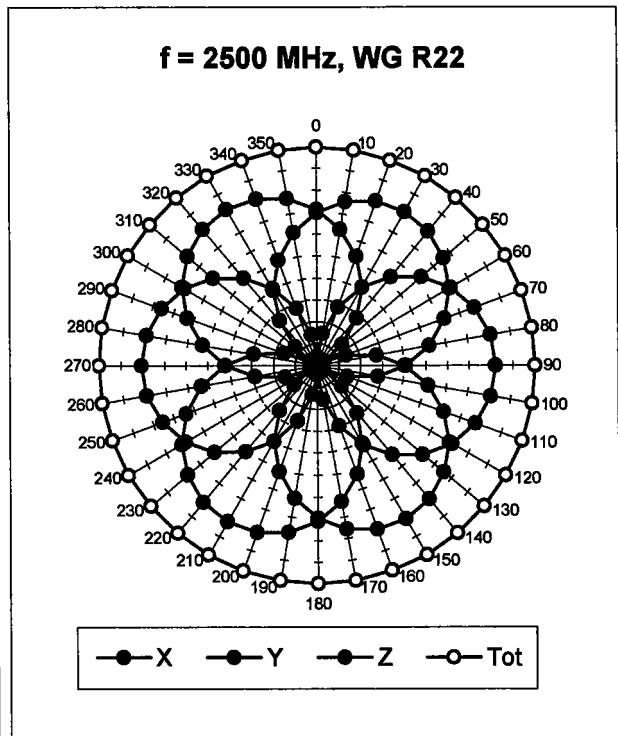
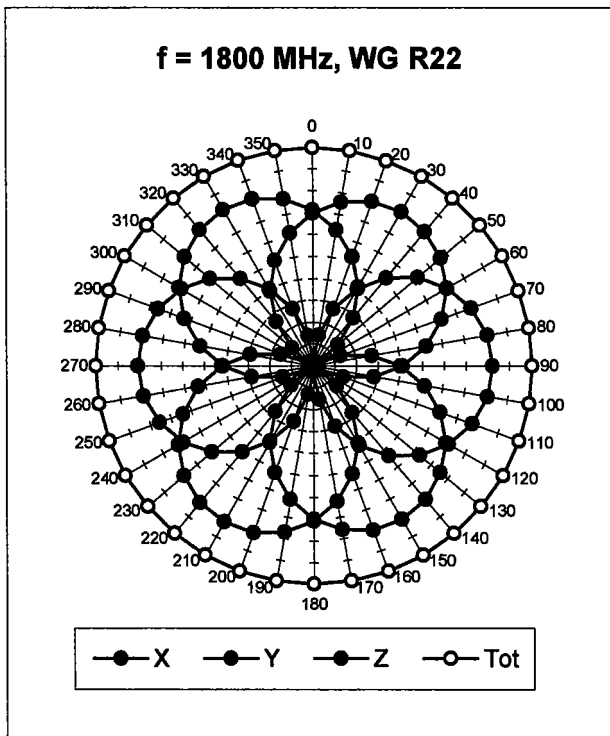

Isotropy Error (ϕ), $\theta = 0^\circ$

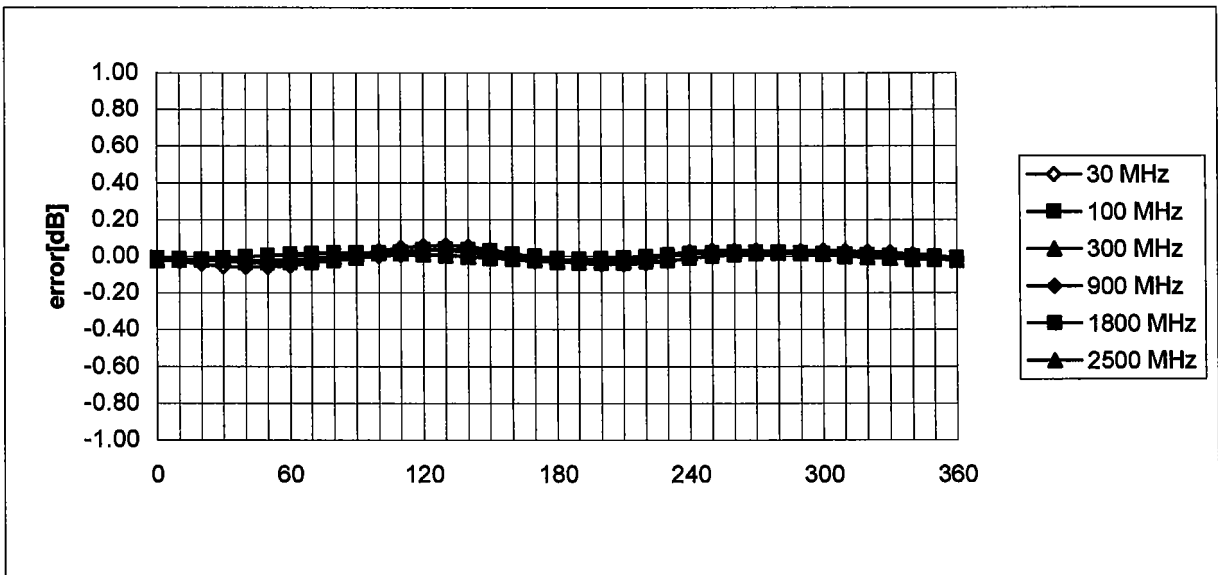

Frequency Response of E-Field

(TEM-Cell:ifi110, Waveguide R22)

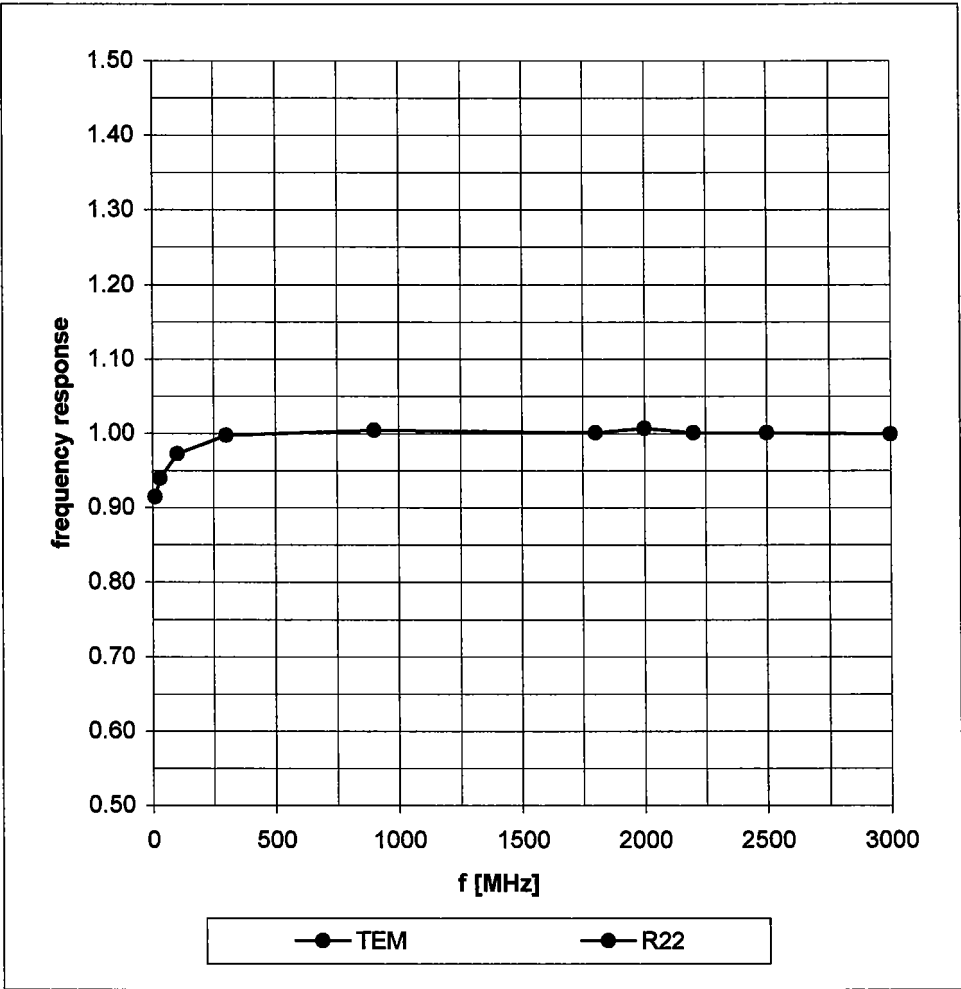

Dynamic Range f(SAR_{brain}) (Waveguide R22)

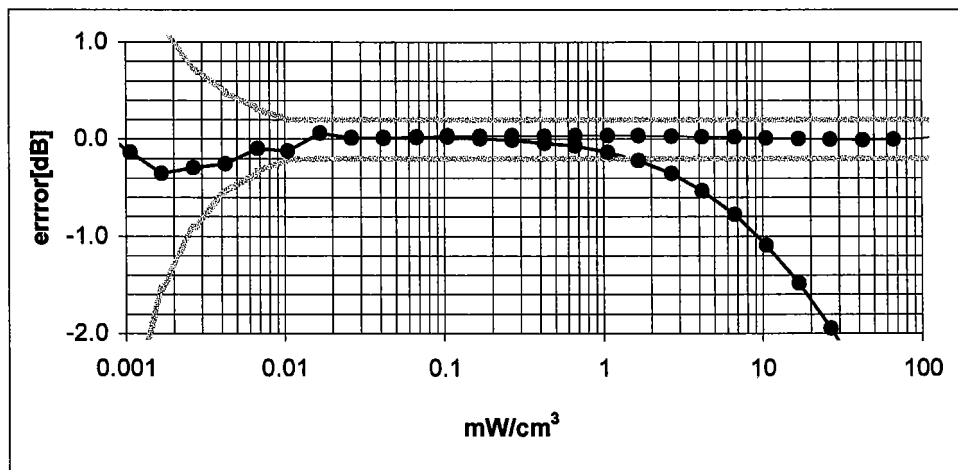
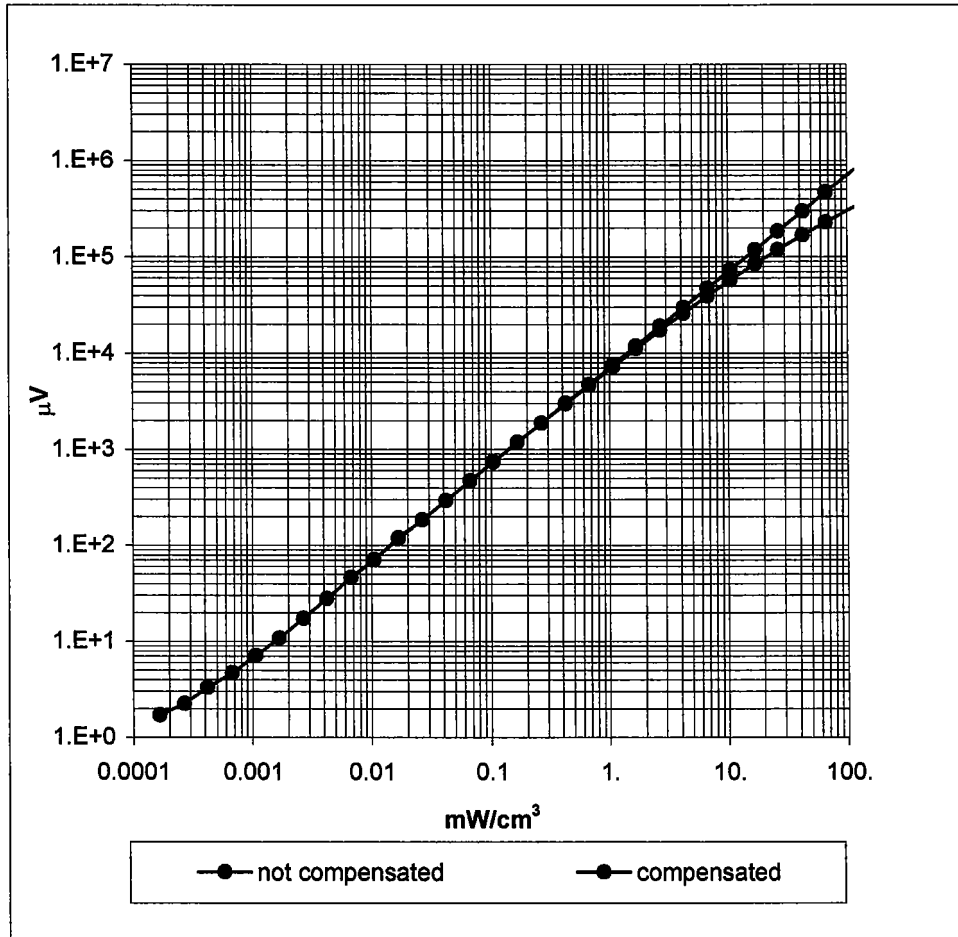

Conversion Factor Assessment

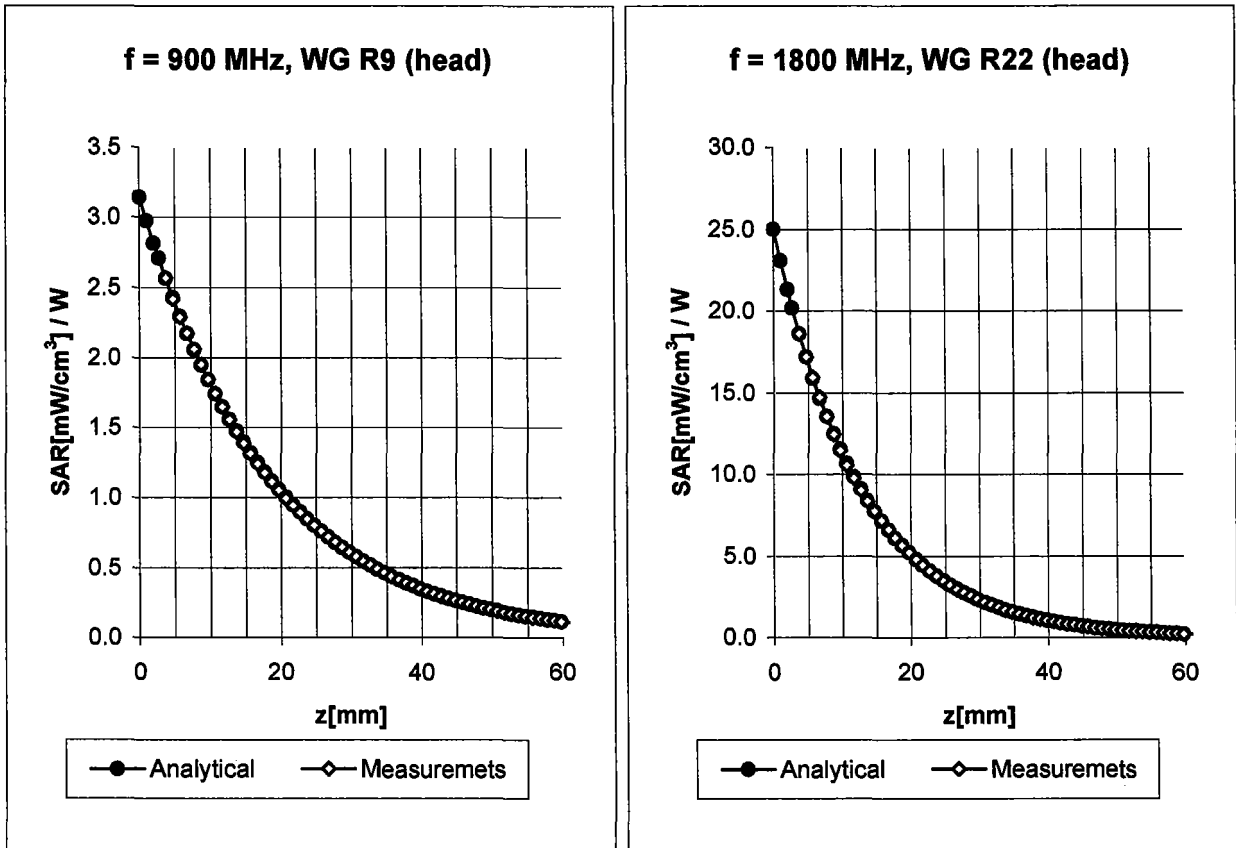

Head	900 MHz	$\epsilon_r = 41.5 \pm 5\%$	$\sigma = 0.97 \pm 5\% \text{ mho/m}$
Valid for f=800-1000 MHz with Head Tissue Simulating Liquid according to EN 50361, P1528-200X			
	ConvF X	6.3 $\pm 9.5\%$ (k=2)	Boundary effect:
	ConvF Y	6.3 $\pm 9.5\%$ (k=2)	Alpha 0.58
	ConvF Z	6.3 $\pm 9.5\%$ (k=2)	Depth 1.95

Head	1800 MHz	$\epsilon_r = 40.0 \pm 5\%$	$\sigma = 1.40 \pm 5\% \text{ mho/m}$
Valid for f=1710-1910 MHz with Head Tissue Simulating Liquid according to EN 50361, P1528-200X			
	ConvF X	5.1 $\pm 9.5\%$ (k=2)	Boundary effect:
	ConvF Y	5.1 $\pm 9.5\%$ (k=2)	Alpha 0.55
	ConvF Z	5.1 $\pm 9.5\%$ (k=2)	Depth 2.48

Conversion Factor Assessment

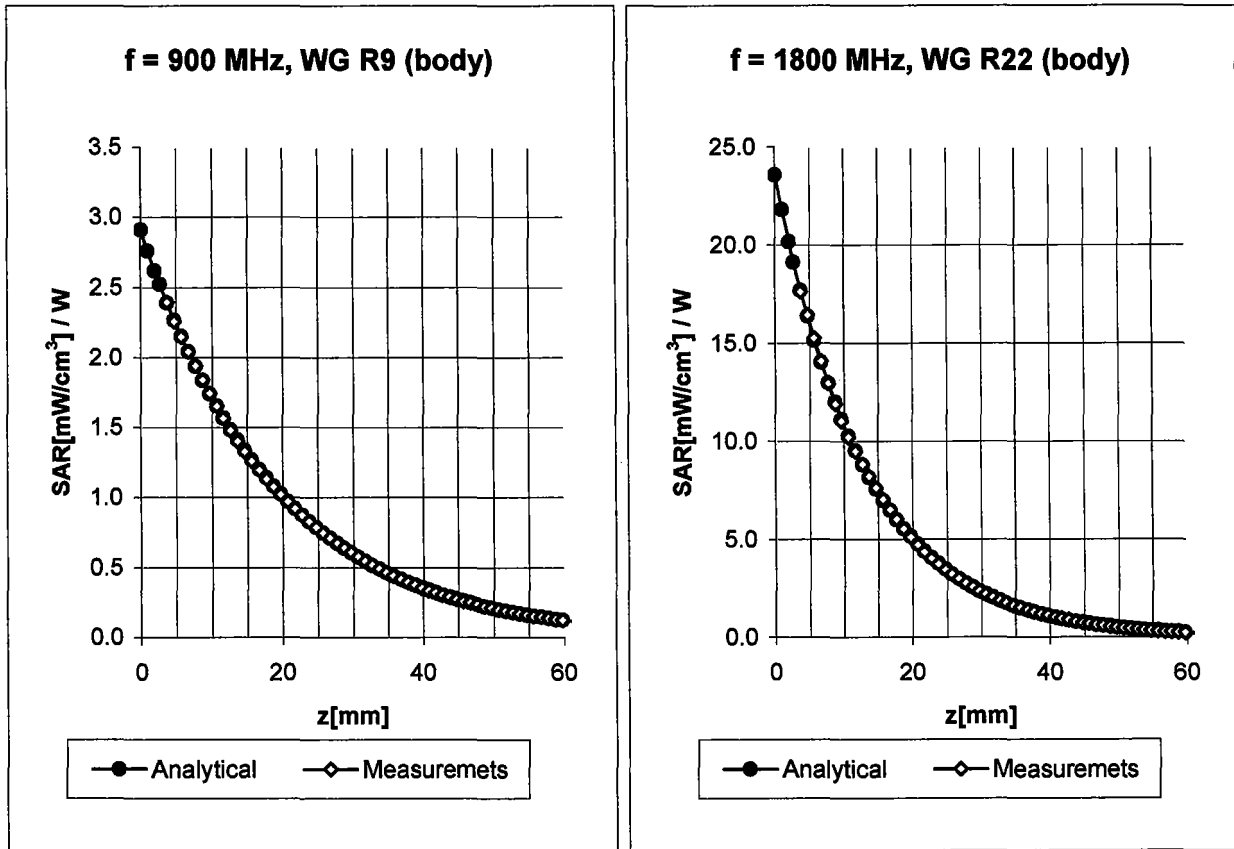

Body **900 MHz** $\epsilon_r = 55.0 \pm 5\%$ $\sigma = 1.05 \pm 5\% \text{ mho/m}$

Valid for f=800-1000 MHz with Head Tissue Simulating Liquid according to OET 65 Suppl. C

ConvF X	6.1 $\pm 9.5\%$ (k=2)	Boundary effect:
ConvF Y	6.1 $\pm 9.5\%$ (k=2)	Alpha 0.51
ConvF Z	6.1 $\pm 9.5\%$ (k=2)	Depth 2.18

Body **1800 MHz** $\epsilon_r = 53.3 \pm 5\%$ $\sigma = 1.52 \pm 5\% \text{ mho/m}$

Valid for f=1710-1910 MHz with Head Tissue Simulating Liquid according to OET 65 Suppl. C

ConvF X	4.7 $\pm 9.5\%$ (k=2)	Boundary effect:
ConvF Y	4.7 $\pm 9.5\%$ (k=2)	Alpha 0.57
ConvF Z	4.7 $\pm 9.5\%$ (k=2)	Depth 2.85

Conversion Factor Assessment

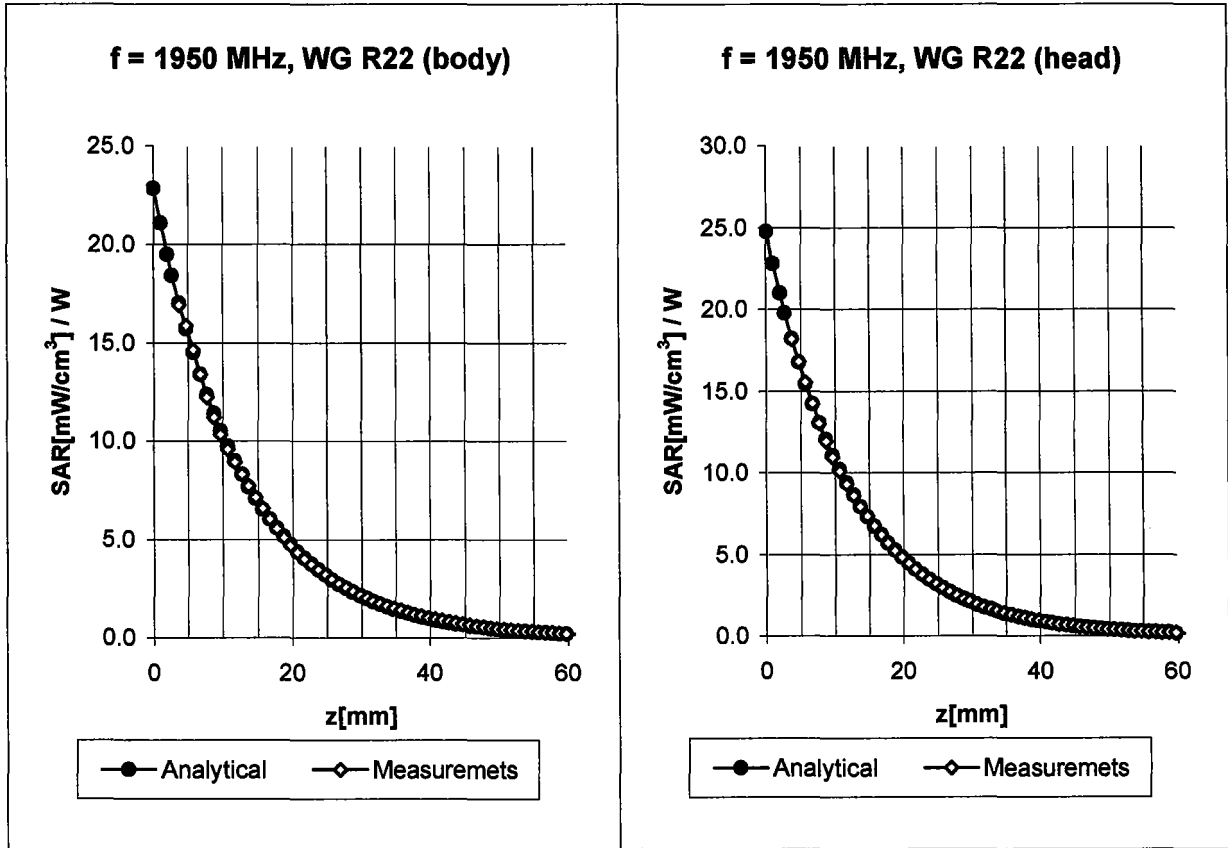

Body	1950 MHz	$\epsilon_r = 53.3 \pm 5\%$	$\sigma = 1.52 \pm 5\% \text{ mho/m}$
	ConvF X	4.5 $\pm 9.5\%$ (k=2)	Boundary effect:
	ConvF Y	4.5 $\pm 9.5\%$ (k=2)	Alpha 0.80
	ConvF Z	4.5 $\pm 9.5\%$ (k=2)	Depth 2.23

Head	1950 MHz	$\epsilon_r = 40.0 \pm 5\%$	$\sigma = 1.40 \pm 5\% \text{ mho/m}$
	ConvF X	5.0 $\pm 8.9\%$ (k=2)	Boundary effect:
	ConvF Y	5.0 $\pm 8.9\%$ (k=2)	Alpha 0.60
	ConvF Z	5.0 $\pm 8.9\%$ (k=2)	Depth 2.44

Conversion Factor Assessment

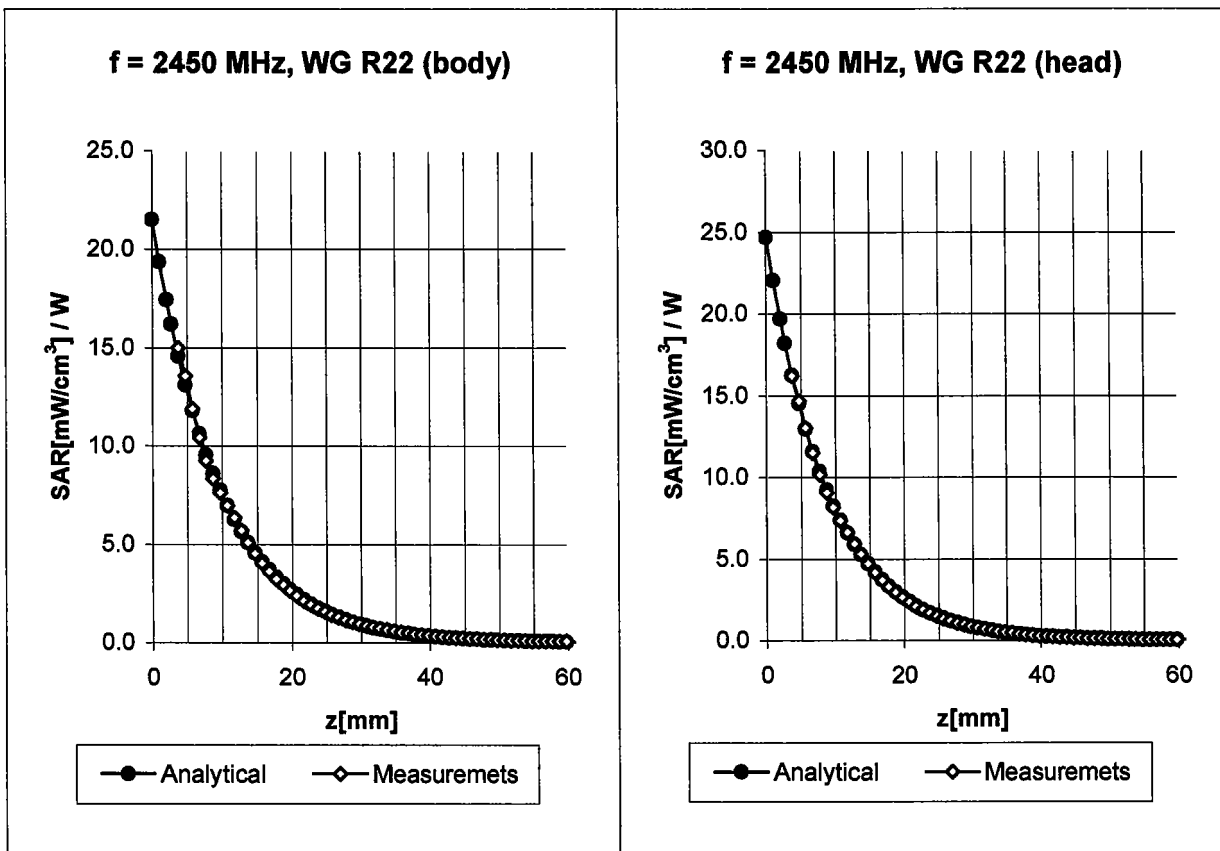

Body 2450 MHz $\epsilon_r = 52.7 \pm 5\%$ $\sigma = 1.95 \pm 5\%$ mho/m

Valid for f=2400-2500 MHz with Body Tissue Simulating Liquid according to OET 65 Suppl. C

ConvF X	4.4 \pm 8.9% (k=2)	Boundary effect:
ConvF Y	4.4 \pm 8.9% (k=2)	Alpha 1.55
ConvF Z	4.4 \pm 8.9% (k=2)	Depth 1.45

Head 2450 MHz $\epsilon_r = 39.2 \pm 5\%$ $\sigma = 1.80 \pm 5\%$ mho/m

Valid for f=2400-2500 MHz with Head Tissue Simulating Liquid according to EN 50361, P1528-200X

ConvF X	4.7 \pm 8.9% (k=2)	Boundary effect:
ConvF Y	4.7 \pm 8.9% (k=2)	Alpha 1.24
ConvF Z	4.7 \pm 8.9% (k=2)	Depth 1.67

Deviation from Isotropy in HSL

Error ($\theta\phi$), $f = 900$ MHz

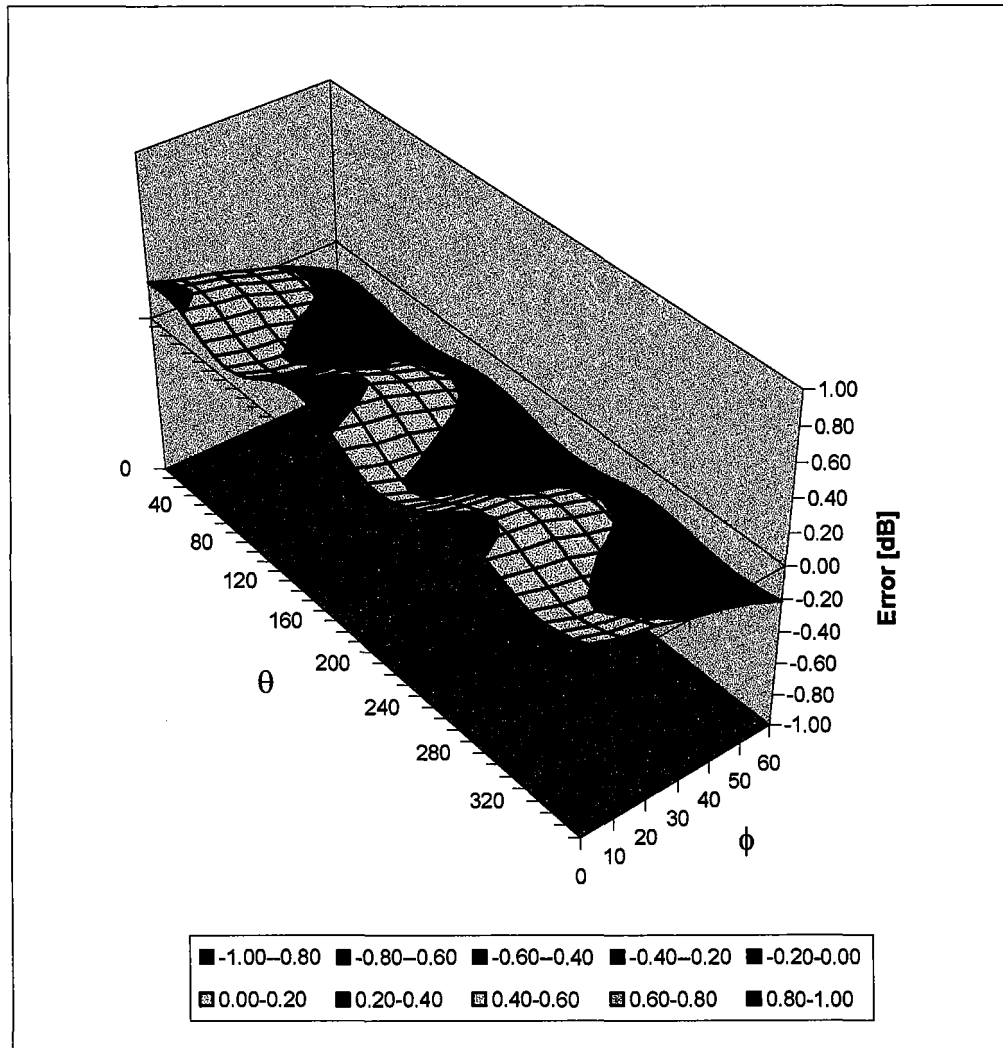

Appendix 5

Dipole Characterization Certificate

Certification of System Performance Check Targets

Based on APP-0396

-Historical Data-

	835MHz	900MHz	1800MHz	1900MHz	
P1528 Target: Advanced Extrapolation	9.5	10.8	38.1	39.7	(W/kg)
Measurement Uncertainty (k=1):	10.2%	10.2%	10.2%	10.2%	
Measurement Period:	November '02 - June '03	November '02 - June '03	November '02 - June '03	November '02 - June '03	
# of tests performed:	169	728	868	26	
Grand Average: Worst Case Extrapolation	10.1	11.6	39.7	42.0	(W/kg)
% Delta (Average - P1528 Target)	6.5%	7.7%	4.2%	5.9%	
Is % Delta <= Measurement Uncertainty?	Yes	Yes	Yes	Yes	
Accept/Reject Average as new system performance check target?	ACCEPT	ACCEPT	ACCEPT	ACCEPT	
	Applicable 835MHz Dipole Serial Numbers:	Applicable 900MHz Dipole Serial Numbers:	Applicable 1800MHz Dipole Serial Numbers:	Applicable 1900MHz Dipole Serial Numbers:	
	420(TR), 421(TR)	77, 78	246(TR), 250(TR)	514(TR), 518(TR)	
	422(TR), 423(TR)	79, 80	251(TR), 258(TR)	519(TR), 520(TR)	
	424(TR), 425(TR)	91, 92	259(TR), 262(TR)	523(TR), 524(TR)	
	431(TR), 432(TR)	93, 94	263(TR), 271(TR)	526(TR), 527(TR)	
	433(TR), 434(TR)	95, 96	272(TR), 273(TR)	528(TR), 529(TR)	
	436(TR)	97	276(TR), 277(TR)	530(TR), 533(TR)	
			279(TR), 280(TR)		
			281(TR), 282(TR)		
			283(TR), 284(TR)		

-New System Performance Check Targets- per APP-0396

(based on analysis of historical data)

Frequency	SAR Target (W/kg)	Permittivity	Conductivity (S/m)
835MHz	10.1	41.5 ± 5%	0.90 ± 5%
900MHz	11.6	41.5 ± 5%	0.97 ± 5%
1800MHz	39.7	40.0 ± 5%	1.40 ± 5%
1900MHz	42.0	40.0 ± 5%	1.40 ± 5%

-Approvals-

Submitted by: Date:

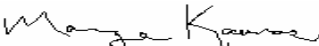
Signed: 

Comments:

Approved by: Date:

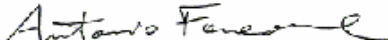
Signed: 

Comments:

Appendix 6
Measurement Uncertainty Budget

Uncertainty Budget for Device Under Test									
<i>a</i>	<i>b</i>	<i>c</i>	<i>d</i>	<i>e = f(d,k)</i>	<i>f</i>	<i>g</i>	<i>h = c x f / e</i>	<i>i = c x g / e</i>	<i>k</i>
Uncertainty Component	Sec.	Tol. (± %)	Prob. Dist.	Div.	<i>c_i</i> (1 g)	<i>c_i</i> (10 g)	1 g <i>u_i</i> (±%)	10 g <i>u_i</i> (±%)	<i>v_i</i>
Measurement System									
Probe Calibration	E.2.1	9.5	N	2.00	1	1	4.8	4.8	∞
Axial Isotropy	E.2.2	4.7	R	1.73	0.707	0.707	1.9	1.9	∞
Spherical Isotropy	E.2.2	9.6	R	1.73	0.707	0.707	3.9	3.9	∞
Boundary Effect	E.2.3	5.8	R	1.73	1	1	3.3	3.3	∞
Linearity	E.2.4	4.7	R	1.73	1	1	2.7	2.7	∞
System Detection Limits	E.2.5	1.0	R	1.73	1	1	0.6	0.6	∞
Readout Electronics	E.2.6	1.0	N	1.00	1	1	1.0	1.0	∞
Response Time	E.2.7	0.8	R	1.73	1	1	0.5	0.5	∞
Integration Time	E.2.8	1.3	R	1.73	1	1	0.8	0.8	∞
RF Ambient Conditions	E.6.1	3.0	R	1.73	1	1	1.7	1.7	∞
Probe Positioner Mechanical Tolerance	E.6.2	0.3	R	1.73	1	1	0.2	0.2	∞
Probe Positioning with respect to Phantom Shell	E.6.3	1.1	R	1.73	1	1	0.6	0.6	∞
Extrapolation, interpolation and Integration Algorithms for Max SAR Evaluation	E.5	3.9	R	1.73	1	1	2.3	2.3	∞
Test sample Related									
Test Sample Positioning	E.4.2	3.6	N	1.00	1	1	3.6	3.6	29
Device Holder Uncertainty	E.4.1	2.8	N	1.00	1	1	2.8	2.8	8
Output Power Variation - SAR drift measurement	6.6.2	5.0	R	1.73	1	1	2.9	2.9	∞
Phantom and Tissue Parameters									
Phantom Uncertainty (shape and thickness tolerances)	E.3.1	4.0	R	1.73	1	1	2.3	2.3	∞
Liquid Conductivity - deviation from target values	E.3.2	5.0	R	1.73	0.64	0.43	1.8	1.2	∞
Liquid Conductivity - measurement uncertainty	E.3.3	10.0	R	1.73	0.64	0.43	3.7	2.5	∞
Liquid Permittivity - deviation from target values	E.3.2	10.0	R	1.73	0.6	0.49	3.5	2.8	∞
Liquid Permittivity - measurement uncertainty	E.3.3	5.0	R	1.73	0.6	0.49	1.7	1.4	∞
Combined Standard Uncertainty			RSS				11.72	11.09	1363
Expanded Uncertainty (95% CONFIDENCE LEVEL)			<i>k</i> =2				22.98	21.75	

Uncertainty Budget for System Performance Check (dipole & flat phantom)

<i>a</i>	<i>b</i>	<i>c</i>	<i>d</i>	$e = f(d, k)$	<i>f</i>	<i>g</i>	$h = c \times f / e$	$i = c \times g / e$	<i>k</i>
Uncertainty Component	Sec.	Tol.	Prob.	Div.	<i>c_i</i>	<i>c_i</i>	1 g	10 g	<i>v_i</i>
		(± %)	Dist.		(1 g)	(10 g)	<i>u_i</i>	<i>u_i</i>	
Measurement System									
Probe Calibration	E.2.1	9.5	N	2.00	1	1	4.8	4.8	∞
Axial Isotropy	E.2.2	4.7	R	1.73	1	1	2.7	2.7	∞
Spherical Isotropy	E.2.2	9.6	R	1.73	0	0	0.0	0.0	∞
Boundary Effect	E.2.3	5.8	R	1.73	1	1	3.3	3.3	∞
Linearity	E.2.4	4.7	R	1.73	1	1	2.7	2.7	∞
System Detection Limits	E.2.5	1.0	R	1.73	1	1	0.6	0.6	∞
Readout Electronics	E.2.6	1.0	N	1.00	1	1	1.0	1.0	∞
Response Time	E.2.7	0.0	R	1.73	1	1	0.0	0.0	∞
Integration Time	E.2.8	0.0	R	1.73	1	1	0.0	0.0	∞
RF Ambient Conditions	E.6.1	3.0	R	1.73	1	1	1.7	1.7	∞
Probe Positioner Mechanical Tolerance	E.6.2	0.3	R	1.73	1	1	0.2	0.2	∞
Probe Positioning with respect to Phantom Shell	E.6.3	1.1	R	1.73	1	1	0.6	0.6	∞
Extrapolation, interpolation and Integration Algorithms for Max. SAR Evaluation	E.5	3.9	R	1.73	1	1	2.3	2.3	∞
Dipole									
Dipole Axis to Liquid Distance	8, E.4.2	1.0	R	1.73	1	1	0.6	0.6	∞
Input Power and SAR Drift Measurement	8, 6.6.2	4.7	R	1.73	1	1	2.7	2.7	∞
Phantom and Tissue Parameters									
Phantom Uncertainty (shape and thickness tolerances)	E.3.1	4.0	R	1.73	1	1	2.3	2.3	∞
Liquid Conductivity - deviation from target values	E.3.2	5.0	R	1.73	0.64	0.43	1.8	1.2	∞
Liquid Conductivity - measurement uncertainty	E.3.3	10.0	R	1.73	0.64	0.43	3.7	2.5	∞
Liquid Permittivity - deviation from target values	E.3.2	10.0	R	1.73	0.6	0.49	3.5	2.8	∞
Liquid Permittivity - measurement uncertainty	E.3.3	5.0	R	1.73	0.6	0.49	1.7	1.4	∞
Combined Standard Uncertainty			RSS				10.16	9.43	99999
Expanded Uncertainty (95% CONFIDENCE LEVEL)			<i>k</i> =2				19.92	18.48	

Appendix 7

Photographs of the device under test



Front of Phone



Back of Phone



Phone Placed Against Phantom Head in Check Touch Position (front view)



Phone Placed Against Phantom Head in Check Touch Position (rear view)

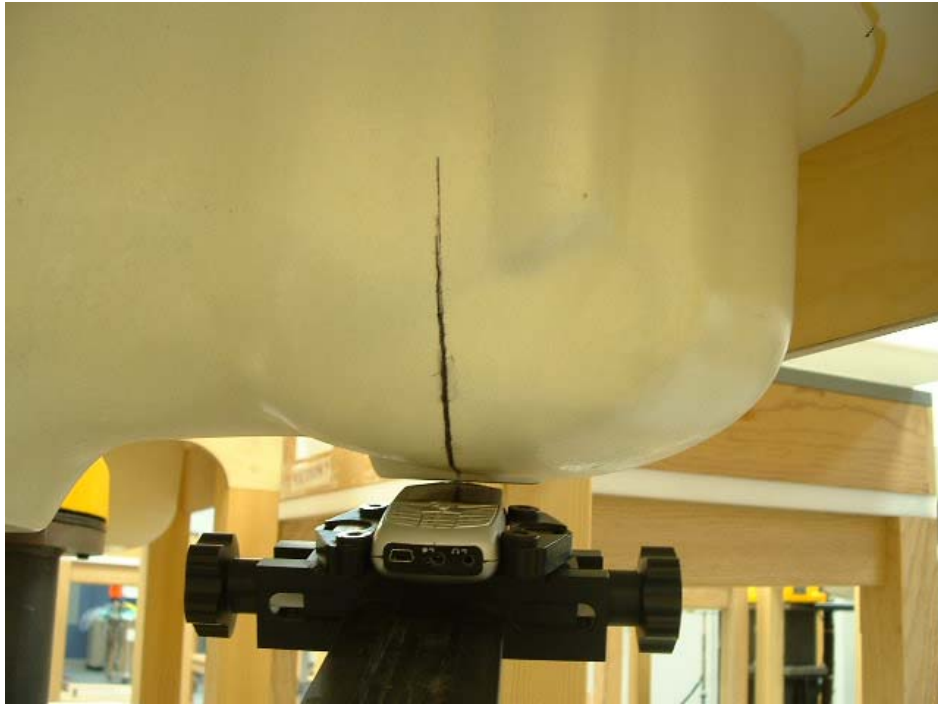

Phone Placed Against Phantom Head in 15 Degree Tilt Position (front view)



Phone Placed Against Phantom Head in 15 Degree Tilt Position (rear view)



Phone with No Available Body-worn Cases Positioned Below Phantom