



Exhibit 11: Class II Permissive Change SAR Test Report IHDT56DR1

Date of test: 20 Dec, 2003 & 8 Jan, 2004
Date of Report: 14 Jan, 2004

Laboratory: Motorola Personal Communications Sector Product Safety & Compliance Laboratory
 600 N. US Highway 45
 Room: MW113
 Libertyville, Illinois 60048

Test Responsible: Steven Hauswirth
 Principal Staff Engineer

Accreditation: This laboratory is accredited to ISO/IEC 17025-1999 to perform the following tests:



<p><u>Tests:</u> Electromagnetic Specific Absorption Rate</p> <p>Simulated Tissue Preparation RF Power Measurement</p>	<p><u>Procedures:</u> ANSI/IEEE C95.1-1992, 1999 (SAR) IEEE C95.3-1991 IEEE P1528 (<i>DRAFT</i>) FCC OET Bulletin 65 (<i>including Supplements A, B, C</i>) Australian Communications Authority Radio Communications (Electromagnetic Radiation – Human Exposure) Standard 1999 CENELEC EN 50361 (2001) APP-0247 DOI-0876, 0900, 0902, 0904, 0915</p>
--	---

On the following products or types of products:
 Wireless Communications Devices (Examples): Two Way Radios; Portable Phones (including Cellular, Licensed Non-Broadcast and PCS); Low Frequency Readers; and Pagers

A2LA certificate #1651-01

Statement of Compliance: Motorola declares under its sole responsibility that portable cellular telephone FCC ID IHDT56DR1 to which this declaration relates, is in conformity with the appropriate General Population/Uncontrolled RF exposure standards, recommendations and guidelines (FCC 47 CFR §2.1093). It also declares that the product was tested in accordance with the appropriate measurement standards, guidelines and recommended practices. Any deviations from these standards, guidelines and recommended practices are noted below:

(none)

©Motorola, Inc. 2004

This test report shall not be reproduced except in full, without written approval of the laboratory.

The results and statements contained herein relate only to the items tested. The names of individuals involved may be mentioned only in connection with the statements or results from this report.

Motorola encourages all feedback, both positive and negative, on this test report.

Table of Contents

1. INTRODUCTION..... 3

2. DESCRIPTION OF THE DEVICE UNDER TEST 3

2.1 Antenna description.....3

3. TEST EQUIPMENT USED..... 3

3.1 Dosimetric System3

3.2 Additional Equipment.....4

4. ELECTRICAL PARAMETERS OF THE TISSUE SIMULATING LIQUID 4

5. SYSTEM ACCURACY VERIFICATION..... 5

6. TEST RESULTS 5

6.1 Body Worn Test Results6

APPENDIX 1: SAR DISTRIBUTION COMPARISON FOR SYSTEM ACCURACY VERIFICATION..... 8

APPENDIX 2: SAR DISTRIBUTION PLOTS FOR BODY WORN CONFIGURATION..... 9

APPENDIX 3: PROBE CALIBRATION CERTIFICATE 11

APPENDIX 4: DIPOLE CHARACTERIZATION CERTIFICATE..... 12

APPENDIX 5: MEASUREMENT UNCERTAINTY BUDGET..... 13

APPENDIX 6: PHOTOGRAPHS OF DEVICE UNDER TEST 16

1. Introduction

The Motorola Personal Communications Sector Product Safety Laboratory has performed measurements of the maximum potential exposure to the user of portable cellular phone (FCC ID IHDT56DR1). The Specific Absorption Rate (SAR) of this product was measured. The portable cellular phone was tested in accordance with FCC OET Bulletin 65 Supplement C 01-01.

2. Description of the Device Under Test

a. Antenna description

Type	Stubby	
Location	Right Side	
Dimensions	Length	21 mm
	Width	10 mm
Configuration	Fixed	

b. Device description

FCC ID Number	IHDT56DR1								
Serial number	LV60D20022								
Mode(s) of Operation	GSM 850	GSM 900	GSM 1800	GSM 1900	GPRS 850	GPRS 900	GPRS 1800	GPRS 1900	Blue Tooth
Modulation Mode(s)	GSM	GSM	GSM	GSM	GSM	GSM	GSM	GSM	Blue Tooth
Maximum Output Power Setting	33.00 dBm	32.50 dBm	30.00 dBm	30.00 dBm	33.00 dBm	32.50 dBm	30.00 dBm	30.00 dBm	4.00 dBm
Duty Cycle	1:8	1:8	1:8	1:8	2:8	2:8	2:8	2:8	1:1
Transmitting Frequency Rang(s)	824.2-848.8 MHz	880.2-914.8 MHz	1710.2-1784.8 MHz	1850.20 - 1909.80 MHz	824.2-848.8 MHz	880.2-914.8 MHz	1710.2-1784.8 MHz	1850.20 - 1909.80 MHz	2400 - 2483.5 MHz
Production Unit or Identical Prototype (47 CFR §2.908)	Identical Prototype								
Device Category	Portable								
RF Exposure Limits	General Population / Uncontrolled								

3. Test Equipment Used

3.1 Dosimetric System

The Motorola Personal Communications Sector Product Safety & Compliance Laboratory utilizes a Dosimetric Assessment System (Dasy3™ v3.1d) manufactured by Schmid & Partner Engineering AG (SPEAG™), of Zurich Switzerland. All the SAR measurements are taken within a shielded enclosure. The overall RSS uncertainty of the measurement system is ±11.7% (K=1) with an expanded uncertainty of ±23.0% (K=2). The measurement uncertainty budget is given in Appendix 6. Per IEEE 1528, this uncertainty budget is applicable to the SAR range of 0.4 W/kg to 10 W/kg. The list of calibrated equipment used for the measurements is shown below.

Description	Serial Number	Cal Due Date
DASY3 DAE V1	SN378	30-May-04
E-Field Probe ET3DV6	SN1514	31-Jul-04
Dipole Validation Kit, D900V2	SN096	24-Jun-04
DASY3 DAE V1	SN440	17-Mar-04
E-Field Probe ET3DV6	SN1520	9-Jun-04
Dipole Validation Kit, D1800V2	SN281TR	24-Jun-04

3.2 Additional Equipment

Description	Serial Number	Cal Due Date
Signal Generator HP8648C	3847A04632	10-Oct-04
Power Meter E4419B	GB39511090	06-Feb-04
Power Sensor #1 - E9301A	US39211007	06-Feb-04
Power Sensor #2 - E9301A	US39210931	06-Feb-04
Network Analyzer HP8753ES	US39171846	03-June-04
Dielectric Probe Kit HP85070B	US99360074	N/A

4. Electrical parameters of the tissue simulating liquid

Prior to conducting SAR measurements, the relative permittivity, ϵ_r , and the conductivity, σ , of the tissue simulating liquids were measured with the HP85070 Dielectric Probe Kit. These values, along with the temperature of the tissue simulate are shown in the table below. The recommended limits for maximum permittivity and minimum conductivity are also shown. These come from the Federal Communication Commission, OET Bulletin 65 Supplement C 01-01. It is seen that the measured parameters are satisfactory for compliance testing.

f (MHz)	Tissue type	Limits / Measured	Dielectric Parameters		
			ϵ_r	σ (S/m)	Temp (°C)
835	Body	Measured, 8-Jan-04	54.4	0.99	19.1
		Recommended Limits	55.2 ±5%	0.97 ±5%	18-25
1880	Body	Measured, 20-Dec-03	51.6	1.58	18.8
		Recommended Limits	53.3 ±5%	1.52 ±5%	18-25

The list of ingredients and the percent composition used for the tissue simulates are indicated in the table below.

Ingredient	800MHz Head	800MHz Body	1900MHz Head	1900MHz Body
Sugar	57.0	44.9	--	30.80
DGBE	--	--	47.0	--
Water	40.45	53.06	52.8	68.91
Salt	1.45	0.94	0.2	0.29
HEC	1.0	1.0	--	--
Bact.	0.1	0.1	--	--

5. System Accuracy Verification

A system accuracy verification of the DASY3 was performed using the measurement equipment listed in Section 3.1. The daily system accuracy verification occurs within center section of the SAM phantom.

A SAR measurement was performed to see if the measured SAR was within +/- 10% from the target SAR indicated on the dipole certification sheet. These tests were done at 900MHz and/or 1800MHz. These frequencies are within 100MHz of the mid-band frequency of the test device. This is within the allowable window given in Supplement C 01-01 *Appendix D System Verification* section item #5. The test was conducted on the same days as the measurement of the DUT. Recommended limits for maximum permittivity, minimum conductivity are shown in the table below. These come from the Federal Communication Commission, OET Bulletin 65 Supplement C 01-01. The obtained results from the system accuracy verification are displayed in the table below. The distributions of SAR compare well with those of the reference measurements (see Appendix 1). The tissue stimulant depth was verified to be 15.0cm ±0.5cm. Z-axis scans showing the SAR penetration are also included in Appendix 1. SAR values are normalized to 1W forward power delivered to the dipole.

f (MHz)	Description	SAR (W/kg), 1gram	Dielectric Parameters		Ambient Temp (°C)	Tissue Temp (°C)
			ε _r	σ (S/m)		
900	Measured, 8-Jan-04	11.1	40.3	0.96	21	19.0
	Recommended Limits	11.6	41.5 ±5%	0.97 ±5%	18-25	18-25
1800	Measured, 19-Dec-03	41.7	39.3	1.37	20	18.3
	Recommended Limits	39.7	40.0 ±5%	1.4 ±5%	18-25	18-25

The following probe conversion factors were used on the E-Field probe(s) used for the system accuracy verification measurements:

Description	Serial Number	f (MHz)	Conversion Factor	Cal Cert pg #
E-Field Probe ET3DV6	SN1514	900	6.30	7 of 11
E-Field Probe ET3DV6	SN1520	1900	5.10	7 of 9

6. Test Results

The test sample was operated in a test mode that allows control of the transmitter without the need to place actual phone calls. For the purposes of this test the unit is commanded to test mode and manually set to the proper channel, transmitter power level and transmit mode of operation. The phone was tested in the configurations stipulated in OET Bulletin 65 Supplement C 01-01. Motorola also followed the requirements in Supplement. C / Appendix D: SAR Measurement Procedures, section titled “*Devices Operating Next To A Person’s Ear* “. These directions state “The device should be tested on the left and right side of the head phantom in the “Cheek/Touch” and “Ear/Tilt” positions. When applicable, each configuration should be tested with the antenna in its fully extended and fully retracted positions. These test configurations should be tested at the high, middle and low frequency channels of each operating mode; for example, AMPS, CDMA, and TDMA. If the SAR measured at the middle channel for each test configuration (left, right, Cheek/Touch, Tile/Ear, extended and retracted) is at least 2.0 dB lower than the SAR limit, testing at the high and low channels is optional for such test configuration(s).“

The DASY v3.1d SAR measurement system specified in section 3.1 was utilized within the intended operations as set by the SPEAG™ setup. The phone was positioned into the measurement configurations using the positioner supplied with the DASY 3.1d SAR measurement system. The measured dielectric constant of the material used for the positioner is less than 2.9 and the loss tangent is less than 0.02 (± 30%) at 850MHz. The default settings for the “coarse” and “cube” scans were chosen and use for measurements. The grid spacing of the course scan was set to 15cm as shown in the SAR plots included in appendix 2 and 3. Please refer to the DASY manual for additional information on SAR scanning procedures and algorithms used.

The Cellular Phone (FCC ID IHDT56DR1) has the SNN5704A as the only available battery option. This battery was used to do all of the SAR testing. The phone was placed in the SAR measurement system with a fully charged battery.

6.1 Body Worn Test Results

The SAR results shown in table 1 are the maximum SAR values averaged over 1 gram of phantom tissue. Also shown are the measured conducted output powers, the temperature of the test facility during the test, the temperature of the tissue simulate after the test, the measured drift and the extrapolated SAR. The exact method of extrapolation is $New\ SAR = Old\ SAR * 10^{(-drift/10)}$. The SAR reported at the end of the measurement process by the DASY™ measurement system can be scaled up by the measured drift to determine the SAR at the beginning of the measurement process. This is the most conservative SAR because it corresponds to the average output power at the beginning of the SAR test. This extrapolation has been done because when the DUT is operating properly it may exhibit a slump in radiated power and SAR over time. This is verified by measuring the SAR drift after the test. The test conditions indicated as bold numbers in the following table are included in Appendix 3. Note that 800MHz digital mode SAR measurements were performed in accordance with OET Bulletin 65 Supplement C 01-01. All other test conditions measured lower SAR values than those included in Appendix 3.

A “flat” phantom was for the body-worn tests. This “flat” phantom is made out of 1” thick natural High Density Polyethylene with a thickness at the bottom equal to 2.0mm. It measures 52.7cm(long) x 26.7cm(wide) x 21.2cm(tall). The measured dielectric constant of the material used is less than 2.3 and the loss tangent is less than 0.0046 all the way up to 2.184GHz.

The tissue stimulant depth was verified to be 15.0cm ±0.5cm. The same device holder described in section 6 was used for positioning the phone. The functional accessories were divided into two categories, the ones with metal components and the ones with non-metal components. For non-metallic component accessories’, testing was performed on the accessory that displayed the closest proximity to the flat phantom. Each metallic component accessory, if any, was checked for uniqueness of metal component so that each is tested with the device. If multiple accessories shared an identical metal component, only the accessory that dictates the closest spacing to the body was tested. The cellular phone was tested with a headset connected to the device for all body-worn SAR measurements.

There is one new Body-Worn Accessories available for this phone:
MTO4366, black leather pouch

This new pouch covers both the data connector and the headset jack on the phone. So GPRS connections and use of the headset to make GSM voice calls is not intended. The phone is still capable of connections in Bluetooth mode. So SAR measurements were performed in GSM calls using a Bluetooth headset.

The following probe conversion factors were used on the E-Field probe(s) used for the body worn measurements:

Description	Serial Number	f (MHz)	Conversion Factor	Cal Cert pg #
E-Field Probe ET3DV6	SN1514	835	6.10	8 of 11
E-Field Probe ET3DV6	SN1520	1900	4.80	8 of 9

f (MHz)	Description	Conducted Output Power (dBm)	Body Worn w/ Bluetooth On			
			MTO4366 Pouch			
			Measured (W/kg)	Drift (dB)	Extrapolated (W/kg)	Simulate Temp (°C)
Digital 850MHz	Channel 128	32.98	0.705	-0.03	0.71	19.1
	Channel 190	32.96	1.03	-0.03	1.04	19.5
	Channel 251	32.97	0.873	-0.06	0.89	18.8
Digital 1900MHz	Channel 512	29.99	0.887	-0.01	0.89	18.9
	Channel 661	30.00	0.875	-0.02	0.88	18.9
	Channel 810	30.00	0.729	0.07	0.73	18.8

Table 1: SAR measurement results for the portable cellular telephone FCC ID IHDT56DR1 at highest possible output power. Measured against the body.

Appendix 1

SAR distribution comparison for the system accuracy verification

Dipole 900 MHz

900 MHz Dipole Validation / Dipole Sn# 096

Forward Power = 245mw Reflected Power = -23.20db

Room Temp at time of measurement = 21.0*C. Simulant Temp at time of measurement = 19.0*C

R4 TP-1131 SUGAR sam expanded (Rev. 2)-9Jan03; Flat

Probe: ET3DV6 - SN1514 - Validation.3; ConvF(6.30,6.30,6.30); Crest factor: 1.0; 900 MHz VALIDATION: $\sigma = 0.96$ mho/m $\epsilon_r = 40.3$ $\rho = 1.00$ g/cm³

Cubes (2): Peak: 4.31 mW/g ± 0.01 dB, SAR (1g): 2.73 mW/g ± 0.00 dB, SAR (10g): 1.73 mW/g ± 0.00 dB, (Worst-case extrapolation)

Penetration depth: 11.6 (10.8, 12.7) [mm]

Powerdrift: -0.10 dB

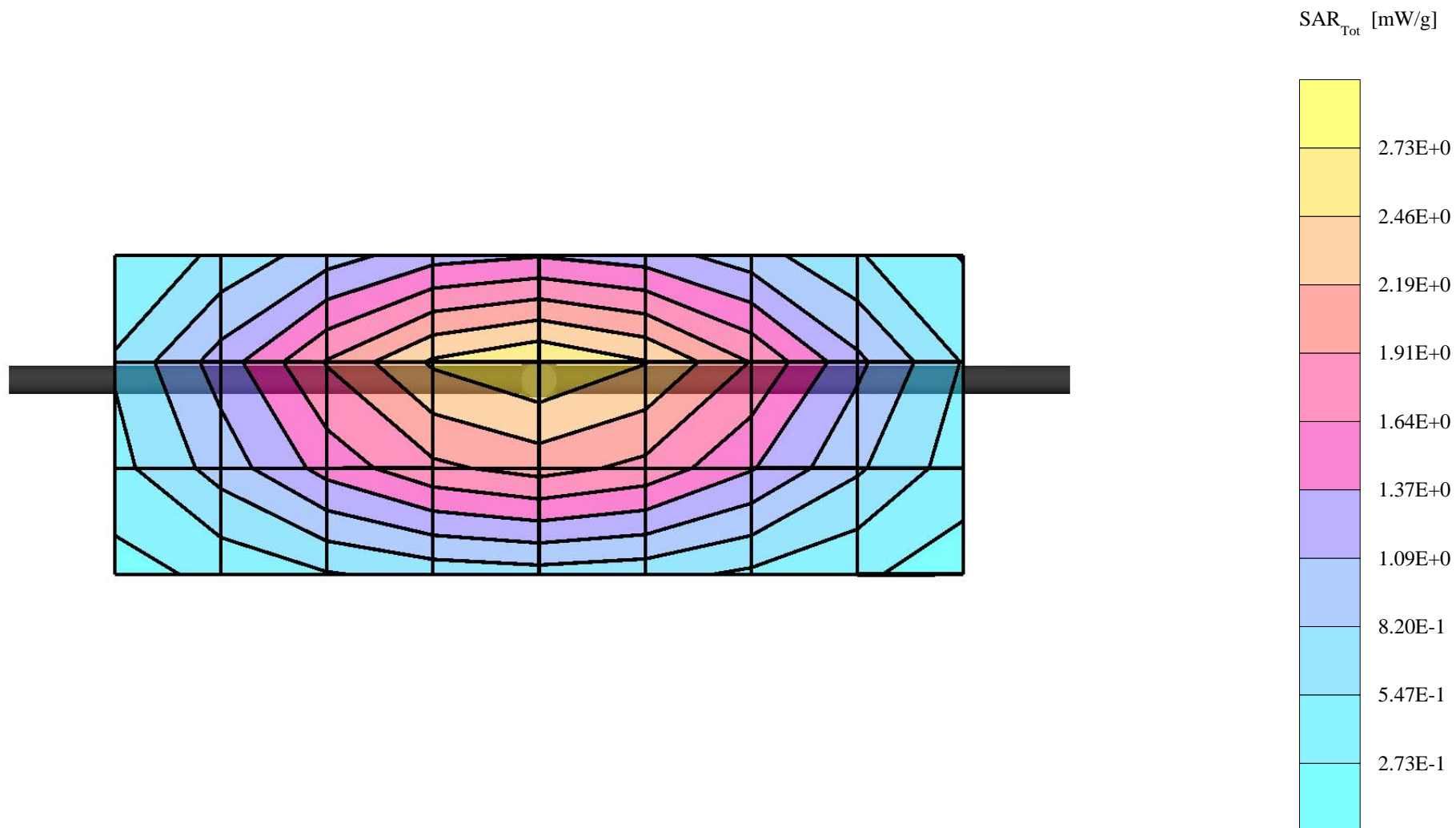

Dipole 900 MHz

900 MHz Dipole Validation / Dipole Sn# 096

Forward Power = 245mw Reflected Power = -23.20db

Room Temp at time of measurement = 21.0*C. Simulant Temp at time of measurement = 19.0*C

R4 TP-1131 SUGAR sam expanded (Rev. 2)-9Jan03 Phantom; Section; Position: ; Frequency: 900 MHz

Probe: ET3DV6 - SN1514 - Validation.3; ConvF(6.30,6.30,6.30); Crest factor: 1.0; 900 MHz VALIDATION: $\sigma = 0.96$ mho/m $\epsilon_r = 40.3$ $\rho = 1.00$ g/cm³

: , ()

Z-Axis: Dx = 0.0, Dy = 0.0, Dz = 5.0

Penetration depth: 11.5 (10.6, 12.7) [mm]

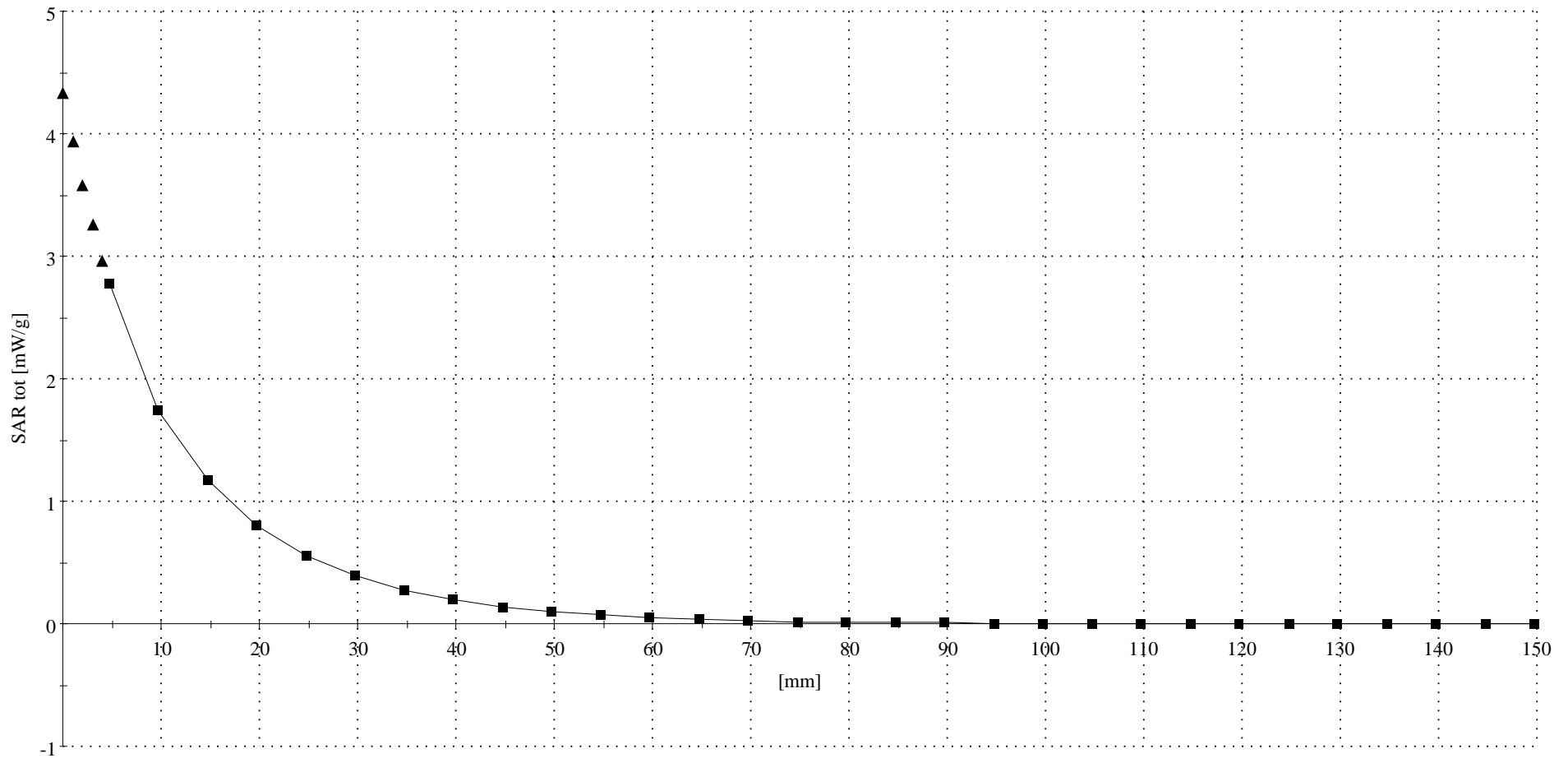

Dipole 1800 MHz

1800 MHz System Performance Check / Dipole Sn# 281tr

Forward Power = 252mW Reflected Power = -30.2dB

Room Temp at time of measurement = 20 Simulant Temp at time of measurement = 18.3

R3 Amy Twin Phantom Rev.4 (22Aug02); section 1

Probe: ET3DV6 - SN1520 - Validation.2; ConvF(5.10,5.10,5.10); Crest factor: 1.0; 1800 MHz VALIDATION: $\sigma = 1.37$ mho/m $\epsilon_r = 39.3$ $\rho = 1.00$ g/cm³

Cubes (2): Peak: 19.2 mW/g ± 0.01 dB, SAR (1g): 10.5 mW/g ± 0.01 dB, SAR (10g): 5.53 mW/g ± 0.02 dB, (Worst-case extrapolation)

Penetration depth: 8.5 (8.1, 9.3) [mm]

Powerdrift: -0.00 dB

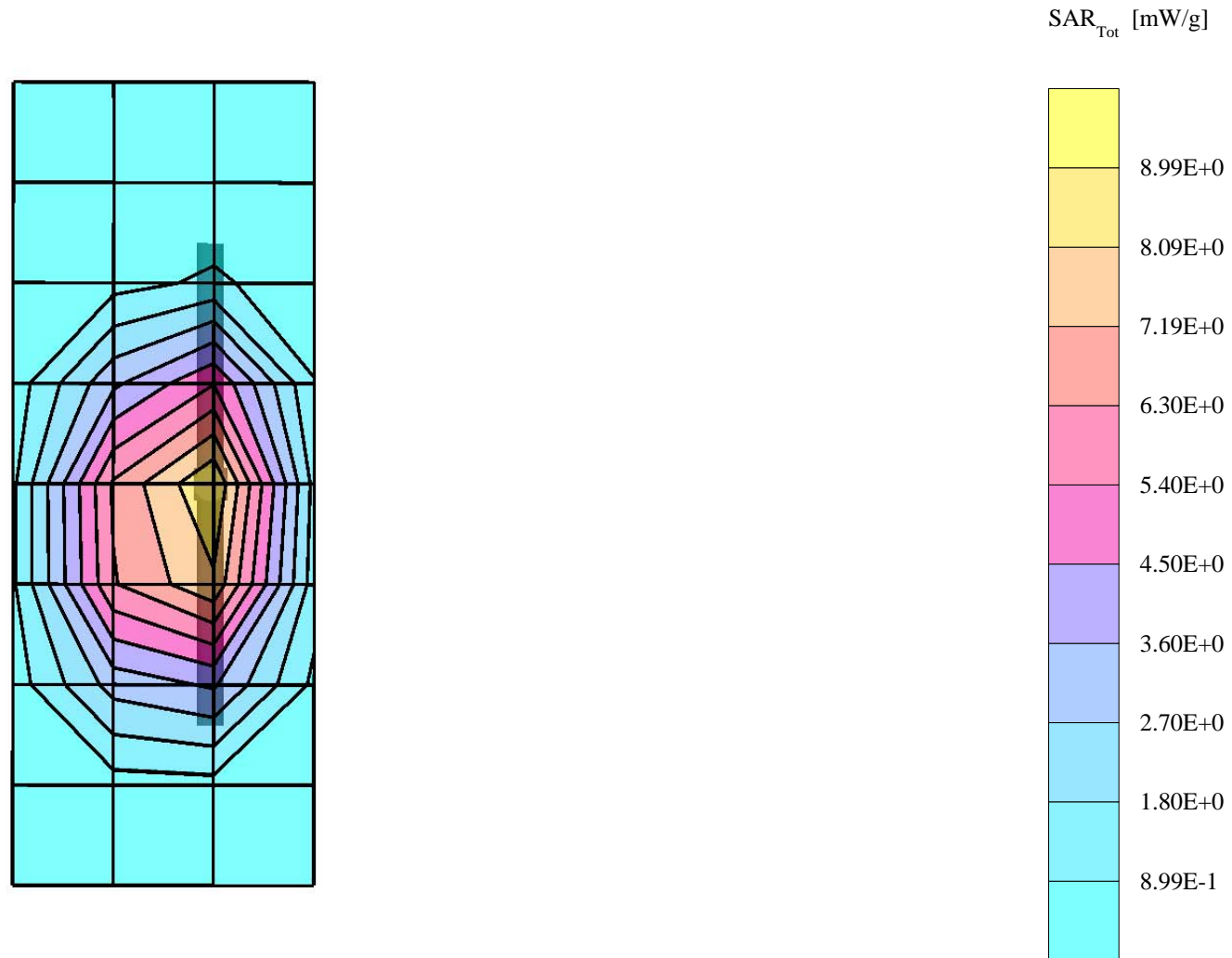

Dipole 1800 MHz

1800 MHz System Performance Check / Dipole Sn# 281tr

Forward Power = 252mW Reflected Power = -30.2dB

Room Temp at time of measurement = 20 Simulant Temp at time of measurement = 18.3

R3 Amy Twin Phantom Rev.4 (22Aug02) Phantom; Section; Position: ; Frequency: 1800 MHz

Probe: ET3DV6 - SN1520 - Validation.2; ConvF(5.10,5.10,5.10); Crest factor: 1.0; 1800 MHz VALIDATION: $\sigma = 1.37$ mho/m $\epsilon_r = 39.3$ $\rho = 1.00$ g/cm³

: , 0

Z-Axis: Dx = 0.0, Dy = 0.0, Dz = 5.0

Penetration depth: 8.4 (8.0, 9.2) [mm]

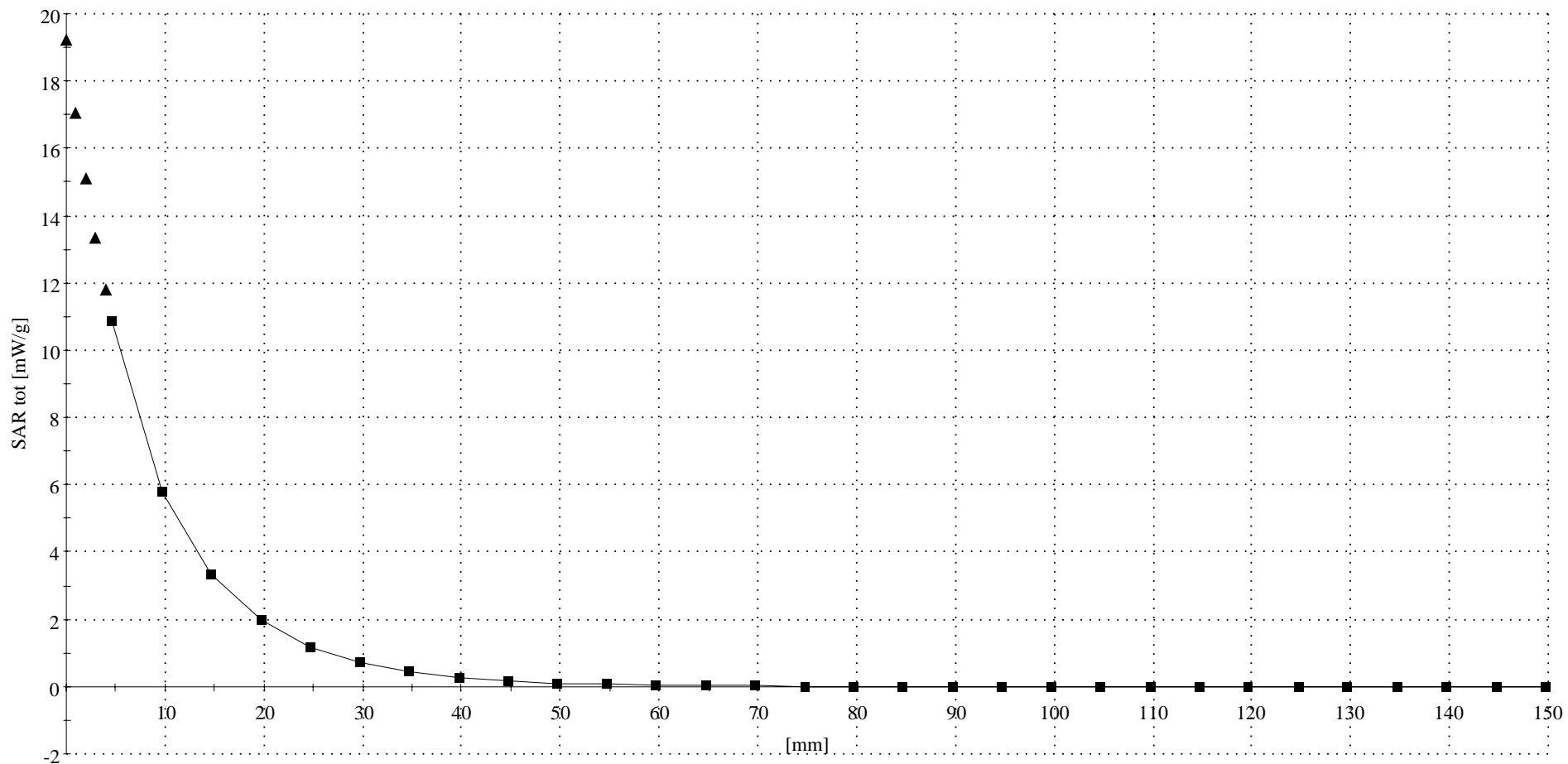

Appendix 2

SAR distribution plots for Body Worn Configuration

s/n: LV60D20022

Ch# 251 / Pwr Step: 5(OTA)

Type of Modulation: GSM850 (Bluetooth)

Accessory Model # = MTO4366 POUCH

R4 - Amy Twin Phantom Rev.4 (22Aug02) Phantom; section 1 Section; Position: (0°,0°); Frequency: 849 MHz

Probe: ET3DV6 - SN1514 - FCC Body.2; ConvF(6.10,6.10,6.10); Crest factor: 8.0; 835 MHz Head & Body: $\sigma = 0.99$ mho/m $\epsilon_r = 54.4$ $\rho = 1.00$ g/cm³

Cube 7x7x7: SAR (1g): 0.873 mW/g, SAR (10g): 0.595 mW/g, (Worst-case extrapolation)

Coarse: Dx = 15.0, Dy = 15.0, Dz = 10.0

Penetration depth: 14.4 (13.4, 15.6) [mm]

Powerdrift: -0.06 dB

Antenna Position: Fixed

Battery Model #: SNN5683A

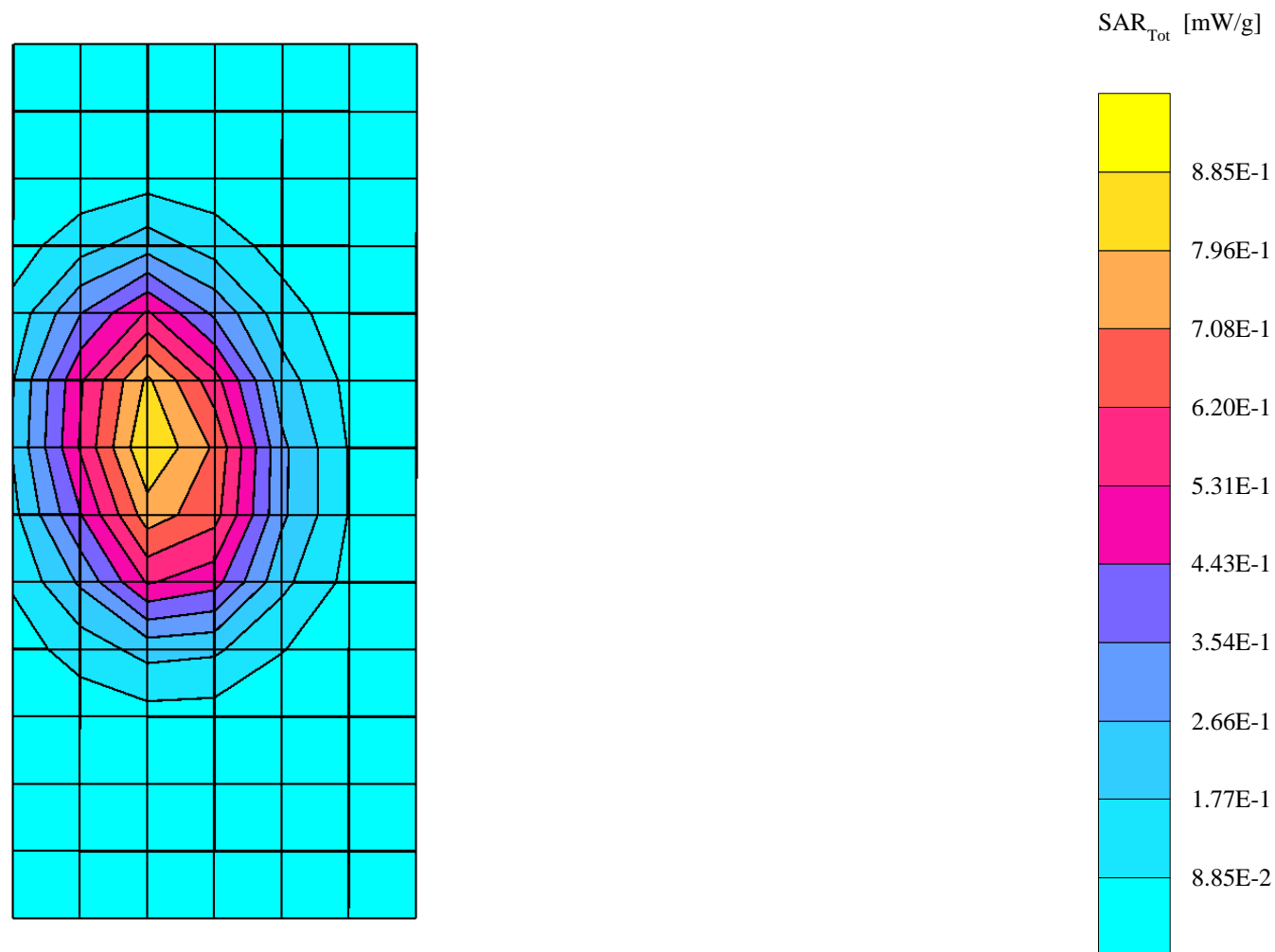

s/n: LV60D20022

Ch# 512 / Pwr Step: 0 OTA

Antenna Position: FIXED

Type of Modulation: 1900 GSM (BLUETOOTH) Battery Model #: SNN5683A

Accessory Model #: MTO4366 POUCH

R3 Amy Twin Phantom Rev.4 (22Aug02) Phantom; section 1 Section; Position: (0°,0°); Frequency: 1850 MHz

Probe: ET3DV6 - SN1520 - FCC Body; ConvF(4.80,4.80,4.80); Crest factor: 8.0; 1880 MHz Head & Body: $\sigma = 1.58$ mho/m $\epsilon_r = 51.6$ $\rho = 1.00$ g/cm³

Cube 7x7x7: SAR (1g): 0.887 mW/g, SAR (10g): 0.486 mW/g, (Worst-case extrapolation)

Coarse: Dx = 15.0, Dy = 15.0, Dz = 10.0

Penetration depth: 9.2 (8.6, 10.2) [mm]

Powerdrift: -0.01 dB

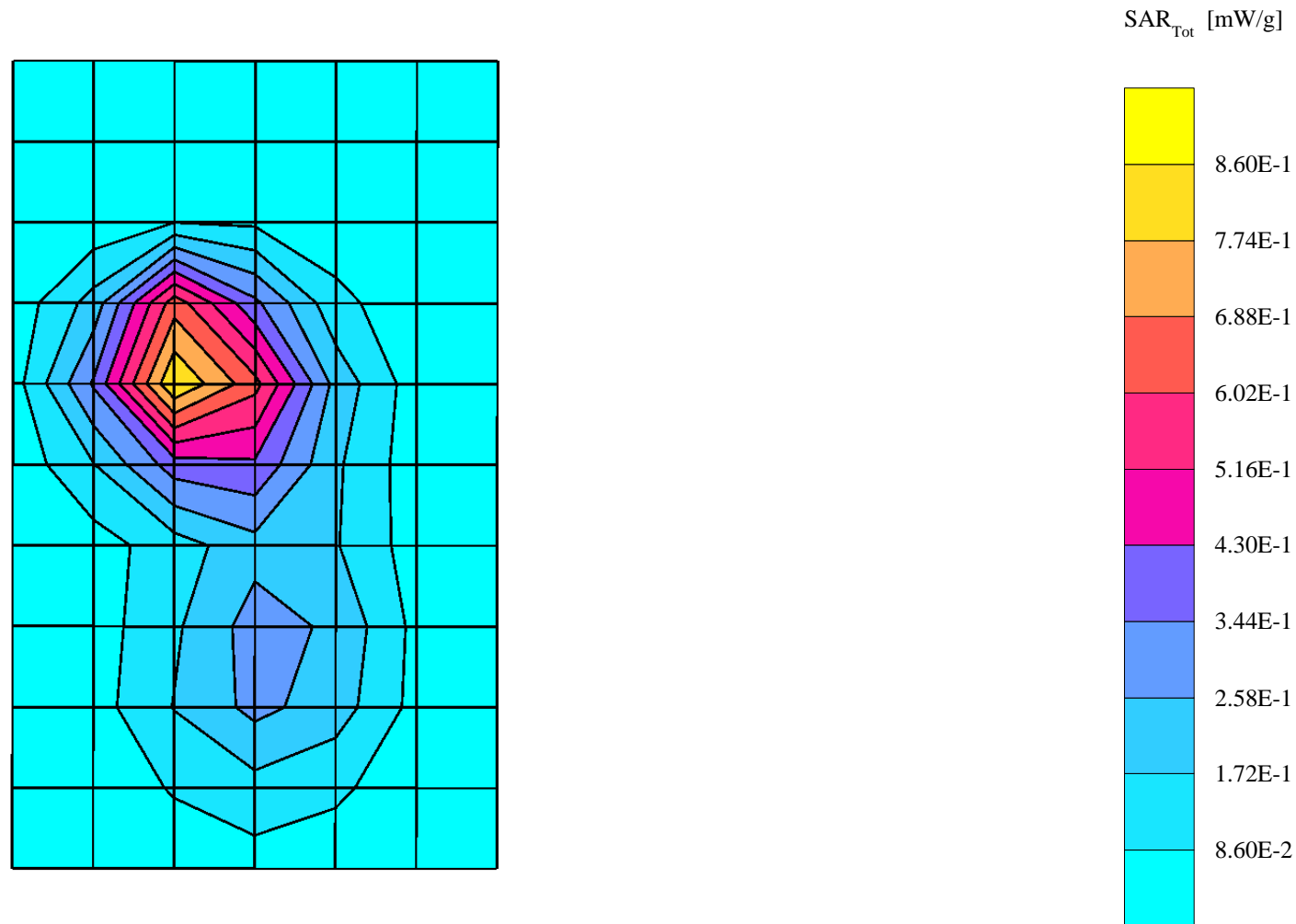

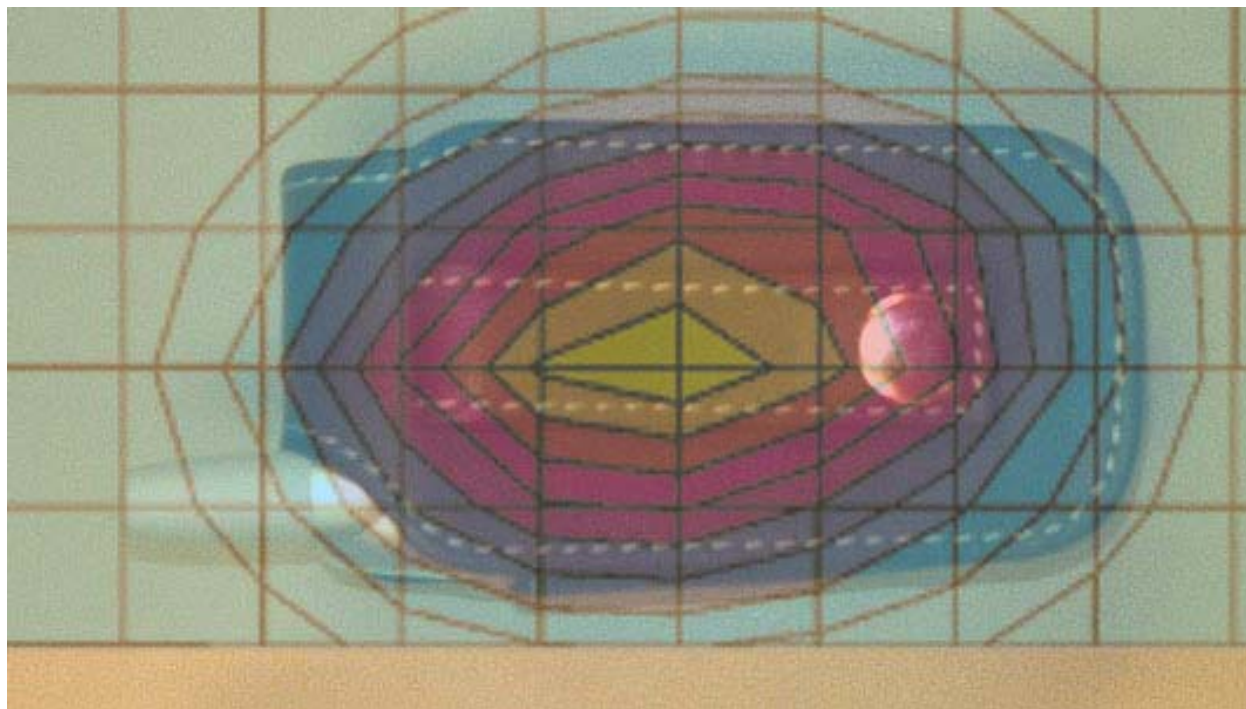

Figure 1. Typical 800 MHz Body-Worn Contour Overlaid on Phone

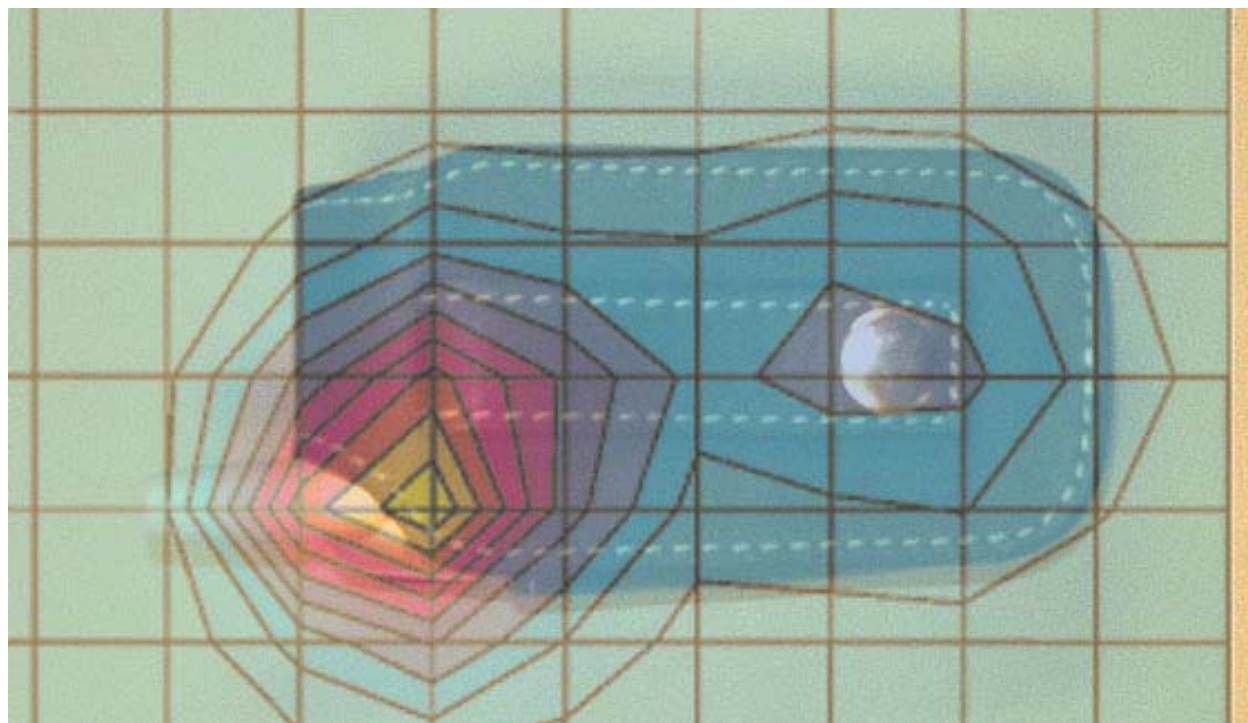

Figure 2. Typical 1900 MHz Body-Worn Contour Overlaid on Phone

Appendix 3
Probe Calibration Certificate

Client

Motorola MRO

CALIBRATION CERTIFICATE

Object(s)

ET3DV6 - SN 1514

Calibration procedure(s)

QA CAL-01 v2
 Calibration procedure for dosimetric E-field probes

Calibration date:

July 31, 2003

Condition of the calibrated item

In Tolerance (according to the specific calibration document)

This calibration statement documents traceability of M&TE used in the calibration procedures and conformity of the procedures with the ISO/IEC 17025 international standard.

All calibrations have been conducted in the closed laboratory facility: environment temperature 22 +/- 2 degrees Celsius and humidity < 75%.

Calibration Equipment used (M&TE critical for calibration)

Model Type	ID #	Cal Date (Calibrated by, Certificate No.)	Scheduled Calibration
RF generator HP 8684C	US3642U01700	4-Aug-99 (SPEAG, in house check Aug-02)	In house check: Aug-05
Power sensor E4412A	MY41495277	2-Apr-03 (METAS, No 252-0250)	Apr-04
Power sensor HP 8481A	MY41092180	18-Sep-02 (Agilent, No. 20020918)	Sep-03
Power meter EPM E4419B	GB41293874	2-Apr-03 (METAS, No 252-0250)	Apr-04
Network Analyzer HP 8753E	US37390585	18-Oct-01 (Agilent, No. 24BR1033101)	In house check: Oct 03
Fluke Process Calibrator Type 702	SN: 6295803	3-Sep-01 (ELCAL, No.2360)	Sep-03

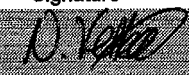
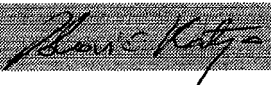
	Name	Function	Signature
Calibrated by:	Nico Vetterli	Technician	
Approved by:	Katja Pekoic	Laboratory Director	

Date issued: July 31, 2003

This calibration certificate is issued as an intermediate solution until the accreditation process (based on ISO/IEC 17025 International Standard) for Calibration Laboratory of Schmid & Partner Engineering AG is completed.

Probe ET3DV6

SN:1514

Manufactured:	November 24, 1999
Last calibration:	July 25, 2002
Recalibrated:	July 31, 2003

Calibrated for DASYS Systems

(Note: non-compatible with DASYS2 system!)

DASY - Parameters of Probe: ET3DV6 SN:1514

Sensitivity in Free Space

NormX	1.70 $\mu\text{V}/(\text{V}/\text{m})^2$
NormY	1.86 $\mu\text{V}/(\text{V}/\text{m})^2$
NormZ	1.79 $\mu\text{V}/(\text{V}/\text{m})^2$

Diode Compression

DCP X	93	mV
DCP Y	93	mV
DCP Z	93	mV

Sensitivity in Tissue Simulating Liquid

Head **900 MHz** $\epsilon_r = 41.5 \pm 5\%$ $\sigma = 0.97 \pm 5\%$ mho/m
Valid for f=800-1000 MHz with Head Tissue Simulating Liquid according to EN 50361, P1528-200X

ConvF X	6.3 $\pm 9.5\%$ (k=2)	Boundary effect:
ConvF Y	6.3 $\pm 9.5\%$ (k=2)	Alpha 0.58
ConvF Z	6.3 $\pm 9.5\%$ (k=2)	Depth 1.95

Head **1800 MHz** $\epsilon_r = 40.0 \pm 5\%$ $\sigma = 1.40 \pm 5\%$ mho/m
Valid for f=1710-1910 MHz with Head Tissue Simulating Liquid according to EN 50361, P1528-200X

ConvF X	5.1 $\pm 9.5\%$ (k=2)	Boundary effect:
ConvF Y	5.1 $\pm 9.5\%$ (k=2)	Alpha 0.55
ConvF Z	5.1 $\pm 9.5\%$ (k=2)	Depth 2.48

Boundary Effect

Head **900 MHz** **Typical SAR gradient: 5 % per mm**

Probe Tip to Boundary		1 mm	2 mm
SAR _{be} [%] Without Correction Algorithm		9.7	5.1
SAR _{be} [%] With Correction Algorithm		0.2	0.4

Head **1800 MHz** **Typical SAR gradient: 10 % per mm**

Probe Tip to Boundary		1 mm	2 mm
SAR _{be} [%] Without Correction Algorithm		13.9	9.0
SAR _{be} [%] With Correction Algorithm		0.1	0.0

Sensor Offset

Probe Tip to Sensor Center	2.7	mm
Optical Surface Detection	0.8 \pm 0.2	mm

Receiving Pattern (ϕ , $\theta = 0^\circ$)

f = 30 MHz, TEM cell ifi110

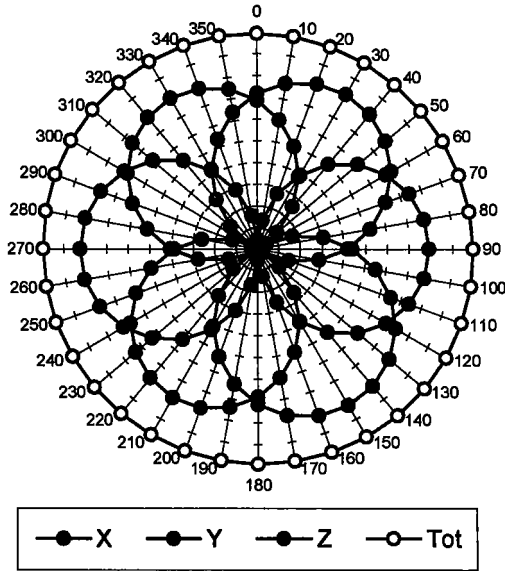

f = 100 MHz, TEM cell ifi110

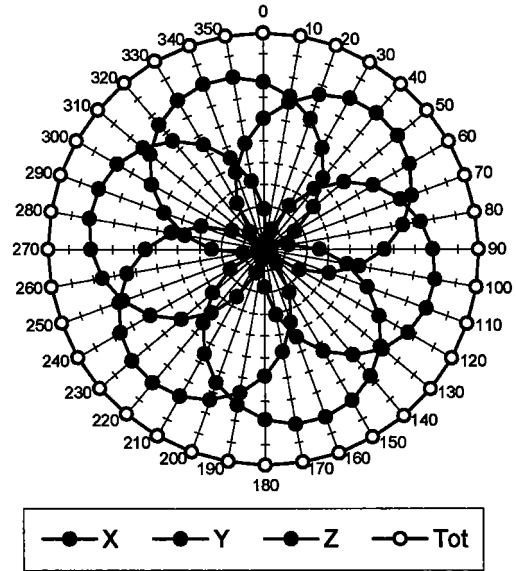

f = 300 MHz, TEM cell ifi110

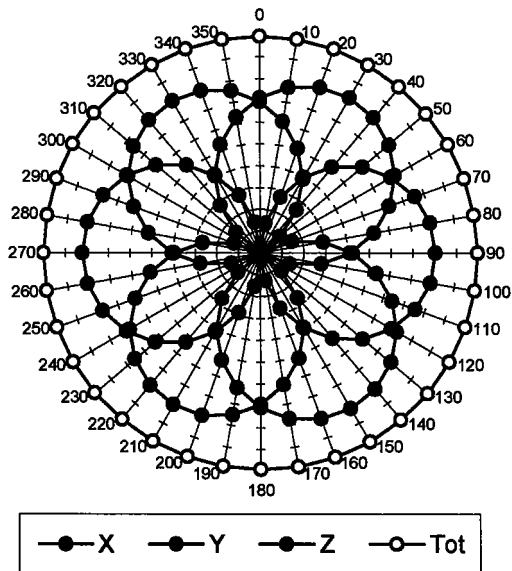

f = 900 MHz, TEM cell ifi110

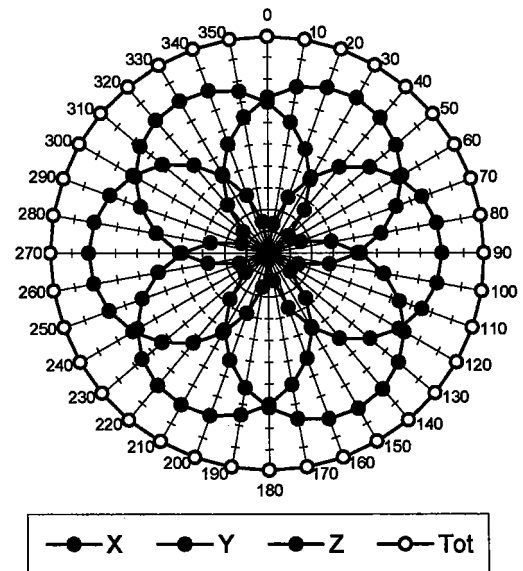

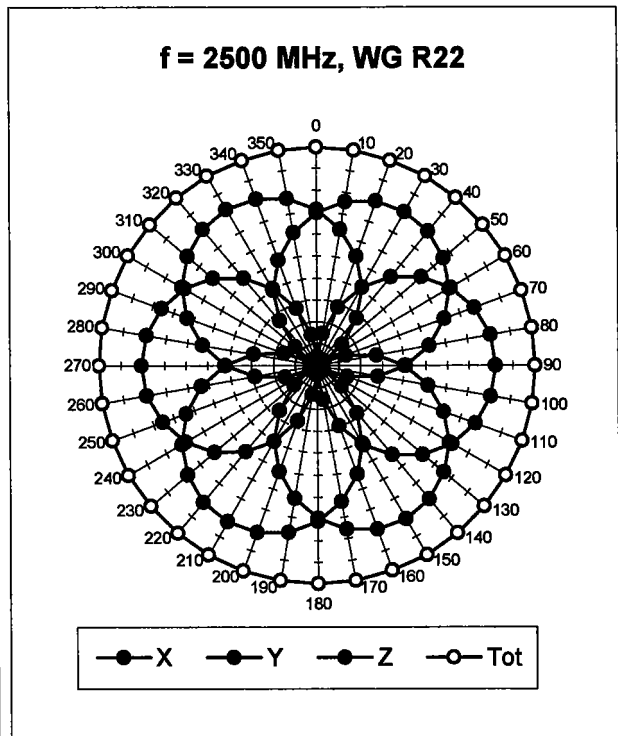
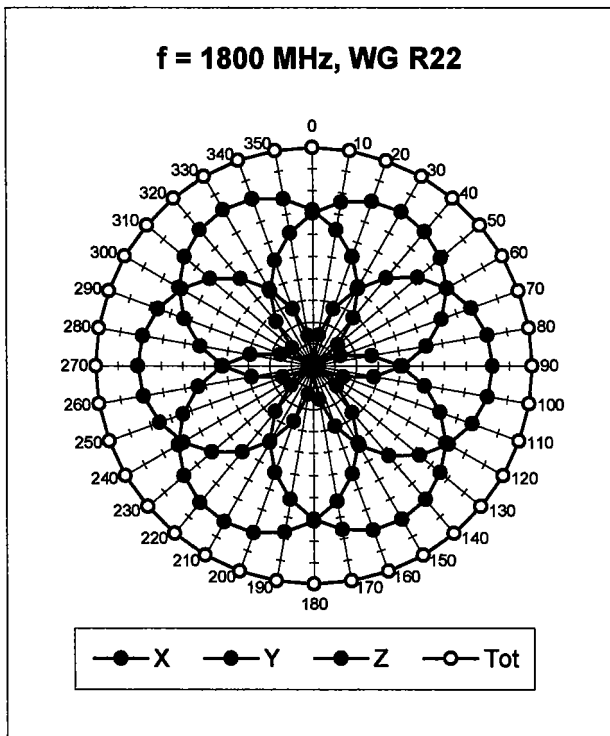

Isotropy Error (ϕ), $\theta = 0^\circ$

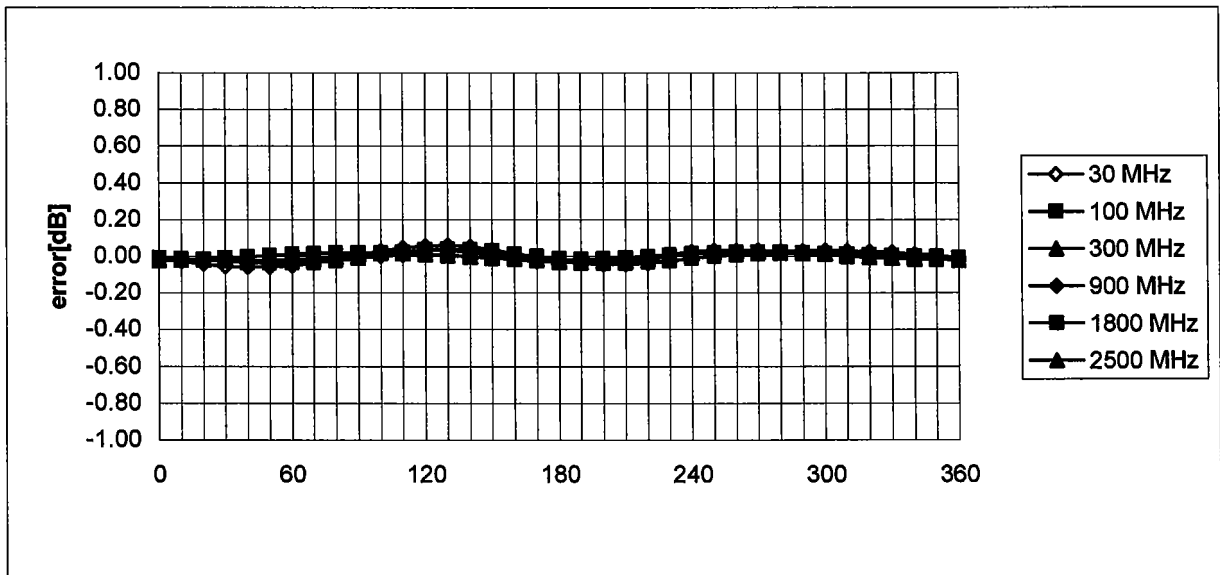

Frequency Response of E-Field

(TEM-Cell:ifi110, Waveguide R22)

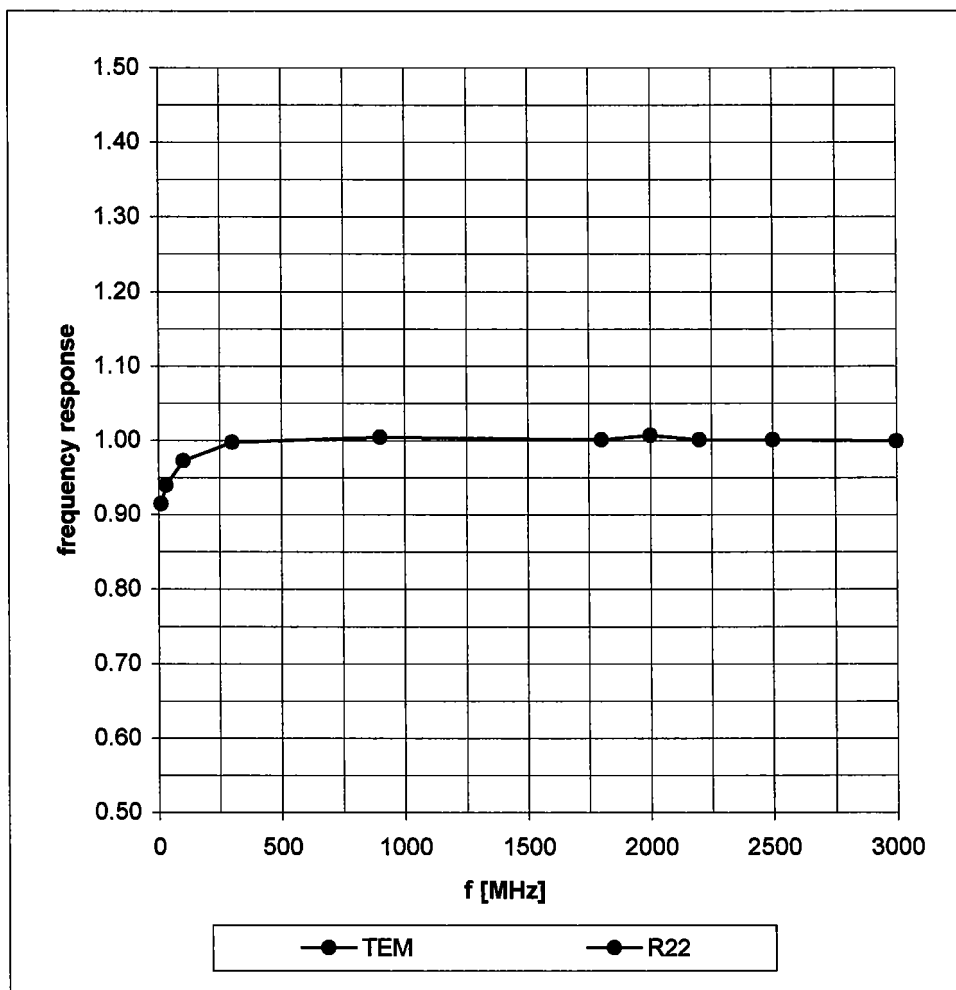

Dynamic Range f(SAR_{brain}) (Waveguide R22)

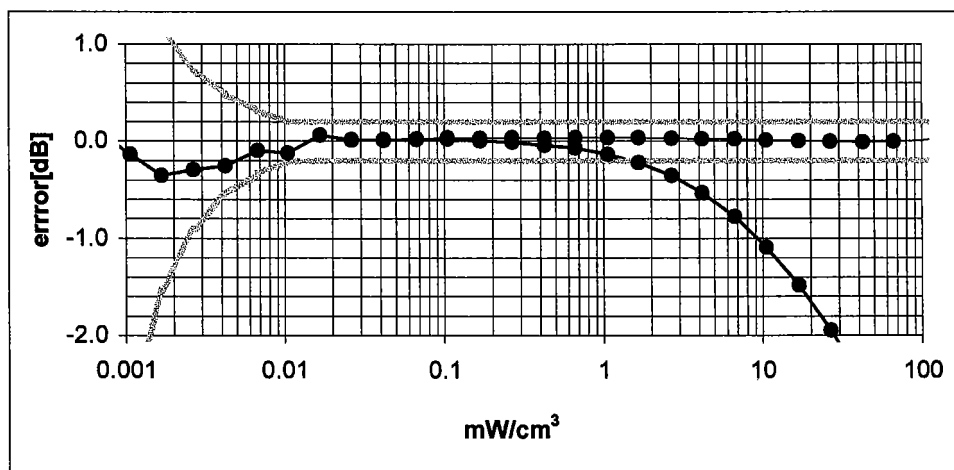
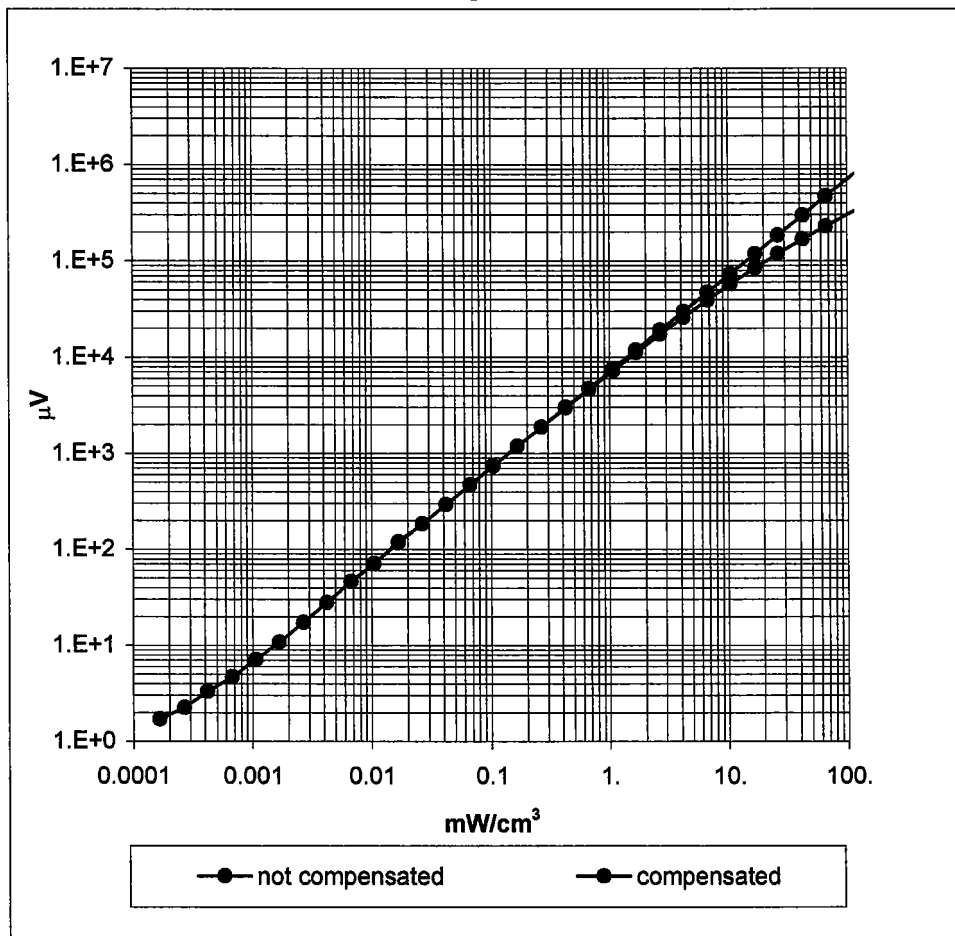

Conversion Factor Assessment

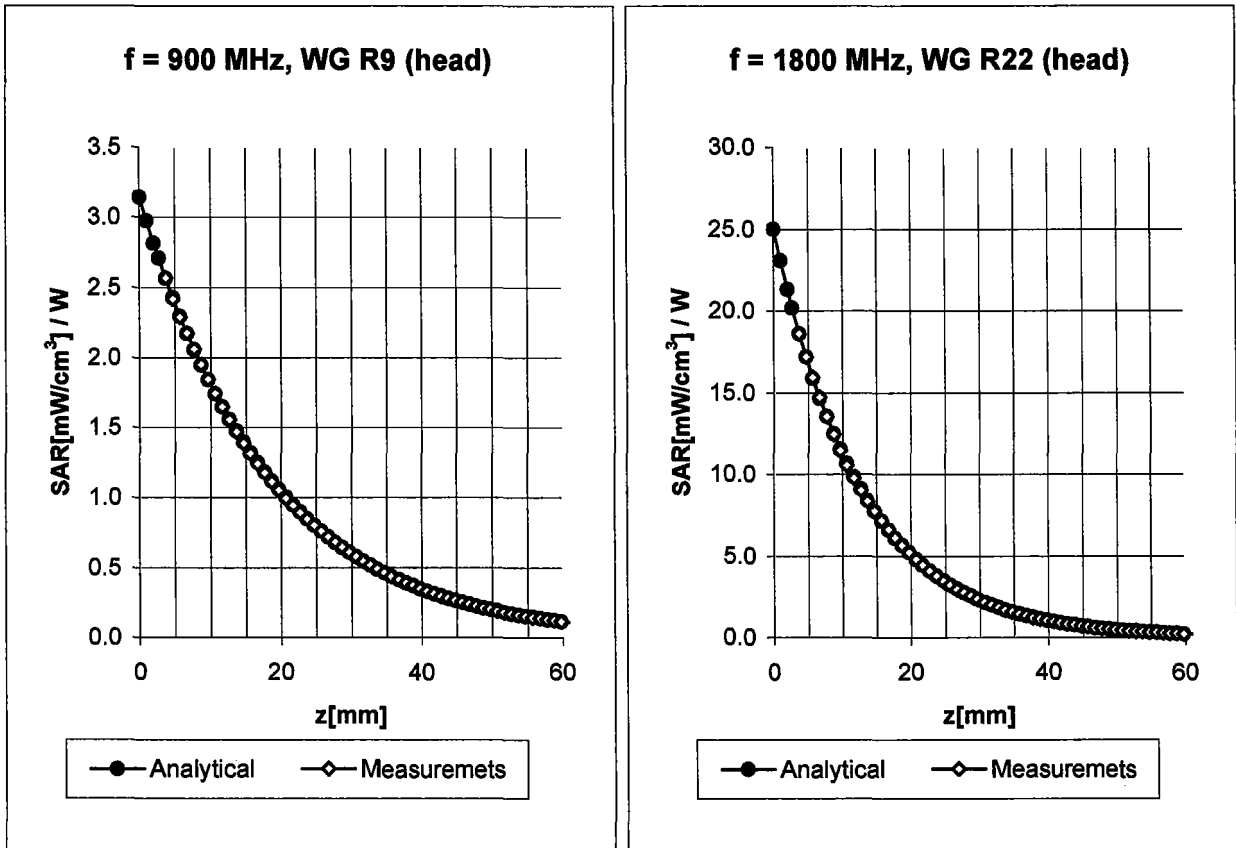

Head	900 MHz	$\epsilon_r = 41.5 \pm 5\%$	$\sigma = 0.97 \pm 5\% \text{ mho/m}$
Valid for f=800-1000 MHz with Head Tissue Simulating Liquid according to EN 50361, P1528-200X			
	ConvF X	6.3 $\pm 9.5\%$ (k=2)	Boundary effect:
	ConvF Y	6.3 $\pm 9.5\%$ (k=2)	Alpha 0.58
	ConvF Z	6.3 $\pm 9.5\%$ (k=2)	Depth 1.95

Head	1800 MHz	$\epsilon_r = 40.0 \pm 5\%$	$\sigma = 1.40 \pm 5\% \text{ mho/m}$
Valid for f=1710-1910 MHz with Head Tissue Simulating Liquid according to EN 50361, P1528-200X			
	ConvF X	5.1 $\pm 9.5\%$ (k=2)	Boundary effect:
	ConvF Y	5.1 $\pm 9.5\%$ (k=2)	Alpha 0.55
	ConvF Z	5.1 $\pm 9.5\%$ (k=2)	Depth 2.48

Conversion Factor Assessment

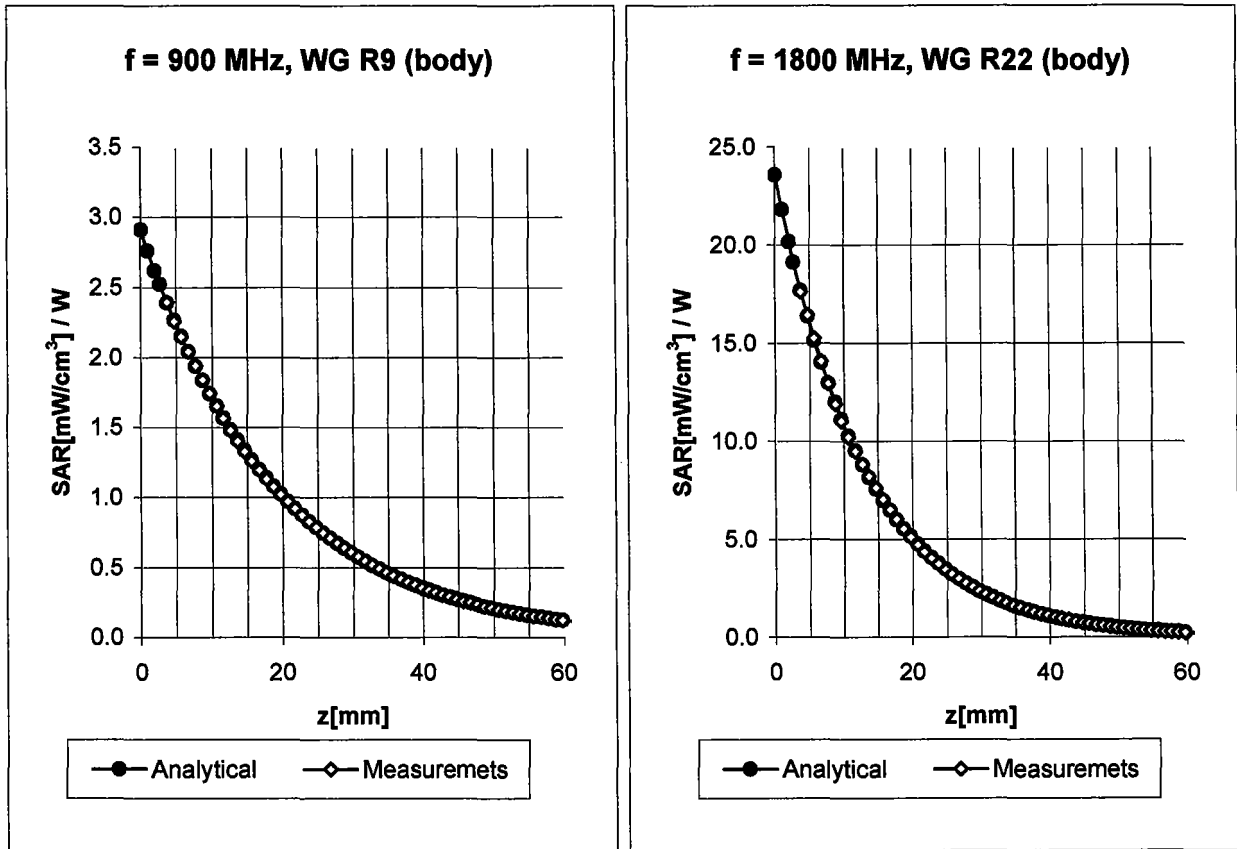

Body **900 MHz** $\epsilon_r = 55.0 \pm 5\%$ $\sigma = 1.05 \pm 5\% \text{ mho/m}$

Valid for f=800-1000 MHz with Head Tissue Simulating Liquid according to OET 65 Suppl. C

ConvF X	6.1 $\pm 9.5\%$ (k=2)	Boundary effect:
ConvF Y	6.1 $\pm 9.5\%$ (k=2)	Alpha 0.51
ConvF Z	6.1 $\pm 9.5\%$ (k=2)	Depth 2.18

Body **1800 MHz** $\epsilon_r = 53.3 \pm 5\%$ $\sigma = 1.52 \pm 5\% \text{ mho/m}$

Valid for f=1710-1910 MHz with Head Tissue Simulating Liquid according to OET 65 Suppl. C

ConvF X	4.7 $\pm 9.5\%$ (k=2)	Boundary effect:
ConvF Y	4.7 $\pm 9.5\%$ (k=2)	Alpha 0.57
ConvF Z	4.7 $\pm 9.5\%$ (k=2)	Depth 2.85

Conversion Factor Assessment

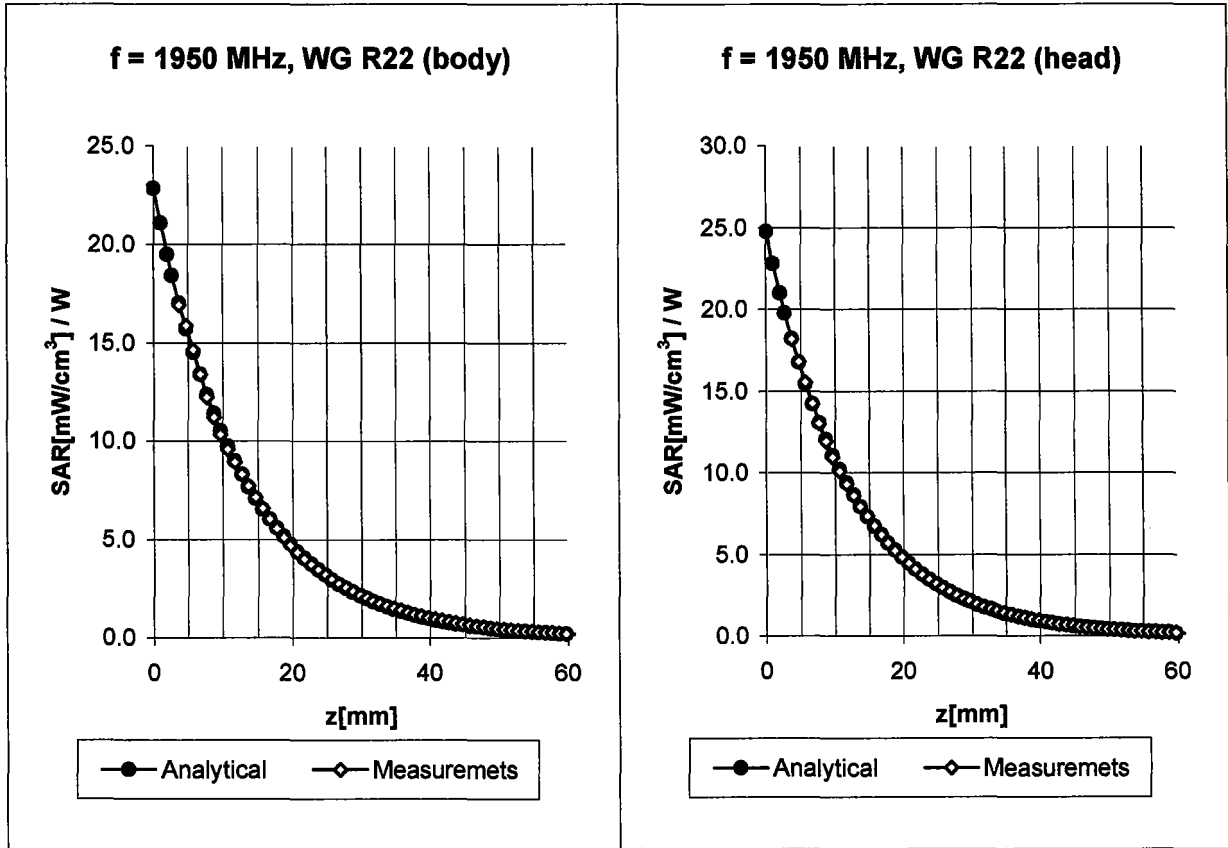

Body	1950 MHz	$\epsilon_r = 53.3 \pm 5\%$	$\sigma = 1.52 \pm 5\% \text{ mho/m}$
	ConvF X	4.5 $\pm 9.5\%$ (k=2)	Boundary effect:
	ConvF Y	4.5 $\pm 9.5\%$ (k=2)	Alpha 0.80
	ConvF Z	4.5 $\pm 9.5\%$ (k=2)	Depth 2.23

Head	1950 MHz	$\epsilon_r = 40.0 \pm 5\%$	$\sigma = 1.40 \pm 5\% \text{ mho/m}$
	ConvF X	5.0 $\pm 8.9\%$ (k=2)	Boundary effect:
	ConvF Y	5.0 $\pm 8.9\%$ (k=2)	Alpha 0.60
	ConvF Z	5.0 $\pm 8.9\%$ (k=2)	Depth 2.44

Conversion Factor Assessment

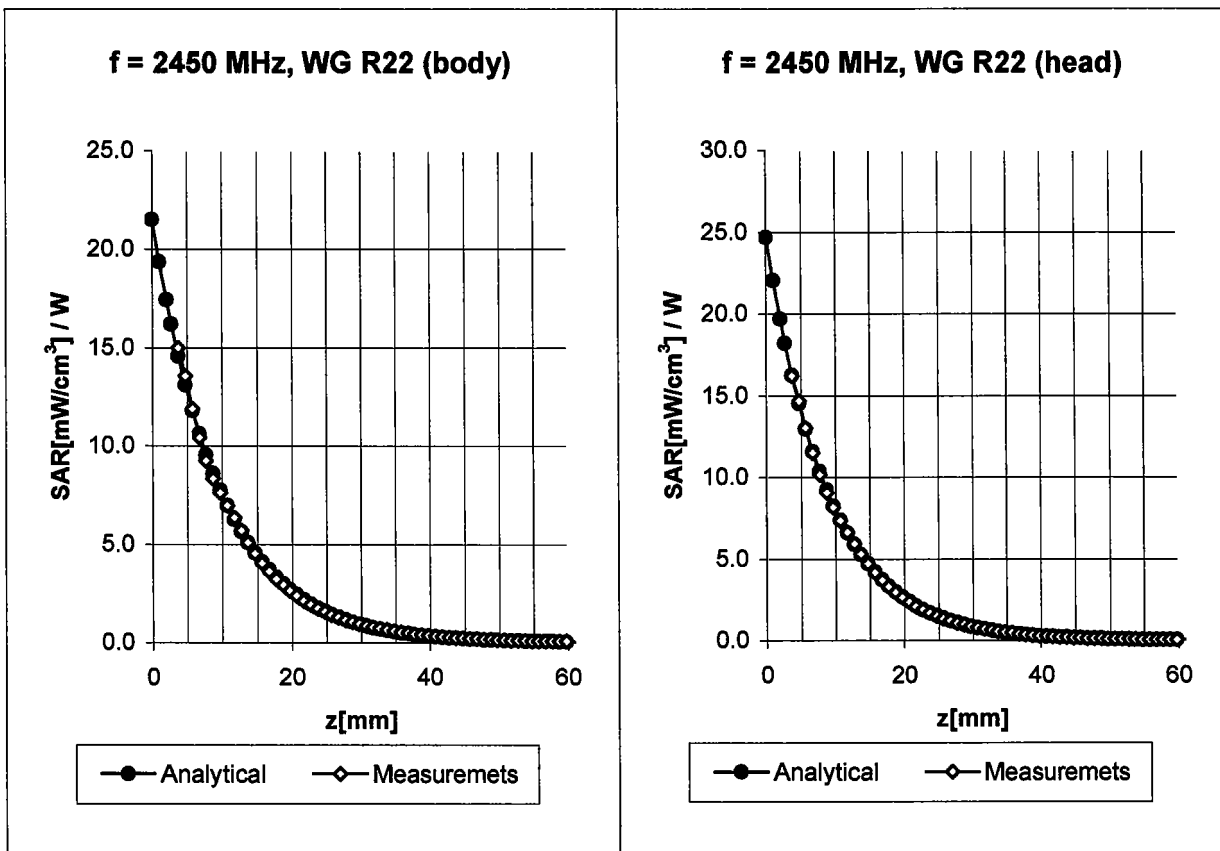

Body 2450 MHz $\epsilon_r = 52.7 \pm 5\%$ $\sigma = 1.95 \pm 5\%$ mho/m

Valid for f=2400-2500 MHz with Body Tissue Simulating Liquid according to OET 65 Suppl. C

ConvF X	4.4 \pm 8.9% (k=2)	Boundary effect:
ConvF Y	4.4 \pm 8.9% (k=2)	Alpha 1.55
ConvF Z	4.4 \pm 8.9% (k=2)	Depth 1.45

Head 2450 MHz $\epsilon_r = 39.2 \pm 5\%$ $\sigma = 1.80 \pm 5\%$ mho/m

Valid for f=2400-2500 MHz with Head Tissue Simulating Liquid according to EN 50361, P1528-200X

ConvF X	4.7 \pm 8.9% (k=2)	Boundary effect:
ConvF Y	4.7 \pm 8.9% (k=2)	Alpha 1.24
ConvF Z	4.7 \pm 8.9% (k=2)	Depth 1.67

Deviation from Isotropy in HSL

Error ($\theta\phi$), $f = 900$ MHz

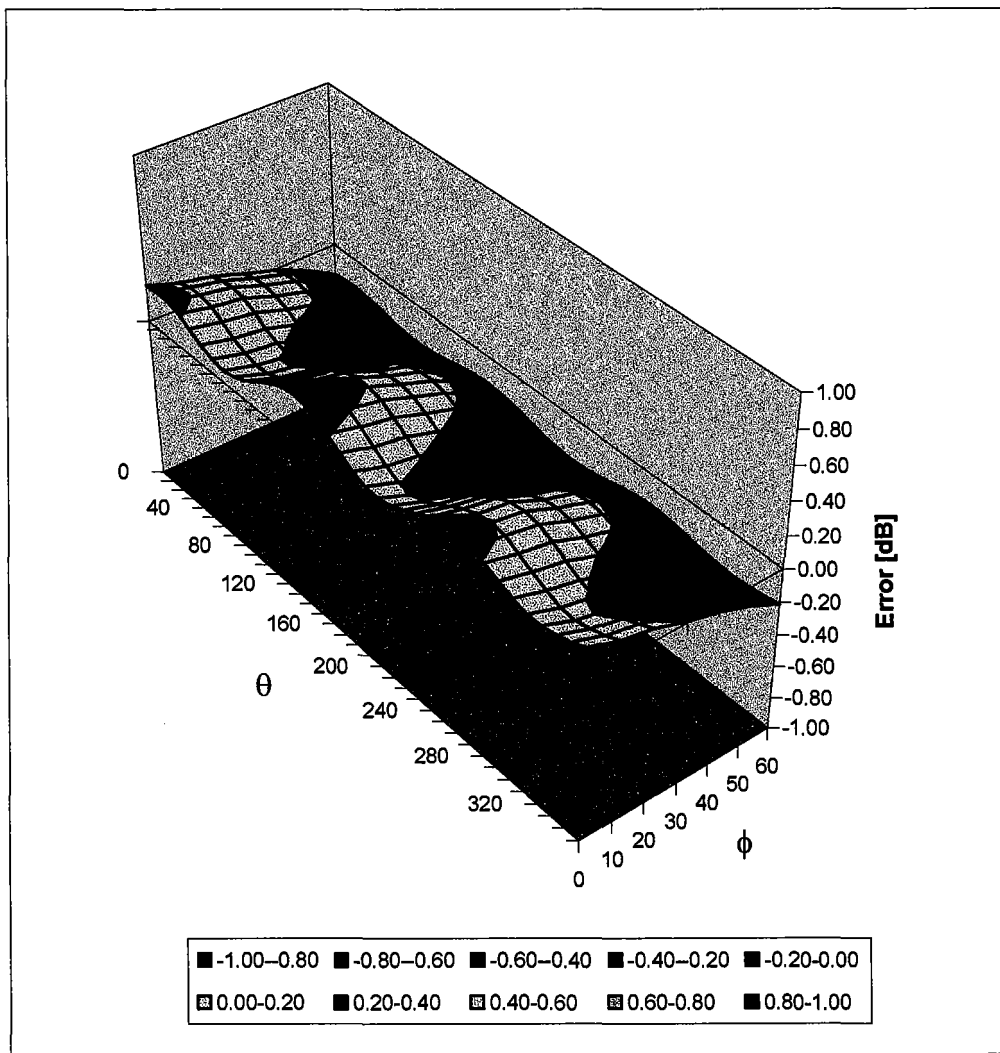

Client **Motorola Korea (MRO)**

CALIBRATION CERTIFICATE

Object(s) **ET3DV6 - SN 1520**

Calibration procedure(s) **QA CAL-01 v2
 Calibration procedure for dosimetric E-field probes**

Calibration date: **June 9, 2003**



Condition of the calibrated item **In Tolerance (according to the specific calibration document)**

This calibration statement documents traceability of M&TE used in the calibration procedures and conformity of the procedures with the ISO/IEC 17025 international standard.

All calibrations have been conducted in the closed laboratory facility: environment temperature 22 +/- 2 degrees Celsius and humidity < 75%.

Calibration Equipment used (M&TE critical for calibration)

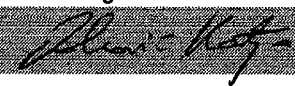
Model Type	ID #	Cal Date (Calibrated by, Certificate No.)	Scheduled Calibration
RF generator HP 8684C	US3642U01700	4-Aug-99 (SPEAG, in house check Aug-02)	In house check: Aug-05
Power sensor E4412A	MY41495277	2-Apr-03 (METAS, No 252-0250)	Apr-04
Power sensor HP 8481A	MY41092180	18-Sep-02 (Agilent, No. 20020918)	Sep-03
Power meter EPM E4419B	GB41293874	2-Apr-03 (METAS, No 252-0250)	Apr-04
Network Analyzer HP 8753E	US37390585	18-Oct-01 (Agilent, No. 24BR1033101)	In house check: Oct 03
Fluke Process Calibrator Type 702	SN: 6295803	3-Sep-01 (ELCAL, No.2360)	Sep-03

	Name	Function	Signature
Calibrated by:	Katja Pakevic	Laboratory Director	
Approved by:	Fin Bommert	R&D Director	

Date issued: June 9, 2003

This calibration certificate is issued as an intermediate solution until the accreditation process (based on ISO/IEC 17025 International Standard) for Calibration Laboratory of Schmid & Partner Engineering AG is completed.

Probe ET3DV6

SN:1520

Manufactured:	February 1, 2000
Last calibration:	May 8, 2002
Recalibrated:	June 9, 2003

Calibrated for DASY Systems

(Note: non-compatible with DASY2 system!)

DASY - Parameters of Probe: ET3DV6 SN:1520

Sensitivity in Free Space

NormX	1.87 $\mu\text{V}/(\text{V}/\text{m})^2$
NormY	1.67 $\mu\text{V}/(\text{V}/\text{m})^2$
NormZ	1.85 $\mu\text{V}/(\text{V}/\text{m})^2$

Diode Compression

DCP X	95	mV
DCP Y	95	mV
DCP Z	95	mV

Sensitivity in Tissue Simulating Liquid

Head 900 MHz $\epsilon_r = 41.5 \pm 5\%$ $\sigma = 0.97 \pm 5\%$ mho/m

Valid for f=800-1000 MHz with Head Tissue Simulating Liquid according to EN 50361, P1528-200X

ConvF X	6.5 $\pm 9.5\%$ (k=2)	Boundary effect:
ConvF Y	6.5 $\pm 9.5\%$ (k=2)	Alpha 0.42
ConvF Z	6.5 $\pm 9.5\%$ (k=2)	Depth 2.27

Head 1800 MHz $\epsilon_r = 40.0 \pm 5\%$ $\sigma = 1.40 \pm 5\%$ mho/m

Valid for f=1710-1910 MHz with Head Tissue Simulating Liquid according to EN 50361, P1528-200X

ConvF X	5.1 $\pm 9.5\%$ (k=2)	Boundary effect:
ConvF Y	5.1 $\pm 9.5\%$ (k=2)	Alpha 0.50
ConvF Z	5.1 $\pm 9.5\%$ (k=2)	Depth 2.63

Boundary Effect

Head 900 MHz Typical SAR gradient: 5 % per mm

Probe Tip to Boundary		1 mm	2 mm
SAR _{be} [%]	Without Correction Algorithm	9.3	5.2
SAR _{be} [%]	With Correction Algorithm	0.3	0.4

Head 1800 MHz Typical SAR gradient: 10 % per mm

Probe Tip to Boundary		1 mm	2 mm
SAR _{be} [%]	Without Correction Algorithm	13.6	9.3
SAR _{be} [%]	With Correction Algorithm	0.2	0.2

Sensor Offset

Probe Tip to Sensor Center	2.7	mm
Optical Surface Detection	1.7 \pm 0.2	mm

Receiving Pattern (ϕ), $\theta = 0^\circ$

f = 30 MHz, TEM cell ifi110

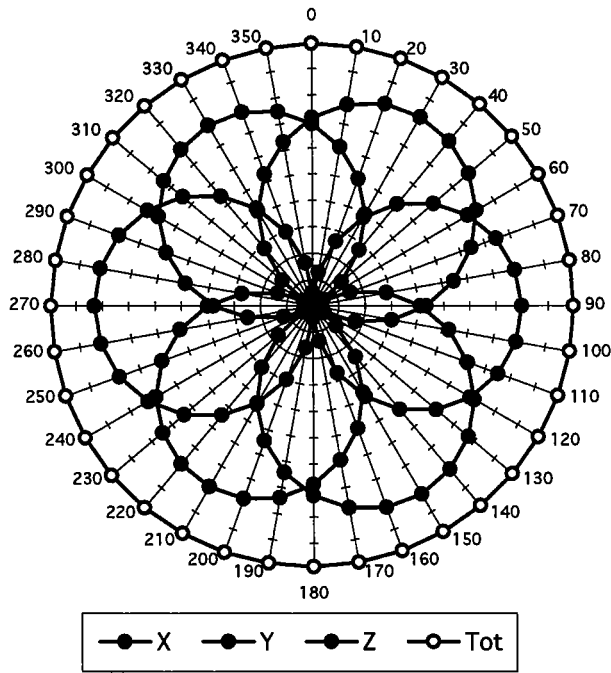

f = 100 MHz, TEM cell ifi110

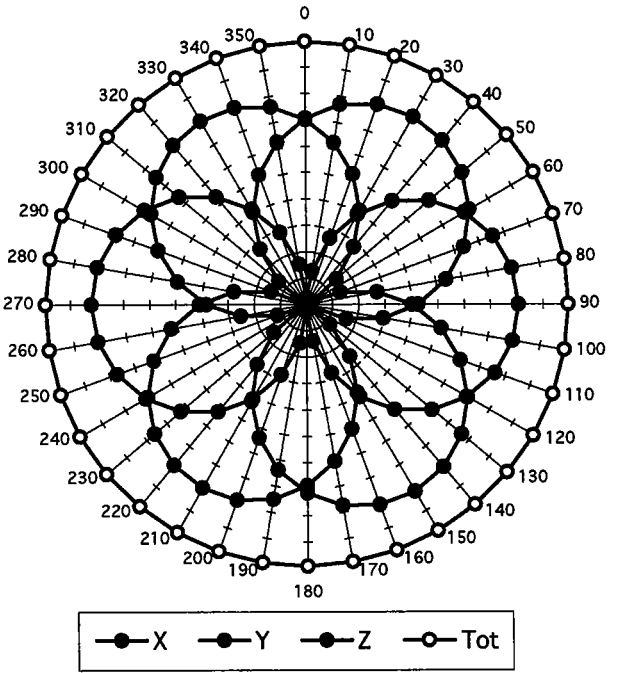

f = 300 MHz, TEM cell ifi110

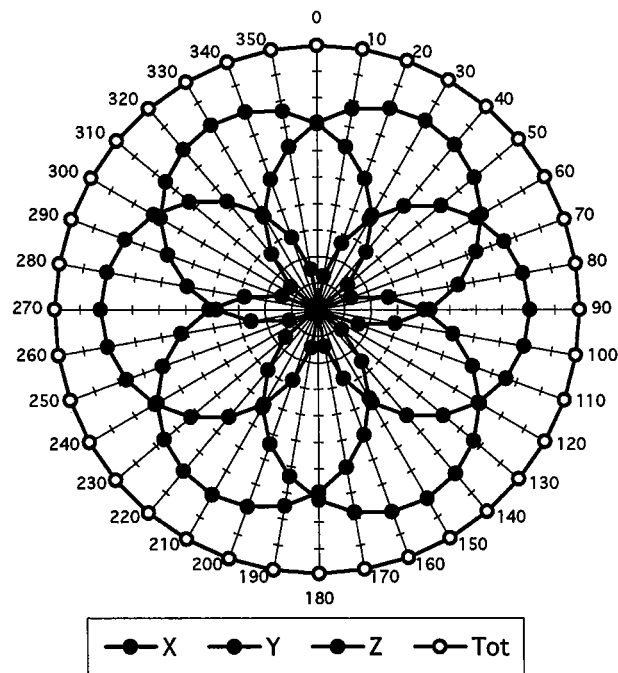

f = 900 MHz, TEM cell ifi110

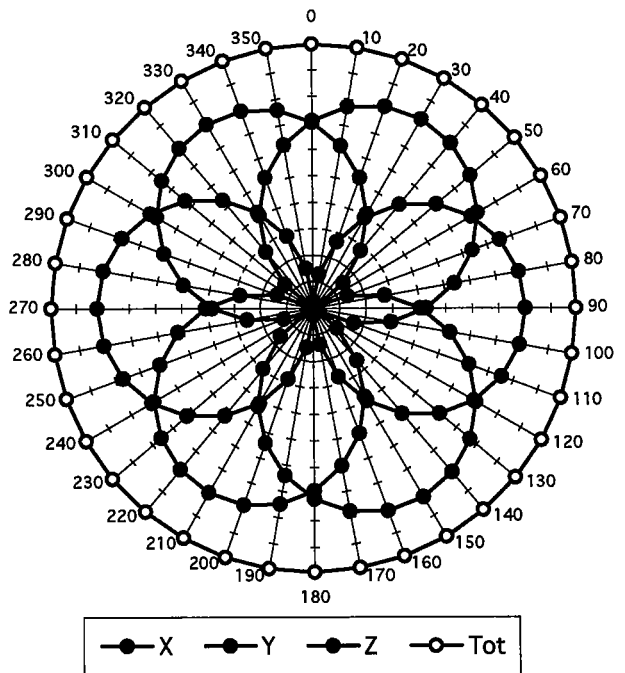

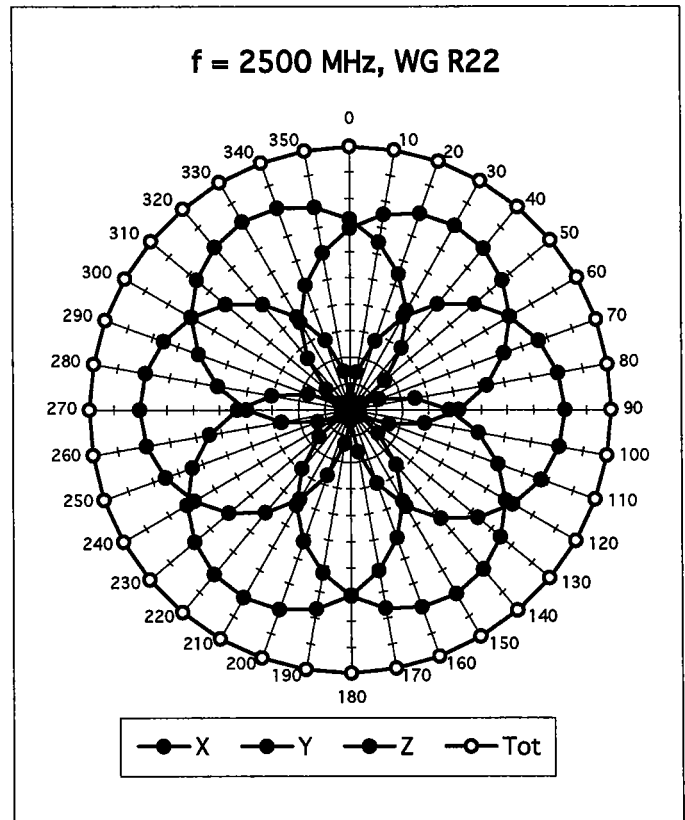
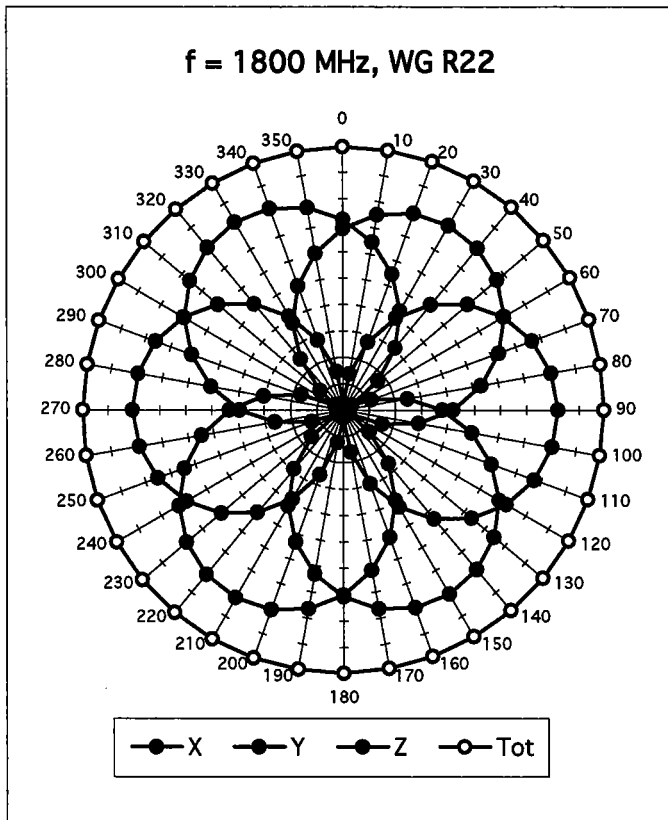

Isotropy Error (ϕ), $\theta = 0^\circ$

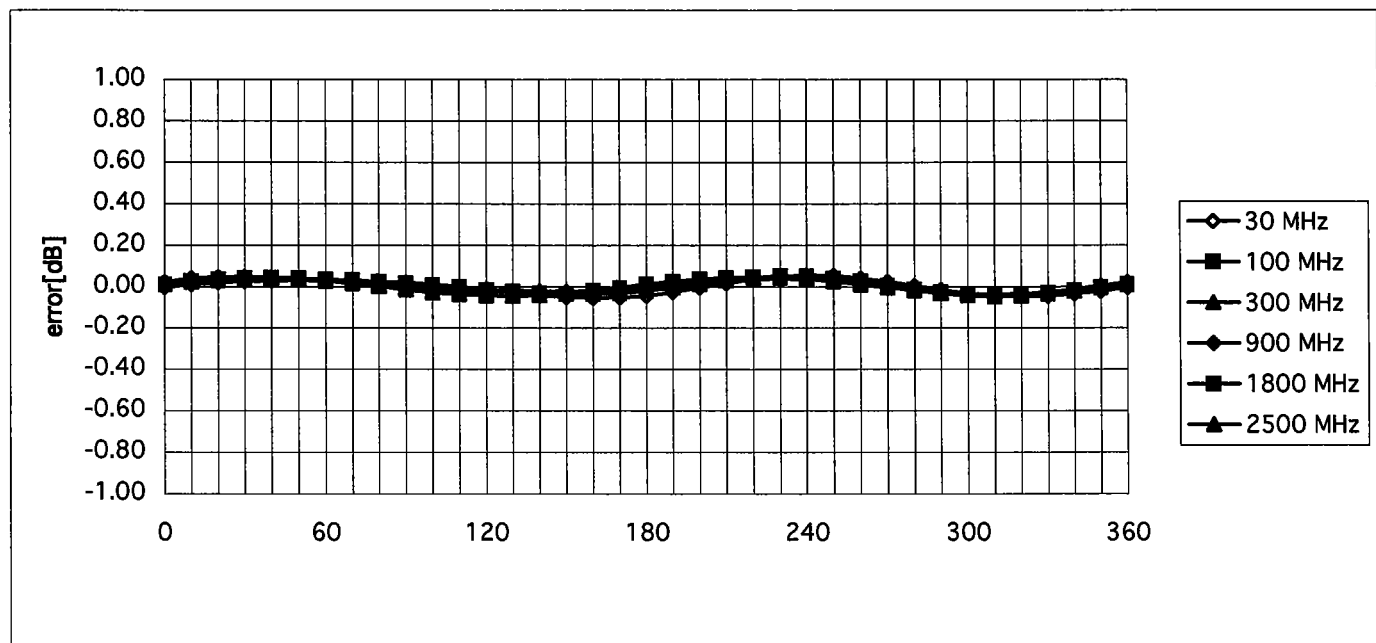

Frequency Response of E-Field

(TEM-Cell:if1110, Waveguide R22)

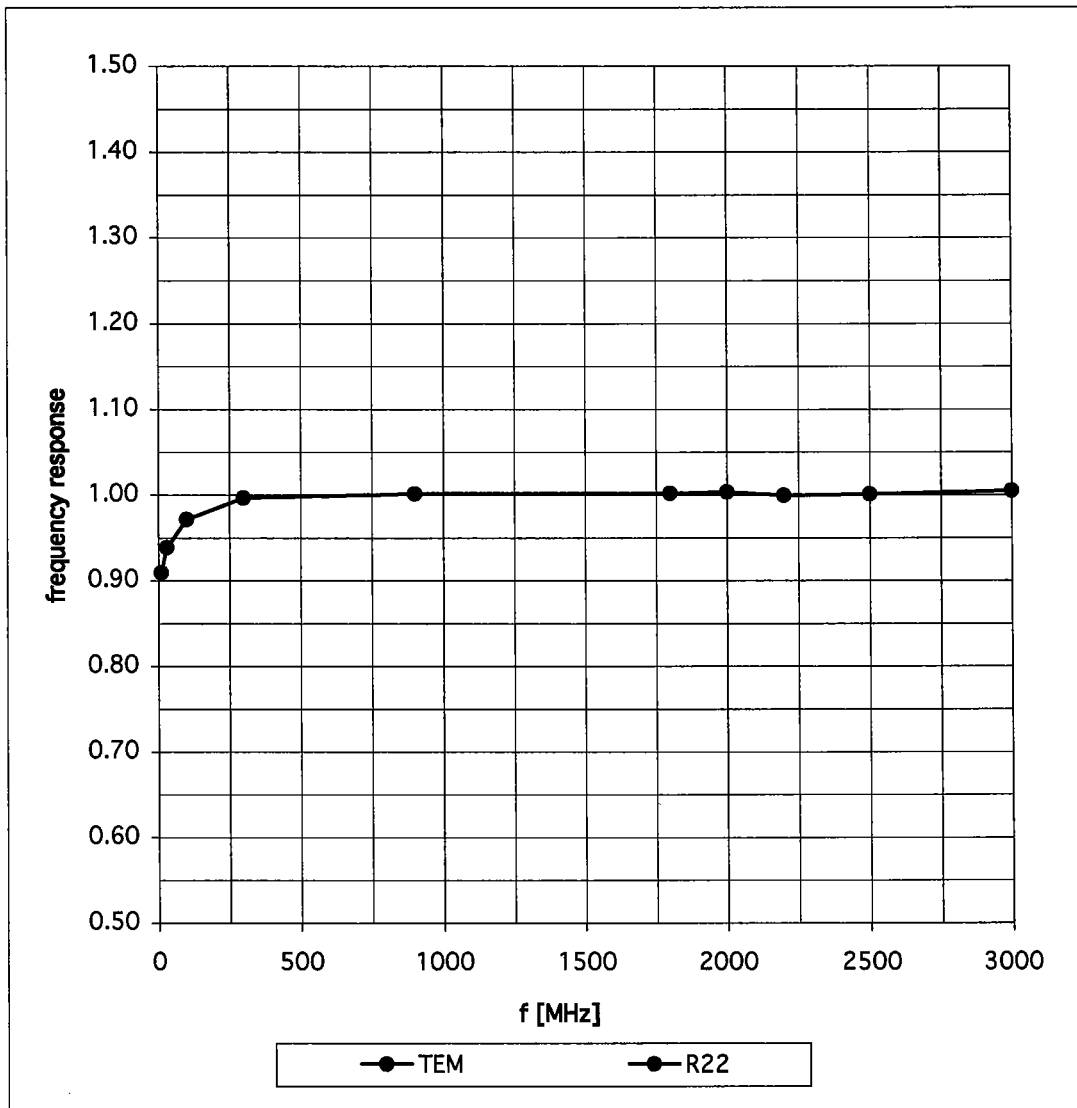

Dynamic Range f(SAR_{brain})

(Waveguide R22)

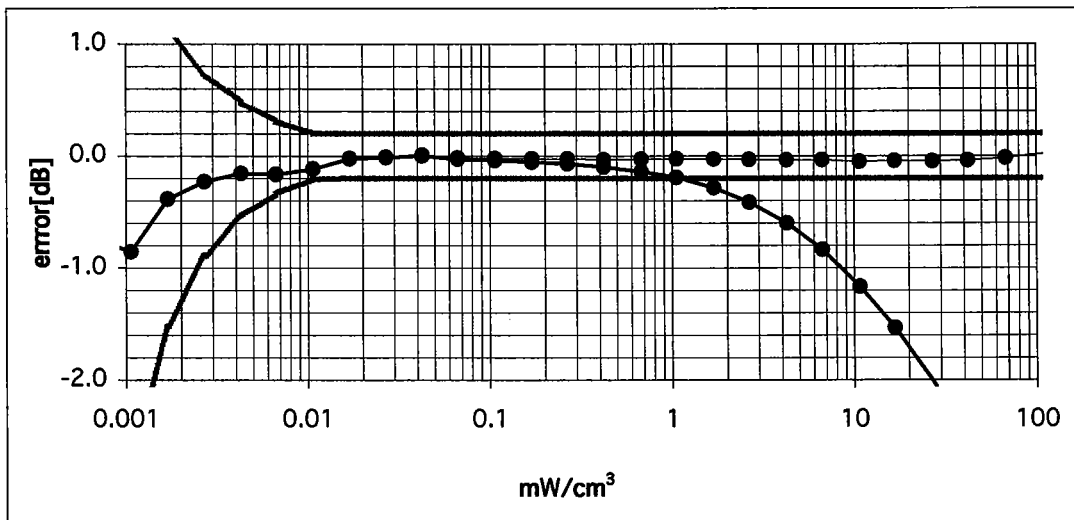
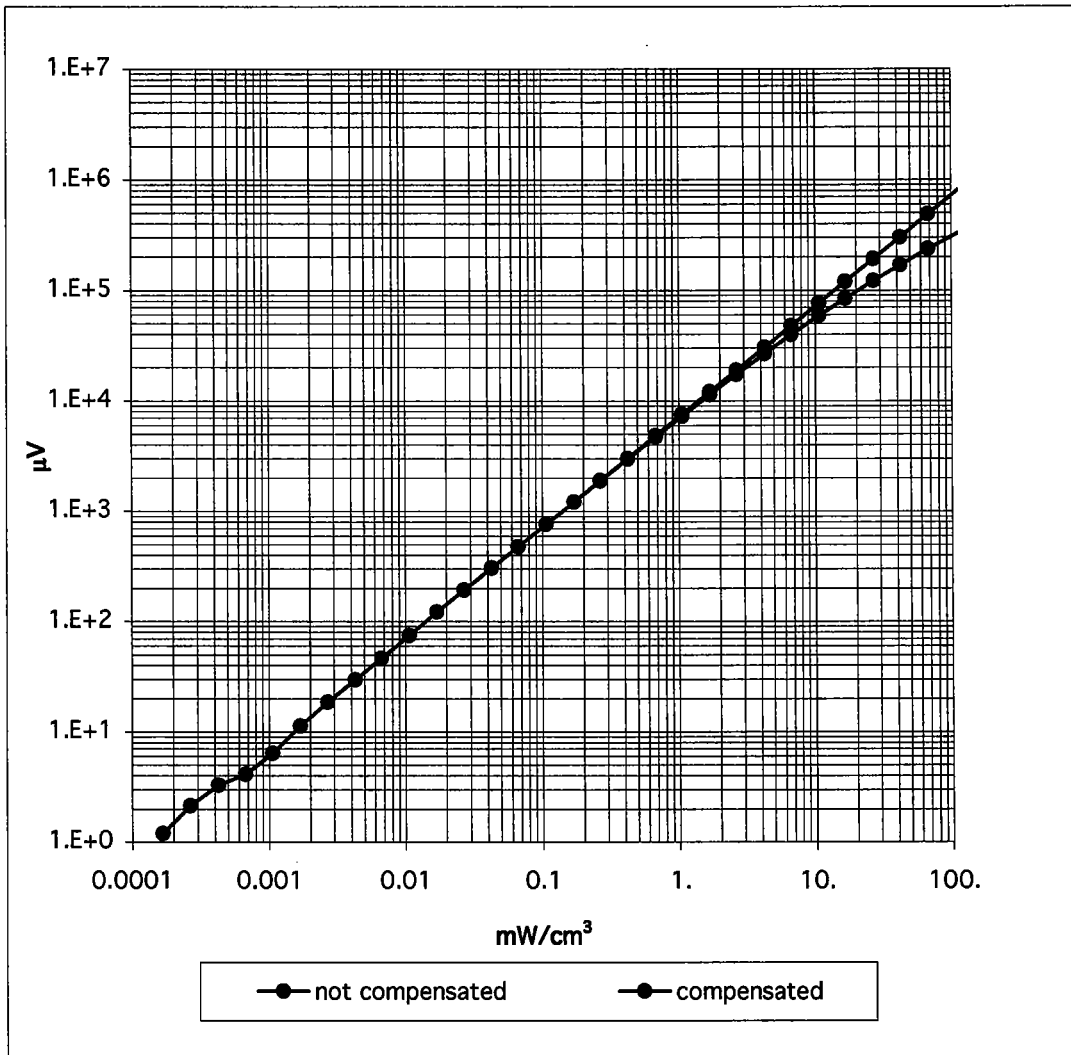

Conversion Factor Assessment

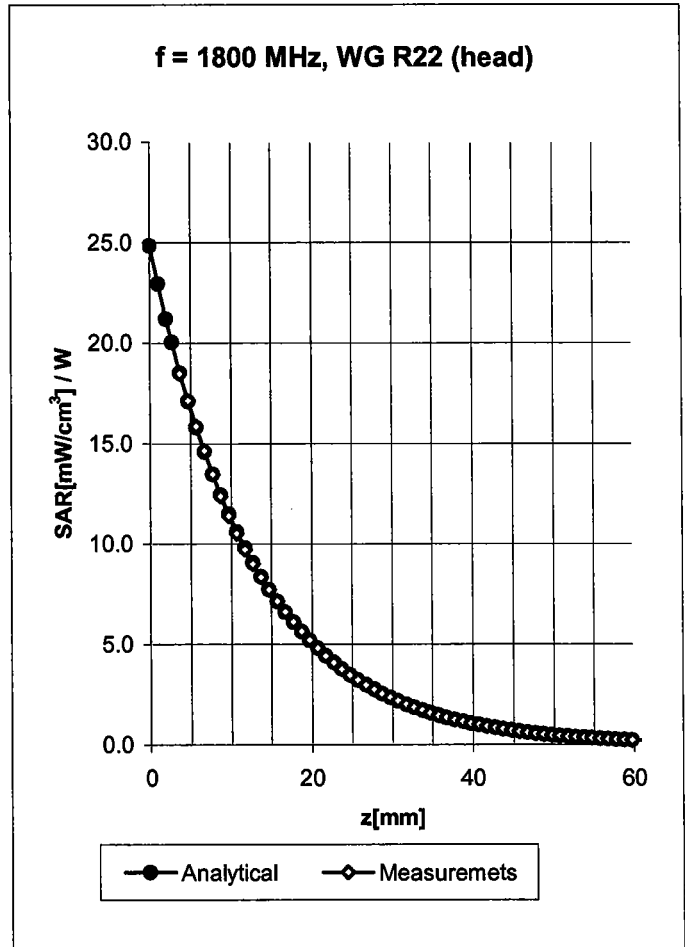
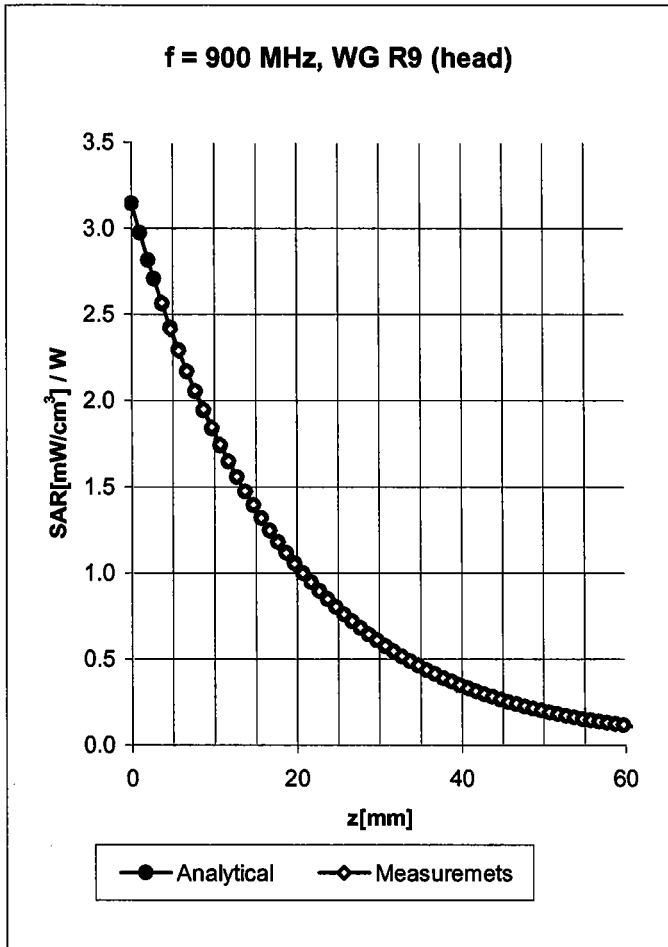

Head 900 MHz $\epsilon_r = 41.5 \pm 5\%$ $\sigma = 0.97 \pm 5\%$ mho/m

Valid for f=800-1000 MHz with Head Tissue Simulating Liquid according to EN 50361, P1528-200X

ConvF X	6.5 $\pm 9.5\%$ (k=2)	Boundary effect:	
ConvF Y	6.5 $\pm 9.5\%$ (k=2)	Alpha	0.42
ConvF Z	6.5 $\pm 9.5\%$ (k=2)	Depth	2.27

Head 1800 MHz $\epsilon_r = 40.0 \pm 5\%$ $\sigma = 1.40 \pm 5\%$ mho/m

Valid for f=1710-1910 MHz with Head Tissue Simulating Liquid according to EN 50361, P1528-200X

ConvF X	5.1 $\pm 9.5\%$ (k=2)	Boundary effect:	
ConvF Y	5.1 $\pm 9.5\%$ (k=2)	Alpha	0.50
ConvF Z	5.1 $\pm 9.5\%$ (k=2)	Depth	2.63

Conversion Factor Assessment

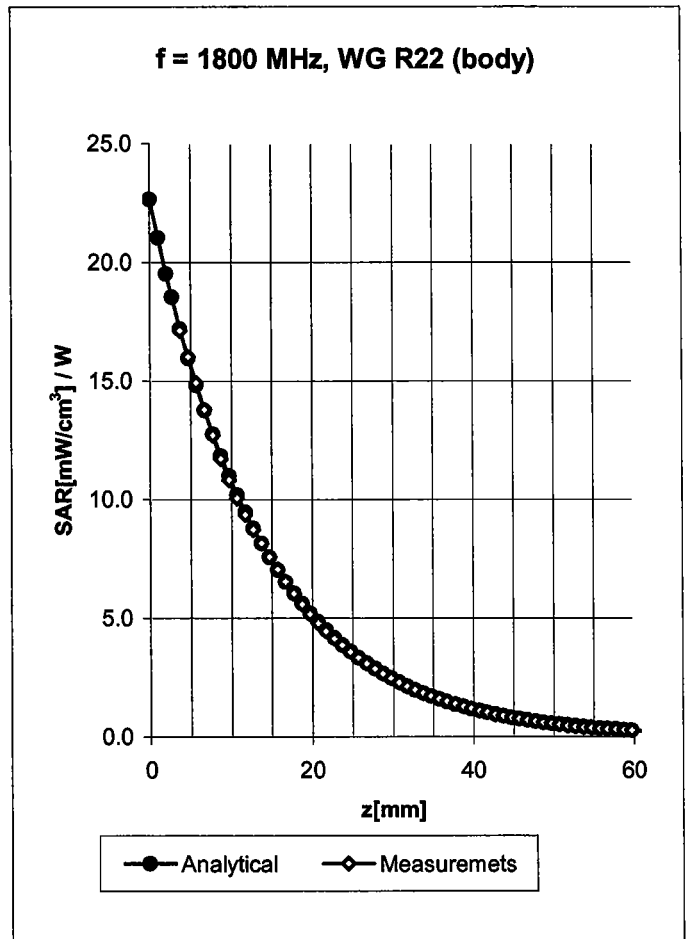
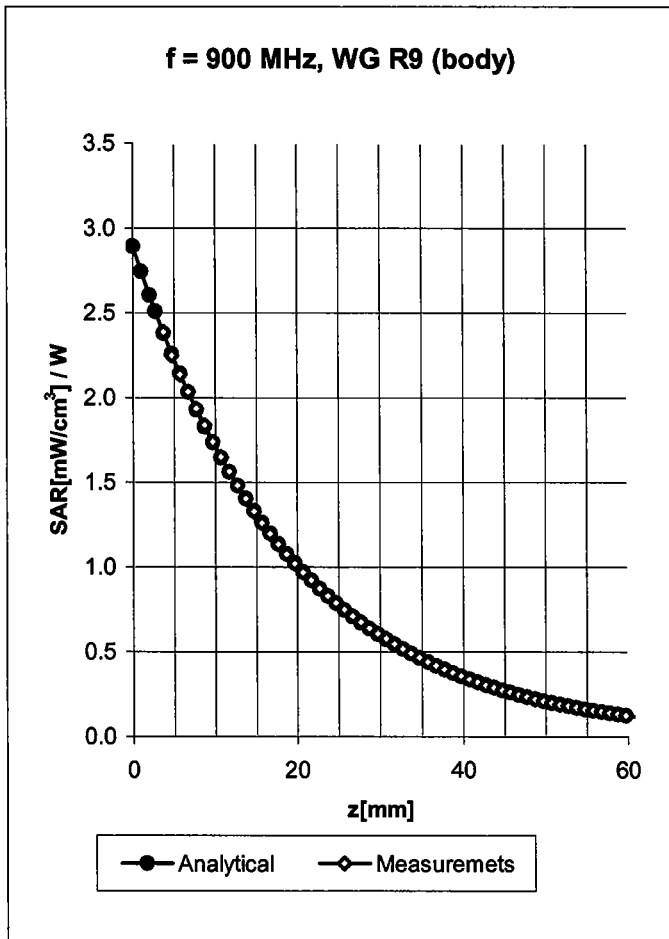

Body 900 MHz $\epsilon_r = 55.0 \pm 5\%$ $\sigma = 1.05 \pm 5\%$ mho/m

Valid for f=800-1000 MHz with Body Tissue Simulating Liquid according to OET 65 Suppl. C

ConvF X	6.4 $\pm 9.5\%$ (k=2)	Boundary effect:	
ConvF Y	6.4 $\pm 9.5\%$ (k=2)	Alpha	0.44
ConvF Z	6.4 $\pm 9.5\%$ (k=2)	Depth	2.29

Body 1800 MHz $\epsilon_r = 53.3 \pm 5\%$ $\sigma = 1.52 \pm 5\%$ mho/m

Valid for f=1710-1910 MHz with Body Tissue Simulating Liquid according to OET 65 Suppl. C

ConvF X	4.8 $\pm 9.5\%$ (k=2)	Boundary effect:	
ConvF Y	4.8 $\pm 9.5\%$ (k=2)	Alpha	0.57
ConvF Z	4.8 $\pm 9.5\%$ (k=2)	Depth	2.61

Deviation from Isotropy in HSL

Error (θ, ϕ), $f = 900$ MHz

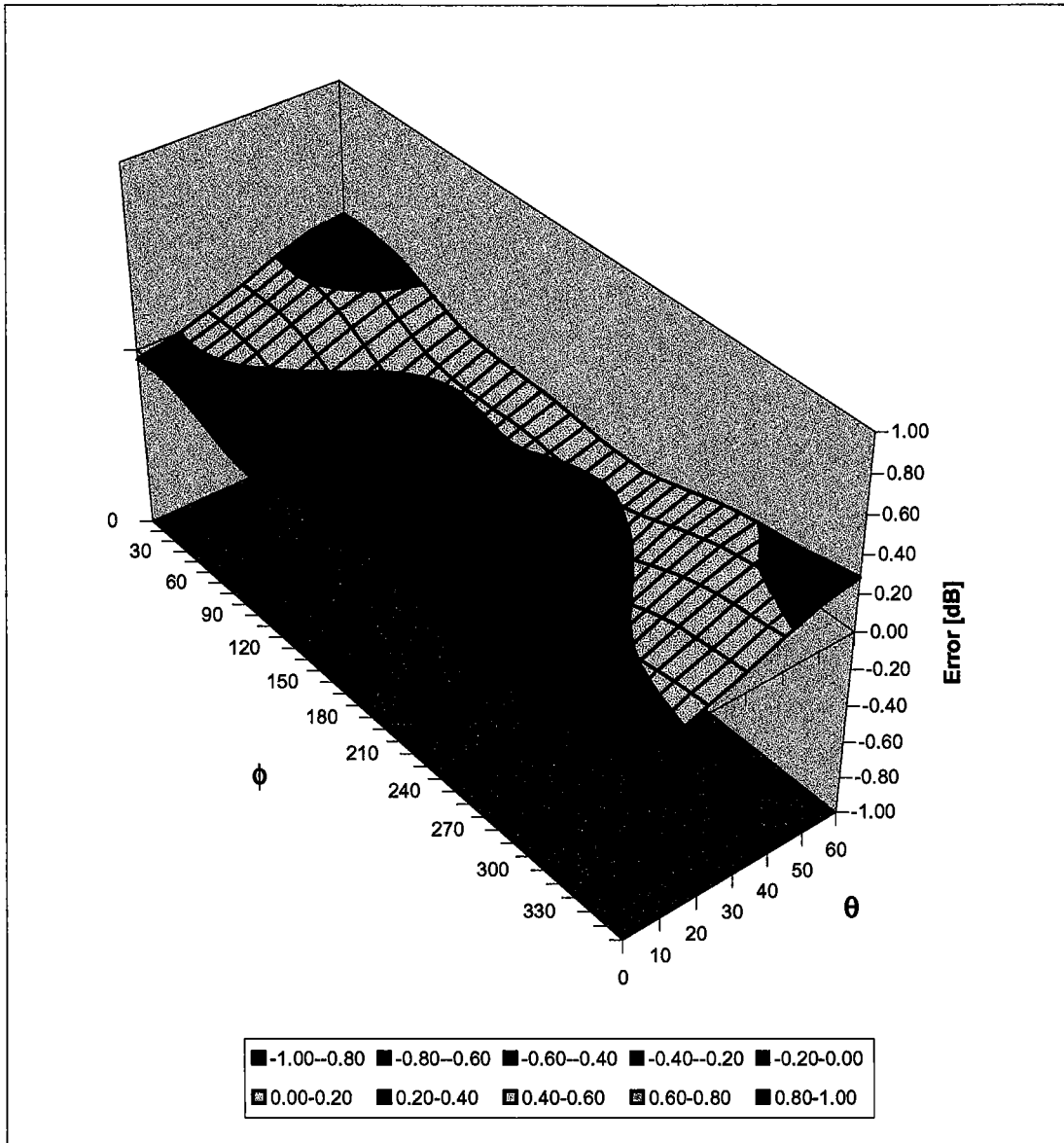

Appendix 4
Dipole Characterization Certificate

Certification of System Performance Check Targets

Based on APP-0396

-Historical Data-

	835MHz	900MHz	1800MHz	1900MHz	
P1528 Target: Advanced Extrapolation	9.5	10.8	38.1	39.7	(W/kg)
Measurement Uncertainty (k=1):	10.2%	10.2%	10.2%	10.2%	
Measurement Period:	November '02 - June '03	November '02 - June '03	November '02 - June '03	November '02 - June '03	
# of tests performed:	169	728	868	26	
Grand Average: Worst Case Extrapolation	10.1	11.6	39.7	42.0	(W/kg)
% Delta (Average - P1528 Target)	6.5%	7.7%	4.2%	5.9%	
Is % Delta <= Measurement Uncertainty?	Yes	Yes	Yes	Yes	
Accept/Reject Average as new system performance check target?	ACCEPT	ACCEPT	ACCEPT	ACCEPT	
	Applicable 835MHz Dipole Serial Numbers:	Applicable 900MHz Dipole Serial Numbers:	Applicable 1800MHz Dipole Serial Numbers:	Applicable 1900MHz Dipole Serial Numbers:	
	420(TR), 421(TR)	77, 78	246(TR), 250(TR)	514(TR), 518(TR)	
	422(TR), 423(TR)	79, 80	251(TR), 258(TR)	519(TR), 520(TR)	
	424(TR), 425(TR)	91, 92	259(TR), 262(TR)	523(TR), 524(TR)	
	431(TR), 432(TR)	93, 94	263(TR), 271(TR)	526(TR), 527(TR)	
	433(TR), 434(TR)	95, 96	272(TR), 273(TR)	528(TR), 529(TR)	
	436(TR)	97	276(TR), 277(TR)	530(TR), 533(TR)	
			279(TR), 280(TR)		
			281(TR), 282(TR)		
			283(TR), 284(TR)		

-New System Performance Check Targets- per APP-0396

(based on analysis of historical data)

Frequency	SAR Target (W/kg)	Permittivity	Conductivity (S/m)
835MHz	10.1	41.5 ± 5%	0.90 ± 5%
900MHz	11.6	41.5 ± 5%	0.97 ± 5%
1800MHz	39.7	40.0 ± 5%	1.40 ± 5%
1900MHz	42.0	40.0 ± 5%	1.40 ± 5%

-Approvals-

Submitted by:

Date:

Signed: *Marge Kaunas*

Comments:

Approved by:

Date:

Signed: *Antonio Faraone*

Comments:

Appendix 5
Measurement Uncertainty Budget

Uncertainty Budget for Device Under Test									
<i>a</i>	<i>b</i>	<i>c</i>	<i>d</i>	<i>e = f(d,k)</i>	<i>f</i>	<i>g</i>	<i>h = c x f / e</i>	<i>i = c x g / e</i>	<i>k</i>
Uncertainty Component	Sec.	Tol. (± %)	Prob. Dist.	Div.	<i>c_i</i> (1 g)	<i>c_i</i> (10 g)	1 g <i>u_i</i> (±%)	10 g <i>u_i</i> (±%)	<i>v_i</i>
Measurement System									
Probe Calibration	E.2.1	9.5	N	2.00	1	1	4.8	4.8	∞
Axial Isotropy	E.2.2	4.7	R	1.73	0.707	0.707	1.9	1.9	∞
Spherical Isotropy	E.2.2	9.6	R	1.73	0.707	0.707	3.9	3.9	∞
Boundary Effect	E.2.3	5.8	R	1.73	1	1	3.3	3.3	∞
Linearity	E.2.4	4.7	R	1.73	1	1	2.7	2.7	∞
System Detection Limits	E.2.5	1.0	R	1.73	1	1	0.6	0.6	∞
Readout Electronics	E.2.6	1.0	N	1.00	1	1	1.0	1.0	∞
Response Time	E.2.7	0.8	R	1.73	1	1	0.5	0.5	∞
Integration Time	E.2.8	1.3	R	1.73	1	1	0.8	0.8	∞
RF Ambient Conditions	E.6.1	3.0	R	1.73	1	1	1.7	1.7	∞
Probe Positioner Mechanical Tolerance	E.6.2	0.3	R	1.73	1	1	0.2	0.2	∞
Probe Positioning with respect to Phantom Shell	E.6.3	1.1	R	1.73	1	1	0.6	0.6	∞
Extrapolation, interpolation and Integration Algorithms for Max. SAR Evaluation	E.5	3.9	R	1.73	1	1	2.3	2.3	∞
Test sample Related									
Test Sample Positioning	E.4.2	3.6	N	1.00	1	1	3.6	3.6	29
Device Holder Uncertainty	E.4.1	2.8	N	1.00	1	1	2.8	2.8	8
Output Power Variation - SAR drift measurement	6.6.2	5.0	R	1.73	1	1	2.9	2.9	∞
Phantom and Tissue Parameters									
Phantom Uncertainty (shape and thickness tolerances)	E.3.1	4.0	R	1.73	1	1	2.3	2.3	∞
Liquid Conductivity - deviation from target values	E.3.2	5.0	R	1.73	0.64	0.43	1.8	1.2	∞
Liquid Conductivity - measurement uncertainty	E.3.3	10.0	R	1.73	0.64	0.43	3.7	2.5	∞
Liquid Permittivity - deviation from target values	E.3.2	10.0	R	1.73	0.6	0.49	3.5	2.8	∞
Liquid Permittivity - measurement uncertainty	E.3.3	5.0	R	1.73	0.6	0.49	1.7	1.4	∞
Combined Standard Uncertainty			RSS				11.72	11.09	1363
Expanded Uncertainty (95% CONFIDENCE LEVEL)			<i>k</i> =2				22.98	21.75	

Uncertainty Budget for System Performance Check (dipole & flat phantom)

<i>a</i>	<i>b</i>	<i>c</i>	<i>d</i>	<i>e = f(d,k)</i>	<i>f</i>	<i>g</i>	<i>h = c x f / e</i>	<i>i = c x g / e</i>	<i>k</i>
Uncertainty Component	Sec.	Tol. (± %)	Prob. Dist.	Div.	<i>c_i</i> (1 g)	<i>c_i</i> (10 g)	1 g <i>u_i</i> (±%)	10 g <i>u_i</i> (±%)	<i>v_i</i>
Measurement System									
Probe Calibration	E.2.1	9.5	N	2.00	1	1	4.8	4.8	∞
Axial Isotropy	E.2.2	4.7	R	1.73	1	1	2.7	2.7	∞
Spherical Isotropy	E.2.2	9.6	R	1.73	0	0	0.0	0.0	∞
Boundary Effect	E.2.3	5.8	R	1.73	1	1	3.3	3.3	∞
Linearity	E.2.4	4.7	R	1.73	1	1	2.7	2.7	∞
System Detection Limits	E.2.5	1.0	R	1.73	1	1	0.6	0.6	∞
Readout Electronics	E.2.6	1.0	N	1.00	1	1	1.0	1.0	∞
Response Time	E.2.7	0.0	R	1.73	1	1	0.0	0.0	∞
Integration Time	E.2.8	0.0	R	1.73	1	1	0.0	0.0	∞
RF Ambient Conditions	E.6.1	3.0	R	1.73	1	1	1.7	1.7	∞
Probe Positioner Mechanical Tolerance	E.6.2	0.3	R	1.73	1	1	0.2	0.2	∞
Probe Positioning with respect to Phantom Shell	E.6.3	1.1	R	1.73	1	1	0.6	0.6	∞
Extrapolation, interpolation and Integration Algorithms for Max. SAR Evaluation	E.5	3.9	R	1.73	1	1	2.3	2.3	∞
Dipole									
Dipole Axis to Liquid Distance	8, E.4.2	1.0	R	1.73	1	1	0.6	0.6	∞
Input Power and SAR Drift Measurement	8, 6.6.2	4.7	R	1.73	1	1	2.7	2.7	∞
Phantom and Tissue Parameters									
Phantom Uncertainty (shape and thickness tolerances)	E.3.1	4.0	R	1.73	1	1	2.3	2.3	∞
Liquid Conductivity - deviation from target values	E.3.2	5.0	R	1.73	0.64	0.43	1.8	1.2	∞
Liquid Conductivity - measurement uncertainty	E.3.3	10.0	R	1.73	0.64	0.43	3.7	2.5	∞
Liquid Permittivity - deviation from target values	E.3.2	10.0	R	1.73	0.6	0.49	3.5	2.8	∞
Liquid Permittivity - measurement uncertainty	E.3.3	5.0	R	1.73	0.6	0.49	1.7	1.4	∞
Combined Standard Uncertainty			RSS				10.16	9.43	99999
Expanded Uncertainty (95% CONFIDENCE LEVEL)			<i>k=2</i>				19.92	18.48	

Appendix 6

Photographs of the device under test



Figure 3. Front View of new Body Worn Accessory



Figure 4. Rear View of new Body Worn Accessory



Figure 5. Top View of new Body Worn Accessory



Figure 6. Bottom View of new Body Worn Accessory



Figure 7. Separation Distance Provided by new Body Worn Accessory