



# FCC RF Test Report

**APPLICANT** : Motorola Mobility LLC  
**EQUIPMENT** : Mobile Cellular Phone  
**BRAND NAME** : Motorola  
**MODEL NAME** : XT2535-15, XT2535-12  
**FCC ID** : IHDT56AV8  
**STANDARD** : FCC Part 15 Subpart E §15.407  
**CLASSIFICATION** : (NII) Unlicensed National Information Infrastructure  
**TEST DATE(S)** : Jul. 17, 2025 ~ Jul. 31, 2025

We, Sporton International Inc. (Kunshan), would like to declare that the tested sample has been evaluated in accordance with the test procedures and has been in compliance with the applicable technical standards.

The test results in this report apply exclusively to the tested model / sample. Without written approval of Sporton International Inc. (Kunshan), the test report shall not be reproduced except in full.

Jason Jia

Approved by: Jason Jia



**Sporton International Inc. (Kunshan)**

**No. 1098, Pengxi North Road, Kunshan Economic Development Zone Jiangsu Province 215300  
People's Republic of China**



# TABLE OF CONTENTS

**REVISION HISTORY..... 3**

**SUMMARY OF TEST RESULT ..... 4**

**1 GENERAL DESCRIPTION ..... 5**

1.1 Applicant ..... 5

1.2 Manufacturer..... 5

1.3 Product Feature of Equipment Under Test..... 5

1.4 Product Specification of Equipment Under Test..... 6

1.5 Modification of EUT ..... 7

1.6 Testing Location ..... 8

1.7 Test Software..... 8

1.8 Applicable Standards..... 8

1.9 Specification of Accessory..... 9

**2 TEST CONFIGURATION OF EQUIPMENT UNDER TEST..... 10**

2.1 Carrier Frequency and Channel ..... 10

2.2 Test Mode..... 11

2.3 Connection Diagram of Test System..... 13

2.4 Support Unit used in test configuration and system ..... 14

2.5 EUT Operation Test Setup ..... 14

2.6 Measurement Results Explanation Example..... 14

**3 TEST RESULT..... 15**

3.1 6dB and 26dB and 99% Occupied Bandwidth Measurement ..... 15

3.2 Maximum Conducted Output Power Measurement ..... 17

3.3 Power Spectral Density Measurement ..... 22

3.4 Unwanted Emissions Measurement..... 25

3.5 AC Conducted Emission Measurement..... 30

3.6 Antenna Requirements..... 32

**4 LIST OF MEASURING EQUIPMENT ..... 33**

**5 MEASUREMENT UNCERTAINTY ..... 34**

**APPENDIX A. CONDUCTED TEST RESULTS**

**APPENDIX B. AC CONDUCTED EMISSION TEST RESULT**

**APPENDIX C. RADIATED SPURIOUS EMISSION**

**APPENDIX D. DUTY CYCLE PLOTS**

**APPENDIX E. SETUP PHOTOGRAPHS**





### SUMMARY OF TEST RESULT

Report Section	FCC Rule	Description	Limit for U-NII-1/2A/2C	Limit for U-NII-3	Result	Remark
3.1	2.1049 & 15.403(i)	6dB, 26dB & 99% Bandwidth	-	6dB Bandwidth > 500kHz	Pass	-
3.2	15.407(a)	Maximum Conducted Output Power	≤ 24 dBm	≤ 30 dBm	Pass	-
3.3	15.407(a)	Power Spectral Density	≤ 11 dBm/MHz	≤ 30 dBm/500kHz	Pass	-
3.4	15.407(b)	Unwanted Emissions	15.407(b) & 15.209(a)	15.407(b)(4)(i) & 15.209(a)	Pass	Under limit 3.24 dB at 5731.56 MHz
3.5	15.207	AC Conducted Emission	15.207(a)	15.207(a)	Pass	Under limit 6.45 dB at 0.155 MHz
3.6	15.203 & 15.407(a)	Antenna Requirement	15.203 & 15.407(a)	15.203 & 15.407(a)	Pass	-

**Conformity Assessment Condition:**

- The test results (PASS/FAIL) with all measurement uncertainty excluded are presented against the regulation limits or in accordance with the requirements stipulated by the applicant/manufacturer who shall bear all the risks of non-compliance that may potentially occur if measurement uncertainty is taken into account.
- The measurement uncertainty please refer to each test result in the section "Measurement Uncertainty"

**Disclaimer:**

The product specifications of the EUT presented in the test report that may affect the test assessments are declared by the manufacturer who shall take full responsibility for the authenticity.



# 1 General Description

## 1.1 Applicant

Motorola Mobility LLC  
222 W,Merchandise Mart Plaza, Chicago IL 60654 USA

## 1.2 Manufacturer

Motorola Mobility LLC  
222 W,Merchandise Mart Plaza, Chicago IL 60654 USA

## 1.3 Product Feature of Equipment Under Test

Product Feature	
Equipment	Mobile Cellular Phone
Brand Name	Motorola
Model Name	XT2535-15, XT2535-12
FCC ID	IHDT56AV8
IMEI/SN Code	Conducted: NL5E1Y0103 Conduction: 359734130002315/359734130002323 Radiation: 355389550008518/355389550008526 for Sample 1 359734130002299/359734130002307 for Sample 2
HW Version	DVT2
SW Version	VVOB35.52
EUT Stage	Identical Prototype

**Remark:**

1. The above EUT's information was declared by manufacturer. Please refer to the specifications or user's manual for more detailed description.
2. There are two types of EUT, the differences between them could be referred to XT2535-15, XT2535-12\_Operational Description of Product Equality Declaration which is exhibit separately. According to the differences, we chose sample 1 to perform full test and sample 2 to verify the worst cases of sample 1.



### 1.4 Product Specification of Equipment Under Test

Standards-related Product Specification	
<b>Tx/Rx Frequency Range</b>	5180 MHz ~ 5240 MHz 5260 MHz ~ 5320 MHz 5500 MHz ~ 5720 MHz 5745 MHz ~ 5825 MHz
<b>Maximum Output Power to Antenna</b>	<p><b>&lt;5180 MHz ~ 5240 MHz&gt;</b>  802.11a : 14.60 dBm / 0.0288 W  802.11n HT20 : 14.48 dBm / 0.0281 W  802.11n HT40 : 14.31 dBm / 0.0270 W  802.11ac VHT20: 14.53 dBm / 0.0284 W  802.11ac VHT40: 14.38 dBm / 0.0274 W  802.11ac VHT80: 11.82 dBm / 0.0152 W</p> <p><b>&lt;5260 MHz ~ 5320 MHz&gt;</b>  802.11a : 14.67 dBm / 0.0293 W  802.11n HT20 : 14.48 dBm / 0.0281 W  802.11n HT40 : 14.26 dBm / 0.0267 W  802.11ac VHT20: 14.56 dBm / 0.0286 W  802.11ac VHT40: 14.32 dBm / 0.0270 W  802.11ac VHT80: 11.90 dBm / 0.0155 W</p> <p><b>&lt;5500 MHz ~ 5720 MHz &gt;</b>  802.11a : 13.25 dBm / 0.0211 W  802.11n HT20 : 13.06 dBm / 0.0202 W  802.11n HT40 : 13.04 dBm / 0.0201 W  802.11ac VHT20: 13.15 dBm / 0.0207 W  802.11ac VHT40: 13.10 dBm / 0.0204 W  802.11ac VHT80: 13.08 dBm / 0.0203 W</p> <p><b>&lt;5745 MHz ~ 5825 MHz&gt;</b>  802.11a : 12.79 dBm / 0.0190 W  802.11n HT20 : 12.61 dBm / 0.0182 W  802.11n HT40 : 12.65 dBm / 0.0184 W  802.11ac VHT20: 12.68 dBm / 0.0185 W  802.11ac VHT40: 12.70 dBm / 0.0186 W  802.11ac VHT80: 12.68 dBm / 0.0185 W</p>



<p><b>99% Occupied Bandwidth</b></p>	<p><b>&lt;5180 MHz ~ 5240 MHz&gt;</b>  802.11a : 17.127 MHz  802.11ac VHT20 : 18.036 MHz  802.11ac VHT40 : 36.218 MHz  802.11ac VHT80 : 75.491 MHz  <b>&lt;5260 MHz ~ 5320 MHz&gt;</b>  802.11a : 17.20 MHz  802.11ac VHT20 : 18.036 MHz  802.11ac VHT40 : 36.145 MHz  802.11ac VHT80 : 75.636 MHz  <b>&lt;5500 MHz ~ 5720 MHz&gt;</b>  802.11a : 17.127 MHz  802.11ac VHT20 : 18.036 MHz  802.11ac VHT40 : 36.218 MHz  802.11ac VHT80 : 75.345 MHz  <b>&lt;5745 MHz ~ 5825 MHz&gt;</b>  802.11a : 17.091 MHz  802.11ac VHT20 : 18.00 MHz  802.11ac VHT40 : 36.218 MHz  802.11ac VHT80 : 75.491 MHz</p>
<p><b>Antenna Type / Gain</b></p>	<p><b>&lt;5180 MHz ~ 5240 MHz&gt;</b>  IFA Antenna type with gain -3.5 dBi  <b>&lt;5260 MHz ~ 5320 MHz&gt;</b>  IFA Antenna type with gain -4.3 dBi  <b>&lt;5500 MHz ~ 5720 MHz&gt;</b>  IFA Antenna type with gain -4.2 dBi  <b>&lt;5745 MHz ~ 5825 MHz&gt;</b>  IFA Antenna type with gain -3.8 dBi</p>
<p><b>Type of Modulation</b></p>	<p>802.11a/n : OFDM (BPSK / QPSK / 16QAM / 64QAM)  802.11ac : OFDM (BPSK / QPSK / 16QAM / 64QAM / 256QAM)</p>

**Note:** For 802.11n HT20 / ac VHT20 and 802.11n HT40 / ac VHT40 mode, the whole testing has assessed only 802.11ac VHT20/ VHT40 by referring to their higher conducted power.

### 1.5 Modification of EUT

No modifications are made to the EUT during all test items.



### 1.6 Testing Location

Sporton International Inc. (Kunshan) is accredited to ISO/IEC 17025:2017 by American Association for Laboratory Accreditation with Certificate Number 5145.02.

<b>Test Firm</b>	Sporton International Inc. (Kunshan)		
<b>Test Site Location</b>	No. 1098, Pengxi North Road, Kunshan Economic Development Zone Jiangsu Province 215300 People's Republic of China TEL : +86-512-57900158		
<b>Test Site No.</b>	<b>Sporton Site No.</b>	<b>FCC Designation No.</b>	<b>FCC Test Firm Registration No.</b>
	CO01-KS 03CH06-KS TH01-KS	CN1257	314309

### 1.7 Test Software

Item	Site	Manufacturer	Name	Version
1.	TH01-KS	Tonscend	JS1120-3 test system China_210602	3.3.10
2.	03CH06-KS	AUDIX	E3	210616
3.	CO01-KS	AUDIX	E3	6.2009-8-24

### 1.8 Applicable Standards

According to the specifications of the manufacturer, the EUT must comply with the requirements of the following standards:

- 47 CFR Part 15 Subpart E
- FCC KDB 789033 D02 General UNII Test Procedures New Rules v02r01.
- ANSI C63.10-2013

**Remark:**

1. All test items were verified and recorded according to the standards and without any deviation during the test.
2. This EUT has also been tested and complied with the requirements of FCC Part 15, Subpart B, recorded in a separate test report.



### 1.9 Specification of Accessory

Specification of Accessory				
AC Adapter 1(US)	Brand Name	Motorola(AOHAI)	Model Name	MC-101
AC Adapter 1(EU)	Brand Name	Motorola(AOHAI)	Model Name	MC-102
AC Adapter 1(UK)	Brand Name	Motorola(AOHAI)	Model Name	MC-103
AC Adapter 1(AR)	Brand Name	Motorola(AOHAI)	Model Name	MC-106
AC Adapter 2(US)	Brand Name	Motorola(Chenyang)	Model Name	MC-101
AC Adapter 2(EU)	Brand Name	Motorola(Chenyang)	Model Name	MC-102
AC Adapter 2(UK)	Brand Name	Motorola(Chenyang)	Model Name	MC-103
AC Adapter 2(AR)	Brand Name	Motorola(Chenyang)	Model Name	MC-106
AC Adapter 2(BR)	Brand Name	Motorola(Chenyang)	Model Name	MC-107
AC Adapter 3(CHILE)	Brand Name	Motorola(SALCOMP)	Model Name	MC-109
AC Adapter 4(EU)	Brand Name	Motorola(AOHAI)	Model Name	MC-202L
AC Adapter 4(UK)	Brand Name	Motorola(AOHAI)	Model Name	MC-203L
AC Adapter 4(IN)	Brand Name	Motorola(AOHAI)	Model Name	MC-204
AC Adapter 5(EU)	Brand Name	Motorola(SALCOMP)	Model Name	MC-202L
AC Adapter 5(UK)	Brand Name	Motorola(SALCOMP)	Model Name	MC-203L
AC Adapter 6(EU)	Brand Name	Motorola(Chenyang)	Model Name	MC-202L
Battery 1	Brand Name	Motorola(SUNWODA)	Model Name	RL52
Battery 2	Brand Name	Motorola(SUNWODA)	Model Name	SL70
USB Cable 1	Brand Name	Motorola(Juwei)	Model Name	JWUB1982-ZN01H
USB Cable 2	Brand Name	Motorola(Washin)	Model Name	HX-ZN-37
USB Cable 3	Brand Name	Motorola(Juwei)	Model Name	JWUB1928-ZN01H
USB Cable 4	Brand Name	Motorola(Washin)	Model Name	HX-ZN-34
USB Cable 5	Brand Name	Motorola(Juwei)	Model Name	JWUB2002-ZN01H
USB Cable 6	Brand Name	Motorola(Washin)	Model Name	HX-ZN-39
Earphone	Brand Name	Motorola(New LEADER)	Model Name	NLD-EM313A-23SF-KD



## 2 Test Configuration of Equipment Under Test

- a. The EUT has been associated with peripherals and configuration operated in a manner tended to maximize its emission characteristics in a typical application. Frequency range investigated: conduction emission (150 kHz to 30 MHz), radiation emission (9 kHz to the 10th harmonic of the highest fundamental frequency or to 40 GHz, whichever is lower). For radiated measurement, pre-scanned in three orthogonal panels, X, Y, Z. The worst cases (X/Z plane) were recorded in this report.
- b. AC power line Conducted Emission was tested under maximum output power.

### 2.1 Carrier Frequency and Channel

Frequency Band	Channel	Freq.(MHz)	Channel	Freq. (MHz)
5180-5240 MHz U-NII-1	36	5180	44	5220
	38*	5190	46*	5230
	40	5200	48	5240
	42#	5210	-	-

Frequency Band	Channel	Freq.(MHz)	Channel	Freq. (MHz)
5260-5320 MHz U-NII-2A	52	5260	60	5300
	54*	5270	62*	5310
	56	5280	64	5320
	58#	5290	-	-

Frequency Band	Channel	Freq.(MHz)	Channel	Freq. (MHz)
5500-5720MHz U-NII-2C	100	5500	112	5560
	102*	5510	116	5580
	104	5520	132	5660
	106#	5530	134*	5670
	108	5540	136	5680
	110*	5550	140	5700

Frequency Band	Channel	Freq.(MHz)	Channel	Freq. (MHz)
5745-5825 MHz U-NII-3	149	5745	157	5785
	151*	5755	159*	5795
	153	5765	161	5805
	155#	5775	165	5825



Frequency Band	Channel	Freq.(MHz)	Channel	Freq. (MHz)
TDWR Channel	118*	5590	124	5620
	120	5600	126*	5630
	122#	5610	128	5640
	-	-	-	-

Frequency Band	Channel	Freq. (MHz)	Channel	Freq. (MHz)
Straddle Channel	138#	5690	144	5720
	142*	5710	-	-

Note:

1. The above Frequency and Channel in "\*" are 40MHz bandwidth.
2. The above Frequency and Channel in "#" are 80MHz bandwidth.

## 2.2 Test Mode

Final test modes are considering the modulation and worse data rates as below table.

### SISO Mode

Modulation	Data Rate
802.11a	6 Mbps
802.11n HT20	MCS0
802.11n HT40	MCS0
802.11ac VHT20	MCS0
802.11ac VHT40	MCS0
802.11ac VHT80	MCS0

<b>AC Conducted Emission</b>	Mode 1 : GSM850 Idle + WLAN Link(2.4G) + Bluetooth Link + USB Cable 2(Charging From Adaptor 2) + Earphone
<b>Remark:</b> For Radiated Test Cases, The tests were performance with Adapter1, Earphone and USB Cable1.	

RSE Co-location
Bluetooth-LE_GSFK 2Mbps CH38 2478 + 802.11a CH140 5700MHZ + LTE B38 link



Ch. #		U-NII-1	U-NII-2A	U-NII-2C	U-NII-3
		20M BW	20M BW	20M BW	20M BW
L	Low	36	52	100	149
M	Middle	44	60	116	157
H	High	48	64	140	165
Straddle		-	-	144	-

Ch. #		U-NII-1	U-NII-2A	U-NII-2C	U-NII-3
		40M BW	40M BW	40M BW	40M BW
L	Low	38	54	102	151
M	Middle	-	-	110	-
H	High	46	62	134	159
Straddle		-	-	142	-

Ch. #		U-NII-1	U-NII-2A	U-NII-2C	U-NII-3
		80M BW	80M BW	80M BW	80M BW
L	Low	-	-	106	-
M	Middle	42	58	-	155
H	High	-	-	-	-
Straddle		-	-	138	-

## 2.3 Connection Diagram of Test System

AC Conducted Emission:

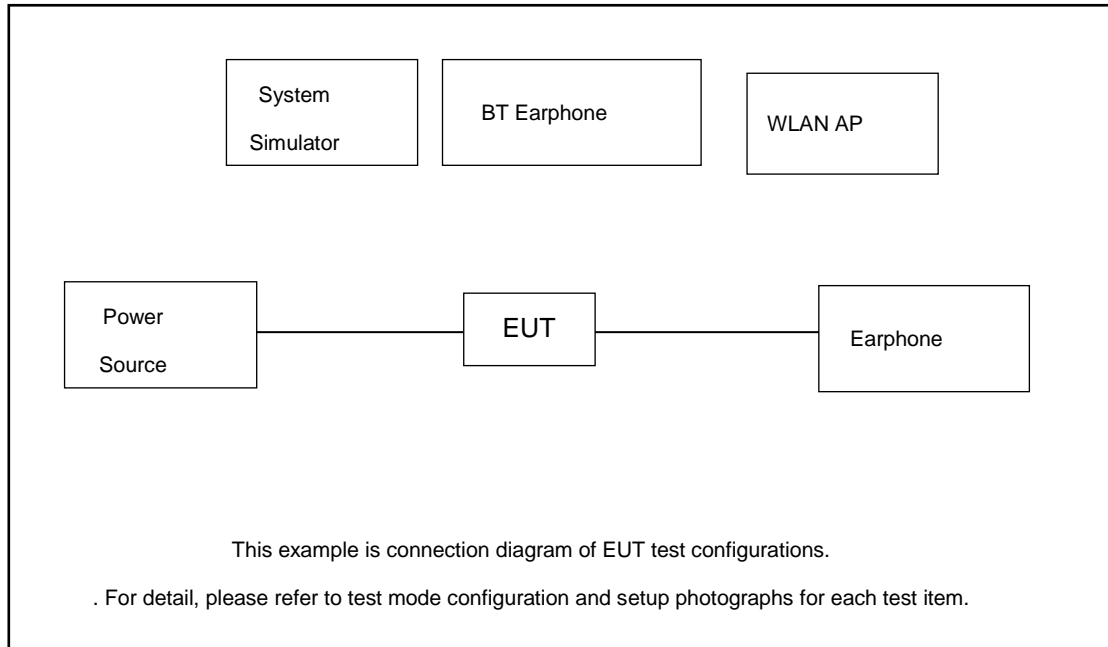

Radiated Emission:

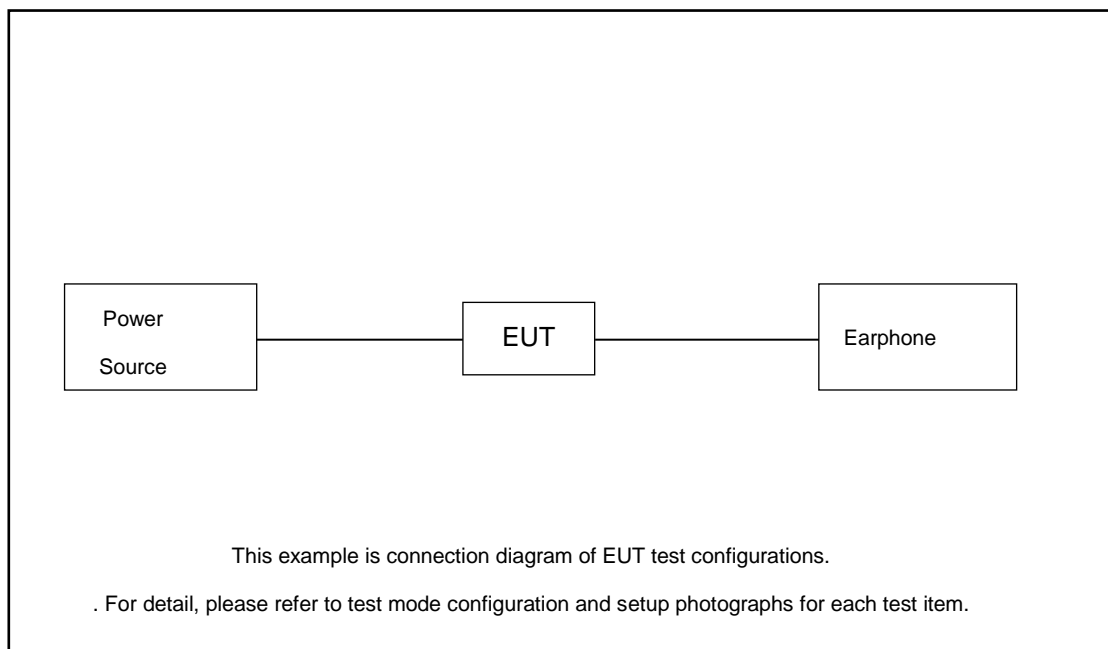



### 2.4 Support Unit used in test configuration and system

Item	Equipment	Trade Name	Model Name	FCC ID	Data Cable	Power Cord
1.	LTE Base Station	Anritus	MT8821C	N/A	N/A	Unshielded,1.8m
2.	WLAN AP	D-link	DIR-655	KA21R655B1	N/A	Unshielded,1.8m
3.	Bluetooth Earphone	Lenovo	thinkplus-BH3	N/A	N/A	N/A
4.	Notebook	Lenovo	G480	QDS-BRCM1050I	N/A	shielded cable DC O/P 1.8m , Unshielded AC I/P cable 1.8m
5.	SD Card	Kingston	8GB	N/A	N/A	N/A

### 2.5 EUT Operation Test Setup

For WLAN RF test items, an engineering test program was provided and enabled to make EUT continuously transmit.

For AC power line conducted emissions, the EUT was set to connect with the WLAN AP under large package sizes transmission.

### 2.6 Measurement Results Explanation Example

For all conducted test items:

The offset level is set in the spectrum analyzer to compensate the RF cable loss and attenuator factor between EUT conducted output port and spectrum analyzer. With the offset compensation, the spectrum analyzer reading level is exactly the EUT RF output level.

Example :

The spectrum analyzer offset is derived from RF cable loss and attenuator factor.

$$Offset = RF\ cable\ loss + attenuator\ factor.$$

Following shows an offset computation example with cable loss 4.4 dB and 20dB attenuator.

$$\begin{aligned}
Offset(dB) &= RF\ cable\ loss(dB) + attenuator\ factor(dB). \\
&= 4.4 + 20 = 24.4\ (dB)
\end{aligned}$$



### 3 Test Result

#### 3.1 6dB and 26dB and 99% Occupied Bandwidth Measurement

##### 3.1.1 Description of 6dB and 26dB and 99% Occupied Bandwidth

The minimum 6 dB bandwidth shall be at least 500 kHz.

26dB and 99% Occupied bandwidth are reporting only.

##### 3.1.2 Measuring Instruments

The measuring equipment is listed in the section 4 of this test report.

##### 3.1.3 Test Procedures

- 1. The testing follows FCC KDB 789033 D02 General UNII Test Procedures New Rules v02r01.

<input checked="" type="checkbox"/>	Section C) Bandwidth Measurement 1. Emission Bandwidth (EBW) and 99% OBW
	<ol style="list-style-type: none"> <li>1. Set RBW = approximately 1% of the emission bandwidth.</li> <li>2. Set the VBW &gt; RBW.</li> <li>3. Detector = Peak.</li> <li>4. Trace mode = max hold</li> <li>5. Measure the maximum width of the emission that is 26 dB down from the peak of the emission. Compare this with the RBW setting of the analyzer. Readjust RBW and repeat measurement as needed until the RBW/EBW ratio is approximately 1%.</li> <li>6. For 99% Bandwidth Measurement, the spectrum analyzer's resolution bandwidth (RBW) is set to 1%~5% of the OBW and set the Video bandwidth (VBW) ≥ 3 * RBW.</li> <li>7. Measure and record the results in the test report.</li> </ol>
<input checked="" type="checkbox"/>	Section C) Bandwidth Measurement 2. Minimum Emission Bandwidth for the band 5.725 - 5.85 GHz
	<ol style="list-style-type: none"> <li>1. Set RBW = 100kHz.</li> <li>2. Set the VBW ≥ 3 x RBW.</li> <li>3. Detector = Peak.</li> <li>4. Trace mode = max hold</li> <li>5. Measure the maximum width of the emission that is 6 dB down from the peak of the emission.</li> <li>6. Measure and record the results in the test report.</li> </ol>

### 3.1.4 Test Setup

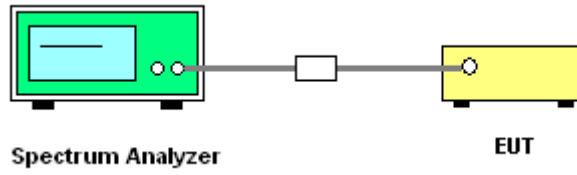

### 3.1.5 Test Result of 6dB Bandwidth

Please refer to Appendix A.



## 3.2 Maximum Conducted Output Power Measurement

### 3.2.1 Limit of Maximum Conducted Output Power

<FCC 14-30 CFR 15.407>

For mobile and portable client devices in the 5.15–5.25 GHz band, the maximum conducted output power over the frequency band of operation shall not exceed 250 mW.

For the 5.25–5.725 GHz bands, the maximum conducted output power over the frequency bands of operation shall not exceed the lesser of 250 mW or  $11 \text{ dBm} + 10 \log_{10} B$ , where B is the 26 dB emission bandwidth in megahertz.

For the band 5.725–5.85 GHz, the maximum conducted output power over the frequency band of operation shall not exceed 1 W.

For the 5.47–5.6 GHz and 5.65–5.725 GHz band, the maximum conducted output power shall not exceed 250 mW or  $11 + 10 \log_{10} B$ , dBm, whichever power is less. The maximum e.i.r.p. shall not exceed 1.0 W or  $17 + 10 \log_{10} B$ , dBm, whichever is less. B is the 99% emission bandwidth in megahertz.

For Straddle Channel, According to KDB 789033 D02 General UNII Test Procedures New Rules v02r01, If the power and PSD of the devices are uniform and comply with the lower limits specified for the U-NII-2 bands, a single measurement over the entire emission bandwidth can be performed to show compliance.

If transmitting antennas of directional gain greater than 6 dBi are used, the peak output power shall be reduced by the amount in dB that the directional gain of the antenna exceeds 6 dBi.

Note that U-NII-2 band, devices with a maximum e.i.r.p. greater than 500 mW shall implement TPC in order to have the capability to operate at least 6 dB below the maximum permitted e.i.r.p. of 1 W.

### 3.2.2 Measuring Instruments

The measuring equipment is listed in the section 4 of this test report.

### 3.2.3 Test Procedures

The testing follows Method PM of FCC KDB 789033 D02 General UNII Test Procedures New Rules v02r01.

Method PM (Measurement using an RF average power meter):

1. Measurement is performed using a wideband RF power meter.
2. The EUT is configured to transmit continuously with a consistent duty cycle at its maximum power control level.
3. Measure the average power of the transmitter, and the average power is corrected with duty factor,  $10 \log(1/x)$ , where  $x$  is the duty cycle.

For Straddle Channel, According to KDB 789033 D02 General UNII Test Procedures New Rules v02r01, If the power and PSD of the devices are uniform and comply with the lower limits specified for the U-NII-2 bands, a single measurement over the entire emission bandwidth can be performed to show compliance.

### 3.2.4 Test Setup

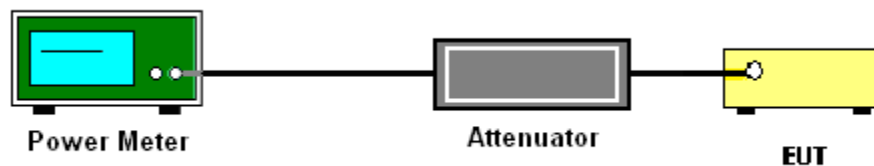



3.2.5 Test Result of Maximum Conducted Output Power

TEST RESULTS DATA											
Average Output Power											
FCC U-NII-1											
Mode						Power Setting	Average Conducted Power with duty factor(dBm)	Conducted Power Limit (dBm)	Gain(dBi)	EIRP Power (dBm)	Pass/Fail
Band	SISO	N <sub>TX</sub>	Channel	Freq (MHz)	Data Rate		Ant 1	Ant 1	Ant 1	Ant 1	
11a	SISO	1	36	5180	6Mbps	14.50	14.07	24.00	-3.50	10.57	Pass
11a	SISO	1	44	5220	6Mbps	15.00	14.55	24.00	-3.50	11.05	Pass
11a	SISO	1	48	5240	6Mbps	15.00	14.60	24.00	-3.50	11.10	Pass
HT20	SISO	1	36	5180	MCS0	15.00	14.45	24.00	-3.50	10.95	Pass
HT20	SISO	1	44	5220	MCS0	15.00	14.42	24.00	-3.50	10.92	Pass
HT20	SISO	1	48	5240	MCS0	15.00	14.48	24.00	-3.50	10.98	Pass
HT40	SISO	1	38	5190	MCS0	13.50	12.91	24.00	-3.50	9.41	Pass
HT40	SISO	1	46	5230	MCS0	15.00	14.31	24.00	-3.50	10.81	Pass
VHT20	SISO	1	36	5180	MCS0	15.00	14.49	24.00	-3.50	10.99	Pass
VHT20	SISO	1	44	5220	MCS0	15.00	14.48	24.00	-3.50	10.98	Pass
VHT20	SISO	1	48	5240	MCS0	15.00	14.53	24.00	-3.50	11.03	Pass
VHT40	SISO	1	38	5190	MCS0	13.50	12.94	24.00	-3.50	9.44	Pass
VHT40	SISO	1	46	5230	MCS0	15.00	14.38	24.00	-3.50	10.88	Pass
VHT80	SISO	1	42	5210	MCS0	12.50	11.82	24.00	-3.50	8.32	Pass

TEST RESULTS DATA												
Average Output Power												
FCC U-NII-2A												
Mode						Power Setting	Average Conducted Power with duty factor(dBm)	FCC Conducted Power Limit (dBm)	Gain(dBi)	EIRP Power (dBm)	EIRP Power Limit (dBm)	Pass/Fail
Band	SISO	N <sub>TX</sub>	Channel	Freq (MHz)	Data Rate		Ant 1	Ant 1	Ant 1	Ant 1	Ant 1	
11a	SISO	1	52	5260	6Mbps	15.00	14.67	23.96	-4.30	10.37	26.99	Pass
11a	SISO	1	60	5300	6Mbps	15.00	14.67	24.00	-4.30	10.37	26.99	Pass
11a	SISO	1	64	5320	6Mbps	15.00	14.65	24.00	-4.30	10.35	26.99	Pass
HT20	SISO	1	52	5260	MCS0	15.00	14.45	24.00	-4.30	10.15	26.99	Pass
HT20	SISO	1	60	5300	MCS0	15.00	14.48	24.00	-4.30	10.18	26.99	Pass
HT20	SISO	1	64	5320	MCS0	14.00	13.56	24.00	-4.30	9.26	26.99	Pass
HT40	SISO	1	54	5270	MCS0	15.00	14.26	24.00	-4.30	9.96	26.99	Pass
HT40	SISO	1	62	5310	MCS0	13.50	12.88	24.00	-4.30	8.58	26.99	Pass
VHT20	SISO	1	52	5260	MCS0	15.00	14.50	24.00	-4.30	10.20	26.99	Pass
VHT20	SISO	1	60	5300	MCS0	15.00	14.56	24.00	-4.30	10.26	26.99	Pass
VHT20	SISO	1	64	5320	MCS0	14.00	13.63	24.00	-4.30	9.33	26.99	Pass
VHT40	SISO	1	54	5270	MCS0	15.00	14.32	24.00	-4.30	10.02	26.99	Pass
VHT40	SISO	1	62	5310	MCS0	13.50	12.93	24.00	-4.30	8.63	26.99	Pass
VHT80	SISO	1	58	5290	MCS0	12.50	11.90	24.00	-4.30	7.60	26.99	Pass



TEST RESULTS DATA												
Average Output Power												
FCC U-NII-2C												
Mode						Power Setting	Average Conducted Power with duty factor(dBm)	FCC Conducted Power Limit (dBm)	Gain(dBi)	EIRP Power (dBm)	EIRP Power Limit (dBm)	Pass/Fail
Band	SISO	N <sub>TX</sub>	Channel	Freq (MHz)	Data Rate		Ant 1	Ant 1	Ant 1	Ant 1	Ant 1	
11a	SISO	1	100	5500	6Mbps	14.00	13.08	23.98	-4.20	8.88	26.99	Pass
11a	SISO	1	116	5580	6Mbps	14.00	13.16	23.93	-4.20	8.96	26.99	Pass
11a	SISO	1	140	5700	6Mbps	14.00	13.22	23.98	-4.20	9.02	26.99	Pass
11a	SISO	1	144	5720	6Mbps	14.00	13.25	23.98	-4.20	9.05	26.99	Pass
HT20	SISO	1	100	5500	MCS0	14.00	13.05	23.98	-4.20	8.85	26.99	Pass
HT20	SISO	1	116	5580	MCS0	14.00	13.06	23.98	-4.20	8.86	26.99	Pass
HT20	SISO	1	140	5700	MCS0	13.50	12.54	23.98	-4.20	8.34	26.99	Pass
HT20	SISO	1	144	5720	MCS0	14.00	13.06	23.98	-4.20	8.86	26.99	Pass
HT40	SISO	1	102	5510	MCS0	14.00	12.91	23.98	-4.20	8.71	26.99	Pass
HT40	SISO	1	110	5550	MCS0	14.00	13.02	23.98	-4.20	8.82	26.99	Pass
HT40	SISO	1	134	5670	MCS0	14.00	13.04	23.98	-4.20	8.84	26.99	Pass
HT40	SISO	1	142	5710	MCS0	14.00	13.01	23.98	-4.20	8.81	26.99	Pass
VHT20	SISO	1	100	5500	MCS0	14.00	13.09	23.98	-4.20	8.89	26.99	Pass
VHT20	SISO	1	118	5580	MCS0	14.00	13.11	23.98	-4.20	8.91	26.99	Pass
VHT20	SISO	1	140	5700	MCS0	13.50	12.58	23.98	-4.20	8.38	26.99	Pass
VHT20	SISO	1	144	5720	MCS0	14.00	13.15	23.98	-4.20	8.95	26.99	Pass
VHT40	SISO	1	102	5510	MCS0	14.00	12.98	23.98	-4.20	8.78	26.99	Pass
VHT40	SISO	1	110	5550	MCS0	14.00	13.08	23.98	-4.20	8.88	26.99	Pass
VHT40	SISO	1	134	5670	MCS0	14.00	13.10	23.98	-4.20	8.90	26.99	Pass
VHT40	SISO	1	142	5710	MCS0	14.00	13.07	23.98	-4.20	8.87	26.99	Pass
VHT80	SISO	1	106	5530	MCS0	13.50	12.55	23.98	-4.20	8.35	26.99	Pass
VHT80	SISO	1	122	5610	MCS0	14.00	13.04	23.98	-4.20	8.84	26.99	Pass
VHT80	SISO	1	138	5690	MCS0	14.00	13.08	23.98	-4.20	8.88	26.99	Pass



TEST RESULTS DATA Average Output Power												
FCC-U-NII-3												
Mode						Power Setting	Average Conducted Power with duty factor(dBm)	Conducted Power Limit (dBm)	Gain(dBi)	EIRP Power (dBm)	EIRP Power Limit (dBm)	Pass/Fail
Band	SISO	N <sub>TX</sub>	Channel	Freq (MHz)	Data Rate		Ant 1	Ant 1	Ant 1	Ant 1	Ant 1	
11a	SISO	1	149	5745	6Mbps	13.50	12.75	30.00	-3.80	8.95	36.00	Pass
11a	SISO	1	157	5785	6Mbps	13.50	12.79	30.00	-3.80	8.99	36.00	Pass
11a	SISO	1	165	5825	6Mbps	13.50	12.77	30.00	-3.80	8.97	36.00	Pass
HT20	SISO	1	149	5745	MCS0	13.50	12.55	30.00	-3.80	8.75	36.00	Pass
HT20	SISO	1	157	5785	MCS0	13.50	12.61	30.00	-3.80	8.81	36.00	Pass
HT20	SISO	1	165	5825	MCS0	13.50	12.60	30.00	-3.80	8.80	36.00	Pass
HT40	SISO	1	151	5755	MCS0	13.50	12.65	30.00	-3.80	8.85	36.00	Pass
HT40	SISO	1	159	5795	MCS0	13.50	12.64	30.00	-3.80	8.84	36.00	Pass
VHT20	SISO	1	149	5745	MCS0	13.50	12.60	30.00	-3.80	8.80	36.00	Pass
VHT20	SISO	1	157	5785	MCS0	13.50	12.68	30.00	-3.80	8.88	36.00	Pass
VHT20	SISO	1	159	5795	MCS0	13.50	12.66	30.00	-3.80	8.86	36.00	Pass
VHT40	SISO	1	151	5755	MCS0	13.50	12.67	30.00	-3.80	8.87	36.00	Pass
VHT40	SISO	1	159	5795	MCS0	13.50	12.70	30.00	-3.80	8.90	36.00	Pass
VHT80	SISO	1	155	5775	MCS0	13.50	12.68	30.00	-3.80	8.88	36.00	Pass



### 3.3 Power Spectral Density Measurement

#### 3.3.1 Limit of Power Spectral Density

<FCC 14-30 CFR 15.407>

For mobile and portable client devices in the 5.15–5.25 GHz band, the maximum power spectral density shall not exceed 11dBm in any 1 megahertz band.

For the 5.25–5.725 GHz bands, the maximum power spectral density shall not exceed 11 dBm in any 1 megahertz band.

For the band 5.725–5.85 GHz, the maximum power spectral density shall not exceed 30 dBm in any 500-kHz band.

For Straddle Channel, According to KDB 789033 D02 General UNII Test Procedures New Rules v02r01, If the power and PSD of the devices are uniform and comply with the lower limits specified for the U-NII-2 bands, a single measurement over the entire emission bandwidth can be performed to show compliance.

If transmitting antennas of directional gain greater than 6 dBi are used, the peak output power shall be reduced by the amount in dB that the directional gain of the antenna exceeds 6 dBi.

#### 3.3.2 Measuring Instruments

The measuring equipment is listed in the section 4 of this test report.



### 3.3.3 Test Procedures

The testing follows FCC KDB 789033 D02 General UNII Test Procedures New Rules v01r04. Section F) Maximum power spectral density.

#### **For devices operating in the bands UNII-1/2A/2C**

##### **# Method SA-2 #**

(trace averaging across on and off times of the EUT transmissions, followed by duty cycle correction).

- Measure the duty cycle.
- Set span to encompass the entire emission bandwidth (EBW) of the signal.
- Set RBW = 1 MHz.
- Set VBW  $\geq$  3 MHz.
- Number of points in sweep  $\geq$  2 Span / RBW.
- Sweep time = auto.
- Detector = RMS
- Trace average at least 100 traces in power averaging mode.
- Add  $10 \log(1/x)$ , where x is the duty cycle, to the measured power in order to compute the average power during the actual transmission times. For example, add  $10 \log(1/0.25) = 6$  dB if the duty cycle is 25 percent.

#### **For devices operating in the band UNII-3**

##### **# Method SA-2 #**

(trace averaging across on and off times of the EUT transmissions, followed by duty cycle correction).

- Measure the duty cycle.
- Set span to encompass the entire emission bandwidth (EBW) of the signal.
- Set RBW = 500KHz (or 300 kHz if the SA can't set RBW=500KHz).
- Set VBW  $\geq$  1 MHz.
- Number of points in sweep  $\geq$  2 Span / RBW.
- Sweep time = auto.
- Detector = RMS
- Trace average at least 100 traces in power averaging mode.
- If the SA can't set RBW=500KHz, then add  $10 \log(500\text{kHz}/\text{RBW})$  to the test result.
- Add  $10 \log(1/x)$ , where x is the duty cycle, to the measured power in order to compute the average power during the actual transmission times. For example, add  $10 \log(1/0.25) = 6$  dB if the duty cycle is 25 percent.

1. The RF output of EUT was connected to the spectrum analyzer by a low loss cable.
2. Each plot has already offset with cable loss, and attenuator loss. Measure the PPSD and record it.

### 3.3.4 Test Setup

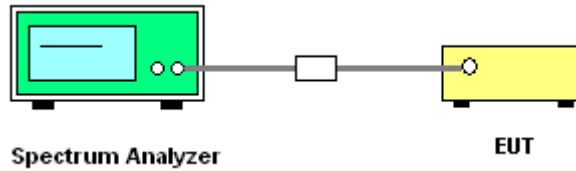

### 3.3.5 Test Result of Power Spectral Density

Please refer to Appendix A.



## 3.4 Unwanted Emissions Measurement

This section as specified in FCC Part 15.407(b) is to measure unwanted emissions through radiated measurement for band edge spurious emissions and out of band emissions measurement. The unwanted emissions shall comply with 15.407(b)(1) to (6), and restricted bands per FCC Part 15.205.

### 3.4.1 Limit of Unwanted Emissions

- (1) For transmitters operating in the 5150-5250 MHz band: all emissions outside of the 5150-5350 MHz band shall not exceed an EIRP of  $-27$  dBm/MHz.

For transmitters operating in the 5250-5350 MHz band: all emissions outside of the 5150-5350 MHz band shall not exceed an EIRP of  $-27$  dBm/MHz. Devices operating in the 5250-5350 MHz band that generate emissions in the 5150-5250 MHz band must meet all applicable technical requirements for operation in the 5150-5250 MHz band (including indoor use) or alternatively meet an out-of-band emission EIRP limit of  $-27$  dBm/MHz in the 5150-5250 MHz band.

For transmitters operating in the 5470-5600 MHz and 5650-5725 MHz band: all emissions outside of the 5470-5600 MHz and 5650-5725 MHz band shall not exceed an EIRP of  $-27$  dBm/MHz.

- (2) For transmitters operating in the 5.725-5.85 GHz band:  
15.407(b)(4)(i) All emissions shall be limited to a level of  $-27$  dBm/MHz at 75 MHz or more above or below the band edge increasing linearly to 10 dBm/MHz at 25 MHz above or below the band edge, and from 25 MHz above or below the band edge increasing linearly to a level of 15.6 dBm/MHz at 5 MHz above or below the band edge, and from 5 MHz above or below the band edge increasing linearly to a level of 27 dBm/MHz at the band edge.



(3) Unwanted spurious emissions fallen in restricted bands shall comply with the general field strength limits as below table,

Frequency (MHz)	Field Strength (microvolts/meter)	Measurement Distance (meters)
0.009 – 0.490	2400/F(kHz)	300
0.490 – 1.705	24000/F(kHz)	30
1.705 – 30.0	30	30
30 – 88	100	3
88 – 216	150	3
216 - 960	200	3
Above 960	500	3

(4) EIRP (dBm)	Field Strength at 3m (dBµV/m)
- 27	68.2

Note: The following formula is used to convert the EIRP to field strength.

$$EIRP = E_{Meas} + 20\log (d_{Meas}) - 104.7$$

where

EIRP is the equivalent isotropically radiated power, in dBm

E<sub>Meas</sub> is the field strength of the emission at the measurement distance, in dBµV/m

d<sub>Meas</sub> is the measurement distance, in m

### 3.4.2 Measuring Instruments

The measuring equipment is listed in the section 4 of this test report.



### 3.4.3 Test Procedures

1. The testing follows FCC KDB 789033 D02 General UNII Test Procedures New Rules v01r04. Section G) Unwanted emissions measurement.
  - (1) Procedure for Unwanted Emissions Measurements Below 1000MHz
    - RBW = 120 kHz
    - VBW = 300 kHz
    - Detector = Peak
    - Trace mode = max hold
  - (2) Procedure for Peak Unwanted Emissions Measurements Above 1000 MHz
    - RBW = 1 MHz
    - VBW  $\geq$  3 MHz
    - Detector = Peak
    - Sweep time = auto
    - Trace mode = max hold
  - (3) Procedures for Average Unwanted Emissions Measurements Above 1000MHz
    - RBW = 1 MHz
    - VBW = 10 Hz, when duty cycle is no less than 98 percent.
    - VBW  $\geq$  1/T, when duty cycle is less than 98 percent where T is the minimum transmission duration over which the transmitter is on.
2. The EUT was placed on a turntable with 0.8 meter for frequency below 1GHz and 1.5 meter for frequency above 1GHz respectively above ground.
3. The EUT was set 3 meters from the interference receiving antenna which was mounted on the top of a variable height antenna tower.
4. The antenna is a broadband antenna and its height is adjusted between one meter and four meters above ground to find the maximum value of the field strength for both horizontal polarization and vertical polarization of the antenna.
5. For each suspected emission, the EUT was arranged to its worst case and then adjust the antenna tower (from 1 m to 4 m) and turntable (from 0 degree to 360 degrees) to find the maximum reading.
6. For testing below 1GHz, if the emission level of the EUT in peak mode was 3 dB lower than the limit specified, then peak values of EUT will be reported, otherwise, the emissions will be repeated one by one using the CISPR quasi-peak method and reported.
7. For testing above 1GHz, the emission level of the EUT in peak mode was 20dB lower than average limit (that means the emission level in average mode also complies with the limit in average mode), then peak values of EUT will be reported, otherwise, the emissions will be measured in average mode again and reported.

### 3.4.4 Test Setup

For radiated emissions below 30MHz

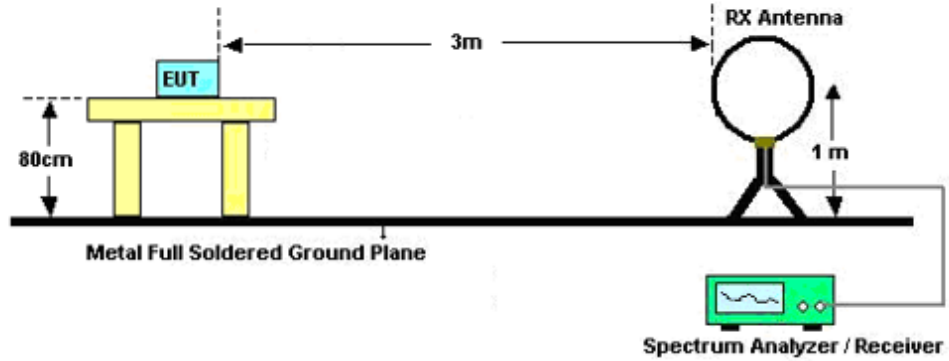

For radiated emissions from 30MHz to 1GHz

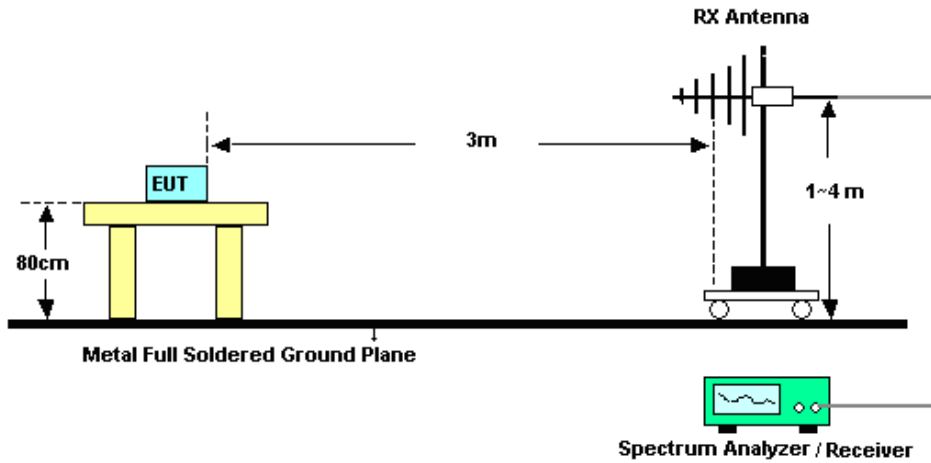

For radiated emissions above 1GHz

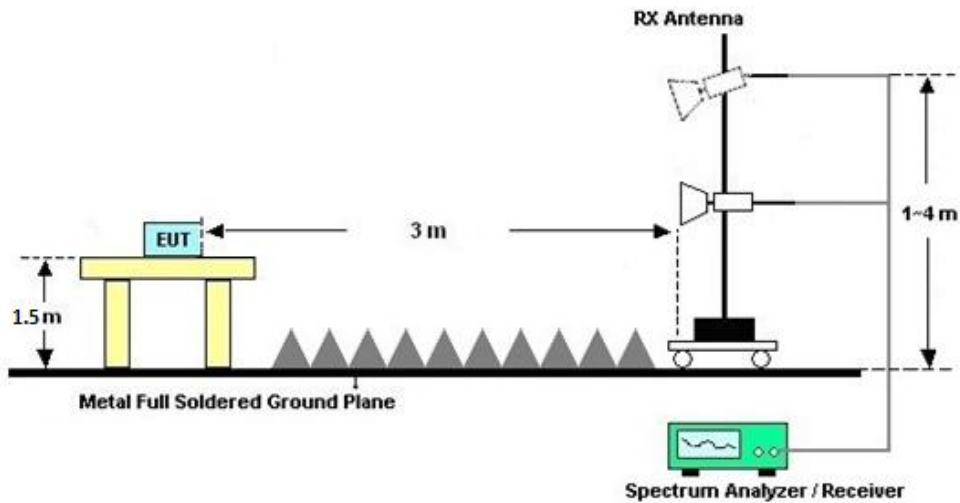



### **3.4.5 Test Results of Radiated Spurious Emissions (9 kHz ~ 30 MHz)**

The low frequency, which started from 9 kHz to 30MHz, was pre-scanned and the result which was 20dB lower than the limit line was not reported.

There is a comparison data of both open-field test site and semi-Anechoic chamber, and the result came out very similar.

### **3.4.6 Test Result of Radiated Spurious at Band Edges**

Please refer to Appendix C.

### **3.4.7 Duty Cycle**

Please refer to Appendix D.

### **3.4.8 Test Result of Radiated Spurious Emissions (30MHz ~ 10th Harmonic)**

Please refer to Appendix C.



### 3.5 AC Conducted Emission Measurement

#### 3.5.1 Limit of AC Conducted Emission

For equipment that is designed to be connected to the public utility (AC) power line, the radio frequency voltage that is conducted back onto the AC power line on any frequency or frequencies within the band 150 kHz to 30 MHz shall not exceed the limits in the following table.

Frequency of emission (MHz)	Conducted limit (dBµV)	
	Quasi-peak	Average
0.15-0.5	66 to 56*	56 to 46*
0.5-5	56	46
5-30	60	50

\*Decreases with the logarithm of the frequency.

#### 3.5.2 Measuring Instruments

The measuring equipment is listed in the section 4 of this test report.

#### 3.5.3 Test Procedures

1. The EUT was placed 0.4 meter from the conducting wall of the shielding room was kept at least 80 centimeters from any other grounded conducting surface.
2. Connect EUT to the power mains through a line impedance stabilization network (LISN).
3. All the support units are connecting to the other LISN.
4. The LISN provides 50 ohm coupling impedance for the measuring instrument.
5. The FCC states that a 50 ohm, 50 microhenry LISN should be used.
6. Both sides of AC line were checked for maximum conducted interference.
7. The frequency range from 150 kHz to 30 MHz was searched.
8. Set the test-receiver system to Peak Detect Function and specified bandwidth with Maximum Hold Mode.

### 3.5.4 Test Setup

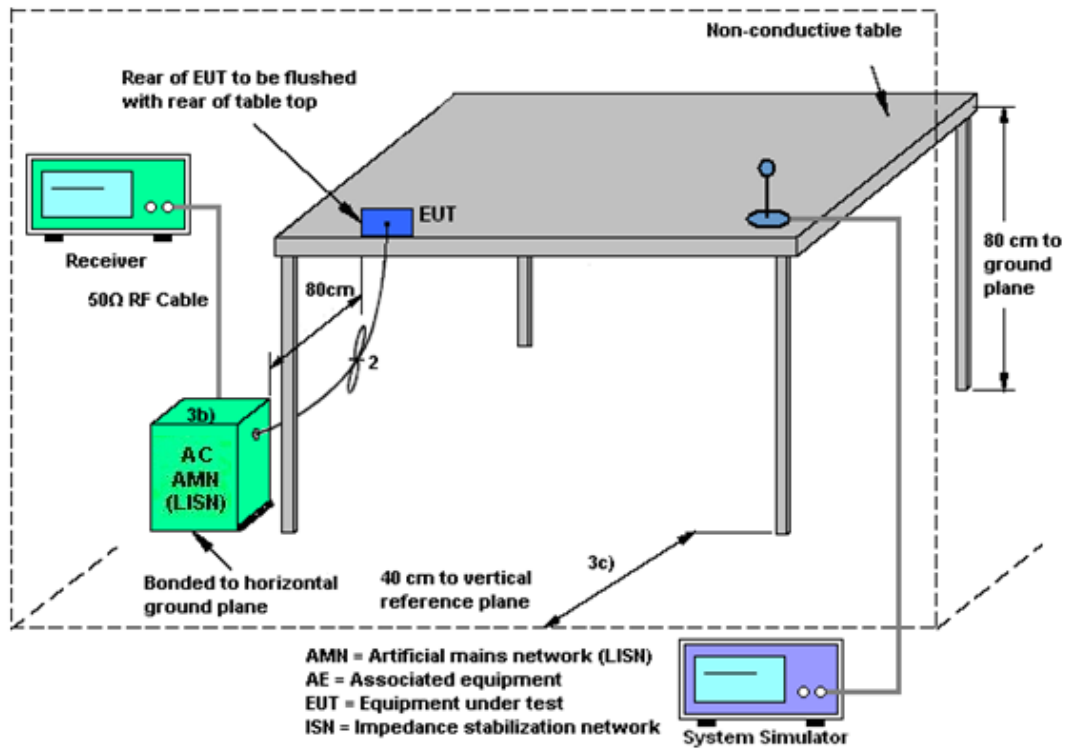

### 3.5.5 Test Result of AC Conducted Emission

Please refer to Appendix B.



## **3.6 Antenna Requirements**

### **3.6.1 Standard Applicable**

According to FCC 47 CFR Section 15.407(a)(1)(2), if transmitting antenna directional gain is greater than 6 dBi, both the peak transmit power and the peak power spectral density shall be reduced by the amount in dB that the directional gain of the antenna exceeds 6 dBi.

### **3.6.2 Antenna Anti-Replacement Construction**

An embedded-in antenna design is used.

### **3.6.3 Antenna Gain**

The antenna peak gain of EUT is less than 6 dBi. Therefore, it is not necessary to reduce maximum peak output power limit.



## 4 List of Measuring Equipment

Instrument	Manufacturer	Model No.	Serial No.	Characteristics	Calibration Date	Test Date	Due Date	Remark
EMI Test Receiver	Keysight	N9038A	MY57290157	3Hz~8.5GHz;Ma x 30dBm	Feb. 22, 2025	Jul. 17, 2025	Feb. 21, 2026	Radiation (03CH06-KS)
EXA Spectrum Analyzer	Keysight	N9010B	MY57471084	10Hz-44GHz	Jul. 04, 2024	Jul. 17, 2025	Jul. 03, 2025	Radiation (03CH06-KS)
EXA Spectrum Analyzer	Keysight	N9010B	MY57471084	10Hz-44GHz	Jul. 03, 2025		Jul. 02, 2026	Radiation (03CH06-KS)
Loop Antenna	R&S	HFH2-Z2E	101125	9kHz~30MHz	Sep. 08, 2024	Jul. 17, 2025	Sep. 07, 2025	Radiation (03CH06-KS)
Bilog Antenna	TeseQ	CBL6111D	59913	30MHz-1GHz	Sep. 03, 2024	Jul. 17, 2025	Sep. 02, 2025	Radiation (03CH06-KS)
Double Ridge Horn Antenna	ETS-Lindgren	3117	00251694	1GHz~18GHz	Jul. 06, 2024	Jul. 17, 2025	Jul. 05, 2025	Radiation (03CH06-KS)
Double Ridge Horn Antenna	ETS-Lindgren	3117	00251694	1GHz~18GHz	Jul. 05, 2025		Jul. 04, 2026	Radiation (03CH06-KS)
SHF-EHF Horn	Com-power	AH-840	101116	18GHz~40GHz	Oct. 22, 2024	Jul. 17, 2025	Oct. 21, 2025	Radiation (03CH06-KS)
Amplifier	SONOMA	310N	380827	9KHz ~1GHZ	Jul. 04, 2024	Jul. 17, 2025	Jul. 03, 2025	Radiation (03CH06-KS)
Amplifier	SONOMA	310N	380827	9KHz ~1GHZ	Jul. 03, 2025		Jul. 02, 2026	Radiation (03CH06-KS)
Amplifier	EM	EM18G40GA	060728	18~40GHz	Jan. 03, 2025	Jul. 17, 2025	Jan. 02, 2026	Radiation (03CH06-KS)
high gain Amplifier	EM	EM01G18GA	060845	1Ghz-18Ghz	Jan. 03, 2025	Jul. 17, 2025	Jan. 02, 2026	Radiation (03CH06-KS)
Amplifier	Keysight	83017A	MY57280119	500MHz~26.5G Hz	Oct. 09, 2024	Jul. 17, 2025	Oct. 08, 2025	Radiation (03CH06-KS)
AC Power Source	Chroma	61601	F104090004	N/A	NCR	Jul. 17, 2025	NCR	Radiation (03CH06-KS)
Turn Table	ChamPro	EM 1000-T	060762-T	0~360 degree	NCR	Jul. 17, 2025	NCR	Radiation (03CH06-KS)
Antenna Mast	ChamPro	EM 1000-A	060762-A	1 m~4 m	NCR	Jul. 17, 2025	NCR	Radiation (03CH06-KS)
EMI Receiver	R&S	ESCI7	100768	9kHz~7GHz;	Apr. 16, 2025	Jul. 31, 2025	Apr. 15, 2026	Conduction (CO01-KS)
AC LISN (for auxiliary equipment)	MessTec	AN3016	060103	9kHz~30MHz	Aug. 20, 2024	Jul. 31, 2025	Aug. 19, 2025	Conduction (CO01-KS)
AC LISN	MessTec	AN3016	060105	9kHz~30MHz	Dec. 24, 2024	Jul. 31, 2025	Dec. 23, 2025	Conduction (CO01-KS)
AC Power Source	Chroma	61602	ABP000000811	AC 0V~300V, 45Hz~1000Hz	Oct. 09, 2024	Jul. 31, 2025	Oct. 08, 2025	Conduction (CO01-KS)
Spectrum Analyzer	R&S	FSV40	101040	10Hz~40GHz	Oct. 10, 2024	Jul. 30, 2025	Oct. 09, 2025	Conducted (TH01-KS)
Pulse Power Sensor	Anritsu	MA2411B	0917070	300MHz~40GHz	Jan. 02, 2025	Jul. 30, 2025	Jan. 01, 2026	Conducted (TH01-KS)
Power Meter	Anritsu	ML2495A	1005002	50MHz Bandwidth	Jan. 02, 2025	Jul. 30, 2025	Jan. 01, 2026	Conducted (TH01-KS)

NCR: No Calibration Required



## 5 Measurement Uncertainty

The measurement uncertainties shown below were calculated in accordance with the requirements of ANSI 63.10-2013. All the measurement uncertainty value were shown with a coverage K=2 to indicate 95% level of confidence. The measurement data show herein meets or exceeds the CISPR measurement uncertainty values specified in CISPR 16-4-2 and can be compared directly to specified limit to determine compliance.

### Uncertainty of Conducted Measurement

Conducted Spurious Emission & Bandedge	±2.00 dB
Occupied Channel Bandwidth	±0.384%
Conducted Power	±0.90 dB
Conducted Power Spectral Density	±0.90 dB
Frequency	±0.38 Hz

### Uncertainty of AC Conducted Emission Measurement (0.15 MHz ~ 30 MHz)

Measuring Uncertainty for a Level of Confidence of 95% (U = 2Uc(y))	2.84 dB
---	---------

### Uncertainty of Radiated Emission Measurement (9 KHz ~ 30 MHz)

Measuring Uncertainty for a Level of Confidence of 95% (U = 2Uc(y))	3.30 dB
---	---------

### Uncertainty of Radiated Emission Measurement (30 MHz ~ 1000 MHz)

Measuring Uncertainty for a Level of Confidence of 95% (U = 2Uc(y))	6.18 dB
---	---------

### Uncertainty of Radiated Emission Measurement (1 GHz ~ 18 GHz)

Measuring Uncertainty for a Level of Confidence of 95% (U = 2Uc(y))	4.88 dB
---	---------

### Uncertainty of Radiated Emission Measurement (18 GHz ~ 40 GHz)

Measuring Uncertainty for a Level of Confidence of 95% (U = 2Uc(y))	5.36 dB
---	---------

----- THE END -----



## Appendix A. Conducted Test Results



Ambient Condition: <u>25</u> °C, <u>45</u> %RH
Test Date: <u>2025.7.30</u> Test Engineer: <u>Zhu Chong</u>

### Emission Bandwidth

#### Test Result

TestMode	Antenna	Freq(MHz)	26dB EBW [MHz]	FL[MHz]	FH[MHz]	Limit[MHz]	Verdict
11A	Ant1	5180	19.93	5170.04	5189.96	---	---
		5220	19.65	5210.13	5229.78	---	---
		5240	19.84	5230.13	5249.96	---	---
		5260	19.75	5250.13	5269.87	---	---
		5300	20.11	5289.76	5309.87	---	---
		5320	19.93	5310.13	5330.05	---	---
		5500	20.02	5490.04	5510.05	---	---
		5580	19.65	5570.22	5589.87	---	---
		5700	20.02	5690.04	5710.05	---	---
		5720	19.93	5710.04	5729.96	---	---
		5745	19.93	5735.13	5755.05	---	---
5785	19.93	5775.04	5794.96	---	---		
5825	19.84	5815.13	5834.96	---	---		
11AC20SISO	Ant1	5180	20.02	5170.04	5190.05	---	---
		5220	20.20	5209.95	5230.15	---	---
		5240	20.02	5229.95	5249.96	---	---
		5260	20.38	5249.95	5270.33	---	---
		5300	20.02	5290.04	5310.05	---	---
		5320	20.20	5309.95	5330.15	---	---
		5500	20.47	5489.85	5510.33	---	---
		5580	20.38	5569.85	5590.24	---	---
		5700	20.02	5690.13	5710.15	---	---
		5720	20.20	5709.95	5730.15	---	---
		5745	20.20	5735.04	5755.24	---	---
5785	20.38	5774.76	5795.15	---	---		
5825	20.20	5814.95	5835.15	---	---		
11AC40SISO	Ant1	5190	40.95	5169.71	5210.66	---	---
		5230	40.40	5209.89	5250.29	---	---
		5270	40.58	5249.89	5290.47	---	---
		5310	40.22	5289.89	5330.11	---	---
		5510	40.58	5489.89	5530.47	---	---
		5550	40.40	5529.89	5570.29	---	---
		5670	40.40	5649.89	5690.29	---	---
		5710	40.22	5690.07	5730.29	---	---
		5755	40.76	5734.89	5775.66	---	---
5795	40.58	5774.89	5815.47	---	---		
11AC80SISO	Ant1	5210	80.80	5169.78	5250.58	---	---
		5290	80.44	5249.78	5330.22	---	---
		5530	80.80	5489.78	5570.58	---	---
		5610	81.16	5569.42	5650.58	---	---
		5690	81.16	5649.78	5730.95	---	---
		5775	80.44	5735.15	5815.58	---	---



Test Graphs

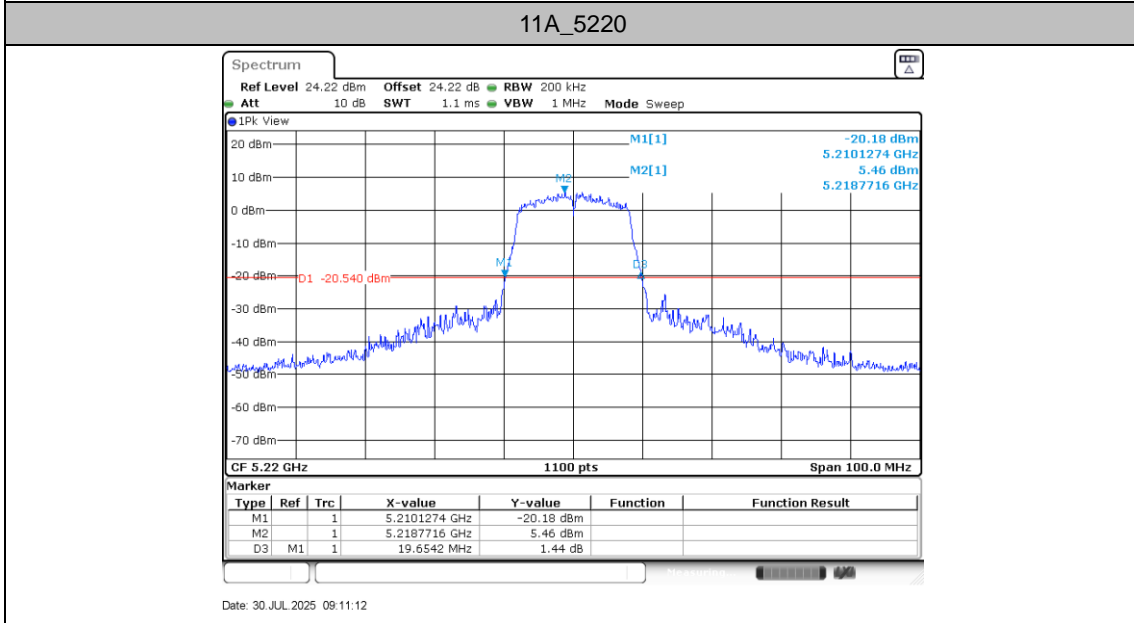
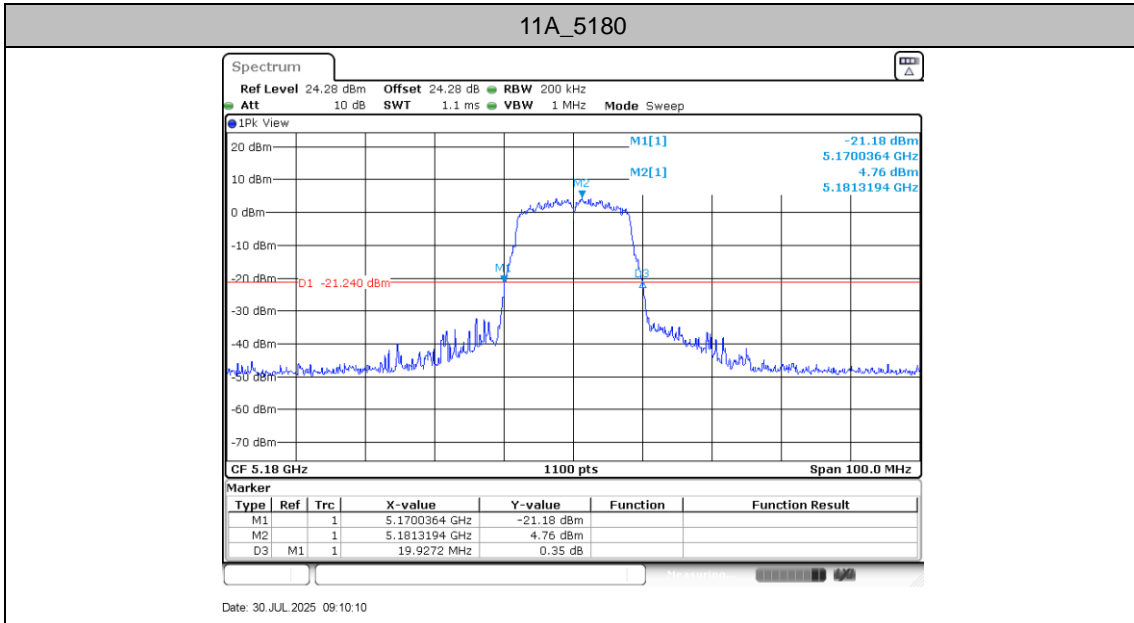



11A\_5240

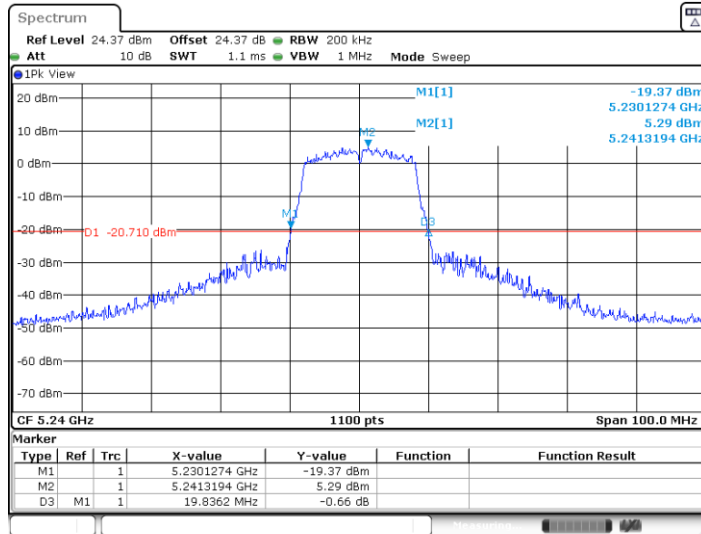

11A\_5260

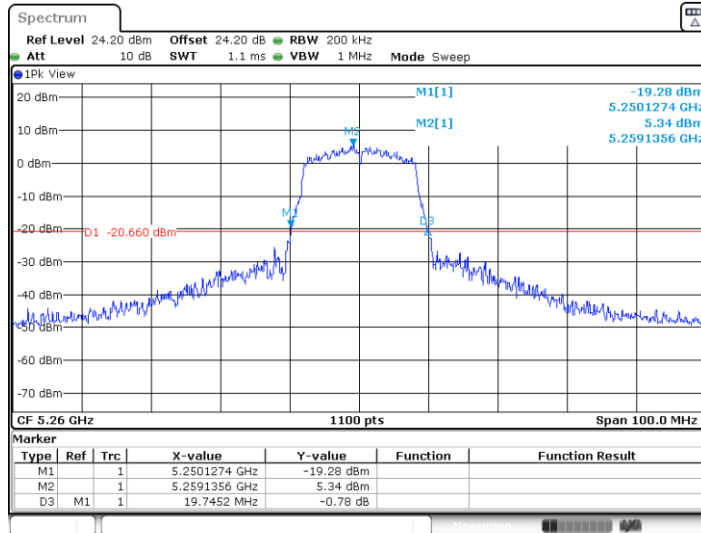



11A\_5300

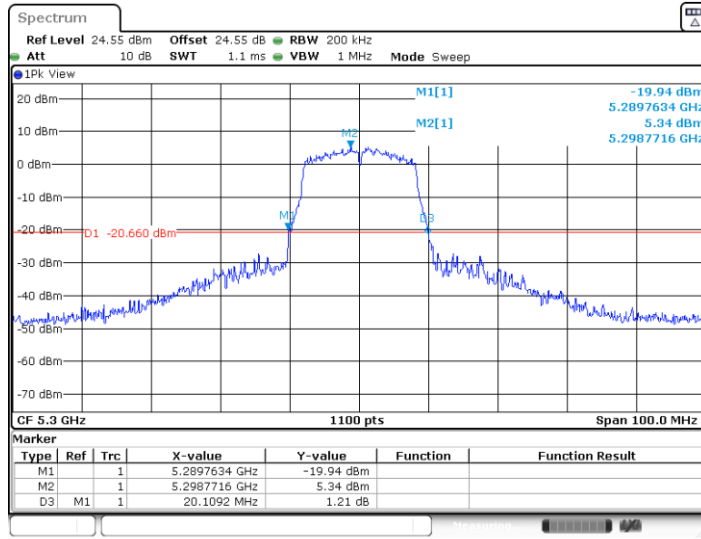

11A\_5320

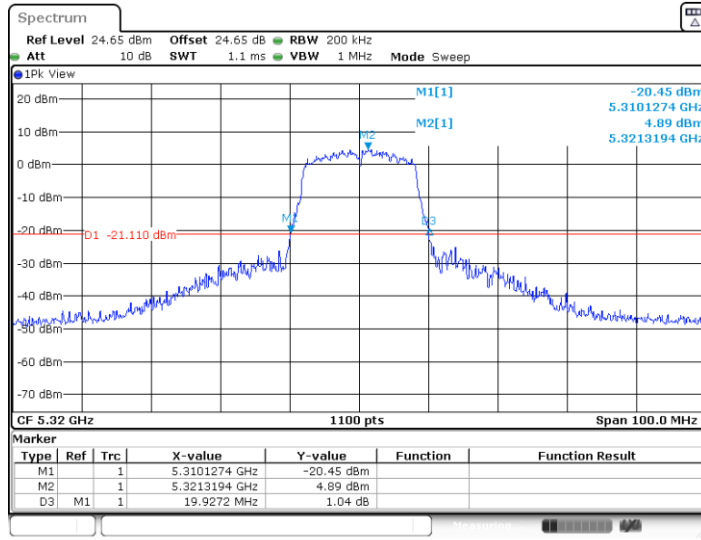

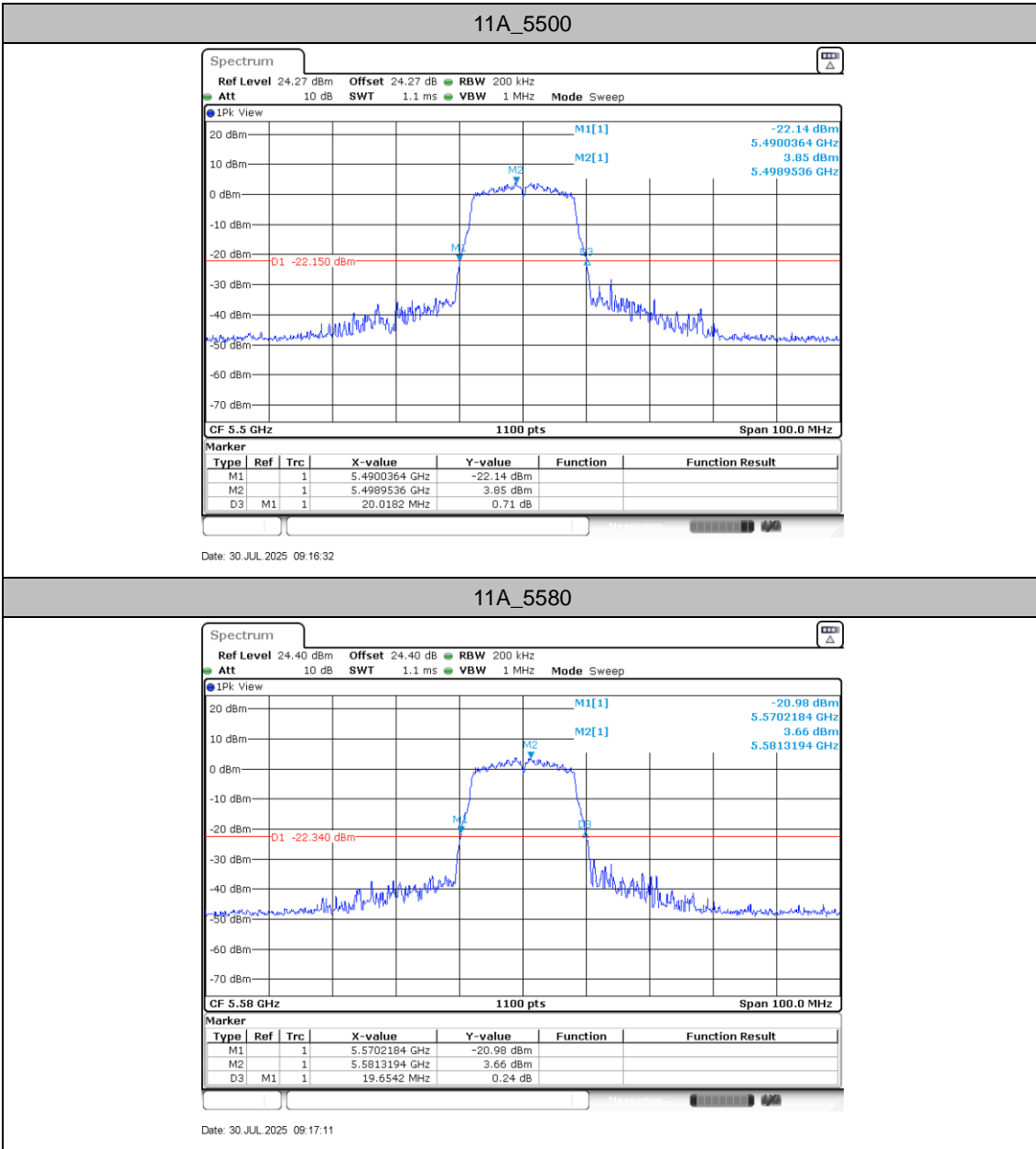



11A\_5700

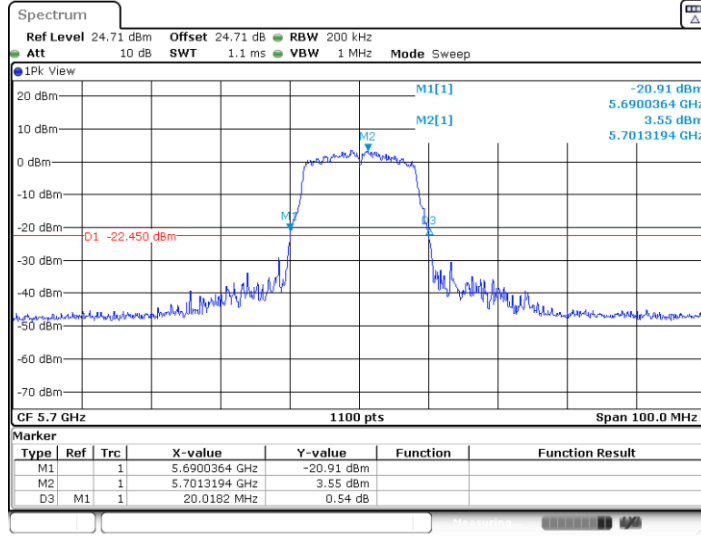

Date: 30 JUL 2025 09:17:59

11A\_5720

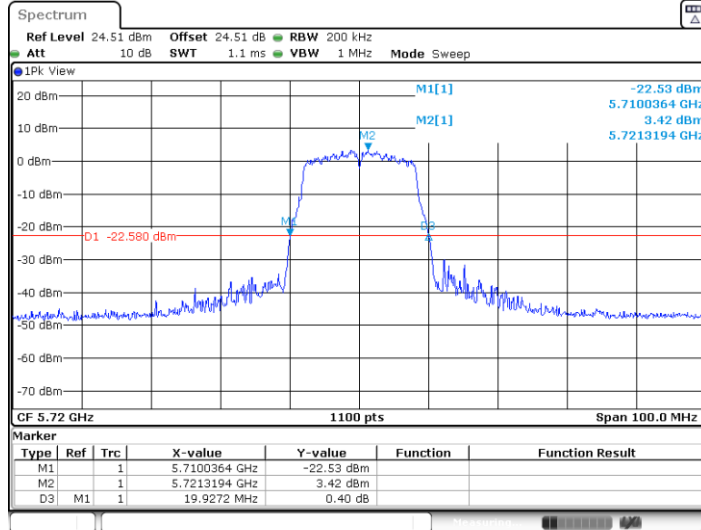

Date: 30 JUL 2025 09:18:42



11A\_5745

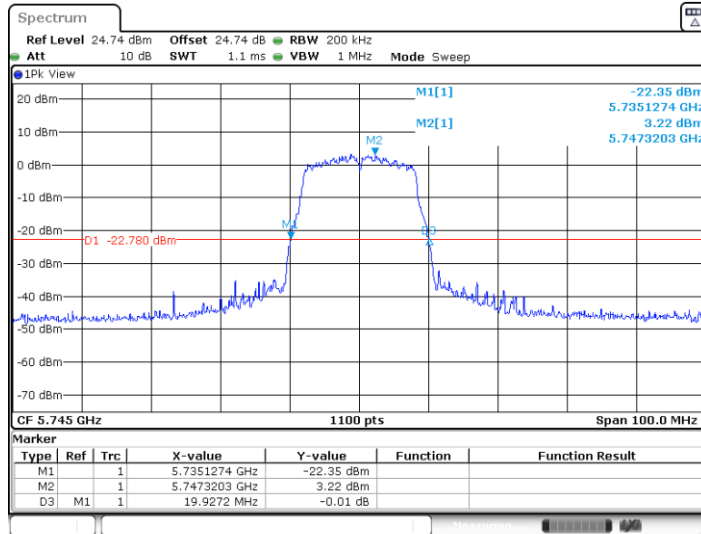

Date: 30 JUL 2025 09:19:40

11A\_5785

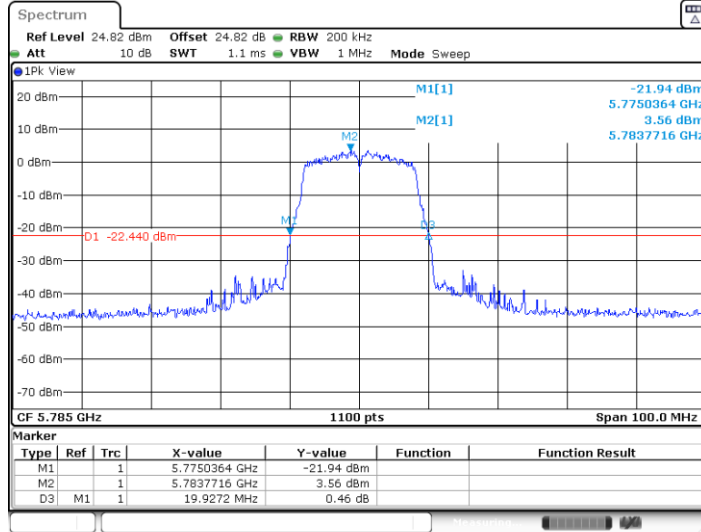

Date: 30 JUL 2025 09:20:35

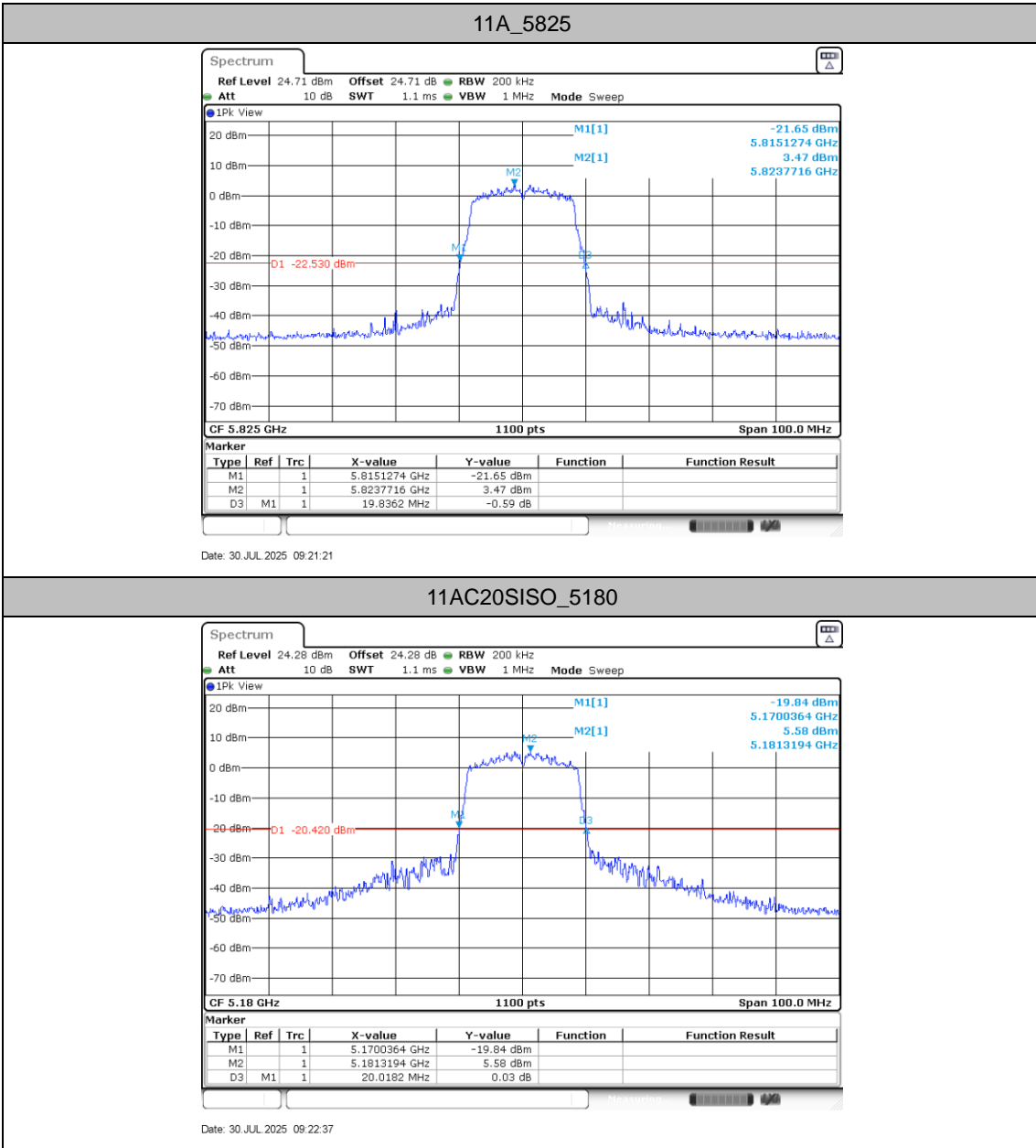

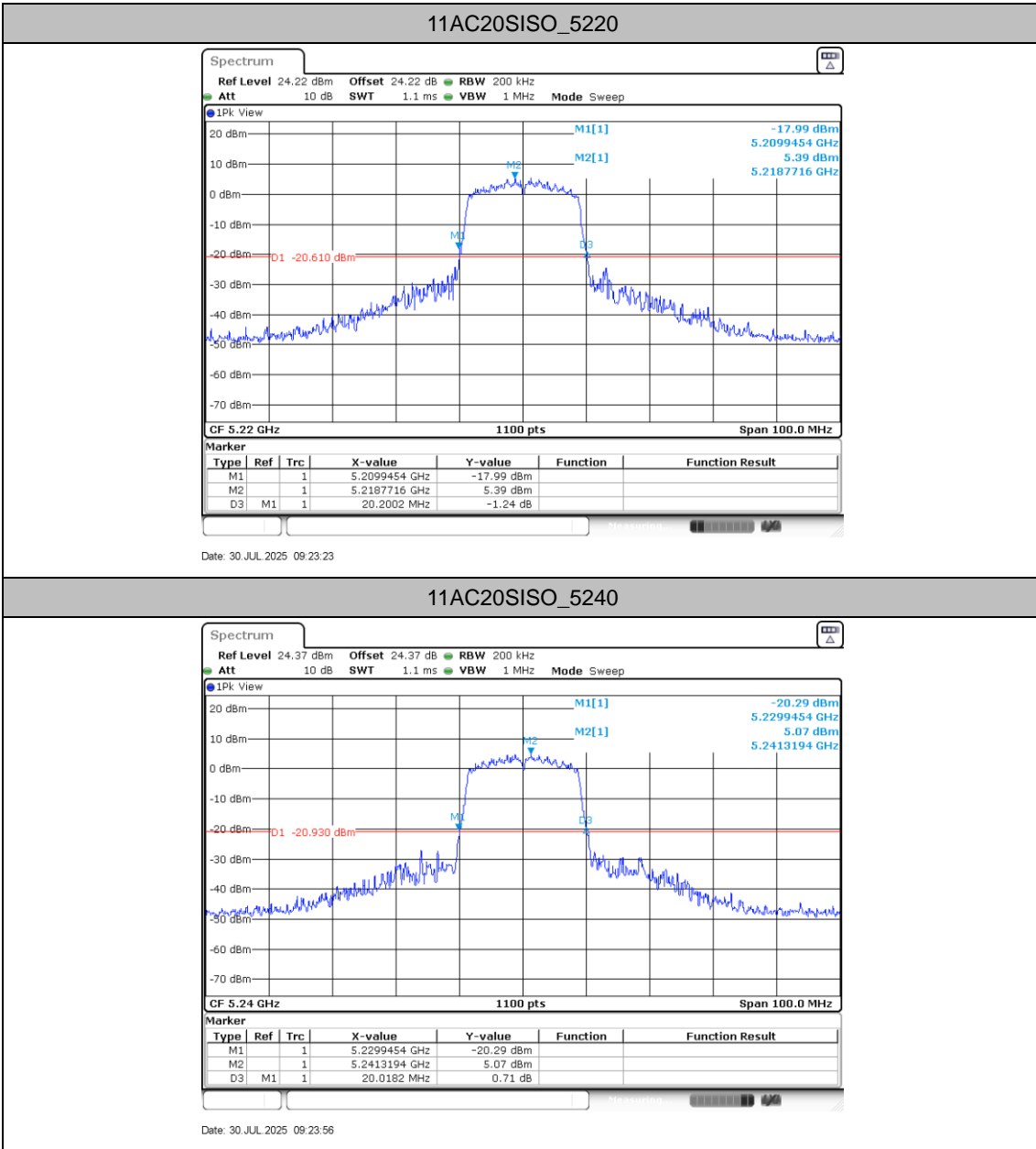



11AC20SISO\_5260

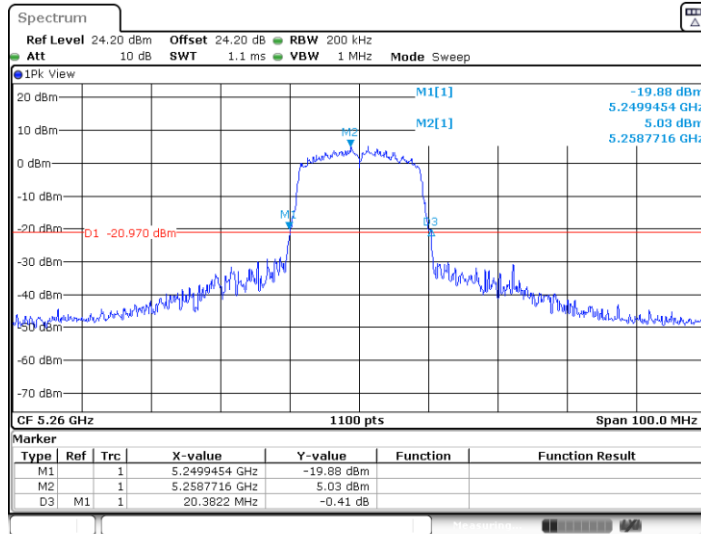

Date: 30 JUL 2025 09:24:33

11AC20SISO\_5300

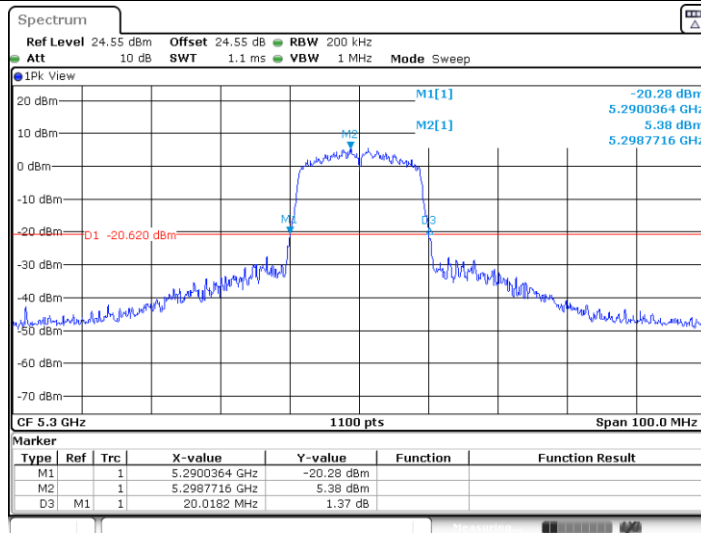

Date: 30 JUL 2025 09:25:15



11AC20SISO\_5320

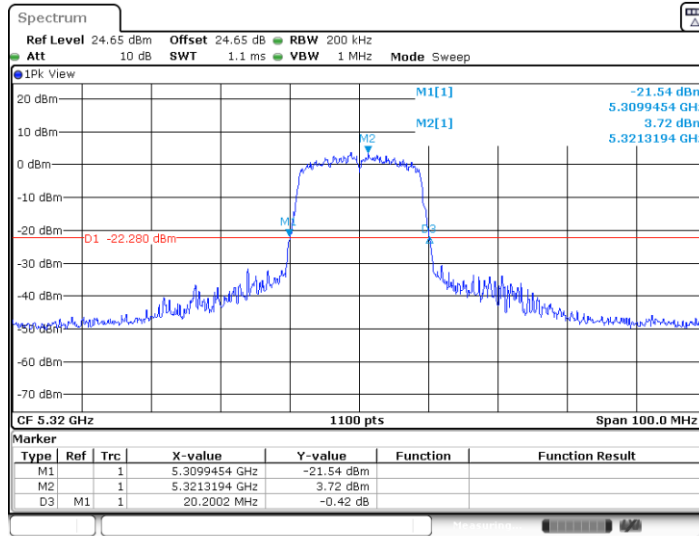

11AC20SISO\_5500

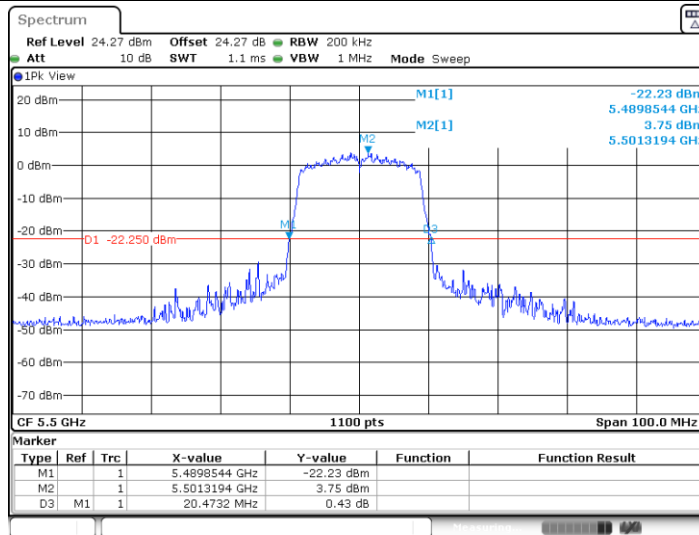

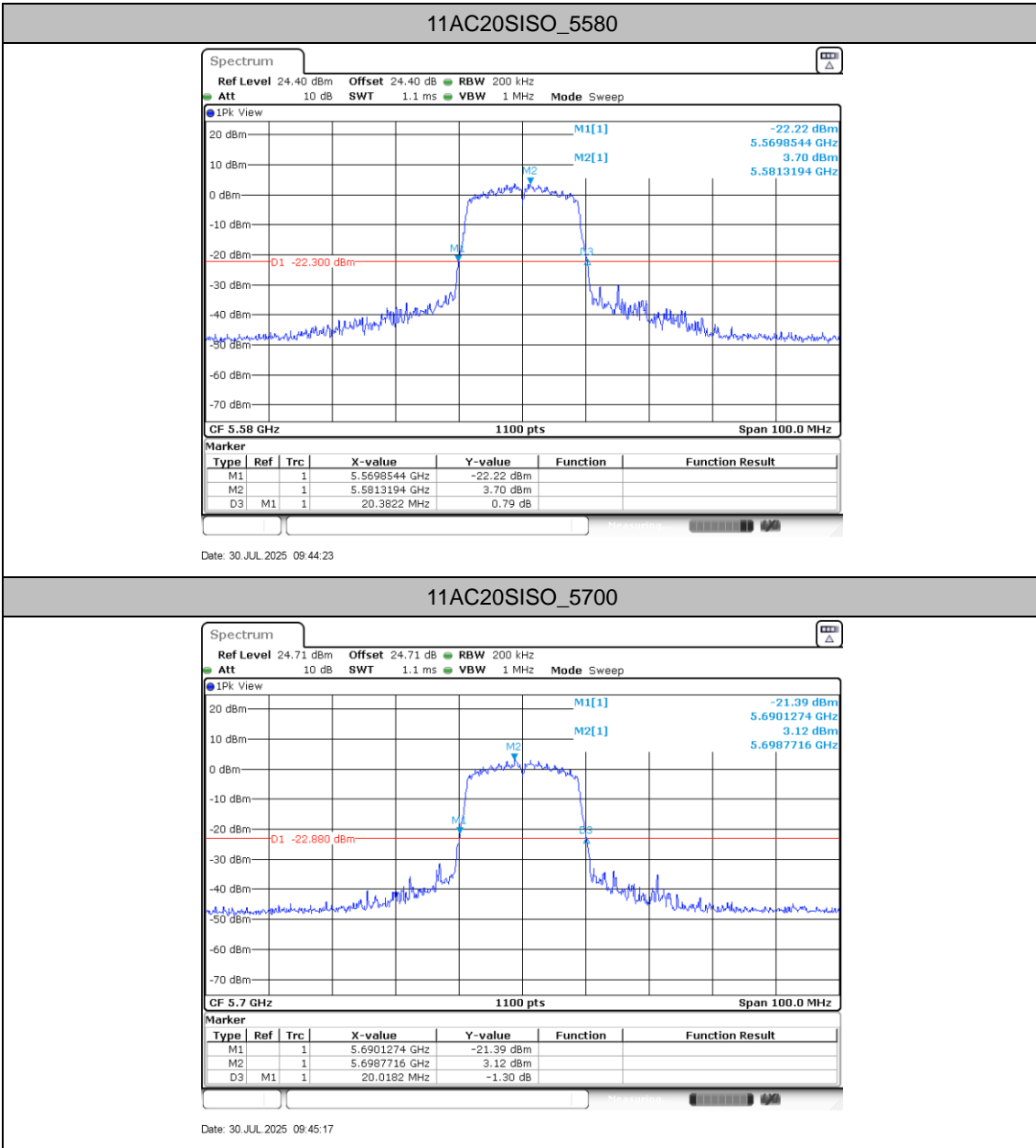





11AC20SISO\_5785

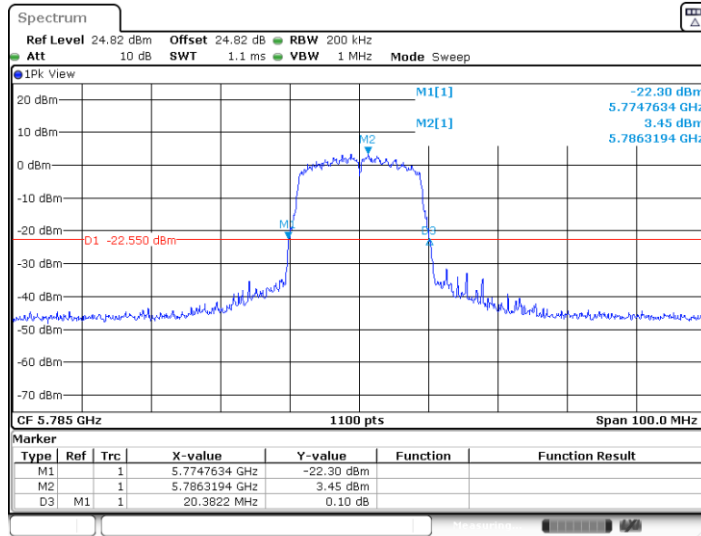

Date: 30 JUL 2025 09:47:29

11AC20SISO\_5825

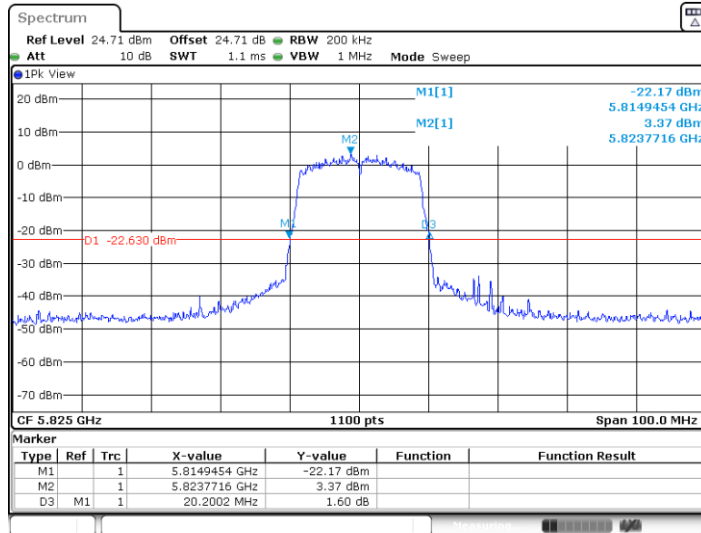

Date: 30 JUL 2025 09:48:09



11AC40SISO\_5190

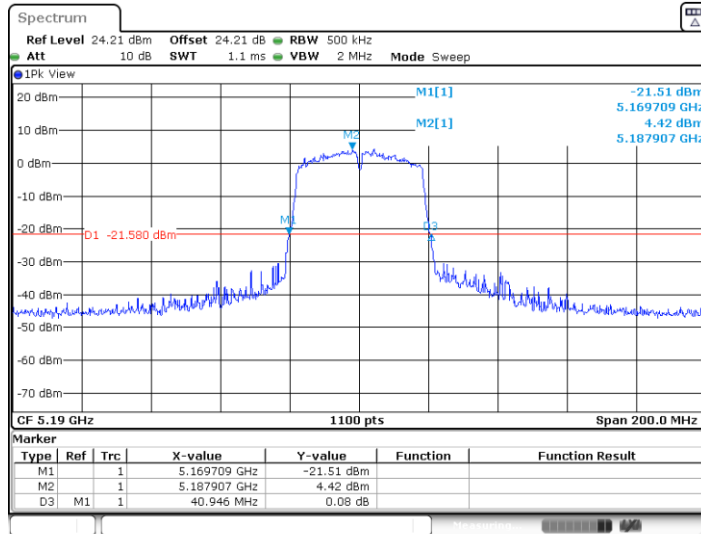

Date: 30 JUL 2025 09:49:09

11AC40SISO\_5230

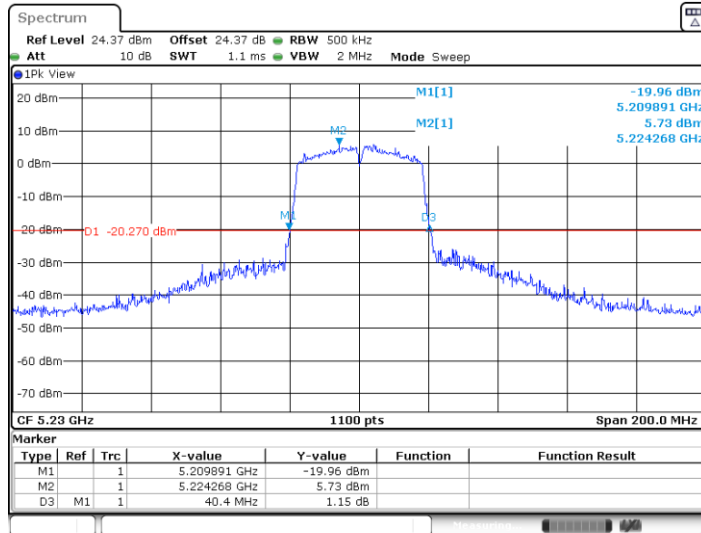

Date: 30 JUL 2025 09:50:11



11AC40SISO\_5270

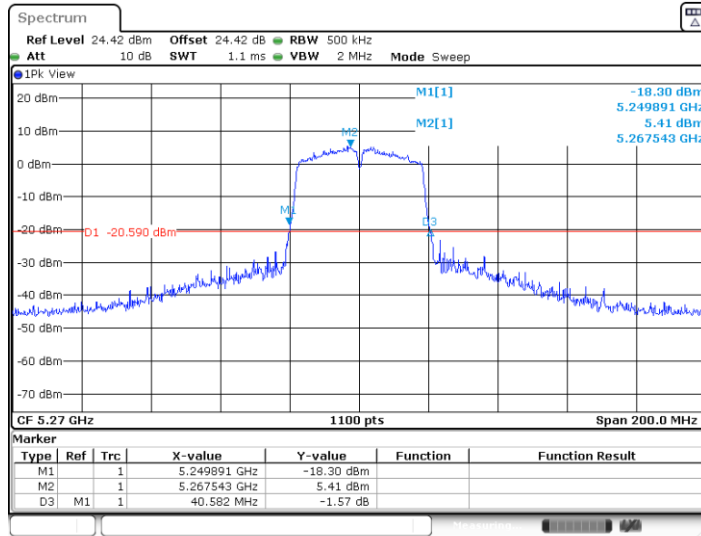

Date: 30 JUL 2025 09:51:46

11AC40SISO\_5310

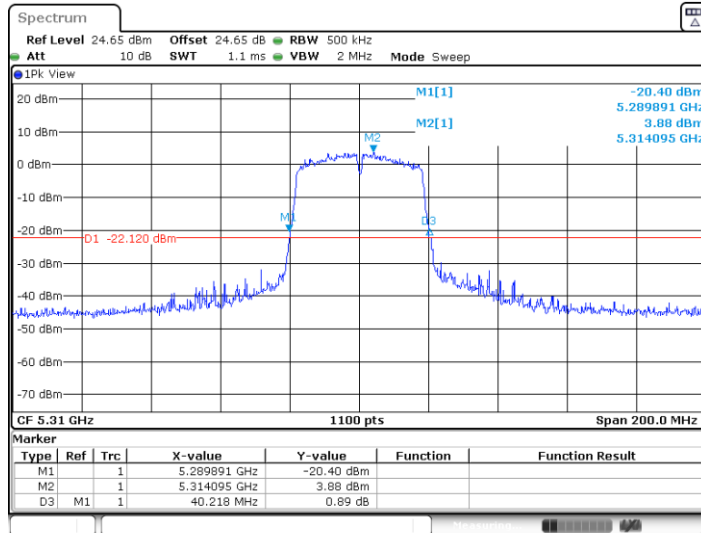

Date: 30 JUL 2025 09:52:22





11AC40SISO\_5670

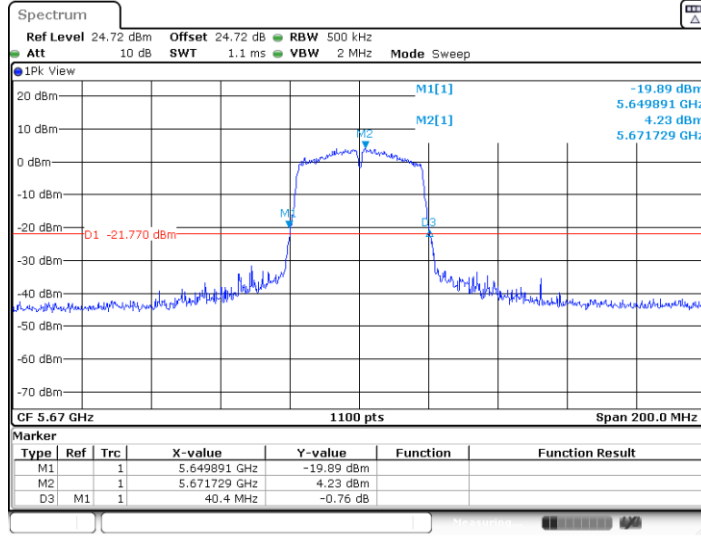

11AC40SISO\_5710

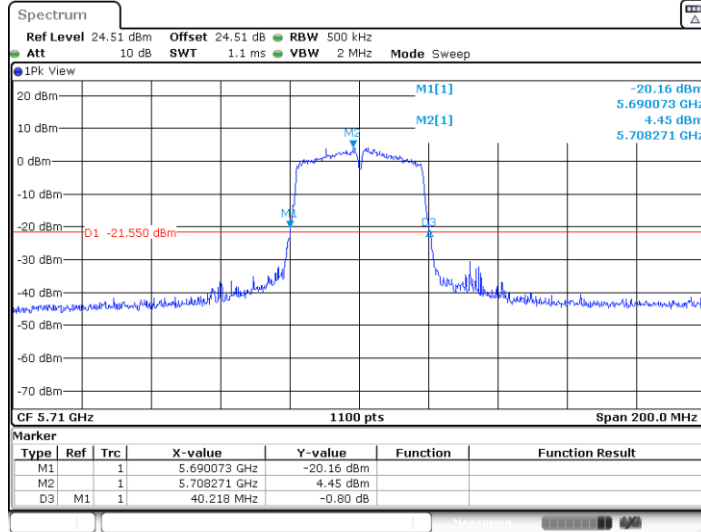



11AC40SISO\_5755

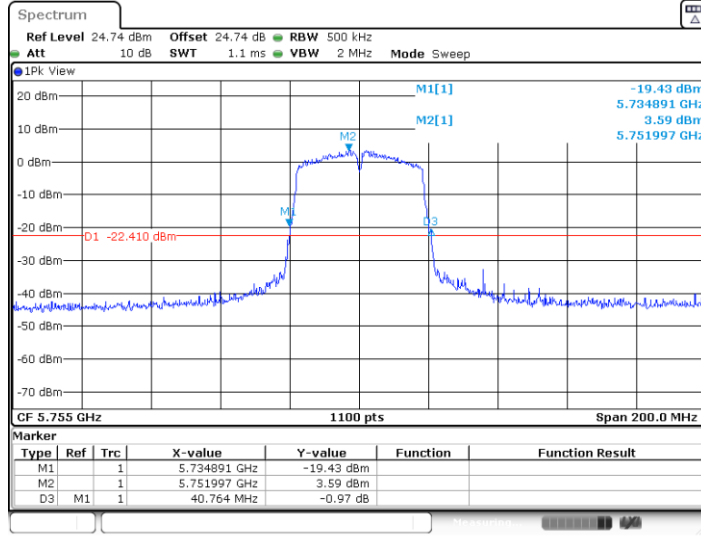

Date: 30 JUL 2025 09:56:07

11AC40SISO\_5795

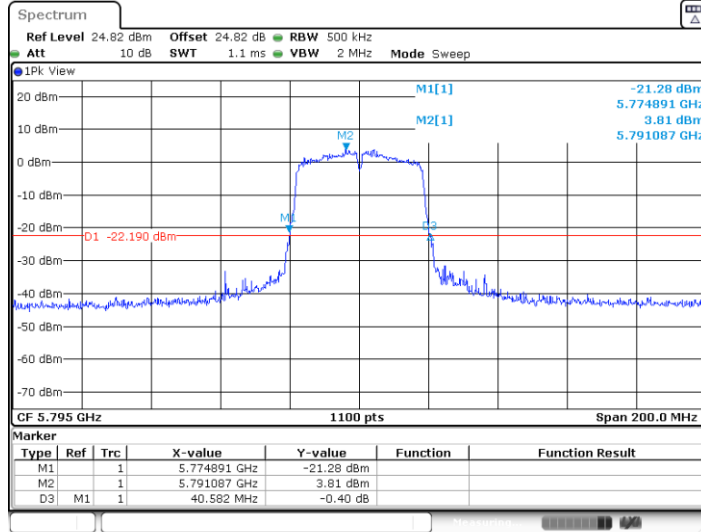

Date: 30 JUL 2025 09:56:53



11AC80SISO\_5210

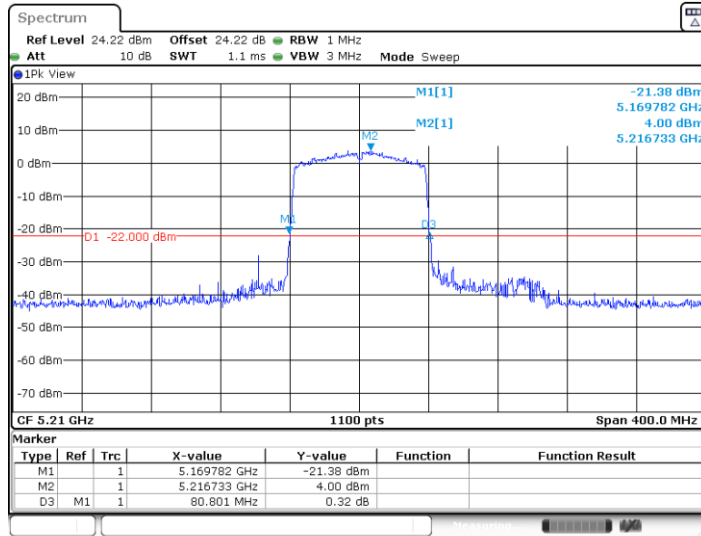

Date: 30 JUL 2025 09:57:44

11AC80SISO\_5290

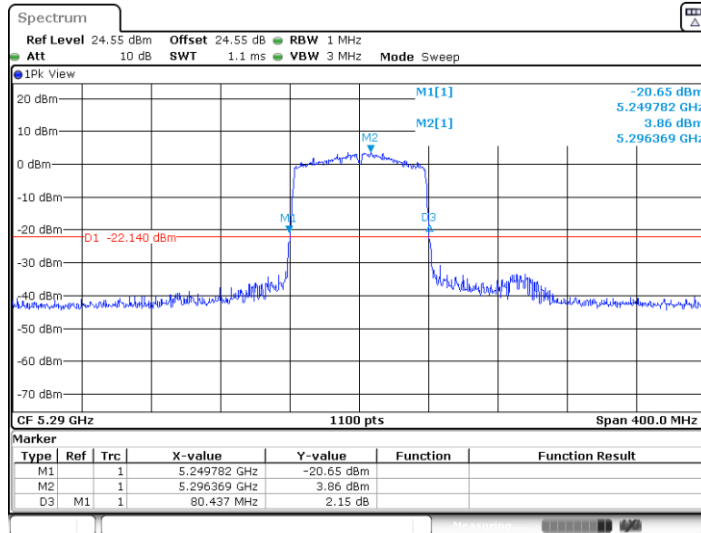

Date: 30 JUL 2025 09:58:40



11AC80SISO\_5530

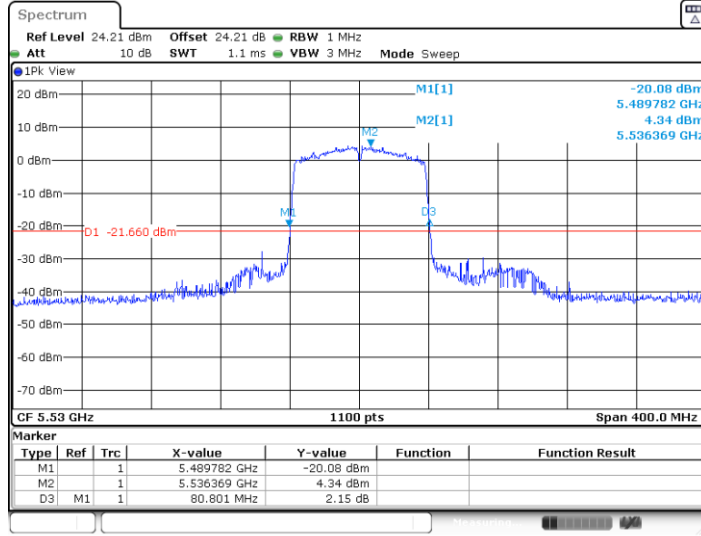

Date: 30 JUL 2025 09:59:27

11AC80SISO\_5610

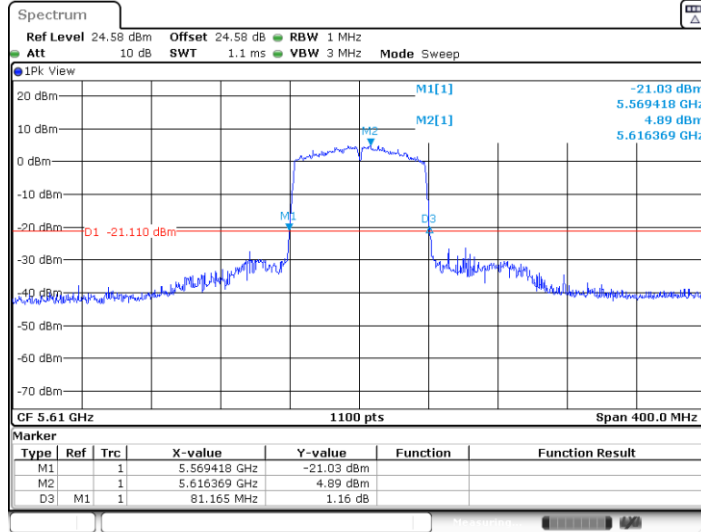

Date: 30 JUL 2025 10:00:06

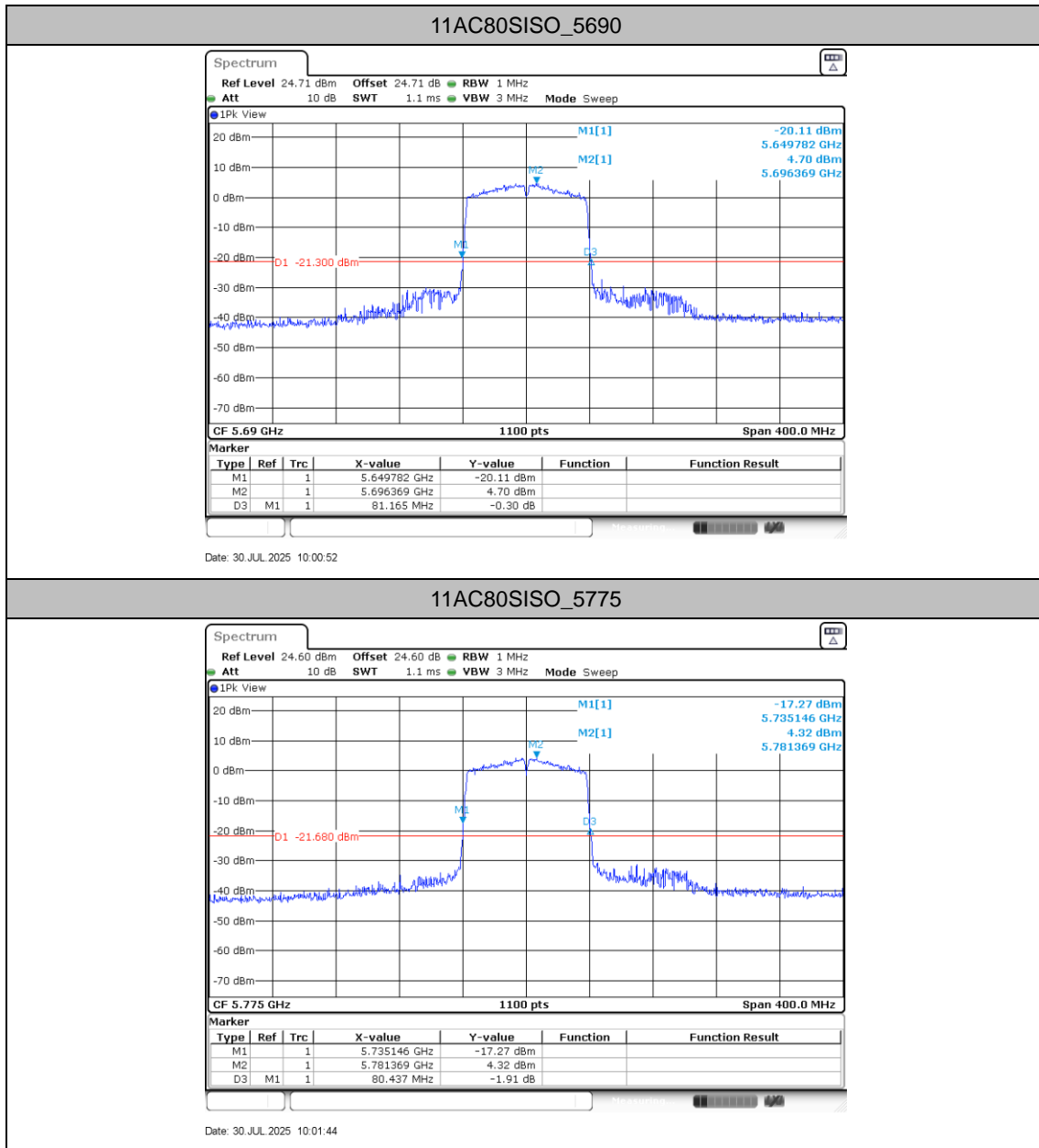



### Occupied channel bandwidth

#### Test Result

TestMode	Antenna	Freq(MHz)	OCB [MHz]	FL[MHz]	FH[MHz]	Limit[MHz]	Verdict
11A	Ant1	5180	16.982	5171.5455	5188.5273	---	---
		5220	17.127	5211.4364	5228.5636	---	---
		5240	17.127	5231.4727	5248.6000	---	---
		5260	17.127	5251.4364	5268.5636	---	---
		5300	17.164	5291.4000	5308.5636	---	---
		5320	17.2	5311.4000	5328.6000	---	---
		5500	17.127	5491.4364	5508.5636	---	---
		5580	17.127	5571.4364	5588.5636	---	---
		5700	17.055	5691.4727	5708.5273	---	---
		5720	17.055	5711.4727	5728.5273	---	---
		5745	17.055	5736.4364	5753.4909	---	---
		5785	17.018	5776.4727	5793.4909	---	---
		5825	17.091	5816.4727	5833.5636	---	---
		11AC20SISO	Ant1	5180	18	5171.0364	5189.0364
5220	17.964			5211.0364	5229.0000	---	---
5240	18.036			5231.0000	5249.0364	---	---
5260	18			5250.9636	5268.9636	---	---
5300	18			5291.0000	5309.0000	---	---
5320	18.036			5311.0000	5329.0364	---	---
5500	18.036			5491.0000	5509.0364	---	---
5580	17.927			5571.0364	5588.9636	---	---
5700	17.927			5691.0364	5708.9636	---	---
5720	18			5711.0364	5729.0364	---	---
5745	17.964			5736.0000	5753.9636	---	---
5785	17.927			5776.0364	5793.9636	---	---
5825	18	5816.0000	5834.0000	---	---		
11AC40SISO	Ant1	5190	36.073	5172.0000	5208.0727	---	---
		5230	36.218	5211.9273	5248.1455	---	---
		5270	36.145	5251.9273	5288.0727	---	---
		5310	36.145	5291.9273	5328.0727	---	---
		5510	36.218	5491.9273	5528.1455	---	---
		5550	36.145	5531.9273	5568.0727	---	---
		5670	36.145	5651.9273	5688.0727	---	---
		5710	36.218	5691.9273	5728.1455	---	---
		5755	36.145	5736.9273	5773.0727	---	---
		5795	36.218	5776.8545	5813.0727	---	---
11AC80SISO	Ant1	5210	75.491	5172.2545	5247.7455	---	---
		5290	75.636	5252.2545	5327.8909	---	---
		5530	75.345	5492.2545	5567.6000	---	---
		5610	75.345	5572.2545	5647.6000	---	---
		5690	75.345	5652.2545	5727.6000	---	---
		5775	75.491	5737.2545	5812.7455	---	---



Test Graphs

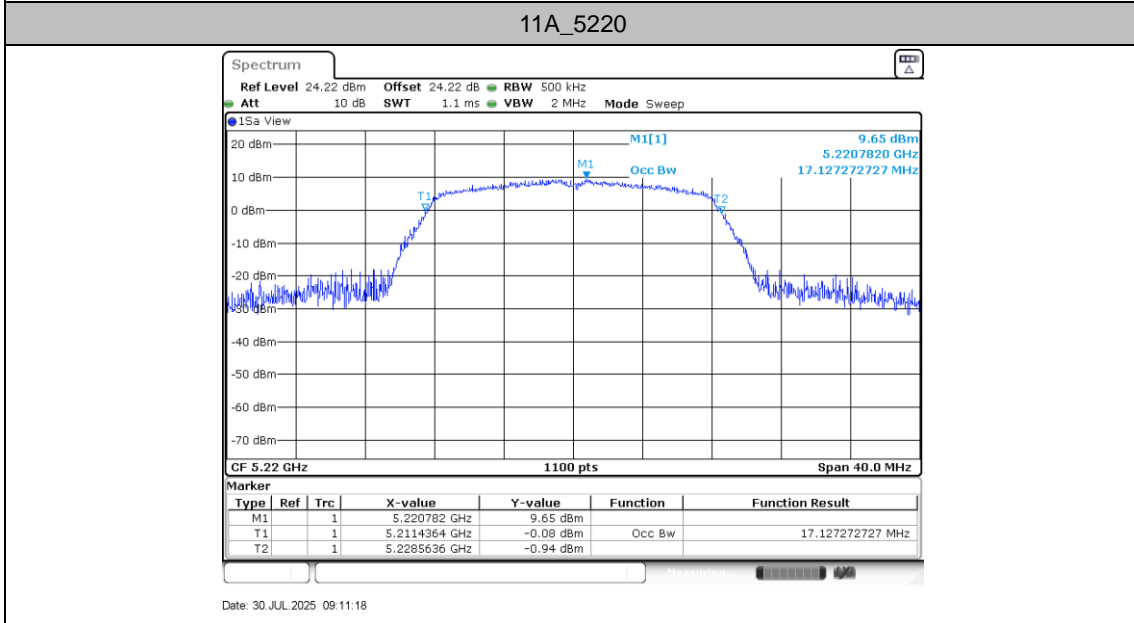
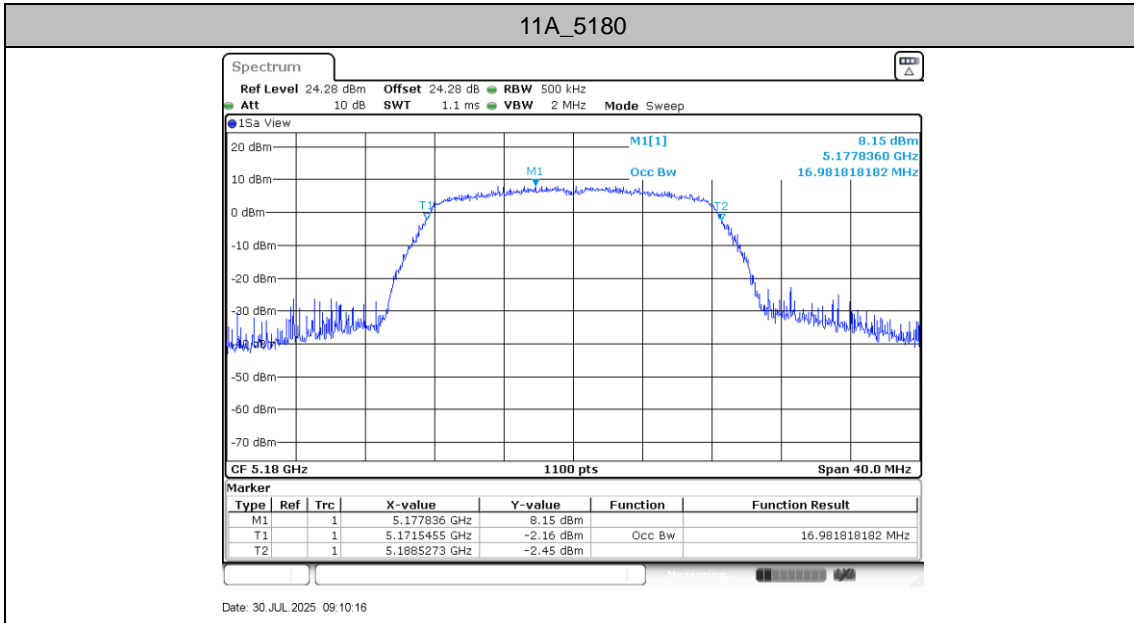



11A\_5240

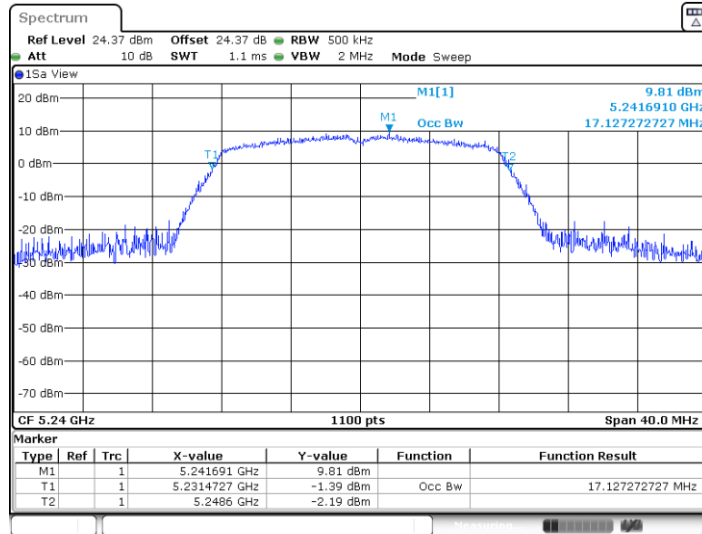

Date: 30 JUL 2025 09:12:16

11A\_5260

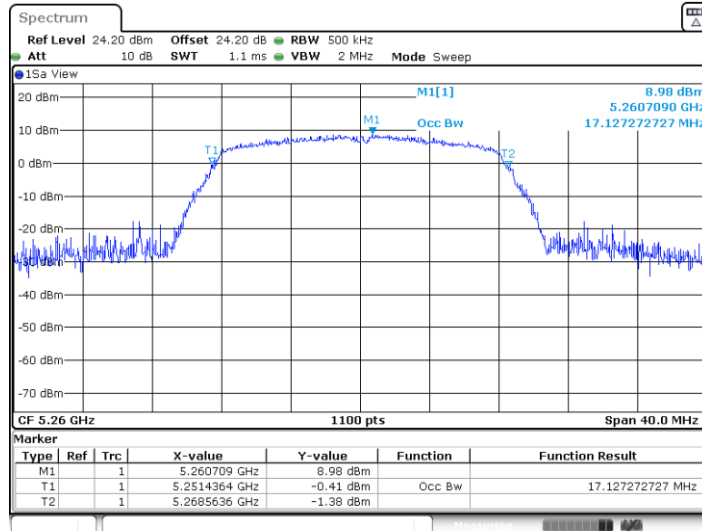

Date: 30 JUL 2025 09:14:10

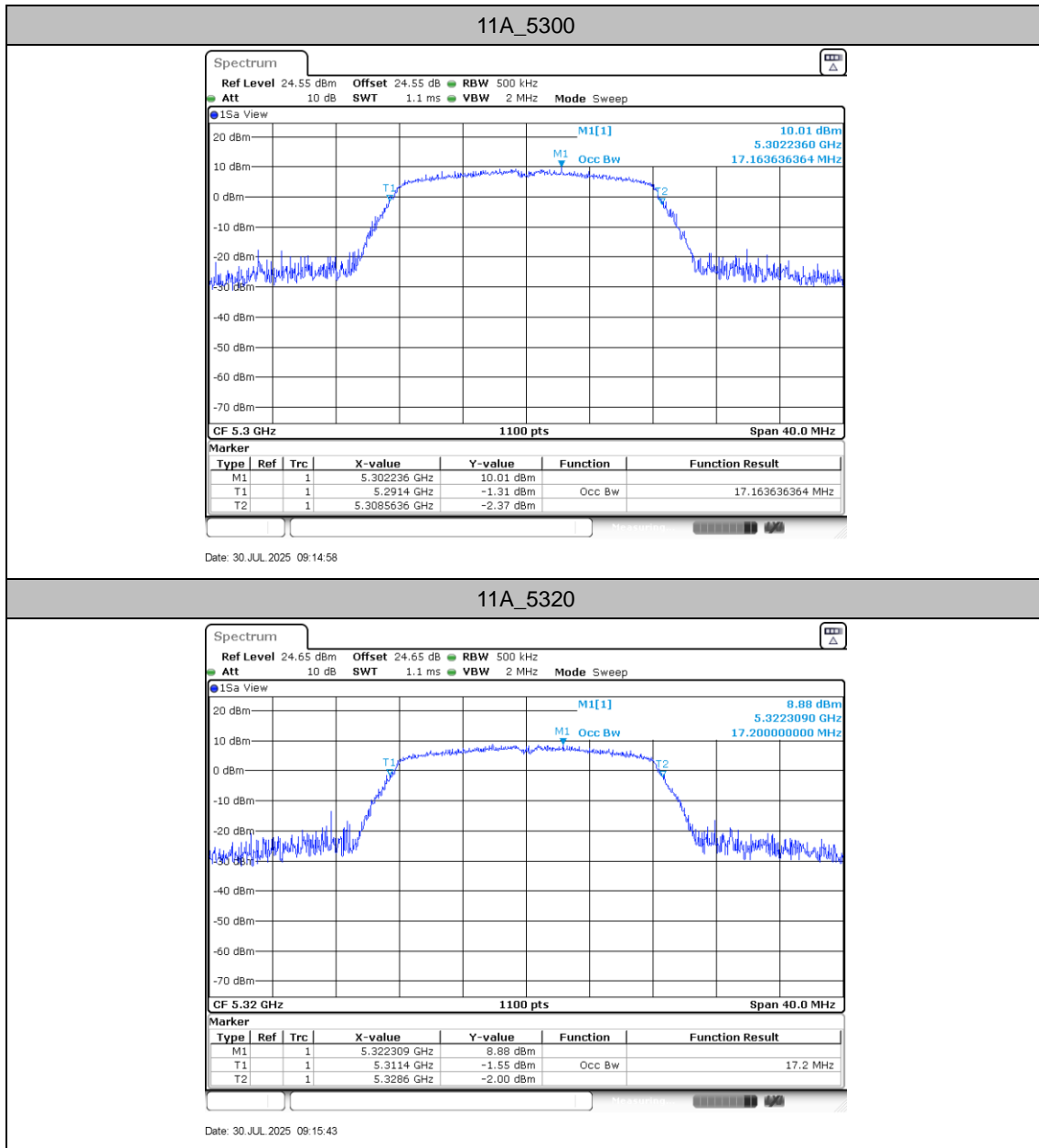

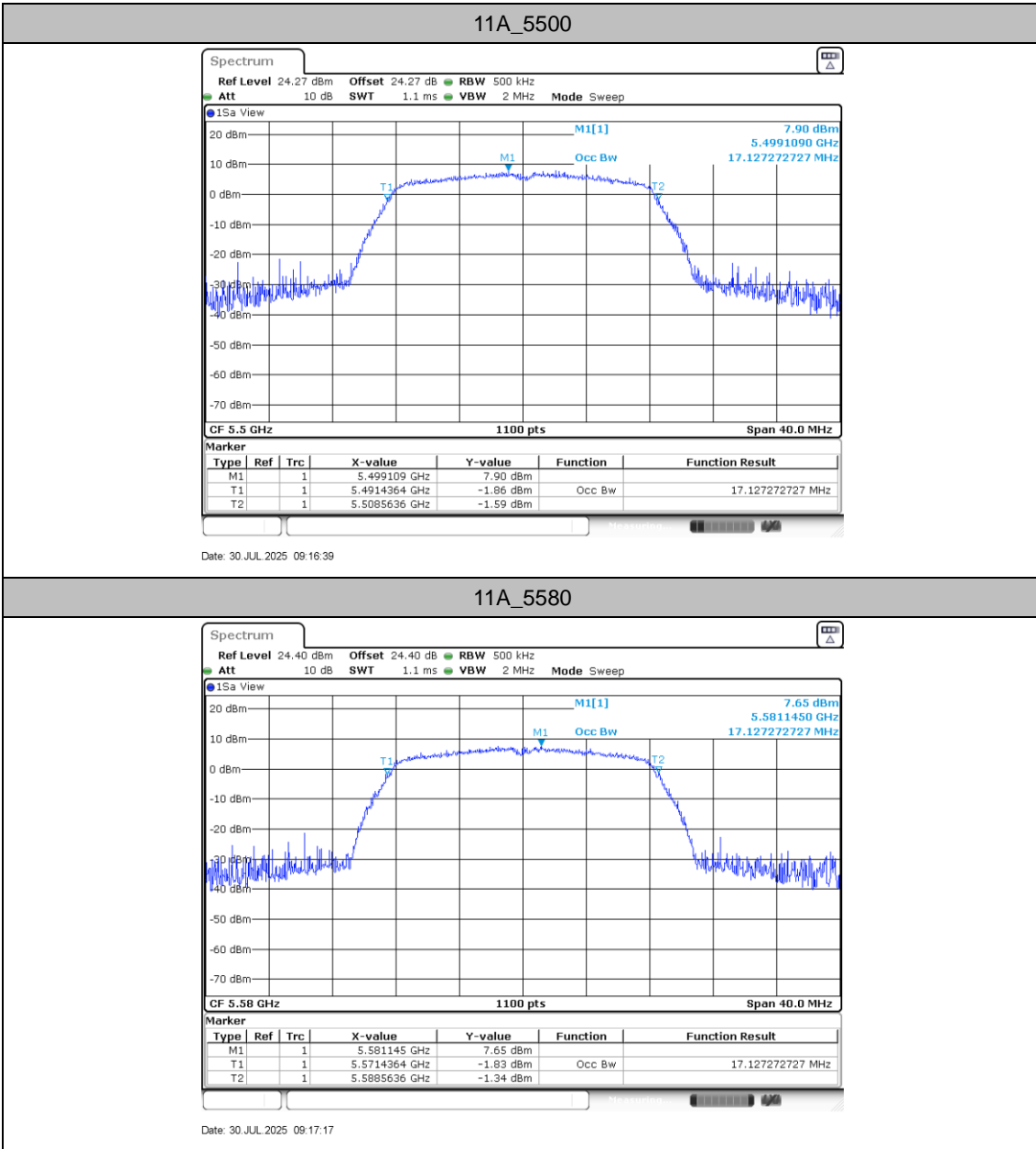
**11A\_5320**

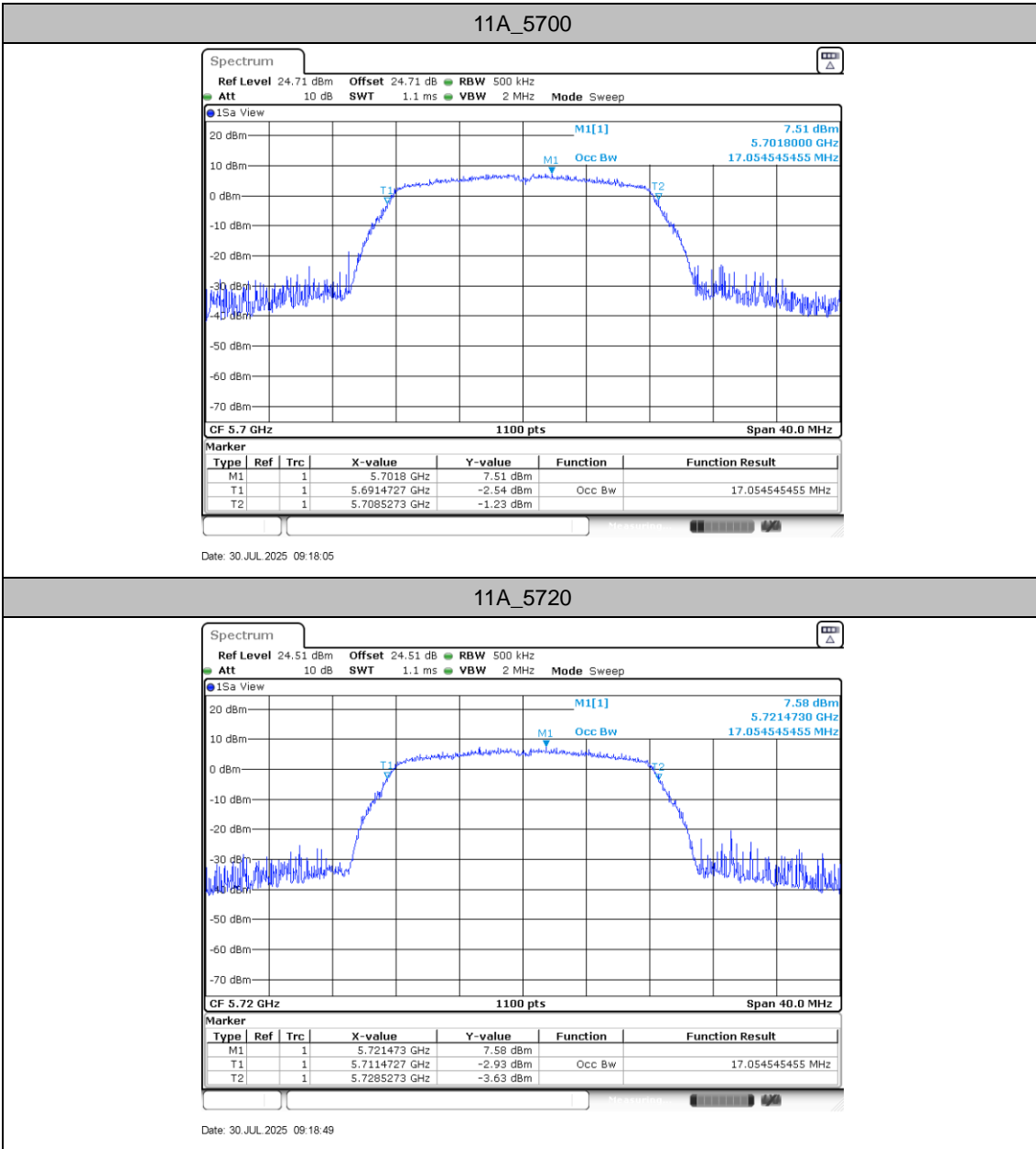

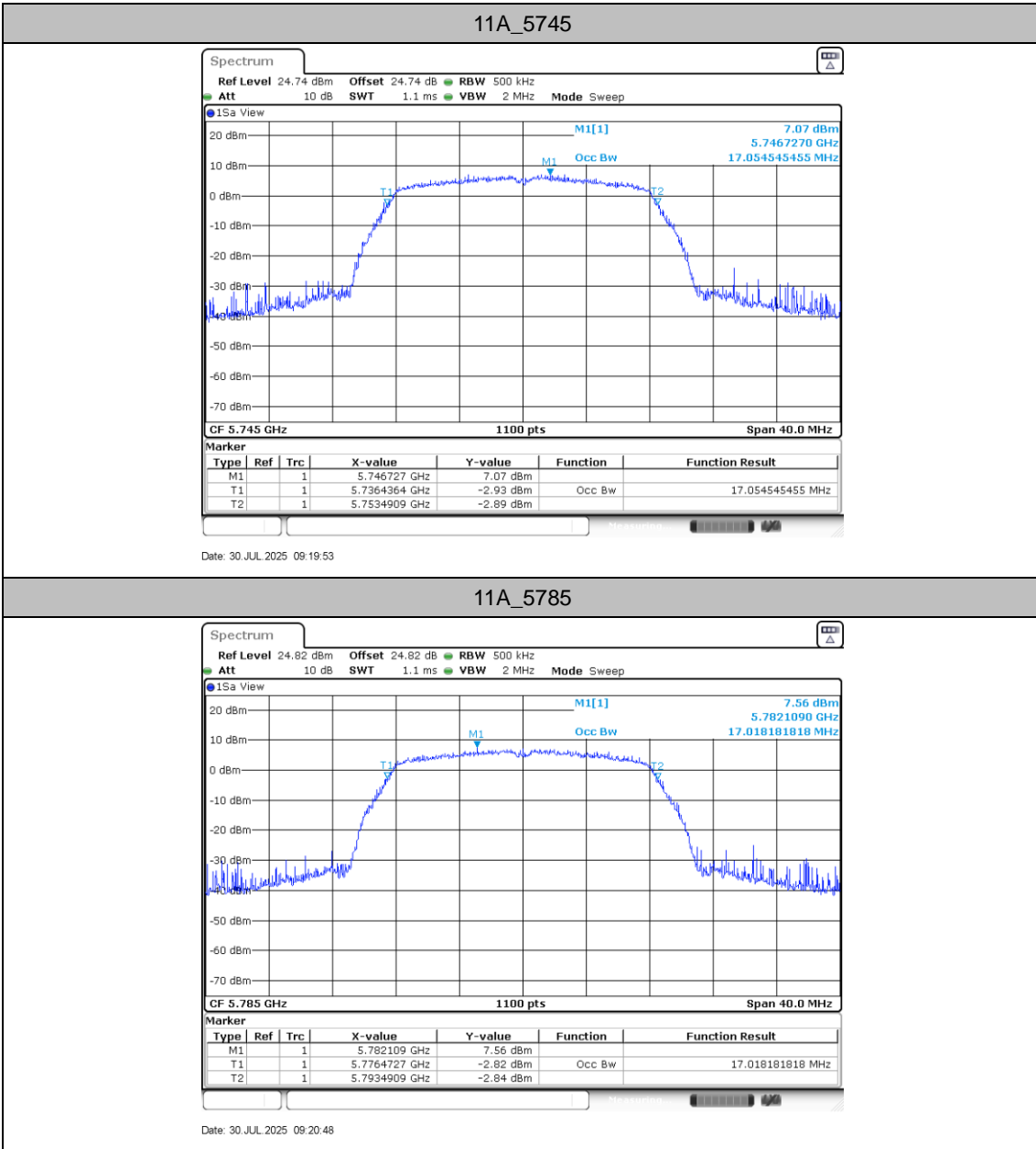

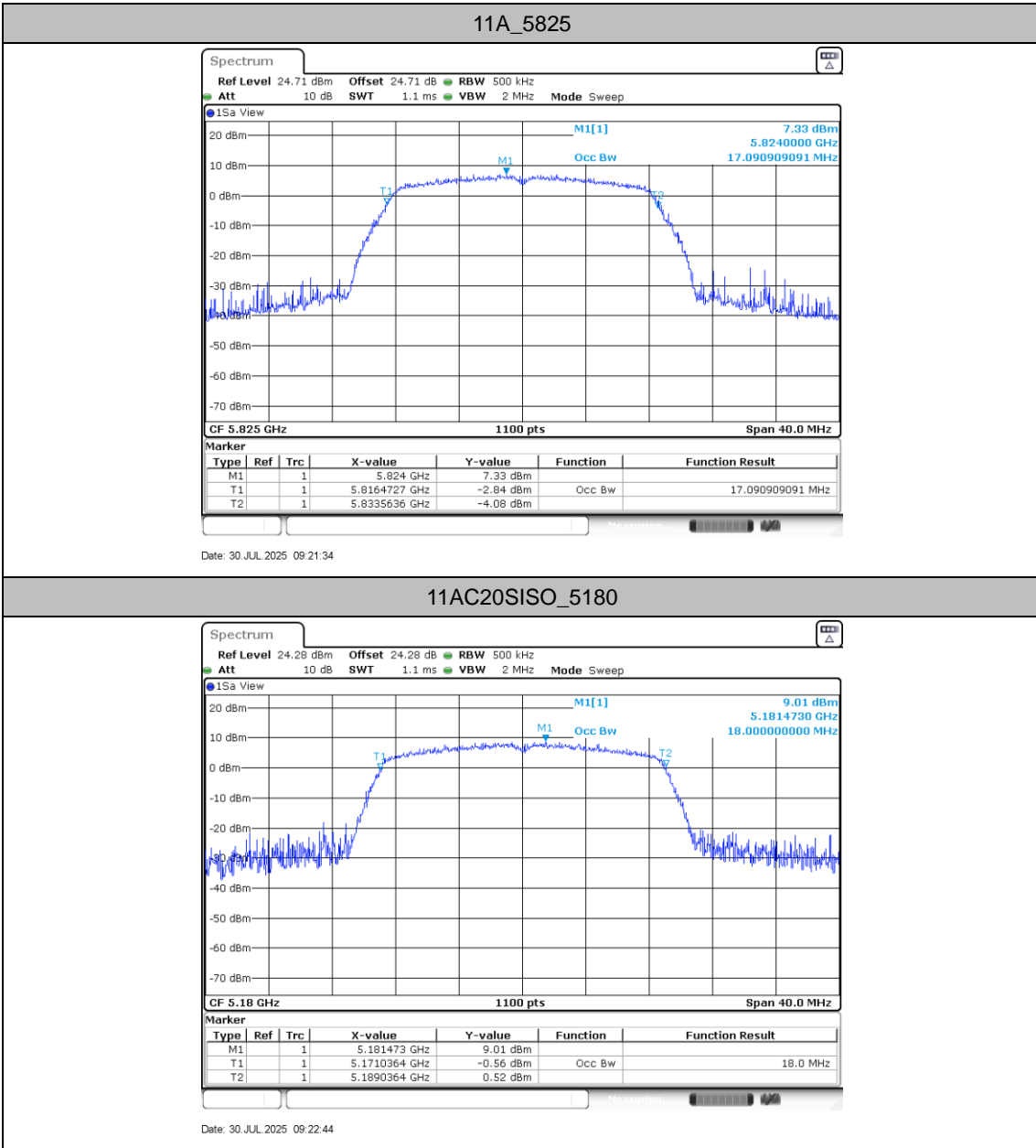

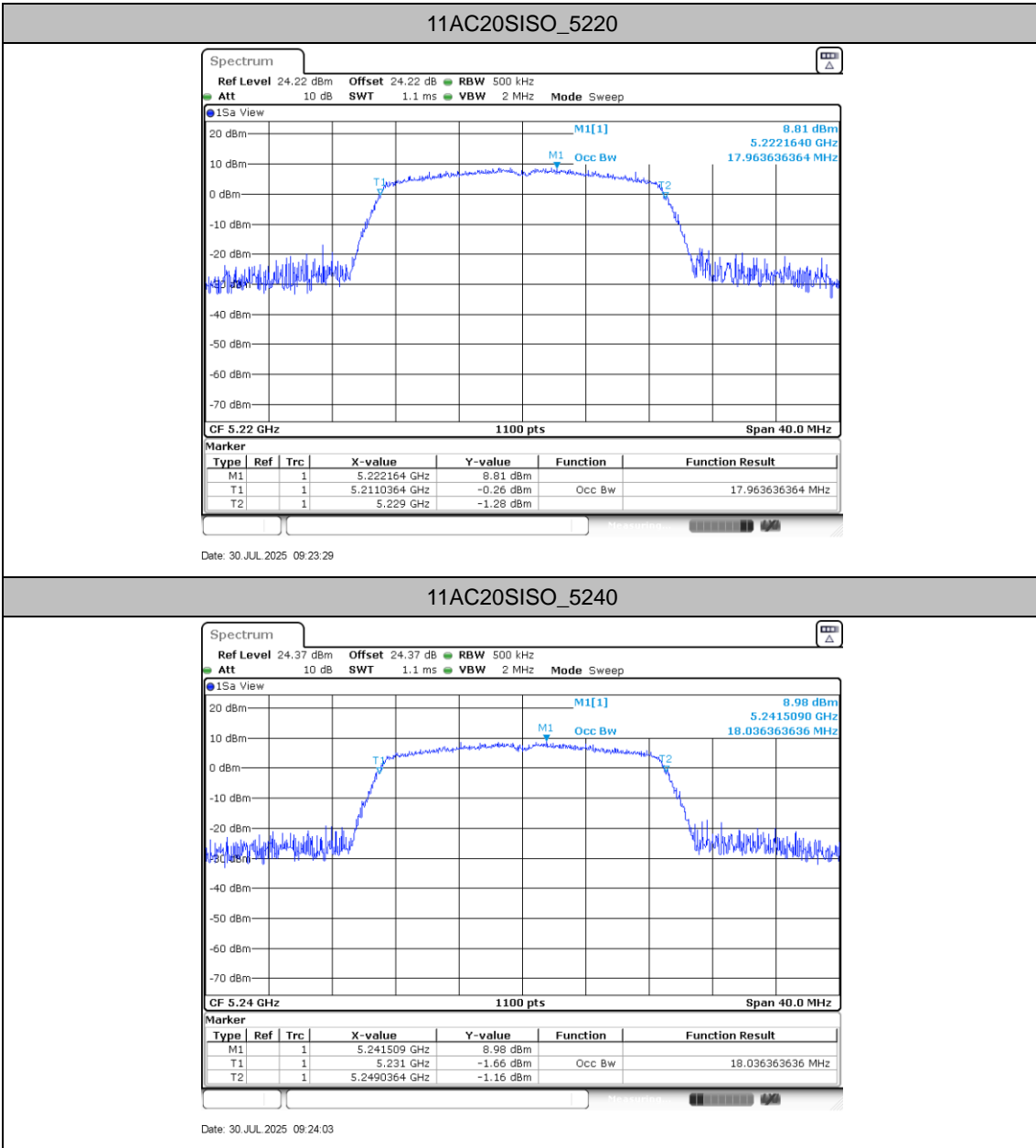





11AC20SISO\_5260

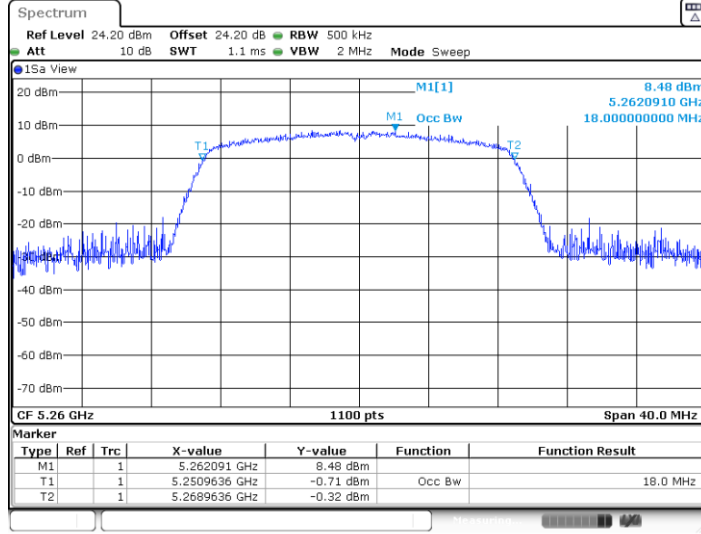

Date: 30 JUL 2025 09:24:39

11AC20SISO\_5300

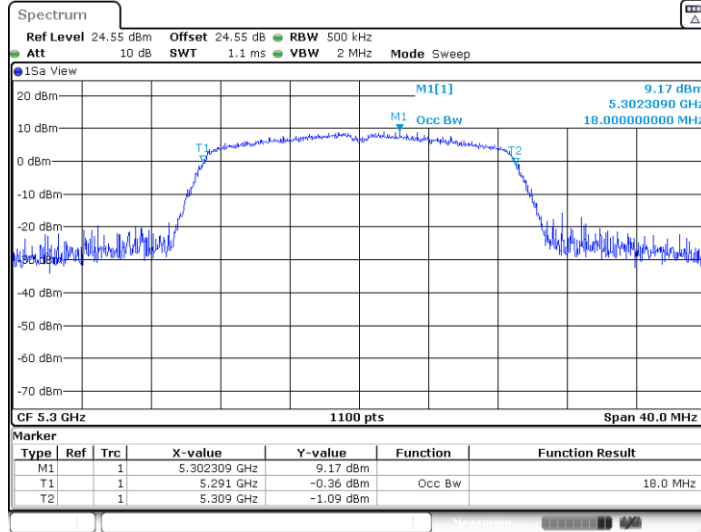

Date: 30 JUL 2025 09:25:21

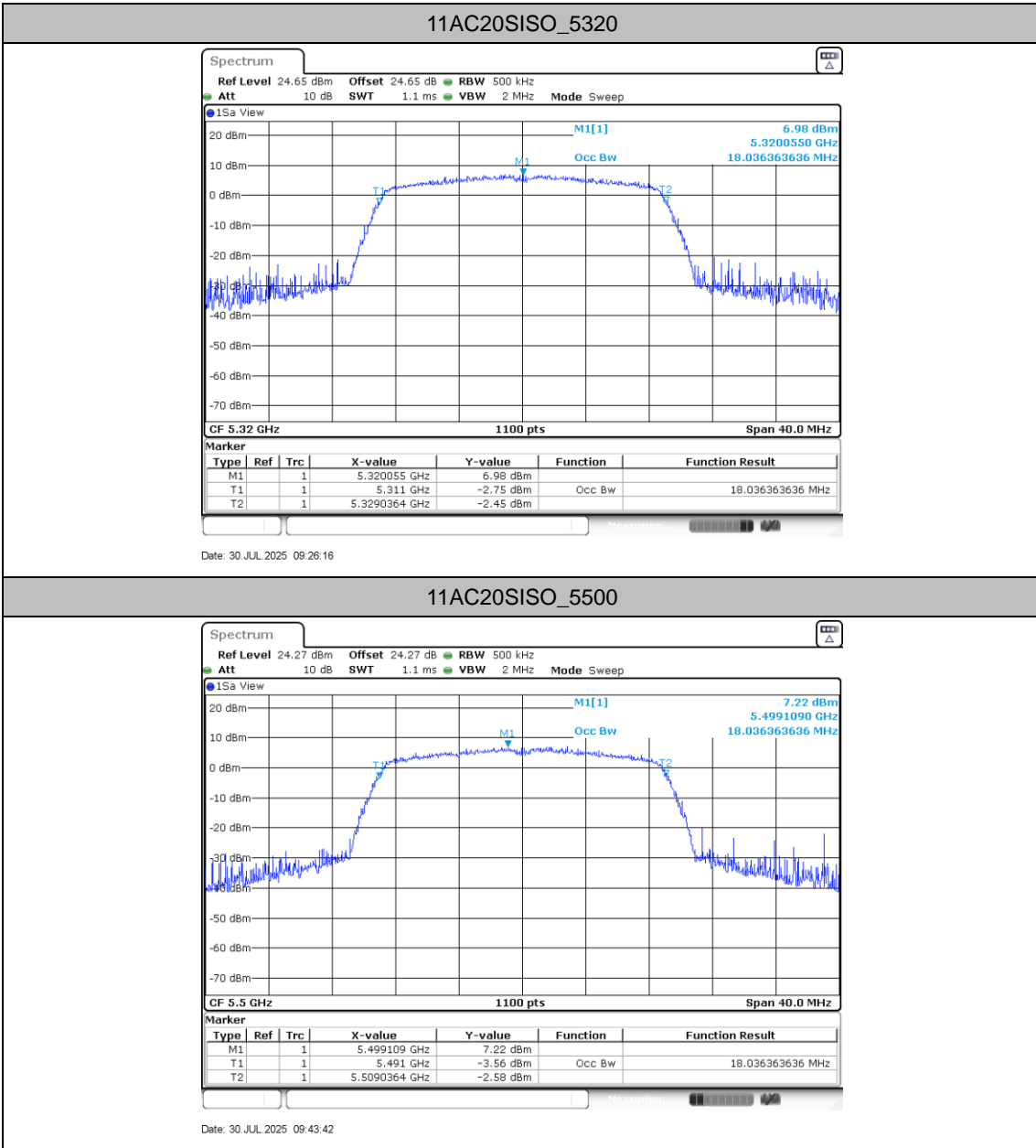



11AC20SISO\_5580

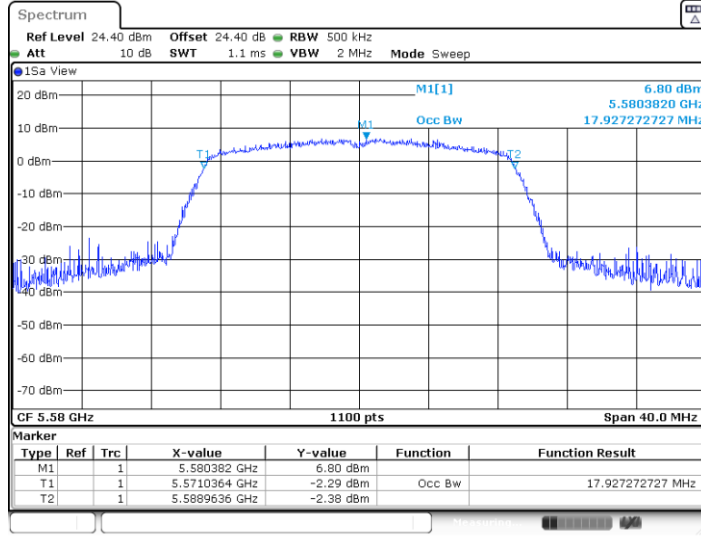

Date: 30 JUL 2025 09:44:30

11AC20SISO\_5700

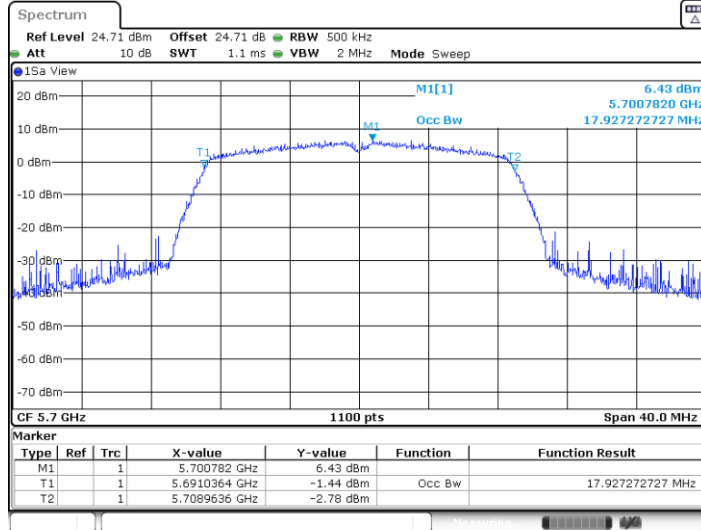

Date: 30 JUL 2025 09:45:24



11AC20SISO\_5720

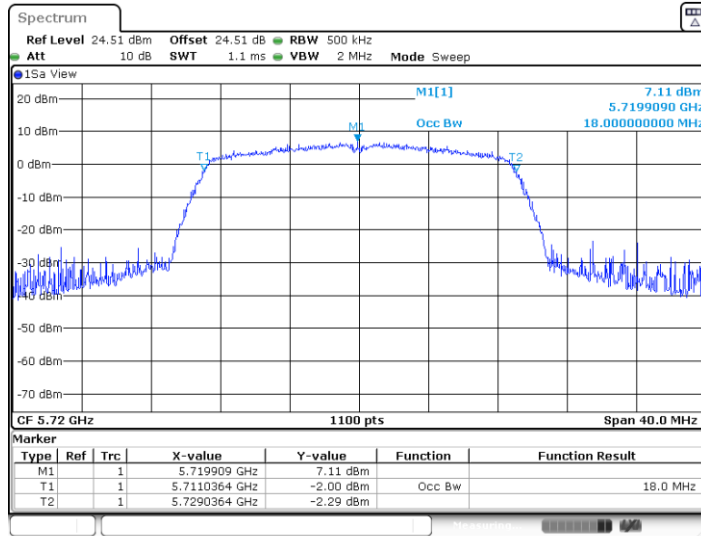

Date: 30 JUL 2025 09:46:01

11AC20SISO\_5745

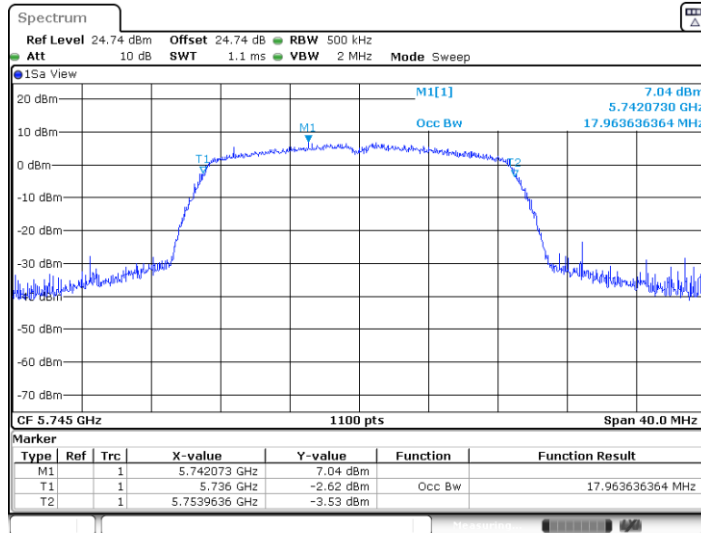

Date: 30 JUL 2025 09:47:01



11AC20SISO\_5785

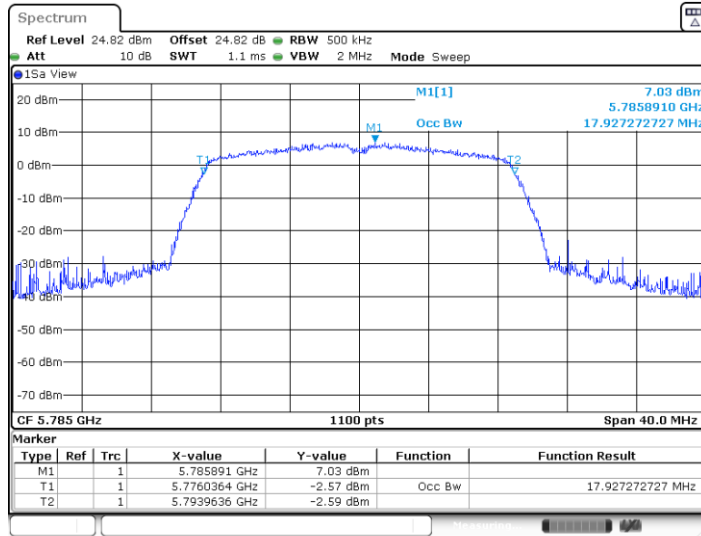

Date: 30 JUL 2025 09:47:42

11AC20SISO\_5825

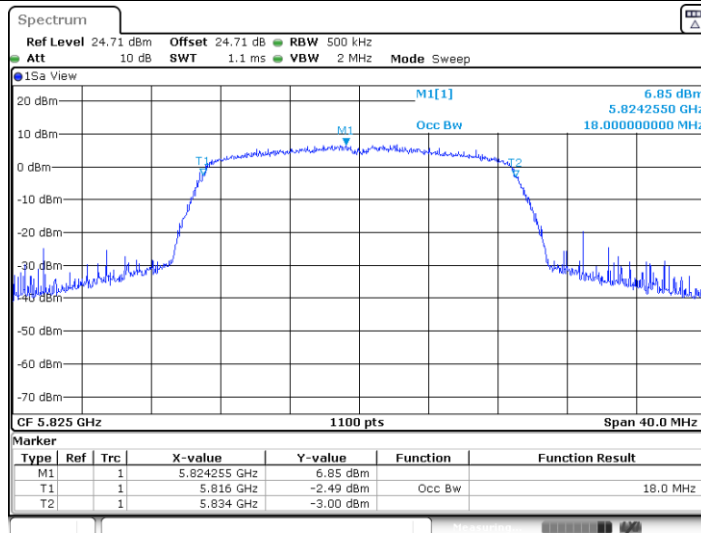

Date: 30 JUL 2025 09:48:22

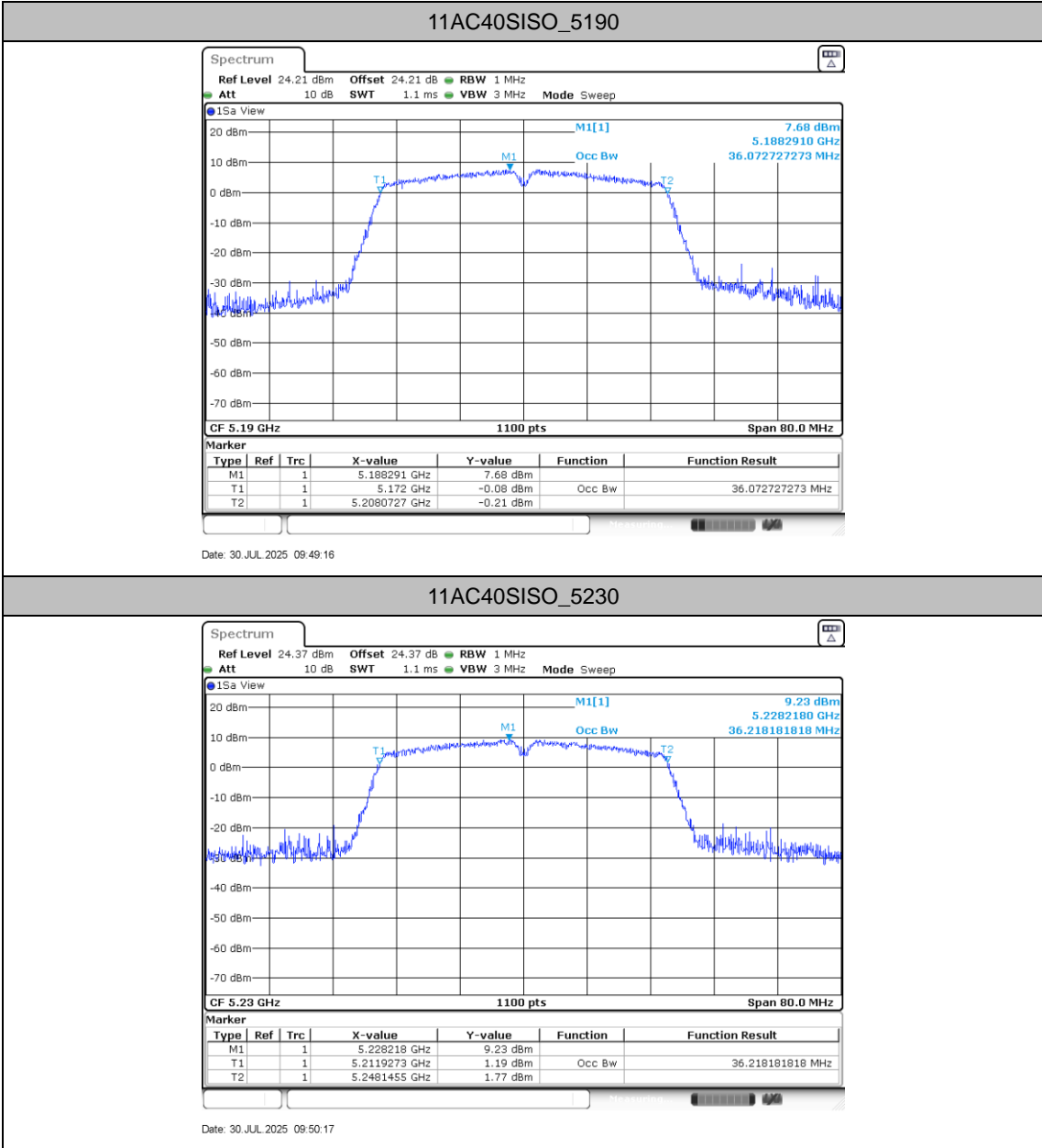



11AC40SISO\_5270

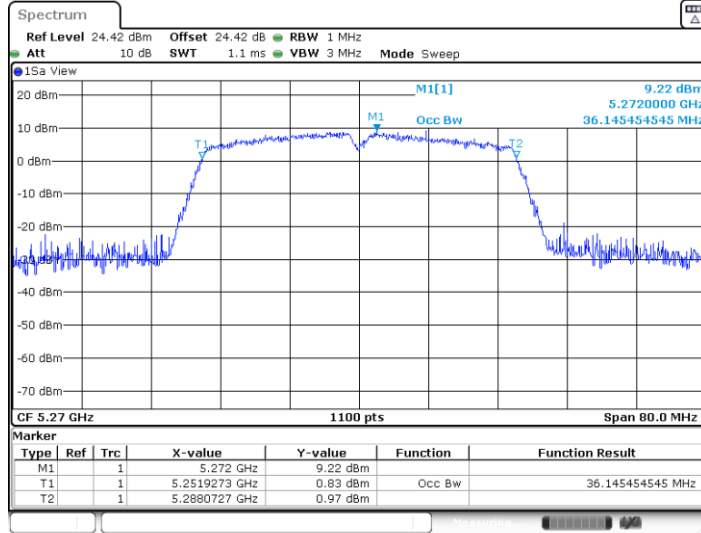

Date: 30 JUL 2025 09:51:52

11AC40SISO\_5310

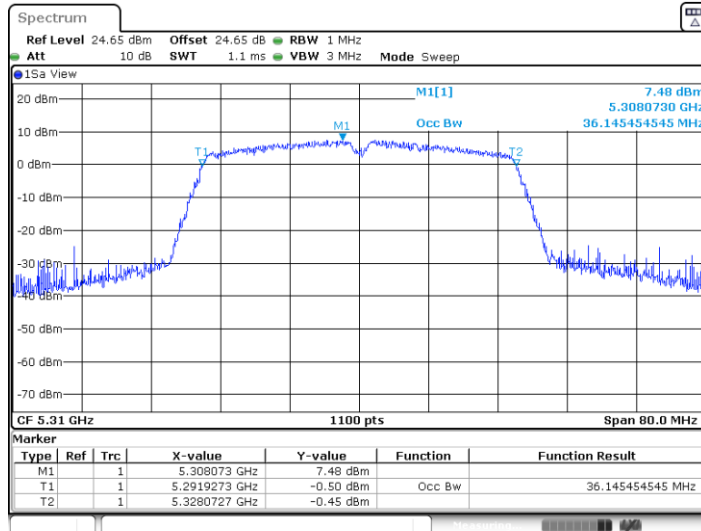

Date: 30 JUL 2025 09:52:28

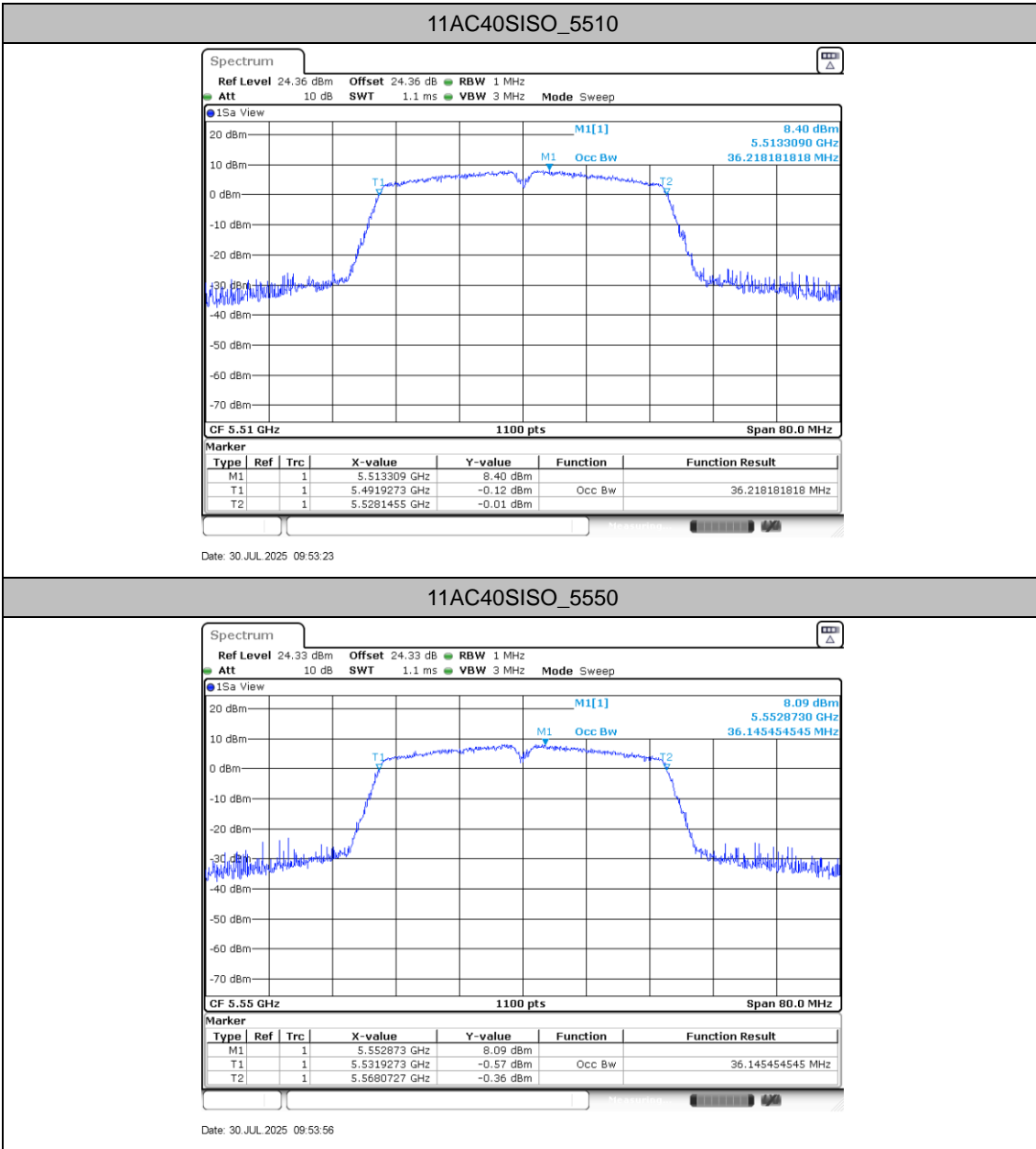



11AC40SISO\_5670

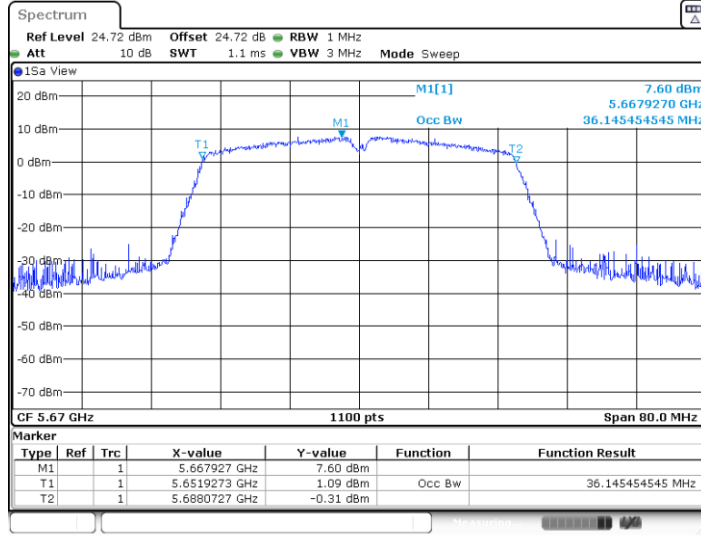

Date: 30 JUL 2025 09:54:32

11AC40SISO\_5710

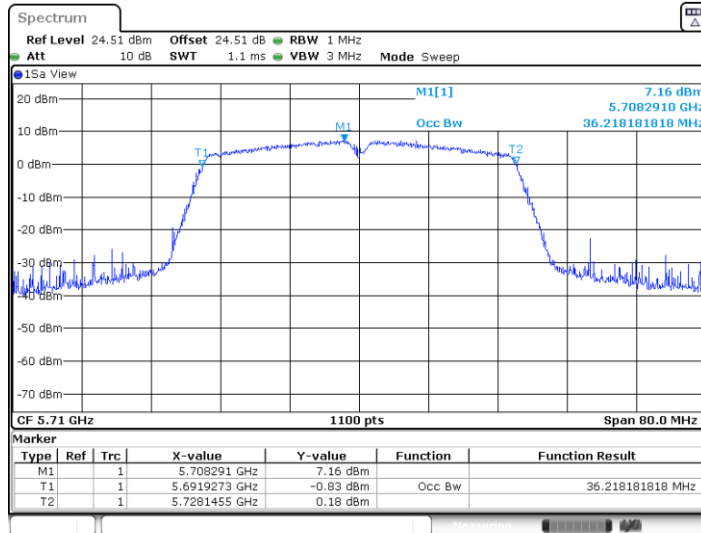

Date: 30 JUL 2025 09:55:09



11AC40SISO\_5755

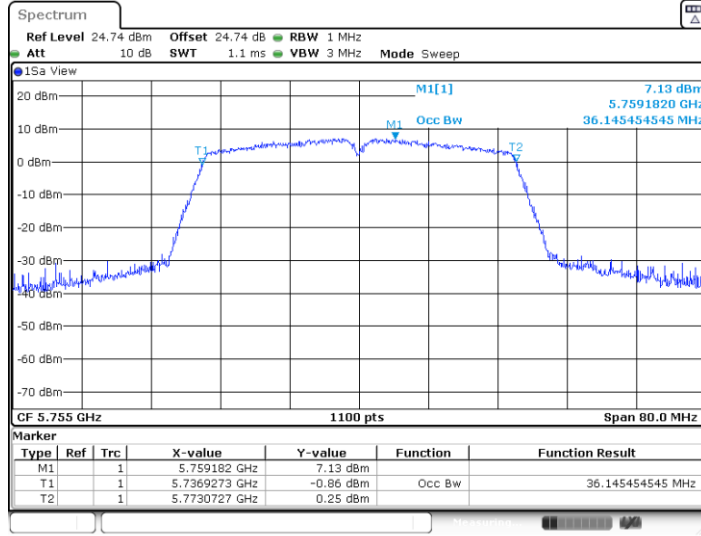

Date: 30 JUL 2025 09:56:21

11AC40SISO\_5795

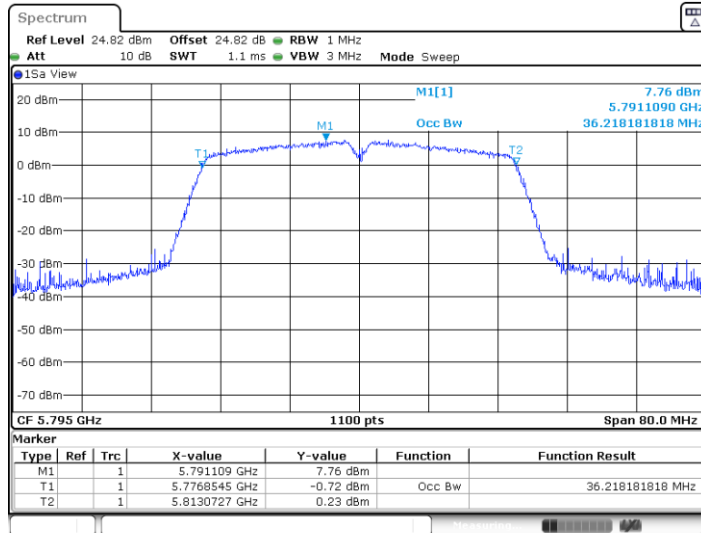

Date: 30 JUL 2025 09:57:07