



FCC RF Test Report

APPLICANT : Motorola Mobility LLC
EQUIPMENT : Mobile Cellular Phone
BRAND NAME : Motorola
MODEL NAME : XT2529-1
FCC ID : IHDT56AV1
STANDARD : 47 CFR Part 90(S)
CLASSIFICATION : PCS Licensed Transmitter Held to Ear (PCE)
TEST DATE(S) : Feb. 23, 2025 ~ Mar. 10, 2025

We, Sporton International Inc. (Kunshan), would like to declare that the tested sample has been evaluated in accordance with the procedures given in ANSI C63.26-2015 and shown compliance with the applicable technical standards.

This report contains data that were produced under subcontract by Sporton International Inc. (ShenZhen)

The test results in this report apply exclusively to the tested model / sample. Without written approval of Sporton International Inc. (Kunshan), the test report shall not be reproduced except in full.

Jason Jia

Approved by: Jason Jia



Sporton International Inc. (Kunshan)

**No. 1098, Pengxi North Road, Kunshan Economic Development Zone Jiangsu Province 215300
People's Republic of China**



TABLE OF CONTENTS

REVISION HISTORY..... 3

SUMMARY OF TEST RESULT 4

1 GENERAL DESCRIPTION 5

 1.1 Applicant..... 5

 1.2 Manufacturer 5

 1.3 Feature of Equipment Under Test..... 5

 1.4 Product Specification of Equipment Under Test 5

 1.5 Modification of EUT 6

 1.6 Maximum Conducted Power and Emission Designator 6

 1.7 Testing Site..... 6

 1.8 Test Software 7

 1.9 Applied Standards 7

 1.10 Specification of Accessory 8

2 TEST CONFIGURATION OF EQUIPMENT UNDER TEST 9

 2.1 Test Mode..... 9

 2.2 Connection Diagram of Test System 9

 2.3 Support Unit used in test configuration and system..... 10

 2.4 Measurement Results Explanation Example 10

 2.5 Frequency List of Low/Middle/High Channels..... 10

3 TEST RESULT..... 11

 3.1 Conducted Output Power Measurement..... 11

 3.2 99% Occupied Bandwidth and 26dB Bandwidth Measurement..... 12

 3.3 Emissions Mask Measurement 13

 3.4 Emissions Mask – Out Of Band Emissions Measurement..... 15

 3.5 Field Strength of Spurious Radiation Measurement 16

 3.6 Frequency Stability Measurement..... 19

4 LIST OF MEASURING EQUIPMENT 21

5 MEASUREMENT UNCERTAINTY 22

APPENDIX A. TEST RESULTS OF CONDUCTED TEST

APPENDIX B. TEST RESULTS OF RADIATED TEST

APPENDIX C. TEST SETUP PHOTOGRAPHS



SUMMARY OF TEST RESULT

Report Section	FCC Rule	Description	Limit	Result	Remark
3.1	§2.1046	Conducted Output Power	—	Report only	-
3.2	§2.1049 §90.209	Occupied Bandwidth and 26dB Bandwidth	—	Report only	-
3.3	§2.1051 §90.691	Emission masks – In-band emissions	$< 50+10\log_{10}(P[\text{Watts}])$	PASS	-
3.4	§2.1051 §90.691	Emission masks – Out of band emissions	$< 43+10\log_{10}(P[\text{Watts}])$	PASS	-
3.5	§2.1053 §90.691	Field Strength of Spurious Radiation	$< 43+10\log_{10}(P[\text{Watts}])$	PASS	Under limit 48.45 dB at 3260.000 MHz
3.6	§2.1055 §90.213	Frequency Stability for Temperature & Voltage	$< 2.5 \text{ ppm}$	PASS	-

Conformity Assessment Condition:

1. The test results (PASS/FAIL) with all measurement uncertainty excluded are presented against the regulation limits or in accordance with the requirements stipulated by the applicant/manufacturer who shall bear all the risks of non-compliance that may potentially occur if measurement uncertainty is taken into account.
2. The measurement uncertainty please refer to each test result in the section "Measurement Uncertainty"

Disclaimer:

The product specifications of the EUT presented in the test report that may affect the test assessments are declared by the manufacturer who shall take full responsibility for the authenticity.



1 General Description

1.1 Applicant

Motorola Mobility LLC
222 W,Merchandise Mart Plaza, Chicago IL 60654 USA

1.2 Manufacturer

Motorola Mobility LLC
222 W,Merchandise Mart Plaza, Chicago IL 60654 USA

1.3 Feature of Equipment Under Test

Product Feature	
Equipment	Mobile Cellular Phone
Brand Name	Motorola
Model Name	XT2529-1
FCC ID	IHDT56AV1
IMEI Code	Conducted: 351291190034439/351291190034447 Radiation: 351291190028753/351291190028761
HW Version	DVT2
SW Version	V2VO35.57
EUT Stage	Identical Prototype

Remark: There are three types of EUT, the differences could be referred to the XT2529-1_Operational Description of Product Equality Declaration which is exhibit separately. According to the difference, we choose sample 1 to full test.

1.4 Product Specification of Equipment Under Test

Product Specification subjective to this standard	
Tx Frequency	814 ~ 824 MHz
Rx Frequency	859 ~ 869 MHz
Bandwidth	15kHz: 5MHz / 10MHz / 15MHz / 20MHz 30kHz: 10MHz / 15MHz / 20MHz
SCS	15kHz/30kHz
Antenna Gain	<ANT0> : -5.5 dBi
Type of Modulation	CP-OFDM: QPSK / 16QAM / 64QAM / 256QAM DFT-s-OFDM: PI/2 BPSK / QPSK / 16QAM / 64QAM / 256QAM

Remark:

- 5G NR n26 support SCS 15kHz and 30kHz. According to the maximum power, full test 15kHz to cover 30kHz.
- 5G NR n26 support SA mode only.



1.5 Modification of EUT

No modifications are made to the EUT during all test items.

1.6 Maximum Conducted Power and Emission Designator

5G NR n26		PI/2 BPSK / QPSK		16QAM / 64QAM / 256QAM	
BW (MHz)	Frequency Range (MHz)	Maximum Conducted power (W)	Emission Designator (99%OBW)	Maximum Conducted power (W)	Emission Designator (99%OBW)
5	816.5 ~ 821.5	0.2466	4M47G7D	0.2307	4M47W7D
10	819	0.2449	9M26G7D	0.2223	9M27W7D
15	821.5	0.2460	14M1G7D	0.2333	14M1W7D
20	824	0.2472	18M9G7D	0.2228	18M9W7D

Note: All modulations have been tested, and only the worst test results of PSK & QAM are shown in the report.

1.7 Testing Site

Sporton International Inc. (Kunshan) is accredited to ISO/IEC 17025:2017 by American Association for Laboratory Accreditation with Certificate Number 5145.02.

Test Firm	Sporton International Inc. (Kunshan)		
Test Site Location	No. 1098, Pengxi North Road, Kunshan Economic Development Zone Jiangsu Province 215300 People’s Republic of China TEL : +86-512-57900158		
Test Site No.	Sporton Site No.	FCC Designation No.	FCC Test Firm Registration No.
	TH01-KS	CN1257	314309



Sporton International Inc. (ShenZhen) is accredited to ISO/IEC 17025:2017 by American Association for Laboratory Accreditation with Certificate Number 5145.01.

Test Firm	Sporton International Inc. (ShenZhen)		
Test Site Location	101, 1st Floor, Block B, Building 1, No. 2, Tengfeng 4th Road, Fenghuang Community, Fuyong Street, Baoan District, Shenzhen City, Guangdong Province 518103 People’s Republic of China TEL: +86-755-86066985		
Test Site No.	Sporton Site No.	FCC Designation No.	FCC Test Firm Registration No.
	03CH02-SZ	CN1256	421272

Test data subcontracted: Radiated Spurious Emission test case in section 3.5 of this report

1.8 Test Software

Item	Site	Manufacture	Name	Version
1.	03CH02-SZ	AUDIX	E3	6.2009-8-24

1.9 Applied Standards

According to the specifications of the manufacturer, the EUT must comply with the requirements of the following standards:

- 47 CFR 90(S)
- ANSI C63.26-2015
- FCC KDB 971168 D01 Power Meas. License Digital Systems v03r01
- FCC KDB 971168 D02 Misc Rev Approv License Devices v02r02

Remark:

1. All test items were verified and recorded according to the standards and without any deviation during the test.
2. This EUT has also been tested and complied with the requirements of FCC Part 15, Subpart B, recorded in a separate test report.



1.10 Specification of Accessory

Accessories Information				
AC Adapter 1(US)	Brand Name	Motorola(Salcomp)	Model Name	MC-331L
AC Adapter 1(EU)	Brand Name	Motorola(Salcomp)	Model Name	MC-332L
AC Adapter 1(UK)	Brand Name	Motorola(Salcomp)	Model Name	MC-333L
AC Adapter 1(AU)	Brand Name	Motorola(Salcomp)	Model Name	MC-335L
AC Adapter 1(AR)	Brand Name	Motorola(Salcomp)	Model Name	MC-336L
AC Adapter 1(BR)	Brand Name	Motorola(Salcomp)	Model Name	MC-337L
AC Adapter 1(CHILE)	Brand Name	Motorola(Salcomp)	Model Name	MC-339L
AC Adapter 1(KR)	Brand Name	Motorola(Salcomp)	Model Name	MC-330L
AC Adapter 2(US)	Brand Name	Motorola(Chenyang)	Model Name	MC-331L
AC Adapter 2(EU)	Brand Name	Motorola(Chenyang)	Model Name	MC-332L
AC Adapter 2(UK)	Brand Name	Motorola(Chenyang)	Model Name	MC-333L
AC Adapter 2(AR)	Brand Name	Motorola(Chenyang)	Model Name	MC-336L
AC Adapter 2(BR)	Brand Name	Motorola(Chenyang)	Model Name	MC-337L
AC Adapter 3(IN)	Brand Name	Motorola(AOHAI)	Model Name	MC-334L
AC Adapter 3(IN)	Brand Name	Motorola(XIHI)	Model Name	MC-334L
AC Adapter 4(IN)	Brand Name	Motorola(Salcomp)	Model Name	MC-334L
AC Adapter 4(IN)	Brand Name	Motorola(Salcomp)	Model Name	MC-334L
AC Adapter 5(US)	Brand Name	Motorola(Salcomp)	Model Name	MC-331
Battery 1	Brand Name	Motorola(Sunwoda)	Model Name	RB52
Battery 2	Brand Name	Motorola(NVT)	Model Name	RB52
Battery 3	Brand Name	Motorola(SCUD)	Model Name	RB52
USB Cable 1	Brand Name	Motorola(Yihuaxing)	Model Name	T365-020 T365-020-01 T365-020-02
USB Cable 2	Brand Name	Motorola(WASHIN)	Model Name	HX-TL-01 HX-TL-07 HX-TL-08
USB Cable 3	Brand Name	Motorola(Juwei)	Model Name	JWUB1614-T03H JWUB1705-T03H JWUB1856-T03H

2 Test Configuration of Equipment Under Test

2.1 Test Mode

During all testing, EUT is in link mode with base station emulator at maximum power level. The spurious emission measurements were carried out in semi-anechoic chamber with 3-meter test range, and EUT is rotated on three test planes to find out the worst emission.

Frequency range investigated for radiated emission is 30 MHz to 9000 MHz.

Test Items	Band	Bandwidth (MHz)				Modulation					RB #			Test Channel		
		5	10	15	20	PI/2 BPSK	QPSK	16QAM	64 QAM	256 QAM	1	Half	Full	L	M	H
Max. Output Power	n26	v	v	v	v	v	v	v	v	v	v		v	v	v	v
26dB and 99% Bandwidth	n26	v	v	v	v		v	v	v	v			v		v	
Emission masks In-band emissions	n26	v				v	v				v		v	v		v
			v		v	v	v				v		v		v	
Emission masks – Out of band emissions	n26	v				v	v				v			v	v	v
			v		v	v	v				v				v	
Frequency Stability	n26				v		v						v		v	
Radiated Spurious Emission	n26	Worst Case											v	v	v	
Note	<ol style="list-style-type: none"> The mark "v" means that this configuration is chosen for testing The mark "-" means that this bandwidth is not supported. 5G n26 transmit frequency for part22 rule is 824MHz-849MHz, for part90 rule is 814MHz-824MHz. ERP over 15MHz bandwidth complies the ERP limit line of part22 rule, therefore ERP of the partial frequency spectrum which falls within part 22 also complies. Frequency Stability : Normal Voltage = 3.91V ; Low Voltage =3.45V. ; High Voltage =4.50V 															

2.2 Connection Diagram of Test System

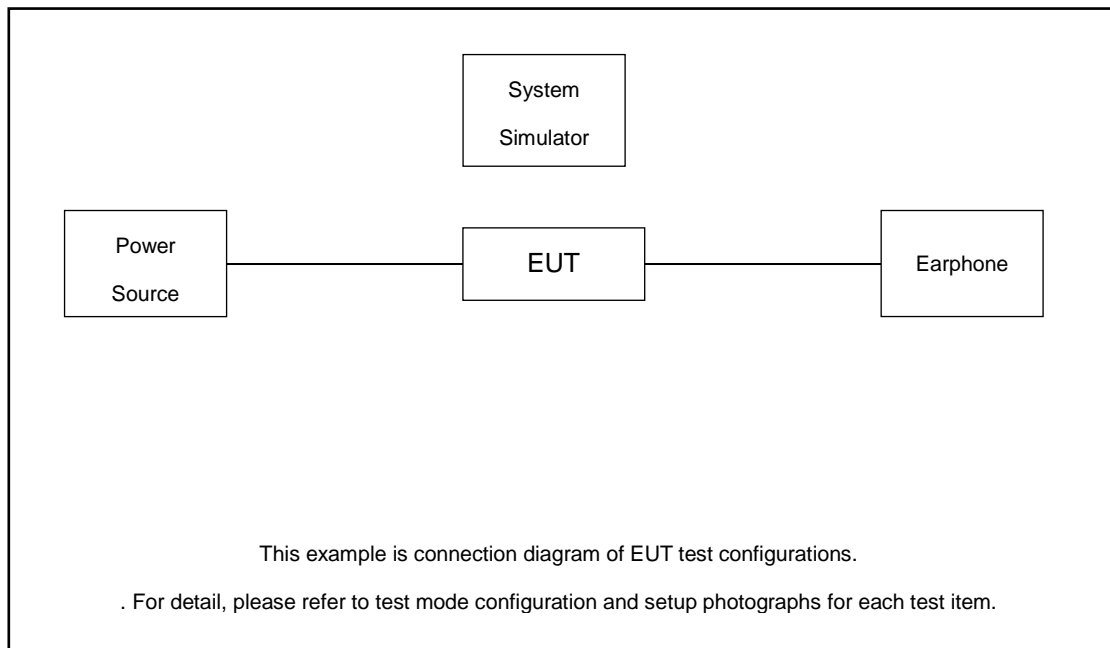

2.3 Support Unit used in test configuration and system

Item	Equipment	Trade Name	Model No.	FCC ID	Data Cable	Power Cord
1.	LTE Base Station	Anritsu	MT8820C	N/A	N/A	Unshielded, 1.8 m
2.	DC Power Supply	GW INSTEK	GPS-3030D	N/A	N/A	Unshielded, 1.8 m
3.	NR Base Station	Anritsu	MT8000A	N/A	N/A	Unshielded, 1.8 m
4.	Earphone	N/A	N/A	N/A	N/A	N/A

2.4 Measurement Results Explanation Example

For all conducted test items:

The offset level is set in the spectrum analyzer to compensate the RF cable loss between RF conducted output port and spectrum analyzer. With the offset compensation, the spectrum analyzer reading level will be exactly the RF output level.

The spectrum analyzer offset is derived from RF cable loss.

Offset = RF cable loss.

The following shows an offset computation example with RF cable loss 7.5 dB.

Example :

Offset(dB) = RF cable loss(dB) = 7.5 (dB)

2.5 Frequency List of Low/Middle/High Channels

5G NR n26 Channel and Frequency List				
BW [MHz]	Channel/Frequency(MHz)	Lowest	Middle	Highest
20	Channel	164800	-	-
	Frequency	824	-	-
15	Channel	164300	-	-
	Frequency	821.5	-	-
10	Channel	-	163800	-
	Frequency	-	819	-
5	Channel	163300	163800	164300
	Frequency	816.5	819	821.5

3 Test Result

3.1 Conducted Output Power Measurement

3.1.1 Description of the Conducted Output Power Measurement

A system simulator was used to establish communication with the EUT. Its parameters were set to enforce EUT transmitting at the maximum power. The measured power in the radio frequency on the transmitter output terminals shall be reported.

3.1.2 Measuring Instruments

The measuring equipment is listed in the section 4 of this test report.

3.1.3 Test Procedures

1. The transmitter output port was connected to the system simulator.
2. Set EUT at maximum power through the system simulator.
3. Select lowest, middle, and highest channels for each band and different modulation.
4. Measure and record the power level from the system simulator.

3.1.4 Test Setup

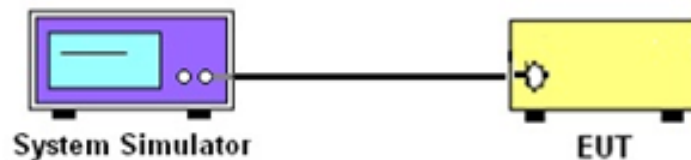

3.1.5 Test Result of Conducted Output Power

Please refer to Appendix A.

3.2 99% Occupied Bandwidth and 26dB Bandwidth Measurement

3.2.1 Description of (Occupied) Bandwidth Limitations Measurement

The 99% occupied bandwidth is the width of a frequency band such that, below the lower and above the upper frequency limits, the mean powers emitted are each equal to a specified percentage 0.5% of the total mean transmitted power.

The emission bandwidth is defined as the width of the signal between two points, located at the 2 sides of the carrier frequency, outside of which all emissions are attenuated at least 26 dB below the transmitter power.

3.2.2 Measuring Instruments

The measuring equipment is listed in the section 4 of this test report.

3.2.3 Test Procedures

1. The EUT was connected to spectrum analyzer and system simulator via a power divider.
2. The 26dB and 99% occupied bandwidth (BW) of the middle channel for the highest RF power with full RB sizes were measured.

3.2.4 Test Setup

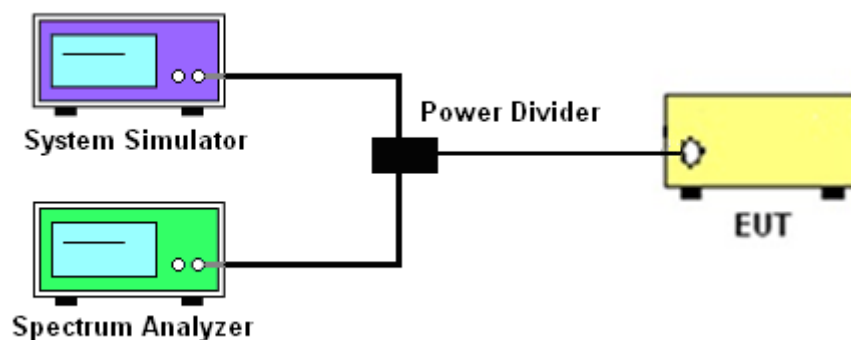

3.2.5 Test Result of 99% Occupied Bandwidth and 26dB Bandwidth

Please refer to Appendix A.



3.3 Emissions Mask Measurement

3.3.1 Description of Emissions Mask Measurement

Equipment used in this licensed to EA or non-EA systems shall comply with the emission mask provisions of FCC Part 90.691.(a):

(a) Out-of-band emission requirement shall apply only to the “outer” channels included in an EA license and to spectrum adjacent to interior channels used by incumbent licensees. The emission limits are as follows:

(1) For any frequency removed from the EA licensee's frequency block by up to and including 37.5 kHz, the power of any emission shall be attenuated below the transmitter power (P) in watts by at least $116 \text{ Log}_{10}(f/6.1)$ decibels or $50 + 10 \text{ Log}_{10}(P)$ decibels or 80 decibels, whichever is the lesser attenuation, where f is the frequency removed from the center of the outer channel in the block in kilohertz and where f is greater than 12.5 kHz.

(2) For any frequency removed from the EA licensee's frequency block greater than 37.5 kHz, the power of any emission shall be attenuated below the transmitter power (P) in watts by at least $43 + 10 \text{ Log}_{10}(P)$ decibels or 80 decibels, whichever is the lesser attenuation, where f is the frequency removed from the center of the outer channel in the block in kilohertz and where f is greater than 37.5 kHz.

3.3.2 Measuring Instruments

The measuring equipment is listed in the section 4 of this test report.

3.3.3 Test Procedures

1. The EUT was connected to spectrum analyzer and base station via power divider.
2. The emissions mask of low and high channels for the highest RF powers were measured.
3. The measured RBW and the VBW set 3 times of RBW are then set in spectrum analyzer, and the RBW correction factor $10 \text{ log} (1\% \text{ of OBW/measured RBW})(\text{dB})$ was compensated, if required.
4. The test results were shown below plots with a correction offset factor including cable loss, insertion loss of power divider.

3.3.4 Test Setup

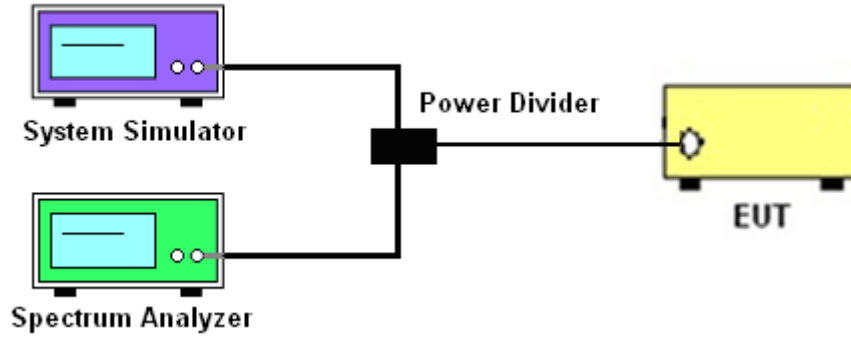

3.3.5 Test Result (Plots) of Conducted Emissions Mask

Please refer to Appendix A.

3.4 Emissions Mask – Out Of Band Emissions Measurement

3.4.1 Description of Conducted Emissions Out of band emissions measurement

The power of any emission FCC Part 90.691 (a)(2) on any frequency removed from the assigned frequency by out of the authorized bandwidth at least $43 + 10 \log (P)$ dB. It is measured by means of a calibrated spectrum analyzer and scanned from 30 MHz up to a frequency including its 10th harmonic.

3.4.2 Measuring Instruments

The measuring equipment is listed in the section 4 of this test report.

3.4.3 Test Procedures

1. The EUT was connected to spectrum analyzer and system simulator via a power divider.
2. The RF output of EUT was connected to the spectrum analyzer by RF cable and attenuator. The path loss was compensated to the results for each measurement.
3. The middle channel for the highest RF power within the transmitting frequency was measured.
4. The conducted spurious emission for the whole frequency range was taken.
5. Make the measurement with the spectrum analyzer's RBW = 1MHz, VBW = 3MHz, taking the record of maximum spurious emission.
6. The RF fundamental frequency should be excluded against the limit line in the operating frequency band.
7. The limit line is derived from $43 + 10\log(P)$ dB below the transmitter power P(Watts)

3.4.4 Test Setup

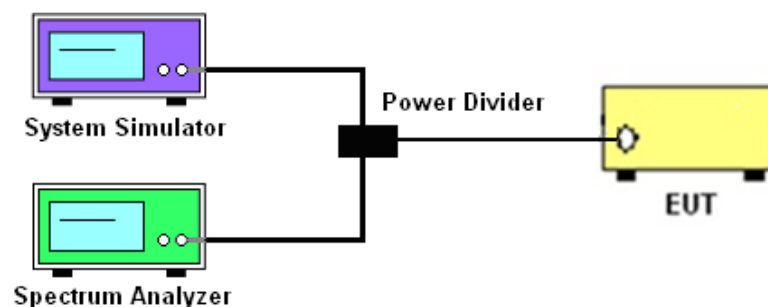

3.4.5 Test Result (Plots) of Conducted Emission

Please refer to Appendix A.

3.5 Field Strength of Spurious Radiation Measurement

3.5.1 Description of Field Strength of Spurious Radiated Measurement

The radiated spurious emission was measured by substitution method according to ANSI C63.26. The power of any emission FCC Part 90.691 on any frequency removed from the assigned frequency by more than 250 percent of the authorized bandwidth at least $43 + 10 \log(P)$ dB. The spectrum is scanned from 30 MHz up to a frequency including its 10th harmonic.

The power of any emission outside of the authorized operating frequency ranges must be attenuated below the transmitter power (P) by a factor of at least $43 + 10 \log_{10}(P[\text{Watts}])$ dB. The spectrum is scanned from 30 MHz up to a frequency including its 10th harmonic.

3.5.2 Measuring Instruments

The measuring equipment is listed in the section 4 of this test report.

3.5.3 Test Procedures

1. The EUT was placed on a turntable with 0.8 meter for frequency below 1GHz and 1.5 meter for frequency above 1GHz respectively above ground.
2. The EUT was set 3 meters from the receiving antenna, which was mounted on the antenna tower.
3. The table was rotated 360 degrees to determine the position of the highest spurious emission.
4. The height of the receiving antenna is varied between one meter and four meters to search the maximum spurious emission for both horizontal and vertical polarizations.
5. Make the measurement with the spectrum analyzer's RBW = 1MHz, VBW = 3MHz, Sweep = 500ms, Taking the record of maximum spurious emission.
6. A horn antenna was substituted in place of the EUT and was driven by a signal generator.
7. Tune the output power of signal generator to the same emission level with EUT maximum spurious emission.
8. Taking the record of output power at antenna port.
9. Repeat step 7 to step 8 for another polarization.
10. $\text{EIRP (dBm)} = \text{S.G. Power} - \text{Tx Cable Loss} + \text{Tx Antenna Gain}$
11. $\text{ERP (dBm)} = \text{EIRP} - 2.15$
12. The RF fundamental frequency should be excluded against the limit line in the operating frequency band.
13. The limit line is derived from $43 + 10 \log(P)$ dB below the transmitter power P(Watts)

3.5.4 Test Setup

For radiated test from 30MHz

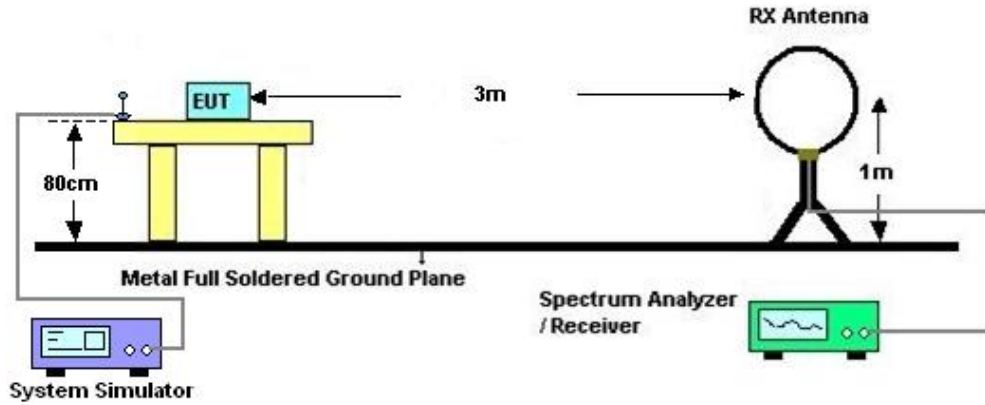

For radiated test from 30MHz to 1GHz

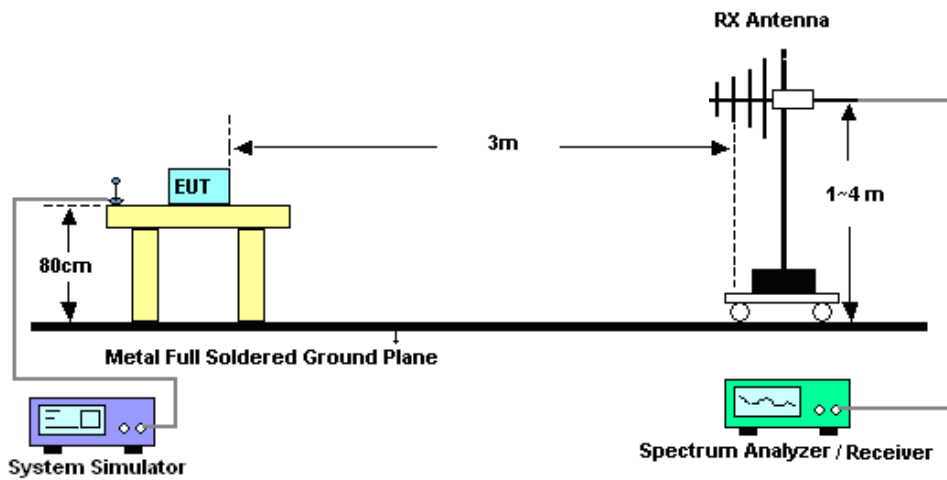

For radiated test above 1GHz

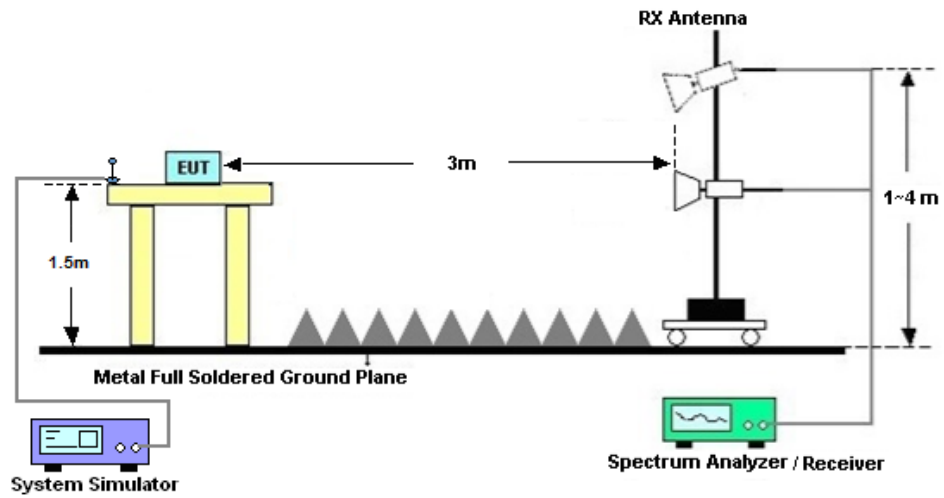

3.5.5 Test Result of Field Strength of Spurious Radiated

The low frequency, which started from 9 kHz to 30MHz, was pre-scanned and the result which was 20dB lower than the limit line was not reported.

Please refer to Appendix B.

3.6 Frequency Stability Measurement

3.6.1 Description of Frequency Stability Measurement

The frequency stability shall be measured by variation of ambient temperature and variation of primary supply voltage to ensure that the fundamental emission stays within the authorized frequency block. The frequency stability of the transmitter shall be maintained within $\pm 0.00025\%$ ($\pm 2.5\text{ppm}$) of the center frequency according to FCC Part 90.213.

3.6.2 Measuring Instruments

The measuring equipment is listed in the section 4 of this test report.

3.6.3 Test Procedures for Temperature Variation

1. The EUT was set up in the thermal chamber and connected with the base station.
2. With power OFF, the temperature was decreased to -30°C and the EUT was stabilized for three hours. Power was applied and the maximum change in frequency was recorded within one minute.
3. With power OFF, the temperature was raised in 10°C step up to 50°C . The EUT was stabilized at each step for at least half an hour. Power was applied and the maximum frequency change was recorded within one minute.

3.6.4 Test Procedures for Voltage Variation

1. The EUT was placed in a temperature chamber at $20\pm 5^{\circ}\text{C}$ and connected with the system simulator.
2. The power supply voltage to the EUT was varied from 85% to 115% of the nominal value for other than hand carried battery equipment.
3. For hand carried, battery powered equipment, reduce the primary ac or dc supply voltage to the battery operating end point, which shall be specified by the manufacturer.
4. The variation in frequency was measured for the worst case.

3.6.5 Test Setup



3.6.6 Test Result of Temperature Variation

Please refer to Appendix A.



4 List of Measuring Equipment

Instrument	Manufacturer	Model No.	Serial No.	Characteristics	Calibration Date	Test Date	Due Date	Remark
Spectrum Analyzer	R&S	FSV40	101040	10Hz~40GHz	Oct. 10, 2024	Mar. 10, 2025	Oct. 09, 2025	Conducted (TH01-KS)
Power divider	STI	STI08-0055	-	0.5~40GHz	NCR	Mar. 10, 2025	NCR	Conducted (TH01-KS)
Temperature & humidity chamber	Hongzhan	LP-150U	H2014011440	-40~+150°C 20%~95%RH	Jul. 04, 2024	Mar. 10, 2025	Jul. 03, 2025	Conducted (TH01-KS)
EXA Spectrum Analyzer	KEYSIGHT	N9010A	MY55150213	10Hz~44GHz	Jul. 03, 2024	Feb. 23, 2025	Jul. 02, 2025	Radiation (03CH02-SZ)
Loop Antenna	R&S	HFH2-Z2E	101141	9kHz~30MHz	Dec. 28, 2024	Feb. 23, 2025	Dec. 27, 2025	Radiation (03CH02-SZ)
Bilog Antenna	TeseQ	CBL6112D	35407	30MHz-2GHz	Oct. 24, 2023	Feb. 23, 2025	Oct. 23, 2025	Radiation (03CH02-SZ)
Double Ridge Horn Antenna	ETS-Lindgren	3117	00119436	1GHz~18GHz	Jul. 04, 2024	Feb. 23, 2025	Jul. 04, 2025	Radiation (03CH02-SZ)
HF Amplifier	MITEQ	TTA1840-35-HG	1871923	18GHz~40GHz	Jul. 03, 2024	Feb. 23, 2025	Jul. 03, 2025	Radiation (03CH02-SZ)
SHF-EHF Horn	com-power	AH-840	101071	18Ghz-40GHz	Apr. 09, 2024	Feb. 23, 2025	Apr. 08, 2025	Radiation (03CH02-SZ)
LF Amplifier	Burgeon	BPA-530	102211	0.01~3000Mhz	Oct. 18, 2024	Feb. 23, 2025	Oct. 17, 2025	Radiation (03CH02-SZ)
HF Amplifier	KEYSIGHT	83017A	MY53270105	0.5GHz~26.5GHz	Oct. 14, 2024	Feb. 23, 2025	Oct. 13, 2025	Radiation (03CH02-SZ)
AC Power Source	Chroma	61601	616010003043	N/A	Oct. 18, 2024	Feb. 23, 2025	Oct. 17, 2025	Radiation (03CH02-SZ)
Turn Table	Chaintek	T-200	N/A	0~360 degree	NCR	Feb. 23, 2025	NCR	Radiation (03CH02-SZ)
Antenna Mast	Chaintek	MBS-400	N/A	1 m~4 m	NCR	Feb. 23, 2025	NCR	Radiation (03CH02-SZ)

NCR: No Calibration Required



5 Measurement Uncertainty

The measurement uncertainties shown below were calculated in accordance with the requirements of ANSI 63.26-2015. All the measurement uncertainty value were shown with a coverage K=2 to indicate 95% level of confidence. The measurement data show herein meets or exceeds the CISPR measurement uncertainty values specified in CISPR 16-4-2 and can be compared directly to specified limit to determine compliance.

Uncertainty of Conducted Measurement

Test Item	Uncertainty
Conducted Spurious Emission & Bandedge	±1.34 dB
Occupied Channel Bandwidth	±0.012 MHz
Conducted Power	±1.34 dB
Peak to Average Ratio	±1.34 dB
Frequency Stability	±1.3 Hz

Uncertainty of Radiated Emission Measurement (30 MHz ~ 1000 MHz)

Measuring Uncertainty for a Level of Confidence of 95% (U = 2Uc(y))	2.47 dB
---	---------

Uncertainty of Radiated Emission Measurement (1 GHz ~ 18 GHz)

Measuring Uncertainty for a Level of Confidence of 95% (U = 2Uc(y))	3.31 dB
---	---------

Uncertainty of Radiated Emission Measurement (18 GHz ~ 40 GHz)

Measuring Uncertainty for a Level of Confidence of 95% (U = 2Uc(y))	3.72 dB
---	---------

----- THE END -----



Appendix A. Test Results of Conducted Test

Test Engineer :	Khan Zhen	Temperature :	22~23°C
		Relative Humidity :	40~42%



Software Version: 23.06.1602

FR1 N26-Ant 0

Transmitter Conducted Output Power

NR Band	SCS	BandWidth	Arfcn	Freq(MHz)	Modulation	RB	Conducted Power(dBm)
26	15	5	163300	816.5	DFT-s-OFDM QPSK	12@6	23.64
26	15	5	163300	816.5	DFT-s-OFDM QPSK	1@1	23.6
26	15	5	163300	816.5	DFT-s-OFDM QPSK	1@23	23.53
26	15	5	163300	816.5	DFT-s-OFDM 16 QAM	12@6	23.42
26	15	5	163300	816.5	DFT-s-OFDM 16 QAM	1@1	23.11
26	15	5	163300	816.5	DFT-s-OFDM 16 QAM	1@23	23.27
26	15	5	163800	819	DFT-s-OFDM QPSK	12@6	23.78
26	15	5	163800	819	DFT-s-OFDM QPSK	1@1	23.74
26	15	5	163800	819	DFT-s-OFDM QPSK	1@23	23.59
26	15	5	163800	819	DFT-s-OFDM 16 QAM	12@6	23.55
26	15	5	163800	819	DFT-s-OFDM 16 QAM	1@1	23.25
26	15	5	163800	819	DFT-s-OFDM 16 QAM	1@23	23.37
26	15	5	164300	821.5	DFT-s-OFDM QPSK	12@6	23.86
26	15	5	164300	821.5	DFT-s-OFDM QPSK	1@1	23.92
26	15	5	164300	821.5	DFT-s-OFDM QPSK	1@23	23.54
26	15	5	164300	821.5	DFT-s-OFDM 16 QAM	12@6	23.63
26	15	5	164300	821.5	DFT-s-OFDM 16 QAM	1@1	23.33
26	15	5	164300	821.5	DFT-s-OFDM 16 QAM	1@23	23.26
26	15	10	163800	819	DFT-s-OFDM QPSK	25@12	23.89
26	15	10	163800	819	DFT-s-OFDM QPSK	1@1	23.6
26	15	10	163800	819	DFT-s-OFDM QPSK	1@50	23.85
26	15	10	163800	819	DFT-s-OFDM 16 QAM	25@12	23.47
26	15	10	163800	819	DFT-s-OFDM 16 QAM	1@1	23.39
26	15	10	163800	819	DFT-s-OFDM 16 QAM	1@50	23.24
26	15	15	164300	821.5	DFT-s-OFDM QPSK	36@18	23.91
26	15	15	164300	821.5	DFT-s-OFDM QPSK	1@1	23.86
26	15	15	164300	821.5	DFT-s-OFDM QPSK	1@77	23.76
26	15	15	164300	821.5	DFT-s-OFDM 16 QAM	36@18	23.68
26	15	15	164300	821.5	DFT-s-OFDM 16 QAM	1@1	23.07
26	15	15	164300	821.5	DFT-s-OFDM 16 QAM	1@77	23.3
26	15	20	164800	824	DFT-s-OFDM PI/2 BPSK	50@25	23.93
26	15	20	164800	824	DFT-s-OFDM PI/2 BPSK	1@1	23.33
26	15	20	164800	824	DFT-s-OFDM PI/2 BPSK	1@104	23.22
26	15	20	164800	824	DFT-s-OFDM QPSK	50@25	23.75



26	15	20	164800	824	DFT-s-OFDM QPSK	1@1	23.39
26	15	20	164800	824	DFT-s-OFDM QPSK	1@104	23.26
26	15	20	164800	824	DFT-s-OFDM 16 QAM	50@25	23.48
26	15	20	164800	824	DFT-s-OFDM 16 QAM	1@1	23.02
26	15	20	164800	824	DFT-s-OFDM 16 QAM	1@104	23.04
26	15	20	164800	824	DFT-s-OFDM 64 QAM	50@25	22.18
26	15	20	164800	824	DFT-s-OFDM 64 QAM	1@1	21.67
26	15	20	164800	824	DFT-s-OFDM 64 QAM	1@104	21.76
26	15	20	164800	824	DFT-s-OFDM 256 QAM	50@25	20.17
26	15	20	164800	824	DFT-s-OFDM 256 QAM	1@1	20
26	15	20	164800	824	DFT-s-OFDM 256 QAM	1@104	20.04
26	15	20	164800	824	CP-OFDM QPSK	53@26	23.15
26	15	20	164800	824	CP-OFDM QPSK	1@1	22.84
26	15	20	164800	824	CP-OFDM QPSK	1@104	22.9



Frequency Stability

NR Band	SCS (kHz)	Bandwidth (MHz)	Arfcn	Freq (MHz)	Modulation	RB	Deviation (ppm)	Verdict	Environment
26	15	20	164800	824.0	DFT-s-OFDM QPSK	100@0	0.0000	PASS	NV
26	15	20	164800	824.0	DFT-s-OFDM QPSK	100@0	0.0123	PASS	LV
26	15	20	164800	824.0	DFT-s-OFDM QPSK	100@0	0.0046	PASS	HV
26	15	20	164800	824.0	DFT-s-OFDM QPSK	100@0	0.0047	PASS	-30°C
26	15	20	164800	824.0	DFT-s-OFDM QPSK	100@0	0.0074	PASS	-20°C
26	15	20	164800	824.0	DFT-s-OFDM QPSK	100@0	0.0046	PASS	-10°C
26	15	20	164800	824.0	DFT-s-OFDM QPSK	100@0	0.0056	PASS	0°C
26	15	20	164800	824.0	DFT-s-OFDM QPSK	100@0	0.0123	PASS	10°C
26	15	20	164800	824.0	DFT-s-OFDM QPSK	100@0	0.0000	PASS	20°C
26	15	20	164800	824.0	DFT-s-OFDM QPSK	100@0	0.0080	PASS	30°C
26	15	20	164800	824.0	DFT-s-OFDM QPSK	100@0	0.0022	PASS	40°C
26	15	20	164800	824.0	DFT-s-OFDM QPSK	100@0	0.0064	PASS	50°C

Peak to Average Ratio

NR Band	SCS (kHz)	Bandwidth (MHz)	Arfcn	Freq (MHz)	Modulation	RB	Result (dB)	Limit (dB)	Verdict
26	15	20	164800	824.0	DFT-s-OFDM PI/2 BPSK	100@0	4.12	13	PASS
26	15	20	164800	824.0	DFT-s-OFDM QPSK	100@0	5.19	13	PASS

N26(20M)_DFT-s-OFDM_PI_2-BPSK_Outer_Full_Mid_CH



N26(20M)_DFT-s-OFDM_QPSK_Outer_Full_Mid_CH





Occupied Bandwidth

NR Band	SCS (kHz)	Bandwidth (MHz)	Arfcn	Freq (MHz)	Modulation	RB	OBW (MHz)	26dB BW (MHz)
26	15	5	163800	819.0	CP-OFDM QPSK	25@0	4.466	4.835
26	15	5	163800	819.0	CP-OFDM 16 QAM	25@0	4.4734	4.879
26	15	5	163800	819.0	CP-OFDM 64 QAM	25@0	4.4595	4.83
26	15	5	163800	819.0	CP-OFDM 256 QAM	25@0	4.4746	4.809
26	15	10	163800	819.0	CP-OFDM QPSK	52@0	9.2563	9.736
26	15	10	163800	819.0	CP-OFDM 16 QAM	52@0	9.2396	9.787
26	15	10	163800	819.0	CP-OFDM 64 QAM	52@0	9.2687	9.813
26	15	10	163800	819.0	CP-OFDM 256 QAM	52@0	9.2742	9.822
26	15	15	164300	821.5	CP-OFDM QPSK	79@0	14.122	14.7
26	15	15	164300	821.5	CP-OFDM 16 QAM	79@0	14.105	14.8
26	15	15	164300	821.5	CP-OFDM 64 QAM	79@0	14.08	14.73
26	15	15	164300	821.5	CP-OFDM 256 QAM	79@0	14.083	14.74
26	15	20	164800	824.0	CP-OFDM QPSK	106@0	18.878	19.8
26	15	20	164800	824.0	CP-OFDM 16 QAM	106@0	18.868	19.77
26	15	20	164800	824.0	CP-OFDM 64 QAM	106@0	18.843	19.69
26	15	20	164800	824.0	CP-OFDM 256 QAM	106@0	18.912	19.73



N26(5M)_CP-OFDM_QPSK_Outer_Full_Mid_CH



N26(5M)_CP-OFDM_16QAM_Outer_Full_Mid_CH



N26(5M)_CP-OFDM_64QAM_Outer_Full_Mid_CH

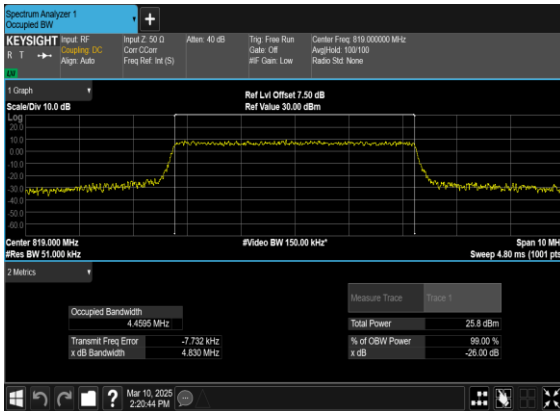

N26(5M)_CP-OFDM_256QAM_Outer_Full_Mid_CH

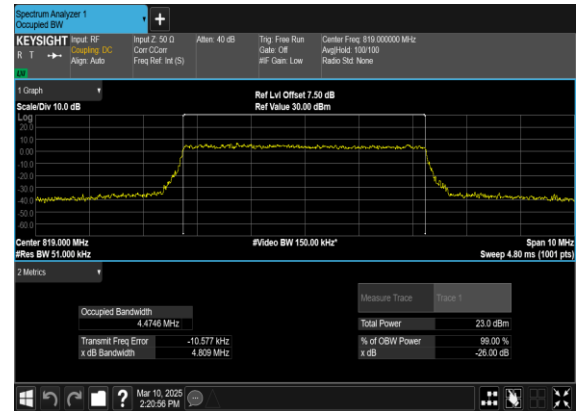



N26(10M)_CP-OFDM_QPSK_Outer_Full_Mid_CH

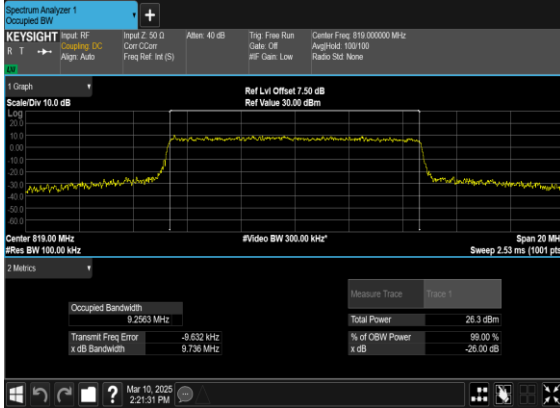

N26(10M)_CP-OFDM_16QAM_Outer_Full_Mid_CH

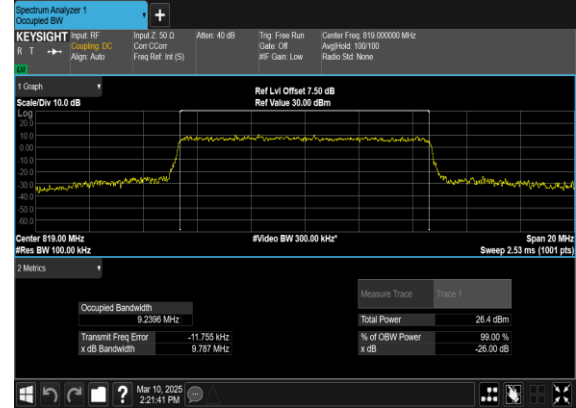

N26(10M)_CP-OFDM_64QAM_Outer_Full_Mid_CH

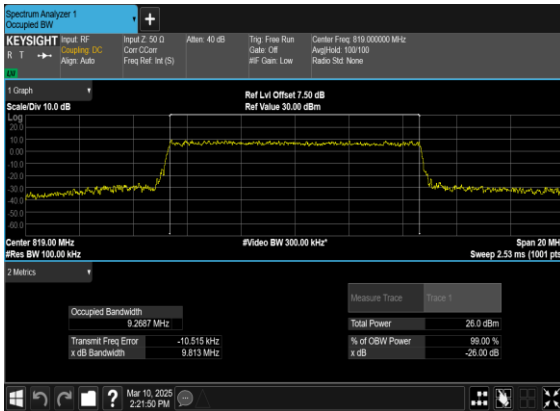

N26(10M)_CP-OFDM_256QAM_Outer_Full_Mid_CH

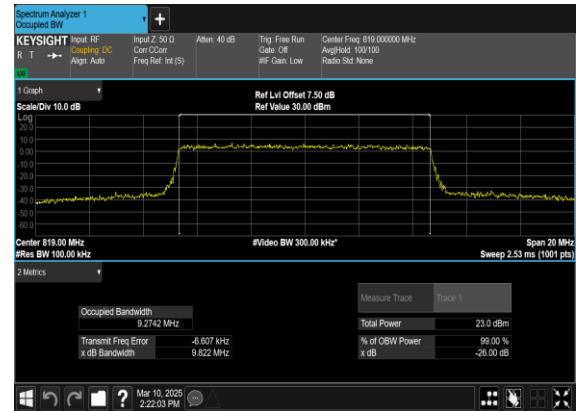



N26(15M)_CP-OFDM_QPSK_Outer_Full_Mid_CH

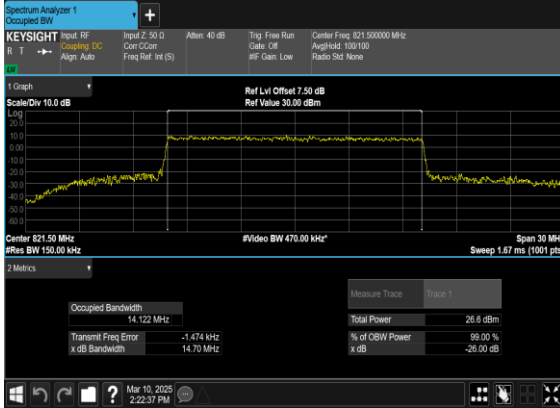

N26(15M)_CP-OFDM_16QAM_Outer_Full_Mid_CH



N26(15M)_CP-OFDM_64QAM_Outer_Full_Mid_CH

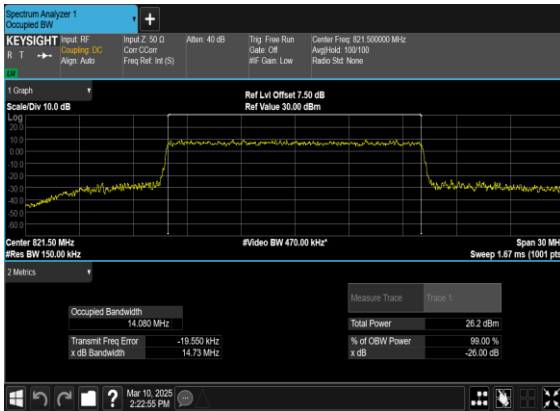

N26(15M)_CP-OFDM_256QAM_Outer_Full_Mid_CH

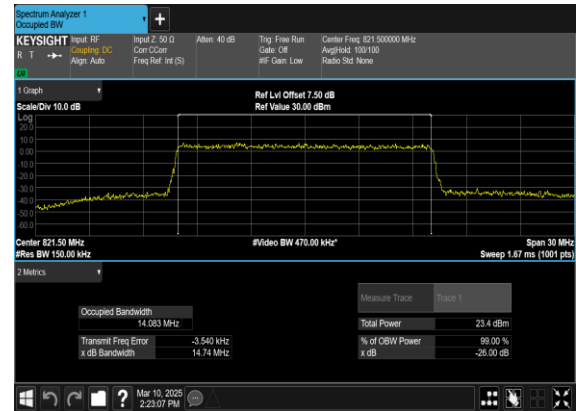



N26(20M)_CP-OFDM_QPSK_Outer_Full_Mid_CH

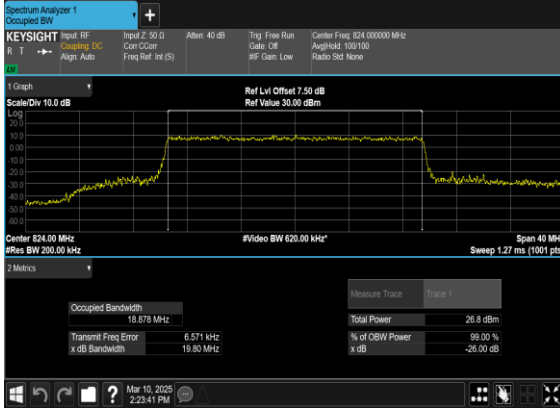

N26(20M)_CP-OFDM_16QAM_Outer_Full_Mid_CH

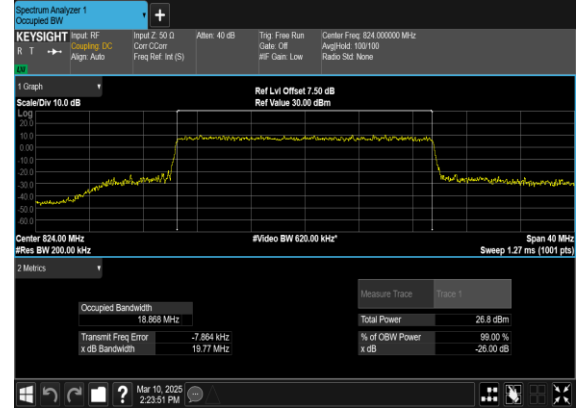

N26(20M)_CP-OFDM_64QAM_Outer_Full_Mid_CH

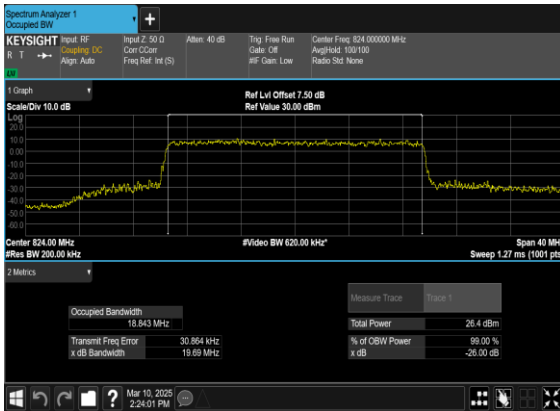

N26(20M)_CP-OFDM_256QAM_Outer_Full_Mid_CH

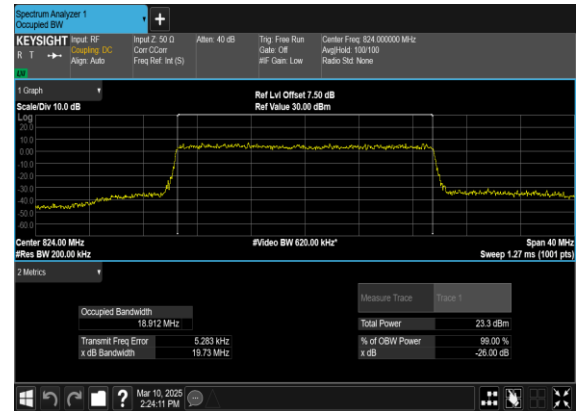



Conducted Spurious Emissions

NR Band	SCS (kHz)	Bandwidth (MHz)	Arfcn	Freq (MHz)	Modulation	RB	Result	Verdict
26	15	5	163300	816.5	DFT-s-OFDM BPSK	1@0	see graph	---
26	15	5	163300	816.5	DFT-s-OFDM BPSK	1@0	see graph	PASS
26	15	5	163300	816.5	DFT-s-OFDM QPSK	1@0	see graph	---
26	15	5	163300	816.5	DFT-s-OFDM QPSK	1@0	see graph	PASS
26	15	5	163800	819.0	DFT-s-OFDM BPSK	1@0	see graph	---
26	15	5	163800	819.0	DFT-s-OFDM BPSK	1@0	see graph	PASS
26	15	5	163800	819.0	DFT-s-OFDM QPSK	1@0	see graph	---
26	15	5	163800	819.0	DFT-s-OFDM QPSK	1@0	see graph	PASS
26	15	5	164300	821.5	DFT-s-OFDM BPSK	1@0	see graph	---
26	15	5	164300	821.5	DFT-s-OFDM BPSK	1@0	see graph	PASS
26	15	5	164300	821.5	DFT-s-OFDM QPSK	1@0	see graph	---
26	15	5	164300	821.5	DFT-s-OFDM QPSK	1@0	see graph	PASS
26	15	10	163800	819.0	DFT-s-OFDM BPSK	1@0	see graph	---
26	15	10	163800	819.0	DFT-s-OFDM BPSK	1@0	see graph	PASS
26	15	10	163800	819.0	DFT-s-OFDM QPSK	1@0	see graph	---
26	15	10	163800	819.0	DFT-s-OFDM QPSK	1@0	see graph	PASS
26	15	20	164800	824.0	DFT-s-OFDM BPSK	1@0	see graph	---
26	15	20	164800	824.0	DFT-s-OFDM BPSK	1@0	see graph	PASS
26	15	20	164800	824.0	DFT-s-OFDM QPSK	1@0	see graph	---
26	15	20	164800	824.0	DFT-s-OFDM QPSK	1@0	see graph	PASS



N26(5M)_DFT-s-OFDM_BPSK_Edge_1RB_Left_Low_CH

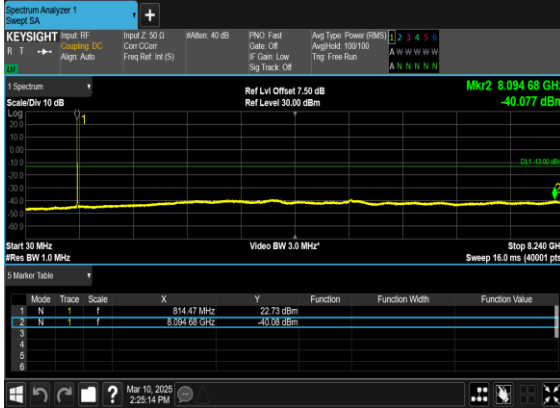

N26(5M)_DFT-s-OFDM_QPSK_Edge_1RB_Left_Low_CH



N26(5M)_DFT-s-OFDM_BPSK_Edge_1RB_Left_Mid_CH



N26(5M)_DFT-s-OFDM_QPSK_Edge_1RB_Left_Mid_CH





N26(5M)_DFT-s-OFDM_BPSK_Edge_1RB_Left_High_CH

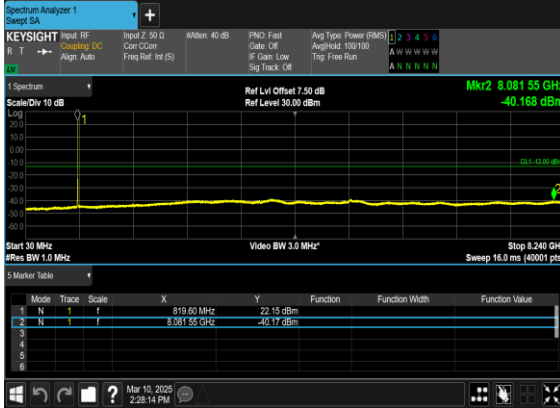

N26(5M)_DFT-s-OFDM_QPSK_Edge_1RB_Left_High_CH



N26(10M)_DFT-s-OFDM_BPSK_Edge_1RB_Left_Mid_CH



N26(10M)_DFT-s-OFDM_QPSK_Edge_1RB_Left_Mid_CH





N26(20M)_DFT-s-OFDM_BPSK_Edge_1RB_Left_Mid_CH



N26(20M)_DFT-s-OFDM_QPSK_Edge_1RB_Left_Mid_CH

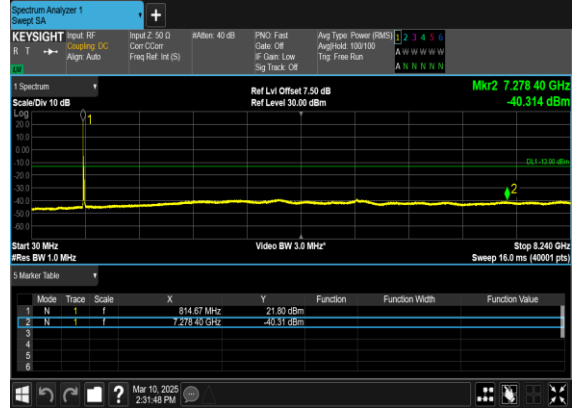



Conducted Band Edge

NR Band	SCS (kHz)	Bandwidth (MHz)	Arfcn	Freq (MHz)	Modulation	RB	Result	Verdict
26	15	5	163300	816.5	DFT-s-OFDM BPSK	1@0	see graph	PASS
26	15	5	163300	816.5	DFT-s-OFDM QPSK	1@0	see graph	PASS
26	15	5	163300	816.5	DFT-s-OFDM BPSK	25@0	see graph	PASS
26	15	5	163300	816.5	DFT-s-OFDM QPSK	25@0	see graph	PASS
26	15	5	164300	821.5	DFT-s-OFDM BPSK	1@24	see graph	PASS
26	15	5	164300	821.5	DFT-s-OFDM QPSK	1@24	see graph	PASS
26	15	5	164300	821.5	DFT-s-OFDM BPSK	25@0	see graph	PASS
26	15	5	164300	821.5	DFT-s-OFDM QPSK	25@0	see graph	PASS
26	15	10	163800	819.0	DFT-s-OFDM BPSK	1@0	see graph	PASS
26	15	10	163800	819.0	DFT-s-OFDM QPSK	1@0	see graph	PASS
26	15	10	163800	819.0	DFT-s-OFDM BPSK	1@51	see graph	PASS
26	15	10	163800	819.0	DFT-s-OFDM QPSK	1@51	see graph	PASS
26	15	10	163800	819.0	DFT-s-OFDM BPSK	50@0	see graph	PASS
26	15	10	163800	819.0	DFT-s-OFDM QPSK	50@0	see graph	PASS
26	15	20	164800	824.0	DFT-s-OFDM BPSK	1@0	see graph	PASS
26	15	20	164800	824.0	DFT-s-OFDM QPSK	1@0	see graph	PASS
26	15	20	164800	824.0	DFT-s-OFDM BPSK	1@105	see graph	PASS
26	15	20	164800	824.0	DFT-s-OFDM QPSK	1@105	see graph	PASS
26	15	20	164800	824.0	DFT-s-OFDM BPSK	100@0	see graph	PASS
26	15	20	164800	824.0	DFT-s-OFDM QPSK	100@0	see graph	PASS



N26(5M)_DFT-s-OFDM_BPSK_Edge_1RB_Left_Low_CH

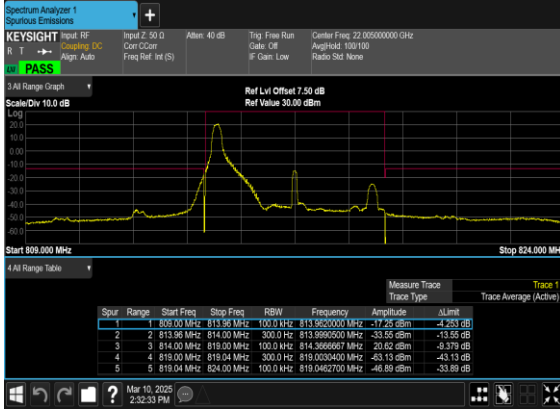

N26(5M)_DFT-s-OFDM_QPSK_Edge_1RB_Left_Low_CH

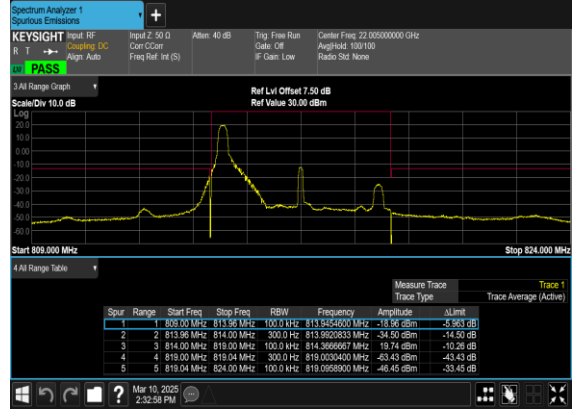

N26(5M)_DFT-s-OFDM_BPSK_Outer_Full_Low_CH

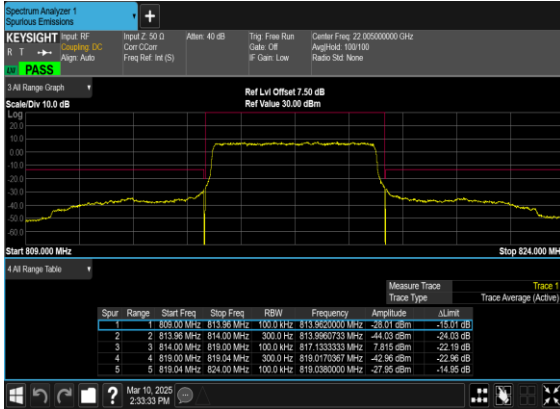

N26(5M)_DFT-s-OFDM_QPSK_Outer_Full_Low_CH

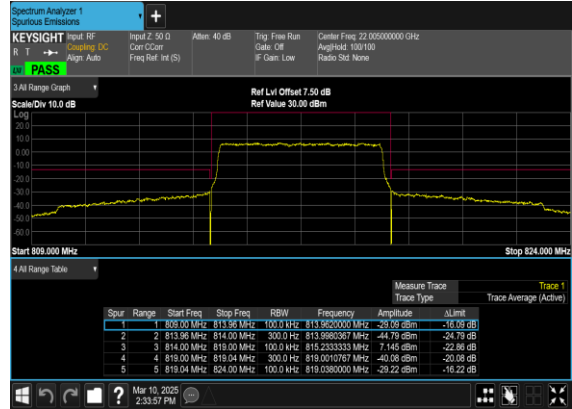



N26(5M)_DFT-s-OFDM_BPSK_Edge_1RB_Right_High_CH

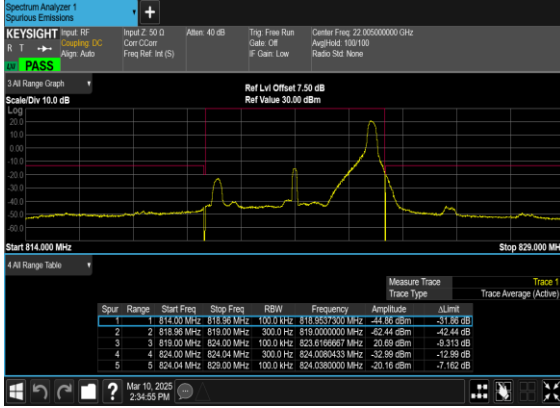

N26(5M)_DFT-s-OFDM_QPSK_Edge_1RB_Right_High_CH

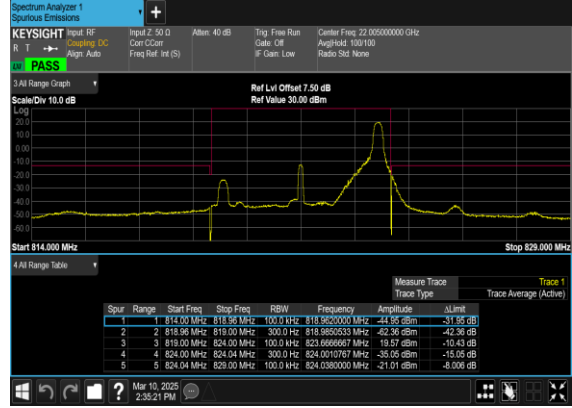

N26(5M)_DFT-s-OFDM_BPSK_Outer_Full_High_CH

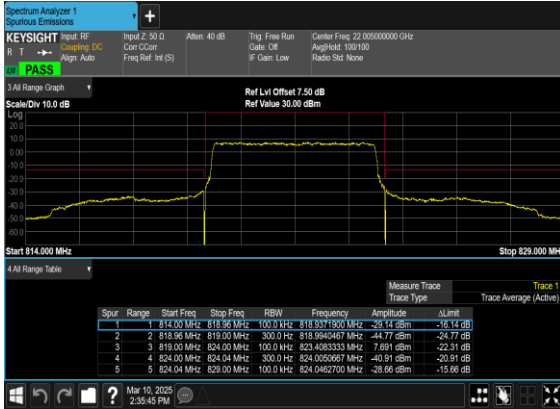

N26(5M)_DFT-s-OFDM_QPSK_Outer_Full_High_CH

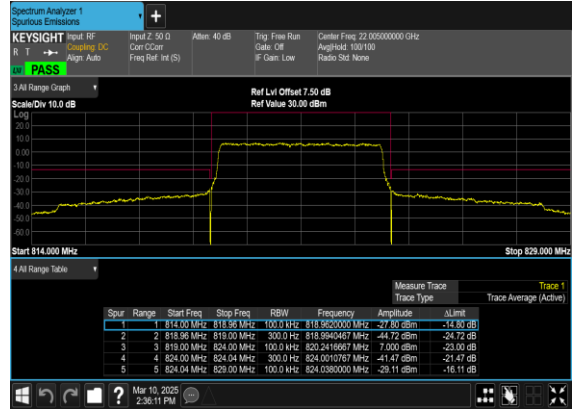



N26(10M)_DFT-s-OFDM_BPSK_Edge_1RB_Left_Mid_CH

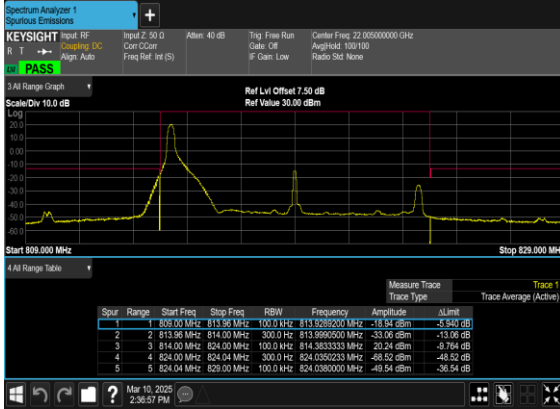

N26(10M)_DFT-s-OFDM_QPSK_Edge_1RB_Left_Mid_CH

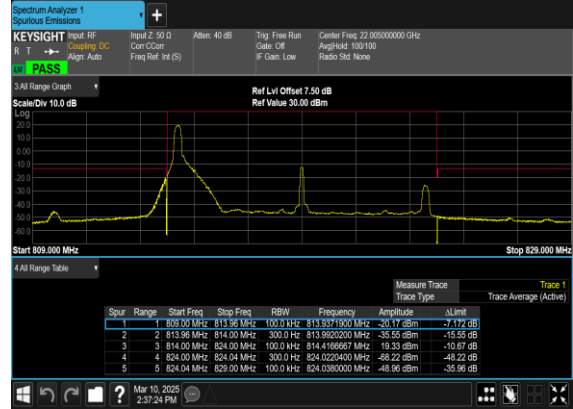

N26(10M)_DFT-s-OFDM_BPSK_Edge_1RB_Right_Mid_CH

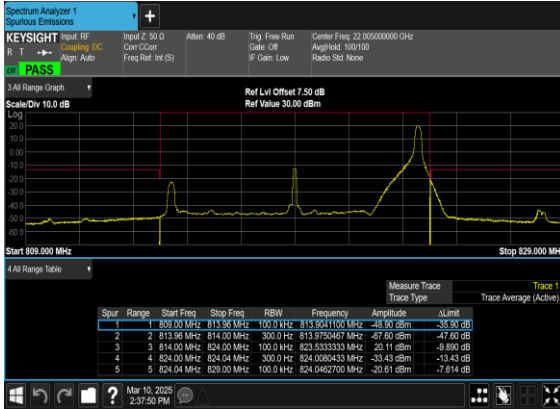

N26(10M)_DFT-s-OFDM_QPSK_Edge_1RB_Right_Mid_CH

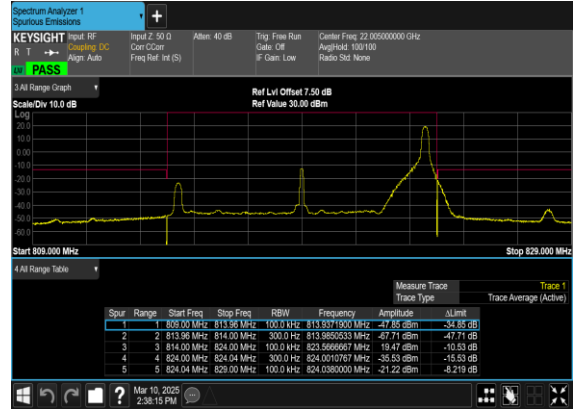



N26(10M)_DFT-s-OFDM_BPSK_Outer_Full_Mid_CH

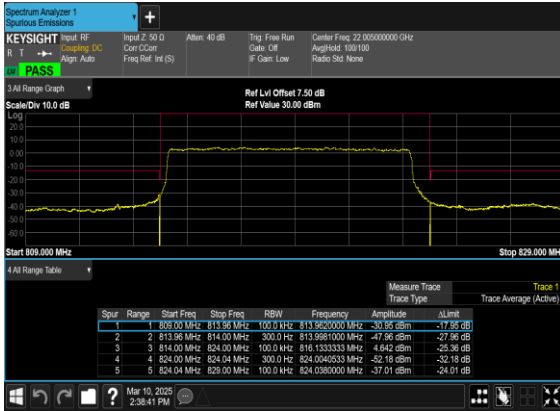

N26(10M)_DFT-s-OFDM_QPSK_Outer_Full_Mid_CH

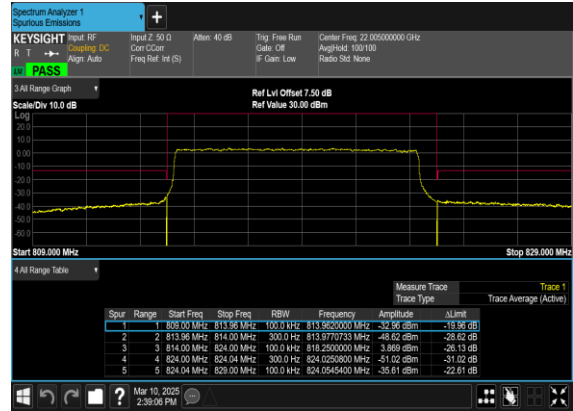

N26(20M)_DFT-s-OFDM_BPSK_Edge_1RB_Left_Mid_CH

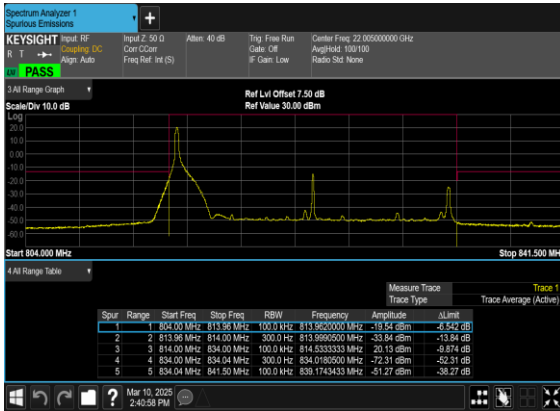

N26(20M)_DFT-s-OFDM_QPSK_Edge_1RB_Left_Mid_CH

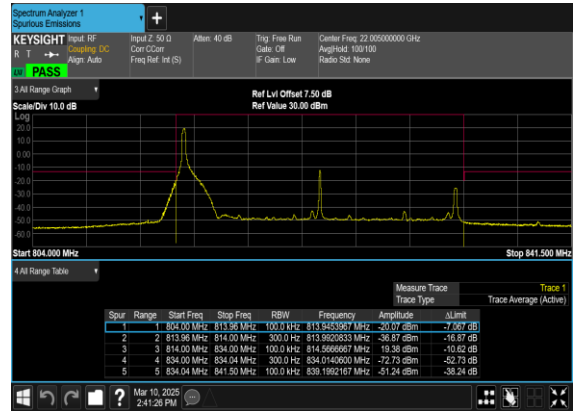



N26(20M)_DFT-s-OFDM_BPSK_Edge_1RB_Right_Mid_CH

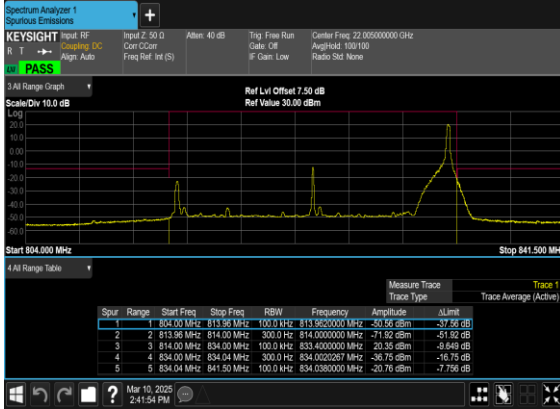

N26(20M)_DFT-s-OFDM_QPSK_Edge_1RB_Right_Mid_CH

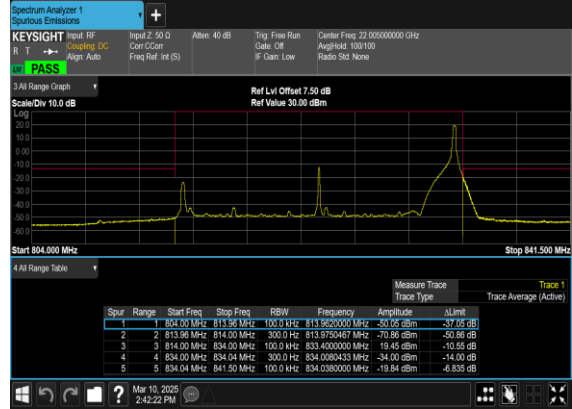

N26(20M)_DFT-s-OFDM_BPSK_Outer_Full_Mid_CH

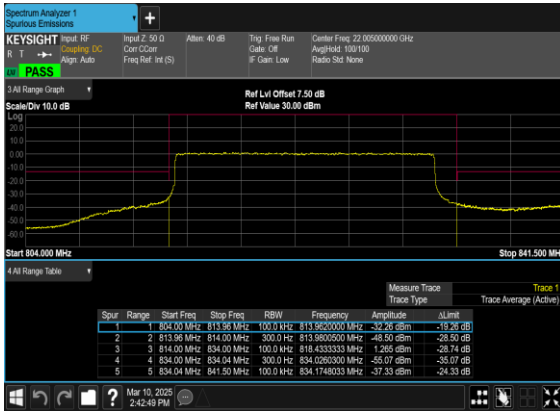

N26(20M)_DFT-s-OFDM_QPSK_Outer_Full_Mid_CH

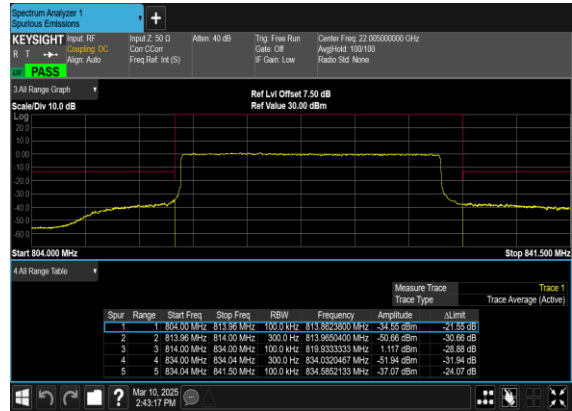



Appendix B. Test Results of Radiated Test

Radiated Spurious Emission

Test Engineer :	Kuang Jia	Temperature :	22~25°C
		Relative Humidity :	48~52%

N26 SA / NR 20MHz / QPSK(ANT0)									
Channel	Frequency (MHz)	ERP (dBm)	Limit (dBm)	Over Limit (dB)	SPA Reading (dBm)	S.G. Power (dBm)	TX Cable loss (dB)	TX Antenna Gain (dBi)	Polarization (H/V)
Lowest	1628.4	-65.86	-13	-52.86	-75.74	-69.09	3.98	9.36	H
	2442.6	-63.09	-13	-50.09	-77.63	-66.64	4.85	10.55	H
	3256.8	-61.62	-13	-48.62	-78.46	-66.55	5.50	12.58	H
	1628.4	-66.09	-13	-53.09	-75.87	-69.32	3.98	9.36	V
	2442.6	-62.98	-13	-49.98	-77.50	-66.53	4.85	10.55	V
	3256.8	-61.67	-13	-48.67	-78.37	-66.60	5.50	12.58	V
Middle	1630	-65.78	-13	-52.78	-75.66	-69.03	4.00	9.40	H
	2445	-63.16	-13	-50.16	-77.70	-66.73	4.88	10.60	H
	3260	-61.45	-13	-48.45	-78.29	-66.38	5.52	12.60	H
	1630	-65.77	-13	-52.77	-75.55	-69.02	4.00	9.40	V
	2445	-63.02	-13	-50.02	-77.54	-66.59	4.88	10.60	V
	3260	-61.56	-13	-48.56	-78.26	-66.49	5.52	12.60	V
Highest	1638.4	-65.92	-13	-52.92	-75.83	-69.09	4.10	9.42	H
	2457.6	-62.87	-13	-49.87	-77.38	-66.45	4.90	10.63	H
	3276.8	-61.85	-13	-48.85	-78.52	-66.77	5.55	12.62	H
	1638.4	-66.03	-13	-53.03	-75.68	-69.20	4.10	9.42	V
	2457.6	-63.18	-13	-50.18	-77.66	-66.76	4.90	10.63	V
	3276.8	-61.67	-13	-48.67	-78.17	-66.59	5.55	12.62	V

Remark: Spurious emissions within 30-1000MHz were found more than 20dB below limit line.