



FCC RF Test Report

APPLICANT : Motorola Mobility LLC
EQUIPMENT : Mobile Cellular Phone
BRAND NAME : Motorola
MODEL NAME : XT2519-1, XT2519-2, XT2519V
FCC ID : IHDT56AU6
STANDARD : 47 CFR Part 27 Subpart Q
CLASSIFICATION : PCS Licensed Transmitter Held to Ear (PCE)
TEST DATE(S) : Jan. 16, 2025 ~ Feb. 17, 2025

We, Sporton International Inc. (Kunshan), would like to declare that the tested sample has been evaluated in accordance with the procedures given in ANSI C63.26-2015 and shown compliance with the applicable technical standards.

This report contains data that were produced under subcontract by Sporton International Inc. (ShenZhen)

The test results in this report apply exclusively to the tested model / sample. Without written approval of Sporton International Inc. (Kunshan), the test report shall not be reproduced except in full.

Jason Jia

Approved by: Jason Jia



Sporton International Inc. (Kunshan)

**No. 1098, Pengxi North Road, Kunshan Economic Development Zone Jiangsu Province 215300
People's Republic of China**



TABLE OF CONTENTS

REVISION HISTORY..... 3
SUMMARY OF TEST RESULT 4
1 GENERAL DESCRIPTION 5
1.1 Applicant 5
1.2 Manufacturer 5
1.3 Product Feature of Equipment Under Test 5
1.4 Product Specification of Equipment Under Test 5
1.5 Modification of EUT 6
1.6 Maximum EIRP Power and Emission Designator 6
1.7 Testing Site 6
1.8 Test Software 7
1.9 Applied Standards 7
1.10 Specification of Accessory 8
2 TEST CONFIGURATION OF EQUIPMENT UNDER TEST 9
2.1 Test Mode 9
2.2 Connection Diagram of Test System 10
2.3 Support Unit used in test configuration and system 10
2.4 Measurement Results Explanation Example 10
2.5 Frequency List of Low/Middle/High Channels 11
3 CONDUCTED TEST ITEMS 12
3.1 Measuring Instruments 12
3.2 Test Setup 12
3.3 Test Result of Conducted Test 12
3.4 Conducted Output Power Measurement 13
3.5 Peak-to-Average Ratio 14
3.6 EIRP 15
3.7 Occupied Bandwidth 16
3.8 Conducted Band Edge Measurement 17
3.9 Conducted Spurious Emission Measurement 18
3.10 Frequency Stability Measurement 19
4 RADIATED TEST ITEMS 20
4.1 Measuring Instruments 20
4.2 Test Setup 20
4.3 Test Result of Radiated Test 21
4.4 Radiated Spurious Emission Measurement 22
5 LIST OF MEASURING EQUIPMENT 23
6 MEASUREMENT UNCERTAINTY 24
APPENDIX A. TEST RESULTS OF CONDUCTED TEST
APPENDIX B. TEST RESULTS OF RADIATED TEST
APPENDIX C. TEST SETUP PHOTOGRAPHS



SUMMARY OF TEST RESULT

Report Section	FCC Rule	Description	Limit	Result	Remark
3.4	§2.1046	Conducted Output Power	—	Report Only	-
3.5	§27.50 (k)(4)	Peak-to-Average Ratio	<13dB	PASS	
3.6	§27.50 (k)(3)	EIRP	EIRP < 1W (30dBm)	PASS	-
3.7	§2.1049	Occupied Bandwidth	—	Report Only	-
3.8	§2.1051 §27.53 (n)(2)	Conducted Band Edge Measurement	-13dBm/MHz	PASS	-
3.9	§2.1051 §27.53 (n)(2)	Conducted Spurious Emission	-13dBm/MHz	PASS	-
3.10	§2.1055 §27.54	Frequency Stability Temperature & Voltage	Within the band	PASS	-
4.4	§2.1053 §27.53 (n)(2)	Radiated Spurious Emission	-13dBm/MHz	PASS	Under limit 29.37 dB at 10473.00 MHz

Conformity Assessment Condition:

- The test results (PASS/FAIL) with all measurement uncertainty excluded are presented against the regulation limits or in accordance with the requirements stipulated by the applicant/manufacture who shall bear all the risks of non-compliance that may potentially occur if measurement uncertainty is taken into account.
- The measurement uncertainty please refer to each test result in the section "Measurement Uncertainty"

Disclaimer:

The product specifications of the EUT presented in the test report that may affect the test assessments are declared by the manufacturer who shall take full responsibility for the authenticity.



1 General Description

1.1 Applicant

Motorola Mobility LLC
222 W,Merchandise Mart Plaza, Chicago IL 60654 USA

1.2 Manufacturer

Motorola Mobility LLC
222 W,Merchandise Mart Plaza, Chicago IL 60654 USA

1.3 Product Feature of Equipment Under Test

Product Feature	
Equipment	Mobile Cellular Phone
Brand Name	Motorola
Model Name	XT2519-1, XT2519-2, XT2519V
FCC ID	IHDT56AU6
IMEI Code	Conducted: 355782390039091/355782390039109 Radiation: 355782390037798/355782390037806
HW Version	DVT2
SW Version	V2VD35.27
EUT Stage	Identical Prototype

Remark:

1. The above EUT's information was declared by manufacturer. Please refer to the specifications or user's manual for more detailed description.
2. The different model name is different for market purpose.

1.4 Product Specification of Equipment Under Test

Product Feature	
Tx/Rx Frequency	LTE Band 42: 3450 MHz ~ 3550 MHz
Bandwidth	5MHz / 10MHz / 15MHz / 20MHz
Maximum Output Power to Antenna	LTE Band 42 : 23.15 dBm for Ant.2 LTE Band 42 : 23.04 dBm for Ant.4 LTE Band 42 : 21.92 dBm for Ant.6 LTE Band 42 : 20.67 dBm for Ant.7
Antenna Gain	LTE Band 42 : -4.5 dBi for Ant.2 LTE Band 42 : -5.3 dBi for Ant.4 LTE Band 42 : -4.9 dBi for Ant.6 LTE Band 42 : -5.0 dBi for Ant.7
Type of Modulation	QPSK / 16QAM / 64QAM / 256QAM

Note: The maximum EIRP is calculated from max output power and max antenna gain, so only the maximum EIRP of Antenna 2 for LTE Band42 are shown in the report.

1.5 Modification of EUT

No modifications are made to the EUT during all test items.

1.6 Maximum EIRP Power and Emission Designator

LTE Band 42		QPSK		16QAM/64QAM/256QAM	
BW (MHz)	Frequency Range (MHz)	Maximum EIRP(W)	Emission Designator (99%OBW)	Maximum EIRP(W)	Emission Designator (99%OBW)
5	3452.5 ~ 3547.5	0.0718	4M50G7D	0.0611	4M48W7D
10	3455 ~ 3545	0.0724	8M99G7D	0.0610	9M01W7D
15	3457.5 ~ 3542.5	0.0724	13M4G7D	0.0607	13M5W7D
20	3460 ~ 3540	0.0733	17M8G7D	0.0621	17M9W7D

1.7 Testing Site

Sporton International Inc. (Kunshan) is accredited to ISO/IEC 17025:2017 by American Association for Laboratory Accreditation with Certificate Number 5145.02.

Test Firm	Sporton International Inc. (Kunshan)		
Test Site Location	No. 1098, Pengxi North Road, Kunshan Economic Development Zone Jiangsu Province 215300 People's Republic of China TEL : +86-512-57900158		
Test Site No.	Sporton Site No.	FCC Designation No.	FCC Test Firm Registration No.
	TH01-KS	CN1257	314309



Sporton International Inc. (ShenZhen) is accredited to ISO/IEC 17025:2017 by American Association for Laboratory Accreditation with Certificate Number 5145.01.

Test Firm	Sporton International Inc. (ShenZhen)		
Test Site Location	101, 1st Floor, Block B, Building 1, No. 2, Tengfeng 4th Road, Fenghuang Community, Fuyong Street, Baoan District, Shenzhen City, Guangdong Province 518103 People's Republic of China TEL: +86-755-86066985		
Test Site No.	Sporton Site No.	FCC Designation No.	FCC Test Firm Registration No.
	03CH03-SZ	CN1256	421272

Test data subcontracted: Radiated Spurious Emission test case in section 4 of this report

1.8 Test Software

Item	Site	Manufacture	Name	Version
1.	03CH03-SZ	AUDIX	E3	6.2009-8-24

1.9 Applied Standards

According to the specifications of the manufacturer, the EUT must comply with the requirements of the following standards:

- ♦ 47 CFR Part 27 Subpart Q
- ♦ ANSI C63.26-2015
- ♦ FCC KDB 971168 Power Meas License Digital Systems D01 v03r01
- ♦ FCC KDB 412172 D01 Determining ERP and EIRP v01r01
- ♦

Remark:

1. All test items were verified and recorded according to the standards and without any deviation during the test.
2. This EUT has also been tested and complied with the requirements of FCC Part 15, Subpart B, recorded in a separate test report.



1.10 Specification of Accessory

Accessories Information				
Battery	Brand Name	Motorola(ATL)	Model Name	RM52
USB Cable 1	Brand Name	Motorola(saibao)	Model Name	SC18D86731
USB Cable 2	Brand Name	Motorola(Luxshare)	Model Name	SC18E08103

2 Test Configuration of Equipment Under Test

2.1 Test Mode

Antenna port conducted and radiated test items listed below are performed according to KDB 971168 D01 Power Meas. License Digital Systems v03r01 with maximum output power.

Radiated measurements are performed by rotating the EUT in three different orthogonal test planes to find the maximum emission. (Z Plane)

Test Cases	Band	Bandwidth (MHz)	Modulation	RB #	Test Channel
		eg. 5M, 10M, 15M, 20M	eg. QPSK, 16QAM, 64QAM, 256QAM	1RB, Partial RB, Full RB	L/M/H
Max. Output Power	LTE Band 42	5M, 10M, 15M, 20M	QPSK, 16QAM, 64QAM, 256QAM	1RB, Partial RB, Full RB	L, M, H
Peak-to-Average Ratio	LTE Band 42	20M	QPSK, 16QAM, 64QAM	Full RB	M
E.I.R.P	LTE Band 42	5M, 10M, 15M, 20M	QPSK, 16QAM, 64QAM, 256QAM	1RB, Partial RB, Full RB	L, M, H
26dB and 99% Bandwidth	LTE Band 42	20M	QPSK, 16QAM	Full RB	M
Conducted Band Edge	LTE Band 42	5M, 10M, 15M, 20M	QPSK, 16QAM, 64QAM	1RB, Full RB	L, H
Conducted Spurious Emission	LTE Band 42	5M, 10M, 15M, 20M	QPSK	1RB	L, M, H
Frequency Stability	LTE Band 42	5M	QPSK	1RB	M
Radiated Spurious Emission	LTE Band 42	Worst case from maximum power			L, M, H

Note:

The device is investigated from 30MHz to 10 times of fundamental signal for radiated spurious emission test under different RB size/offset and modulations in exploratory test. Subsequently, only the worst case emissions are reported.

2.2 Connection Diagram of Test System

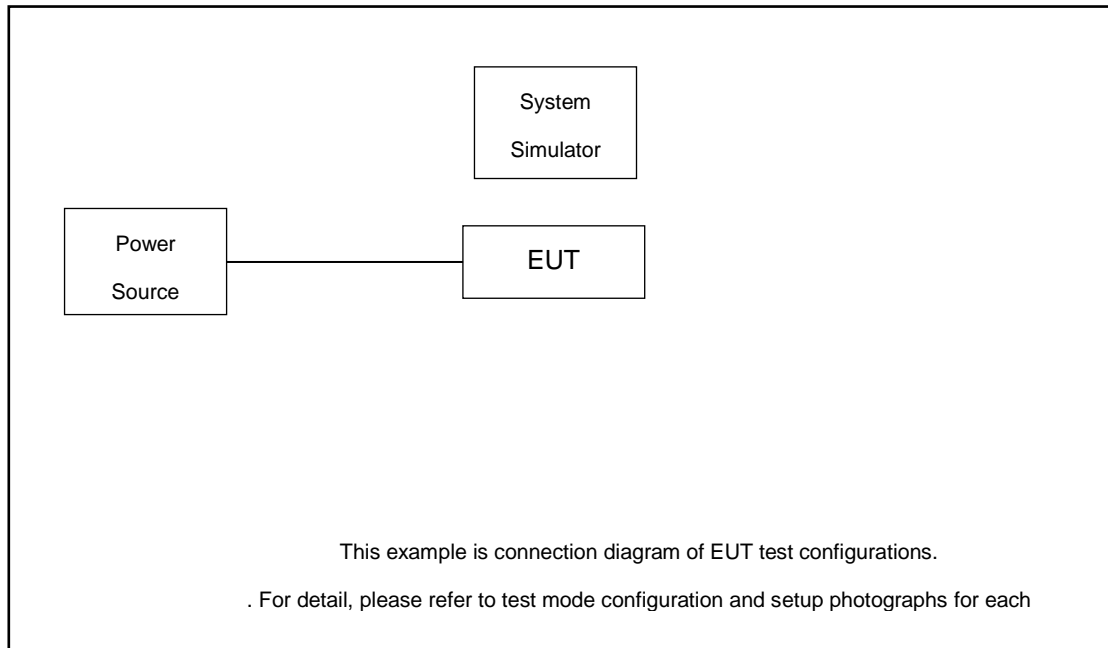

2.3 Support Unit used in test configuration and system

Item	Equipment	Trade Name	Model No.	FCC ID	Data Cable	Power Cord
1.	Power Supply	GWINSTEK	PSS-2002	N/A	N/A	Unshielded, 1.8 m
2.	LTE Base Station	Anritsu	MT8820C	N/A	N/A	Unshielded, 1.8 m

2.4 Measurement Results Explanation Example

For all conducted test items:

The offset level is set in the spectrum analyzer to compensate the RF cable loss and attenuator factor between EUT conducted output port and spectrum analyzer. With the offset compensation, the spectrum analyzer reading level is exactly the EUT RF output level.

The spectrum analyzer offset is derived from RF cable loss and attenuator factor.

Offset = RF cable loss + attenuator factor.

Following shows an offset computation example with cable loss 5.5 dB and 10dB attenuator.

Example :

$$\begin{aligned} \text{Offset(dB)} &= \text{RF cable loss(dB)} + \text{attenuator factor(dB)}. \\ &= 5.5 + 10 = 15.5 \text{ (dB)} \end{aligned}$$



2.5 Frequency List of Low/Middle/High Channels

LTE Band 42 Channel and Frequency List				
BW [MHz]	Channel/Frequency(MHz)	Lowest	Middle	Highest
20	Channel	42190	42590	42990
	Frequency	3460	3500	3540
15	Channel	42165	42590	43015
	Frequency	3457.5	3500	3542.5
10	Channel	42140	42590	43040
	Frequency	3455	3500	3545
5	Channel	42115	42590	43065
	Frequency	3452.5	3500	3547.5

3 Conducted Test Items

3.1 Measuring Instruments

See list of measuring instruments of this test report.

3.2 Test Setup

3.2.1 Conducted Output Power

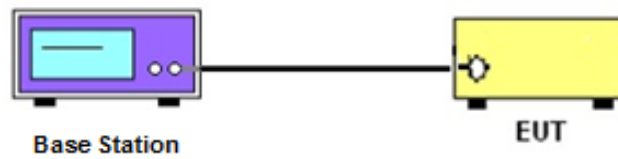

3.2.2 Peak-to-Average Ratio, Occupied / 26dB Bandwidth ,Band-Edge and Conducted Spurious Emission

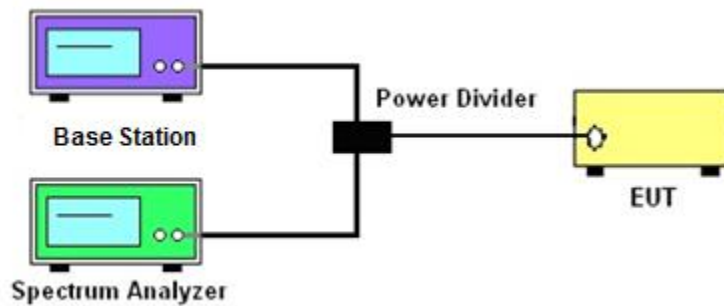

3.2.3 Frequency Stability

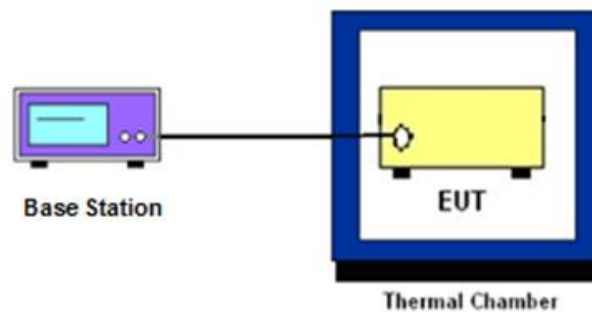

3.3 Test Result of Conducted Test

Please refer to Appendix A.



3.4 Conducted Output Power Measurement

3.4.1 Description of the Conducted Output Power Measurement

A base station simulator was used to establish communication with the EUT. Its parameters were set to transmit the maximum power on the EUT. The measured power in the radio frequency on the transmitter output terminals shall be reported.

3.4.2 Test Procedures

1. The testing follows ANSI C63.26 Section 5.2
2. The transmitter output port was connected to the system simulator.
3. Set EUT at maximum power through the system simulator.
4. Select lowest, middle, and highest channels for each band and different modulation.
5. Measure and record the power level from the system simulator.

3.5 Peak-to-Average Ratio

3.5.1 Description of the PAR Measurement

Power Complementary Cumulative Distribution Function (CCDF) curves provide a means for characterizing the power peaks of a digitally modulated signal on a statistical basis. A CCDF curve depicts the probability of the peak signal amplitude exceeding the average power level. Most contemporary measurement instrumentation include the capability to produce CCDF curves for an input signal provided that the instrument's resolution bandwidth can be set wide enough to accommodate the entire input signal bandwidth. In measuring transmissions in this band using an average power technique, the peak-to-average ratio (PAR) of the transmission may not exceed 13 dB.

3.5.2 Test Procedures

1. The testing follows ANSI C63.26 Section 5.2.3.4 (CCDF).
2. The EUT was connected to spectrum and system simulator via a power divider.
3. Set the CCDF (Complementary Cumulative Distribution Function) option in spectrum analyzer.
4. The highest RF powers were measured and recorded the maximum PAPR level associated with a probability of 0.1 %.
5. Record the deviation as Peak to Average Ratio.

3.6 EIRP

3.6.1 Description of EIRP Limit

§ 27.50 (k)(3)

Mobile devices are limited to 1Watt (30 dBm) EIRP. Mobile devices operating in these bands must employ a means for limiting power to the minimum necessary for successful communications

3.6.2 Test Procedures

1. According to KDB 412172 D01 Power Approach,
2. $EIRP = P_T + G_T - L_C$, $ERP = EIRP - 2.15$, where
 P_T = transmitter output power in dBm
 G_T = gain of the transmitting antenna in dBi
 L_C = signal attenuation in the connecting cable between the transmitter and antenna in dB

3.7 Occupied Bandwidth

3.7.1 Description of Occupied Bandwidth Measurement

The occupied bandwidth is the width of a frequency band such that, below the lower and above the upper frequency limits, the mean powers emitted are each equal to a specified percentage 0.5% of the total mean transmitted power.

The 26 dB emission bandwidth is defined as the frequency range between two points, one above and one below the carrier frequency, at which the spectral density of the emission is attenuated 26 dB below the maximum in-band spectral density of the modulated signal. Spectral density (power per unit bandwidth) is to be measured with a detector of resolution bandwidth equal to approximately 1.0% of the emission bandwidth.

3.7.2 Test Procedures

1. The testing follows ANSI C63.26 Section 5.4
2. The EUT was connected to spectrum analyzer and system simulator via a power divider.
3. The spectrum analyzer center frequency is set to the nominal EUT channel center frequency. The span range for the spectrum analyzer shall be between two and five times the anticipated OBW.
4. The nominal resolution bandwidth (RBW) shall be in the range of 1 to 5 % of the anticipated OBW, and the VBW shall be at least 3 times the RBW.
5. Set the detection mode to peak, and the trace mode to max hold.
6. Determine the reference value: Set the EUT to transmit a modulated signal. Allow the trace to stabilize. Set the spectrum analyzer marker to the highest level of the displayed trace.
(this is the reference value)
7. Determine the “-26 dB down amplitude” as equal to (Reference Value – X).
8. Place two markers, one at the lowest and the other at the highest frequency of the envelope of the spectral display such that each marker is at or slightly below the “-X dB down amplitude” determined in step 6. If a marker is below this “-X dB down amplitude” value it shall be placed as close as possible to this value. The OBW is the positive frequency difference between the two markers.
9. Use the 99 % power bandwidth function of the spectrum analyzer and report the measured bandwidth.

3.8 Conducted Band Edge Measurement

3.8.1 Description of Conducted Band Edge Measurement

§ 27.53 (n)(2)

For mobile operations in the 3450-3550 MHz band, the conducted power of any emission outside the licensee's authorized bandwidth shall not exceed -13 dBm/MHz.

Compliance with this paragraph is based on the use of measurement instrumentation employing a resolution bandwidth of 1 megahertz or greater. However, in the 1 megahertz bands immediately outside and adjacent to the licensee's frequency block, a resolution bandwidth of at least one percent of the emission bandwidth of the fundamental emission of the transmitter may be employed, but limited to a maximum of 200 kHz. In the bands between 1 and 5 MHz removed from the licensee's frequency block, the minimum resolution bandwidth for the measurement shall be 500 kHz.

3.8.2 Test Procedures

1. The testing follows ANSI C63.26 section 5.7
2. The EUT was connected to spectrum analyzer and system simulator via a power divider.
3. The band edges of low and high channels for the highest RF powers were measured.
4. Set RBW $\geq 1\%$ EBW but limited to a maximum of 200 kHz in the 1MHz band immediately outside and adjacent to the band edge.
5. Beyond the 1 MHz and 5 MHz removed from the band edge, set RBW ≥ 500 KHz.
6. Beyond the 5 MHz removed from the band edge, set RBW = 1MHz.
7. Set spectrum analyzer with RMS detector.
8. The RF fundamental frequency should be excluded against the limit line in the operating frequency band.
9. Checked that all the results comply with the emission limit line.

3.9 Conducted Spurious Emission Measurement

3.9.1 Description of Conducted Spurious Emission Measurement

The power of any emission outside of the authorized operating frequency ranges shall not exceed -13 dBm/MHz.

It is measured by means of a calibrated spectrum analyzer and scanned from 9 kHz up to a frequency including its 10th harmonic.

3.9.2 Test Procedures

1. The testing follows ANSI C63.26 section 5.7
2. The EUT was connected to spectrum analyzer and system simulator via a power divider.
3. The RF output of EUT was connected to the spectrum analyzer by RF cable and attenuator. The path loss was compensated to the results for each measurement.
4. The middle channel for the highest RF power within the transmitting frequency was measured.
5. The conducted spurious emission for the whole frequency range was taken.
6. Make the measurement with the spectrum analyzer's RBW = 1MHz, VBW = 3MHz.
7. Set spectrum analyzer with RMS detector.
8. Taking the record of maximum spurious emission.
9. The RF fundamental frequency should be excluded against the limit line in the operating frequency band.
10. Checked that all the results comply with the emission limit line.

3.10 Frequency Stability Measurement

3.10.1 Description of Frequency Stability Measurement

The frequency stability shall be measured by variation of ambient temperature and variation of primary supply voltage to ensure that the fundamental emission stays within the authorized frequency block.

3.10.2 Test Procedures for Temperature Variation

1. The testing follows ANSI C63.26 section 5.6.4
2. The EUT was set up in the thermal chamber and connected with the system simulator.
3. With power OFF, the temperature was decreased to -30°C and the EUT was stabilized before testing. Power was applied and the maximum change in frequency was recorded within one minute.
4. With power OFF, the temperature was raised in 10°C step up to 50°C . The EUT was stabilized at each step for at least half an hour. Power was applied and the maximum frequency change was recorded within one minute.

3.10.3 Test Procedures for Voltage Variation

1. The testing follows ANSI C63.26 section 5.6.5.
2. The EUT was placed in a temperature chamber at $20\pm 5^{\circ}\text{C}$ and connected with the system simulator.
3. The power supply voltage to the EUT was varied from 85% to 115% of the nominal value for other than hand carried battery equipment.
4. For hand carried, battery powered equipment, reduce the primary ac or dc supply voltage to the battery operating end point, which shall be specified by the manufacturer.
5. The variation in frequency was measured for the worst case.

4 Radiated Test Items

4.1 Measuring Instruments

See list of measuring instruments of this test report.

4.2 Test Setup

4.2.1 For radiated test below 30MHz

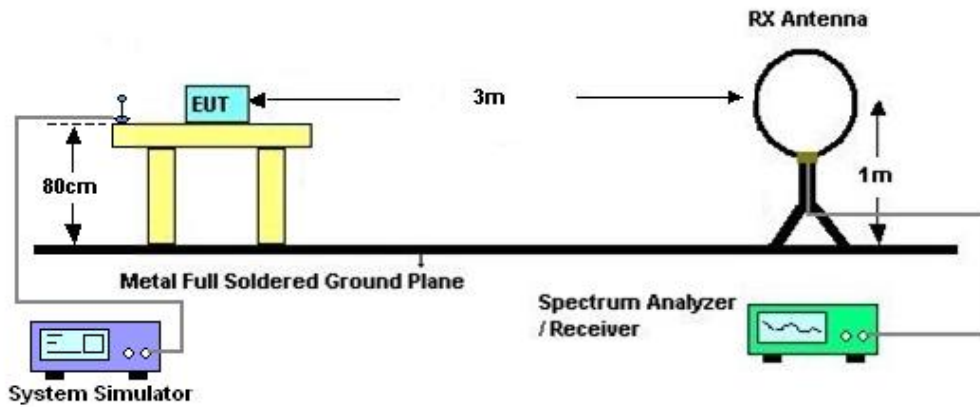

4.2.2 For radiated test from 30MHz to 1GHz

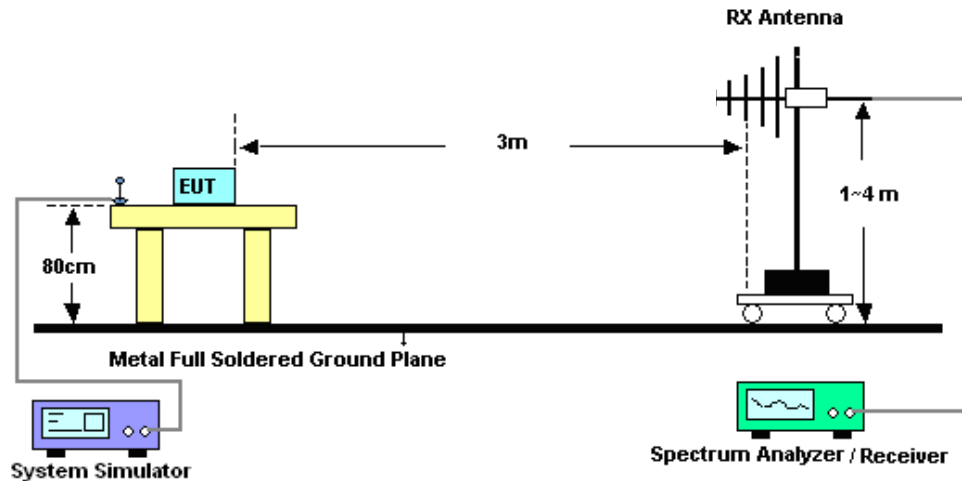

4.2.3 For radiated test above 1GHz

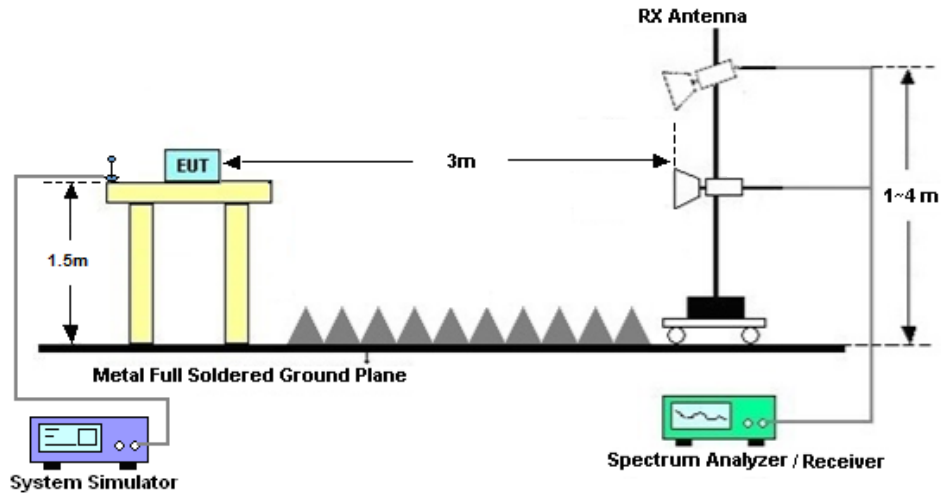

4.3 Test Result of Radiated Test

The low frequency, which started from 9 kHz to 30MHz, was pre-scanned and the result which was 20dB lower than the limit line was not reported.

Please refer to Appendix B.

4.4 Radiated Spurious Emission Measurement

4.4.1 Description of Radiated Spurious Emission

The radiated spurious emission was measured by substitution method according to ANSI C63.26. The power of any emission outside of the authorized operating frequency ranges shall not exceed -13 dBm/MHz.

The spectrum is scanned from 30 MHz up to a frequency including its 10th harmonic.

4.4.2 Test Procedures

1. The testing follows ANSI C63.26 Section 5.5
2. The EUT was placed on a turntable with 0.8 meter height for frequency below 1GHz and 1.5 meter height for frequency above 1GHz respectively above ground.
3. The EUT was set 3 meters from the receiving antenna mounted on the antenna tower.
4. The table was rotated 360 degrees to determine the position of the highest spurious emission.
5. The height of the receiving antenna is varied between 1m to 4m to search the maximum spurious emission for both horizontal and vertical polarizations.
6. During the measurement, the system simulator parameters were set to force the EUT transmitting at maximum output power.
7. Make the measurement with the spectrum analyzer's RBW = 1MHz, VBW = 3MHz, taking the record of maximum spurious emission.
8. A horn antenna was substituted in place of the EUT and was driven by a signal generator.
9. Tune the output power of signal generator to the same emission level with EUT maximum spurious emission.
$$\text{EIRP (dBm)} = \text{S.G. Power} - \text{Tx Cable Loss} + \text{Tx Antenna Gain}$$
$$\text{ERP (dBm)} = \text{EIRP} - 2.15$$
10. The RF fundamental frequency should be excluded against the limit line in the operating frequency band.



5 List of Measuring Equipment

Instrument	Manufacturer	Model No.	Serial No.	Characteristics	Calibration Date	Test Date	Due Date	Remark
Spectrum Analyzer	R&S	FSV40	101040	10Hz~40GHz	Oct. 10, 2024	Jan. 16, 2025~ Jan. 23, 2025	Oct. 09, 2025	Conducted (TH01-KS)
Power divider	STI	STI08-0055	-	0.5~40GHz	NCR	Jan. 16, 2025~ Jan. 23, 2025	NCR	Conducted (TH01-KS)
Temperature & humidity chamber	Hongzhan	LP-150U	H2014011440	-40~+150°C 20%~95%RH	Jul. 04, 2024	Jan. 16, 2025~ Jan. 23, 2025	Jul. 03, 2025	Conducted (TH01-KS)
EMI Test Receiver&SA	KEYSIGHT	N9038A	MY54450083	20Hz~8.4GHz	Apr. 09, 2024	Feb. 17, 2025	Apr. 08, 2025	Radiation (03CH03-SZ)
Loop Antenna	R&S	HFH2-Z2E	101141	9kHz~30MHz	Dec. 28, 2024	Feb. 17, 2025	Dec. 27, 2025	Radiation (03CH03-SZ)
EXA Spectrum Analyzer	KEYSIGHT	N9010A	MY55150246	10Hz~44GHz;	Apr. 09, 2024	Feb. 17, 2025	Apr. 08, 2025	Radiation (03CH03-SZ)
Bilog Antenna	TeseQ	CBL6112D	35408	30MHz-2GHz	Aug. 20, 2023	Feb. 17, 2025	Aug. 19, 2025	Radiation (03CH03-SZ)
Double Ridge Horn Antenna	SCHWARZBECK	BBHA9120D	9120D-1355	1GHz~18GHz	Apr. 09, 2024	Feb. 17, 2025	Apr. 08, 2025	Radiation (03CH03-SZ)
LF Amplifier	Burgeon	BPA-530	102209	0.01~3000Mhz	Apr. 09, 2024	Feb. 17, 2025	Apr. 08, 2025	Radiation (03CH03-SZ)
HF Amplifier	MITEQ	TTA1840-35-HG	1871923	18GHz~40GHz	Jul. 03, 2024	Feb. 17, 2025	Jul. 02, 2025	Radiation (03CH03-SZ)
SHF-EHF Horn	com-power	AH-840	101071	18Ghz-40GHz	Apr. 09, 2024	Feb. 17, 2025	Apr. 08, 2025	Radiation (03CH03-SZ)
AC Power Source	Chroma	61601	616010002729	N/A	Oct. 18, 2024	Feb. 17, 2025	Oct. 17, 2025	Radiation (03CH03-SZ)
Turn Table	EM	EM1000	N/A	0~360 degree	NCR	Feb. 17, 2025	NCR	Radiation (03CH03-SZ)
Antenna Mast	EM	EM1000	N/A	1 m~4 m	NCR	Feb. 17, 2025	NCR	Radiation (03CH03-SZ)

NCR: No Calibration Required

6 Measurement Uncertainty

The measurement uncertainties shown below were calculated in accordance with the requirements of ANSI 63.26-2015. All the measurement uncertainty value were shown with a coverage K=2 to indicate 95% level of confidence. The measurement data show herein meets or exceeds the CISPR measurement uncertainty values specified in CISPR 16-4-2 and can be compared directly to specified limit to determine compliance.

Uncertainty of Conducted Measurement

Test Item	Uncertainty
Conducted Spurious Emission & Bandedge	±2.22 dB
Occupied Channel Bandwidth	±0.1%
Conducted Power	±0.50 dB
Peak to Average Ratio	±0.90 dB
Frequency Stability	±0.04ppm

Uncertainty of Radiated Emission Measurement (30 MHz ~ 1000 MHz)

Measuring Uncertainty for a Level of Confidence of 95% (U = 2Uc(y))	3.0 dB
---	--------

Uncertainty of Radiated Emission Measurement (1 GHz ~ 18 GHz)

Measuring Uncertainty for a Level of Confidence of 95% (U = 2Uc(y))	3.6 dB
---	--------

Uncertainty of Radiated Emission Measurement (18 GHz ~ 40 GHz)

Measuring Uncertainty for a Level of Confidence of 95% (U = 2Uc(y))	3.8 dB
---	--------

----- THE END -----

Appendix A. Test Results of Conducted Test

Test Engineer :	Fly	Temperature :	22~23℃
		Relative Humidity :	40~42%

Conducted Output Power(Average power) and EIRP

LTE Band 42_ANT2:

BW [MHz]	Modulation	RB Size	RB Offset	Power Low Ch. / Freq.	Power Middle Ch. / Freq.	Power High Ch. / Freq.	EIRP(W)		
							L	M	H
Channel				42190	42590	42990			
Frequency (MHz)				3460	3500	3540	L	M	H
20	QPSK	1	0	23.09	23.15	23.00	0.0723	0.0733	0.0708
20	QPSK	1	49	22.92	23.02	22.91	0.0695	0.0711	0.0693
20	QPSK	1	99	22.88	22.96	22.80	0.0689	0.0701	0.0676
20	QPSK	50	0	21.98	22.19	22.11	0.0560	0.0587	0.0577
20	QPSK	50	24	21.97	22.04	21.90	0.0558	0.0568	0.0550
20	QPSK	50	50	21.93	21.98	21.92	0.0553	0.0560	0.0552
20	QPSK	100	0	21.98	22.10	21.99	0.0560	0.0575	0.0561
20	16QAM	1	0	22.31	22.41	22.34	0.0604	0.0618	0.0608
20	16QAM	1	49	22.26	22.35	22.26	0.0597	0.0610	0.0597
20	16QAM	1	99	22.28	22.43	22.26	0.0600	0.0621	0.0597
20	16QAM	50	0	20.97	21.04	20.88	0.0444	0.0451	0.0435
20	16QAM	50	24	20.91	21.07	20.85	0.0438	0.0454	0.0432
20	16QAM	50	50	20.80	20.90	20.94	0.0427	0.0437	0.0441
20	16QAM	100	0	20.90	20.96	20.88	0.0437	0.0443	0.0435
20	64QAM	1	0	21.21	21.27	21.34	0.0469	0.0475	0.0483
20	64QAM	1	49	21.15	21.28	21.19	0.0462	0.0476	0.0467
20	64QAM	1	99	21.08	21.15	21.28	0.0455	0.0462	0.0476
20	64QAM	50	0	20.00	19.97	19.96	0.0355	0.0352	0.0352
20	64QAM	50	24	19.92	19.89	19.83	0.0348	0.0346	0.0341
20	64QAM	50	50	19.94	19.83	19.86	0.0350	0.0341	0.0344
20	64QAM	100	0	19.91	19.95	19.84	0.0348	0.0351	0.0342
20	256QAM	1	0	18.14	18.17	18.14	0.0231	0.0233	0.0231
20	256QAM	1	49	18.07	18.16	18.07	0.0228	0.0232	0.0228
20	256QAM	1	99	18.11	18.14	18.12	0.0230	0.0231	0.0230
20	256QAM	50	0	17.88	17.97	17.90	0.0218	0.0222	0.0219
20	256QAM	50	24	17.80	17.89	17.75	0.0214	0.0218	0.0211
20	256QAM	50	50	17.85	17.90	17.80	0.0216	0.0219	0.0214
20	256QAM	100	0	18.00	18.01	17.88	0.0224	0.0224	0.0218
Channel				42165	42590	43015	EIRP(W)		
Frequency (MHz)				3457.5	3500	3542.5	L	M	H
15	QPSK	1	0	23.02	23.10	22.87	0.0711	0.0724	0.0687
15	QPSK	1	37	22.82	22.94	22.80	0.0679	0.0698	0.0676



15	QPSK	1	74	22.76	22.92	22.70	0.0670	0.0695	0.0661
15	QPSK	36	0	21.93	22.13	22.06	0.0553	0.0579	0.0570
15	QPSK	36	20	21.93	21.99	21.85	0.0553	0.0561	0.0543
15	QPSK	36	39	21.79	21.86	21.88	0.0536	0.0545	0.0547
15	QPSK	75	0	21.87	21.98	21.92	0.0546	0.0560	0.0552
15	16QAM	1	0	22.26	22.33	22.27	0.0597	0.0607	0.0598
15	16QAM	1	37	22.19	22.27	22.22	0.0587	0.0598	0.0592
15	16QAM	1	74	22.16	22.31	22.20	0.0583	0.0604	0.0589
15	16QAM	36	0	20.83	20.91	20.77	0.0430	0.0438	0.0424
15	16QAM	36	20	20.83	20.94	20.82	0.0430	0.0441	0.0429
15	16QAM	36	39	20.68	20.87	20.80	0.0415	0.0434	0.0427
15	16QAM	75	0	20.83	20.92	20.78	0.0430	0.0439	0.0425
15	64QAM	1	0	21.16	21.13	21.31	0.0463	0.0460	0.0480
15	64QAM	1	37	21.05	21.19	21.09	0.0452	0.0467	0.0456
15	64QAM	1	74	21.00	21.07	21.18	0.0447	0.0454	0.0466
15	64QAM	36	0	19.93	19.92	19.83	0.0349	0.0348	0.0341
15	64QAM	36	20	19.81	19.83	19.72	0.0340	0.0341	0.0333
15	64QAM	36	39	19.90	19.73	19.75	0.0347	0.0333	0.0335
15	64QAM	75	0	19.85	19.92	19.81	0.0343	0.0348	0.0340
15	256QAM	1	0	18.03	18.10	18.04	0.0225	0.0229	0.0226
15	256QAM	1	37	18.00	18.09	18.00	0.0224	0.0229	0.0224
15	256QAM	1	74	18.05	18.12	18.02	0.0226	0.0230	0.0225
15	256QAM	36	0	17.80	17.91	17.87	0.0214	0.0219	0.0217
15	256QAM	36	20	17.75	17.82	17.70	0.0211	0.0215	0.0209
15	256QAM	36	39	17.71	17.77	17.76	0.0209	0.0212	0.0212
15	256QAM	75	0	17.87	17.93	17.75	0.0217	0.0220	0.0211
Channel				42140	42590	43040	EIRP(W)		
Frequency (MHz)				3455	3500	3545	L	M	H
10	QPSK	1	0	22.99	23.10	22.94	0.0706	0.0724	0.0698
10	QPSK	1	25	22.87	22.94	22.79	0.0687	0.0698	0.0675
10	QPSK	1	49	22.85	22.94	22.71	0.0684	0.0698	0.0662
10	QPSK	25	0	21.95	22.06	22.08	0.0556	0.0570	0.0573
10	QPSK	25	12	21.84	21.94	21.82	0.0542	0.0555	0.0540
10	QPSK	25	25	21.89	21.95	21.81	0.0548	0.0556	0.0538
10	QPSK	50	0	21.95	22.06	21.95	0.0556	0.0570	0.0556
10	16QAM	1	0	22.21	22.27	22.20	0.0590	0.0598	0.0589
10	16QAM	1	25	22.17	22.27	22.22	0.0585	0.0598	0.0592
10	16QAM	1	49	22.14	22.35	22.21	0.0581	0.0610	0.0590
10	16QAM	25	0	20.88	20.95	20.80	0.0435	0.0442	0.0427
10	16QAM	25	12	20.88	21.03	20.72	0.0435	0.0450	0.0419
10	16QAM	25	25	20.72	20.84	20.86	0.0419	0.0431	0.0433
10	16QAM	50	0	20.83	20.85	20.75	0.0430	0.0432	0.0422
10	64QAM	1	0	21.08	21.22	21.22	0.0455	0.0470	0.0470
10	64QAM	1	25	21.09	21.22	21.13	0.0456	0.0470	0.0460
10	64QAM	1	49	21.03	21.09	21.19	0.0450	0.0456	0.0467
10	64QAM	25	0	19.87	19.85	19.91	0.0344	0.0343	0.0348
10	64QAM	25	12	19.82	19.75	19.75	0.0340	0.0335	0.0335
10	64QAM	25	25	19.82	19.71	19.83	0.0340	0.0332	0.0341



10	64QAM	50	0	19.86	19.83	19.81	0.0344	0.0341	0.0340
10	256QAM	1	0	18.08	18.05	18.11	0.0228	0.0226	0.0230
10	256QAM	1	25	18.00	18.08	17.93	0.0224	0.0228	0.0220
10	256QAM	1	49	18.01	18.01	18.00	0.0224	0.0224	0.0224
10	256QAM	25	0	17.78	17.93	17.78	0.0213	0.0220	0.0213
10	256QAM	25	12	17.72	17.80	17.68	0.0210	0.0214	0.0208
10	256QAM	25	25	17.73	17.78	17.75	0.0210	0.0213	0.0211
10	256QAM	50	0	17.91	17.95	17.74	0.0219	0.0221	0.0211
Channel				42115	42590	43065	EIRP(W)		
Frequency (MHz)				3452.5	3500	3547.5	L	M	H
5	QPSK	1	0	23.06	23.02	22.88	0.0718	0.0711	0.0689
5	QPSK	1	12	22.83	22.91	22.83	0.0681	0.0693	0.0681
5	QPSK	1	24	22.80	22.92	22.69	0.0676	0.0695	0.0659
5	QPSK	12	0	21.87	22.15	21.98	0.0546	0.0582	0.0560
5	QPSK	12	7	21.95	22.01	21.83	0.0556	0.0564	0.0541
5	QPSK	12	13	21.84	21.85	21.78	0.0542	0.0543	0.0535
5	QPSK	25	0	21.91	22.06	21.92	0.0551	0.0570	0.0552
5	16QAM	1	0	22.20	22.31	22.22	0.0589	0.0604	0.0592
5	16QAM	1	12	22.24	22.25	22.13	0.0594	0.0596	0.0579
5	16QAM	1	24	22.19	22.36	22.22	0.0587	0.0611	0.0592
5	16QAM	12	0	20.91	21.02	20.77	0.0438	0.0449	0.0424
5	16QAM	12	7	20.87	20.96	20.72	0.0434	0.0443	0.0419
5	16QAM	12	13	20.76	20.84	20.90	0.0423	0.0431	0.0437
5	16QAM	25	0	20.78	20.93	20.85	0.0425	0.0440	0.0432
5	64QAM	1	0	21.10	21.19	21.28	0.0457	0.0467	0.0476
5	64QAM	1	12	21.10	21.19	21.09	0.0457	0.0467	0.0456
5	64QAM	1	24	21.01	21.11	21.18	0.0448	0.0458	0.0466
5	64QAM	12	0	19.96	19.94	19.92	0.0352	0.0350	0.0348
5	64QAM	12	7	19.80	19.80	19.79	0.0339	0.0339	0.0338
5	64QAM	12	13	19.82	19.72	19.72	0.0340	0.0333	0.0333
5	64QAM	25	0	19.78	19.92	19.71	0.0337	0.0348	0.0332
5	256QAM	1	0	18.06	18.07	18.01	0.0227	0.0228	0.0224
5	256QAM	1	12	18.05	18.07	17.99	0.0226	0.0228	0.0223
5	256QAM	1	24	18.01	18.02	17.99	0.0224	0.0225	0.0223
5	256QAM	12	0	17.81	17.85	17.83	0.0214	0.0216	0.0215
5	256QAM	12	7	17.68	17.81	17.66	0.0208	0.0214	0.0207
5	256QAM	12	13	17.73	17.81	17.73	0.0210	0.0214	0.0210
5	256QAM	25	0	17.92	17.99	17.84	0.0220	0.0223	0.0216



LTE Band 42

Peak-to-Average Ratio

Mode	LTE Band 42 / 20MHz			
Mod.	QPSK	16QAM	64QAM	Limit: 13dB
RB Size	Full RB	Full RB	Full RB	Result
Middle CH	4.58	5.51	5.88	PASS

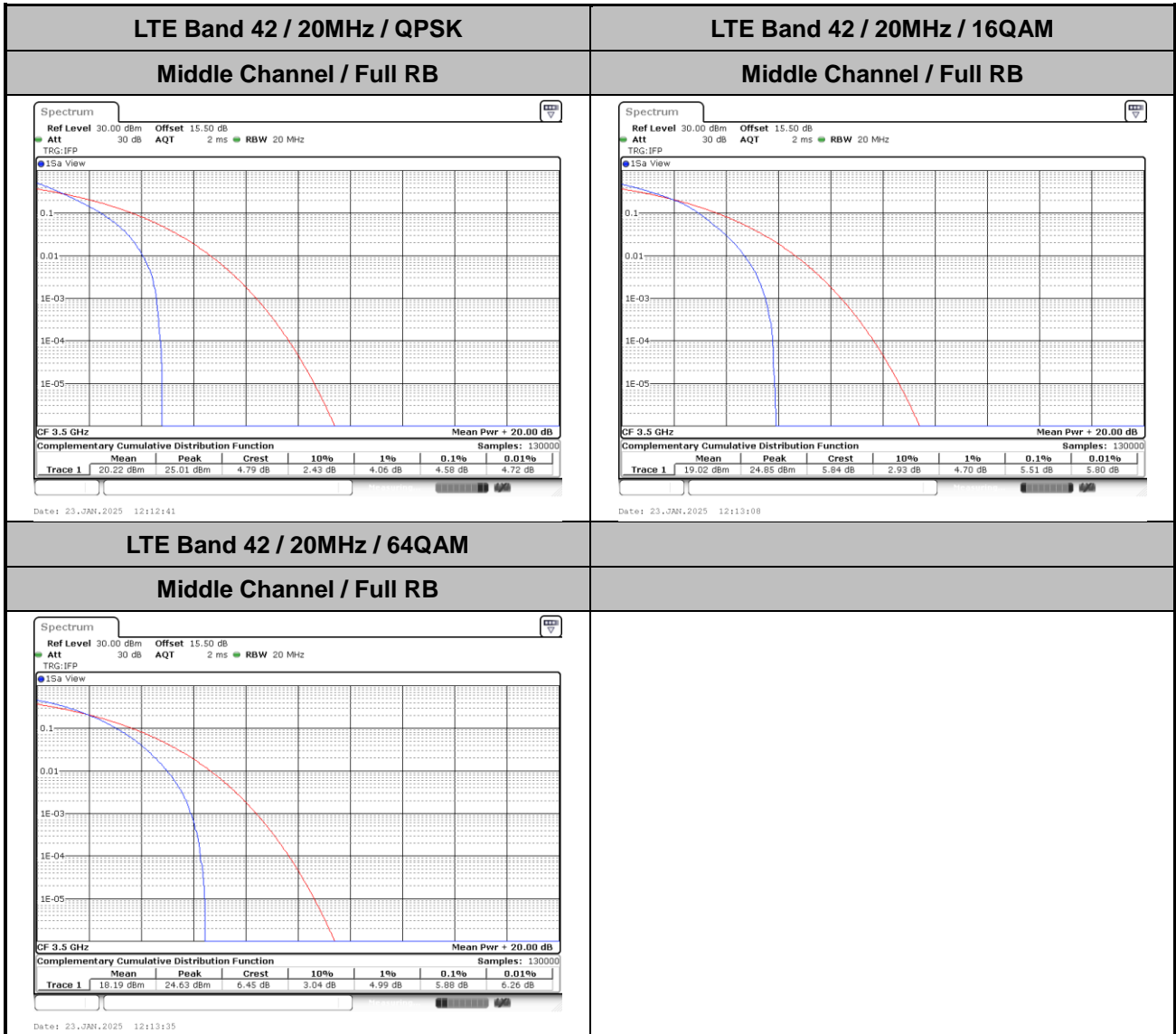



26dB Bandwidth

Mode	LTE Band 42 : 26dB BW(MHz)											
	1.4MHz		3MHz		5MHz		10MHz		15MHz		20MHz	
Mod.	QPSK	16QAM	QPSK	16QAM	QPSK	16QAM	QPSK	16QAM	QPSK	16QAM	QPSK	16QAM
Middle CH	-	-	-	-	5.00	4.84	9.63	9.73	14.18	14.36	19.06	18.62



LTE Band 42

Middle Channel / 5MHz / QPSK

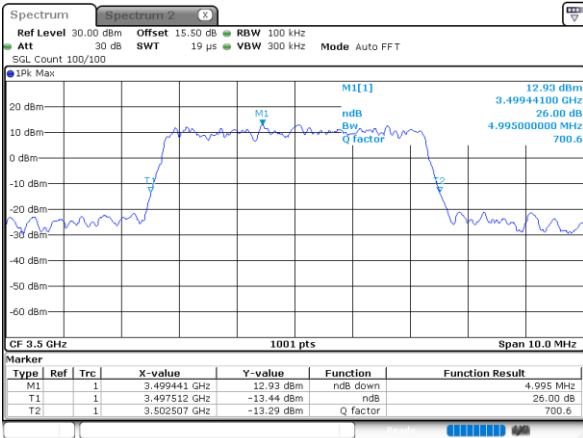

Date: 16, JAN, 2025 16:21:09

Middle Channel / 5MHz / 16QAM

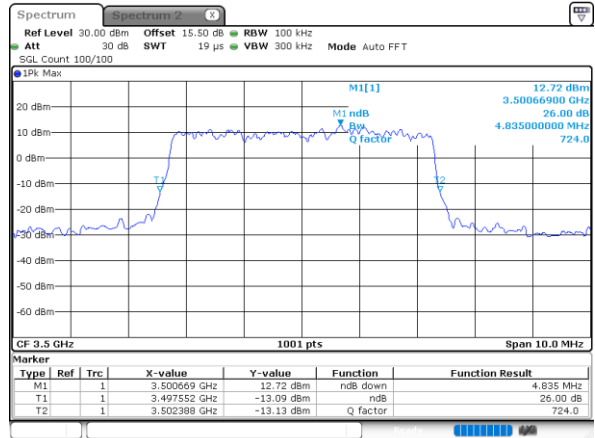

Date: 16, JAN, 2025 16:21:48

Middle Channel / 10MHz / QPSK

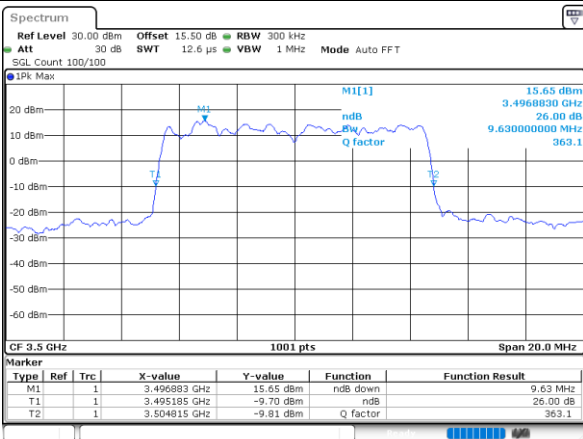

Date: 23, JAN, 2025 11:44:44

Middle Channel / 10MHz / 16QAM

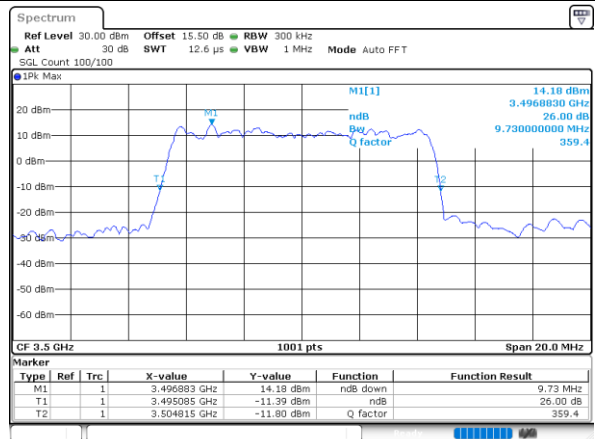

Date: 23, JAN, 2025 11:45:23

Middle Channel / 15MHz / QPSK

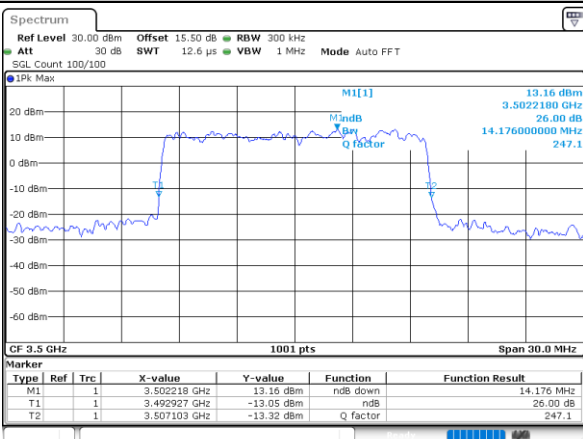

Date: 23, JAN, 2025 11:58:07

Middle Channel / 15MHz / 16QAM

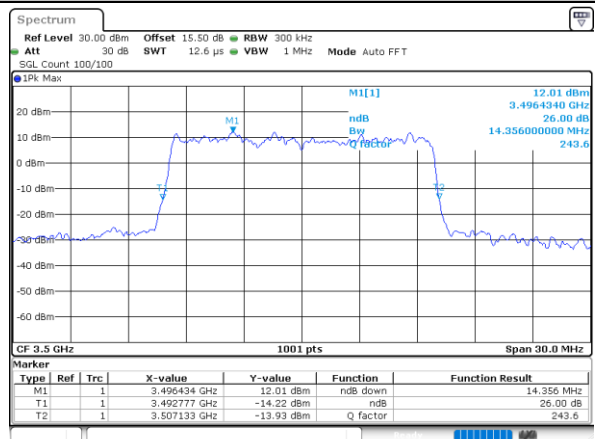

Date: 23, JAN, 2025 11:58:46



LTE Band 42

Middle Channel / 20MHz / QPSK

Middle Channel / 20MHz / 16QAM

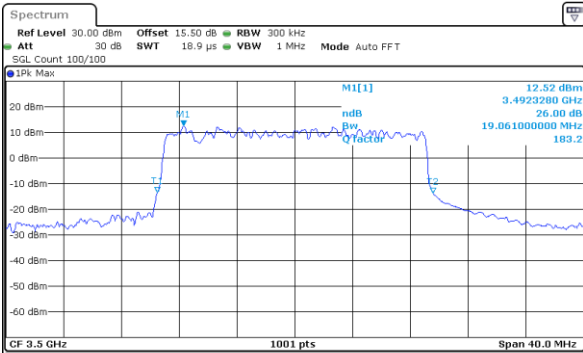

Type	Ref	Trc	X-value	Y-value	Function	Function Result
M1	1		3.492328 GHz	12.52 dBm	ndB down	19.061 MHz
T1	1		3.49049 GHz	-13.57 dBm	ndB	26.00 dB
T2	1		3.50955 GHz	-13.62 dBm	Q factor	183.2

Date: 23_JAN_2025 12:11:35

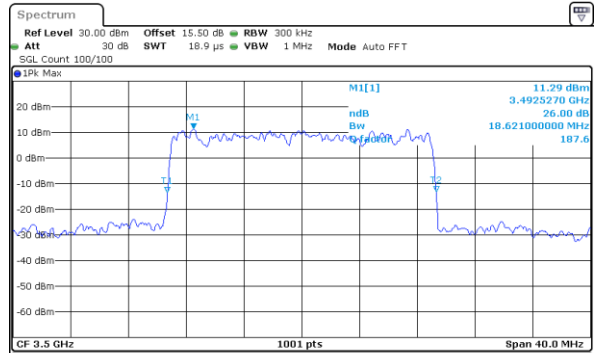

Type	Ref	Trc	X-value	Y-value	Function	Function Result
M1	1		3.492527 GHz	11.29 dBm	ndB down	18.621 MHz
T1	1		3.490689 GHz	-13.44 dBm	ndB	26.00 dB
T2	1		3.509311 GHz	-13.10 dBm	Q factor	187.6

Date: 23_JAN_2025 12:11:15



Occupied Bandwidth

Mode	LTE Band 42 : 99%OBW(MHz)											
	1.4MHz		3MHz		5MHz		10MHz		15MHz		20MHz	
Mod.	QPSK	16QAM	QPSK	16QAM	QPSK	16QAM	QPSK	16QAM	QPSK	16QAM	QPSK	16QAM
Middle CH	-	-	-	-	4.50	4.48	8.99	9.01	13.43	13.46	17.82	17.90

LTE Band 42

Middle Channel / 5MHz / QPSK

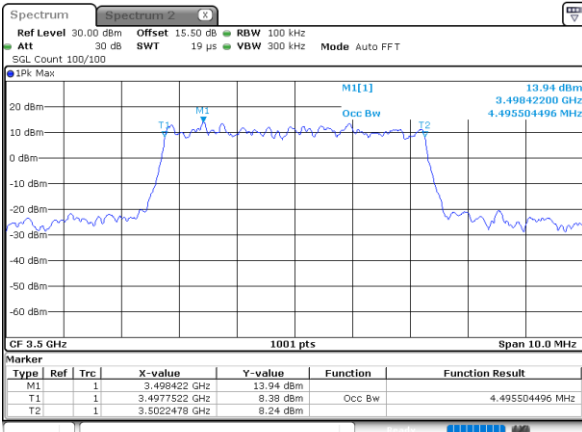

Date: 16_JAN,2025 16:20:55

Middle Channel / 5MHz / 16QAM

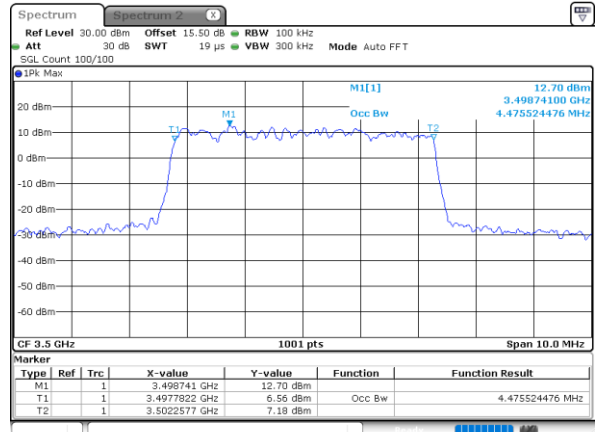

Date: 16_JAN,2025 16:21:34

Middle Channel / 10MHz / QPSK

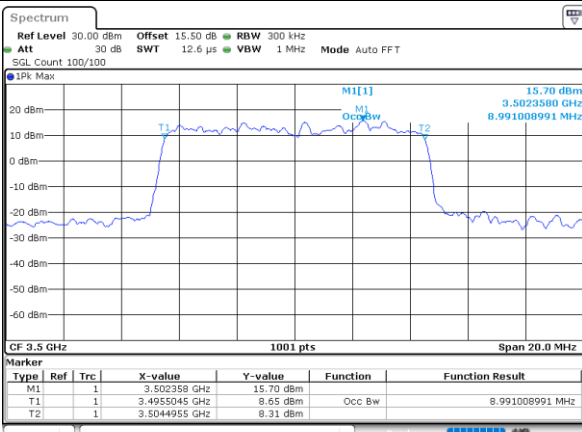

Date: 23_JAN,2025 13:19:44

Middle Channel / 10MHz / 16QAM

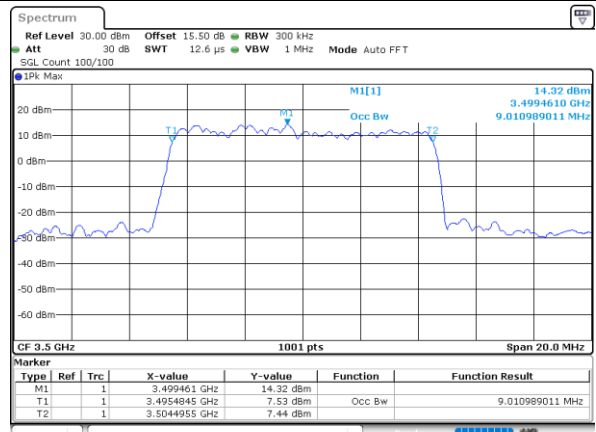

Date: 23_JAN,2025 11:45:09

Middle Channel / 15MHz / QPSK

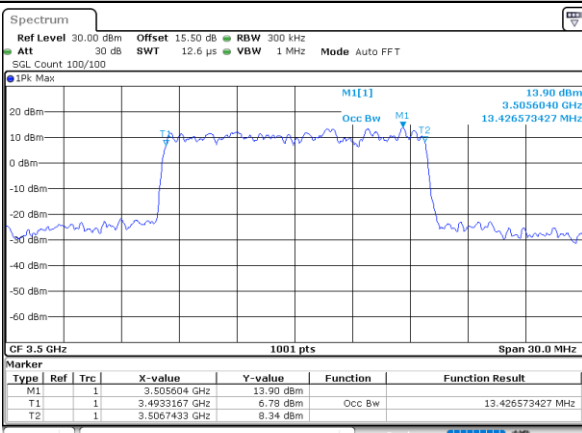

Date: 23_JAN,2025 11:57:53

Middle Channel / 15MHz / 16QAM

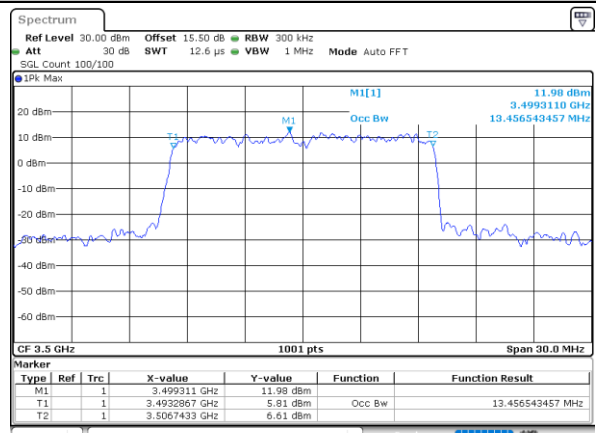

Date: 23_JAN,2025 11:58:32

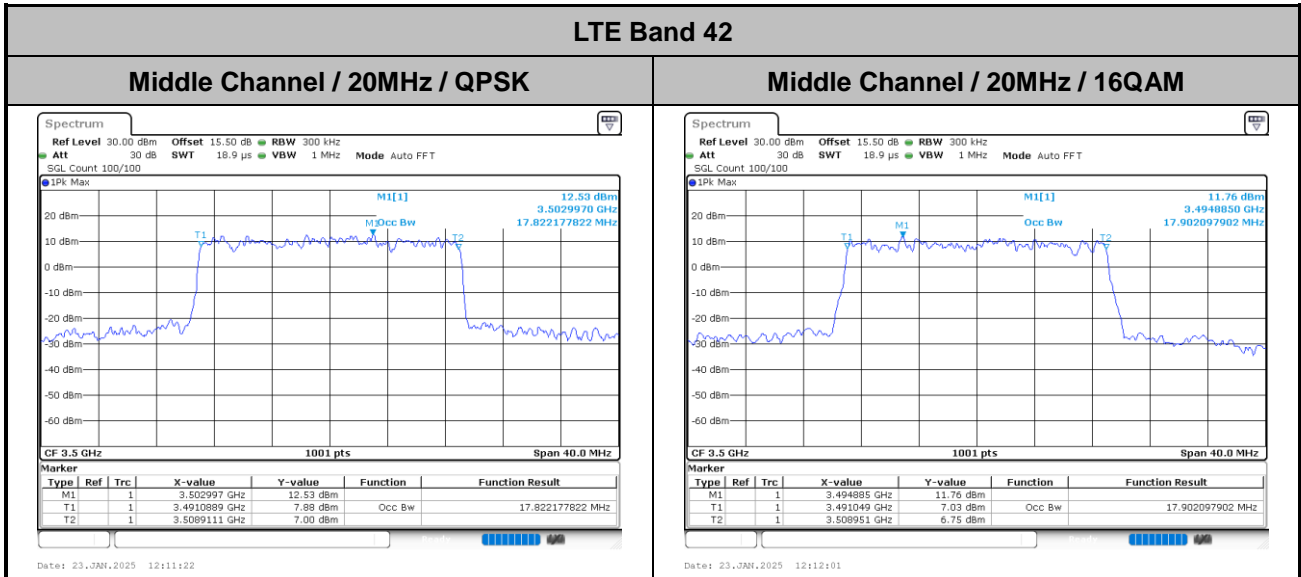



Conducted Band Edge

LTE Band 42 / 5MHz / QPSK

Lowest Band Edge / 1 RB

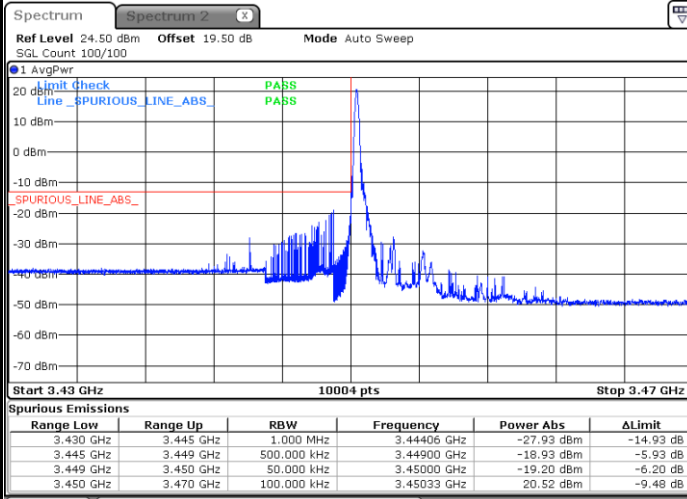

Date: 16.JAN.2025 16:14:27

Highest Band Edge / 1 RB

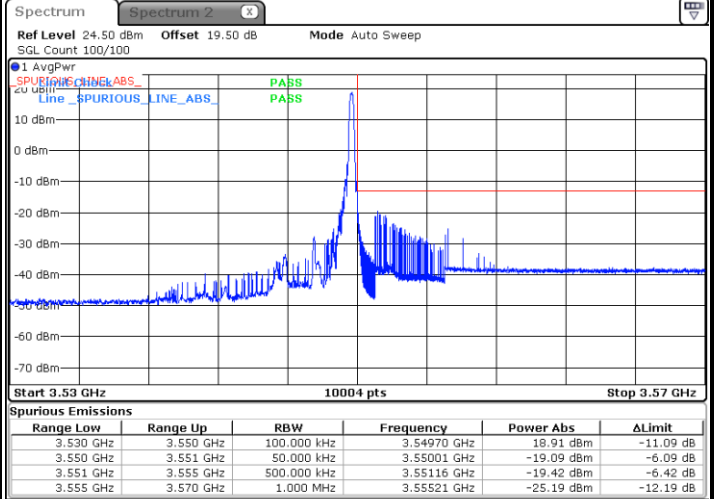

Date: 16.JAN.2025 16:22:28

Lowest Band Edge / Full RB

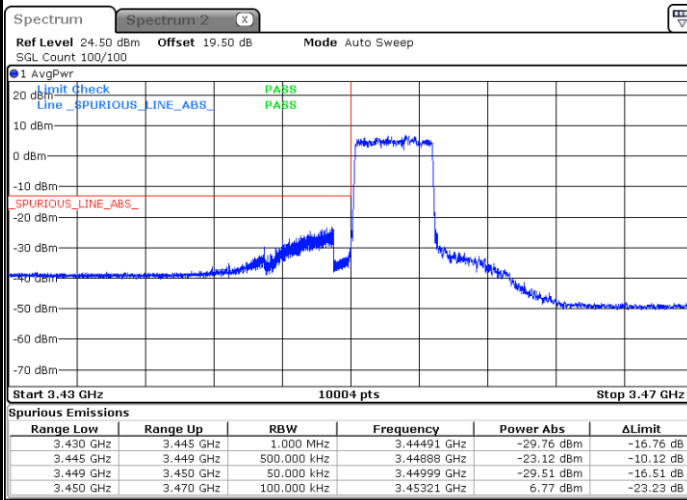

Date: 16.JAN.2025 16:16:29

Highest Band Edge / Full RB

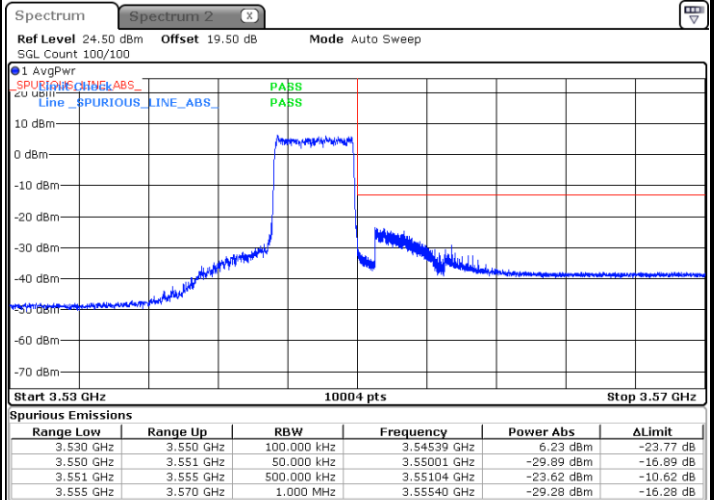

Date: 16.JAN.2025 16:24:29



LTE Band 42 / 5MHz / 16QAM

Lowest Band Edge / 1RB

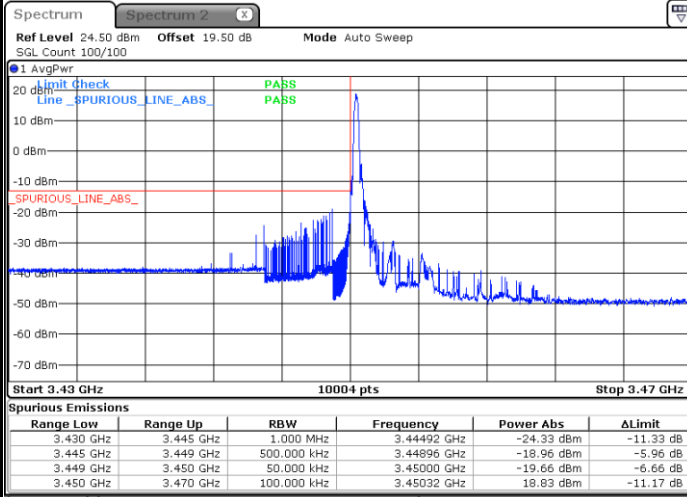

Date: 16.JAN.2025 16:15:08

Highest Band Edge / 1 RB

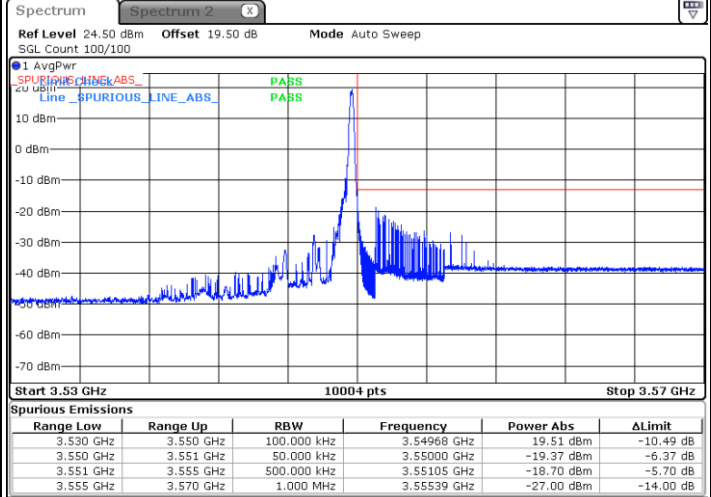

Date: 16.JAN.2025 16:23:08

Lowest Band Edge / Full RB

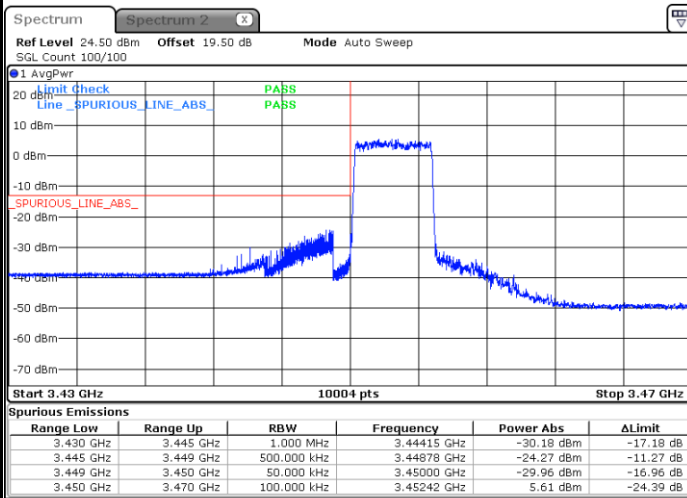

Date: 16.JAN.2025 16:17:09

Highest Band Edge / Full RB

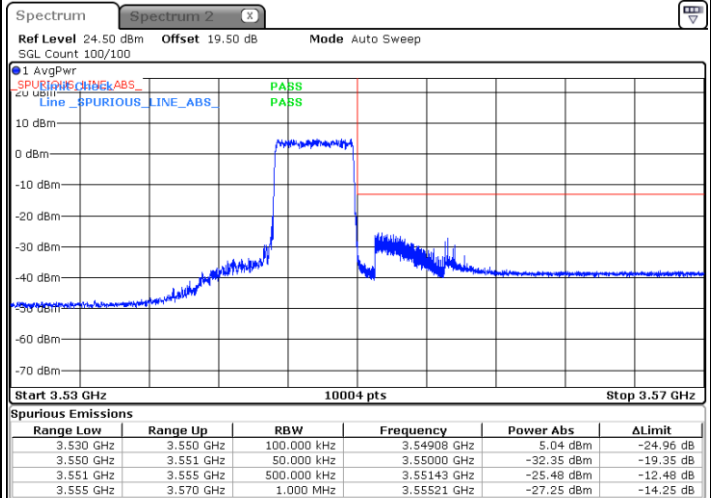

Date: 16.JAN.2025 16:25:10



LTE Band 42 / 5MHz / 64QAM

Lowest Band Edge / 1RB

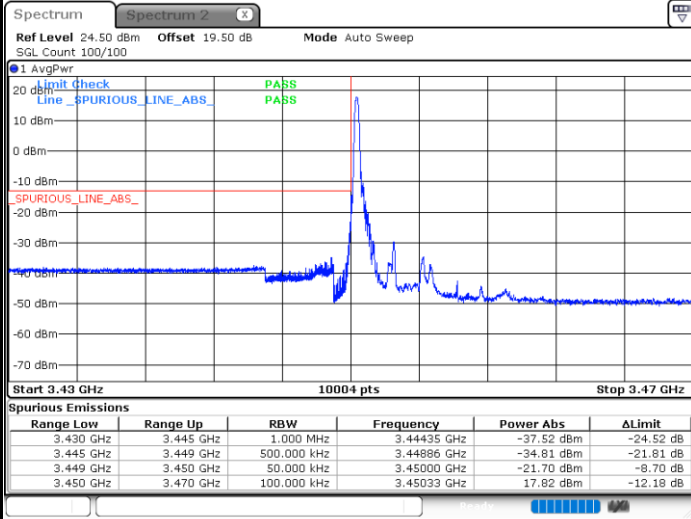

Date: 16.JAN.2025 16:15:48

Highest Band Edge / 1 RB

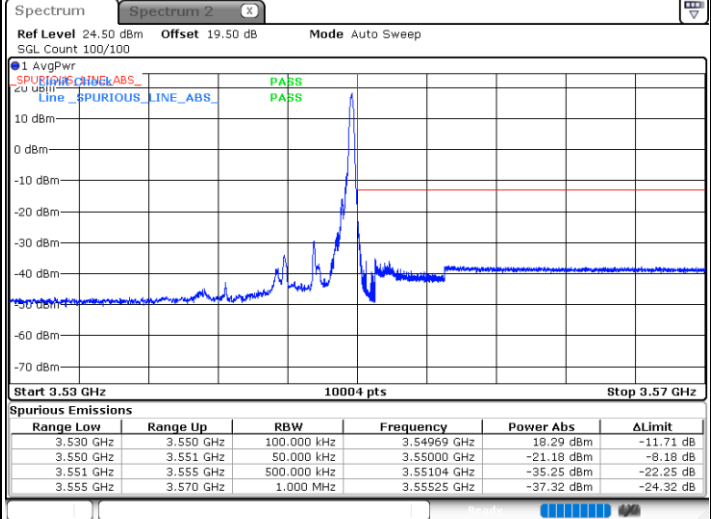

Date: 16.JAN.2025 16:23:49

Lowest Band Edge / Full RB

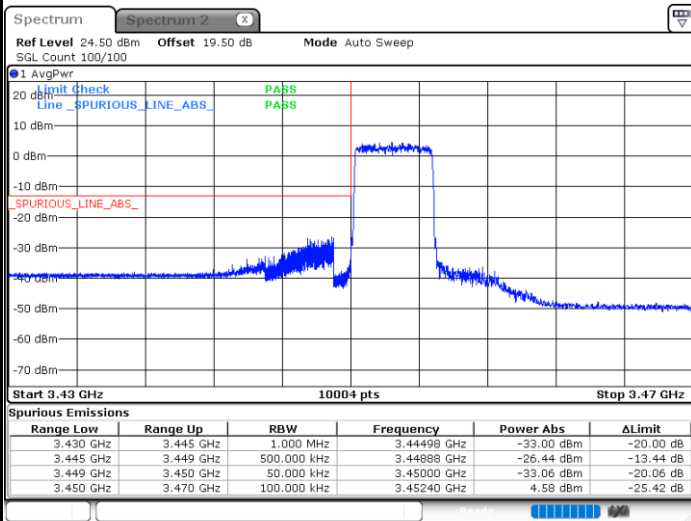

Date: 16.JAN.2025 16:17:50

Highest Band Edge / Full RB

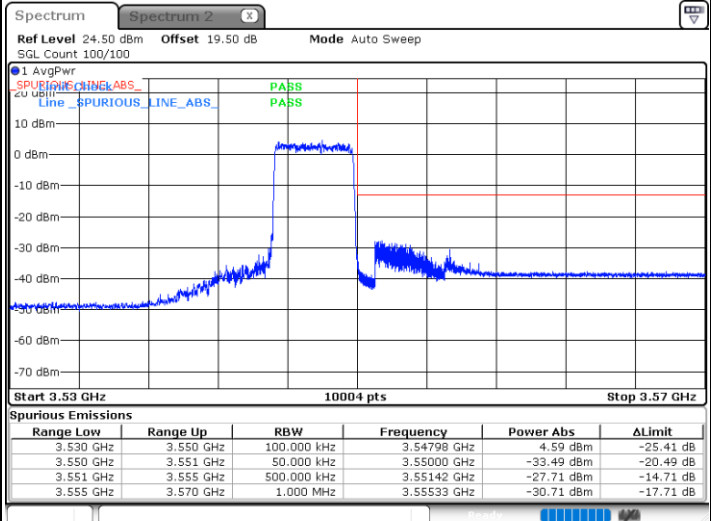

Date: 16.JAN.2025 16:25:50



LTE Band 42 / 10MHz / QPSK

Lowest Band Edge / 1 RB

Highest Band Edge / 1 RB

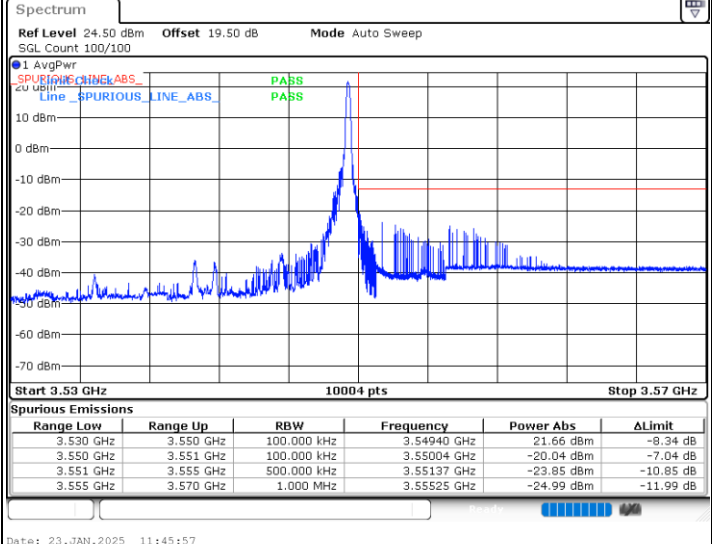
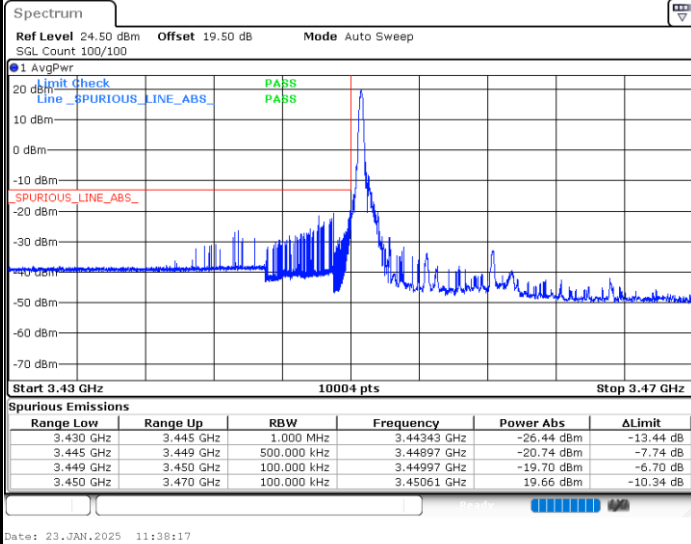

Date: 23.JAN.2025 11:38:17

Date: 23.JAN.2025 11:45:57

Lowest Band Edge / Full RB

Highest Band Edge / Full RB

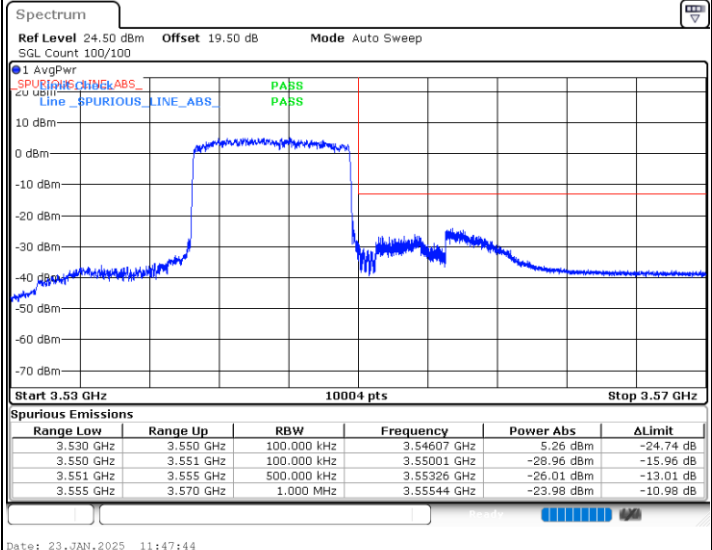
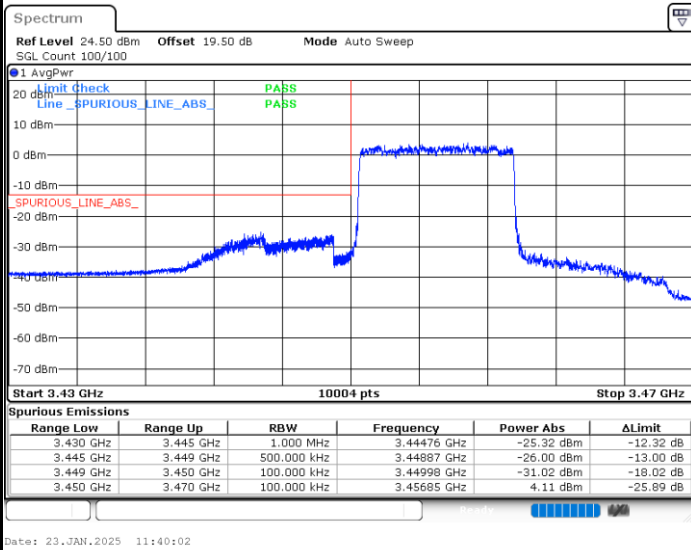

Date: 23.JAN.2025 11:40:02

Date: 23.JAN.2025 11:47:44



LTE Band 42 / 10MHz / 16QAM

Lowest Band Edge / 1RB

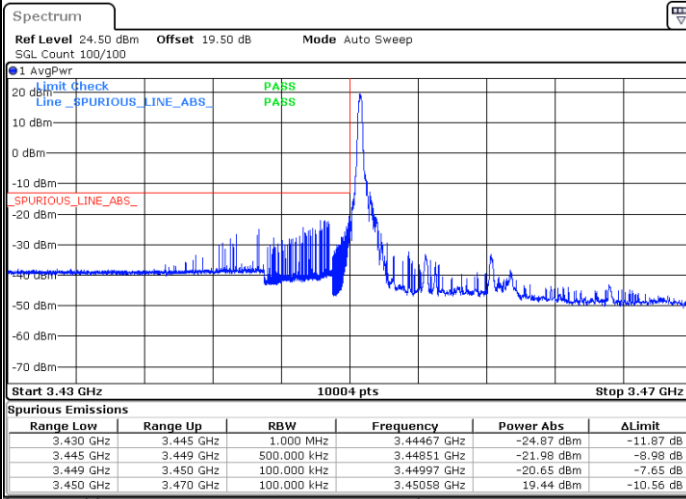

Date: 23.JAN.2025 11:38:51

Highest Band Edge / 1 RB

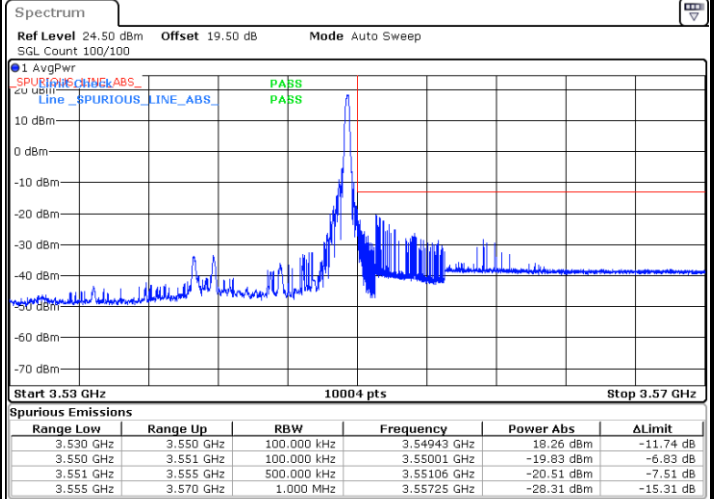

Date: 23.JAN.2025 11:46:33

Lowest Band Edge / Full RB

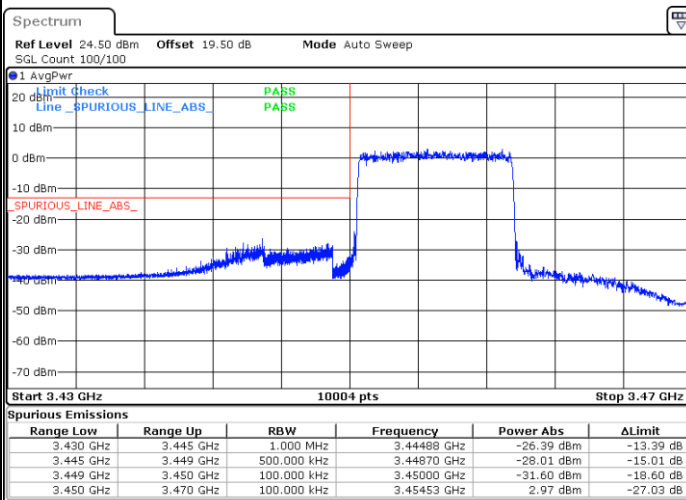

Date: 23.JAN.2025 11:40:38

Highest Band Edge / Full RB

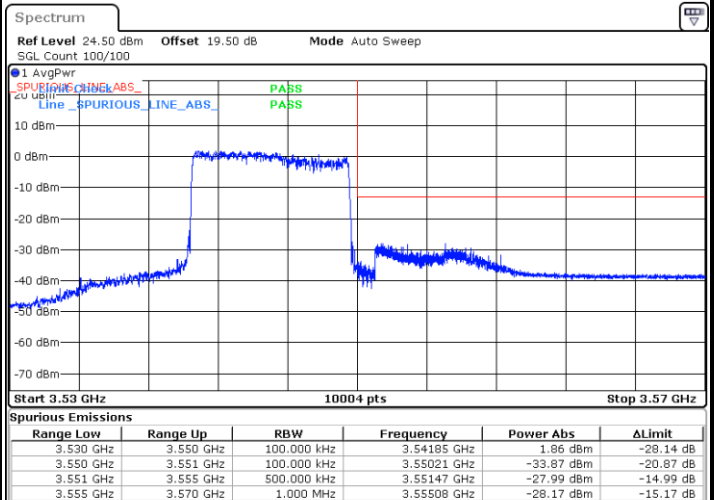

Date: 23.JAN.2025 11:48:20



LTE Band 42 / 10MHz / 64QAM

Lowest Band Edge / 1RB

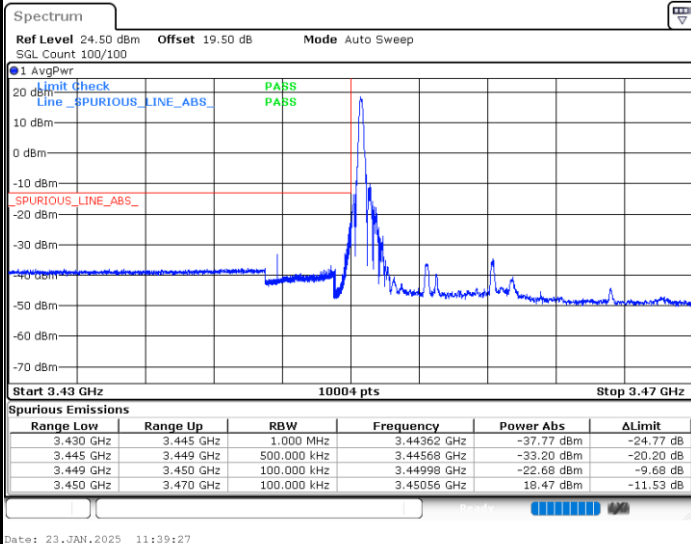

Highest Band Edge / 1 RB

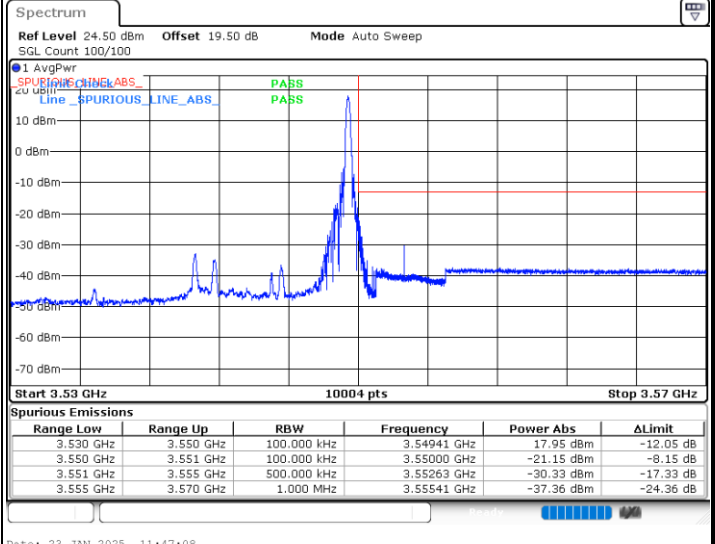

Lowest Band Edge / Full RB

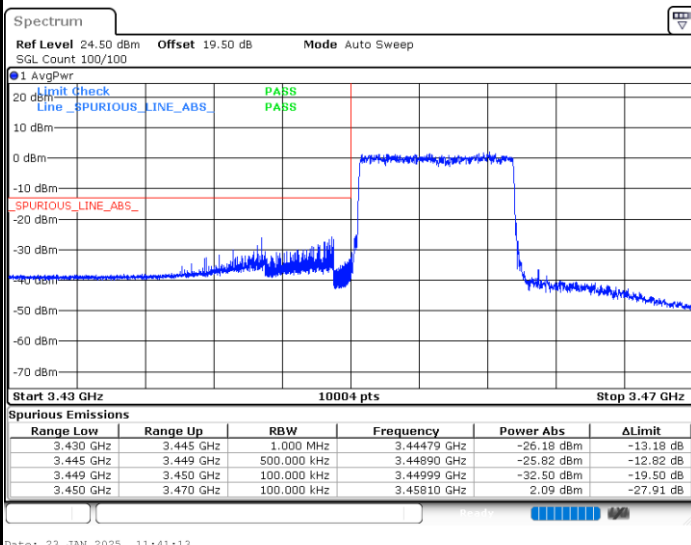

Highest Band Edge / Full RB

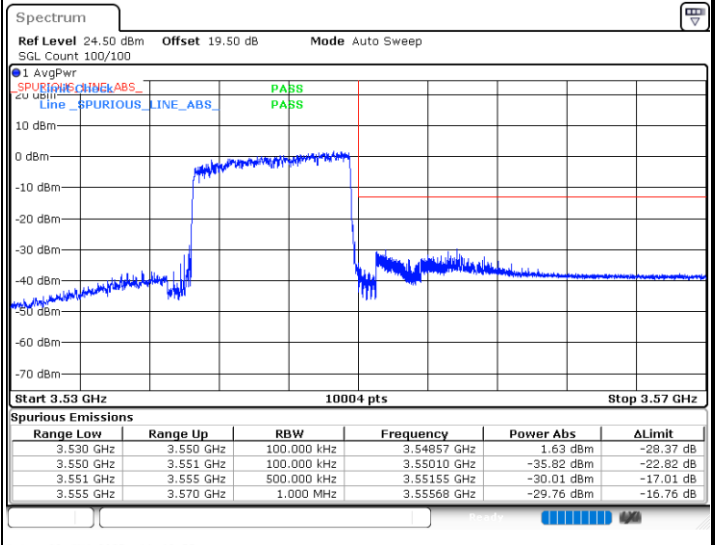



LTE Band 42 / 15MHz / QPSK

Lowest Band Edge / 1 RB

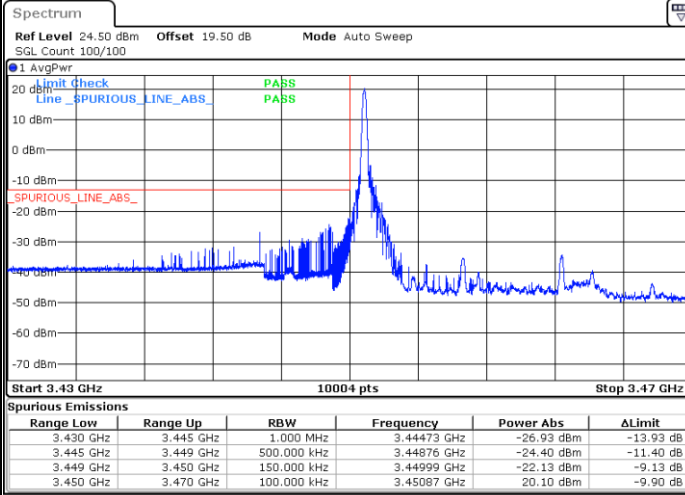

Date: 23.JAN.2025 11:51:39

Highest Band Edge / 1 RB

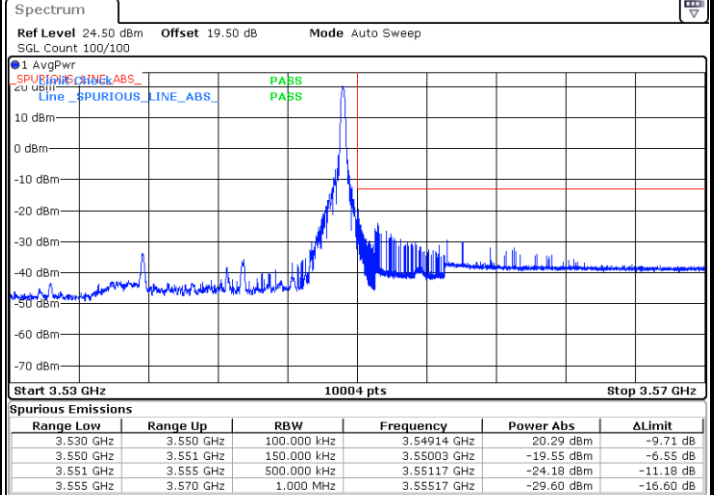

Date: 23.JAN.2025 11:59:21

Lowest Band Edge / Full RB

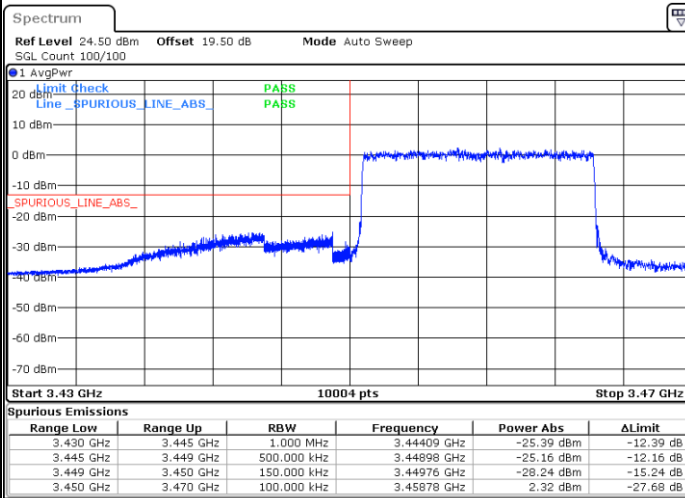

Date: 23.JAN.2025 11:53:26

Highest Band Edge / Full RB

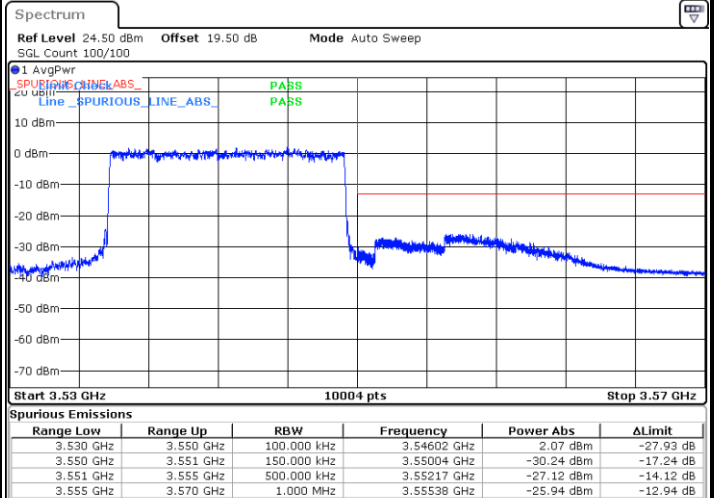

Date: 23.JAN.2025 12:01:11



LTE Band 42 / 15MHz / 16QAM

Lowest Band Edge / 1RB

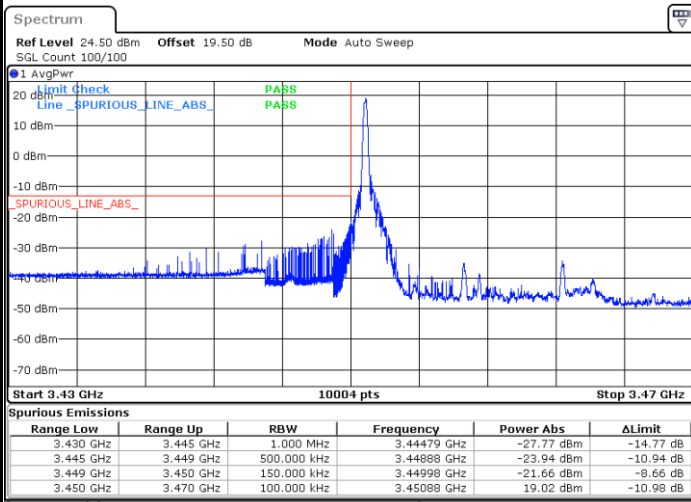

Date: 23.JAN.2025 11:52:15

Highest Band Edge / 1 RB

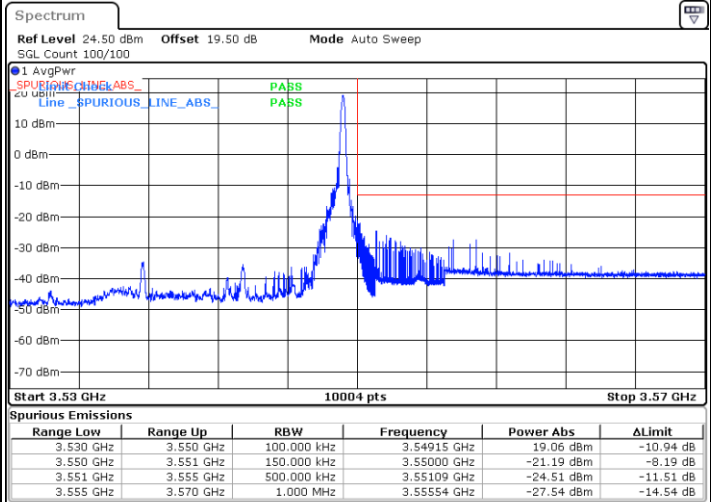

Date: 23.JAN.2025 11:59:56

Lowest Band Edge / Full RB

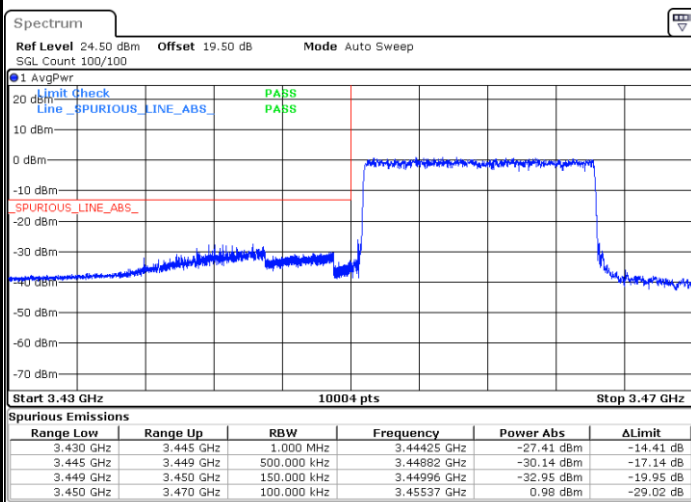

Date: 23.JAN.2025 11:54:02

Highest Band Edge / Full RB

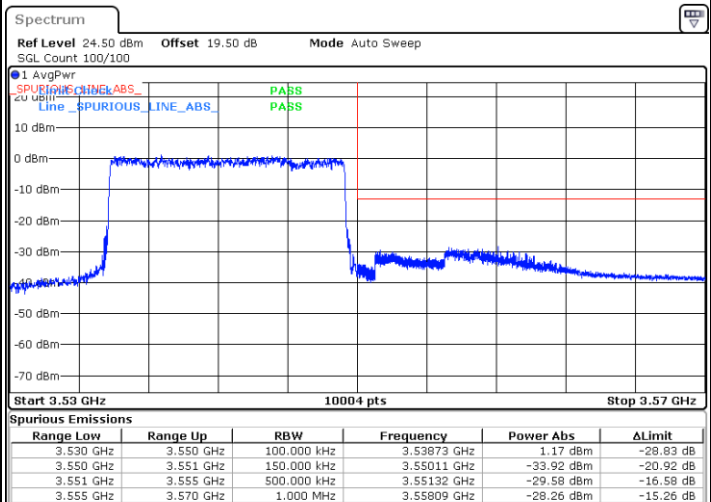

Date: 23.JAN.2025 12:01:46



LTE Band 42 / 15MHz / 64QAM

Lowest Band Edge / 1RB

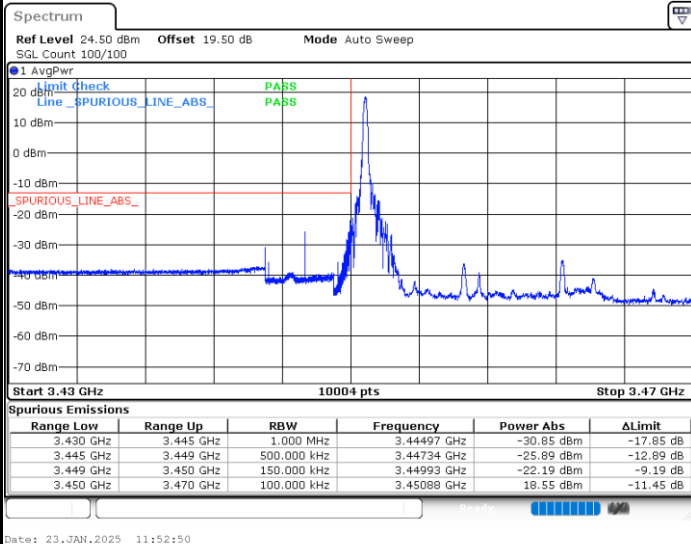

Date: 23.JAN.2025 11:52:50

Highest Band Edge / 1 RB

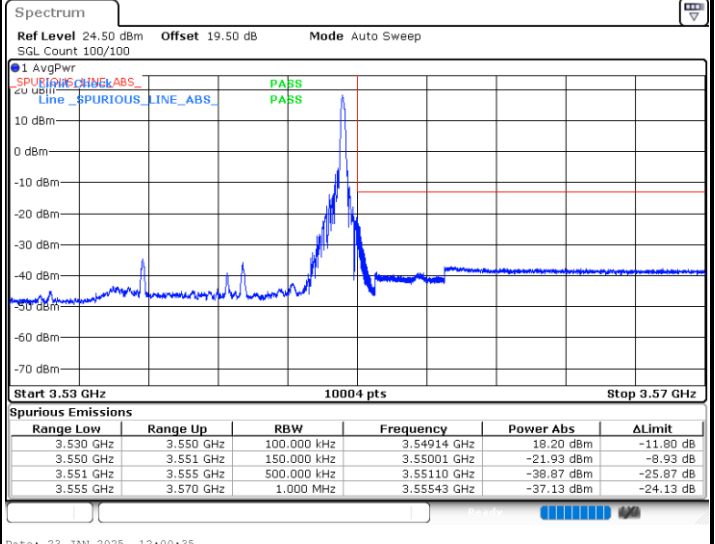

Date: 23.JAN.2025 12:00:35

Lowest Band Edge / Full RB

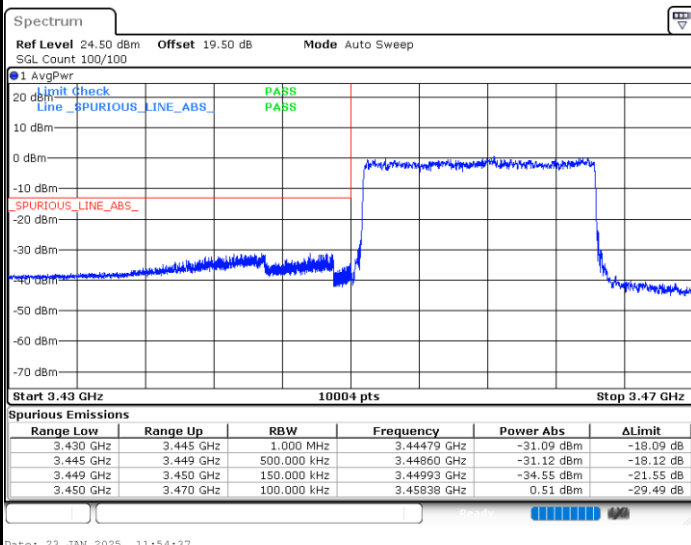

Date: 23.JAN.2025 11:54:37

Highest Band Edge / Full RB

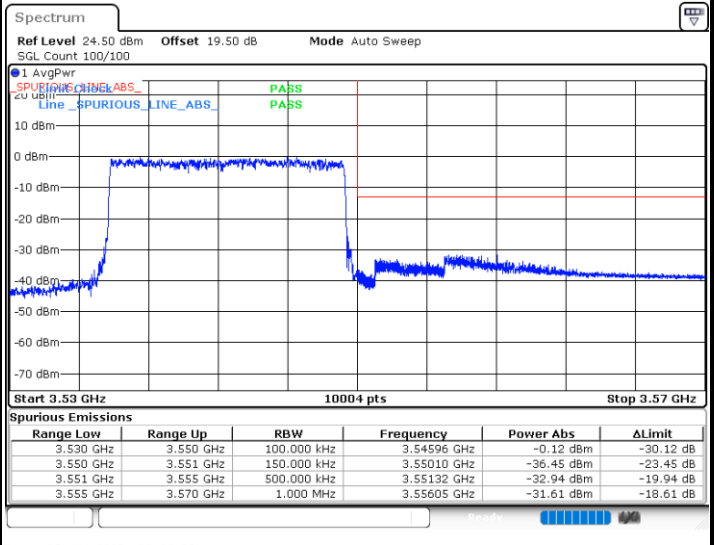

Date: 23.JAN.2025 12:02:22



LTE Band 42 / 20MHz / QPSK

Lowest Band Edge / 1 RB

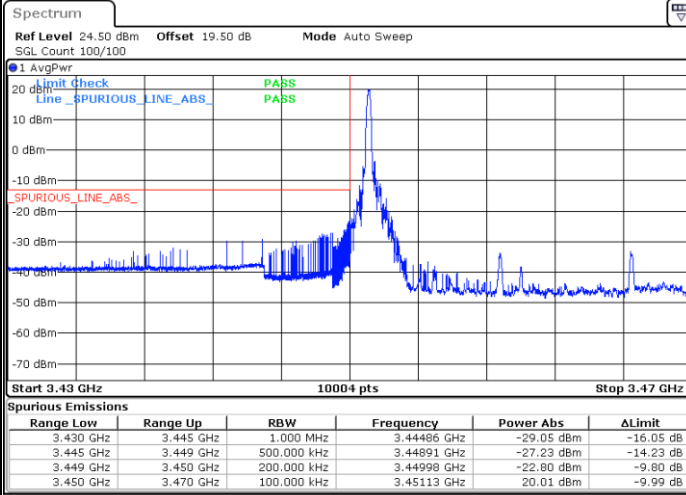

Date: 23.JAN.2025 13:09:44

Highest Band Edge / 1 RB



Date: 23.JAN.2025 12:14:09

Lowest Band Edge / Full RB

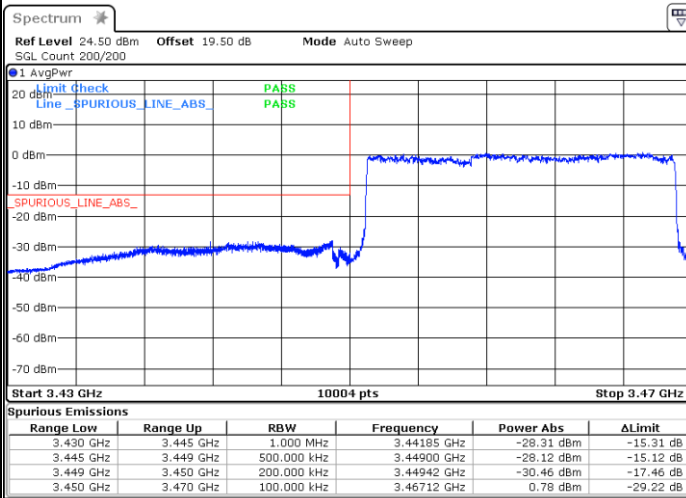

Date: 23.JAN.2025 13:12:29

Highest Band Edge / Full RB

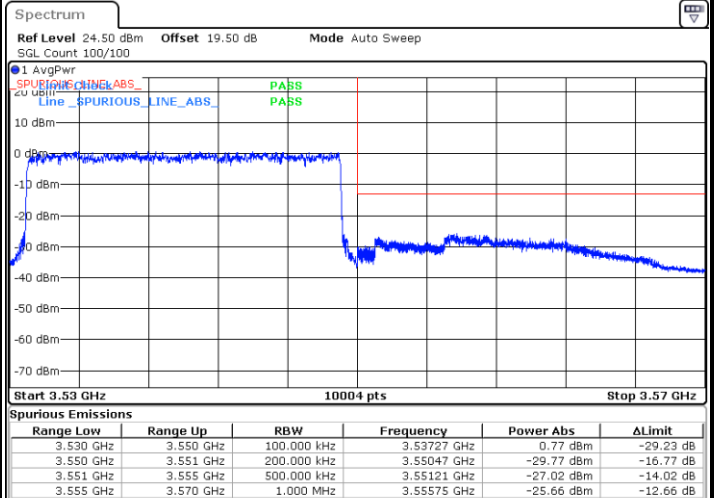

Date: 23.JAN.2025 12:15:56



LTE Band 42 / 20MHz / 16QAM

Lowest Band Edge / 1RB

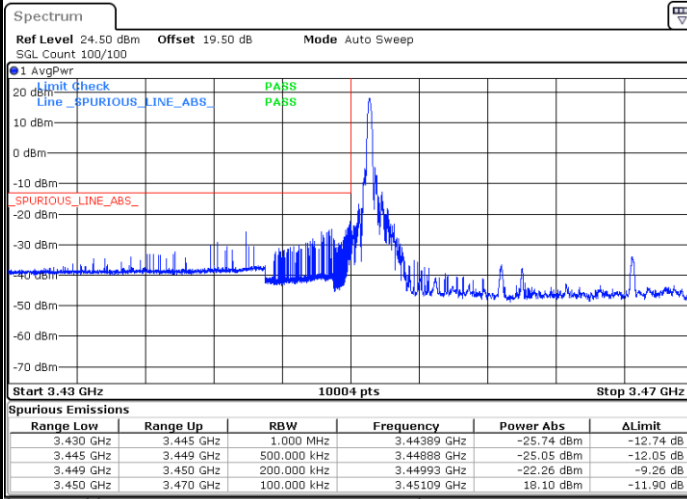

Date: 23.JAN.2025 12:05:44

Highest Band Edge / 1 RB

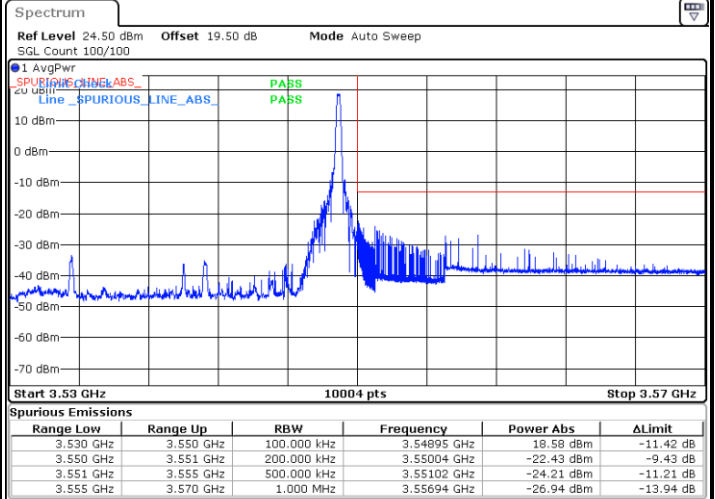

Date: 23.JAN.2025 12:14:45

Lowest Band Edge / Full RB

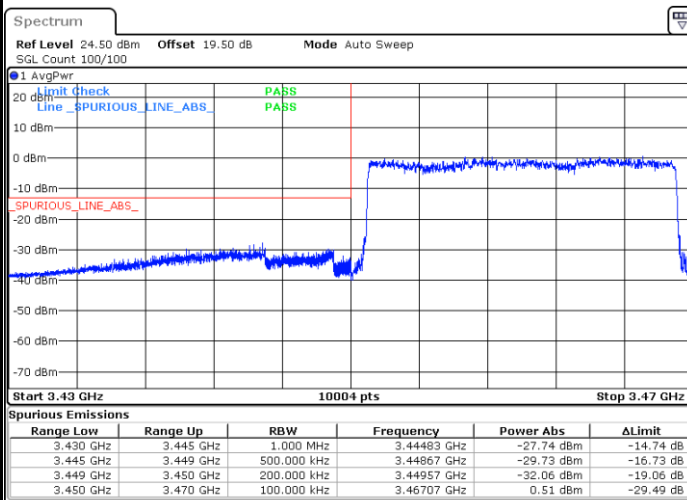

Date: 23.JAN.2025 12:07:31

Highest Band Edge / Full RB

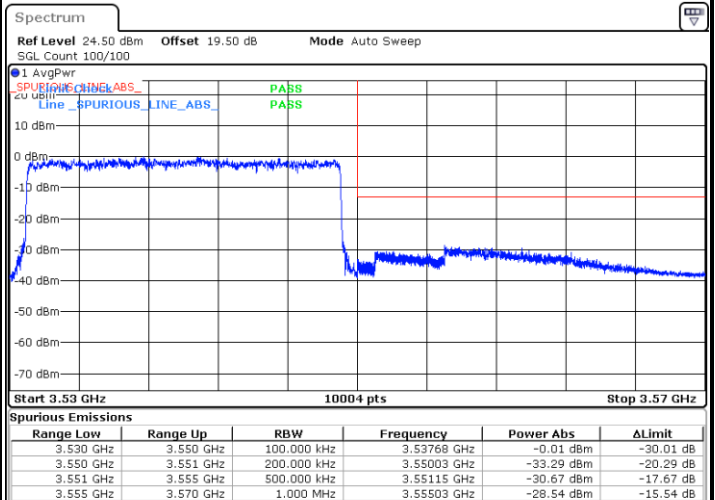

Date: 23.JAN.2025 12:16:31



LTE Band 42 / 20MHz / 64QAM

Lowest Band Edge / 1RB

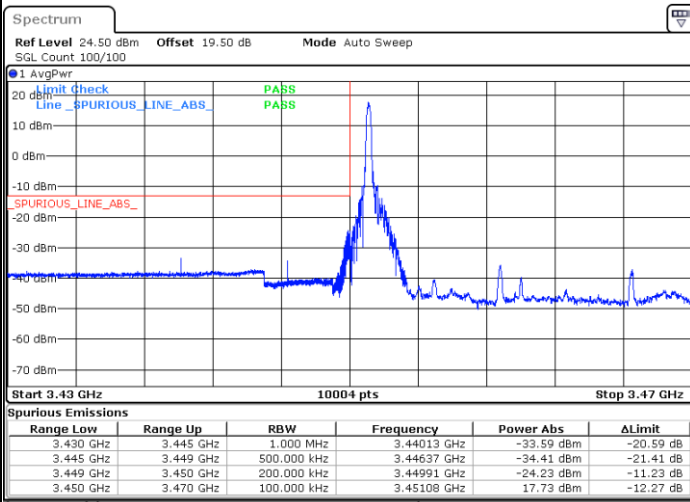

Date: 23.JAN.2025 12:06:20

Highest Band Edge / 1 RB

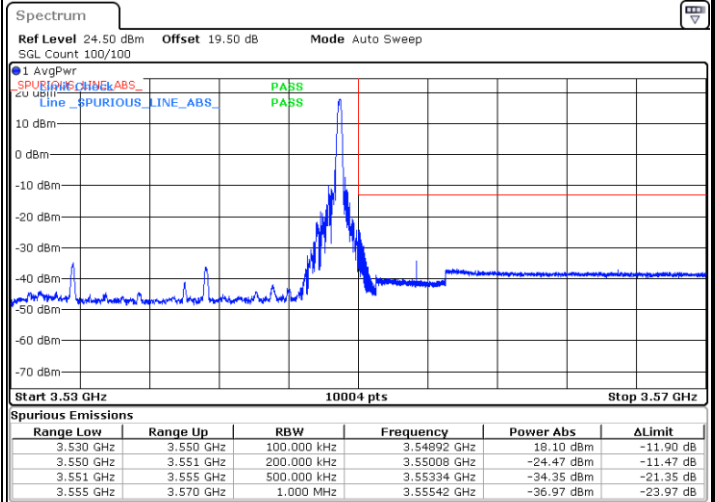

Date: 23.JAN.2025 12:15:20

Lowest Band Edge / Full RB

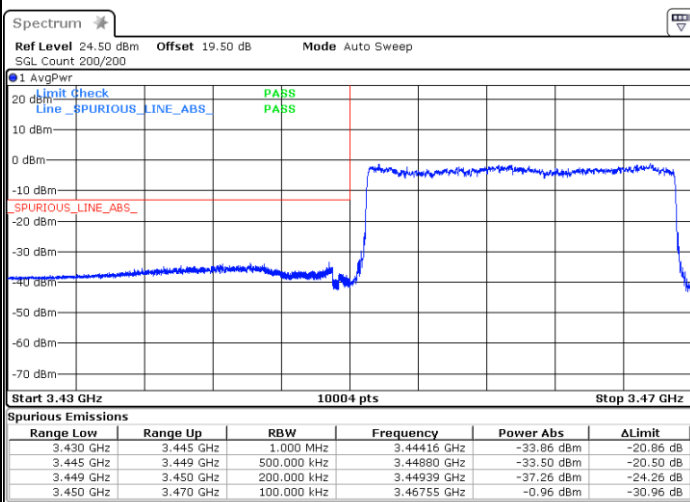

Date: 23.JAN.2025 13:11:03

Highest Band Edge / Full RB

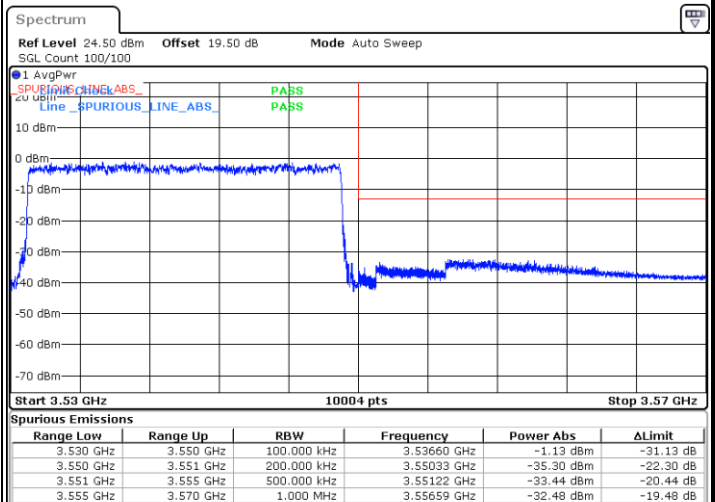

Date: 23.JAN.2025 12:17:07



Conducted Spurious Emission

LTE Band 42 / 5MHz

Lowest Channel / QPSK

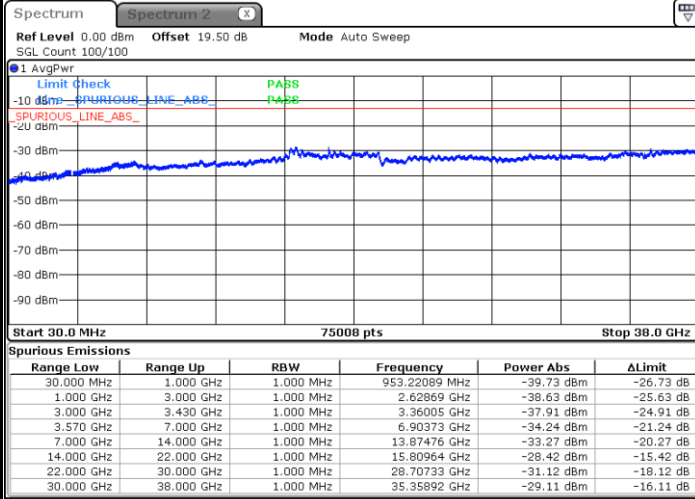

Date: 16.JAN.2025 16:19:10

Middle Channel / QPSK

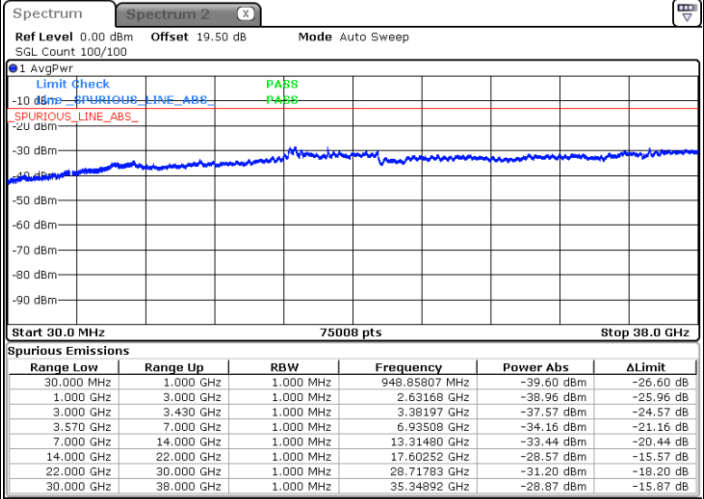

Date: 16.JAN.2025 16:20:29

Highest Channel / QPSK

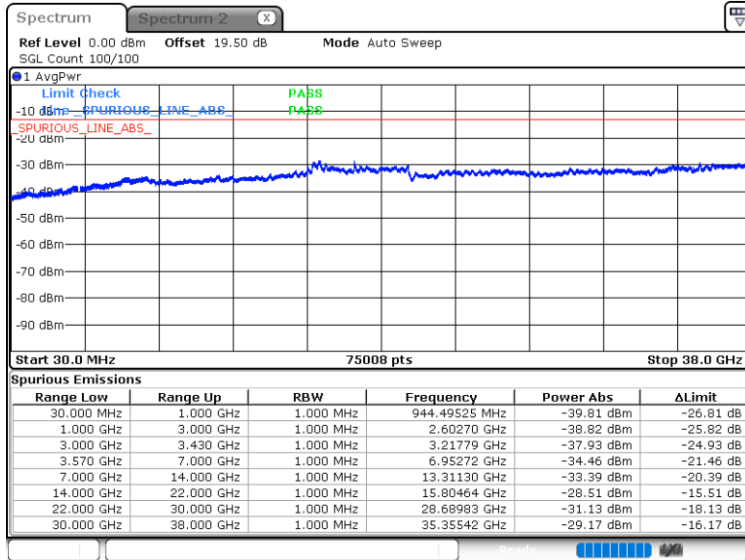

Date: 16.JAN.2025 16:27:10



LTE Band 42 / 10MHz

Lowest Channel / QPSK	Middle Channel / QPSK																																																																																																												
<p style="text-align: center;">Spectrum</p> <p>Ref Level 0.00 dBm Offset 19.50 dB Mode Auto Sweep SGL Count 100/100</p> <p>Start 30.0 MHz 75008 pts Stop 38.0 GHz</p> <table border="1" style="width: 100%; border-collapse: collapse;"> <thead> <tr> <th>Range Low</th> <th>Range Up</th> <th>RBW</th> <th>Frequency</th> <th>Power Abs</th> <th>ΔLimit</th> </tr> </thead> <tbody> <tr><td>30.000 MHz</td><td>1.000 GHz</td><td>1.000 MHz</td><td>970.67216 MHz</td><td>-39.63 dBm</td><td>-26.63 dB</td></tr> <tr><td>1.000 GHz</td><td>3.000 GHz</td><td>1.000 MHz</td><td>2.94653 GHz</td><td>-38.92 dBm</td><td>-25.92 dB</td></tr> <tr><td>3.000 GHz</td><td>3.430 GHz</td><td>1.000 MHz</td><td>3.36886 GHz</td><td>-37.92 dBm</td><td>-24.92 dB</td></tr> <tr><td>3.570 GHz</td><td>7.000 GHz</td><td>1.000 MHz</td><td>6.99143 GHz</td><td>-34.20 dBm</td><td>-21.20 dB</td></tr> <tr><td>7.000 GHz</td><td>14.000 GHz</td><td>1.000 MHz</td><td>13.89276 GHz</td><td>-33.33 dBm</td><td>-20.33 dB</td></tr> <tr><td>14.000 GHz</td><td>22.000 GHz</td><td>1.000 MHz</td><td>15.81464 GHz</td><td>-28.67 dBm</td><td>-15.67 dB</td></tr> <tr><td>22.000 GHz</td><td>30.000 GHz</td><td>1.000 MHz</td><td>28.67833 GHz</td><td>-31.18 dBm</td><td>-18.18 dB</td></tr> <tr><td>30.000 GHz</td><td>38.000 GHz</td><td>1.000 MHz</td><td>35.35492 GHz</td><td>-29.15 dBm</td><td>-16.15 dB</td></tr> </tbody> </table> <p>Date: 23.JAN.2025 13:17:58</p>	Range Low	Range Up	RBW	Frequency	Power Abs	ΔLimit	30.000 MHz	1.000 GHz	1.000 MHz	970.67216 MHz	-39.63 dBm	-26.63 dB	1.000 GHz	3.000 GHz	1.000 MHz	2.94653 GHz	-38.92 dBm	-25.92 dB	3.000 GHz	3.430 GHz	1.000 MHz	3.36886 GHz	-37.92 dBm	-24.92 dB	3.570 GHz	7.000 GHz	1.000 MHz	6.99143 GHz	-34.20 dBm	-21.20 dB	7.000 GHz	14.000 GHz	1.000 MHz	13.89276 GHz	-33.33 dBm	-20.33 dB	14.000 GHz	22.000 GHz	1.000 MHz	15.81464 GHz	-28.67 dBm	-15.67 dB	22.000 GHz	30.000 GHz	1.000 MHz	28.67833 GHz	-31.18 dBm	-18.18 dB	30.000 GHz	38.000 GHz	1.000 MHz	35.35492 GHz	-29.15 dBm	-16.15 dB	<p style="text-align: center;">Spectrum</p> <p>Ref Level 0.00 dBm Offset 19.50 dB Mode Auto Sweep SGL Count 100/100</p> <p>Start 30.0 MHz 75008 pts Stop 38.0 GHz</p> <table border="1" style="width: 100%; border-collapse: collapse;"> <thead> <tr> <th>Range Low</th> <th>Range Up</th> <th>RBW</th> <th>Frequency</th> <th>Power Abs</th> <th>ΔLimit</th> </tr> </thead> <tbody> <tr><td>30.000 MHz</td><td>1.000 GHz</td><td>1.000 MHz</td><td>925.58971 MHz</td><td>-39.74 dBm</td><td>-26.74 dB</td></tr> <tr><td>1.000 GHz</td><td>3.000 GHz</td><td>1.000 MHz</td><td>2.97151 GHz</td><td>-38.92 dBm</td><td>-25.92 dB</td></tr> <tr><td>3.000 GHz</td><td>3.430 GHz</td><td>1.000 MHz</td><td>3.37982 GHz</td><td>-37.90 dBm</td><td>-24.90 dB</td></tr> <tr><td>3.570 GHz</td><td>7.000 GHz</td><td>1.000 MHz</td><td>6.96987 GHz</td><td>-34.33 dBm</td><td>-21.33 dB</td></tr> <tr><td>7.000 GHz</td><td>14.000 GHz</td><td>1.000 MHz</td><td>13.99275 GHz</td><td>-33.36 dBm</td><td>-20.36 dB</td></tr> <tr><td>14.000 GHz</td><td>22.000 GHz</td><td>1.000 MHz</td><td>15.80964 GHz</td><td>-28.56 dBm</td><td>-15.56 dB</td></tr> <tr><td>22.000 GHz</td><td>30.000 GHz</td><td>1.000 MHz</td><td>28.69533 GHz</td><td>-31.15 dBm</td><td>-18.15 dB</td></tr> <tr><td>30.000 GHz</td><td>38.000 GHz</td><td>1.000 MHz</td><td>35.33842 GHz</td><td>-29.25 dBm</td><td>-16.25 dB</td></tr> </tbody> </table> <p>Date: 23.JAN.2025 13:19:18</p>	Range Low	Range Up	RBW	Frequency	Power Abs	ΔLimit	30.000 MHz	1.000 GHz	1.000 MHz	925.58971 MHz	-39.74 dBm	-26.74 dB	1.000 GHz	3.000 GHz	1.000 MHz	2.97151 GHz	-38.92 dBm	-25.92 dB	3.000 GHz	3.430 GHz	1.000 MHz	3.37982 GHz	-37.90 dBm	-24.90 dB	3.570 GHz	7.000 GHz	1.000 MHz	6.96987 GHz	-34.33 dBm	-21.33 dB	7.000 GHz	14.000 GHz	1.000 MHz	13.99275 GHz	-33.36 dBm	-20.36 dB	14.000 GHz	22.000 GHz	1.000 MHz	15.80964 GHz	-28.56 dBm	-15.56 dB	22.000 GHz	30.000 GHz	1.000 MHz	28.69533 GHz	-31.15 dBm	-18.15 dB	30.000 GHz	38.000 GHz	1.000 MHz	35.33842 GHz	-29.25 dBm	-16.25 dB
Range Low	Range Up	RBW	Frequency	Power Abs	ΔLimit																																																																																																								
30.000 MHz	1.000 GHz	1.000 MHz	970.67216 MHz	-39.63 dBm	-26.63 dB																																																																																																								
1.000 GHz	3.000 GHz	1.000 MHz	2.94653 GHz	-38.92 dBm	-25.92 dB																																																																																																								
3.000 GHz	3.430 GHz	1.000 MHz	3.36886 GHz	-37.92 dBm	-24.92 dB																																																																																																								
3.570 GHz	7.000 GHz	1.000 MHz	6.99143 GHz	-34.20 dBm	-21.20 dB																																																																																																								
7.000 GHz	14.000 GHz	1.000 MHz	13.89276 GHz	-33.33 dBm	-20.33 dB																																																																																																								
14.000 GHz	22.000 GHz	1.000 MHz	15.81464 GHz	-28.67 dBm	-15.67 dB																																																																																																								
22.000 GHz	30.000 GHz	1.000 MHz	28.67833 GHz	-31.18 dBm	-18.18 dB																																																																																																								
30.000 GHz	38.000 GHz	1.000 MHz	35.35492 GHz	-29.15 dBm	-16.15 dB																																																																																																								
Range Low	Range Up	RBW	Frequency	Power Abs	ΔLimit																																																																																																								
30.000 MHz	1.000 GHz	1.000 MHz	925.58971 MHz	-39.74 dBm	-26.74 dB																																																																																																								
1.000 GHz	3.000 GHz	1.000 MHz	2.97151 GHz	-38.92 dBm	-25.92 dB																																																																																																								
3.000 GHz	3.430 GHz	1.000 MHz	3.37982 GHz	-37.90 dBm	-24.90 dB																																																																																																								
3.570 GHz	7.000 GHz	1.000 MHz	6.96987 GHz	-34.33 dBm	-21.33 dB																																																																																																								
7.000 GHz	14.000 GHz	1.000 MHz	13.99275 GHz	-33.36 dBm	-20.36 dB																																																																																																								
14.000 GHz	22.000 GHz	1.000 MHz	15.80964 GHz	-28.56 dBm	-15.56 dB																																																																																																								
22.000 GHz	30.000 GHz	1.000 MHz	28.69533 GHz	-31.15 dBm	-18.15 dB																																																																																																								
30.000 GHz	38.000 GHz	1.000 MHz	35.33842 GHz	-29.25 dBm	-16.25 dB																																																																																																								

Highest Channel / QPSK

Spectrum

Ref Level 0.00 dBm Offset 19.50 dB Mode Auto Sweep
SGL Count 100/100

Start 30.0 MHz 75008 pts Stop 38.0 GHz

Range Low	Range Up	RBW	Frequency	Power Abs	ΔLimit
30.000 MHz	1.000 GHz	1.000 MHz	985.21489 MHz	-39.96 dBm	-26.96 dB
1.000 GHz	3.000 GHz	1.000 MHz	2.63568 GHz	-38.87 dBm	-25.87 dB
3.000 GHz	3.430 GHz	1.000 MHz	3.34351 GHz	-37.71 dBm	-24.71 dB
3.570 GHz	7.000 GHz	1.000 MHz	6.92480 GHz	-34.43 dBm	-21.43 dB
7.000 GHz	14.000 GHz	1.000 MHz	13.87876 GHz	-33.28 dBm	-20.28 dB
14.000 GHz	22.000 GHz	1.000 MHz	15.80814 GHz	-28.54 dBm	-15.54 dB
22.000 GHz	30.000 GHz	1.000 MHz	28.68833 GHz	-31.16 dBm	-18.16 dB
30.000 GHz	38.000 GHz	1.000 MHz	35.33992 GHz	-29.12 dBm	-16.12 dB

Date: 23.JAN.2025 13:21:03



LTE Band 42 / 15MHz

Lowest Channel / QPSK

Middle Channel / QPSK

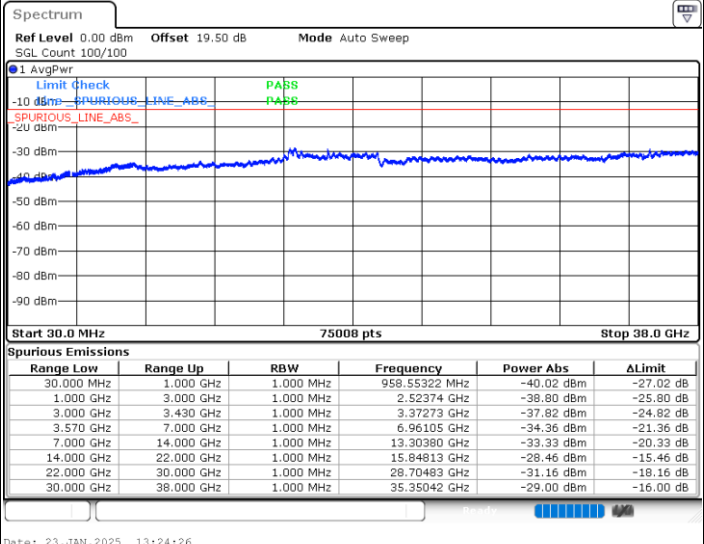
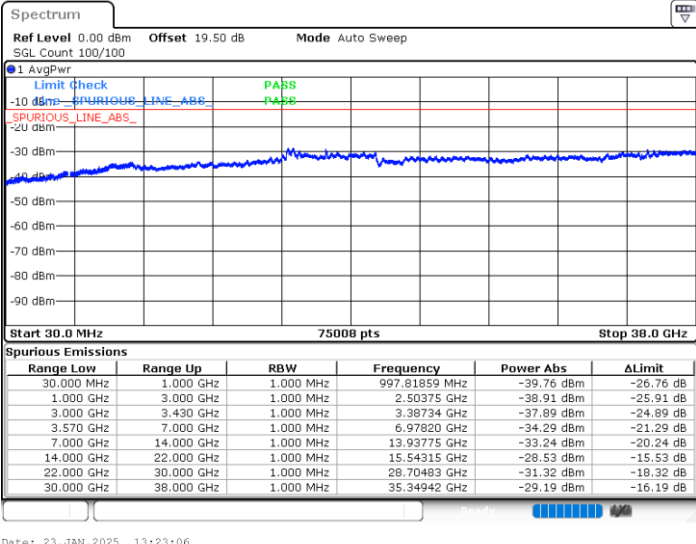

Highest Channel / QPSK

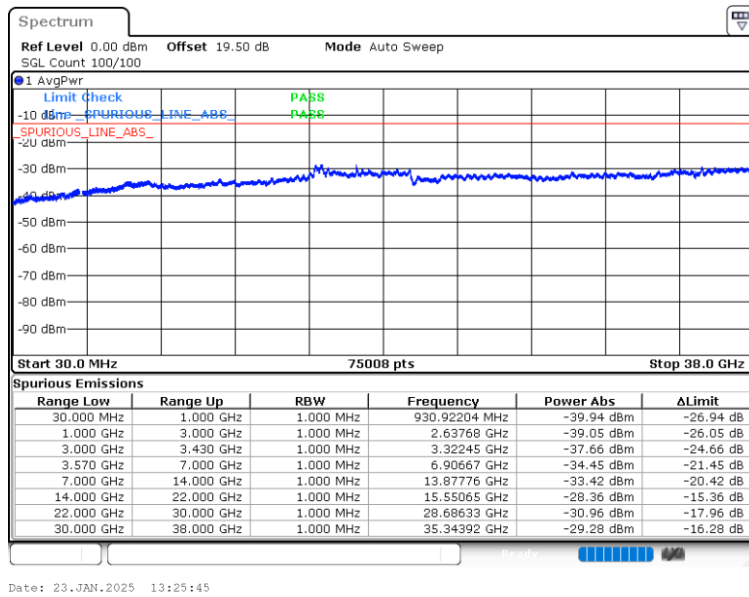



LTE Band 42 / 20MHz

Lowest Channel / QPSK

Middle Channel / QPSK

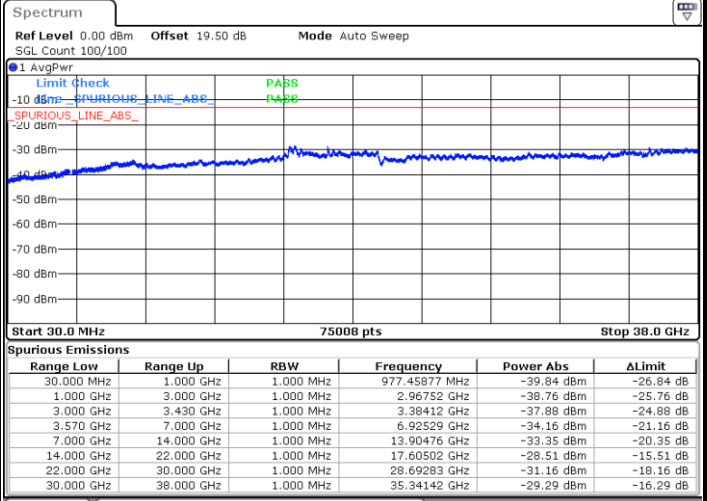
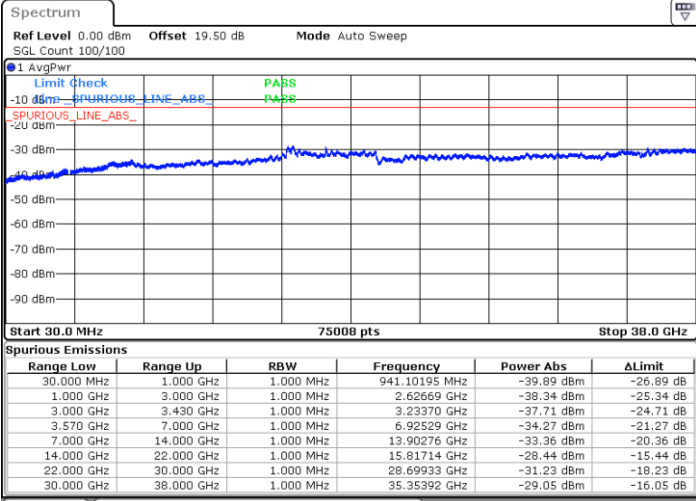

Date: 23.JAN.2025 13:27:48

Date: 23.JAN.2025 13:15:32

Highest Channel / QPSK

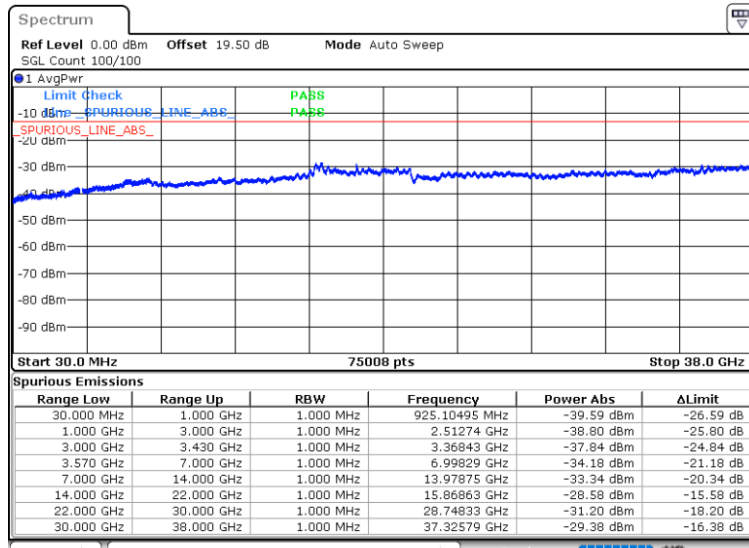

Date: 23.JAN.2025 13:29:08

Frequency Stability

Test Conditions		LTE Band 42 (QPSK) / Middle Channel	Limit
Temperature (°C)	Voltage (Volt)	BW 5MHz	Note 2.
		Frequency Offset (Δf) (Hz)	Result
50	Normal Voltage	-2.6	PASS
40	Normal Voltage	2.2	
30	Normal Voltage	3.1	
20(Ref.)	Normal Voltage	-3	
10	Normal Voltage	3.6	
0	Normal Voltage	3.3	
-10	Normal Voltage	2.8	
-20	Normal Voltage	2.3	
-30	Normal Voltage	4.1	
20	Maximum Voltage	3.7	
20	Normal Voltage	-3	
20	Battery End Point	3.5	

Note:

1. Normal Voltage = 3.91 V. ; Battery End Point (BEP) = 3.6 V. ; Maximum Voltage = 4.5 V.
2. The frequency fundamental emissions stay within the authorized frequency block.

$$\text{MAX}(\Delta f) = 4.1\text{Hz}$$

Frequency Stability	Frequency (MHz)	Limit Line	Result
$f_L - \text{MAX}(\Delta f) $	3450.262196	$\geq 3450\text{MHz}$	PASS
$f_H + \text{MAX}(\Delta f) $	3549.757704	$\leq 3550\text{MHz}$	



Appendix B. Test Results of Radiated Test

Radiated Spurious Emission

Test Engineer :	Shunping You	Temperature :	22~25°C
		Relative Humidity :	48~52%

Note: Pre-scanned harmonic for the different antennas, we choose the worst antenna mode to perform final test and record in the report.

LTE Band 42 / 20MHz / QPSK / Ant. 4									
Channel	Frequency (MHz)	EIRP (dBm)	Limit (dBm)	Over Limit (dB)	SPA Reading (dBm)	S.G. Power (dBm)	TX Cable loss (dB)	TX Antenna Gain (dBi)	Polarization (H/V)
Lowest	6802.00	-56.42	-13	-43.42	-45.09	-59.75	8.25	11.58	H
	10203.00	-46.05	-13	-33.05	-42.41	-47.60	10.45	12.00	H
	13604.00	-52.07	-13	-39.07	-53.52	-53.78	11.74	13.45	H
	6802.00	-55.64	-13	-42.64	-43.94	-58.97	8.25	11.58	V
	10203.00	-50.81	-13	-37.81	-46.79	-52.36	10.45	12.00	V
	13604.00	-52.05	-13	-39.05	-53.27	-53.76	11.74	13.45	V
Middle	6982.00	-56.16	-13	-43.16	-45.47	-59.46	8.30	11.60	H
	10473.00	-42.37	-13	-29.37	-39.17	-43.89	10.48	12.00	H
	13964.00	-52.73	-13	-39.73	-53.89	-54.43	11.80	13.50	H
	6982.00	-57.66	-13	-44.66	-47.13	-60.96	8.30	11.60	V
	10473.00	-46.97	-13	-33.97	-43.69	-48.49	10.48	12.00	V
	13964.00	-52.99	-13	-39.99	-53.78	-54.69	11.80	13.50	V
Highest	7062.00	-57.29	-13	-44.29	-46.97	-60.59	8.32	11.62	H
	10593.00	-47.90	-13	-34.90	-45.19	-49.58	10.52	12.20	H
	14124.00	-51.89	-13	-38.89	-53.42	-53.59	11.85	13.55	H
	7062.00	-57.93	-13	-44.93	-47.77	-61.23	8.32	11.62	V
	10593.00	-51.93	-13	-38.93	-49.12	-53.61	10.52	12.20	V
	14124.00	-52.42	-13	-39.42	-53.61	-54.12	11.85	13.55	V

Remark: Spurious emissions within 30-1000MHz were found more than 20dB below limit line.