



FCC RF Test Report

APPLICANT : Motorola Mobility LLC
EQUIPMENT : Mobile Cellular Phone
BRAND NAME : Motorola
MODEL NAME : XT2515-1, XT2515-2, XT2515-3, XT2515V
FCC ID : IHDT56AU5
STANDARD : 47 CFR Part 27(H), 27(F), 27(N)
CLASSIFICATION : PCS Licensed Transmitter Held to Ear (PCE)
TEST DATE(S) : Sep. 26, 2024 ~ Oct. 08, 2024

We, Sporton International Inc. (Kunshan), would like to declare that the tested sample has been evaluated in accordance with the procedures given in ANSI C63.26-2015 and shown compliance with the applicable technical standards.

The test results in this report apply exclusively to the tested model / sample. Without written approval of Sporton International Inc. (Kunshan), the test report shall not be reproduced except in full.

Jason Jia

Approved by: Jason Jia



Sporton International Inc. (Kunshan)

**No. 1098, Pengxi North Road, Kunshan Economic Development Zone Jiangsu Province 215300
People's Republic of China**



TABLE OF CONTENTS

REVISION HISTORY... 3
SUMMARY OF TEST RESULT ... 4
1 GENERAL DESCRIPTION ... 5
1.1 Applicant ... 5
1.2 Manufacturer ... 5
1.3 Product Feature of Equipment Under Test ... 5
1.4 Product Specification of Equipment Under Test ... 5
1.5 Modification of EUT ... 6
1.6 Maximum ERP and Emission Designator ... 6
1.7 Testing Location ... 7
1.8 Test Software ... 7
1.9 Applicable Standards ... 8
1.10 Specification of Accessory ... 8
2 TEST CONFIGURATION OF EQUIPMENT UNDER TEST ... 9
2.1 Test Mode ... 9
2.2 Connection Diagram of Test System ... 11
2.3 Support Unit used in test configuration and system ... 11
2.4 Measurement Results Explanation Example ... 11
2.5 Frequency List of Low/Middle/High Channels ... 12
3 CONDUCTED TEST ITEMS ... 14
3.1 Measuring Instruments ... 14
3.2 Test Setup ... 14
3.3 Test Result of Conducted Test ... 14
3.4 Conducted Output Power and ERP/EIRP ... 15
3.5 Peak-to-Average Ratio ... 16
3.6 Occupied Bandwidth ... 17
3.7 Conducted Band Edge ... 18
3.8 Conducted Spurious Emission ... 19
3.9 Frequency Stability ... 20
4 RADIATED TEST ITEMS ... 21
4.1 Measuring Instruments ... 21
4.2 Test Setup ... 21
4.3 Test Result of Radiated Test ... 22
4.4 Radiated Spurious Emission ... 23
5 LIST OF MEASURING EQUIPMENT ... 24
6 MEASUREMENT UNCERTAINTY ... 25
APPENDIX A. TEST RESULTS OF CONDUCTED TEST
APPENDIX B. TEST RESULTS OF RADIATED TEST
APPENDIX C. TEST SETUP PHOTOGRAPHS



REVISION HISTORY

REPORT NO.	VERSION	DESCRIPTION	ISSUED DATE
FG483010C	Rev. 01	Initial issue of report	Oct. 17, 2024



SUMMARY OF TEST RESULT

Report Section	FCC Rule	Description	Limit	Result	Remark
3.4	§2.1046	Conducted Output Power	-	Report Only	-
	§27.50(b)(10) §27.50(c)(10)	Effective Radiated Power (Band 12) (Band 13) (Band 17) (Band 71)	ERP < 3 Watt		-
3.5	N/A	Peak-to-Average Ratio	<13 dB	PASS	-
3.6	§2.1049	Occupied Bandwidth	-	Report Only	-
3.7	§2.1051 §27.53(c)(2)(4) §27.53(g)	Conducted Band Edge Measurement (Band 12) (Band 13) (Band 17) (Band 71)	< 43+10log ₁₀ (P[Watts])	PASS	-
3.8	§2.1051 §27.53(c)(2) §27.53(g)	Conducted Spurious Emission (Band 12) (Band 13) (Band 17) (Band 71)	< 43+10log ₁₀ (P[Watts])	PASS	-
3.9	§2.1055 §27.54	Frequency Stability Temperature & Voltage	Within Authorized Band	PASS	-
4.4	§2.1053 §27.53(c)(2) §27.53(f) §27.53(g)	Radiated Spurious Emission (Band 12) (Band 13) (Band 17) (Band 71)	< 43+10log ₁₀ (P[Watts])	PASS	Under limit 6.63 dB at 1568.00 MHz

Conformity Assessment Condition:

- The test results (PASS/FAIL) with all measurement uncertainty excluded are presented against the regulation limits or in accordance with the requirements stipulated by the applicant/manufacturer who shall bear all the risks of non-compliance that may potentially occur if measurement uncertainty is taken into account.
- The measurement uncertainty please refer to each test result in the section "Measurement Uncertainty"

Disclaimer:

The product specifications of the EUT presented in the test report that may affect the test assessments are declared by the manufacturer who shall take full responsibility for the authenticity.



1 General Description

1.1 Applicant

Motorola Mobility LLC
222 W,Merchandise Mart Plaza, Chicago IL 60654 USA

1.2 Manufacturer

Motorola Mobility LLC
222 W,Merchandise Mart Plaza, Chicago IL 60654 USA

1.3 Product Feature of Equipment Under Test

Product Feature	
Equipment	Mobile Cellular Phone
Brand Name	Motorola
Model Name	XT2515-1, XT2515-2, XT2515-3, XT2515V
FCC ID	IHDT56AU5
IMEI Code	Conducted: 350213730022436/350213730022444 Radiation: 350213730021792/350213730021800
HW Version	DVT2
SW Version	VVE35.35
EUT Stage	Identical Prototype

Remark: The four model names are only for market segment, no other difference.

1.4 Product Specification of Equipment Under Test

Standards-related Product Specification	
Tx Frequency	LTE Band 12 : 699 MHz ~ 716 MHz LTE Band 13 : 777 MHz ~ 787 MHz LTE Band 17 : 704 MHz ~ 716 MHz LTE Band 71: 663 MHz ~ 698 MHz
Rx Frequency	LTE Band 12 : 729 MHz ~ 746 MHz LTE Band 13 : 746 MHz ~ 756 MHz LTE Band 17 : 734 MHz ~ 746 MHz LTE Band 71: 617 MHz ~ 652 MHz
Bandwidth	LTE Band 12 : 1.4MHz / 3MHz / 5MHz / 10MHz LTE Band 13 : 5MHz / 10MHz LTE Band 17 : 5MHz / 10MHz LTE Band 71 : 5MHz / 10MHz / 15MHz / 20MHz
Maximum Output Power to Antenna	<Ant.0> LTE Band 12 : 22.99 dBm LTE Band 13 : 22.92 dBm LTE Band 17 : 22.99 dBm LTE Band 71 : 23.09 dBm <Ant.4>



	LTE Band 12 : 23.21 dBm LTE Band 13 : 23.11 dBm LTE Band 17 : 23.21 dBm LTE Band 71 : 23.19 dBm
Antenna Gain	<Ant.0> LTE Band 12/17 : -6.7 dBi LTE Band 13 : -6.7 dBi LTE Band 71 : -8.1 dBi <Ant.4> LTE Band 12/17 : -8.4 dBi LTE Band 13 : -9.5 dBi LTE Band 71 : -9.6 dBi
Type of Modulation	QPSK / 16QAM / 64QAM / 256QAM

Note: The maximum ERP is calculated from max output power and max antenna gain, only the maximum ERP of Antenna 0 for LTE Band 12/13/17/71 are shown in the report.

1.5 Modification of EUT

No modifications are made to the EUT during all test items.

1.6 Maximum ERP and Emission Designator

LTE Band 12		QPSK		16QAM/64QAM/256QAM	
BW (MHz)	Frequency Range (MHz)	Maximum ERP(W)	Emission Designator (99%OBW)	Maximum ERP(W)	Emission Designator (99%OBW)
1.4	699.7 ~ 715.3	0.0247	1M10G7D	0.0191	1M09W7D
3	700.5 ~ 714.5	0.0259	2M75G7D	0.0193	2M75W7D
5	701.5 ~ 713.5	0.0259	4M50G7D	0.0196	4M47W7D
10	704.0 ~ 711.0	0.0259	9M01G7D	0.0200	9M01W7D
LTE Band 13		QPSK		16QAM/64QAM/256QAM	
BW (MHz)	Frequency Range (MHz)	Maximum ERP(W)	Emission Designator (99%OBW)	Maximum ERP(W)	Emission Designator (99%OBW)
5	779.5 ~ 784.5	0.0254	4M48G7D	0.0200	4M51W7D
10	782.0	0.0255	9M03G7D	0.0205	8M99W7D
LTE Band 17		QPSK		16QAM/64QAM/256QAM	
BW (MHz)	Frequency Range (MHz)	Maximum ERP(W)	Emission Designator (99%OBW)	Maximum ERP(W)	Emission Designator (99%OBW)
5	706.5 ~ 713.5	0.0252	4M50G7D	0.0205	4M47W7D
10	709.0 ~ 711.0	0.0259	9M01G7D	0.0206	9M01W7D



LTE Band 71		QPSK		16QAM/64QAM/256QAM	
BW (MHz)	Frequency Range (MHz)	Maximum ERP(W)	Emission Designator (99%OBW)	Maximum ERP(W)	Emission Designator (99%OBW)
5	665.5 ~ 695.5	0.0188	4M54G7D	0.0147	4M48W7D
10	668.0 ~ 693.0	0.0190	8M99G7D	0.0149	9M03W7D
15	670.5 ~ 690.5	0.0191	13M5G7D	0.0149	13M4W7D
20	673.0 ~ 688.0	0.0192	17M9G7D	0.0153	17M9W7D

Note:

- LTE Band 12 overlaps the entire frequency range of LTE Band 17. Therefore, the test results provided in this report covers Band 12 as well as Band 17.
- All modulations have been tested, only the worst test results of PSK & QAM are shown in the report.

1.7 Testing Location

Sporton International Inc. (Kunshan) is accredited to ISO/IEC 17025:2017 by American Association for Laboratory Accreditation with Certificate Number 5145.02.

Test Firm	Sporton International Inc. (Kunshan)		
Test Site Location	No. 1098, Pengxi North Road, Kunshan Economic Development Zone Jiangsu Province 215300 People's Republic of China TEL : +86-512-57900158		
Test Site No.	Sporton Site No.	FCC Designation No.	FCC Test Firm Registration No.
	03CH04-KS TH01-KS	CN1257	314309

1.8 Test Software

Item	Site	Manufacturer	Name	Version
1.	TH01-KS	SPORTON	Part2224_Ver5.0 200330	5.0
2.	03CH04-KS	AUDIX	E3	210616



1.9 Applicable Standards

According to the specifications of the manufacturer, the EUT must comply with the requirements of the following standards:

- 47 CFR Part 27(H), 27(F), 27(N)
- ANSI C63.26-2015
- FCC KDB 971168 D01 Power Meas License Digital Systems v03r01
- FCC KDB 412172 D01 Determining ERP and EIRP v01r01

Remark:

1. All test items were verified and recorded according to the standards and without any deviation during the test.
2. This EUT has also been tested and complied with the requirements of FCC Part 15, Subpart B, recorded in a separate test report.

1.10 Specification of Accessory

Accessories Information				
AC Adapter 1	Brand Name	Motorola(Aohai)	Model Name	MC-201L
Battery 1	Brand Name	Motorola(NVT)	Model Name	RW50
USB Cable 1	Brand Name	Motorola(Saibao)	Model Name	S928E42856
USB Cable 2	Brand Name	Motorola(Naiyi)	Model Name	S928E42857
USB Cable 3	Brand Name	Motorola(Saibao)	Model Name	S928E44701
USB Cable 4	Brand Name	Motorola(Naiyi)	Model Name	S928E44702



2 Test Configuration of Equipment Under Test

2.1 Test Mode

Antenna port conducted and radiated test items listed below are performed according to KDB 971168 D01 Power Meas License Digital Systems v03r01 with maximum output power.

Radiated measurements are performed by rotating the EUT in three different orthogonal test planes to find the maximum emission(X Plane).

Test Items	Band	Bandwidth (MHz)						Modulation				RB #			Test Channel		
		1.4	3	5	10	15	20	QPSK	16 QAM	64 QAM	256 QAM	1	Half	Full	L	M	H
Max. Output Power	12	v	v	v	v	-	-	v	v	v	v	v		v	v	v	v
	13	-	-	v	v	-	-	v	v	v	v	v		v	v	v	v
	17	-	-	v	v	-	-	v	v	v	v	v		v	v	v	v
	71	-	-	v	v	v	v	v	v	v	v	v		v	v	v	v
Peak-to-Average Ratio	12				v	-	-	v	v	v	v			v		v	
	13	-	-		v	-	-	v	v	v	v			v		v	
	71	-	-				v	v	v	v	v			v		v	
26dB and 99% Bandwidth	12	v	v	v	v	-	-	v	v					v		v	
	13	-	-	v	v	-	-	v	v					v		v	
	71	-	-	v	v	v	v	v	v					v		v	
Conducted Band Edge	12	v	v	v	v	-	-	v	v	v	v	v		v	v		v
	13	-	-	v	v	-	-	v	v	v	v	v		v	v		v
	71	-	-	v	v	v	v	v	v	v	v	v		v	v		v



Test Items	Band	Bandwidth (MHz)						Modulation			RB #			Test Channel			
		1.4	3	5	10	15	20	QPSK	16 QAM	64 QAM	256 QAM	1	Half	Full	L	M	H
Conducted Spurious Emission	12	v	v	v	v	-	-	v				v			v	v	v
	13	-	-	v	v	-	-	v				v			v	v	v
	71	-	-	v	v	v	v	v				v			v	v	v
Frequency Stability	12				v	-	-	v				v				v	
	13	-	-		v	-	-	v				v				v	
	71	-	-		v			v				v				v	
E.R.P	12	v	v	v	v	-	-	v	v	v	v	v		v	v	v	v
	13	-	-	v	v	-	-	v	v	v	v	v		v	v	v	v
	17	-	-	v	v	-	-	v	v	v	v	v		v	v	v	v
	71	-	-	v	v	v	v	v	v	v	v	v		v	v	v	v
Radiated Spurious Emission	12	Worst Case												v	v	v	
	13	Worst Case												v	v	v	
	71	Worst Case												v	v	v	
Note	<p>1. The mark "v" means that this configuration is chosen for testing</p> <p>2. The mark "-" means that this bandwidth is not supported.</p> <p>3. The device is investigated from 30MHz to 10 times of fundamental signal for radiated spurious emission test under different RB size/offset and modulations in exploratory test. Subsequently, only the worst case emissions are reported.</p> <p>4. LTE Band 12 overlaps the entire frequency range of LTE Band 17. Therefore, the test results provided in this report covers Band 12 as well as Band 17.</p>																

2.2 Connection Diagram of Test System

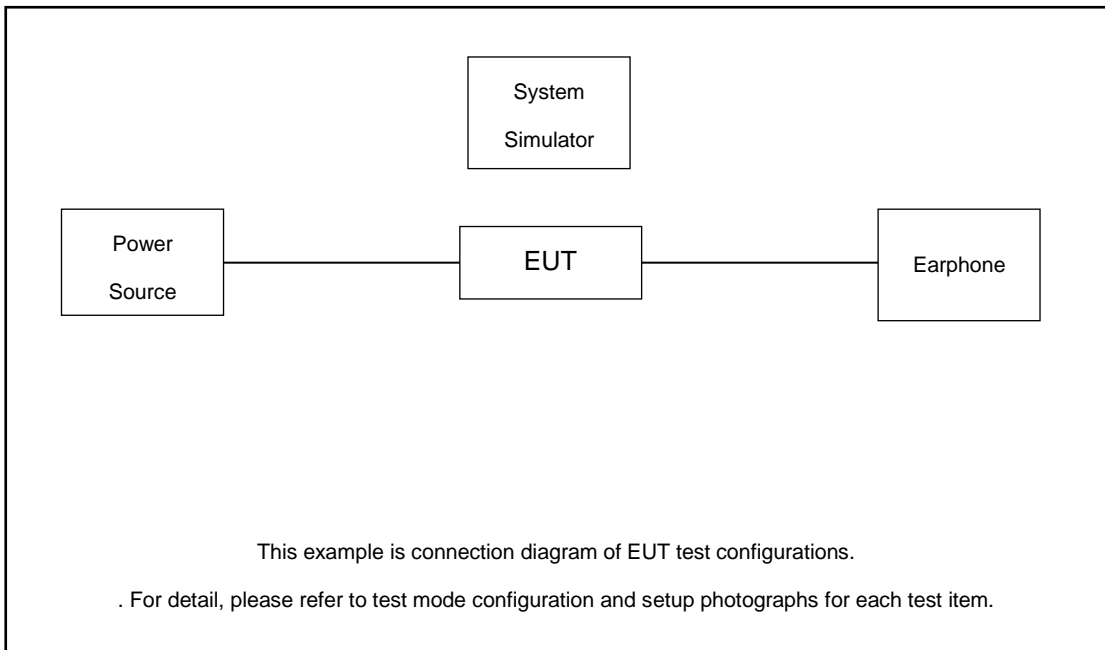

2.3 Support Unit used in test configuration and system

Item	Equipment	Trade Name	Model No.	FCC ID	Data Cable	Power Cord
1.	Power Supply	GWINSTEK	PSS-2002	N/A	N/A	Unshielded, 1.8 m
2.	LTE Base Station	Anritsu	MT8820C	N/A	N/A	Unshielded, 1.8 m
3.	Earphone	Lenovo	P121	N/A	N/A	N/A

2.4 Measurement Results Explanation Example

For all conducted test items:

The offset level is set in the spectrum analyzer to compensate the RF cable loss between EUT conducted output port and spectrum analyzer. With the offset compensation, the spectrum analyzer reading level is exactly the EUT RF output level.

The spectrum analyzer offset is derived from RF cable loss.

$$\text{Offset} = \text{RF cable loss.}$$

Following shows an offset computation example with cable loss 4.8 dB.

Example :

$$\begin{aligned} \text{Offset(dB)} &= \text{RF cable loss(dB)}. \\ &= 4.8 \text{ (dB)} \end{aligned}$$



2.5 Frequency List of Low/Middle/High Channels

LTE Band 12 Channel and Frequency List				
BW [MHz]	Channel/Frequency(MHz)	Lowest	Middle	Highest
10	Channel	23060	23095	23130
	Frequency	704	707.5	711
5	Channel	23035	23095	23155
	Frequency	701.5	707.5	713.5
3	Channel	23025	23095	23165
	Frequency	700.5	707.5	714.5
1.4	Channel	23017	23095	23173
	Frequency	699.7	707.5	715.3

LTE Band 13 Channel and Frequency List				
BW [MHz]	Channel/Frequency(MHz)	Lowest	Middle	Highest
10	Channel	-	23230	-
	Frequency	-	782	-
5	Channel	23205	23230	23255
	Frequency	779.5	782	784.5

LTE Band 17 Channel and Frequency List				
BW [MHz]	Channel/Frequency(MHz)	Lowest	Middle	Highest
10	Channel	23780	23790	23800
	Frequency	709	710	711
5	Channel	23755	23790	23825
	Frequency	706.5	710	713.5



LTE Band 71 Channel and Frequency List				
BW [MHz]	Channel/Frequency(MHz)	Lowest	Middle	Highest
20	Channel	133222	133322	133372
	Frequency	673.0	680.5	688.0
15	Channel	133197	133297	133397
	Frequency	670.5	680.5	690.5
10	Channel	133172	133272	133422
	Frequency	668.0	678.0	693.0
5	Channel	133147	133247	133447
	Frequency	665.5	675.5	695.5

3 Conducted Test Items

3.1 Measuring Instruments

See list of measuring instruments of this test report.

3.2 Test Setup

3.2.1 Conducted Output Power

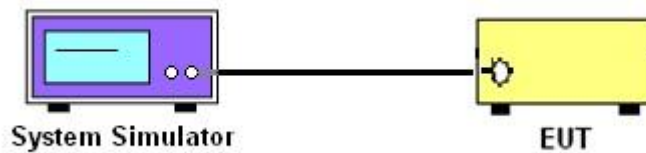

3.2.2 Peak-to-Average Ratio, Occupied Bandwidth ,Conducted Band-Edge and Conducted Spurious Emission

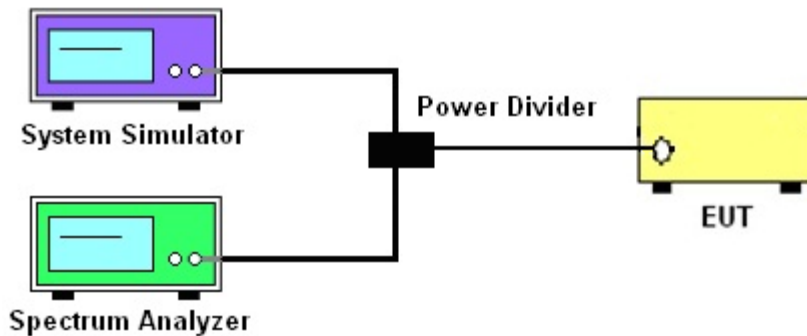

3.2.3 Frequency Stability

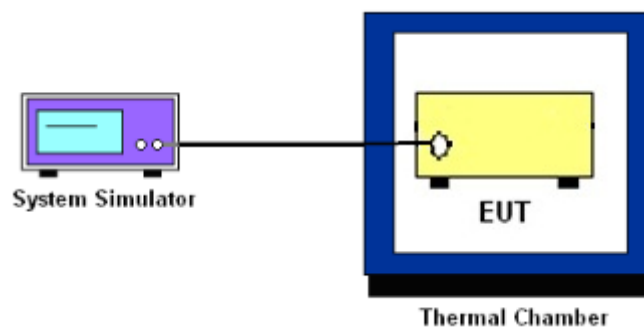

3.3 Test Result of Conducted Test

Please refer to Appendix A.



3.4 Conducted Output Power and ERP/EIRP

3.4.1 Description of the Conducted Output Power Measurement and ERP/EIRP Measurement

A system simulator was used to establish communication with the EUT. Its parameters were set to force the EUT transmitting at maximum output power. The measured power in the radio frequency on the transmitter output terminals shall be reported.

The ERP of mobile transmitters must not exceed 3 Watts for LTE Band 12, Band 13 and Band 17 and Band 71.

According to KDB 412172 D01 Power Approach,

$EIRP = P_T + G_T - L_C$, $ERP = EIRP - 2.15$, where

P_T = transmitter output power in dBm

G_T = gain of the transmitting antenna in dBi

L_C = signal attenuation in the connecting cable between the transmitter and antenna in dB

3.4.2 Test Procedures

1. The testing follows ANSI C63.26 Section 5.2
2. The transmitter output port was connected to the system simulator.
3. Set EUT at maximum power through the system simulator.
4. Select lowest, middle, and highest channels for each band and different modulation.
5. Measure and record the power level from the system simulator.



3.5 Peak-to-Average Ratio

3.5.1 Description of the PAR Measurement

Power Complementary Cumulative Distribution Function (CCDF) curves provide a means for characterizing the power peaks of a digitally modulated signal on a statistical basis. A CCDF curve depicts the probability of the peak signal amplitude exceeding the average power level. Most contemporary measurement instrumentation include the capability to produce CCDF curves for an input signal provided that the instrument's resolution bandwidth can be set wide enough to accommodate the entire input signal bandwidth. In measuring transmissions in this band using an average power technique, the peak-to-average ratio (PAR) of the transmission may not exceed 13 dB.

3.5.2 Test Procedures

1. The testing follows ANSI C63.26 Section 5.2.3.4 (CCDF).
2. The EUT was connected to spectrum and system simulator via a power divider.
3. Set the CCDF (Complementary Cumulative Distribution Function) option in spectrum analyzer.
4. The highest RF powers were measured and recorded the maximum PAPR level associated with a probability of 0.1 %.
5. Record the deviation as Peak to Average Ratio.



3.6 Occupied Bandwidth

3.6.1 Description of Occupied Bandwidth Measurement

The occupied bandwidth is the width of a frequency band such that, below the lower and above the upper frequency limits, the mean powers emitted are each equal to a specified percentage 0.5% of the total mean transmitted power.

The 26 dB emission bandwidth is defined as the frequency range between two points, one above and one below the carrier frequency, at which the spectral density of the emission is attenuated 26 dB below the maximum in-band spectral density of the modulated signal. Spectral density (power per unit bandwidth) is to be measured with a detector of resolution bandwidth equal to approximately 1.0% of the emission bandwidth.

3.6.2 Test Procedures

1. The testing follows ANSI C63.26 Section 5.4
2. The EUT was connected to spectrum analyzer and system simulator via a power divider.
3. The spectrum analyzer center frequency is set to the nominal EUT channel center frequency. The span range for the spectrum analyzer shall be between two and five times the anticipated OBW.
4. The nominal resolution bandwidth (RBW) shall be in the range of 1 to 5 % of the anticipated OBW, and the VBW shall be at least 3 times the RBW.
5. Set the detection mode to peak, and the trace mode to max hold.
6. Determine the reference value: Set the EUT to transmit a modulated signal. Allow the trace to stabilize. Set the spectrum analyzer marker to the highest level of the displayed trace.
(this is the reference value)
7. Determine the “-26 dB down amplitude” as equal to (Reference Value – X).
8. Place two markers, one at the lowest and the other at the highest frequency of the envelope of the spectral display such that each marker is at or slightly below the “-X dB down amplitude” determined in step 6. If a marker is below this “-X dB down amplitude” value it shall be placed as close as possible to this value. The OBW is the positive frequency difference between the two markers.
9. Use the 99 % power bandwidth function of the spectrum analyzer and report the measured bandwidth.



3.7 Conducted Band Edge

3.7.1 Description of Conducted Band Edge Measurement

27.53 (c)

For operations in the 776-788 MHz band, the FCC limit is $43 + 10\log_{10}(P[\text{Watts}])$ dB below the transmitter power P(Watts) in a 100 kHz bandwidth. However, in the 100 kHz bands immediately outside and adjacent to the frequency block, a resolution bandwidth of at least 30 kHz may be employed. In addition, the power of any unwanted emissions in any 6.25 kHz bandwidth for all frequencies between 763-775 MHz and 793-806 MHz shall be attenuated below the transmitter power, P (dBW), by at least $65 + 10 \log_{10} p(\text{watts})$, dB, for mobile and portable equipment.

27.53 (g)

For operations in the 600MHz band and 698 -746 MHz band, the FCC limit is $43 + 10\log_{10}(P[\text{Watts}])$ dB below the transmitter power P(Watts) in a 100 kHz bandwidth. However, in the 100 kilohertz bands immediately outside and adjacent to a licensee's frequency block, a resolution bandwidth of at least 30 kHz may be employed.

3.7.2 Test Procedures

1. The testing follows ANSI C63.26 section 5.7
1. The EUT was connected to spectrum analyzer and system simulator via a power divider.
2. The band edges of low and high channels for the highest RF powers were measured.
3. Set RBW \geq 1% EBW in the 1MHz band immediately outside and adjacent to the band edge.
4. Beyond the 1 MHz band from the band edge, RBW=1MHz was used or a narrower RBW was used and the measured power was integrated over the full required measurement bandwidth of 1 MHz.
5. Set spectrum analyzer with RMS detector.
6. The RF fundamental frequency should be excluded against the limit line in the operating frequency band.
7. Checked that all the results comply with the emission limit line.

Example:

$$\begin{aligned} &\text{The limit line is derived from } 43 + 10\log(P)\text{dB below the transmitter power } P(\text{Watts}) \\ &= P(\text{W}) - [43 + 10\log(P)] \text{ (dB)} \\ &= [30 + 10\log(P)] \text{ (dBm)} - [43 + 10\log(P)] \text{ (dB)} = -13\text{dBm}. \end{aligned}$$

8. When using the integration method, the starting frequency of the integration shall be centered at one-half of the RBW away from the band edge.



3.8 Conducted Spurious Emission

3.8.1 Description of Conducted Spurious Emission Measurement

The power of any emission outside of the authorized operating frequency ranges must be lower than the transmitter power (P) by a factor of at least $43 + 10 \log (P)$ dB.

It is measured by means of a calibrated spectrum analyzer and scanned from 30 MHz up to a frequency including its 10th harmonic.

3.8.2 Test Procedures

1. The testing follows ANSI C63.26 section 5.7
2. The EUT was connected to spectrum analyzer and system simulator via a power divider.
3. The RF output of EUT was connected to the spectrum analyzer by RF cable and attenuator. The path loss was compensated to the results for each measurement.
4. The middle channel for the highest RF power within the transmitting frequency was measured.
5. The conducted spurious emission for the whole frequency range was taken.
6. Make the measurement with the spectrum analyzer's RBW = 1MHz, VBW = 3MHz.
7. Set spectrum analyzer with RMS detector.
8. Taking the record of maximum spurious emission.
9. The RF fundamental frequency should be excluded against the limit line in the operating frequency band.
10. The limit line is derived from $43 + 10\log(P)$ dB below the transmitter power P(Watts)
= $P(W) - [43 + 10\log(P)]$ (dB)
= $[30 + 10\log(P)]$ (dBm) - $[43 + 10\log(P)]$ (dB)
= -13dBm.



3.9 Frequency Stability

3.9.1 Description of Frequency Stability Measurement

The frequency stability shall be measured by variation of ambient temperature and variation of primary supply voltage to ensure that the fundamental emission stays within the authorized frequency block. The frequency stability of the transmitter shall be maintained within $\pm 0.00025\%$ ($\pm 2.5\text{ppm}$) of the center frequency.

3.9.2 Test Procedures for Temperature Variation

1. The testing follows ANSI C63.26 section 5.6.4
2. The EUT was set up in the thermal chamber and connected with the system simulator.
3. With power OFF, the temperature was decreased to -30°C and the EUT was stabilized before testing. Power was applied and the maximum change in frequency was recorded within one minute.
4. With power OFF, the temperature was raised in 10°C step up to 50°C . The EUT was stabilized at each step for at least half an hour. Power was applied and the maximum frequency change was recorded within one minute.

3.9.3 Test Procedures for Voltage Variation

1. The testing follows ANSI C63.26 section 5.6.5
2. The EUT was placed in a temperature chamber at $20\pm 5^{\circ}\text{C}$ and connected with the system simulator.
3. The power supply voltage to the EUT was varied from 85% to 115% of the nominal value for other than hand carried battery equipment.
4. For hand carried, battery powered equipment, reduce the primary ac or dc supply voltage to the battery operating end point, which shall be specified by the manufacturer.
5. The variation in frequency was measured for the worst case.

4 Radiated Test Items

4.1 Measuring Instruments

See list of measuring instruments of this test report.

4.2 Test Setup

4.2.1 For radiated test below 30MHz

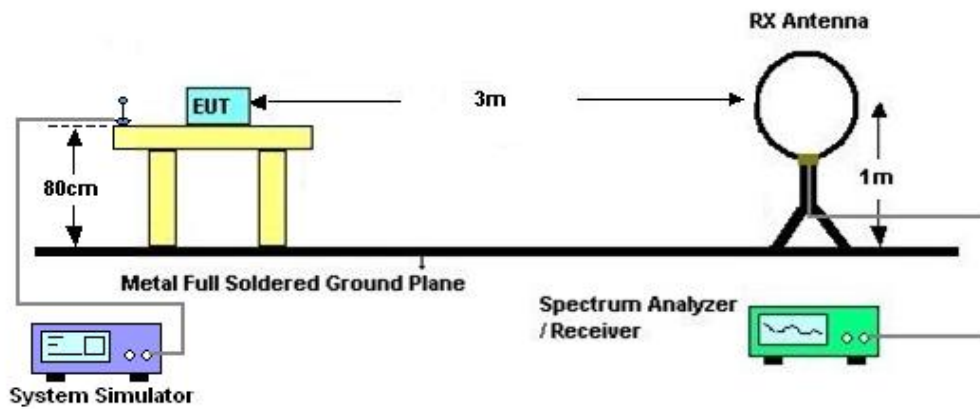

4.2.2 For radiated test from 30MHz to 1GHz

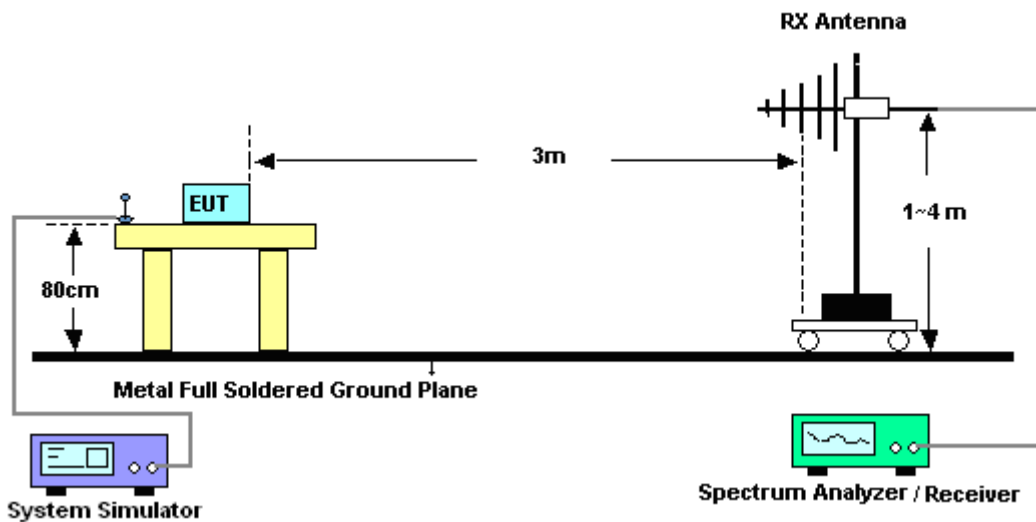

4.2.3 For radiated test above 1GHz

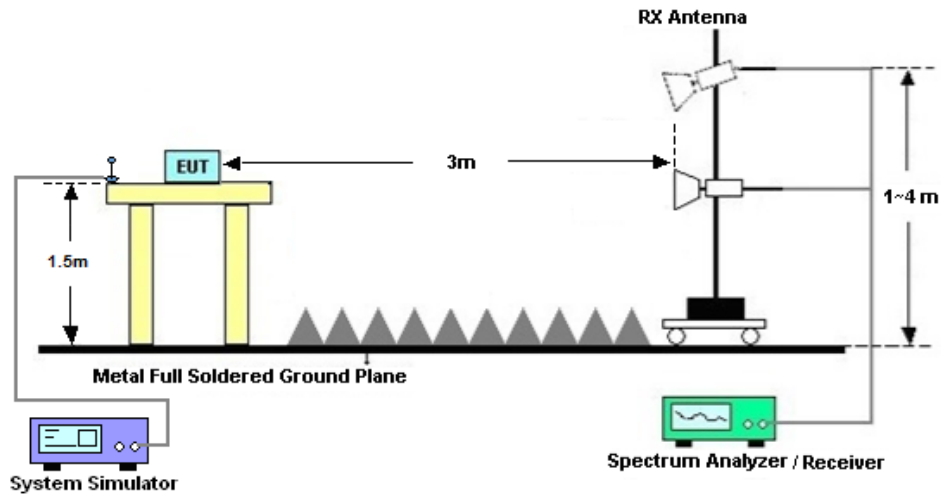

4.3 Test Result of Radiated Test

The low frequency, which started from 9 kHz to 30MHz, was pre-scanned and the result which was 20dB lower than the limit line was not reported.

Please refer to Appendix B.



4.4 Radiated Spurious Emission

4.4.1 Description of Radiated Spurious Emission

The radiated spurious emission was measured by substitution method according to ANSI C63.26. The power of any emission outside of the authorized operating frequency ranges must be attenuated below the transmitter power (P) by a factor of at least $43 + 10 \log (P)$ dB.

For LTE Band 13

For operations in the 746-758 MHz, 775-788 MHz, and 805-806 MHz bands, emissions in the band 1559-1610 MHz shall be limited to -70 dBW/MHz equivalent isotropically radiated power (EIRP) for wideband signals, and -80 dBW EIRP for discrete emissions of less than 700 Hz bandwidth.

The spectrum is scanned from 30 MHz up to a frequency including its 10th harmonic.

4.4.2 Test Procedures

1. The testing follows ANSI C63.26 Section 5.5
2. The EUT was placed on a turntable with 0.8 meter height for frequency below 1GHz and 1.5 meter height for frequency above 1GHz respectively above ground.
3. The EUT was set 3 meters from the receiving antenna mounted on the antenna tower.
4. The table was rotated 360 degrees to determine the position of the highest spurious emission.
5. The height of the receiving antenna is varied between 1m to 4m to search the maximum spurious emission for both horizontal and vertical polarizations.
6. During the measurement, the system simulator parameters were set to force the EUT transmitting at maximum output power.
7. Make the measurement with the spectrum analyzer's RBW = 1MHz, VBW = 3MHz, taking the record of maximum spurious emission.
8. A horn antenna was substituted in place of the EUT and was driven by a signal generator.
9. Tune the output power of signal generator to the same emission level with EUT maximum spurious emission.
10. $EIRP (dBm) = S.G. Power - Tx Cable Loss + Tx Antenna Gain$
11. $ERP (dBm) = EIRP - 2.15$
12. The RF fundamental frequency should be excluded against the limit line in the operating frequency band.

The limit line is derived from $43 + 10\log(P)$ dB below the transmitter power P(Watts)

$$= P(W) - [43 + 10\log(P)] (dB)$$

$$= [30 + 10\log(P)] (dBm) - [43 + 10\log(P)] (dB)$$

$$= -13dBm.$$



5 List of Measuring Equipment

Instrument	Manufacturer	Model No.	Serial No.	Characteristics	Calibration Date	Test Date	Due Date	Remark
Spectrum Analyzer	R&S	FSV40	101040	10Hz~40GHz	Oct. 11, 2023	Sep. 26, 2024~ Sep. 27, 2024	Oct. 10, 2024	Conducted (TH01-KS)
Power divider	STI	STI08-0055	-	0.5~40GHz	NCR	Sep. 26, 2024~ Sep. 27, 2024	NCR	Conducted (TH01-KS)
Temperature & humidity	Hongzhan	LP-150U	H2014011440	-40~+150°C 20%~95%RH	Jul. 04, 2024	Sep. 26, 2024~ Sep. 27, 2024	Jul. 03, 2025	Conducted (TH01-KS)
EXA Spectrum Analyzer	Keysight	N9010B	MY57471079	10Hz-44G,MAX 30dB	Oct. 11, 2023	Oct. 08, 2024	Oct. 10, 2024	Radiation (03CH04-KS)
Loop Antenna	R&S	HFH2-Z2E	101125	9kHz~30MHz	Sep. 08, 2024	Oct. 08, 2024	Sep. 07, 2025	Radiation (03CH04-KS)
Bilog Antenna	TeseQ	CBL6111D	44483	30MHz-1GHz	Dec. 06, 2023	Oct. 08, 2024	Dec. 05, 2024	Radiation (03CH04-KS)
Double Ridge Horn Antenna	ETS-Lindgren	3117	75957	1GHz~18GHz	Oct. 23, 2023	Oct. 08, 2024	Oct. 22, 2024	Radiation (03CH04-KS)
SHF-EHF Horn	Com-power	AH-840	101070	18GHz~40GHz	Jan. 27, 2024	Oct. 08, 2024	Jan. 26, 2025	Radiation (03CH04-KS)
Amplifier	SONOMA	310N	413740	9KHz-1GHz	Jan. 03, 2024	Oct. 08, 2024	Jan. 02, 2025	Radiation (03CH04-KS)
Amplifier	EM	EM18G40G A	060728	18~40GHz	Jan. 02, 2024	Oct. 08, 2024	Jan. 01, 2025	Radiation (03CH04-KS)
high gain Amplifier	EM	EM01G18G A	060840	1Ghz-18Ghz	Oct. 11, 2023	Oct. 08, 2024	Oct. 10, 2024	Radiation (03CH04-KS)
Amplifier	EM	EM01G18G A	060892	1Ghz-18Ghz	Oct. 11, 2023	Oct. 08, 2024	Oct. 10, 2024	Radiation (03CH04-KS)
AC Power Source	Chroma	61601	F104090004	N/A	NCR	Oct. 08, 2024	NCR	Radiation (03CH04-KS)
Turn Table	ChamPro	EM 1000-T	060762-T	0~360 degree	NCR	Oct. 08, 2024	NCR	Radiation (03CH04-KS)
Antenna Mast	ChamPro	EM 1000-A	060762-A	1 m~4 m	NCR	Oct. 08, 2024	NCR	Radiation (03CH04-KS)

NCR: No Calibration Required



6 Measurement Uncertainty

The measurement uncertainties shown below were calculated in accordance with the requirements of ANSI 63.26-2015. All the measurement uncertainty value were shown with a coverage K=2 to indicate 95% level of confidence. The measurement data show herein meets or exceeds the CISPR measurement uncertainty values specified in CISPR 16-4-2 and can be compared directly to specified limit to determine compliance.

Uncertainty of Conducted Measurement

Conducted Spurious Emission & Bandedge	±2.22 dB
Occupied Channel Bandwidth	±0.1%
Conducted Power	±0.50 dB
Peak to Average Ratio	±0.50 dB
Frequency Stability	±0.04 Hz

Uncertainty of Radiated Emission Measurement (30 MHz ~ 1000 MHz)

Measuring Uncertainty for a Level of Confidence of 95% (U = 2Uc(y))	2.83 dB
---	---------

Uncertainty of Radiated Emission Measurement (1 GHz ~ 18 GHz)

Measuring Uncertainty for a Level of Confidence of 95% (U = 2Uc(y))	2.83 dB
---	---------

Uncertainty of Radiated Emission Measurement (18 GHz ~ 40 GHz)

Measuring Uncertainty for a Level of Confidence of 95% (U = 2Uc(y))	2.82 dB
---	---------

----- THE END -----



Appendix A. Test Results of Conducted Test

Test Engineer :	Smile	Temperature :	24~26°C
		Relative Humidity :	50~53%

Conducted Output Power(Average power) and ERP

LTE Band 12_Ant.0

BW [MHz]	Modulation	RB Size	RB Offset	Power	Power	Power	ERP(W)		
				Low Ch. / Freq.	Middle Ch. / Freq.	High Ch. / Freq.			
Channel				23060	23095	23130			
Frequency (MHz)				704	707.5	711	L	M	H
10	QPSK	1	0	22.96	22.99	22.97	0.0258	0.0259	0.0258
10	QPSK	1	49	22.88	22.78	22.78	0.0253	0.0247	0.0247
10	QPSK	50	0	21.67	21.88	21.76	0.0191	0.0201	0.0195
10	16QAM	1	0	21.76	21.86	21.62	0.0195	0.0200	0.0189
10	64QAM	1	0	20.85	20.72	20.64	0.0158	0.0154	0.0151
10	256QAM	1	0	17.76	17.93	17.75	0.0078	0.0081	0.0078
Channel				23035	23095	23155	ERP(W)		
Frequency (MHz)				701.5	707.5	713.5	L	M	H
5	QPSK	1	0	22.78	22.98	22.84	0.0247	0.0259	0.0251
5	16QAM	1	0	21.67	21.77	21.48	0.0191	0.0196	0.0183
Channel				23025	23095	23165	ERP(W)		
Frequency (MHz)				700.5	707.5	714.5	L	M	H
3	QPSK	1	0	22.95	22.91	22.98	0.0257	0.0255	0.0259
3	16QAM	1	0	21.69	21.70	21.41	0.0192	0.0193	0.0180
Channel				23017	23095	23173	ERP(W)		
Frequency (MHz)				699.7	707.5	715.3	L	M	H
1.4	QPSK	1	0	22.73	22.74	22.77	0.0244	0.0245	0.0247
1.4	16QAM	1	0	21.56	21.65	21.56	0.0187	0.0191	0.0187



LTE Band 13_Ant.0

BW [MHz]	Modulation	RB Size	RB Offset	Power	Power	Power	ERP(W)		
				Low Ch. / Freq.	Middle Ch. / Freq.	High Ch. / Freq.			
Channel				23230					
Frequency (MHz)				782				M	
10	QPSK	1	0		22.92			0.0255	
10	QPSK	1	49		22.71			0.0243	
10	QPSK	50	0		21.98			0.0206	
10	16QAM	1	0		21.97			0.0205	
10	64QAM	1	0		21.09			0.0167	
10	256QAM	1	0		17.98			0.0082	
Channel				23205	23230	23255	ERP(W)		
Frequency (MHz)				779.5	782	784.5	L	M	H
5	QPSK	1	0	22.81	22.90	22.85	0.0249	0.0254	0.0251
5	16QAM	1	0	21.87	21.82	21.77	0.0200	0.0198	0.0196

LTE Band 17_Ant.0

BW [MHz]	Modulation	RB Size	RB Offset	Power	Power	Power	ERP(W)		
				Low Ch. / Freq.	Middle Ch. / Freq.	High Ch. / Freq.			
Channel				23780	23790	23800			
Frequency (MHz)				709	710	711	L	M	H
10	QPSK	1	0	22.96	22.99	22.96	0.0258	0.0259	0.0258
10	QPSK	1	49	22.87	22.87	22.97	0.0252	0.0252	0.0258
10	QPSK	50	0	21.68	21.93	21.90	0.0192	0.0203	0.0202
10	16QAM	1	0	21.92	21.98	21.78	0.0203	0.0206	0.0196
10	64QAM	1	0	20.67	20.89	20.81	0.0152	0.0160	0.0157
10	256QAM	1	0	17.80	18.07	17.84	0.0079	0.0084	0.0079
Channel				23755	23790	23825	ERP(W)		
Frequency (MHz)				706.5	710	713.5	L	M	H
5	QPSK	1	0	22.79	22.80	22.86	0.0248	0.0248	0.0252
5	16QAM	1	0	21.82	21.96	21.66	0.0198	0.0205	0.0191



LTE Band 71_Ant.0

BW [MHz]	Modulation	RB Size	RB Offset	Power Low Ch. / Freq.	Power Middle Ch. / Freq.	Power High Ch. / Freq.	ERP(W)		
Channel				133222	133322	133372			
Frequency (MHz)				673	683	688	L	M	H
20	QPSK	1	0	23.07	23.09	23.07	0.0191	0.0192	0.0191
20	QPSK	1	99	23.08	22.95	22.96	0.0192	0.0186	0.0187
20	QPSK	100	0	22.05	22.07	21.85	0.0151	0.0152	0.0145
20	16QAM	1	0	21.97	21.97	22.11	0.0149	0.0149	0.0153
20	64QAM	1	0	20.97	21.06	21.06	0.0118	0.0121	0.0121
20	256QAM	1	0	17.53	17.61	17.53	0.0053	0.0054	0.0053
Channel				133197	133297	133397	EIRP(W)		
Frequency (MHz)				670.5	680.5	690.5	L	M	H
15	QPSK	1	0	23.07	23.06	22.86	0.0191	0.0191	0.0182
15	16QAM	1	0	21.97	21.91	21.92	0.0149	0.0147	0.0147
Channel				133172	133272	133422	EIRP(W)		
Frequency (MHz)				668	678	693	L	M	H
10	QPSK	1	0	23.01	23.03	22.94	0.0189	0.0190	0.0186
10	16QAM	1	0	21.87	21.84	21.97	0.0145	0.0144	0.0149
Channel				133147	133247	133447	EIRP(W)		
Frequency (MHz)				665.5	675.5	695.5	L	M	H
5	QPSK	1	0	22.99	22.90	22.86	0.0188	0.0184	0.0182
5	16QAM	1	0	21.76	21.91	21.91	0.0142	0.0147	0.0147



LTE Band 12

Peak-to-Average Ratio

Mode	LTE Band 12 / 10MHz				
Mod.	QPSK	16QAM	64QAM	256QAM	Limit: 13dB
RB Size	Full RB	Full RB	Full RB	Full RB	Result
Middle CH	5.33	6.23	6.52	6.72	PASS

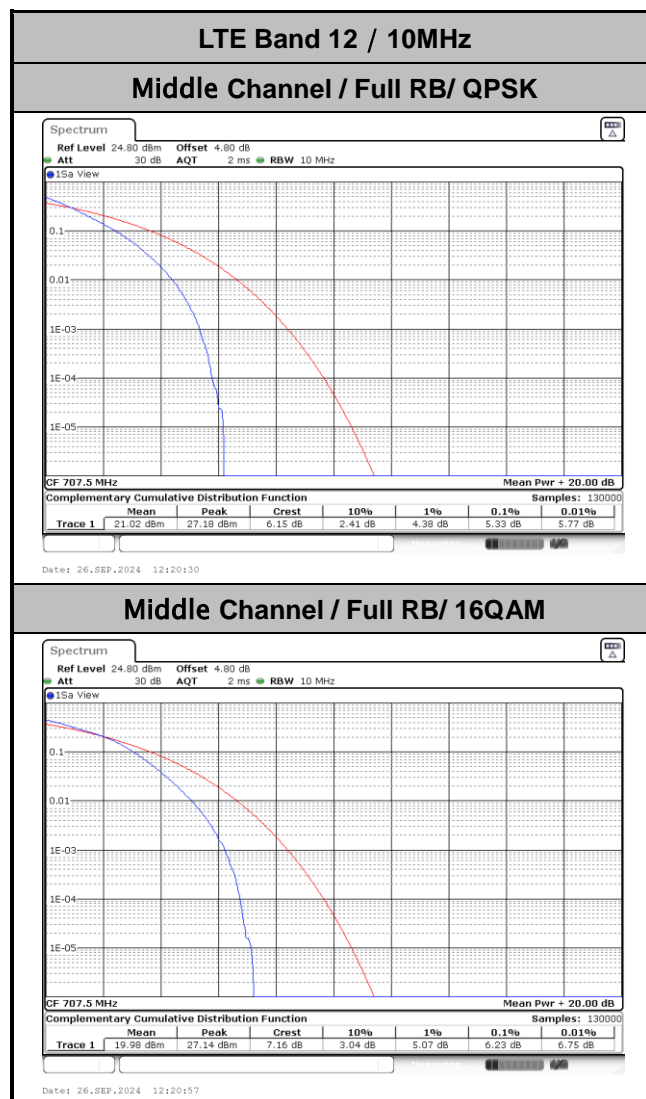

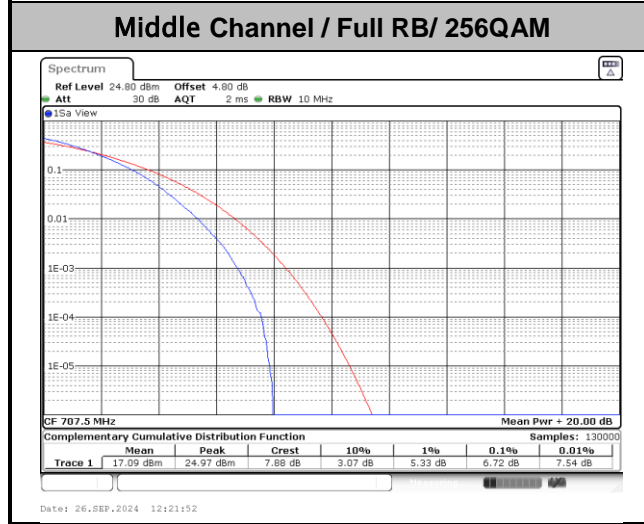
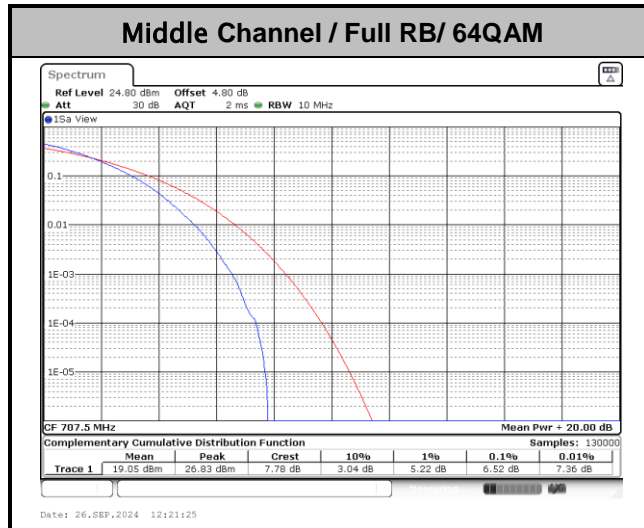



26dB Bandwidth

Mode	LTE Band 12 : 26dB BW(MHz)	
BW	1.4MHz	
Mod.	QPSK	16QAM
Middle CH	1.28	1.27
BW	3MHz	
Mod.	QPSK	16QAM
Middle CH	2.99	2.97
BW	5MHz	
Mod.	QPSK	16QAM
Middle CH	4.92	4.84
BW	10MHz	
Mod.	QPSK	16QAM
Middle CH	9.85	9.69

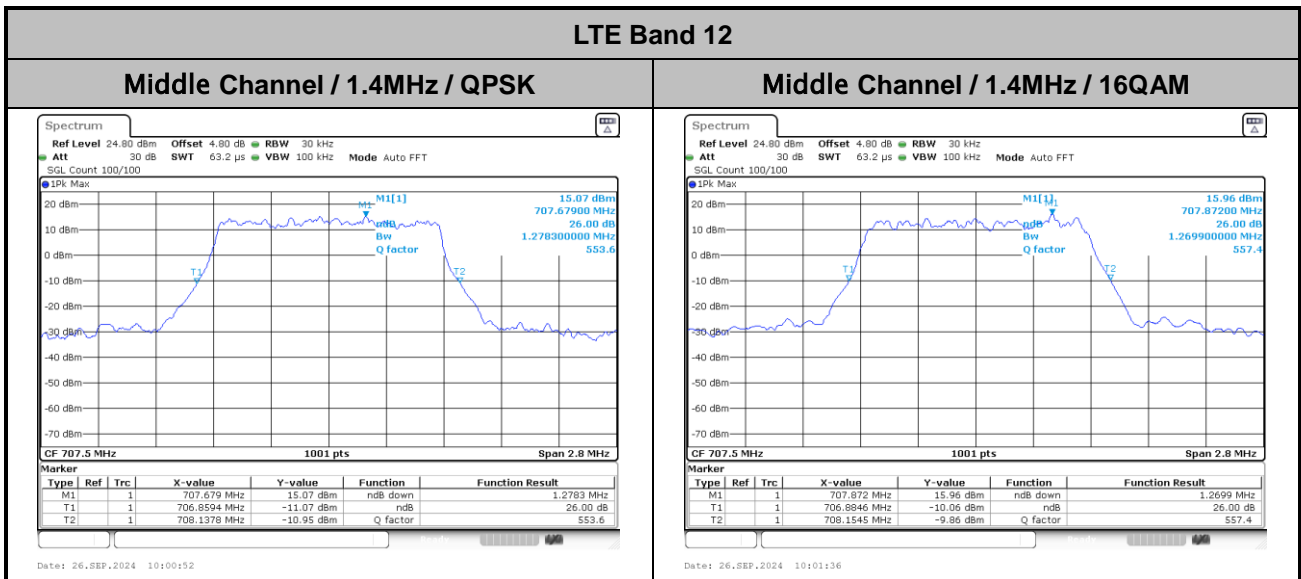



LTE Band 12

Middle Channel / 3MHz / QPSK

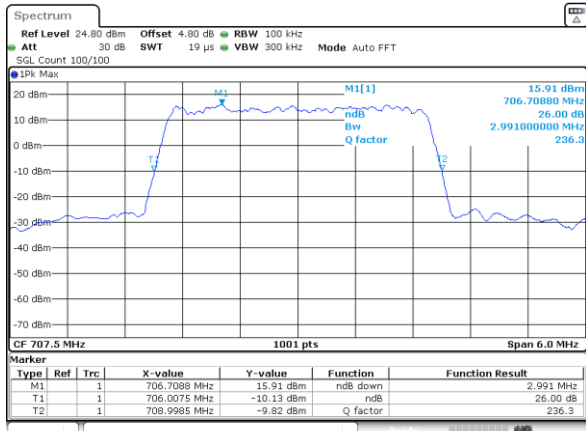

Date: 26.SEP.2024 10:37:46

Middle Channel / 3MHz / 16QAM

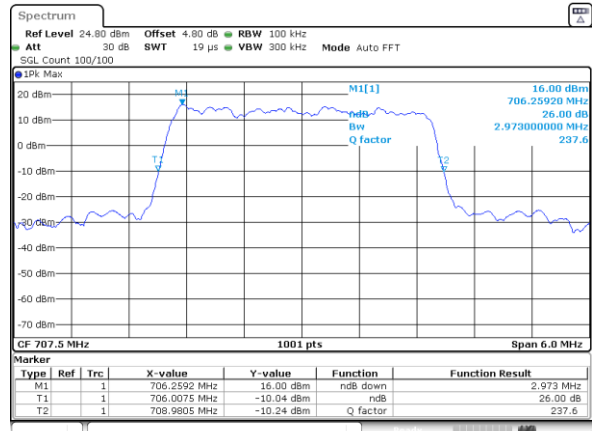

Date: 26.SEP.2024 10:38:26

LTE Band 12

Middle Channel / 5MHz / QPSK

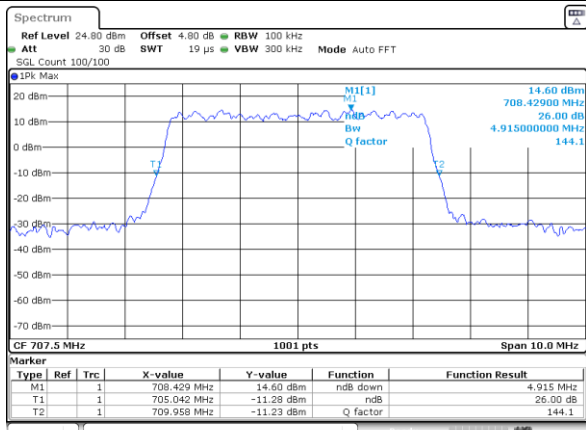

Date: 26.SEP.2024 11:21:14

Middle Channel / 5MHz / 16QAM

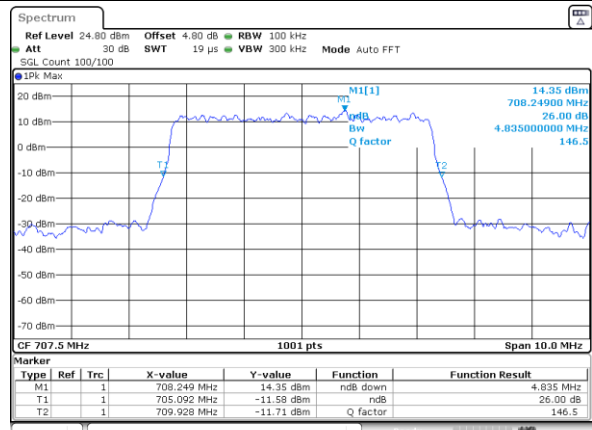

Date: 26.SEP.2024 11:21:54

LTE Band 12

Middle Channel / 10MHz / QPSK

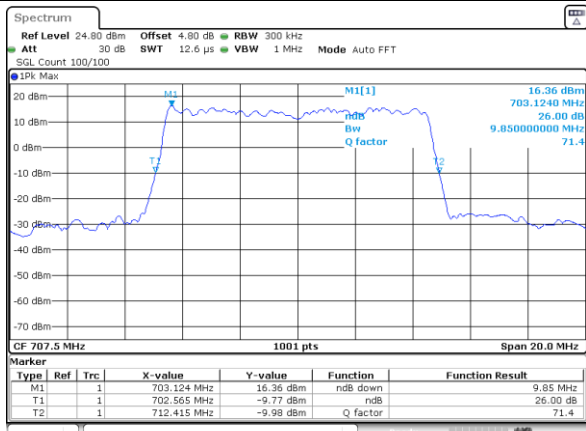

Date: 26.SEP.2024 12:07:07

Middle Channel / 10MHz / 16QAM

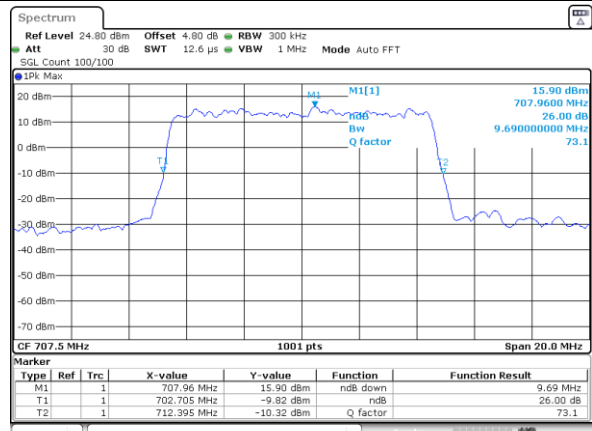

Date: 26.SEP.2024 12:07:47



Occupied Bandwidth

Mode	LTE Band 12 : 99%OBW(MHz)	
BW	1.4MHz	
Mod.	QPSK	16QAM
Middle CH	1.10	1.09
BW	3MHz	
Mod.	QPSK	16QAM
Middle CH	2.75	2.75
BW	5MHz	
Mod.	QPSK	16QAM
Middle CH	4.50	4.47
BW	10MHz	
Mod.	QPSK	16QAM
Middle CH	9.01	9.01

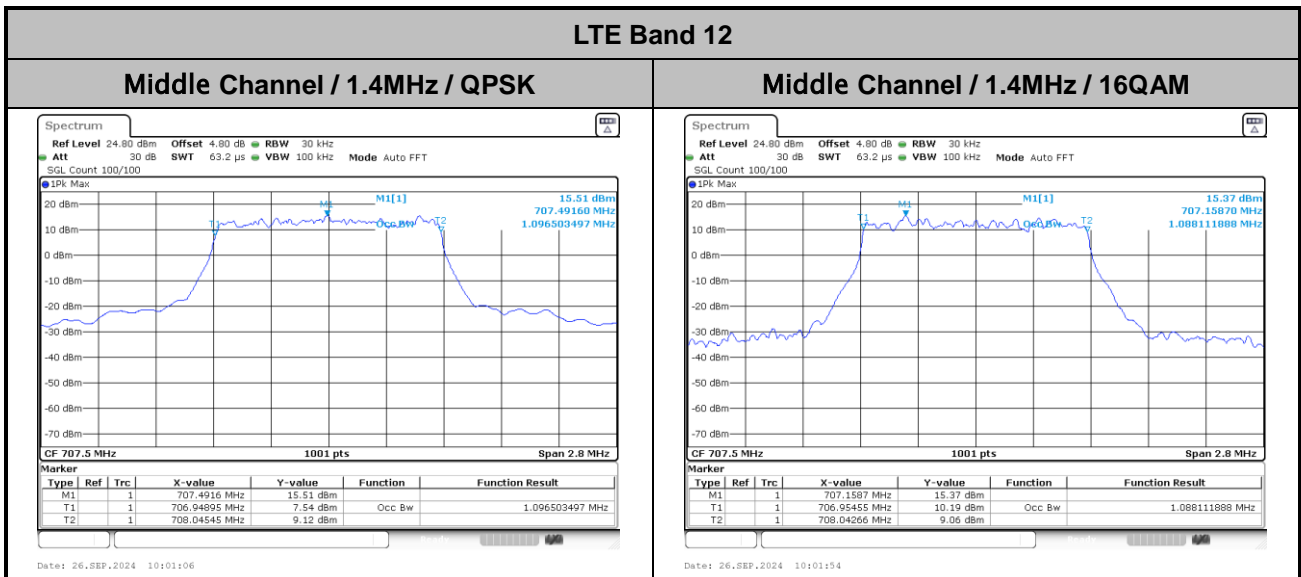



LTE Band 12

Middle Channel / 3MHz / QPSK

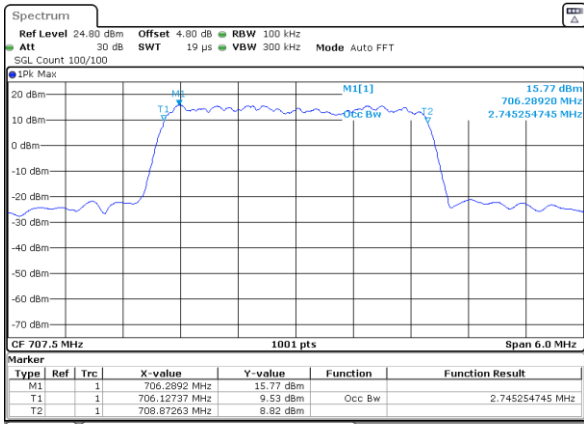

Date: 26_SEP.2024 10:38:01

Middle Channel / 3MHz / 16QAM

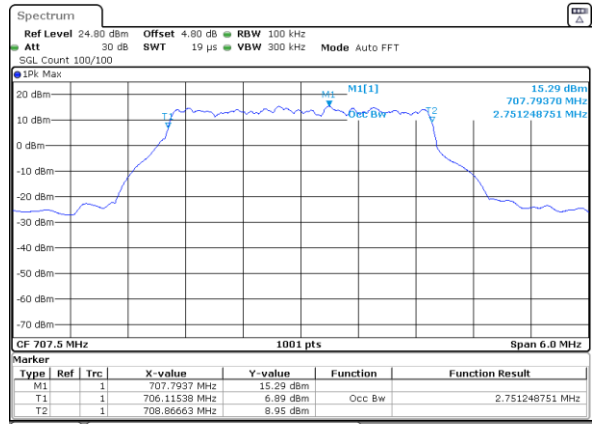

Date: 26_SEP.2024 10:38:41

LTE Band 12

Middle Channel / 5MHz / QPSK

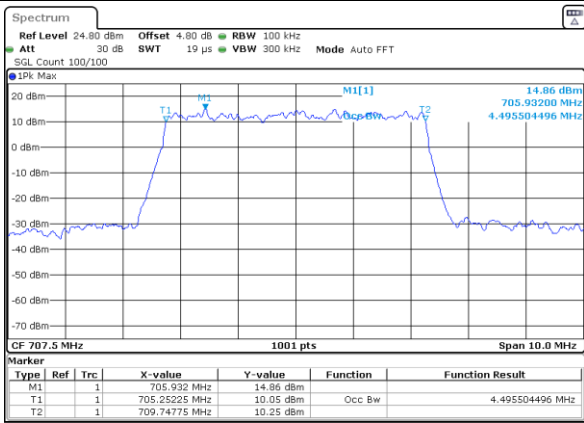

Date: 26_SEP.2024 11:21:28

Middle Channel / 5MHz / 16QAM

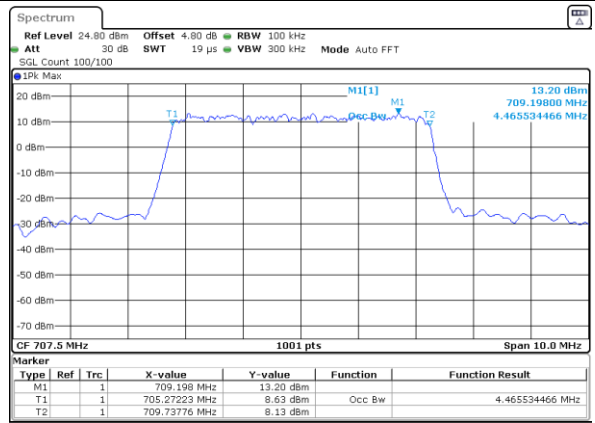

Date: 26_SEP.2024 11:22:08

LTE Band 12

Middle Channel / 10MHz / QPSK

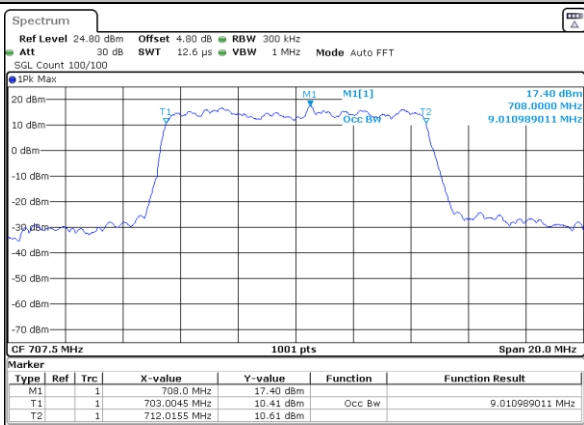

Date: 26_SEP.2024 12:07:23

Middle Channel / 10MHz / 16QAM

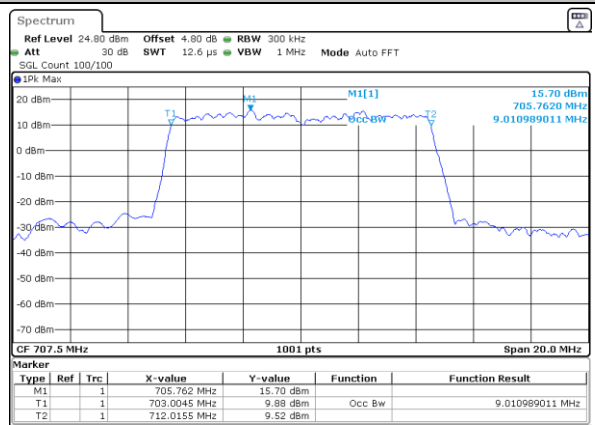

Date: 26_SEP.2024 12:08:01



Conducted Band Edge

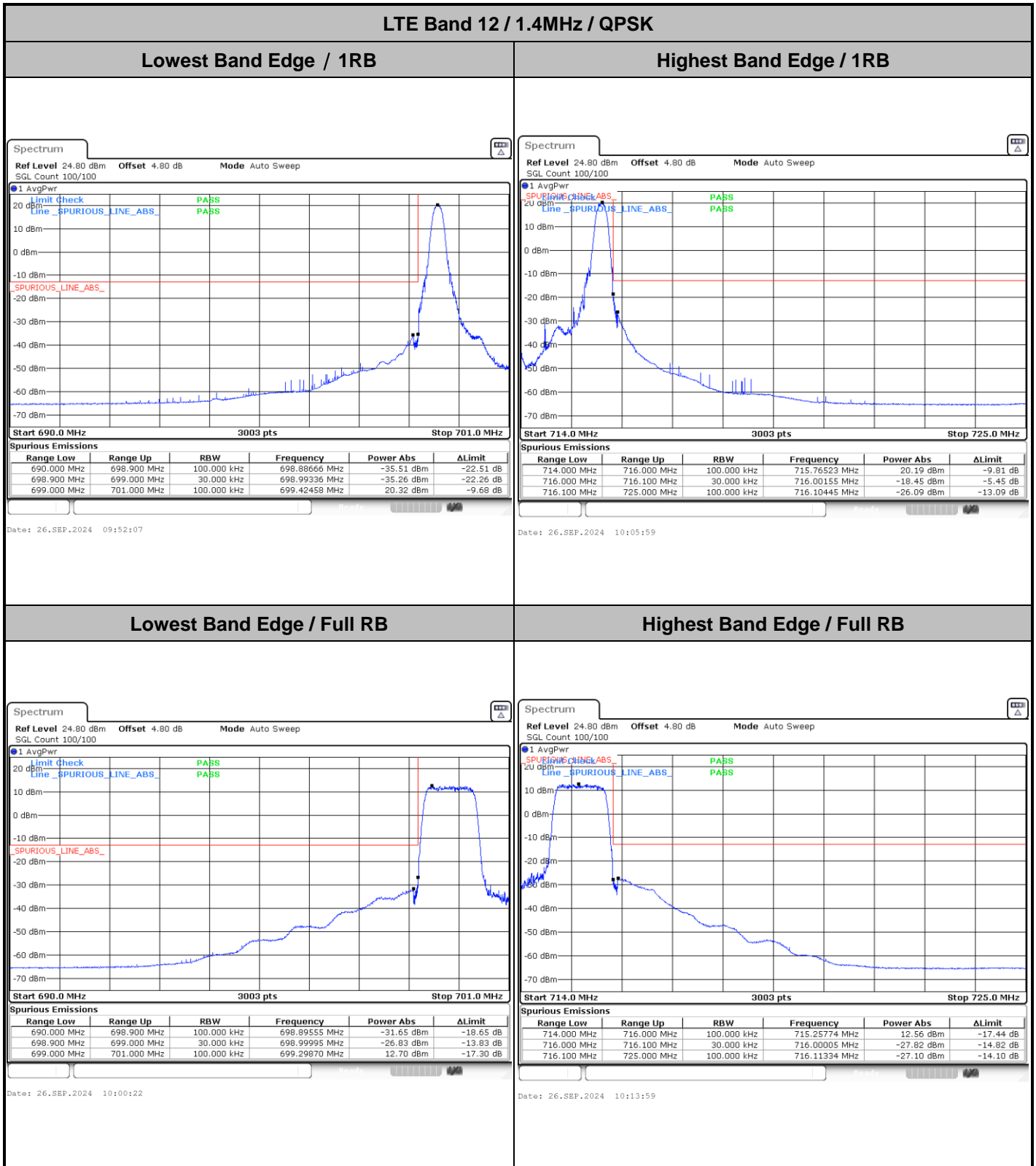



LTE Band 12 / 1.4MHz / 16QAM

Lowest Band Edge / 1 RB

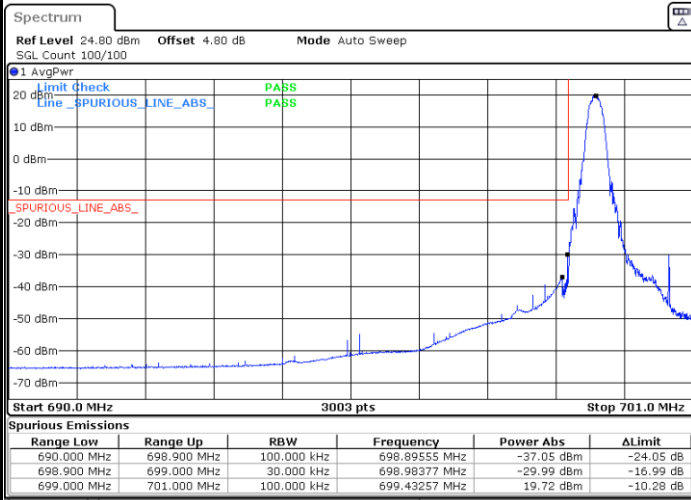

Date: 26.SEP.2024 09:53:20

Highest Band Edge / 1 RB

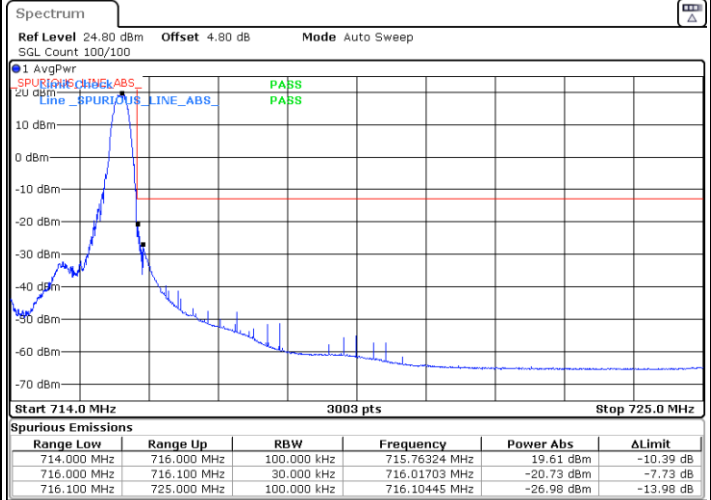

Date: 26.SEP.2024 10:07:10

Lowest Band Edge / Full RB

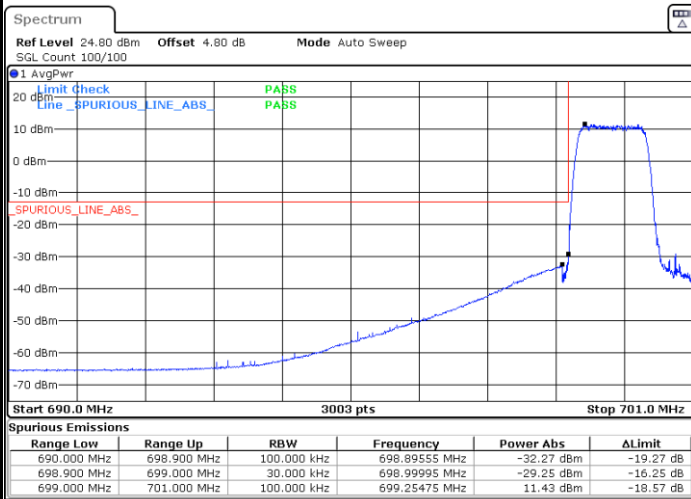

Date: 26.SEP.2024 09:59:12

Highest Band Edge / Full RB

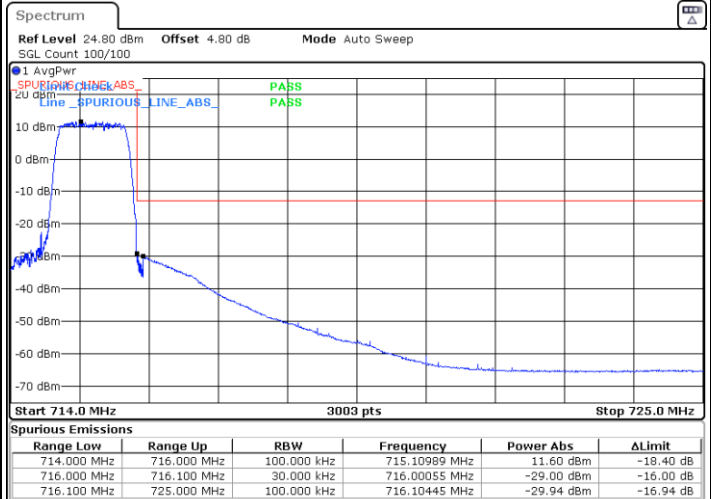

Date: 26.SEP.2024 10:12:51



LTE Band 12 / 1.4MHz / 64QAM

Lowest Band Edge / 1 RB

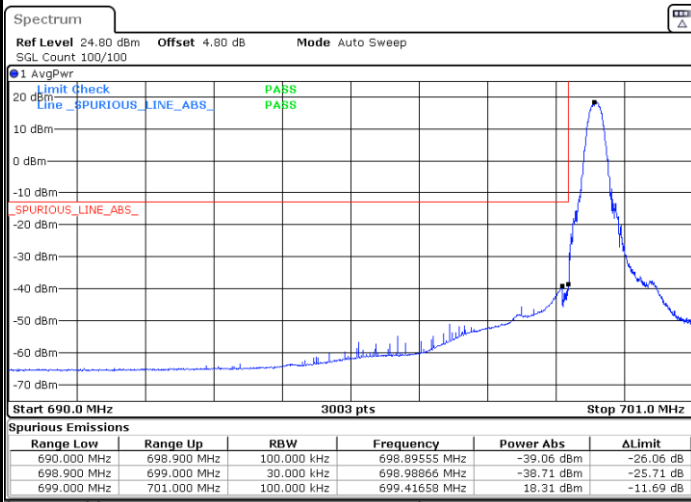

Date: 26.SEP.2024 09:54:32

Highest Band Edge / 1 RB

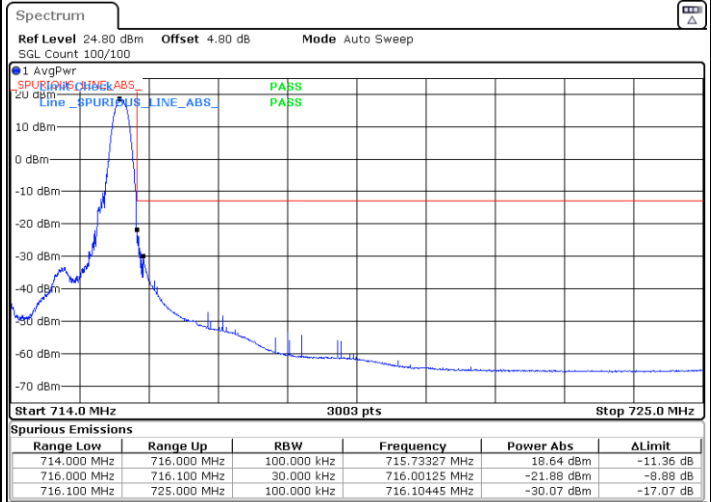

Date: 26.SEP.2024 10:08:18

Lowest Band Edge / Full RB

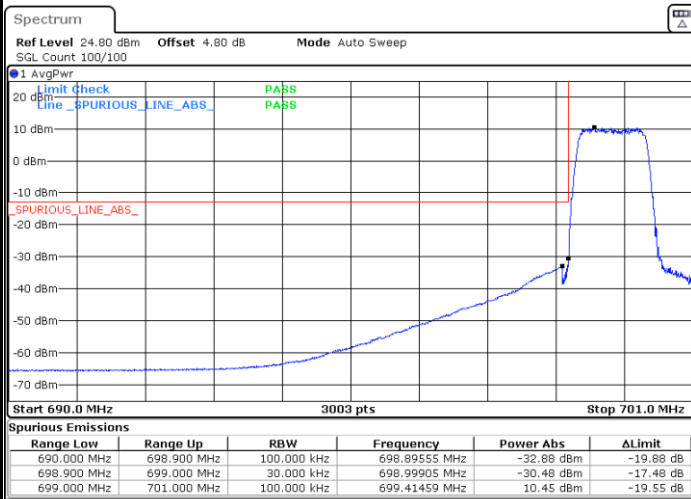

Date: 26.SEP.2024 09:58:02

Highest Band Edge / Full RB

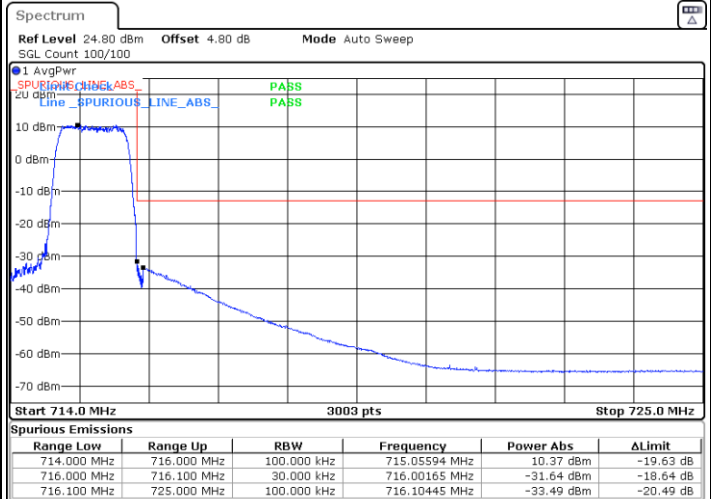

Date: 26.SEP.2024 10:11:43



LTE Band 12 / 1.4MHz / 256QAM

Lowest Band Edge / 1 RB

Highest Band Edge / 1 RB

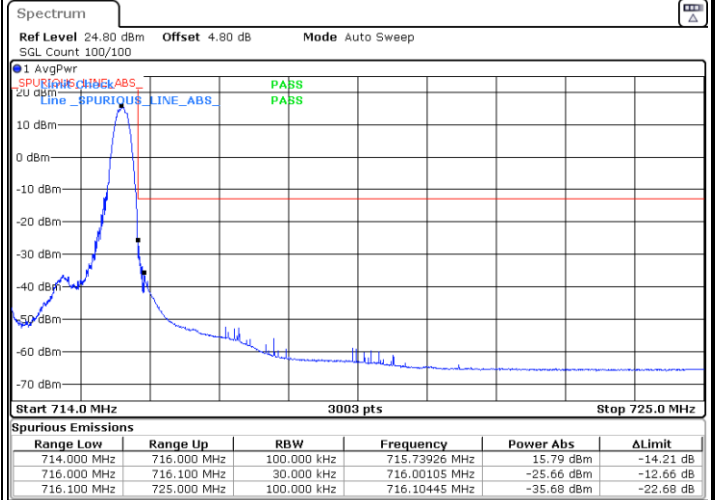
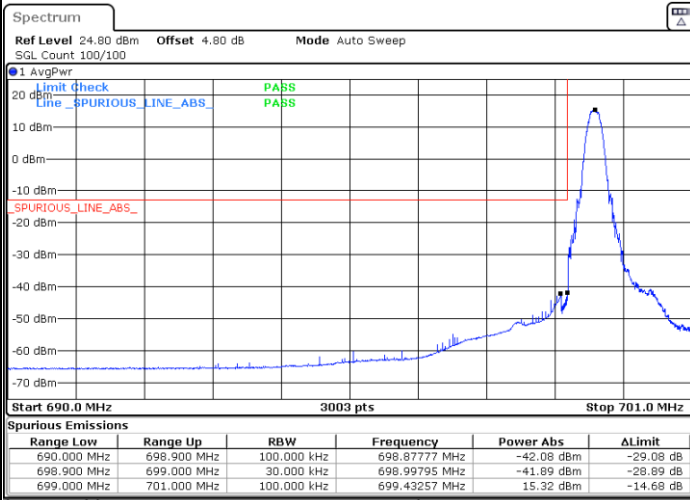

Date: 26.SEP.2024 09:55:41

Date: 26.SEP.2024 10:09:26

Lowest Band Edge / Full RB

Highest Band Edge / Full RB

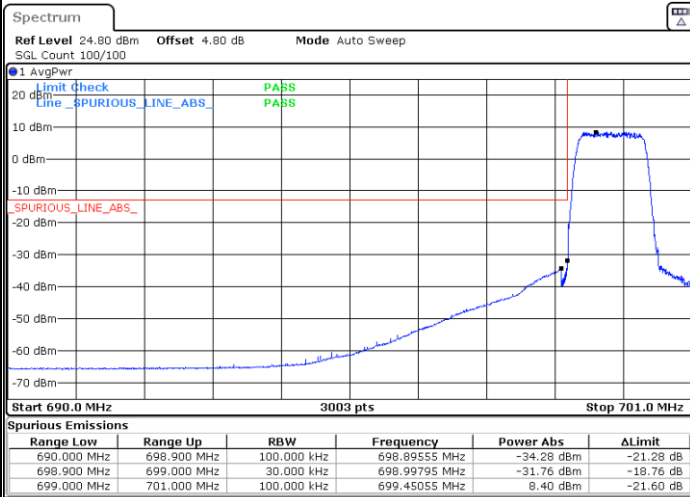

Date: 26.SEP.2024 09:56:51

Date: 26.SEP.2024 10:10:34



LTE Band 12 / 3MHz / QPSK

Lowest Band Edge / 1RB

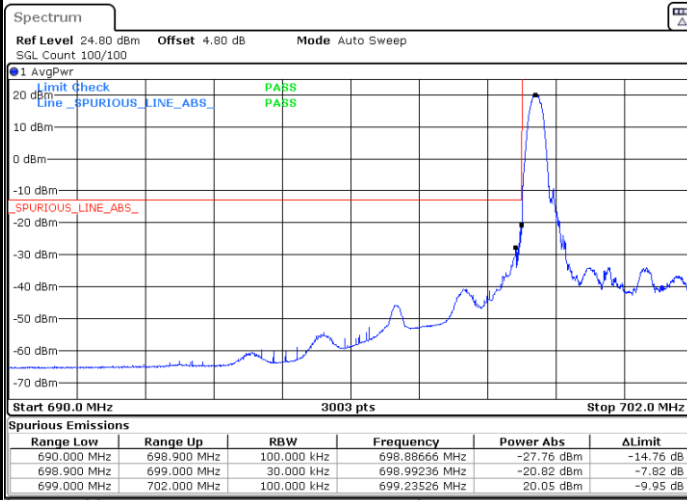

Date: 26.SEP.2024 10:29:20

Highest Band Edge / 1 RB



Date: 26.SEP.2024 10:42:45

Lowest Band Edge / Full RB

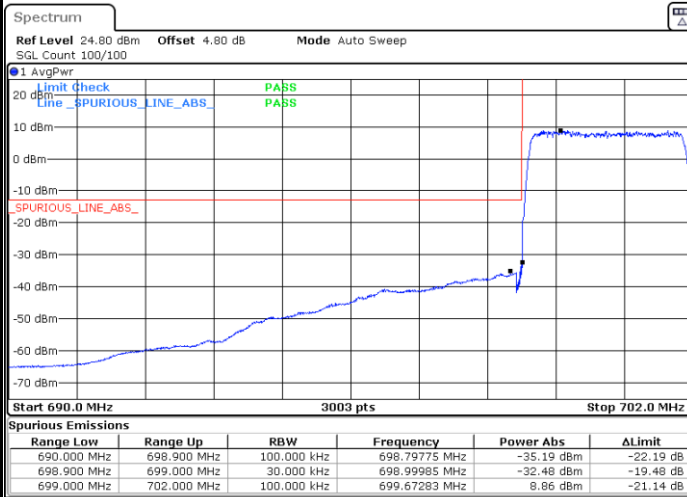

Date: 26.SEP.2024 10:37:20

Highest Band Edge / Full RB

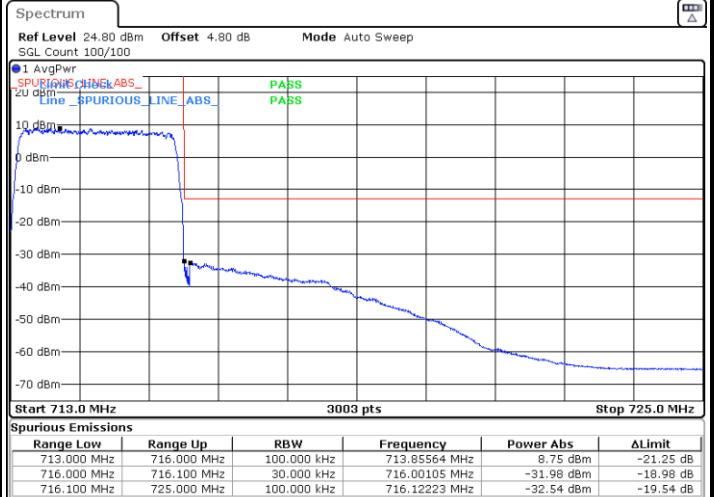

Date: 26.SEP.2024 10:50:45



LTE Band 12 / 3MHz / 16QAM

Lowest Band Edge / 1 RB

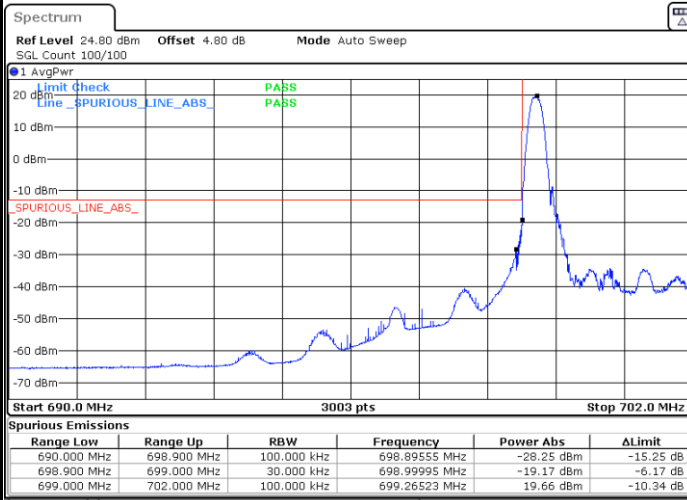

Date: 26.SEP.2024 10:30:32

Highest Band Edge / 1 RB



Date: 26.SEP.2024 10:43:56

Lowest Band Edge / Full RB

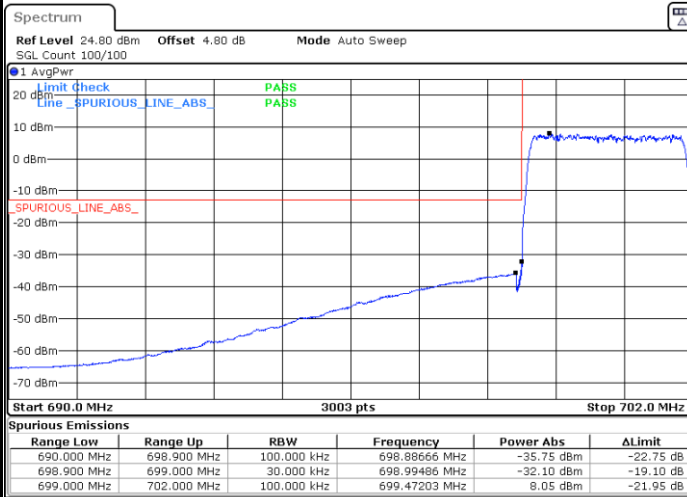

Date: 26.SEP.2024 10:36:12

Highest Band Edge / Full RB

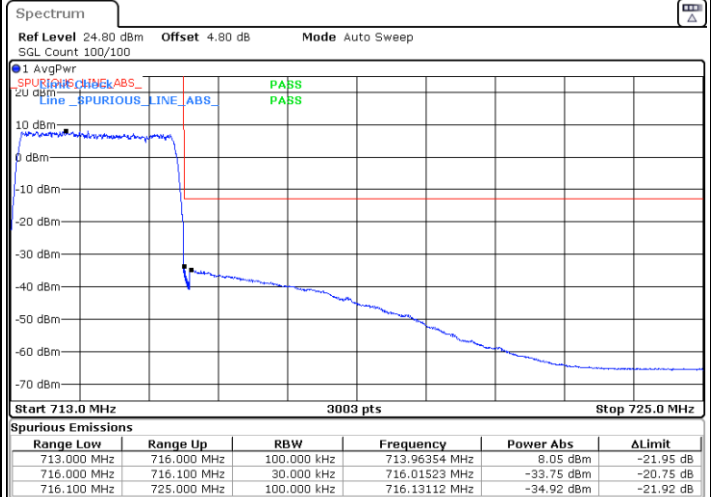

Date: 26.SEP.2024 10:49:37



LTE Band 12 / 3MHz / 64QAM

Lowest Band Edge / 1 RB

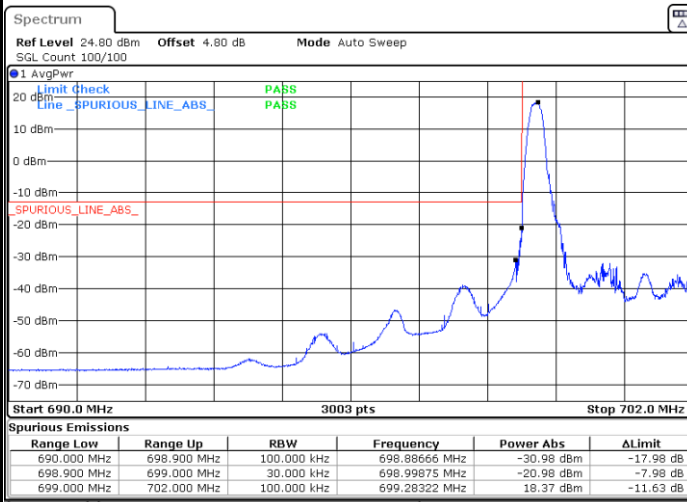

Date: 26.SEP.2024 10:31:40

Highest Band Edge / 1 RB

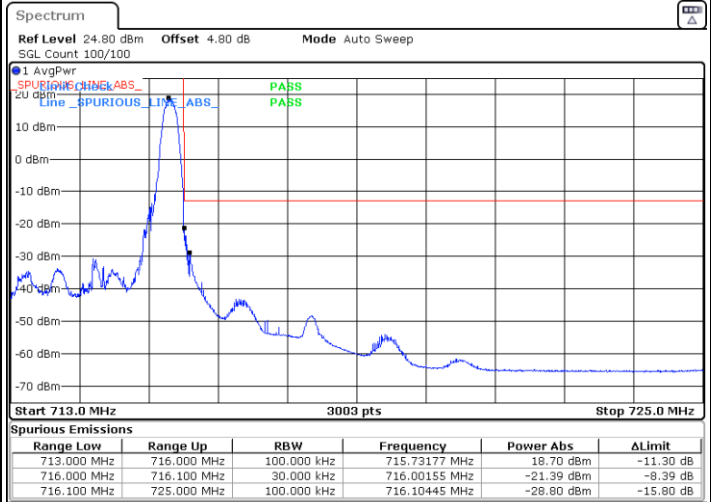

Date: 26.SEP.2024 10:45:04

Lowest Band Edge / Full RB

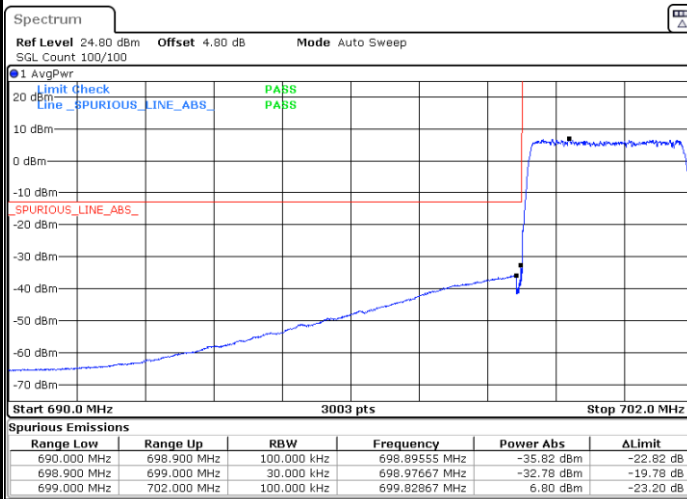

Date: 26.SEP.2024 10:35:04

Highest Band Edge / Full RB

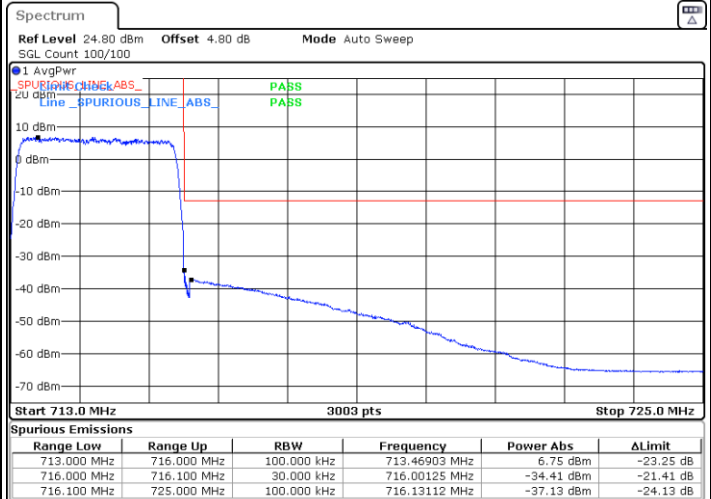

Date: 26.SEP.2024 10:46:12



LTE Band 12 / 3MHz / 256QAM

Lowest Band Edge / 1 RB

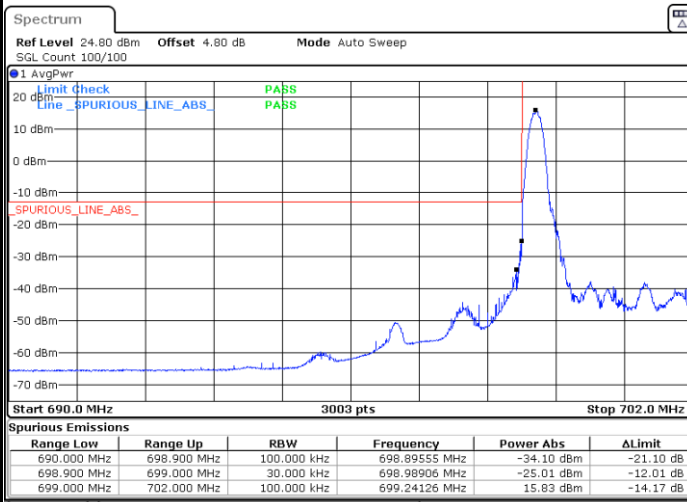

Highest Band Edge / 1 RB

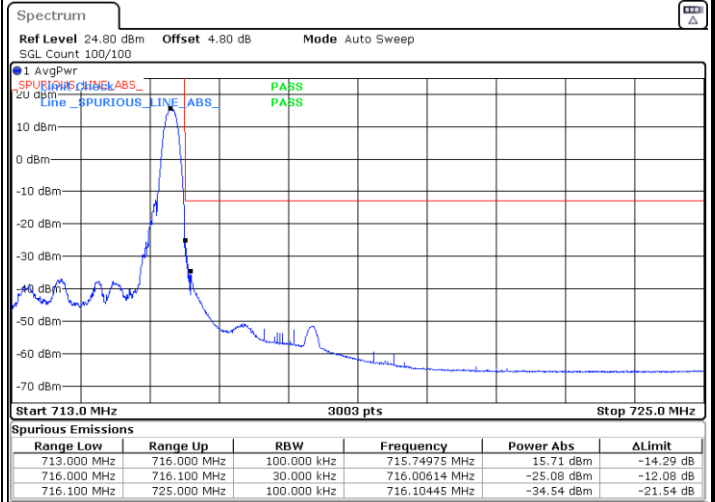

Lowest Band Edge / Full RB

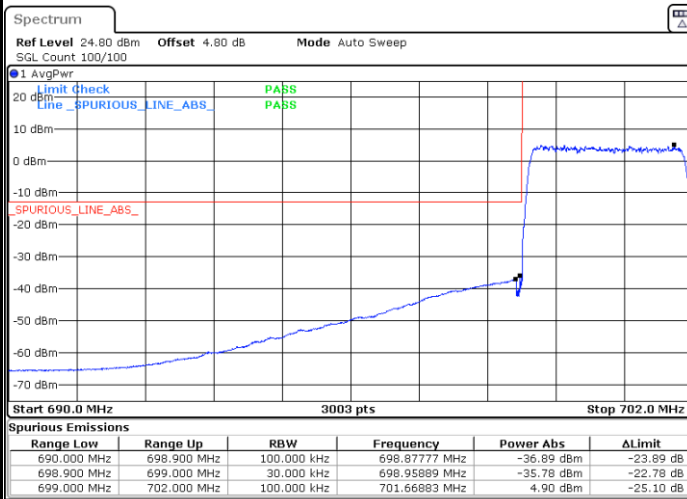

Highest Band Edge / Full RB

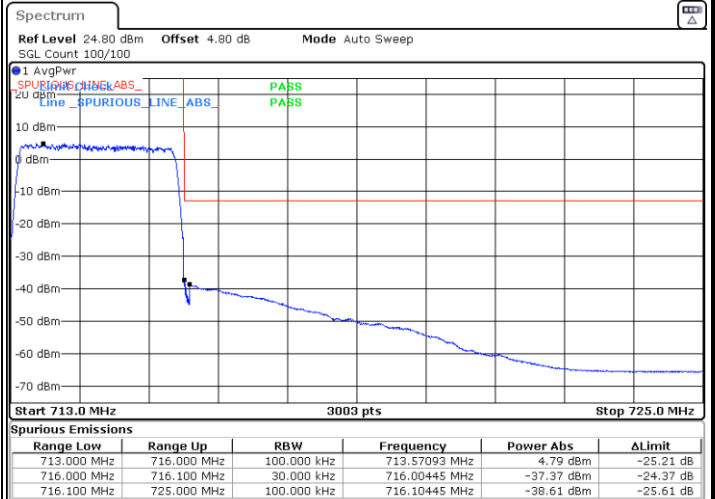



LTE Band 12 / 5MHz / QPSK

Lowest Band Edge / 1 RB

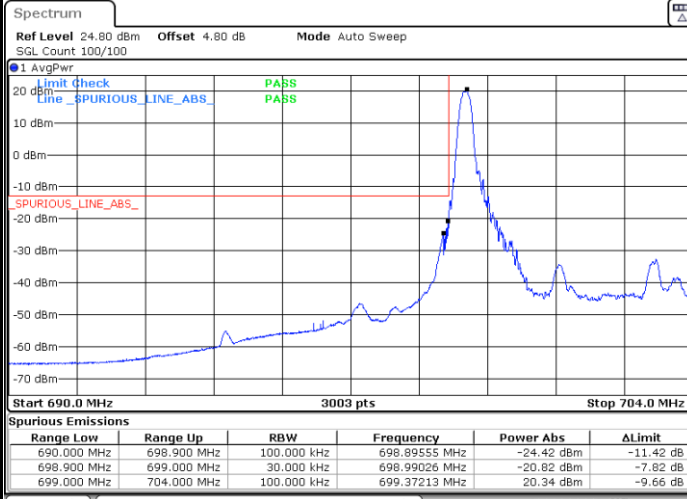

Date: 26.SEP.2024 11:12:48

Highest Band Edge / 1 RB

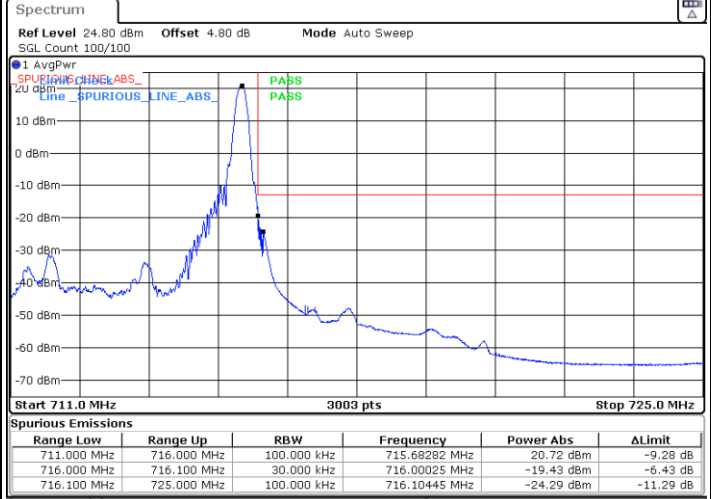

Date: 26.SEP.2024 11:26:12

Lowest Band Edge / Full RB

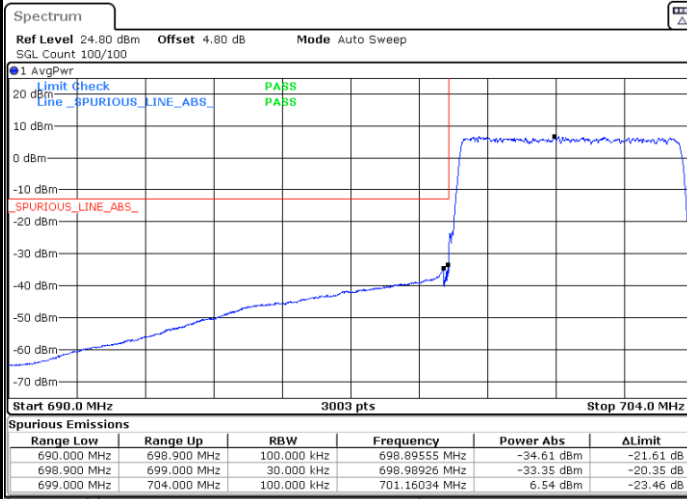

Date: 26.SEP.2024 11:20:47

Highest Band Edge / Full RB

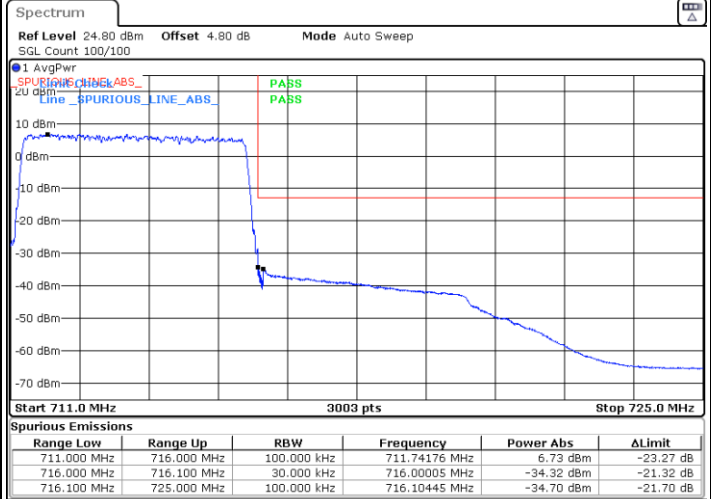

Date: 26.SEP.2024 11:34:12



LTE Band 12 / 5MHz / 16QAM

Lowest Band Edge / 1RB

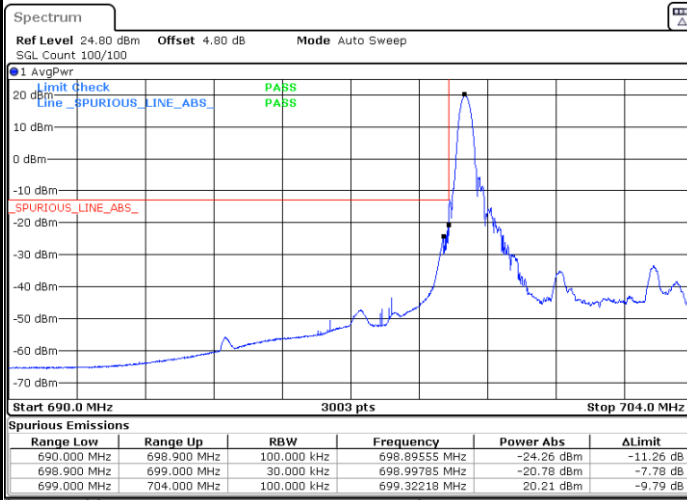

Date: 26.SEP.2024 11:13:59

Highest Band Edge / 1 RB

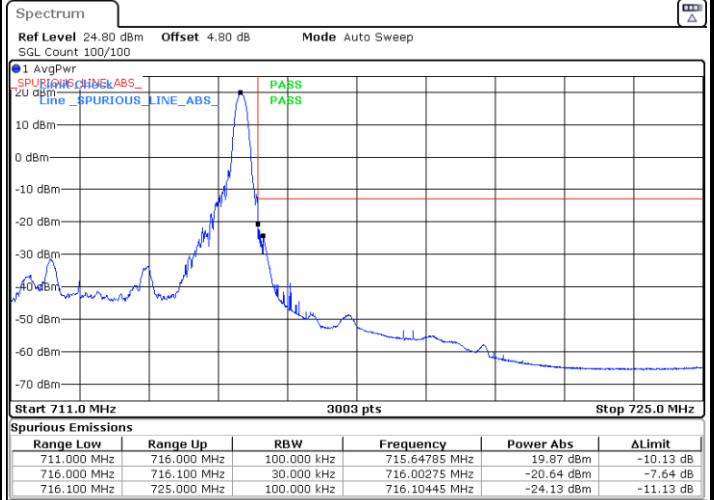

Date: 26.SEP.2024 11:27:23

Lowest Band Edge / Full RB

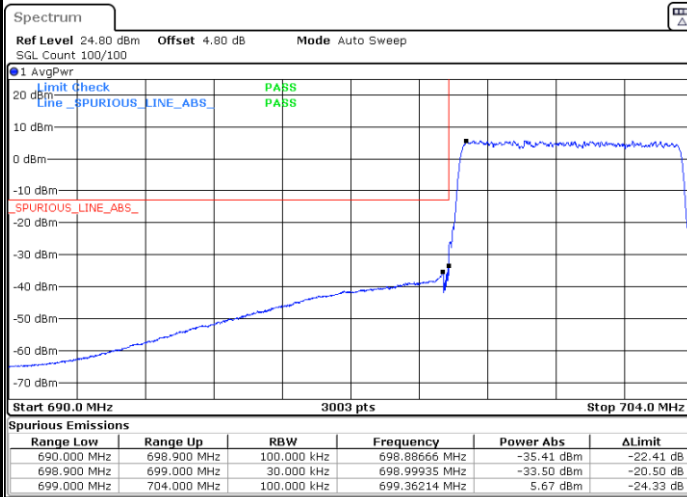

Date: 26.SEP.2024 11:19:39

Highest Band Edge / Full RB

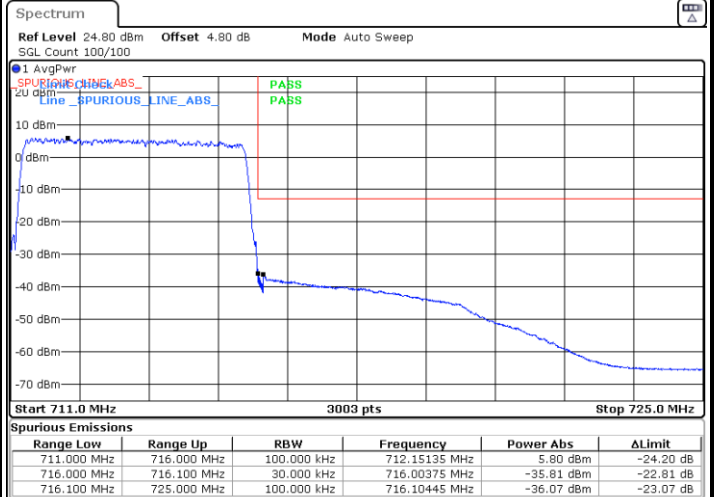

Date: 26.SEP.2024 11:33:04



LTE Band 12 / 5MHz / 64QAM

Lowest Band Edge / 1RB

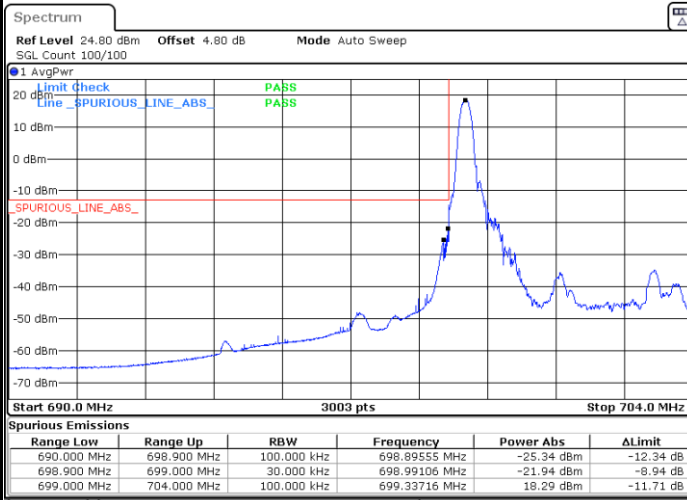

Date: 26.SEP.2024 11:15:07

Highest Band Edge / 1 RB

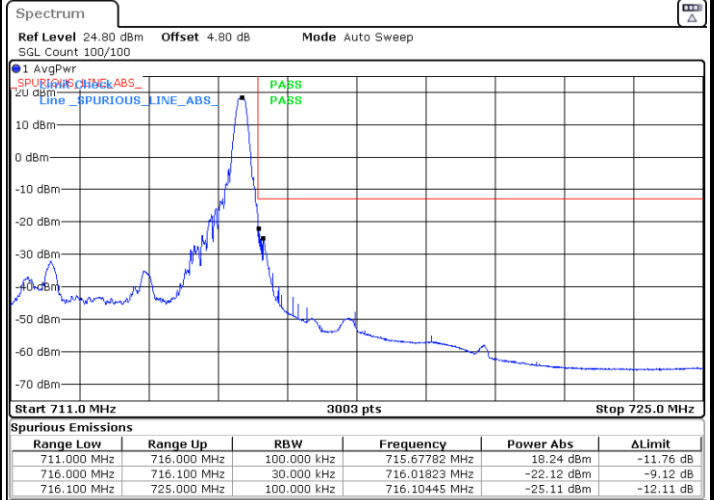

Date: 26.SEP.2024 11:28:31

Lowest Band Edge / Full RB

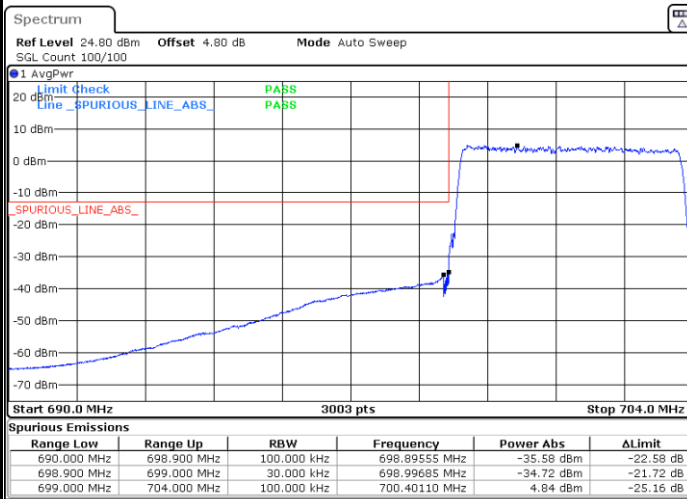

Date: 26.SEP.2024 11:18:31

Highest Band Edge / Full RB

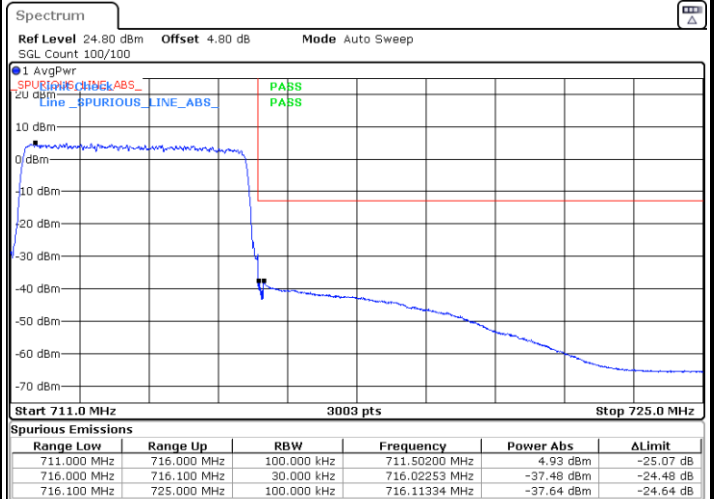

Date: 26.SEP.2024 11:31:55



LTE Band 12 / 5MHz / 256QAM

Lowest Band Edge / 1RB

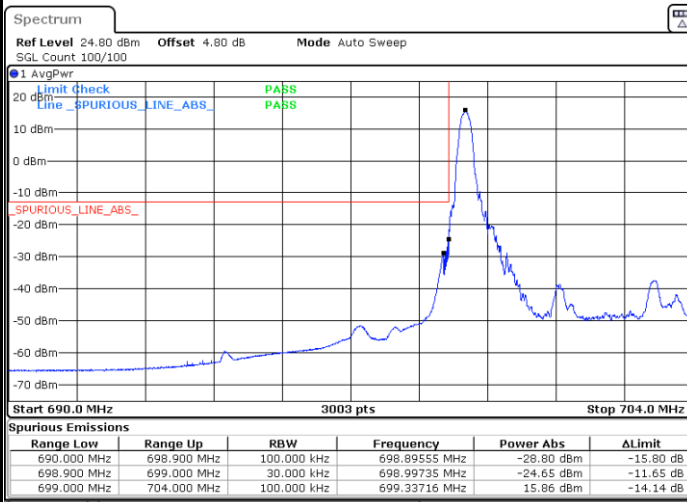

Date: 26.SEP.2024 11:16:15

Highest Band Edge / 1 RB

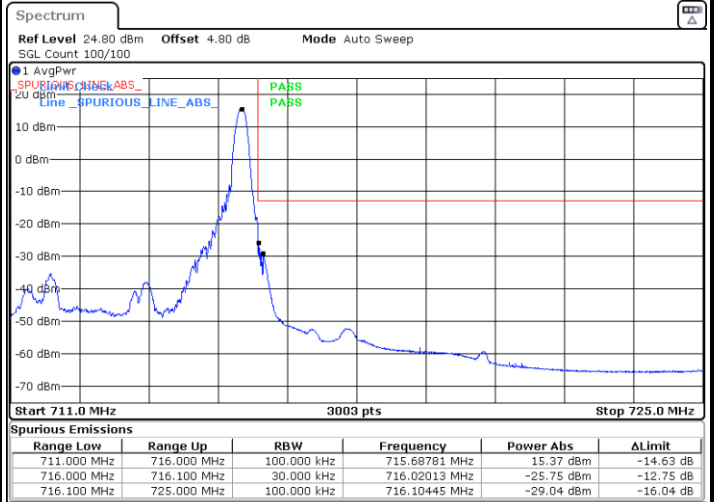

Date: 26.SEP.2024 11:29:39

Lowest Band Edge / Full RB

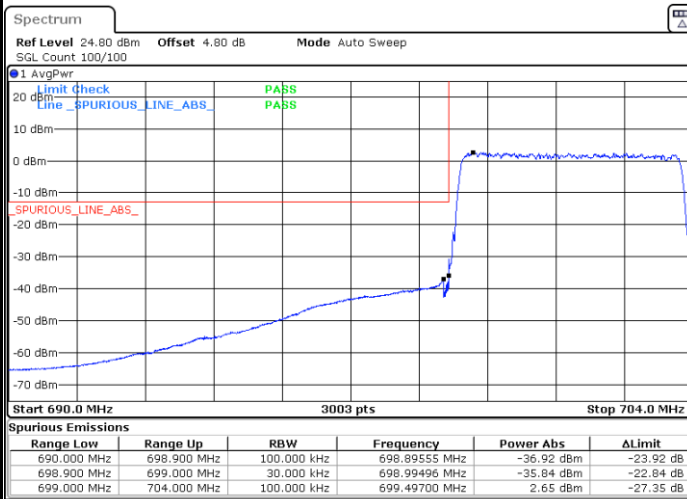

Date: 26.SEP.2024 11:17:23

Highest Band Edge / Full RB

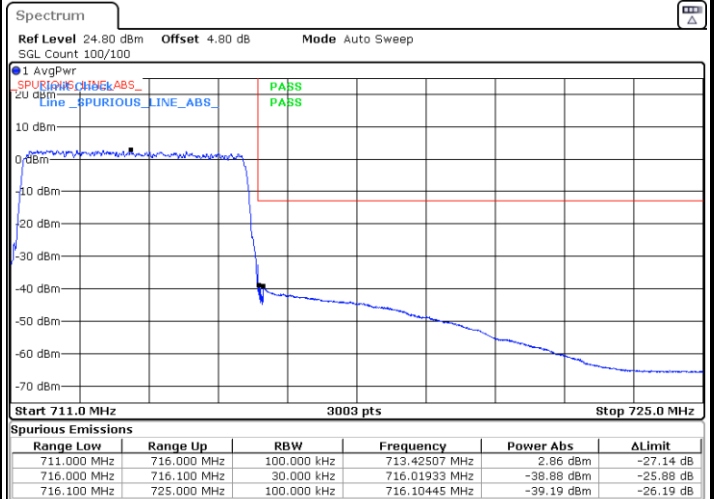

Date: 26.SEP.2024 11:30:47



LTE Band 12 / 10MHz / QPSK

Lowest Band Edge / 1 RB

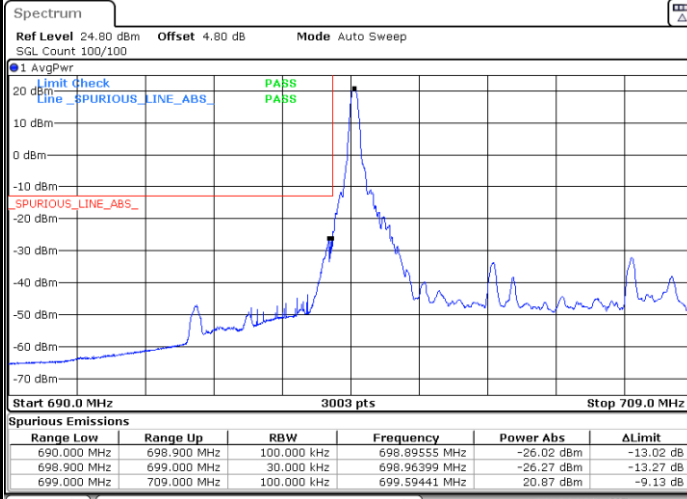

Highest Band Edge / 1 RB

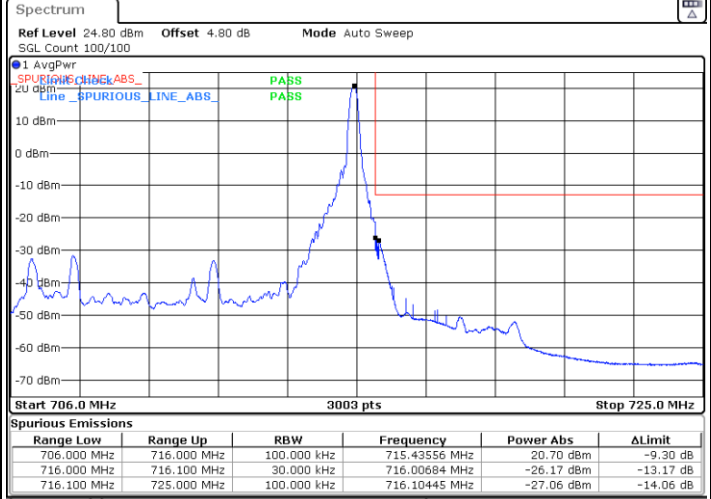

Lowest Band Edge / Full RB

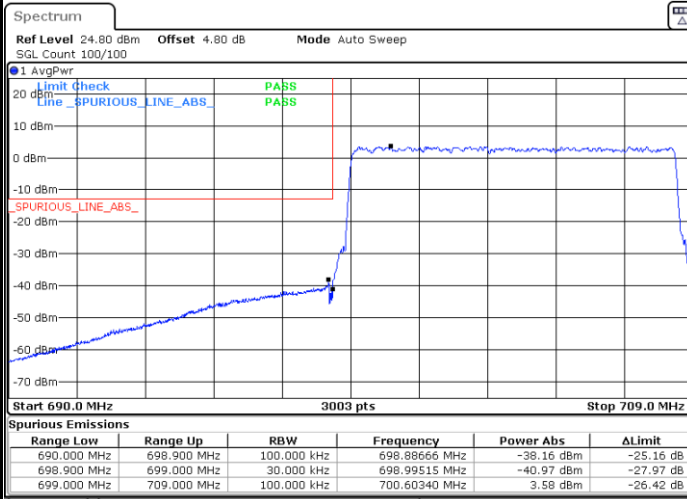

Highest Band Edge / Full RB

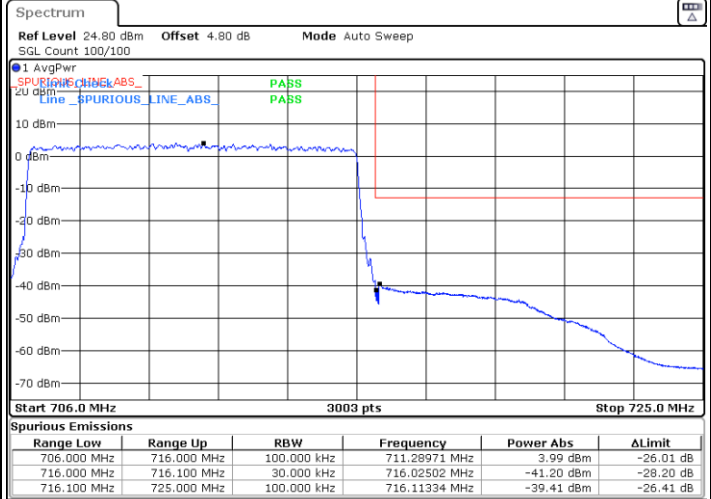



LTE Band 12 / 10MHz / 16QAM

Lowest Band Edge / 1 RB

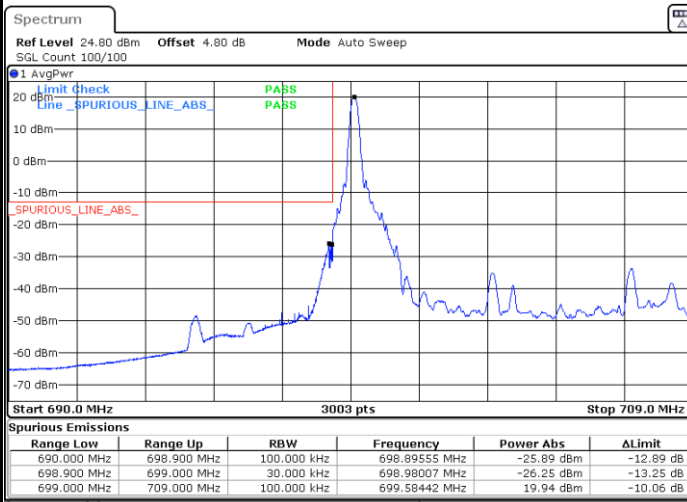

Date: 26.SEP.2024 11:59:51

Highest Band Edge / 1 RB

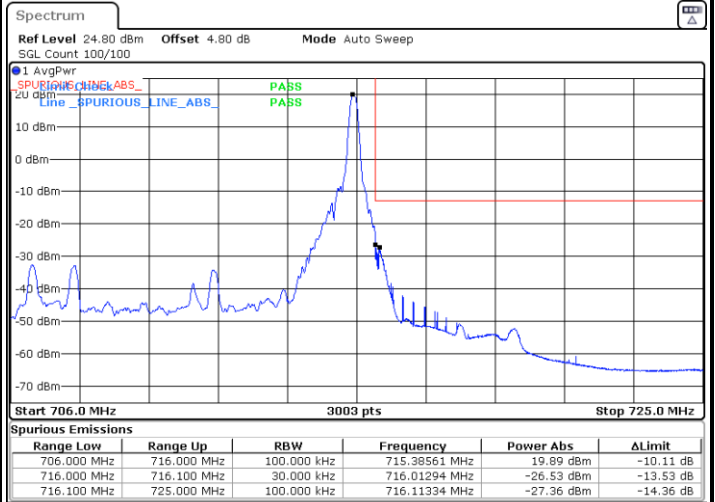

Date: 26.SEP.2024 12:13:16

Lowest Band Edge / Full RB

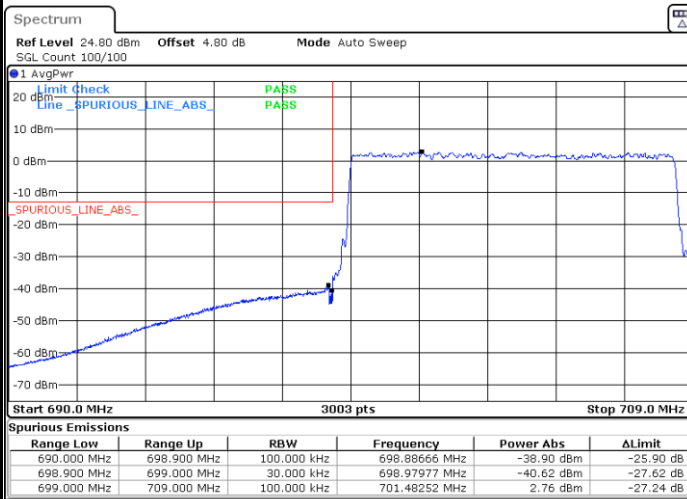

Date: 26.SEP.2024 12:05:32

Highest Band Edge / Full RB

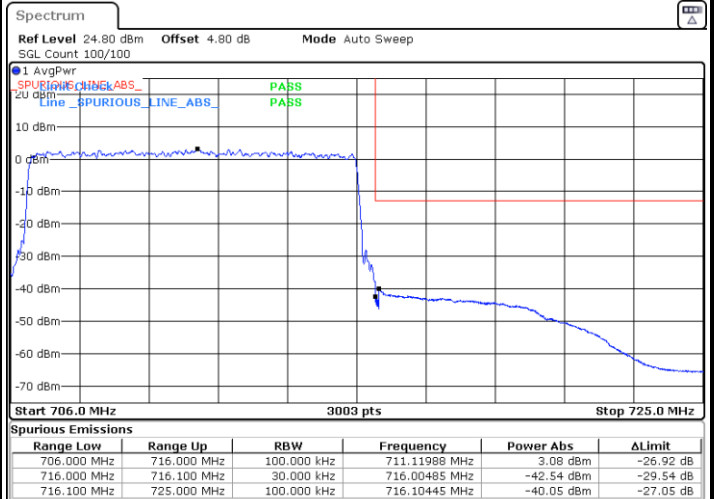

Date: 26.SEP.2024 12:18:55



LTE Band 12 / 10MHz / 64QAM

Lowest Band Edge / 1 RB

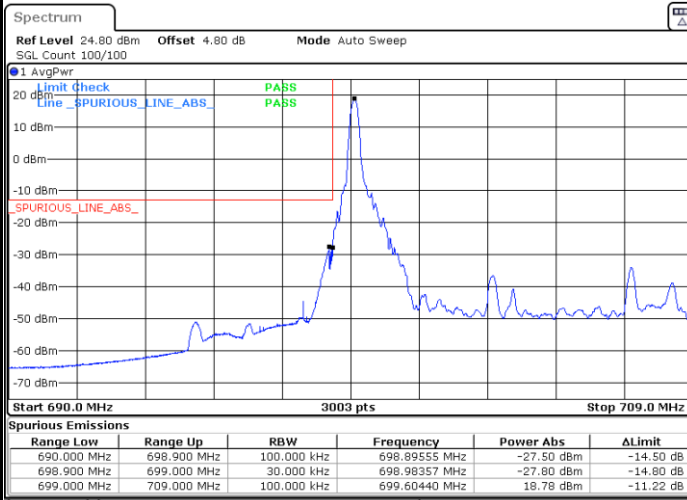

Date: 26.SEP.2024 12:00:59

Highest Band Edge / 1 RB

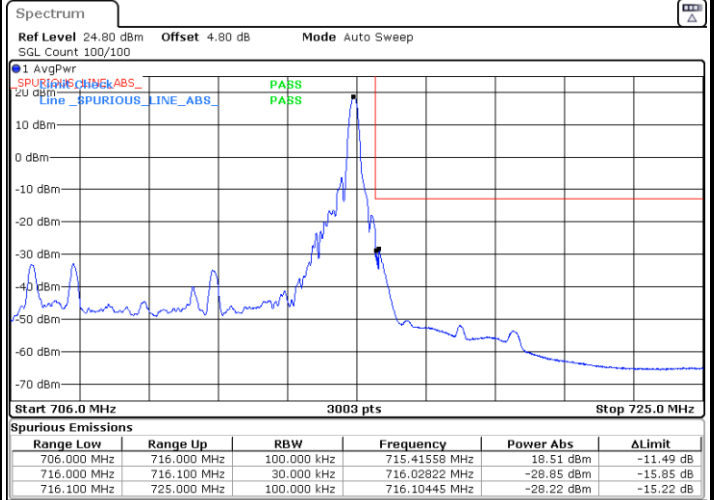

Date: 26.SEP.2024 12:14:23

Lowest Band Edge / Full RB

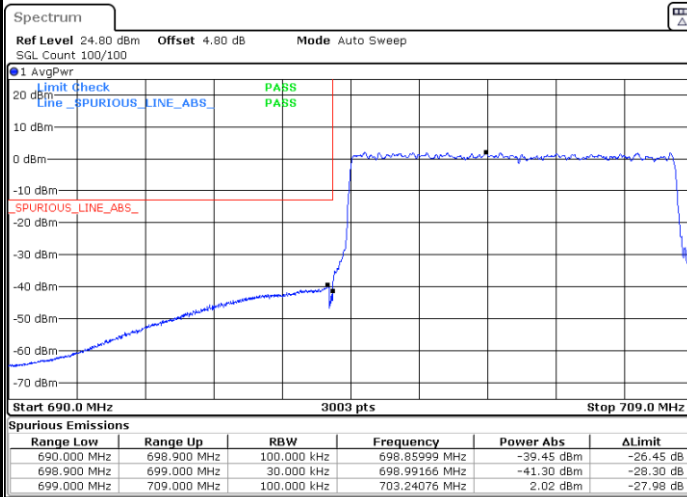

Date: 26.SEP.2024 12:04:24

Highest Band Edge / Full RB

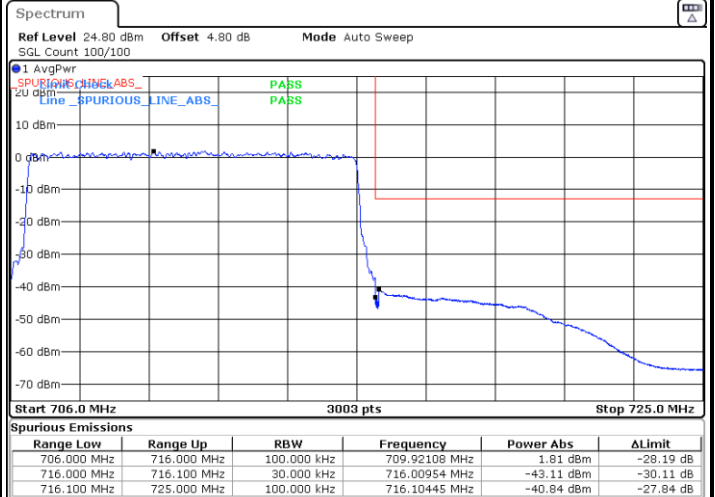

Date: 26.SEP.2024 12:17:47



LTE Band 12 / 10MHz / 256QAM

Lowest Band Edge / 1 RB

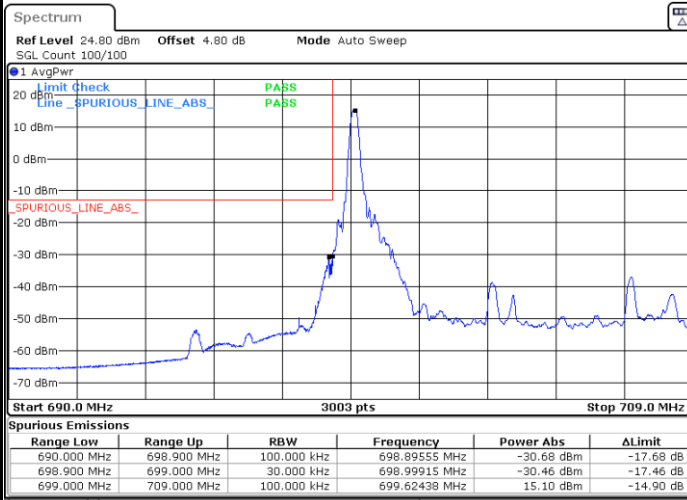

Date: 26.SEP.2024 12:02:08

Highest Band Edge / 1 RB

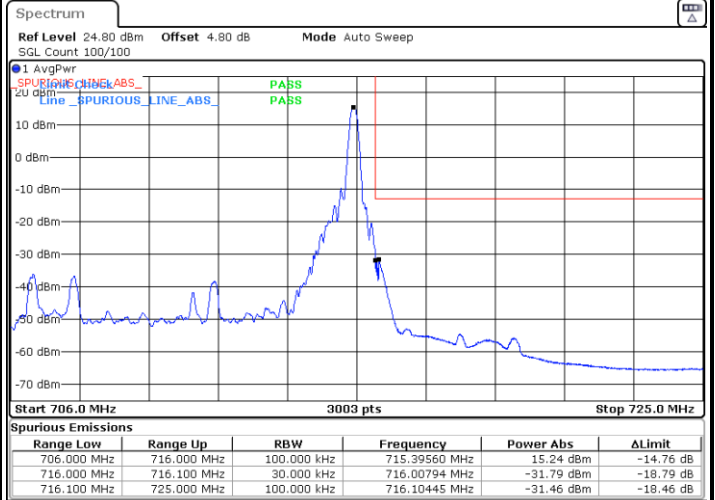

Date: 26.SEP.2024 12:15:31

Lowest Band Edge / Full RB

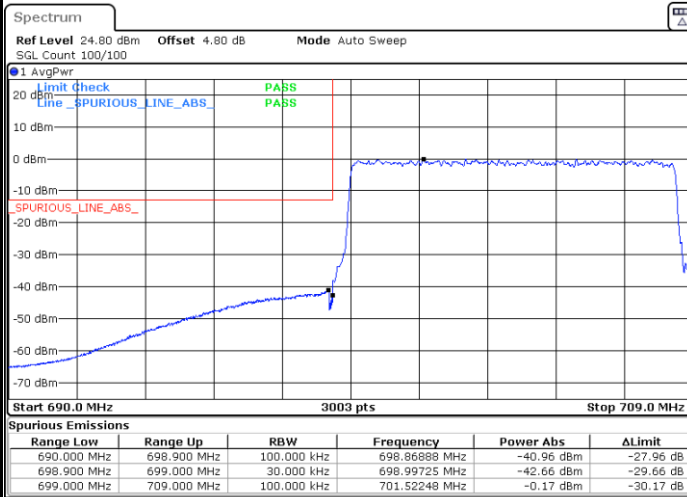

Date: 26.SEP.2024 12:03:16

Highest Band Edge / Full RB

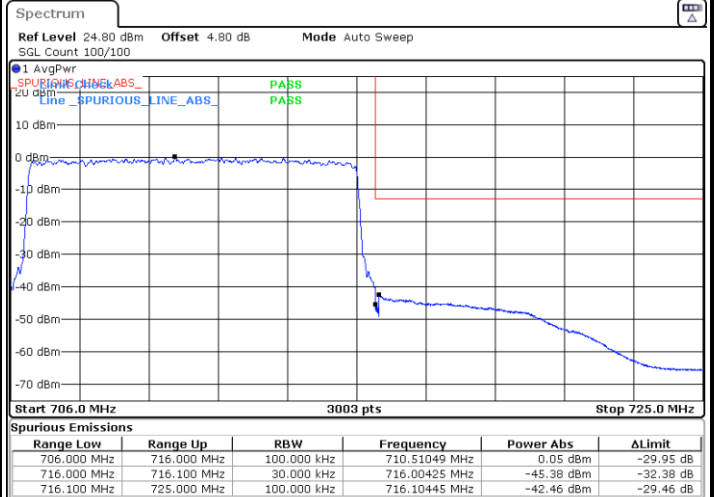

Date: 26.SEP.2024 12:16:39



Conducted Spurious Emission

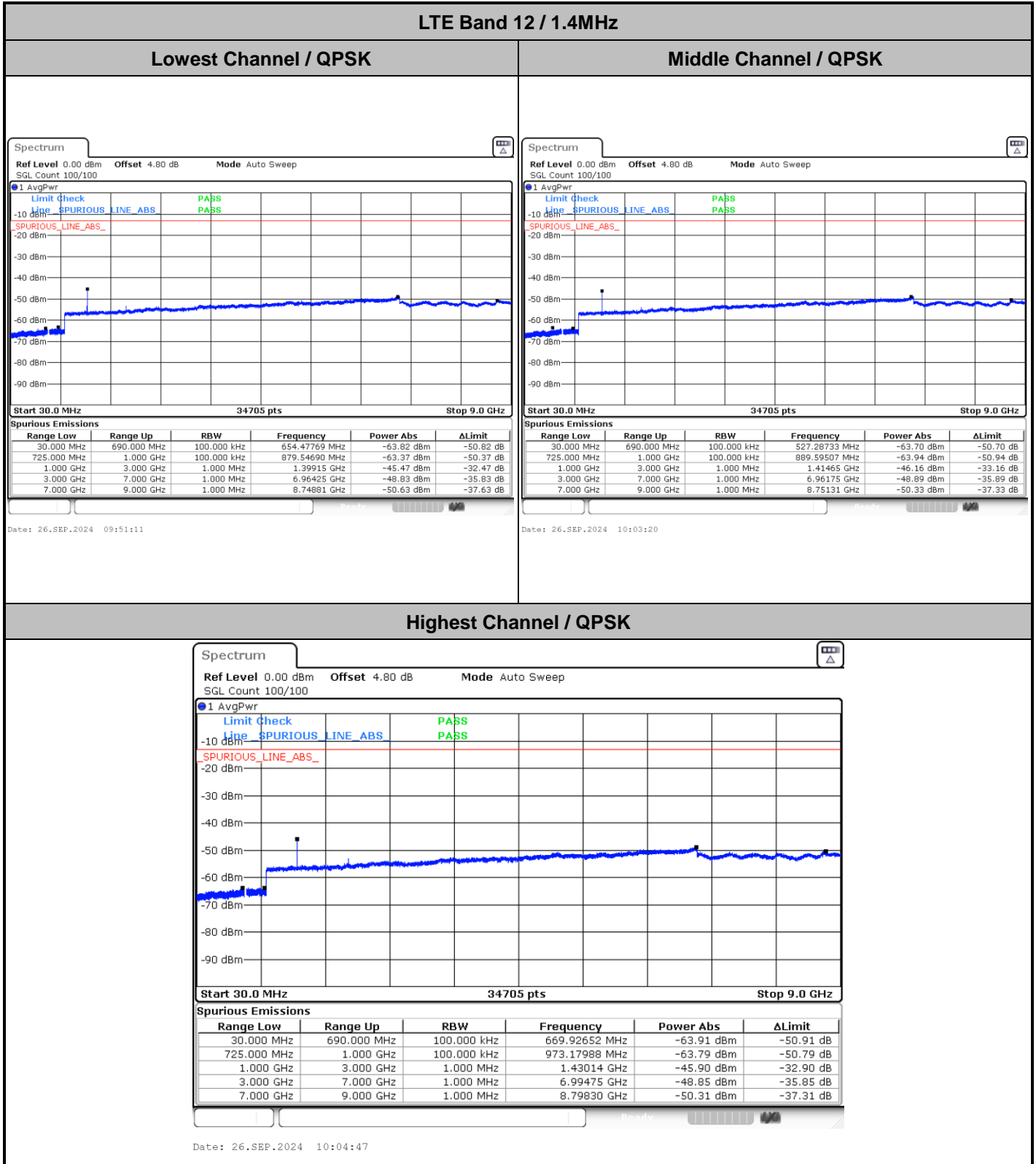



LTE Band 12 / 3MHz

Lowest Channel / QPSK

Middle Channel / QPSK

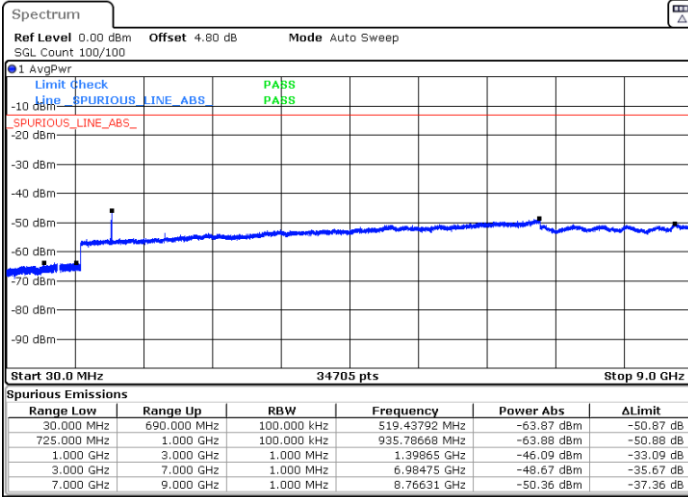

Date: 26.SEP.2024 10:28:24

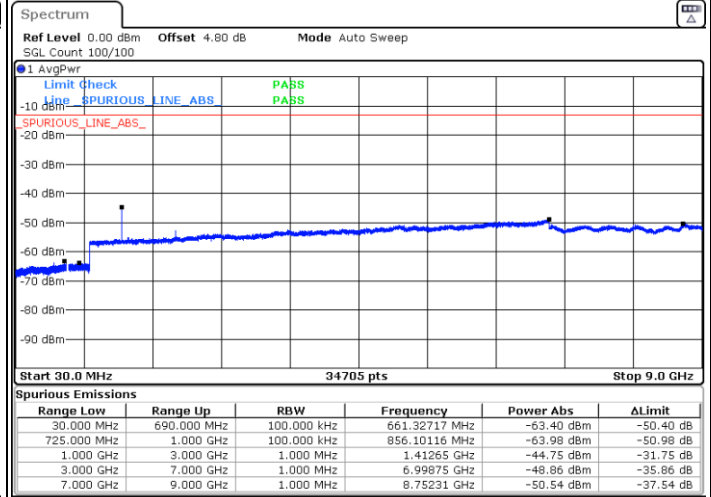

Date: 26.SEP.2024 10:40:07

Highest Channel / QPSK

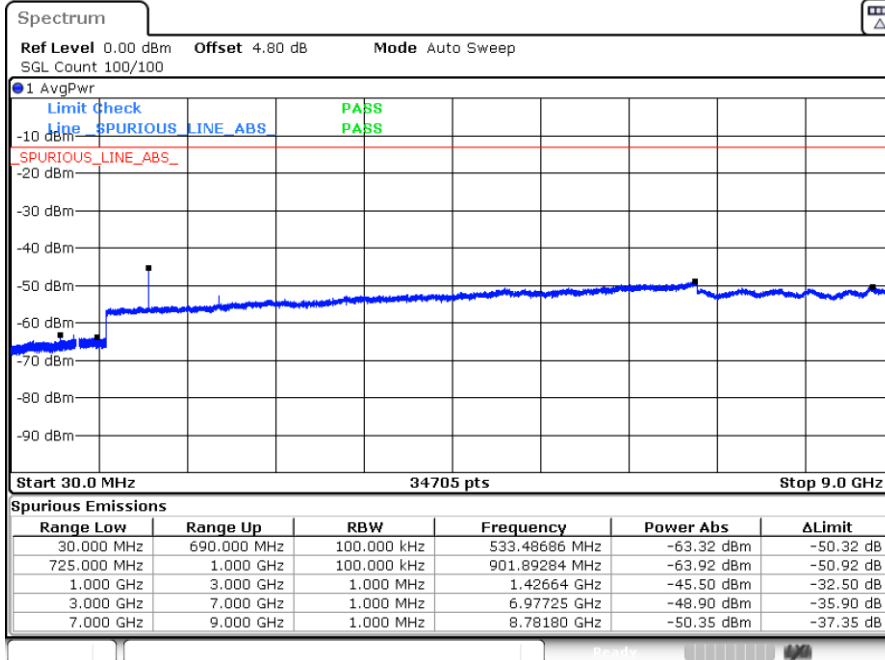

Date: 26.SEP.2024 10:41:34



LTE Band 12 / 5MHz

Lowest Channel / QPSK

Middle Channel / QPSK

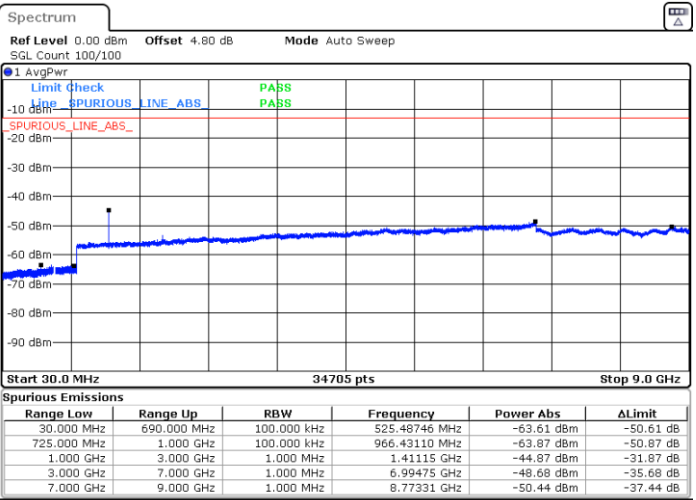
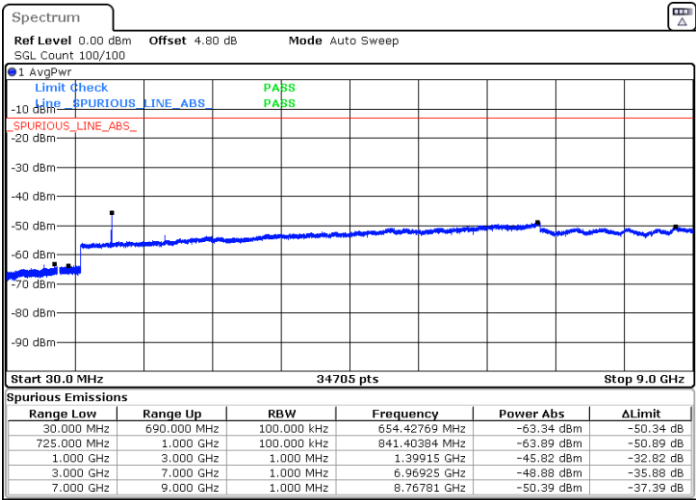

Date: 26.SEP.2024 11:11:52

Date: 26.SEP.2024 11:23:34

Highest Channel / QPSK

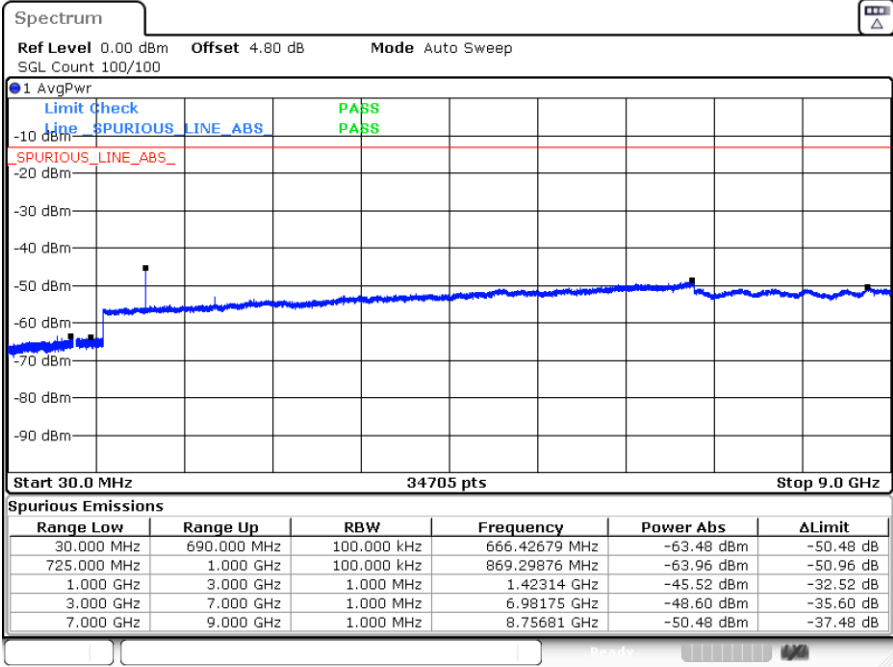

Date: 26.SEP.2024 11:25:00