



FCC RF Test Report

APPLICANT : Motorola Mobility LLC
EQUIPMENT : Mobile Cellular Phone
BRAND NAME : Motorola
MODEL NAME : XT2507-1
FCC ID : IHDT56AU3
STANDARD : 47 CFR Part 27(M)
CLASSIFICATION : PCS Licensed Transmitter Held to Ear (PCE)
TEST DATE(S) : Jan. 23, 2025 ~ Feb. 25, 2025

We, Sporton International Inc. (Kunshan), would like to declare that the tested sample has been evaluated in accordance with the procedures given in ANSI C63.26-2015 and shown compliance with the applicable technical standards.

This report contains data that were produced under subcontract by Sporton International Inc. (Shenzhen).

The test results in this report apply exclusively to the tested model / sample. Without written approval of Sporton International Inc. (Kunshan), the test report shall not be reproduced except in full.

Jason Jia



Approved by: Jason Jia

Sporton International Inc. (Kunshan)

**No. 1098, Pengxi North Road, Kunshan Economic Development Zone Jiangsu Province 215300
People's Republic of China**



TABLE OF CONTENTS

REVISION HISTORY... 3
SUMMARY OF TEST RESULT ... 4
1 GENERAL DESCRIPTION ... 5
1.1 Applicant ... 5
1.2 Manufacturer ... 5
1.3 Product Feature of Equipment Under Test ... 5
1.4 Product Specification of Equipment Under Test ... 6
1.5 Modification of EUT ... 7
1.6 Maximum EIRP Power and Emission Designator ... 7
1.7 Testing Location ... 9
1.8 Test Software ... 10
1.9 Applicable Standards ... 10
1.10 Specification of Accessory ... 11
2 TEST CONFIGURATION OF EQUIPMENT UNDER TEST ... 12
2.1 Test Mode ... 12
2.2 Connection Diagram of Test System ... 14
2.3 Support Unit used in test configuration and system ... 14
2.4 Measurement Results Explanation Example ... 14
2.5 Frequency List of Low/Middle/High Channels ... 15
3 CONDUCTED TEST ITEMS ... 19
3.1 Measuring Instruments ... 19
3.2 Test Setup ... 19
3.3 Test Result of Conducted Test ... 19
3.4 Conducted Output Power and EIRP ... 20
3.5 Peak-to-Average Ratio ... 22
3.6 Occupied Bandwidth ... 23
3.7 Conducted Band Edge ... 24
3.8 Conducted Spurious Emission ... 25
3.9 Frequency Stability ... 26
4 RADIATED TEST ITEMS ... 27
4.1 Measuring Instruments ... 27
4.2 Test Setup ... 27
4.3 Test Result of Radiated Test ... 28
4.4 Radiated Spurious Emission ... 29
5 LIST OF MEASURING EQUIPMENT ... 30
6 MEASUREMENT UNCERTAINTY ... 31
APPENDIX A. TEST RESULTS OF CONDUCTED TEST
APPENDIX B. TEST RESULTS OF RADIATED TEST
APPENDIX C. TEST SETUP PHOTOGRAPHS



SUMMARY OF TEST RESULT

Report Section	FCC Rule	Description	Limit	Result	Remark
3.4	§2.1046	Conducted Output Power	-	Report Only	-
	§27.50(h)(2)	Equivalent Isotropic Radiated Power (Band 7) (Band 38) (Band 41)	EIRP < 2Watt	PASS	-
3.5	N/A	Peak-to-Average Ratio	<13 dB	PASS	-
3.6	§2.1049	Occupied Bandwidth	-	Report Only	-
3.7	§27.53(m)(4)	Conducted Band Edge Measurement (Band 7) (Band 38) (Band 41)	§27.53(m)(4)	PASS	-
3.8	§2.1051 §27.53(m)(4)	Conducted Spurious Emission (Band 7) (Band 38) (Band 41)	< 55+10log ₁₀ (P[Watts])	PASS	-
3.9	§2.1055 §27.54	Frequency Stability Temperature & Voltage	Within Authorized Band	PASS	-
4.4	§2.1053 §27.53(m)(4)	Radiated Spurious Emission (Band 7) (Band 38) (Band 41)	< 55+10log ₁₀ (P[Watts])	PASS	Under limit 19.50 dB at 7752.00 MHz

Conformity Assessment Condition:

- The test results (PASS/FAIL) with all measurement uncertainty excluded are presented against the regulation limits or in accordance with the requirements stipulated by the applicant/manufacturer who shall bear all the risks of non-compliance that may potentially occur if measurement uncertainty is taken into account.
- The measurement uncertainty please refer to each test result in the section "Measurement Uncertainty"

Disclaimer:

The product specifications of the EUT presented in the test report that may affect the test assessments are declared by the manufacturer who shall take full responsibility for the authenticity.



1 General Description

1.1 Applicant

Motorola Mobility LLC
222 W,Merchandise Mart Plaza, Chicago IL 60654 USA

1.2 Manufacturer

Motorola Mobility LLC
222 W,Merchandise Mart Plaza, Chicago IL 60654 USA

1.3 Product Feature of Equipment Under Test

Product Feature	
Equipment	Mobile Cellular Phone
Brand Name	Motorola
Model Name	XT2507-1
FCC ID	IHDT56AU3
IMEI Code	Conducted: 358346690031930/358346690031948 Radiation: 358346690030072/358346690030080
HW Version	DVT2
SW Version	V2VV35.35
EUT Stage	Identical Prototype

Remark: The above EUT's information was declared by manufacturer. Please refer to the specifications or user's manual for more detailed description.



1.4 Product Specification of Equipment Under Test

Standards-related Product Specification	
Tx Frequency	LTE Band 7 : 2500 MHz ~ 2570 MHz LTE Band 38 : 2570 MHz ~ 2620 MHz LTE Band 41 : 2496 MHz ~ 2690 MHz
Rx Frequency	LTE Band 7 : 2620 MHz ~ 2690 MHz LTE Band 38 : 2570 MHz ~ 2620 MHz LTE Band 41 : 2496 MHz ~ 2690 MHz
Bandwidth	LTE Band 7 : 5MHz/ 10MHz / 15MHz / 20MHz LTE Band 38 : 5MHz / 10MHz / 15MHz / 20MHz LTE Band 41 : 5MHz / 10MHz / 15MHz / 20MHz
Maximum Output Power to Antenna	<p><Ant 0>: LTE Band 7 : 21.23 dBm LTE CA_7C : 21.11 dBm LTE Band 38 : 21.51 dBm LTE CA_38C : 21.40 dBm LTE Band 41 : 24.55 dBm LTE CA_41C : 21.53 dBm</p> <p><Ant 1>: LTE Band 7 : 21.85 dBm LTE CA_7C : 21.73 dBm LTE Band 38 : 21.66 dBm LTE CA_38C : 21.47 dBm LTE Band 41 : 24.87 dBm LTE CA_41C : 21.89 dBm</p> <p><Ant 2>: LTE Band 7 : 23.14 dBm LTE CA_7C : 22.97 dBm LTE Band 38 : 23.00 dBm LTE CA_38C : 22.95 dBm LTE Band 41 : 26.11 dBm LTE CA_41C : 22.96 dBm</p> <p><Ant 9>: LTE Band 7 : 23.24 dBm LTE CA_7C : 23.13 dBm LTE Band 38 : 23.21 dBm LTE CA_38C : 23.0 dBm LTE Band 41 : 26.29 dBm LTE CA_41C : 23.17 dBm</p>
Antenna Gain	<p><Ant 0>: LTE Band 7 : -3.0 dBi LTE Band 38 : -3.0 dBi LTE Band 41 : -3.0 dBi</p> <p><Ant 1>: LTE Band 7 : -4.0 dBi LTE Band 38 : -4.0 dBi LTE Band 41 : -4.0 dBi</p> <p><Ant 2>:</p>



	LTE Band 7 : -3.0 dBi LTE Band 38 : -3.0 dBi LTE Band 41 : -3.0 dBi <Ant 9> LTE Band 7 : -7.0 dBi LTE Band 38 : -8.0 dBi LTE Band 41 : -7.0 dBi
Type of Modulation	QPSK / 16QAM / 64QAM / 256QAM

Note:

1. The maximum EIRP is calculated from max output power and max antenna gain, so only the maximum EIRP of Antenna 2 for LTE Band7/7C/38/38C/41/41C are shown in the report.
2. For LTE Band 7/7C/38/38C/41/41C, the whole conducted test items have assessed ant.9 by referring to the higher conducted power.
3. The device supports two PAs for LTE Band 7(main PA and other PA, other PA for NSA mode), both the PAs are full tested, only the worst EIRP are shown in the report.
4. LTE Band 41 Single Carrier supports PC2.

1.5 Modification of EUT

No modifications are made to the EUT during all test items.

1.6 Maximum EIRP Power and Emission Designator

LTE Band 7		QPSK		16QAM/64QAM/256QAM	
BW (MHz)	Frequency Range (MHz)	Maximum EIRP(W)	Emission Designator (99%OBW)	Maximum EIRP(W)	Emission Designator (99%OBW)
5	2502.5 ~ 2567.5	0.1023	4M49G7D	0.0843	4M50W7D
10	2505.0 ~ 2565.0	0.1012	9M07G7D	0.0849	9M01W7D
15	2507.5 ~ 2562.5	0.1005	13M5G7D	0.0851	13M5W7D
20	2510.0 ~ 2560.0	0.1033	17M9G7D	0.0867	17M9W7D
LTE Band 38		QPSK		16QAM/64QAM/256QAM	
BW (MHz)	Frequency Range (MHz)	Maximum EIRP(W)	Emission Designator (99%OBW)	Maximum EIRP(W)	Emission Designator (99%OBW)
5	2572.5 ~ 2617.5	0.0984	4M48G7D	0.0796	4M47W7D
10	2575.0 ~ 2615.0	0.0971	9M07G7D	0.0796	8M95W7D
15	2577.5 ~ 2612.5	0.0973	13M4G7D	0.0796	13M6W7D
20	2580.0 ~ 2610.0	0.1000	17M9G7D	0.0807	17M8W7D



LTE Band 41		QPSK		16QAM/64QAM/256QAM	
BW (MHz)	Frequency Range (MHz)	Maximum EIRP(W)	Emission Designator (99%OBW)	Maximum EIRP(W)	Emission Designator (99%OBW)
5	2498.5 ~ 2687.5	0.1991	4M48G7D	0.1690	4M47W7D
10	2501.0 ~ 2685.0	0.2014	9M07G7D	0.1690	8M95W7D
15	2503.5 ~ 2682.5	0.2004	13M4G7D	0.1663	13M6W7D
20	2506.0 ~ 2680.0	0.2046	17M9G7D	0.1710	17M8W7D

LTE Band 7 CA		QPSK		16QAM/64QAM/256QAM	
BW (MHz)		Maximum EIRP(W)	Emission Designator (99%OBW)	Maximum EIRP(W)	Emission Designator (99%OBW)
10MHz+20MHz		0.0975	28M2G7D	0.0838	28M2W7D
15MHz+15MHz		0.0975	28M5G7D	0.0838	28M5W7D
15MHz+20MHz		0.0973	32M8G7D	0.0843	32M8W7D
15MHz+10MHz		0.0993	23M5G7D	0.0847	23M6W7D
20MHz+10MHz		0.0968	28M1G7D	0.0836	28M1W7D
20MHz+15MHz		0.0989	32M9G7D	0.0838	32M8W7D
20MHz+20MHz		0.0968	37M5G7D	0.0832	37M7W7D

LTE Band 38 CA		QPSK		16QAM/64QAM/256QAM	
BW (MHz)		Maximum EIRP(W)	Emission Designator (99%OBW)	Maximum EIRP(W)	Emission Designator (99%OBW)
15MHz+15MHz		0.0977	28M7G7D	0.0815	28M7W7D
20MHz+20MHz		0.0989	37M9G7D	0.0832	37M9W7D

LTE Band 41 CA		QPSK		16QAM/64QAM/256QAM	
BW (MHz)		Maximum EIRP(W)	Emission Designator (99%OBW)	Maximum EIRP(W)	Emission Designator (99%OBW)
5MHz+20MHz		0.0962	23M5G7D	0.0787	23M1W7D
10MHz+20MHz		0.0948	27M7G7D	0.0794	28M0W7D
10MHz+15MHz		0.0975	23M2G7D	0.0789	23M3W7D
15MHz+15MHz		0.0986	28M5G7D	0.0769	28M7W7D
15MHz+20MHz		0.0962	32M7G7D	0.0778	32M9W7D
15MHz+10MHz		0.0982	23M4G7D	0.0783	23M3W7D
20MHz+5MHz		0.0951	23M5G7D	0.0789	23M1W7D
20MHz+10MHz		0.0989	28M0G7D	0.0764	28M1W7D
20MHz+15MHz		0.0989	32M7G7D	0.0791	32M7W7D
20MHz+20MHz		0.0991	37M8G7D	0.0791	37M6W7D



Note:

1. LTE Band 41 overlaps the entire frequency range of LTE Band 38. Therefore, the test results provided in this report covers Band 41 as well as Band 38.
2. All modulations have been tested, and only the worst test results of PSK & QAM are shown in the report.

1.7 Testing Location

Sporton International Inc. (Kunshan) is accredited to ISO/IEC 17025:2017 by American Association for Laboratory Accreditation with Certificate Number 5145.02.

Test Firm	Sporton International Inc. (Kunshan)		
Test Site Location	No. 1098, Pengxi North Road, Kunshan Economic Development Zone Jiangsu Province 215300 People's Republic of China TEL : +86-512-57900158		
Test Site No.	Sporton Site No.	FCC Designation No.	FCC Test Firm Registration No.
	TH01-KS	CN1257	314309

Sporton International Inc. (ShenZhen) is accredited to ISO/IEC 17025:2017 by American Association for Laboratory Accreditation with Certificate Number 5145.01.

Test Firm	Sporton International Inc. (ShenZhen)		
Test Site Location	101, 1st Floor, Block B, Building 1, No. 2, Tengfeng 4th Road, Fenghuang Community, Fuyong Street, Baoan District, Shenzhen City, Guangdong Province 518103 People's Republic of China TEL: +86-755-86066985		
Test Site No.	Sporton Site No.	FCC Designation No.	FCC Test Firm Registration No.
	03CH02-SZ	CN1256	421272

Test data subcontracted: Radiated Spurious Emission test case in section 4.4 of this report.



1.8 Test Software

Item	Site	Manufacturer	Name	Version
1.	TH01-KS	SPORTON	Part2224_Ver5.0 200330	5.0
2.	03CH02-SZ	AUDIX	E3	6.2009-8-24a

1.9 Applicable Standards

According to the specifications of the manufacturer, the EUT must comply with the requirements of the following standards:

- ♦ 47 CFR Part 27(M)
- ♦ ANSI C63.26-2015
- ♦ FCC KDB 971168 D01 Power Meas License Digital Systems v03r01
- ♦ FCC KDB 412172 D01 Determining ERP and EIRP v01r01

Remark:

1. All test items were verified and recorded according to the standards and without any deviation during the test.
2. This EUT has also been tested and complied with the requirements of FCC Part 15, Subpart B, recorded in a separate test report.



1.10 Specification of Accessory

Accessories Information				
AC Adapter 1(US)	Brand Name	Motorola(Salcomp)	Model Name	MC-901
AC Adapter 1(EU)	Brand Name	Motorola(Salcomp)	Model Name	MC-902
AC Adapter 1(UK)	Brand Name	Motorola(Salcomp)	Model Name	MC-903
AC Adapter 1(AU)	Brand Name	Motorola(Salcomp)	Model Name	MC-905
AC Adapter 1(AR)	Brand Name	Motorola(Salcomp)	Model Name	MC-906
AC Adapter 1(BR)	Brand Name	Motorola(Salcomp)	Model Name	MC-907
AC Adapter 1(CHILE)	Brand Name	Motorola(Salcomp)	Model Name	MC-909
AC Adapter 2(US)	Brand Name	Motorola(AOHAI)	Model Name	MC-901
AC Adapter 2(EU)	Brand Name	Motorola(AOHAI)	Model Name	MC-902
AC Adapter 2(UK)	Brand Name	Motorola(AOHAI)	Model Name	MC-903
AC Adapter 2(AU)	Brand Name	Motorola(AOHAI)	Model Name	MC-905
AC Adapter 2(AR)	Brand Name	Motorola(AOHAI)	Model Name	MC-906
AC Adapter 2(BR)	Brand Name	Motorola(AOHAI)	Model Name	MC-907
AC Adapter 2(CHILE)	Brand Name	Motorola(AOHAI)	Model Name	MC-909
Battery	Brand Name	Motorola(ATL)	Model Name	RE60
USB Cable 1	Brand Name	Motorola(saibao)	Model Name	SC18D71644
USB Cable 2	Brand Name	Motorola(Luxshare)	Model Name	SC18E08104
USB Cable 3	Brand Name	Motorola(saibao)	Model Name	SC18D86731
USB Cable 4	Brand Name	Motorola(Luxshare)	Model Name	SC18E08103



2 Test Configuration of Equipment Under Test

2.1 Test Mode

Antenna port conducted and radiated test items listed below are performed according to KDB 971168 D01 Power Meas License Digital Systems v03r01 with maximum output power.

Radiated measurements are performed by rotating the EUT in three different orthogonal test planes to find the maximum emission. (Y Plane)

Test Items	Band	Bandwidth (MHz)						Modulation				RB #			Test Channel			
		1.4	3	5	10	15	20	QPSK	16 QAM	64 QAM	256 QAM	1	Half	Full	L	M	H	
Max. Output Power	7	-	-	v	v	v	v	v	v	v	v	v	v	v	v	v	v	v
	38	-	-	v	v	v	v	v	v	v	v	v	v	v	v	v	v	v
	41	-	-	v	v	v	v	v	v	v	v	v	v	v	v	v	v	v
Peak-to-Average Ratio	7	-	-				v	v	v	v	v			v		v		
	41	-	-				v	v	v	v	v			v		v		
26dB and 99% Bandwidth	7	-	-	v	v	v	v	v	v					v		v		
	41	-	-	v	v	v	v	v	v					v		v		
Conducted Band Edge	7	-	-	v	v	v	v	v	v	v	v	v		v	v			v
	41	-	-	v	v	v	v	v	v	v	v	v		v	v			v
Conducted Spurious Emission	7	-	-	v	v	v	v	v					v			v	v	v
	41	-	-	v	v	v	v	v					v			v	v	v
Frequency Stability	7	-	-		v			v						v		v		
	41	-	-		v			v						v		v		
E.I.R.P	7	-	-	v	v	v	v	v	v	v	v	v	v	v	v	v	v	v
	38	-	-	v	v	v	v	v	v	v	v	v	v	v	v	v	v	v
	41	-	-	v	v	v	v	v	v	v	v	v	v	v	v	v	v	v
Radiated Spurious Emission	7	Worst Case															v	
	41	Worst Case															v	
Note	<ol style="list-style-type: none"> The mark "v" means that this configuration is chosen for testing The mark "-" means that this bandwidth is not supported. The device is investigated from 30MHz to 10 times of fundamental signal for radiated spurious emission test under different RB size/offset and modulations in exploratory test. Subsequently, only the worst case emissions are reported. 																	



Test Items	Band	Bandwidth (MHz)										Modulation			RB #			Test Channel			
		20+20	20+15	15+20	20+10	10+20	20+5	5+20	15+15	15+10	10+15	QPSK	16 QAM	64 QAM	256 QAM	1	Half	Full	L	M	H
Max. Output Power	7C_CA	v	v	v	v	v	-	-	v	v	-	v	v	v	v	v			v	v	v
	38C_CA	v	-	-	-	-	-	-	v	-	-	v	v	v	v	v			v	v	v
	41C_CA	v	v	v	v	v	v	v	v	v	v	v	v	v	v	v			v	v	v
26dB and 99% Bandwidth	7C_CA	v	v	v	v	v	-	-	v	v	-	v	v					v		v	
	41C_CA	v	v	v	v	v	v	v	v	v	v	v	v					v		v	
Conducted Band Edge	7C_CA	v	v	v	v	v	-	-	v	v	-	v	v	v	v	v		v	v	v	
	41C_CA	v	v	v	v	v	v	v	v	v	v	v	v	v	v	v		v	v	v	
Conducted Spurious Emission	7C_CA	v	v	v	v	v	-	-	v	v	-	v				v			v	v	v
	41C_CA	v	v	v	v	v	v	v	v	v	v	v				v			v	v	v
E.I.R.P.	7C_CA	v	v	v	v	v	-	-	v	v	-	v	v	v	v	v			v	v	v
	38C_CA	v	-	-	-	-	-	-	v	-	-	v	v	v	v	v			v	v	v
	41C_CA	v	v	v	v	v	v	v	v	v	v	v	v	v	v	v			v	v	v
Radiated Spurious Emission	7C_CA	Worst Case																		v	
	41C_CA	Worst Case																		v	
Note	1. The mark "v" means that this configuration is chosen for testing 2. The mark "-" means that this bandwidth is not supported. 3. The device is investigated from 30MHz to 10 times of fundamental signal for radiated spurious emission test under different RB size/offset and modulations in exploratory test. Subsequently, only the worst case emissions are reported.																				

2.2 Connection Diagram of Test System

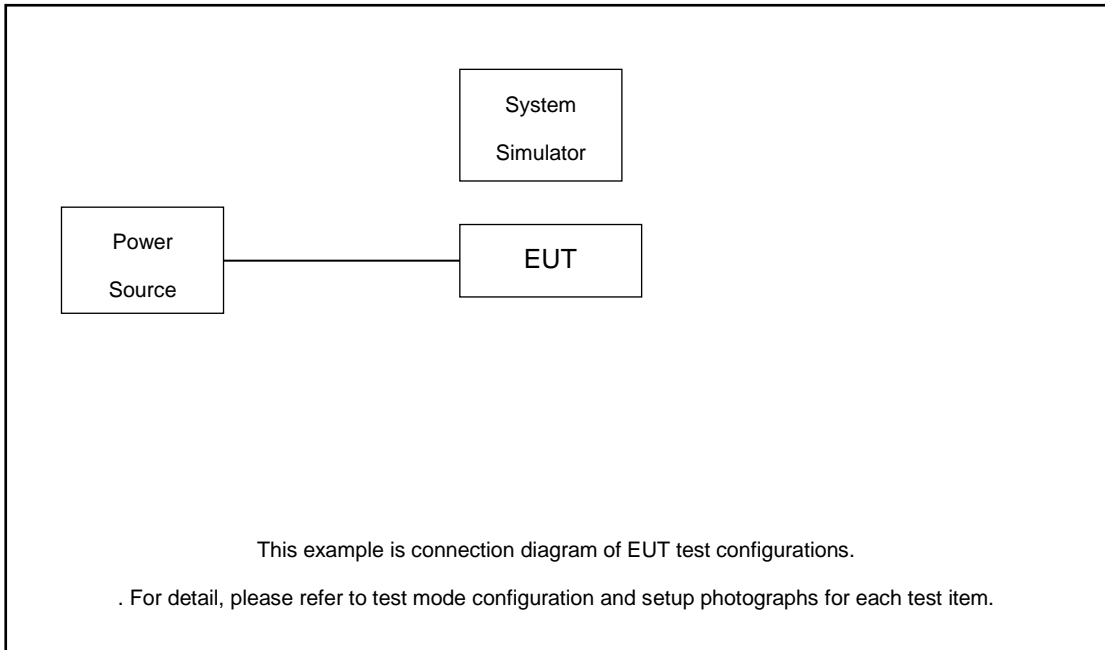

2.3 Support Unit used in test configuration and system

Item	Equipment	Trade Name	Model No.	FCC ID	Data Cable	Power Cord
1.	Power Supply	GWINSTEK	PSS-2002	N/A	N/A	Unshielded, 1.8 m
2.	LTE Base Station	Anritsu	MT8820C	N/A	N/A	Unshielded, 1.8 m

2.4 Measurement Results Explanation Example

For all conducted test items:

The offset level is set in the spectrum analyzer to compensate the RF cable loss between EUT conducted output port and spectrum analyzer. With the offset compensation, the spectrum analyzer reading level is exactly the EUT RF output level.

The spectrum analyzer offset is derived from RF cable loss.

Offset = RF cable loss.

Following shows an offset computation example with cable loss 6.0 dB.

Example :

$$\begin{aligned} \text{Offset(dB)} &= \text{RF cable loss(dB)}. \\ &= 6.0 \text{ (dB)} \end{aligned}$$



2.5 Frequency List of Low/Middle/High Channels

LTE Band 7 Channel and Frequency List				
BW [MHz]	Channel/Frequency(MHz)	Lowest	Middle	Highest
20	Channel	20850	21100	21350
	Frequency	2510	2535	2560
15	Channel	20825	21100	21375
	Frequency	2507.5	2535	2562.5
10	Channel	20800	21100	21400
	Frequency	2505	2535	2565
5	Channel	20775	21100	21425
	Frequency	2502.5	2535	2567.5

LTE Band 38 Channel and Frequency List				
BW [MHz]	Channel/Frequency(MHz)	Lowest	Middle	Highest
20	Channel	37850	38000	38150
	Frequency	2580	2595	2610
15	Channel	37825	38000	38175
	Frequency	2577.5	2595	2612.5
10	Channel	37800	38000	38200
	Frequency	2575	2595	2615
5	Channel	37775	38000	38225
	Frequency	2572.5	2595	2617.5

LTE Band 41 Channel and Frequency List				
BW [MHz]	Channel/Frequency(MHz)	Lowest	Middle	Highest
20	Channel	39750	40620	41490
	Frequency	2506	2593	2680
15	Channel	39725	40620	41515
	Frequency	2503.5	2593	2682.5
10	Channel	39700	40620	41540
	Frequency	2501	2593	2685
5	Channel	39675	40620	41565
	Frequency	2498.5	2593	2687.5



LTE Band 7C_CA Channel and Frequency List					
BW [MHz]	Channel/Frequency(MHz)		Lowest	Middle	Highest
20 + 20	PCC	Channel	20850	21001	21152
		Frequency	2510.0	2525.1	2540.2
	SCC	Channel	21048	21199	21350
		Frequency	2529.8	2544.9	2560.0
20 + 15	PCC	Channel	20850	21026	21201
		Frequency	2510.0	2527.6	2545.1
	SCC	Channel	21021	21197	21372
		Frequency	2527.1	2544.7	2562.2
15 + 20	PCC	Channel	20828	21003	21179
		Frequency	2507.8	2525.3	2542.9
	SCC	Channel	20999	21174	21350
		Frequency	2524.9	2542.4	2560.0
20 + 10	PCC	Channel	20850	21051	21251
		Frequency	2510.0	2530.1	2550.1
	SCC	Channel	20994	21195	21395
		Frequency	2524.4	2544.5	2564.5
10 + 20	PCC	Channel	20805	21006	21206
		Frequency	2505.5	2525.6	2545.6
	SCC	Channel	20949	21150	21350
		Frequency	2519.9	2540.0	2560.0
15 + 15	PCC	Channel	20825	21025	21225
		Frequency	2507.5	2527.5	2547.5
	SCC	Channel	20975	21175	21375
		Frequency	2522.5	2542.5	2562.5
15 + 10	PCC	Channel	20825	21051	21277
		Frequency	2507.5	2530.1	2552.7
	SCC	Channel	20945	21171	21397
		Frequency	2519.5	2542.1	2564.7



LTE Band 38C_CA Channel and Frequency List					
BW [MHz]	Channel/Frequency(MHz)		Lowest	Middle	Highest
20 + 20	PCC	Channel	37850	37901	37952
		Frequency	2580.0	2585.1	2590.2
	SCC	Channel	38048	38099	38150
		Frequency	2599.8	2604.9	2610.0
15+ 15	PCC	Channel	37825	37925	38025
		Frequency	2577.5	2587.5	2597.5
	SCC	Channel	37975	38075	38175
		Frequency	2592.5	2602.5	2612.5

LTE Band 41C_CA Channel and Frequency List					
BW [MHz]	Channel/Frequency(MHz)		Lowest	Middle	Highest
20 + 20	PCC	Channel	39750	40521	41292
		Frequency	2506.0	2583.1	2660.2
	SCC	Channel	39948	40719	41490
		Frequency	2525.8	2602.9	2680.0
20 + 15	PCC	Channel	39750	40546	41341
		Frequency	2506.0	2585.6	2665.1
	SCC	Channel	39921	40717	41512
		Frequency	2523.1	2602.7	2682.2
15 + 20	PCC	Channel	39728	40523	41319
		Frequency	2503.8	2593.3	2662.9
	SCC	Channel	39899	40694	41490
		Frequency	2520.9	2600.4	2680.0
20 + 10	PCC	Channel	39750	40571	41391
		Frequency	2506.0	2588.1	2670.1
	SCC	Channel	39894	40715	41535
		Frequency	2520.4	2602.5	2684.5
10 + 20	PCC	Channel	39705	40526	41346
		Frequency	2501.5	2583.6	2665.6
	SCC	Channel	39849	40670	41490
		Frequency	2515.9	2598.0	2680.0



LTE Band 41C_CA Channel and Frequency List					
20 + 5	PCC	Channel	39750	40595	41440
		Frequency	2506.0	2590.5	2675.0
	SCC	Channel	39867	40712	41557
		Frequency	2517.7	2602.2	2686.7
5 + 20	PCC	Channel	39683	40528	41373
		Frequency	2499.3	2583.8	2668.3
	SCC	Channel	39800	40645	41490
		Frequency	2511.0	2595.5	2680.0
15 + 15	PCC	Channel	39725	40545	41365
		Frequency	2503.5	2585.5	2667.5
	SCC	Channel	39875	40695	41515
		Frequency	2518.5	2600.5	2682.5
10 + 15	PCC	Channel	39703	40549	41395
		Frequency	2501.3	2585.9	2670.5
	SCC	Channel	39823	40669	41515
		Frequency	2513.3	2597.9	2682.5
15 + 10	PCC	Channel	39725	40571	41417
		Frequency	2503.5	2588.1	2672.7
	SCC	Channel	39845	40691	41537
		Frequency	2515.5	2600.1	2684.7

3 Conducted Test Items

3.1 Measuring Instruments

See list of measuring instruments of this test report.

3.2 Test Setup

3.2.1 Conducted Output Power

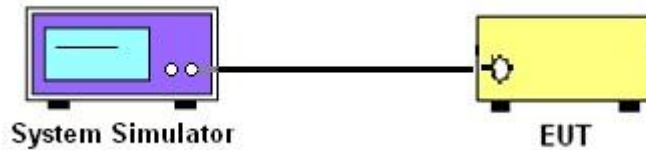

3.2.2 Peak-to-Average Ratio, Occupied Bandwidth ,Conducted Band-Edge and Conducted Spurious Emission

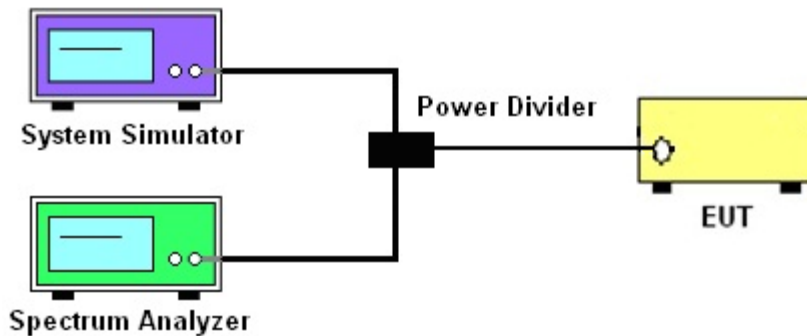

3.2.3 Frequency Stability

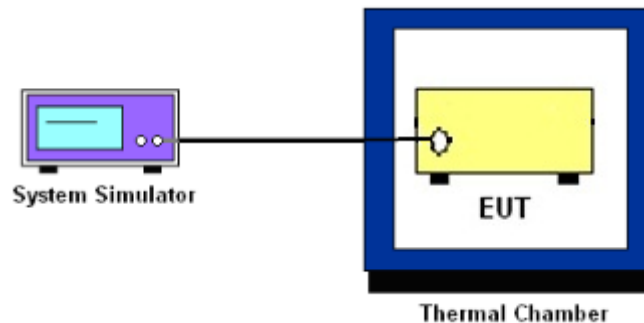

3.3 Test Result of Conducted Test

Please refer to Appendix A.



3.4 Conducted Output Power and EIRP

3.4.1 Description of the Conducted Output Power Measurement and EIRP Measurement

A system simulator was used to establish communication with the EUT. Its parameters were set to force the EUT transmitting at maximum output power. The measured power in the radio frequency on the transmitter output terminals shall be reported.

The EIRP of mobile transmitters must not exceed 2 Watts for LTE Band 7 and Band 38 and Band 41.

According to KDB 412172 D01 Power Approach,

$EIRP = P_T + G_T - L_C$, $ERP = EIRP - 2.15$, where

P_T = transmitter output power in dBm

G_T = gain of the transmitting antenna in dBi

L_C = signal attenuation in the connecting cable between the transmitter and antenna in dB

3.4.2 Test Procedures

1. The testing follows ANSI C63.26 Section 5.2
2. The transmitter output port was connected to the system simulator.
3. Set EUT at maximum power through the system simulator.
4. Select lowest, middle, and highest channels for each band and different modulation.
5. Measure and record the power level from the system simulator.

3.4.3 Test Procedures for LTE ULCA

1. The testing follows ANSI C63.26 Section 5.2
2. The transmitter PCC & SCC output ports were connected to the system simulator.
3. Set EUT at maximum power, set the PCC/SCC CA band, channel, bandwidth and RB config.

PCC config_(Channel Bandwidth / Channel / Band)

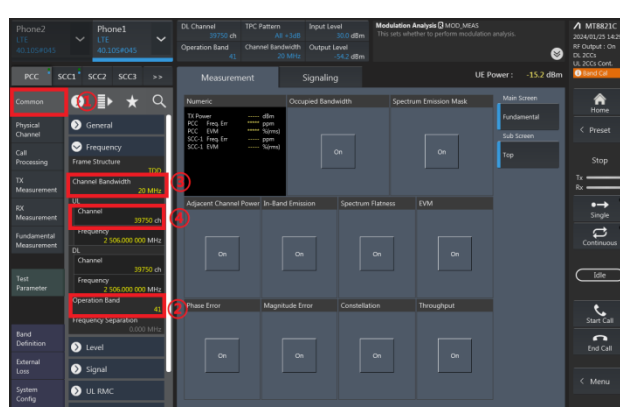

SCC config_(Channel Bandwidth / Channel / Band)

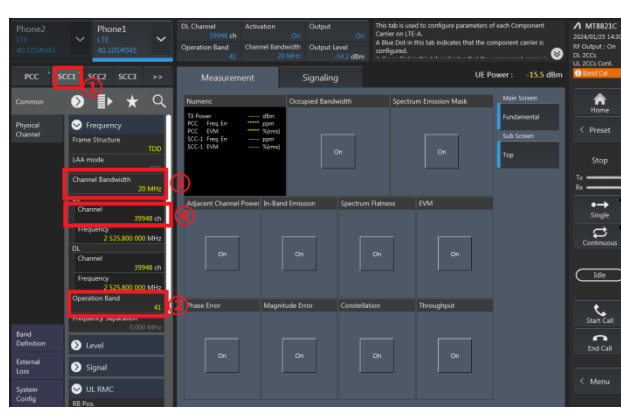

PCC config_(Number of RB / Starting RB)

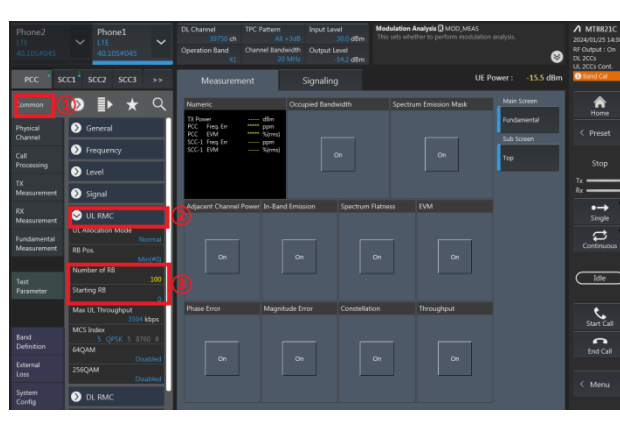

SCC config_(Number of RB / Starting RB)

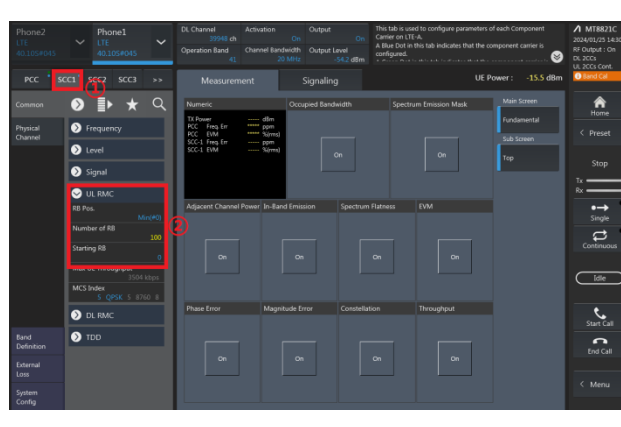

4. Select lowest, middle, and highest channels for each ULCA band and different modulation.
5. Check the ULCA spectrum and record the total power from the system simulator.

Check the ULCA spectrum (eg. 20M+20M)

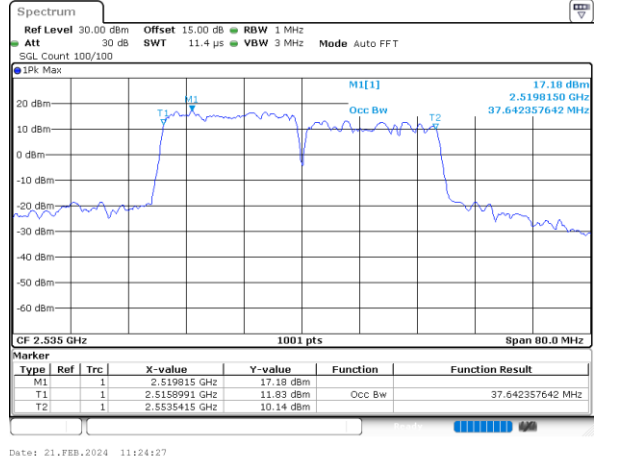

Read the Total UL CA output power (PCC+SCC)

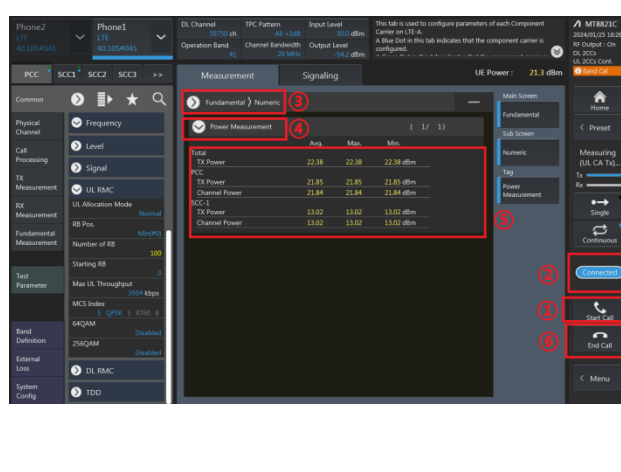



3.5 Peak-to-Average Ratio

3.5.1 Description of the PAR Measurement

Power Complementary Cumulative Distribution Function (CCDF) curves provide a means for characterizing the power peaks of a digitally modulated signal on a statistical basis. A CCDF curve depicts the probability of the peak signal amplitude exceeding the average power level. Most contemporary measurement instrumentation include the capability to produce CCDF curves for an input signal provided that the instrument's resolution bandwidth can be set wide enough to accommodate the entire input signal bandwidth. In measuring transmissions in this band using an average power technique, the peak-to-average ratio (PAR) of the transmission may not exceed 13 dB.

3.5.2 Test Procedures

1. The testing follows ANSI C63.26 Section 5.2.3.4 (CCDF).
2. The EUT was connected to spectrum and system simulator via a power divider.
3. Set the CCDF (Complementary Cumulative Distribution Function) option in spectrum analyzer.
4. The highest RF powers were measured and recorded the maximum PAPR level associated with a probability of 0.1 %.
5. Record the deviation as Peak to Average Ratio.



3.6 Occupied Bandwidth

3.6.1 Description of Occupied Bandwidth Measurement

The occupied bandwidth is the width of a frequency band such that, below the lower and above the upper frequency limits, the mean powers emitted are each equal to a specified percentage 0.5% of the total mean transmitted power.

The 26 dB emission bandwidth is defined as the frequency range between two points, one above and one below the carrier frequency, at which the spectral density of the emission is attenuated 26 dB below the maximum in-band spectral density of the modulated signal. Spectral density (power per unit bandwidth) is to be measured with a detector of resolution bandwidth equal to approximately 1.0% of the emission bandwidth.

3.6.2 Test Procedures

1. The testing follows ANSI C63.26 Section 5.4
2. The EUT was connected to spectrum analyzer and system simulator via a power divider.
3. The spectrum analyzer center frequency is set to the nominal EUT channel center frequency. The span range for the spectrum analyzer shall be between two and five times the anticipated OBW.
4. The nominal resolution bandwidth (RBW) shall be in the range of 1 to 5 % of the anticipated OBW, and the VBW shall be at least 3 times the RBW.
5. Set the detection mode to peak, and the trace mode to max hold.
6. Determine the reference value: Set the EUT to transmit a modulated signal. Allow the trace to stabilize. Set the spectrum analyzer marker to the highest level of the displayed trace.
(this is the reference value)
7. Determine the “-26 dB down amplitude” as equal to (Reference Value – X).
8. Place two markers, one at the lowest and the other at the highest frequency of the envelope of the spectral display such that each marker is at or slightly below the “-X dB down amplitude” determined in step 6. If a marker is below this “-X dB down amplitude” value it shall be placed as close as possible to this value. The OBW is the positive frequency difference between the two markers.
9. Use the 99 % power bandwidth function of the spectrum analyzer and report the measured bandwidth.



3.7 Conducted Band Edge

3.7.1 Description of Conducted Band Edge Measurement

27.53(m)(4)

For mobile digital stations, the attenuation factor shall be not less than $40 + 10 \log (P)$ dB on all frequencies between the channel edge and 5 megahertz from the channel edge, $43 + 10 \log (P)$ dB on all frequencies between 5 megahertz and X megahertz from the channel edge, and $55 + 10 \log (P)$ dB on all frequencies more than X megahertz from the channel edge, where X is the greater of 6 megahertz or the actual emission bandwidth as defined in paragraph (m)(6) of this section. In addition, the attenuation factor shall not be less than $43 + 10 \log (P)$ dB on all frequencies between 2490.5 MHz and 2496 MHz and $55 + 10 \log (P)$ dB at or below 2490.5 MHz. Mobile Satellite Service licensees operating on frequencies below 2495 MHz may also submit a documented interference complaint against BRS licensees operating on channel BRS Channel 1 on the same terms and conditions as adjacent channel BRS or EBS licensees.

3.7.2 Test Procedures

1. The testing follows ANSI C63.26 section 5.7
2. The EUT was connected to spectrum analyzer and system simulator via a power divider.
3. The band edges of low and high channels for the highest RF powers were measured.
4. Set RBW $\geq 1\%/2\%$ EBW in the 1MHz band immediately outside and adjacent to the band edge.
5. Beyond the 1 MHz band from the band edge, RBW=1MHz was used or a narrower RBW was used and the measured power was integrated over the full required measurement bandwidth of 1 MHz.
6. Set spectrum analyzer with RMS detector.
7. Offset has included the duty factor for LTE Band 41. Duty factor = $10 \log (1/x)$, where x is the measured duty cycle
8. The RF fundamental frequency should be excluded against the limit line in the operating frequency band.
9. Checked that all the results comply with the emission limit line.
10. For LTE Band 7, 38, 41, the other 40 dB, and 55 dB have additionally applied same calculation above.
11. When using the integration method, the starting frequency of the integration shall be centered at one-half of the RBW away from the band edge.



3.8 Conducted Spurious Emission

3.8.1 Description of Conducted Spurious Emission Measurement

For Band 7,38,41:

The power of any emission outside of the authorized operating frequency ranges must be lower than the transmitter power (P) by a factor of at least $55 + 10 \log (P)$ dB.

It is measured by means of a calibrated spectrum analyzer and scanned from 30 MHz up to a frequency including its 10th harmonic.

3.8.2 Test Procedures

1. The testing follows ANSI C63.26 section 5.7
2. The EUT was connected to spectrum analyzer and system simulator via a power divider.
3. The RF output of EUT was connected to the spectrum analyzer by RF cable and attenuator. The path loss was compensated to the results for each measurement.
4. The middle channel for the highest RF power within the transmitting frequency was measured.
5. The conducted spurious emission for the whole frequency range was taken.
6. Make the measurement with the spectrum analyzer's RBW = 1MHz, VBW = 3MHz.
7. Set spectrum analyzer with RMS detector.
8. Offset has included the duty factor for LTE Band 41. Duty factor = $10 \log (1/x)$, where x is the measured duty cycle
9. Taking the record of maximum spurious emission.
10. The RF fundamental frequency should be excluded against the limit line in the operating frequency band.
11. For Band 7, 38, 41

$$\begin{aligned} & \text{The limit line is derived from } 55 + 10\log(P)\text{dB below the transmitter power P(Watts)} \\ & = P(W) - [55 + 10\log(P)] \text{ (dB)} \\ & = [30 + 10\log(P)] \text{ (dBm)} - [55 + 10\log(P)] \text{ (dB)} \\ & = -25\text{dBm.} \end{aligned}$$



3.9 Frequency Stability

3.9.1 Description of Frequency Stability Measurement

The frequency stability shall be measured by variation of ambient temperature and variation of primary supply voltage to ensure that the fundamental emission stays within the authorized frequency block.

3.9.2 Test Procedures for Temperature Variation

1. The testing follows ANSI C63.26 section 5.6.4
2. The EUT was set up in the thermal chamber and connected with the system simulator.
3. With power OFF, the temperature was decreased to -30°C and the EUT was stabilized before testing. Power was applied and the maximum change in frequency was recorded within one minute.
4. With power OFF, the temperature was raised in 10°C step up to 50°C . The EUT was stabilized at each step for at least half an hour. Power was applied and the maximum frequency change was recorded within one minute.

3.9.3 Test Procedures for Voltage Variation

1. The testing follows ANSI C63.26 section 5.6.5
2. The EUT was placed in a temperature chamber at $20\pm 5^{\circ}\text{C}$ and connected with the system simulator.
3. The power supply voltage to the EUT was varied from 85% to 115% of the nominal value for other than hand carried battery equipment.
4. For hand carried, battery powered equipment, reduce the primary ac or dc supply voltage to the battery operating end point, which shall be specified by the manufacturer.
5. The variation in frequency was measured for the worst case.

4 Radiated Test Items

4.1 Measuring Instruments

See list of measuring instruments of this test report.

4.2 Test Setup

4.2.1 For radiated test below 30MHz

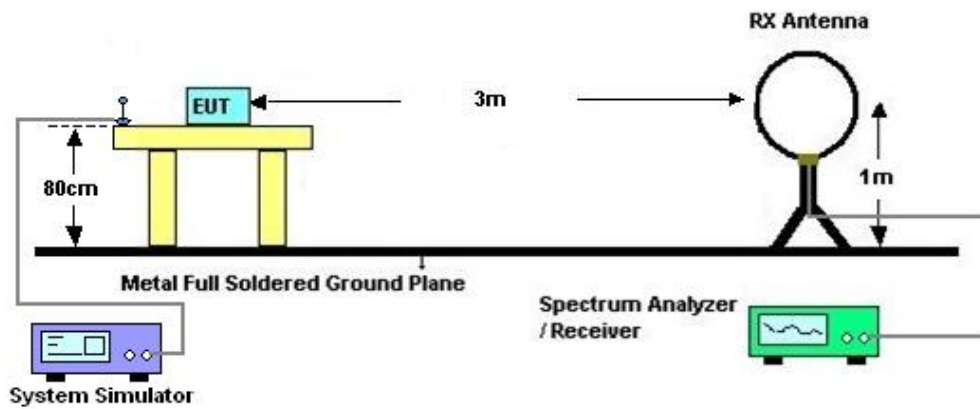

4.2.2 For radiated test from 30MHz to 1GHz

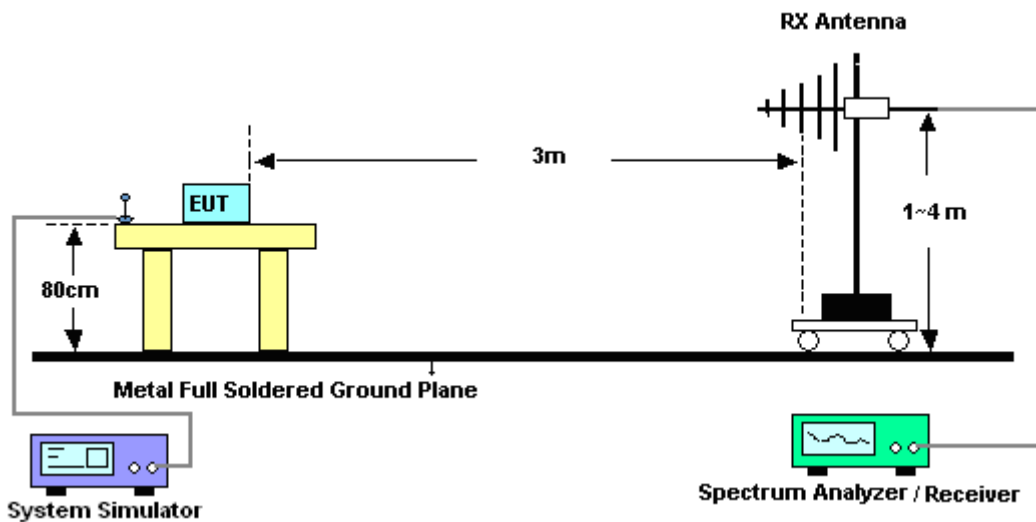

4.2.3 For radiated test above 1GHz

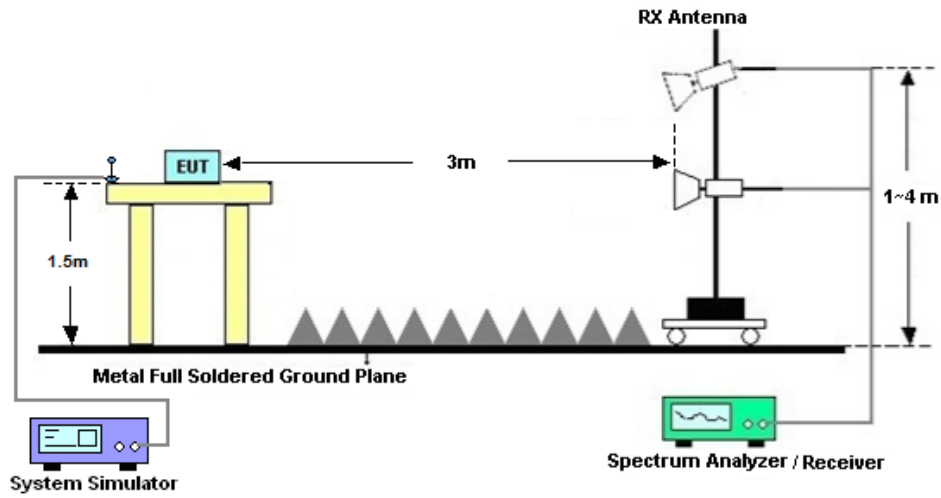

4.3 Test Result of Radiated Test

The low frequency, which started from 9 kHz to 30MHz, was pre-scanned and the result which was 20dB lower than the limit line was not reported.

Please refer to Appendix B.



4.4 Radiated Spurious Emission

4.4.1 Description of Radiated Spurious Emission

The radiated spurious emission was measured by substitution method according to ANSI C63.26.

For Band 7, 38, 41

The power of any emission outside of the authorized operating frequency ranges must be attenuated below the transmitter power (P) by a factor of at least $55 + 10 \log (P)$ dB.

The spectrum is scanned from 30 MHz up to a frequency including its 10th harmonic.

4.4.2 Test Procedures

1. The testing follows ANSI C63.26 Section 5.5
2. The EUT was placed on a turntable with 0.8 meter height for frequency below 1GHz and 1.5 meter height for frequency above 1GHz respectively above ground.
3. The EUT was set 3 meters from the receiving antenna mounted on the antenna tower.
4. The table was rotated 360 degrees to determine the position of the highest spurious emission.
5. The height of the receiving antenna is varied between 1m to 4m to search the maximum spurious emission for both horizontal and vertical polarizations.
6. During the measurement, the system simulator parameters were set to force the EUT transmitting at maximum output power.
7. Make the measurement with the spectrum analyzer's RBW = 1MHz, VBW = 3MHz, taking the record of maximum spurious emission.
8. A horn antenna was substituted in place of the EUT and was driven by a signal generator.
9. Tune the output power of signal generator to the same emission level with EUT maximum spurious emission.
10. $EIRP (dBm) = S.G. Power - Tx Cable Loss + Tx Antenna Gain$
11. $ERP (dBm) = EIRP - 2.15$
12. For Band 7, 38, 41:
The limit line is derived from $55 + 10\log(P)$ dB below the transmitter power P(Watts)



5 List of Measuring Equipment

Instrument	Manufacturer	Model No.	Serial No.	Characteristics	Calibration Date	Test Date	Due Date	Remark
Spectrum Analyzer	R&S	FSV40	101040	10Hz~40GHz	Oct. 10, 2024	Jan. 23, 2025~ Feb. 24, 2025	Oct. 09, 2025	Conducted (TH01-KS)
Power divider	STI	STI08-0055	-	0.5~40GHz	NCR	Jan. 23, 2025~ Feb. 24, 2025	NCR	Conducted (TH01-KS)
Temperature & humidity chamber	Hongzhan	LP-150U	H2014011440	-40~+150°C 20%~95%RH	Jul. 04, 2024	Jan. 23, 2025~ Feb. 24, 2025	Jul. 03, 2025	Conducted (TH01-KS)
EXA Spectrum Analyzer	KEYSIGHT	N9010A	MY55150213	10Hz~44GHz	Jul. 03, 2024	Feb. 19, 2025~ Feb. 25, 2025	Jul. 02, 2025	Radiation (03CH02-SZ)
Loop Antenna	R&S	HFH2-Z2E	101141	9kHz~30MHz	Dec. 28, 2024	Feb. 19, 2025~ Feb. 25, 2025	Dec. 27, 2025	Radiation (03CH02-SZ)
Bilog Antenna	TeseQ	CBL6112D	35407	30MHz-2GHz	Oct. 24, 2023	Feb. 19, 2025~ Feb. 25, 2025	Oct. 23, 2025	Radiation (03CH02-SZ)
Double Ridge Horn Antenna	ETS-Lindgren	3117	00119436	1GHz~18GHz	Jul. 04, 2024	Feb. 19, 2025~ Feb. 25, 2025	Jul. 04, 2025	Radiation (03CH02-SZ)
HF Amplifier	MITEQ	TTA1840-35-HG	1871923	18GHz~40GHz	Jul. 03, 2024	Feb. 19, 2025~ Feb. 25, 2025	Jul. 03, 2025	Radiation (03CH02-SZ)
SHF-EHF Horn	com-power	AH-840	101071	18Ghz-40GHz	Apr. 09, 2024	Feb. 19, 2025~ Feb. 25, 2025	Apr. 08, 2025	Radiation (03CH02-SZ)
LF Amplifier	Burgeon	BPA-530	102211	0.01~3000Mhz	Oct. 18, 2024	Feb. 19, 2025~ Feb. 25, 2025	Oct. 17, 2025	Radiation (03CH02-SZ)
HF Amplifier	KEYSIGHT	83017A	MY53270105	0.5GHz~26.5Ghz	Oct. 14, 2024	Feb. 19, 2025~ Feb. 25, 2025	Oct. 13, 2025	Radiation (03CH02-SZ)
AC Power Source	Chroma	61601	616010003043	N/A	Oct. 18, 2024	Feb. 19, 2025~ Feb. 25, 2025	Oct. 17, 2025	Radiation (03CH02-SZ)
Turn Table	Chaintek	T-200	N/A	0~360 degree	NCR	Feb. 19, 2025~ Feb. 25, 2025	NCR	Radiation (03CH02-SZ)
Antenna Mast	Chaintek	MBS-400	N/A	1 m~4 m	NCR	Feb. 19, 2025~ Feb. 25, 2025	NCR	Radiation (03CH02-SZ)

NCR: No Calibration Required



6 Measurement Uncertainty

The measurement uncertainties shown below were calculated in accordance with the requirements of ANSI 63.26-2015. All the measurement uncertainty value were shown with a coverage K=2 to indicate 95% level of confidence. The measurement data show herein meets or exceeds the CISPR measurement uncertainty values specified in CISPR 16-4-2 and can be compared directly to specified limit to determine compliance.

Uncertainty of Conducted Measurement

Test Item	Uncertainty
Conducted Spurious Emission & Bandedge	±2.22 dB
Occupied Channel Bandwidth	±0.1%
Conducted Power	±0.50 dB
Peak to Average Ratio	±0.50 dB
Frequency Stability	±0.04 ppm

Uncertainty of Radiated Emission Measurement (30 MHz ~ 1000 MHz)

Measuring Uncertainty for a Level of Confidence of 95% (U = 2Uc(y))	2.47 dB
---	---------

Uncertainty of Radiated Emission Measurement (1 GHz ~ 18 GHz)

Measuring Uncertainty for a Level of Confidence of 95% (U = 2Uc(y))	3.31 dB
---	---------

Uncertainty of Radiated Emission Measurement (18 GHz ~ 40 GHz)

Measuring Uncertainty for a Level of Confidence of 95% (U = 2Uc(y))	3.72 dB
---	---------

----- THE END -----



Appendix A. Test Results of Conducted Test

Test Engineer :	Smile Wang	Temperature :	22~23°C
		Relative Humidity :	40~42%

Conducted Output Power(Average power) and EIRP

LTE Band7_Ant 2:

BW [MHz]	Modulation	RB Size	RB Offset	Power Low	Power Middle	Power High	EIRP(W)		
				Ch. / Freq.	Ch. / Freq.	Ch. / Freq.	L	M	H
Channel				20850	20850	21350	EIRP(W)		
Frequency (MHz)				2510	2535	2560	L	M	H
20	QPSK	1	0	23.06	23.14	22.92	0.1014	0.1033	0.0982
20	QPSK	1	99	22.94	23.04	22.91	0.0986	0.1009	0.0979
20	QPSK	100	0	21.75	21.93	21.80	0.0750	0.0782	0.0759
20	16QAM	1	0	22.28	22.34	22.38	0.0847	0.0859	0.0867
20	64QAM	1	0	21.32	21.20	21.27	0.0679	0.0661	0.0671
20	256QAM	1	0	18.05	18.06	17.98	0.0320	0.0321	0.0315
Channel				20825	21100	21375	EIRP(W)		
Frequency (MHz)				2507.5	2535	2562.5	L	M	H
15	QPSK	1	0	22.97	23.02	22.87	0.0993	0.1005	0.0971
15	16QAM	1	0	22.18	22.25	22.30	0.0828	0.0841	0.0851
Channel				20800	21100	21400	EIRP(W)		
Frequency (MHz)				2505	2535	2565	L	M	H
10	QPSK	1	0	22.94	23.05	22.86	0.0986	0.1012	0.0968
10	16QAM	1	0	22.18	22.23	22.29	0.0828	0.0838	0.0849
Channel				20775	21100	21425	EIRP(W)		
Frequency (MHz)				2502.5	2535	2567.5	L	M	H
5	QPSK	1	0	23.01	23.10	22.84	0.1002	0.1023	0.0964
5	16QAM	1	0	22.21	22.26	22.25	0.0834	0.0843	0.0841



LTE Band38_Ant 2:

BW [MHz]	Modulation	RB Size	RB Offset	Power Low Ch. / Freq.	Power Middle Ch. / Freq.	Power High Ch. / Freq.	EIRP(W)		
Channel				37850	38000	38150			
Frequency (MHz)				2580	2595	2610	L	M	H
20	QPSK	1	0	22.95	23.00	22.88	0.0989	0.1000	0.0973
20	QPSK	1	99	22.80	22.81	22.84	0.0955	0.0957	0.0964
20	QPSK	100	0	21.92	22.02	21.76	0.0780	0.0798	0.0752
20	16QAM	1	0	22.00	22.07	22.05	0.0794	0.0807	0.0804
20	64QAM	1	0	20.69	20.75	20.64	0.0587	0.0596	0.0581
20	256QAM	1	0	18.06	17.94	17.92	0.0321	0.0312	0.0310
Channel				37825	38000	38175	EIRP(W)		
Frequency (MHz)				2577.5	2595	2612.5	L	M	H
15	QPSK	1	0	22.83	22.88	22.75	0.0962	0.0973	0.0944
15	16QAM	1	0	22.00	22.00	22.01	0.0794	0.0794	0.0796
Channel				37800	38000	38200	EIRP(W)		
Frequency (MHz)				2575	2595	2615	L	M	H
10	QPSK	1	0	22.87	22.86	22.65	0.0971	0.0968	0.0923
10	16QAM	1	0	22.01	21.98	21.97	0.0796	0.0791	0.0789
Channel				37775	38000	38225	EIRP(W)		
Frequency (MHz)				2572.5	2595	2617.5	L	M	H
5	QPSK	1	0	22.93	22.92	22.65	0.0984	0.0982	0.0923
5	16QAM	1	0	22.00	21.94	22.01	0.0794	0.0783	0.0796



LTE Band41_Ant 2:

BW [MHz]	Modulation	RB Size	RB Offset	Power Low Ch. / Freq.	Power Middle Ch. / Freq.	Power High Ch. / Freq.	EIRP(W)		
Channel				39750	40620	41490			
Frequency (MHz)				2506	2593	2680	L	M	H
20	QPSK	1	0	26.06	26.11	25.79	0.2023	0.2046	0.1901
20	QPSK	1	99	25.91	25.99	25.94	0.1954	0.1991	0.1968
20	QPSK	100	0	25.00	25.01	24.91	0.1585	0.1589	0.1552
20	16QAM	1	0	25.21	25.33	25.33	0.1663	0.1710	0.1710
20	64QAM	1	0	23.99	24.07	24.00	0.1256	0.1279	0.1259
20	256QAM	1	0	21.13	21.11	21.05	0.0650	0.0647	0.0638
Channel				39725	40620	41515	EIRP(W)		
Frequency (MHz)				2503.5	2593	2682.5	L	M	H
15	QPSK	1	0	25.95	26.02	25.72	0.1972	0.2004	0.1871
15	16QAM	1	0	25.12	25.20	25.21	0.1629	0.1660	0.1663
Channel				39700	40620	41540	EIRP(W)		
Frequency (MHz)				2501	2593	2685	L	M	H
10	QPSK	1	0	25.96	26.04	25.76	0.1977	0.2014	0.1888
10	16QAM	1	0	25.10	25.28	25.28	0.1622	0.1690	0.1690
Channel				39675	40620	41565	EIRP(W)		
Frequency (MHz)				2498.5	2593	2687.5	L	M	H
5	QPSK	1	0	25.99	25.99	25.71	0.1991	0.1991	0.1866
5	16QAM	1	0	25.09	25.28	25.28	0.1618	0.1690	0.1690



LTE CA_7C_Ant 2:

Combination 20MHz+20MHz (100RB+100RB)							
Channel	Modulation	PCC		SCC		Measured Power	EIRP(W)
		RB Size	RB offset	RB Size	RB offset		
L	QPSK	1	Max	1	0	22.86	0.0968
M	QPSK	1	Max	1	0	22.74	0.0942
H	QPSK	1	Max	1	0	22.71	0.0935
L	16QAM	1	Max	1	0	22.19	0.0830
M	16QAM	1	Max	1	0	22.09	0.0811
H	16QAM	1	Max	1	0	22.20	0.0832
L	64QAM	1	Max	1	0	21.22	0.0664
M	64QAM	1	Max	1	0	20.95	0.0624
H	64QAM	1	Max	1	0	21.00	0.0631
L	256QAM	1	Max	1	0	17.97	0.0314
M	256QAM	1	Max	1	0	17.93	0.0311
H	256QAM	1	Max	1	0	17.90	0.0309
Combination 20MHz+15MHz (100RB+75RB)							
Channel	Modulation	PCC		SCC		Measured Power	EIRP(W)
		RB Size	RB offset	RB Size	RB offset		
L	QPSK	1	Max	1	0	22.95	0.0989
H	16QAM	1	Max	1	0	22.23	0.0838
Combination 15MHz+20MHz (75RB+100RB)							
Channel	Modulation	PCC		SCC		Measured Power	EIRP(W)
		RB Size	RB offset	RB Size	RB offset		
L	QPSK	1	Max	1	0	22.88	0.0973
H	16QAM	1	Max	1	0	22.26	0.0843
Combination 15MHz+15MHz (75RB+75RB)							
Channel	Modulation	PCC		SCC		Measured Power	EIRP(W)
		RB Size	RB offset	RB Size	RB offset		
L	QPSK	1	Max	1	0	22.89	0.0975
H	16QAM	1	Max	1	0	22.23	0.0838
Combination 20MHz+10MHz (100RB+50RB)							
Channel	Modulation	PCC		SCC		Measured Power	EIRP(W)
		RB Size	RB offset	RB Size	RB offset		
L	QPSK	1	Max	1	0	22.86	0.0968
H	16QAM	1	Max	1	0	22.22	0.0836
Combination 10MHz+20MHz (50RB+100RB)							
Channel	Modulation	PCC		SCC		Measured Power	EIRP(W)
		RB Size	RB offset	RB Size	RB offset		
L	QPSK	1	Max	1	0	22.89	0.0975
H	16QAM	1	Max	1	0	22.23	0.0838
Combination 15MHz+10MHz (75RB+50RB)							
Channel	Modulation	PCC		SCC		Measured Power	EIRP(W)
		RB Size	RB offset	RB Size	RB offset		
L	QPSK	1	Max	1	0	22.97	0.0993
H	16QAM	1	Max	1	0	22.28	0.0847



LTE CA_38C_Ant 2:

Combination 20MHz+20MHz (100RB+100RB)							
Channel	Modulation	PCC		SCC		Measured Power	EIRP(W)
		RB Size	RB offset	RB Size	RB offset		
L	QPSK	1	Max	1	0	22.95	0.0989
M	QPSK	1	Max	1	0	22.75	0.0944
H	QPSK	1	Max	1	0	22.80	0.0955
L	16QAM	1	Max	1	0	22.00	0.0794
M	16QAM	1	Max	1	0	22.16	0.0824
H	16QAM	1	Max	1	0	22.20	0.0832
L	64QAM	1	Max	1	0	20.69	0.0587
M	64QAM	1	Max	1	0	20.73	0.0593
H	64QAM	1	Max	1	0	20.86	0.0611
L	256QAM	1	Max	1	0	18.06	0.0321
M	256QAM	1	Max	1	0	18.07	0.0321
H	256QAM	1	Max	1	0	17.84	0.0305
Combination 15MHz+15MHz (75RB+75RB)							
Channel	Modulation	PCC		SCC		Measured Power	EIRP(W)
		RB Size	RB offset	RB Size	RB offset		
L	QPSK	1	Max	1	0	22.90	0.0977
H	16QAM	1	Max	1	0	22.11	0.0815



LTE CA_41C_Ant 2:

Combination 20MHz+20MHz (100RB+100RB)							
Channel	Modulation	PCC		SCC		Measured Power	EIRP(W)
		RB Size	RB offset	RB Size	RB offset		
L	QPSK	1	Max	1	0	22.96	0.0991
M	QPSK	1	Max	1	0	22.68	0.0929
H	QPSK	1	Max	1	0	22.68	0.0929
L	16QAM	1	Max	1	0	21.98	0.0791
M	16QAM	1	Max	1	0	21.85	0.0767
H	16QAM	1	Max	1	0	21.78	0.0755
L	64QAM	1	Max	1	0	20.60	0.0575
M	64QAM	1	Max	1	0	20.76	0.0597
H	64QAM	1	Max	1	0	20.59	0.0574
L	256QAM	1	Max	1	0	17.81	0.0303
M	256QAM	1	Max	1	0	17.71	0.0296
H	256QAM	1	Max	1	0	17.72	0.0296
Combination 20MHz+15MHz (100RB+75RB)							
Channel	Modulation	PCC		SCC		Measured Power	EIRP(W)
		RB Size	RB offset	RB Size	RB offset		
L	QPSK	1	Max	1	0	22.95	0.0989
L	16QAM	1	Max	1	0	21.98	0.0791
Combination 15MHz+20MHz (75RB+100RB)							
Channel	Modulation	PCC		SCC		Measured Power	EIRP(W)
		RB Size	RB offset	RB Size	RB offset		
L	QPSK	1	Max	1	0	22.83	0.0962
L	16QAM	1	Max	1	0	21.91	0.0778
Combination 15MHz+15MHz (75RB+75RB)							
Channel	Modulation	PCC		SCC		Measured Power	EIRP(W)
		RB Size	RB offset	RB Size	RB offset		
L	QPSK	1	Max	1	0	22.94	0.0986
L	16QAM	1	Max	1	0	21.86	0.0769
Combination 20MHz+10MHz (100RB+50RB)							
Channel	Modulation	PCC		SCC		Measured Power	EIRP(W)
		RB Size	RB offset	RB Size	RB offset		
L	QPSK	1	Max	1	0	22.95	0.0989
L	16QAM	1	Max	1	0	21.83	0.0764
Combination 10MHz+20MHz (50RB+100RB)							
Channel	Modulation	PCC		SCC		Measured Power	EIRP(W)
		RB Size	RB offset	RB Size	RB offset		
L	QPSK	1	Max	1	0	22.77	0.0948
L	16QAM	1	Max	1	0	22.00	0.0794
Combination 15MHz+10MHz (75RB+50RB)							
Channel	Modulation	PCC		SCC		Measured Power	EIRP(W)
		RB Size	RB offset	RB Size	RB offset		
L	QPSK	1	Max	1	0	22.92	0.0982



L	16QAM	1	Max	1	0	21.94	0.0783
Combination 10MHz+15MHz (50RB+75RB)							
Channel	Modulation	PCC		SCC		Measured Power	EIRP(W)
		RB Size	RB offset	RB Size	RB offset		
L	QPSK	1	Max	1	0	22.89	0.0975
L	16QAM	1	Max	1	0	21.97	0.0789
Combination 20MHz+5MHz (100RB+25RB)							
Channel	Modulation	PCC		SCC		Measured Power	EIRP(W)
		RB Size	RB offset	RB Size	RB offset		
L	QPSK	1	Max	1	0	22.78	0.0951
L	16QAM	1	Max	1	0	21.97	0.0789
Combination 5MHz+20MHz (25RB+100RB)							
Channel	Modulation	PCC		SCC		Measured Power	EIRP(W)
		RB Size	RB offset	RB Size	RB offset		
L	QPSK	1	Max	1	0	22.83	0.0962
L	16QAM	1	Max	1	0	21.96	0.0787



LTE Band 7

Peak-to-Average Ratio

Mode	LTE Band 7 / 20MHz				
Mod.	QPSK	16QAM	64QAM	256QAM	Limit: 13dB
RB Size	Full RB	Full RB	Full RB	Full RB	Result
Middle CH	4.93	5.86	6.26	6.55	PASS

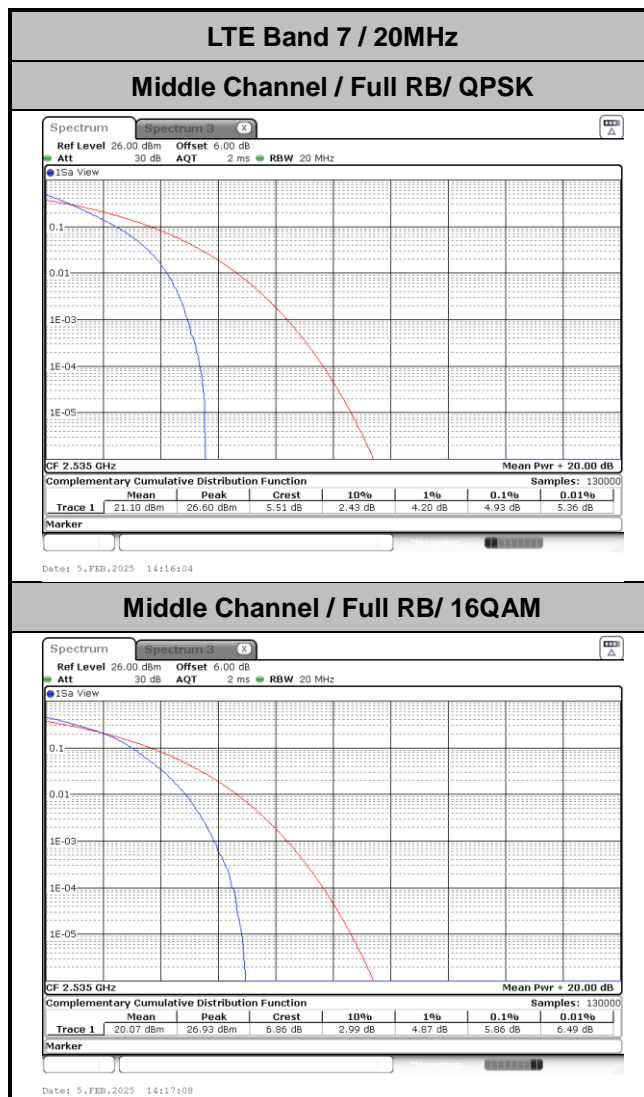

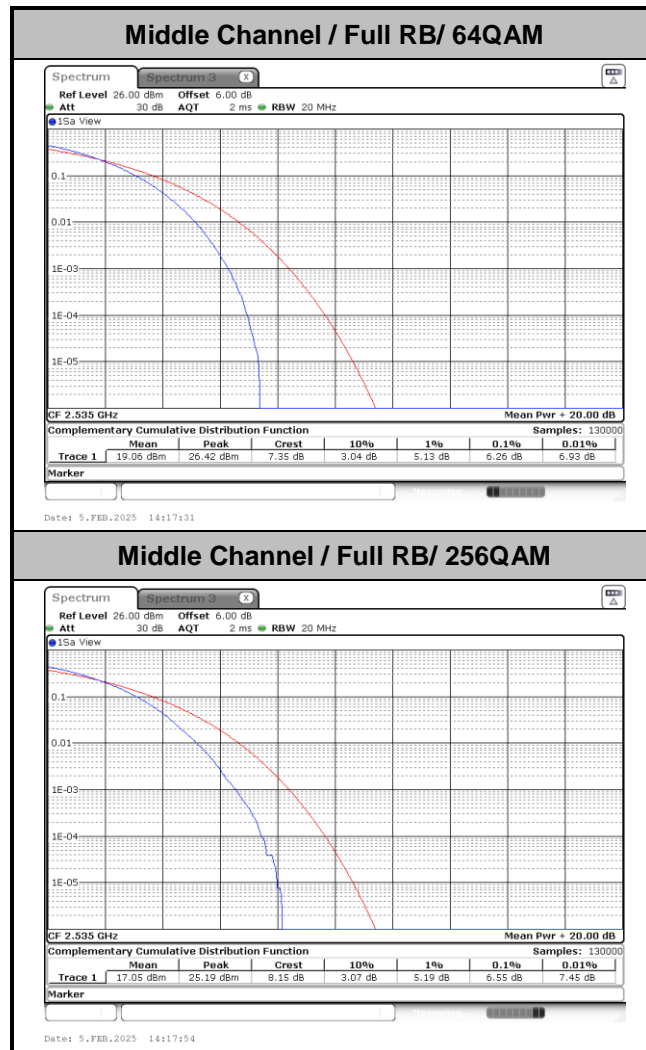



26dB Bandwidth

Mode	LTE Band 7 : 26dB BW(MHz)							
BW	5MHz		10MHz		15MHz		20MHz	
Mod.	QPSK	16QAM	QPSK	16QAM	QPSK	16QAM	QPSK	16QAM
Middle CH	4.92	4.87	9.89	9.79	14.39	14.15	18.78	19.10

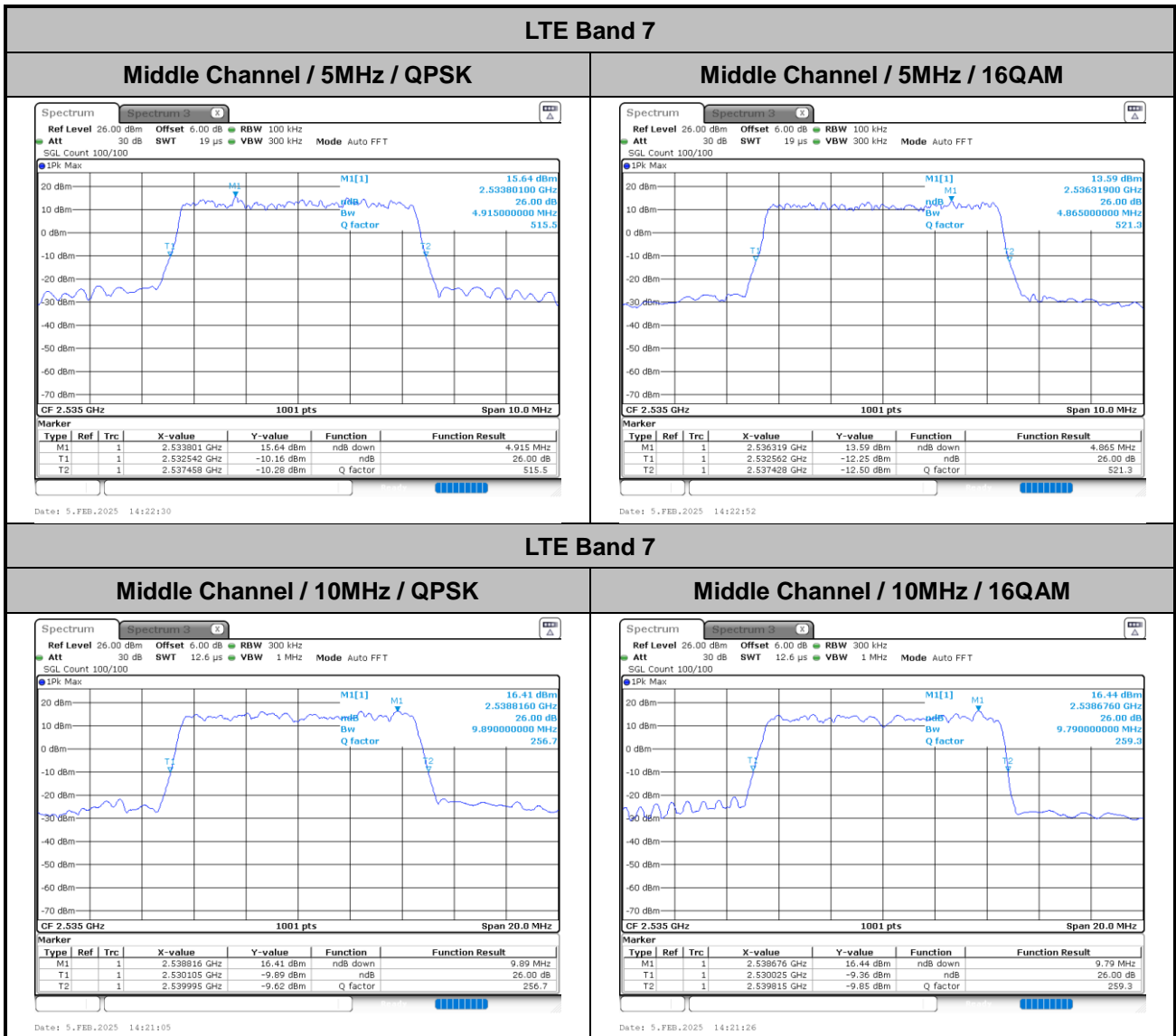



LTE Band 7

Middle Channel / 15MHz / QPSK

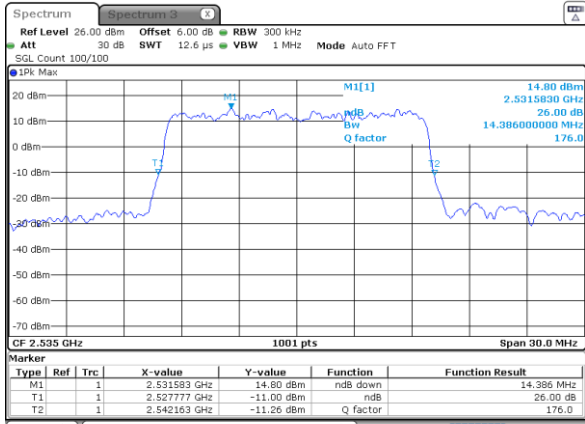

Middle Channel / 15MHz / 16QAM

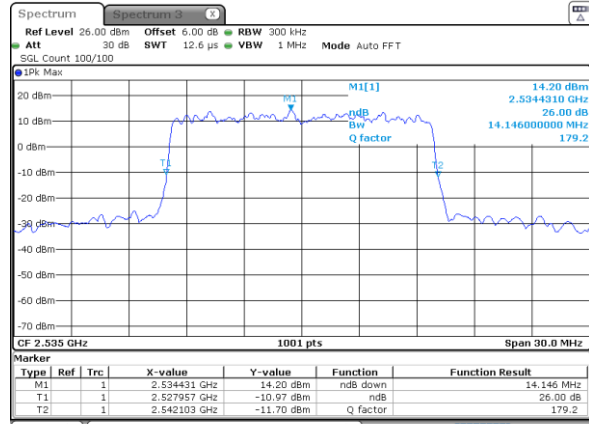

LTE Band 7

Middle Channel / 20MHz / QPSK

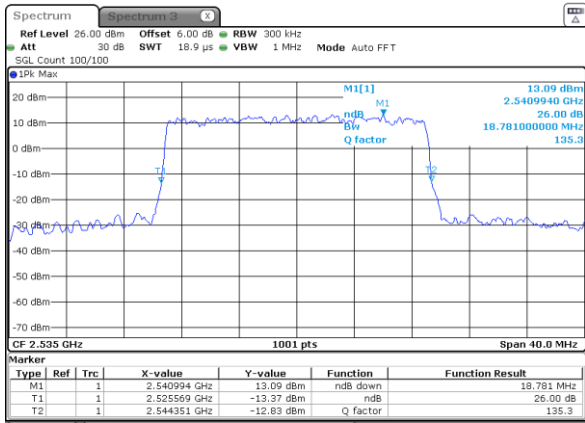

Middle Channel / 20MHz / 16QAM

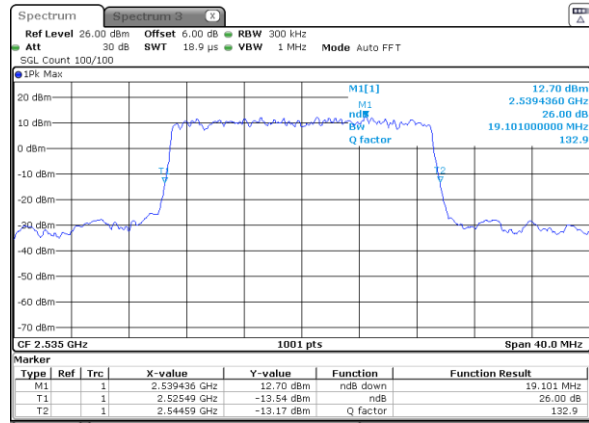



Occupied Bandwidth

Mode	LTE Band 7 : 99%OBW(MHz)							
BW	5MHz		10MHz		15MHz		20MHz	
Mod.	QPSK	16QAM	QPSK	16QAM	QPSK	16QAM	QPSK	16QAM
Middle CH	4.49	4.47	9.07	8.97	13.49	13.43	17.82	17.78

LTE Band 7

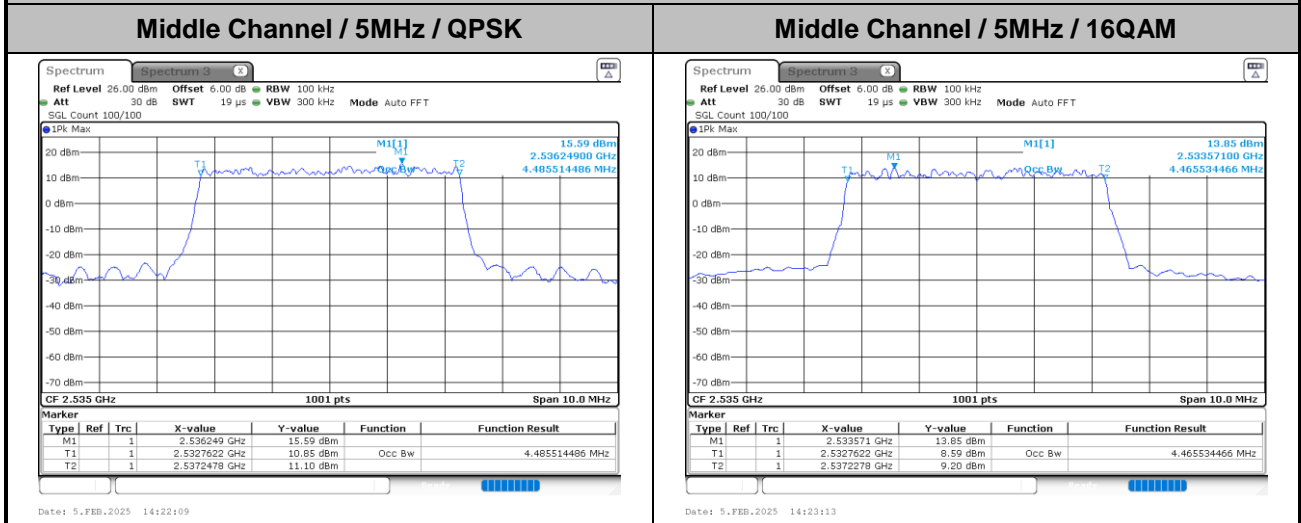

LTE Band 7

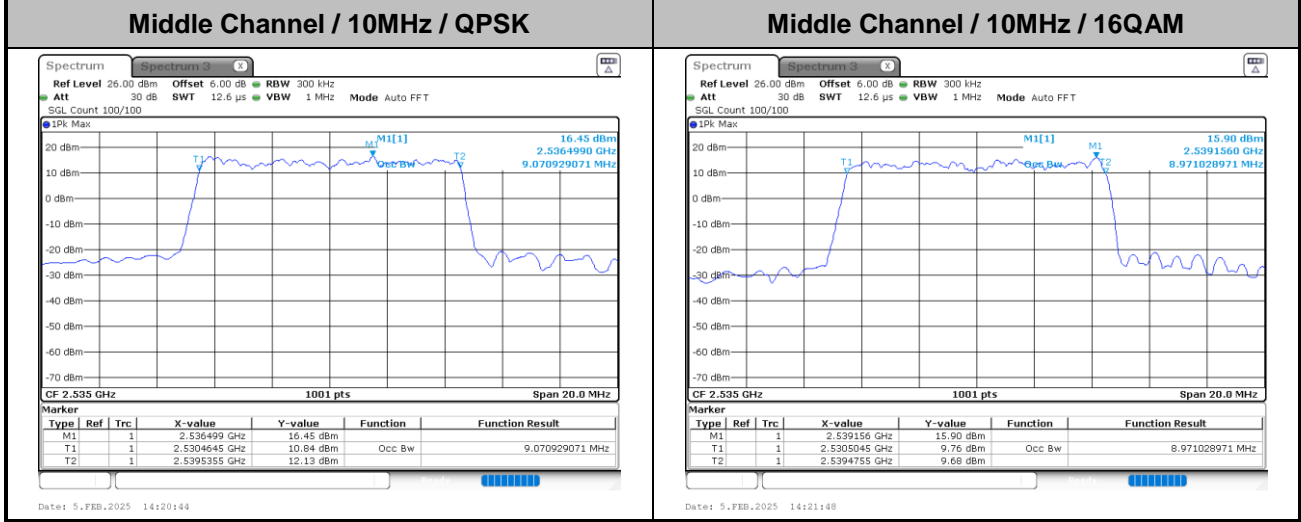



LTE Band 7

Middle Channel / 15MHz / QPSK

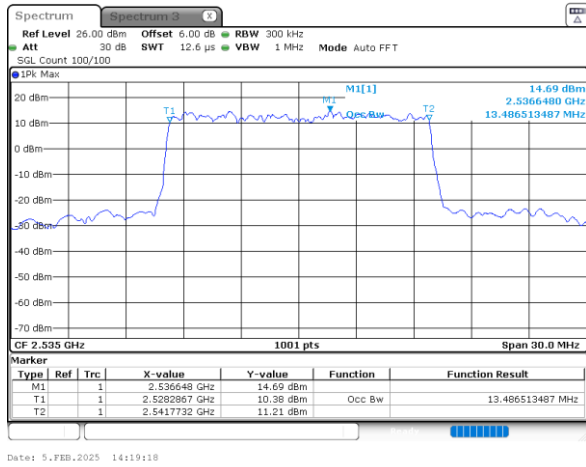

Date: 5.FEB.2025 14:19:18

Middle Channel / 15MHz / 16QAM

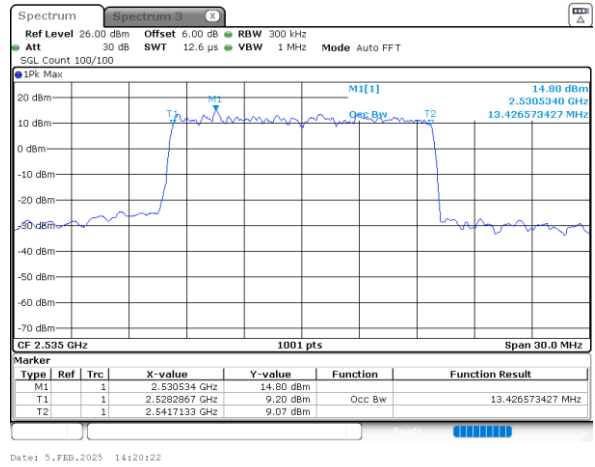

Date: 5.FEB.2025 14:20:22

LTE Band 7

Middle Channel / 20MHz / QPSK

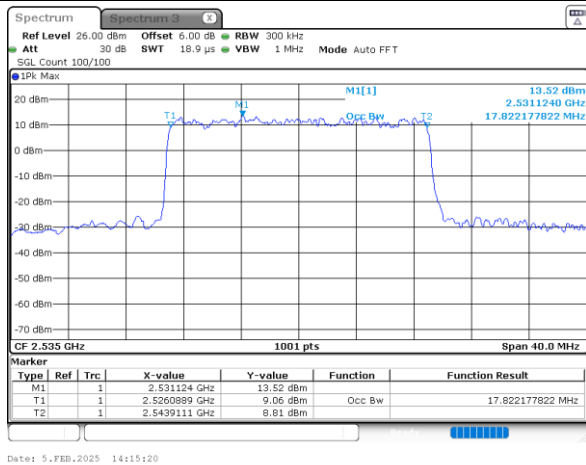

Date: 5.FEB.2025 14:15:20

Middle Channel / 20MHz / 16QAM

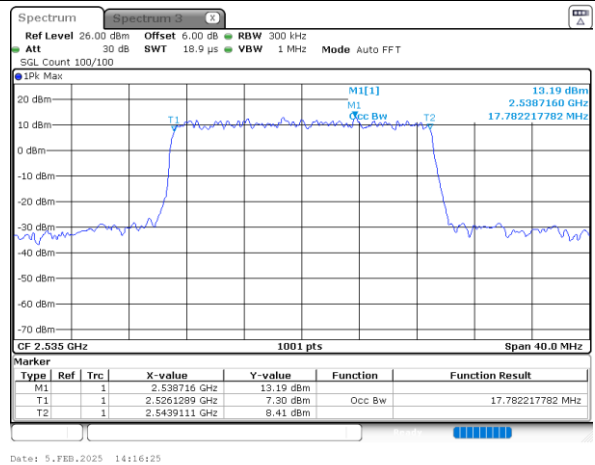

Date: 5.FEB.2025 14:16:25



Conducted Band Edge

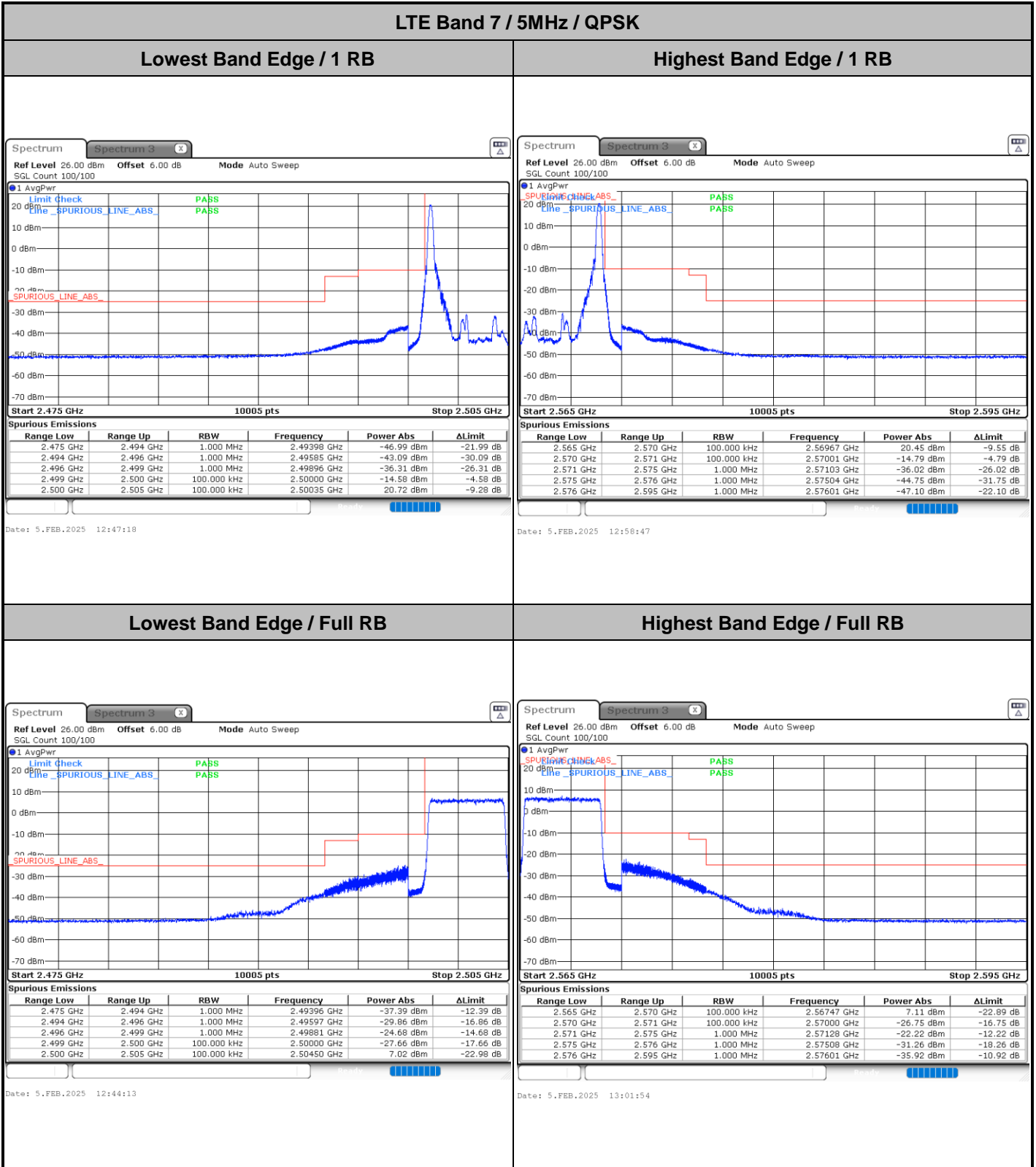



LTE Band 7 / 5MHz / 16QAM

Lowest Band Edge / 1RB

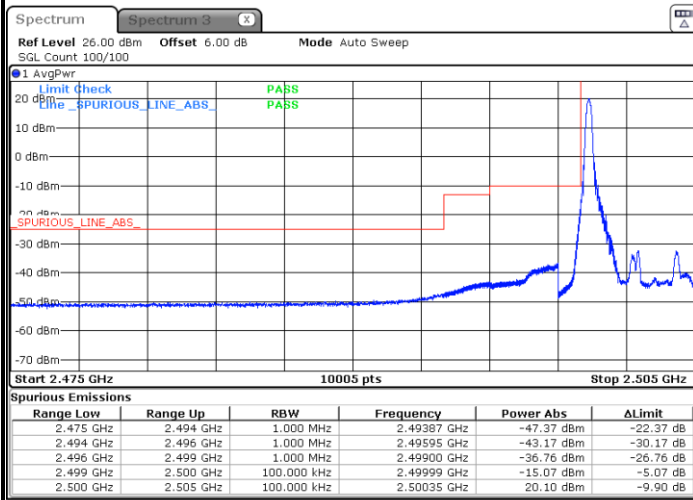

Date: 5.FEB.2025 12:48:07

Highest Band Edge / 1 RB

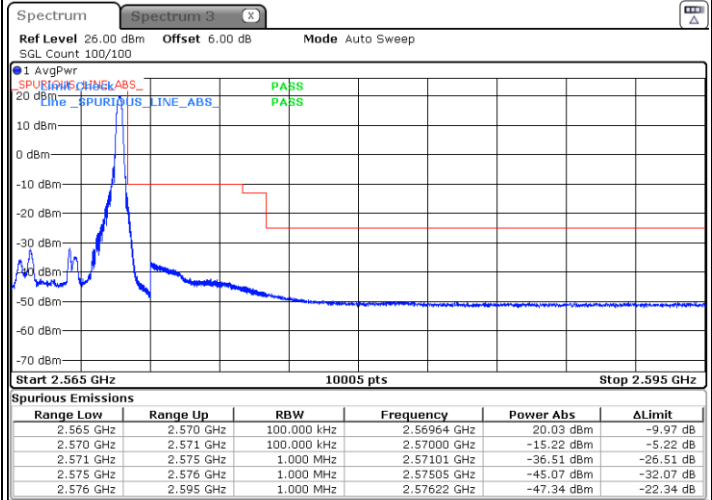

Date: 5.FEB.2025 12:59:36

Lowest Band Edge / Full RB

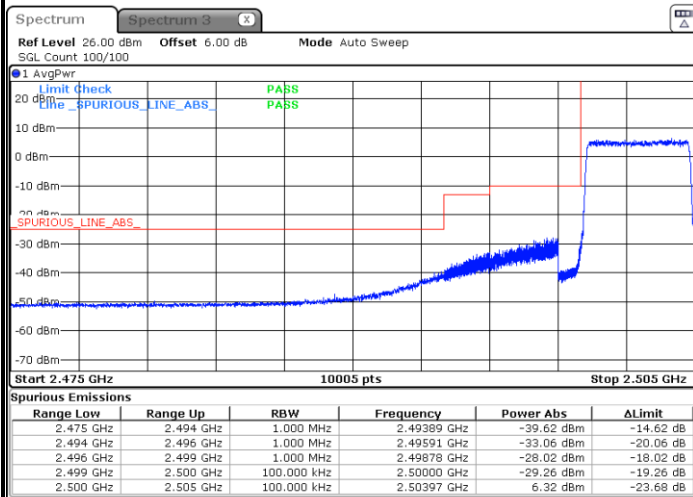

Date: 5.FEB.2025 12:44:59

Highest Band Edge / Full RB

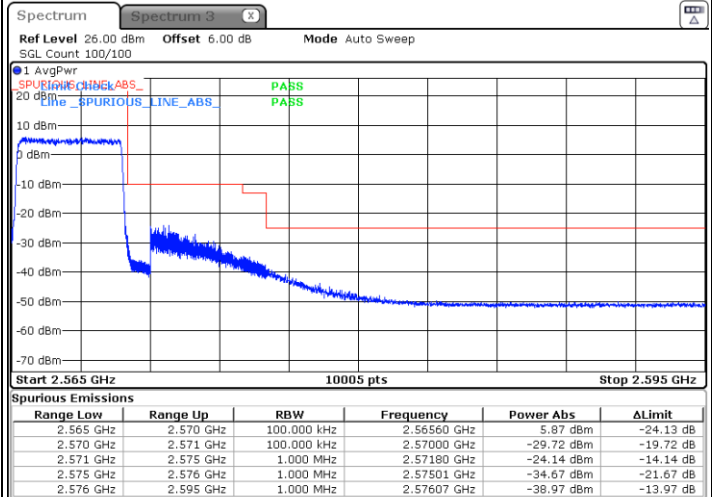

Date: 5.FEB.2025 13:02:39



LTE Band 7 / 5MHz / 64QAM

Lowest Band Edge / 1RB

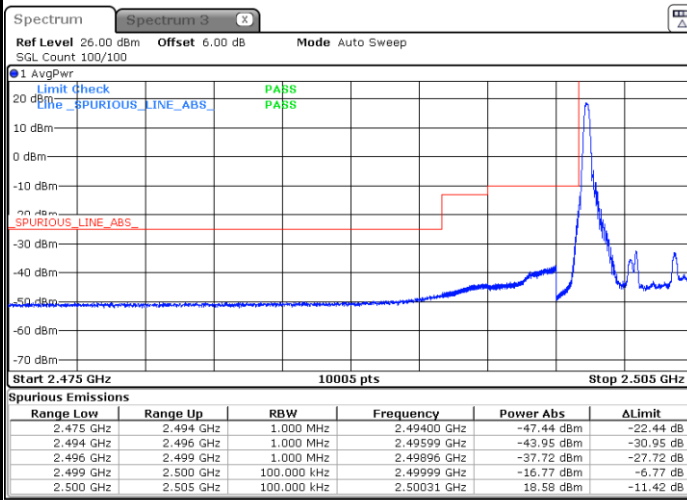

Date: 5.FEB.2025 12:48:53

Highest Band Edge / 1 RB

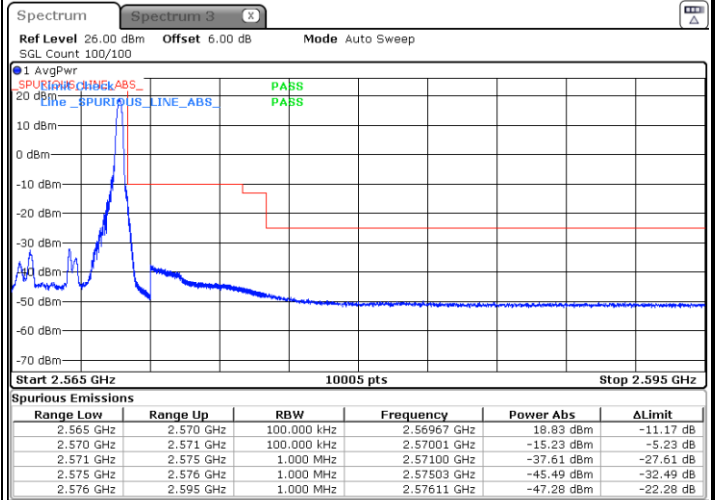

Date: 5.FEB.2025 13:00:21

Lowest Band Edge / Full RB

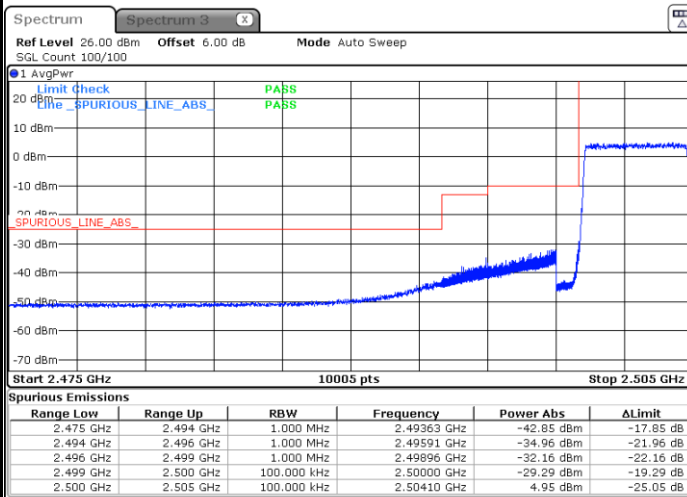

Date: 5.FEB.2025 12:45:45

Highest Band Edge / Full RB

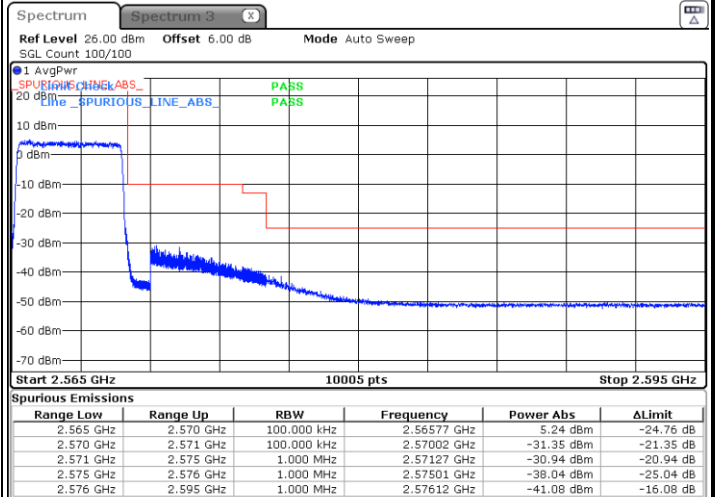

Date: 5.FEB.2025 13:03:25



LTE Band 7 / 5MHz / 256QAM

Lowest Band Edge / 1RB

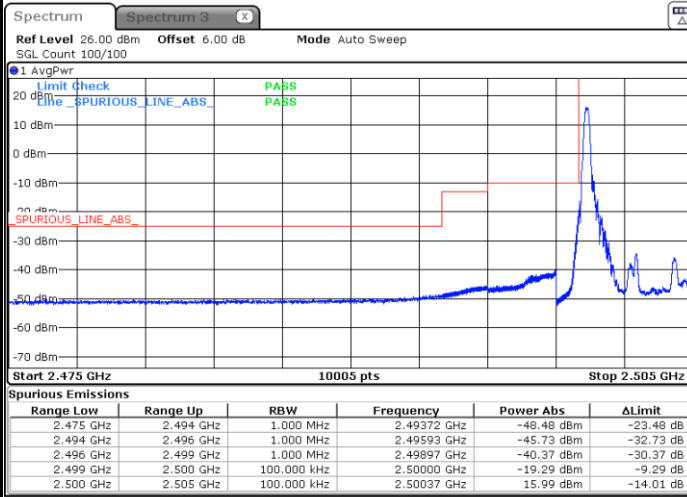

Date: 5.FEB.2025 12:49:39

Highest Band Edge / 1 RB

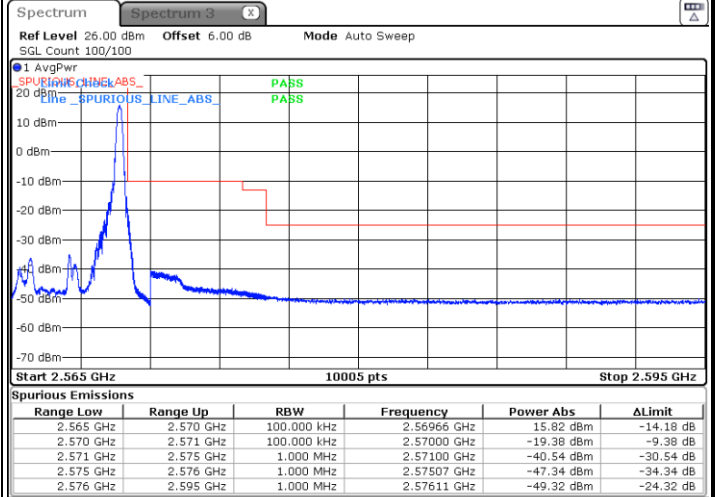

Date: 5.FEB.2025 13:01:07

Lowest Band Edge / Full RB

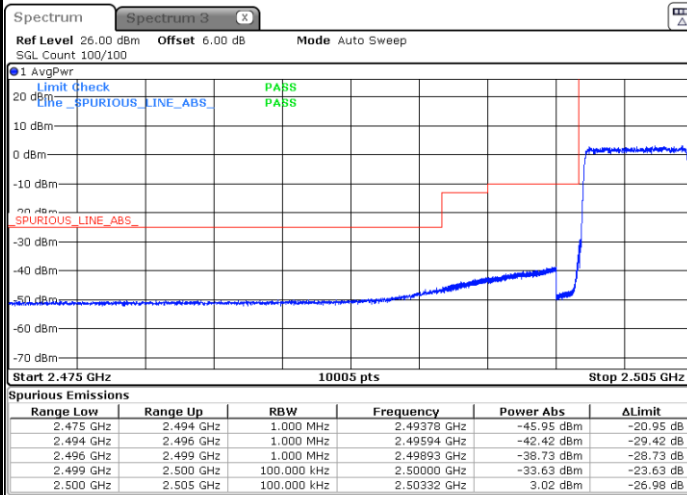

Date: 5.FEB.2025 12:46:32

Highest Band Edge / Full RB

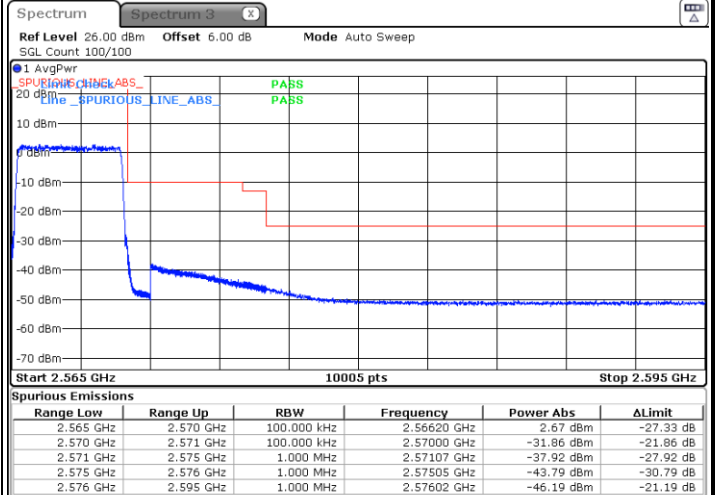

Date: 5.FEB.2025 13:04:11



LTE Band 7 / 10MHz / QPSK

Lowest Band Edge / 1 RB

Highest Band Edge / 1 RB

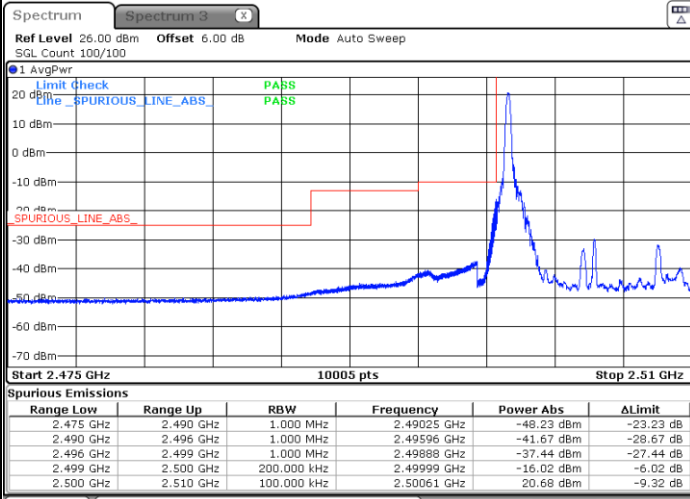

Date: 5.FEB.2025 13:08:42

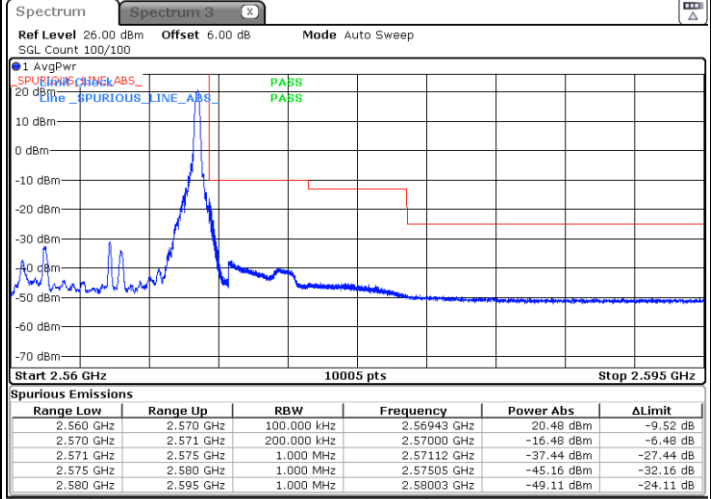

Date: 5.FEB.2025 13:21:07

Lowest Band Edge / Full RB

Highest Band Edge / Full RB

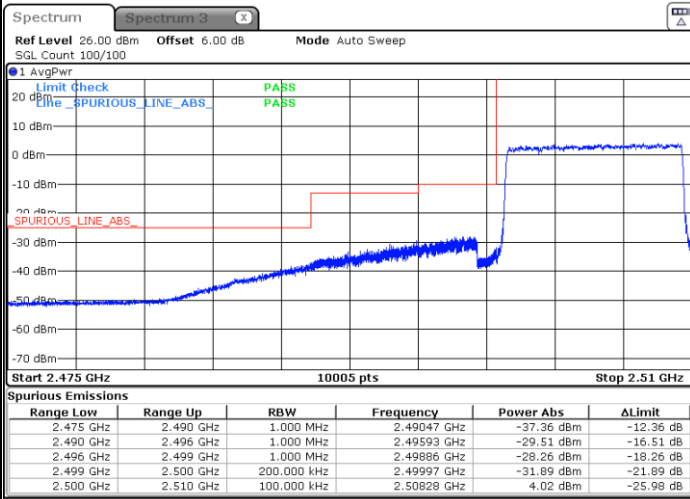

Date: 5.FEB.2025 13:05:39

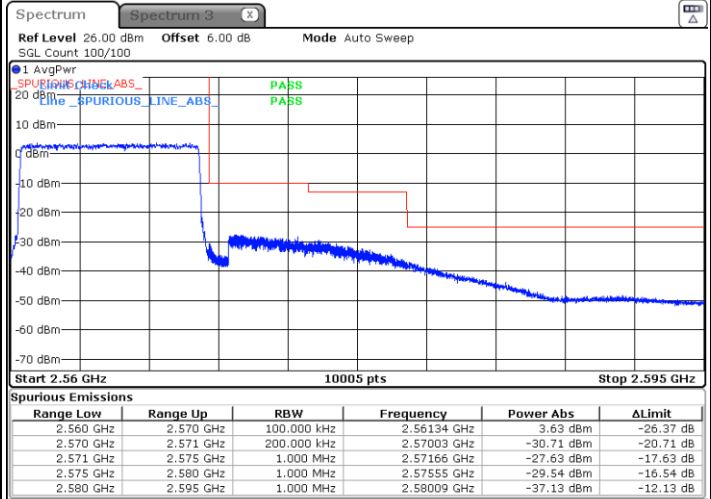

Date: 5.FEB.2025 13:24:14



LTE Band 7 / 10MHz / 16QAM

Lowest Band Edge / 1 RB

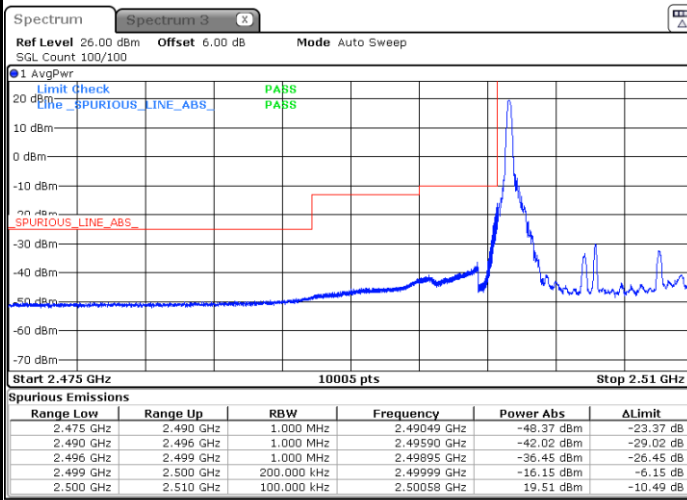

Date: 5.FEB.2025 13:09:31

Highest Band Edge / 1 RB

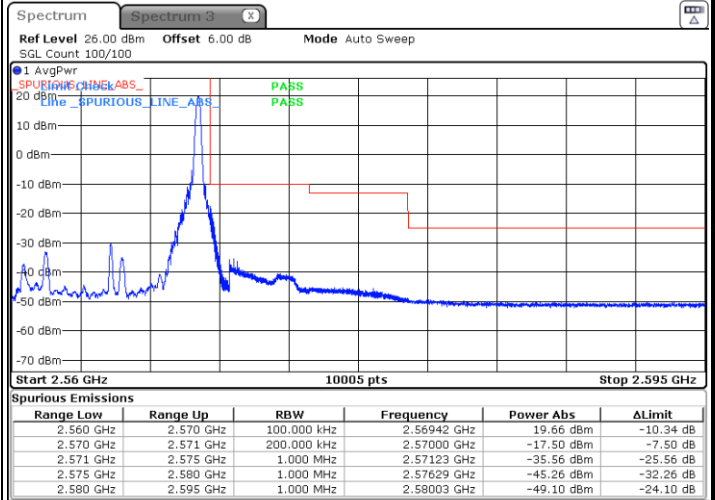

Date: 5.FEB.2025 13:21:56

Lowest Band Edge / Full RB

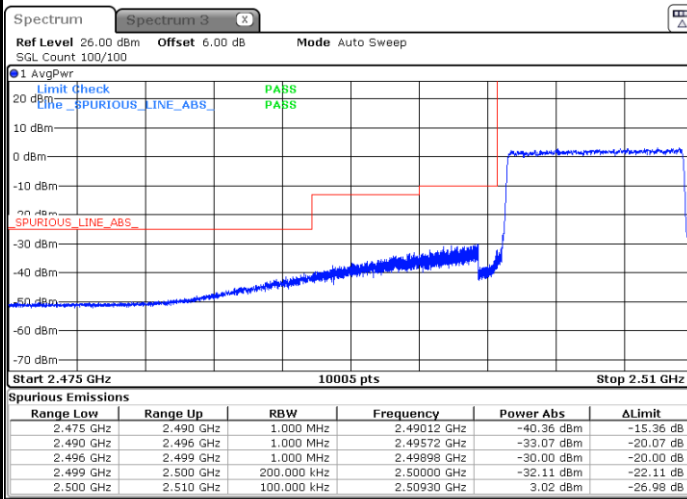

Date: 5.FEB.2025 13:06:25

Highest Band Edge / Full RB

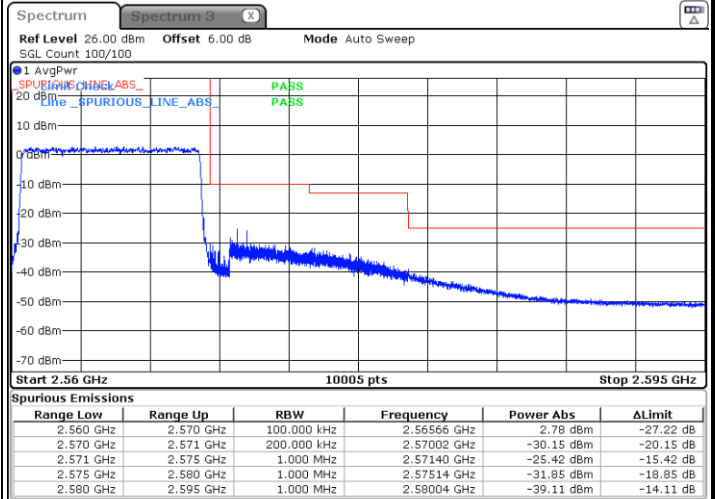

Date: 5.FEB.2025 13:24:59



LTE Band 7 / 10MHz / 64QAM

Lowest Band Edge / 1 RB

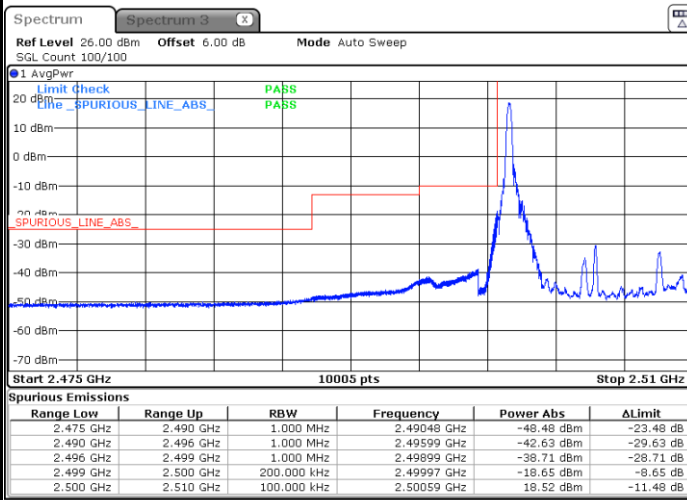

Date: 5.FEB.2025 13:10:17

Highest Band Edge / 1 RB

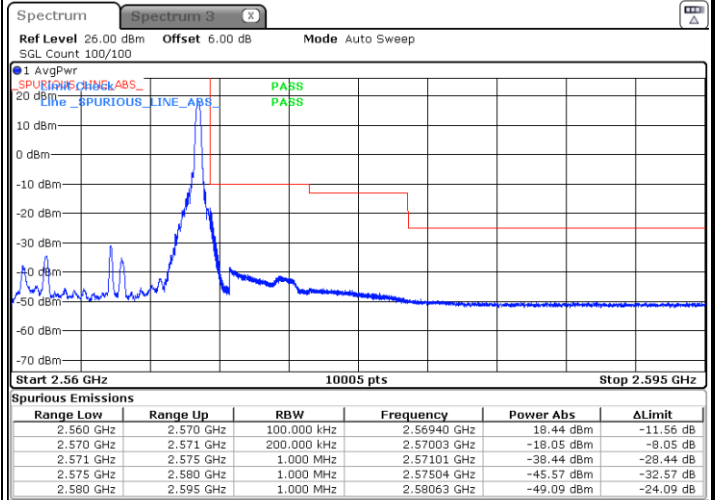

Date: 5.FEB.2025 13:22:42

Lowest Band Edge / Full RB

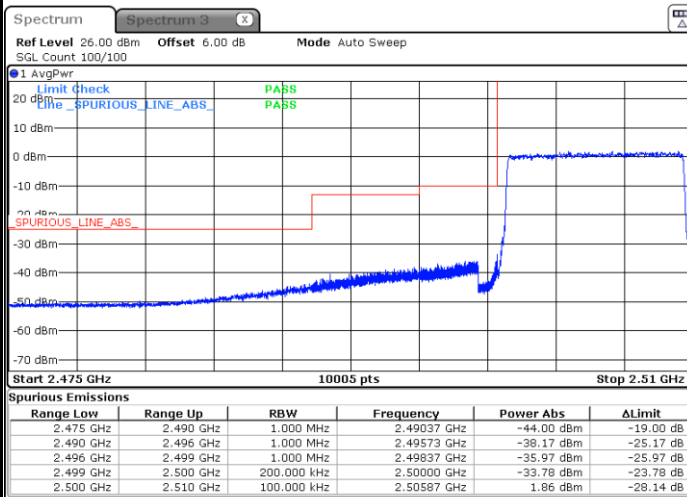

Date: 5.FEB.2025 13:07:11

Highest Band Edge / Full RB

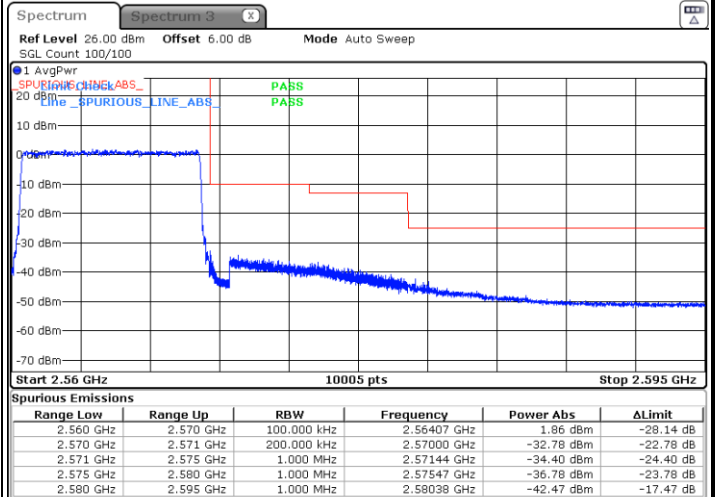

Date: 5.FEB.2025 13:25:45



LTE Band 7 / 10MHz / 256QAM

Lowest Band Edge / 1 RB

Highest Band Edge / 1 RB

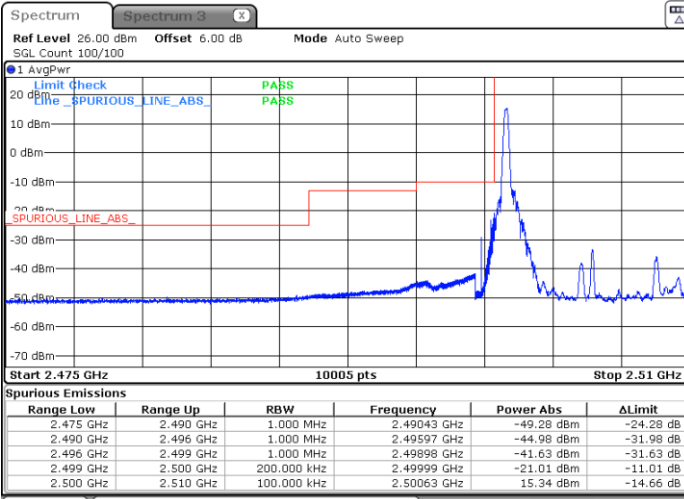

Date: 5.FEB.2025 13:11:03

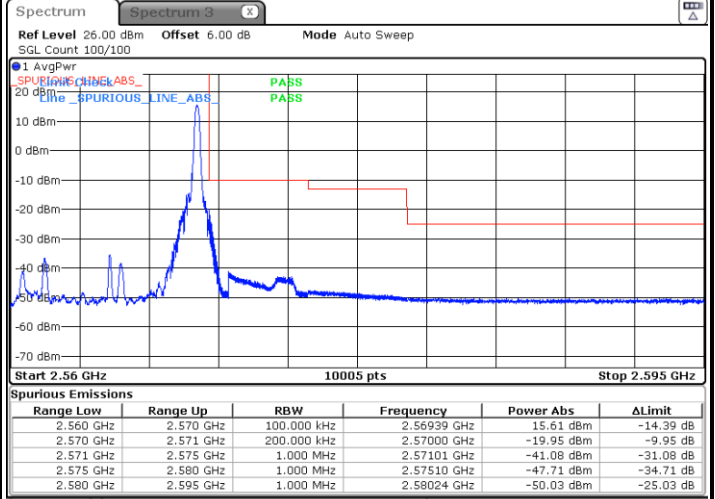

Date: 5.FEB.2025 13:23:28

Lowest Band Edge / Full RB

Highest Band Edge / Full RB

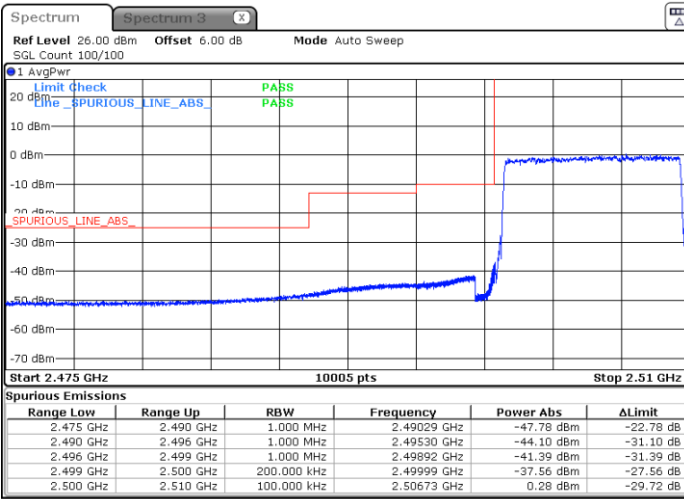

Date: 5.FEB.2025 13:07:57

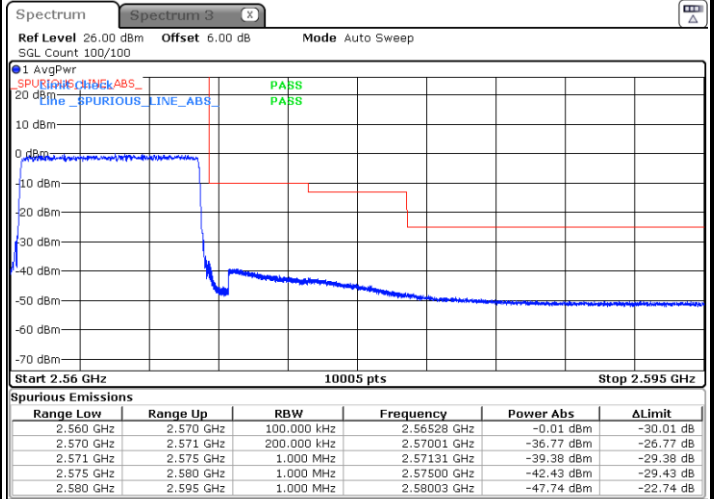

Date: 5.FEB.2025 13:26:31



LTE Band 7 / 15MHz / QPSK

Lowest Band Edge / 1 RB

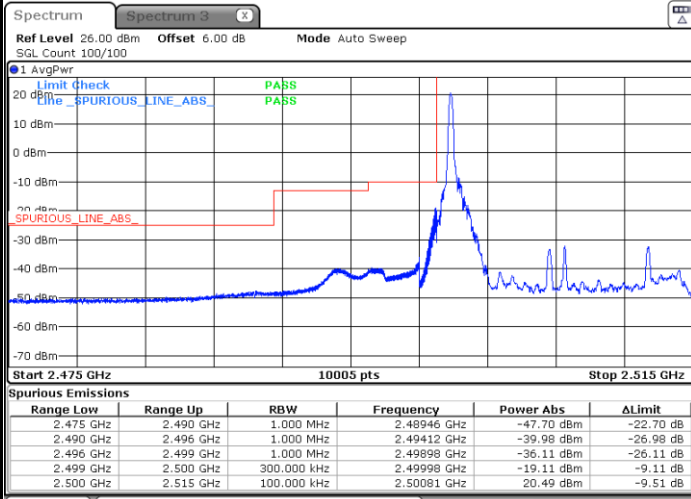

Date: 5.FEB.2025 13:34:46

Highest Band Edge / 1 RB

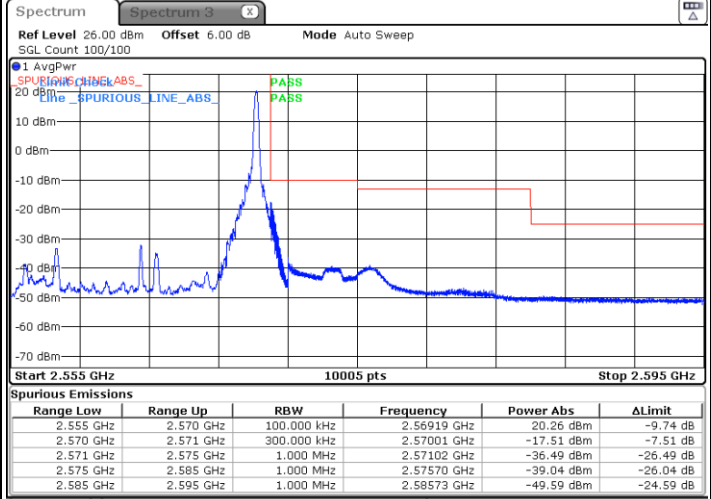

Date: 5.FEB.2025 13:47:47

Lowest Band Edge / Full RB

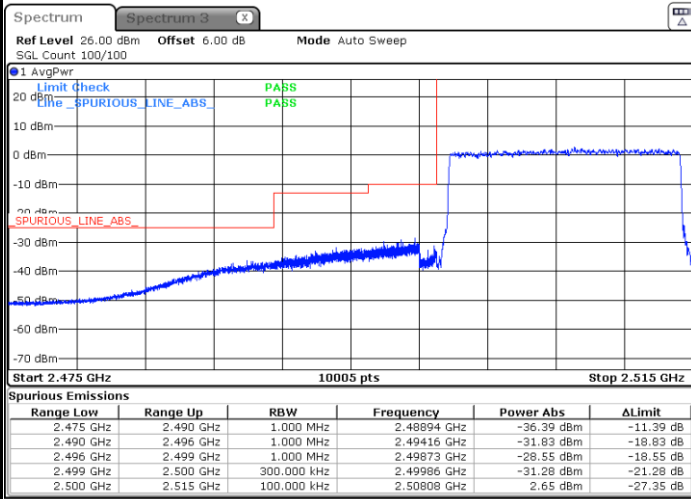

Date: 5.FEB.2025 13:31:41

Highest Band Edge / Full RB

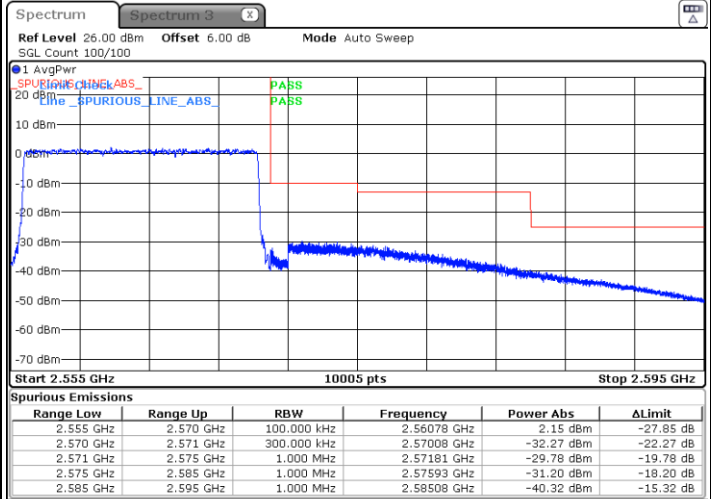

Date: 5.FEB.2025 13:51:33



LTE Band 7 / 15MHz / 16QAM

Lowest Band Edge / 1 RB

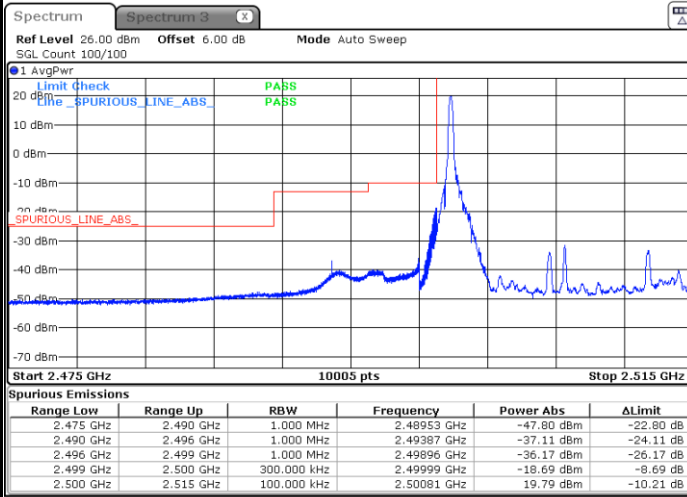

Highest Band Edge / 1 RB

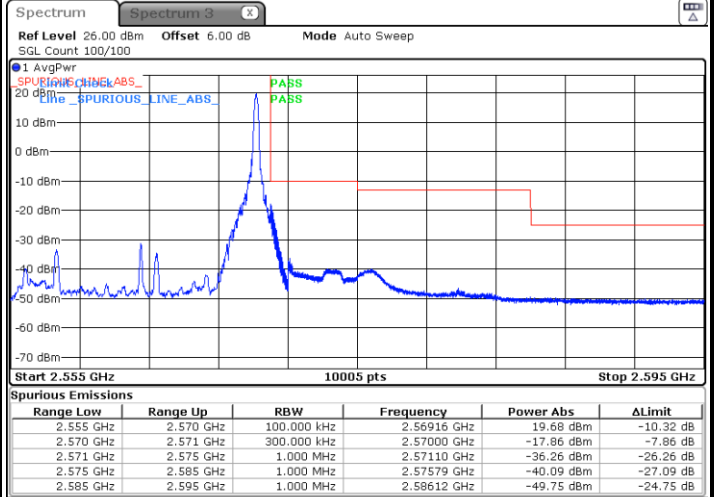

Lowest Band Edge / Full RB

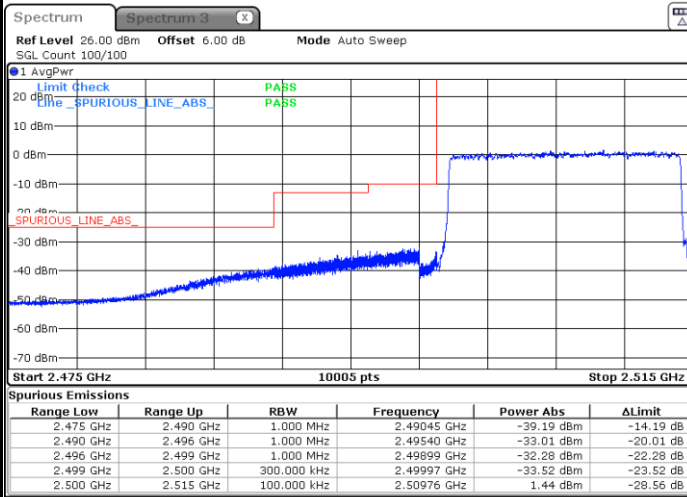

Highest Band Edge / Full RB

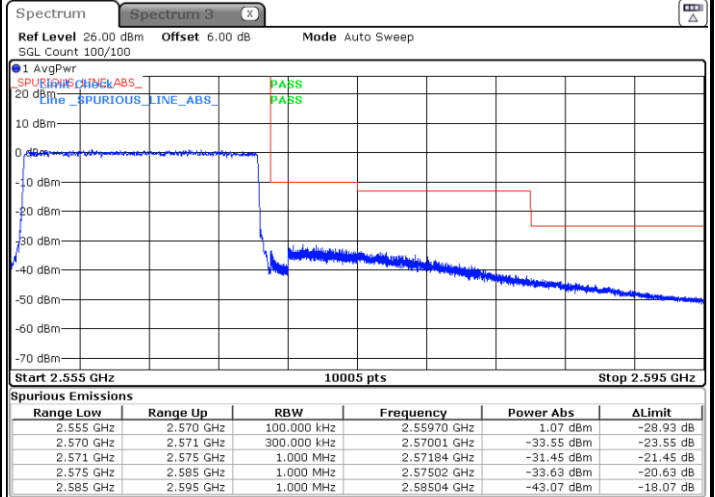



LTE Band 7 / 15MHz / 64QAM

Lowest Band Edge / 1 RB

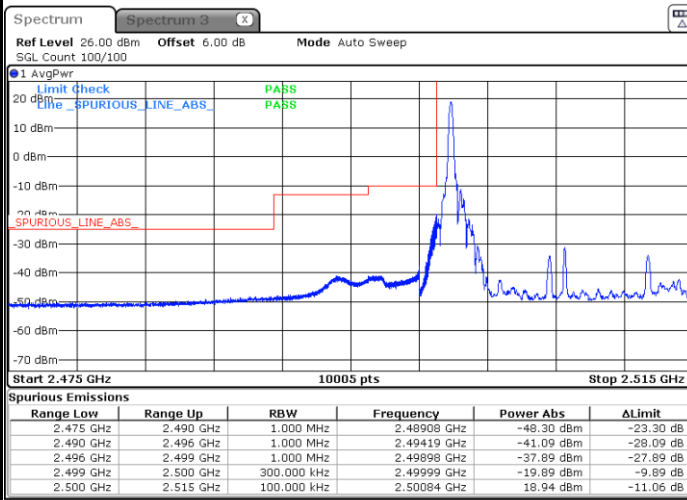

Date: 5.FEB.2025 13:36:21

Highest Band Edge / 1 RB

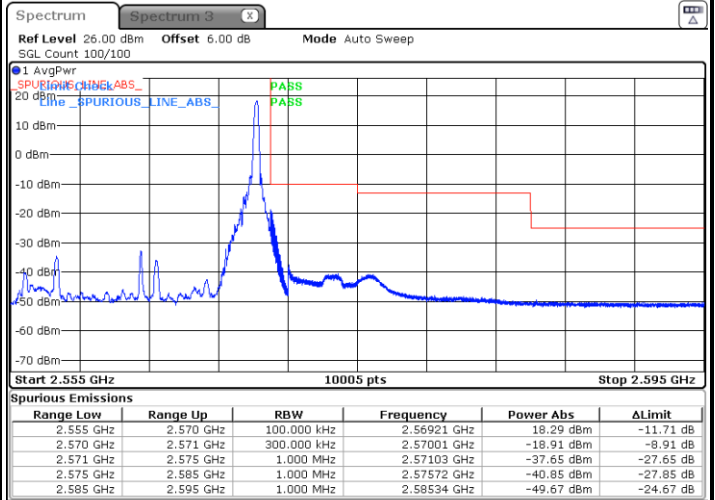

Date: 5.FEB.2025 13:49:21

Lowest Band Edge / Full RB

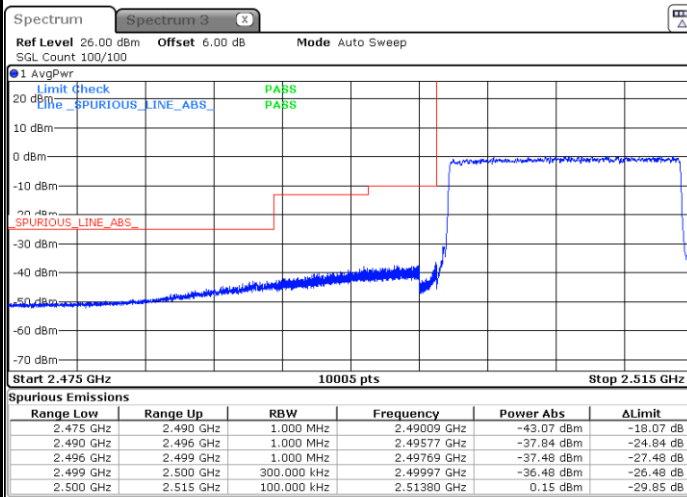

Date: 5.FEB.2025 13:33:13

Highest Band Edge / Full RB

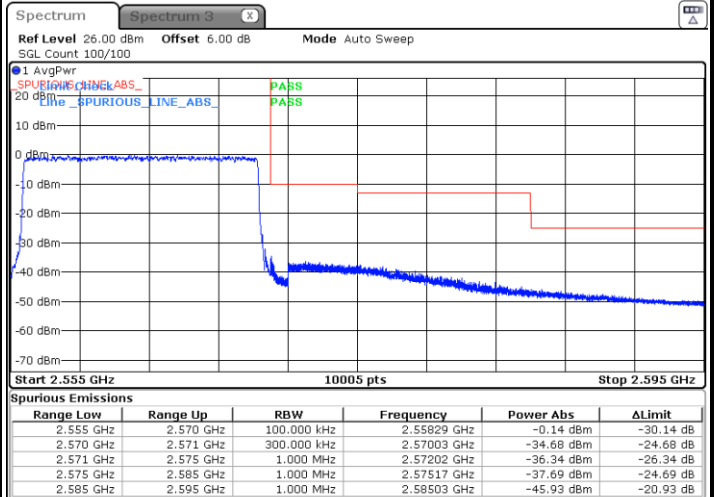

Date: 5.FEB.2025 13:53:05



LTE Band 7 / 15MHz / 256QAM

Lowest Band Edge / 1 RB

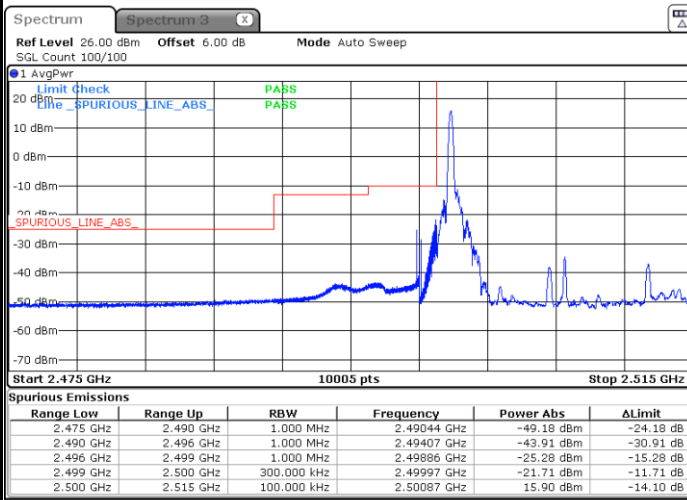

Highest Band Edge / 1 RB

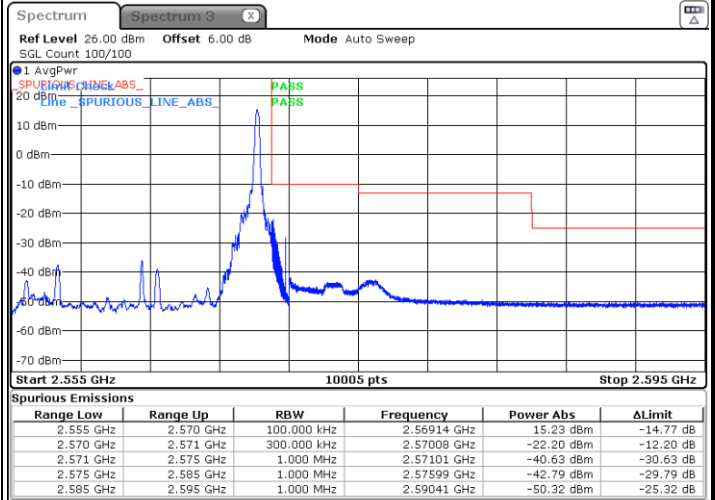

Lowest Band Edge / Full RB

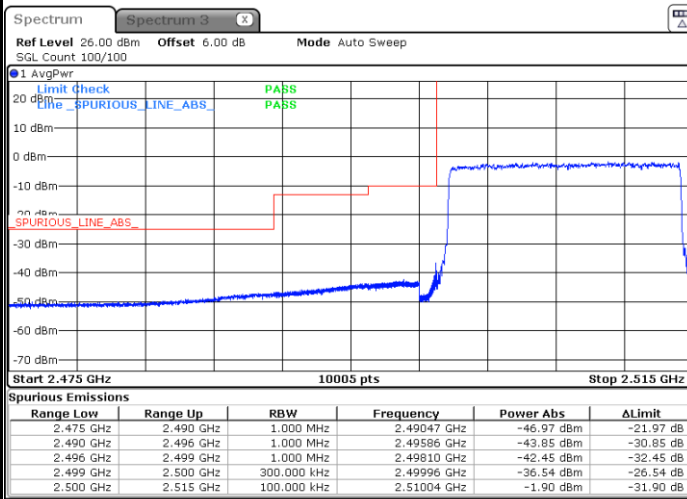

Highest Band Edge / Full RB

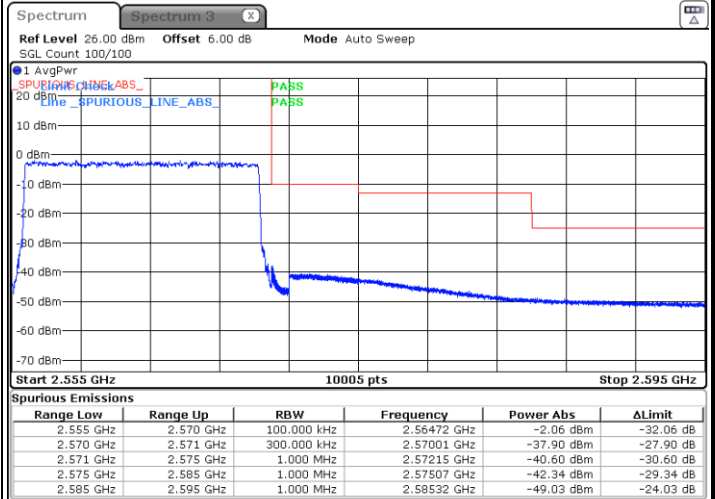



LTE Band 7 / 20MHz / QPSK

Lowest Band Edge / 1 RB

Highest Band Edge / 1 RB

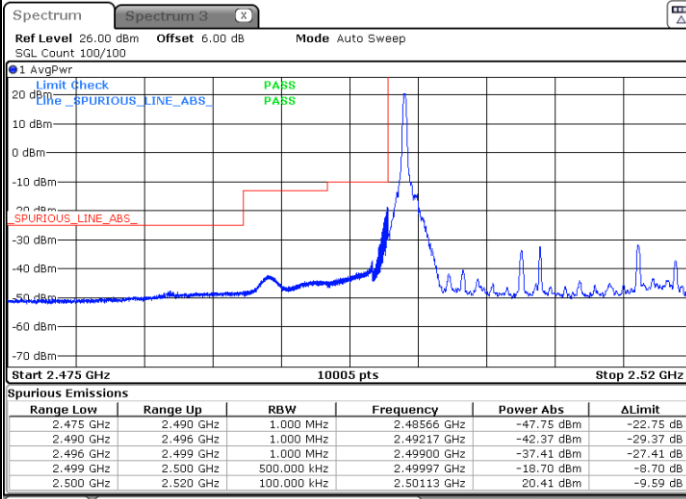

Date: 5.FEB.2025 13:58:42

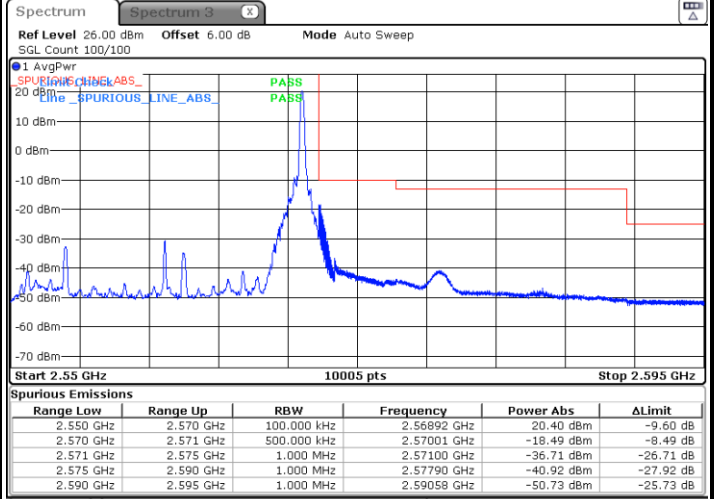

Date: 5.FEB.2025 14:09:19

Lowest Band Edge / Full RB

Highest Band Edge / Full RB

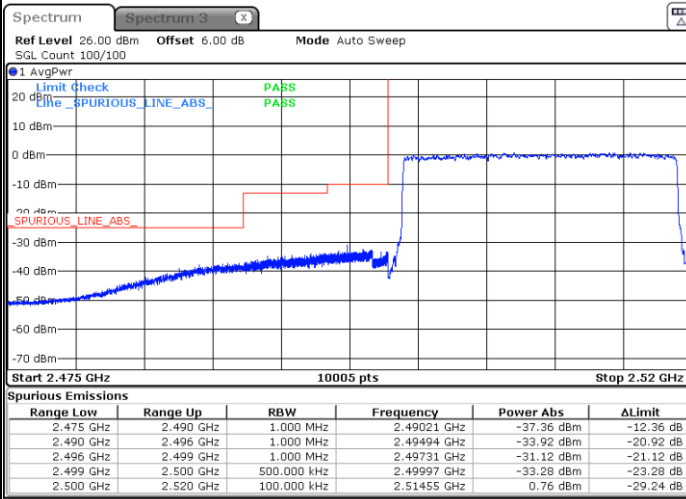

Date: 5.FEB.2025 13:55:37

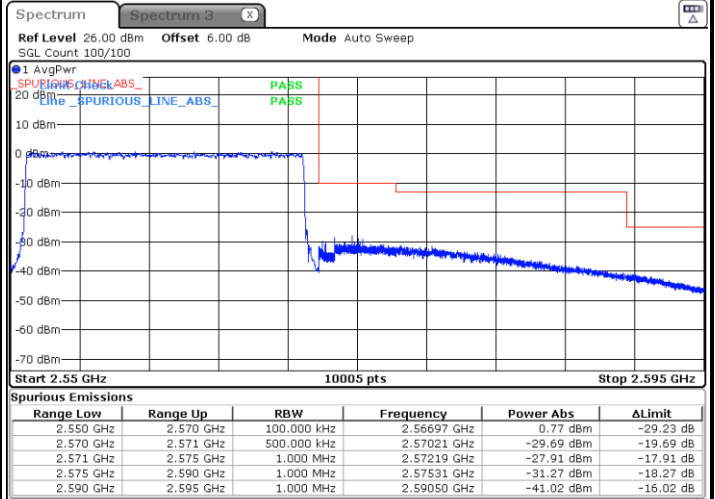

Date: 5.FEB.2025 14:12:25



LTE Band 7 / 20MHz / 16QAM

Lowest Band Edge / 1 RB

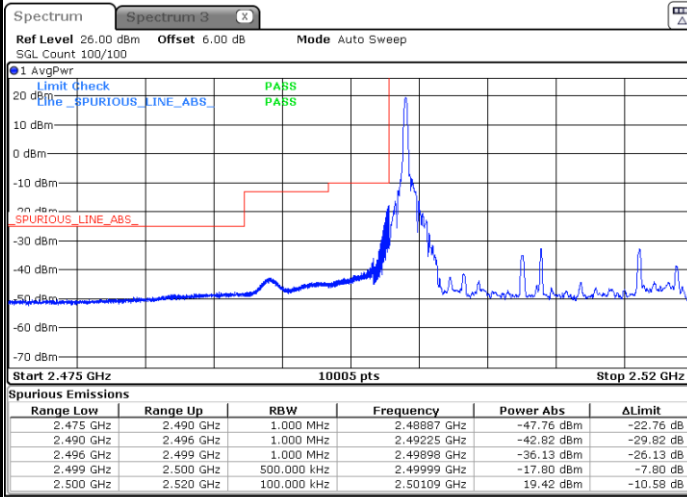

Date: 5.FEB.2025 13:59:31

Highest Band Edge / 1 RB

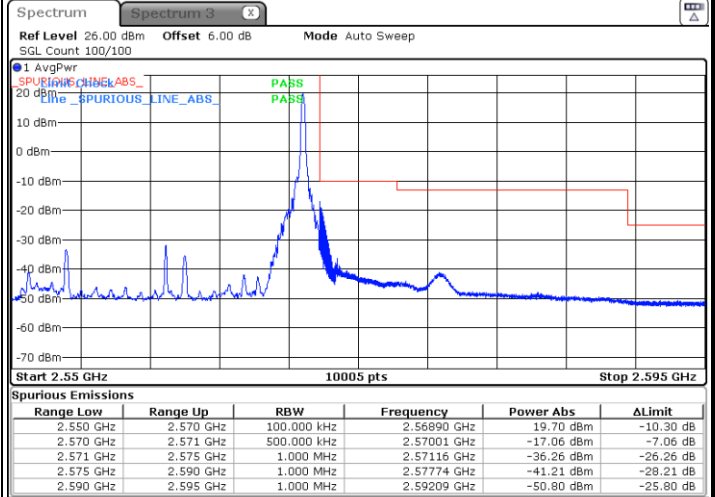

Date: 5.FEB.2025 14:10:08

Lowest Band Edge / Full RB

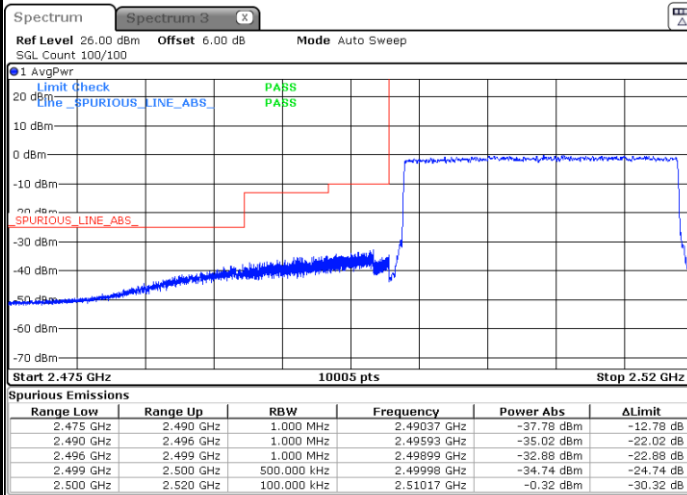

Date: 5.FEB.2025 13:56:23

Highest Band Edge / Full RB

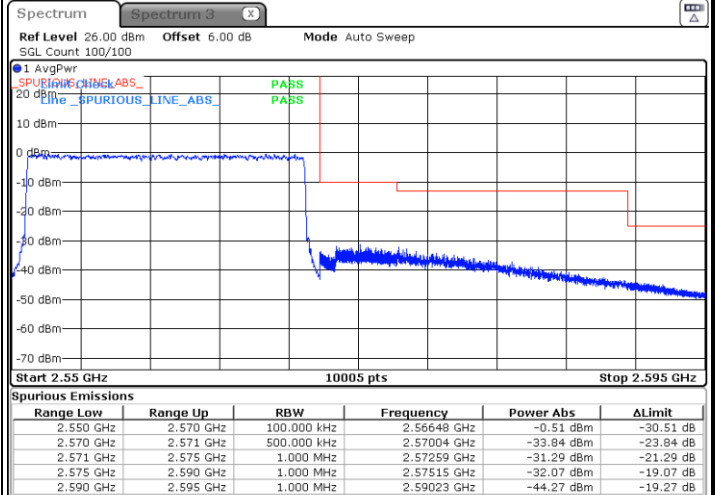

Date: 5.FEB.2025 14:13:11



LTE Band 7 / 20MHz / 64QAM

Lowest Band Edge / 1 RB

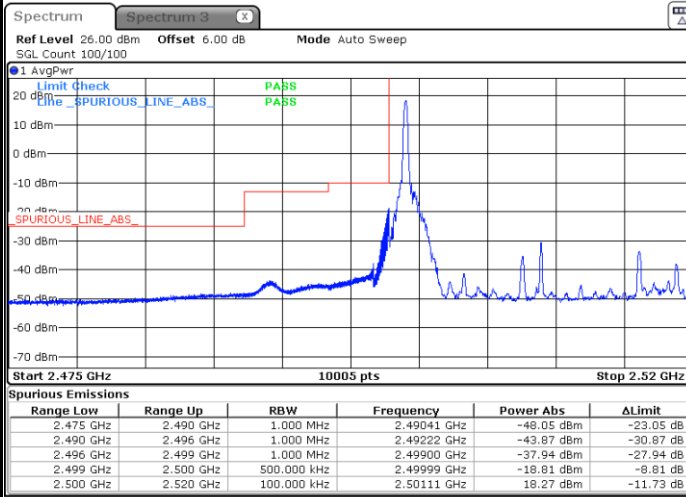

Date: 5.FEB.2025 14:00:17

Highest Band Edge / 1 RB

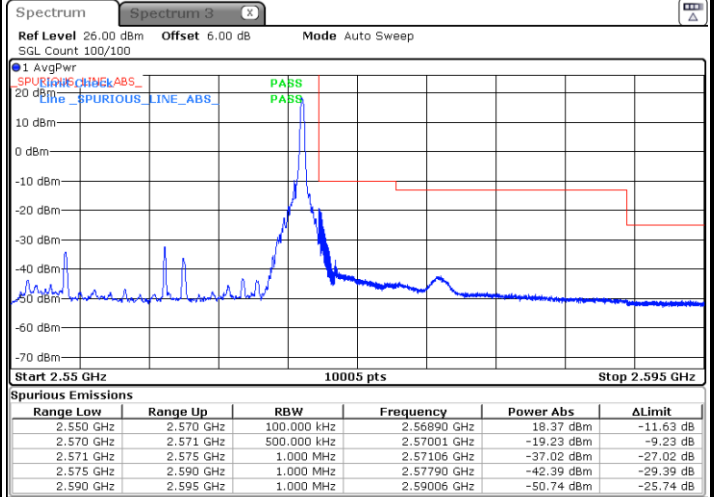

Date: 5.FEB.2025 14:10:54

Lowest Band Edge / Full RB

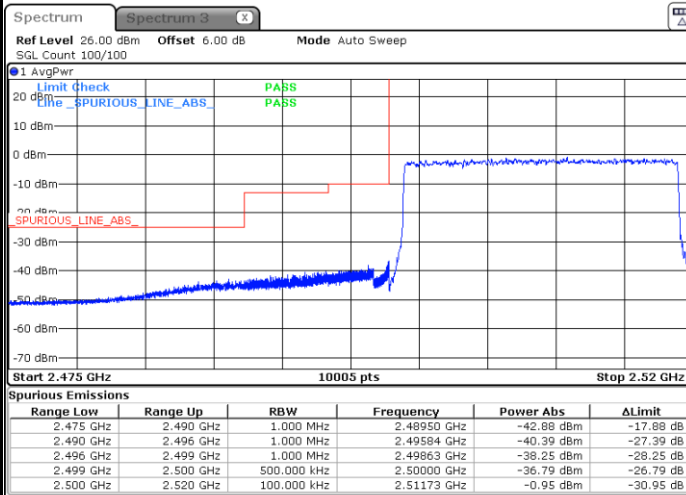

Date: 5.FEB.2025 13:57:09

Highest Band Edge / Full RB

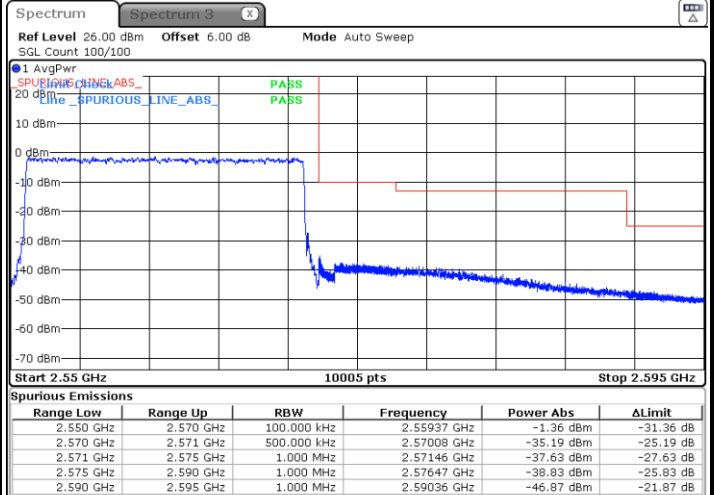

Date: 5.FEB.2025 14:13:57