



FCC RF Test Report

APPLICANT : Motorola Mobility LLC
EQUIPMENT : Mobile Cellular Phone
BRAND NAME : Motorola
MODEL NAME : XT2551-1, XT2551-2, XT2551-6
FCC ID : IHDT56AU1
STANDARD : 47 CFR Part 96
CLASSIFICATION : Citizens Band End User Devices (CBE)
EQUIPMENT TYPE : End User Equipment
TEST DATE(S) : Dec. 03, 2024 ~ Jan. 02, 2025

We, Sporton International Inc. (KunShan), would like to declare that the tested sample has been evaluated in accordance with the procedures given in ANSI C63.26-2015 and shown compliance with the applicable technical standards.

The test results in this report apply exclusively to the tested model / sample. Without written approval of Sporton International Inc. (KunShan), the test report shall not be reproduced except in full.

Jason Jia

Approved by: Jason Jia



Sporton International Inc. (Kunshan)

**No. 1098, Pengxi North Road, Kunshan Economic Development Zone Jiangsu Province 215300
People's Republic of China**



Table of Contents

History of this test report..... 3

Summary of Test Result..... 4

1 General Description 5

 1.1 Applicant..... 5

 1.2 Manufacturer 5

 1.3 Feature of Equipment Under Test..... 5

 1.4 Maximum EIRP Power and Emission Designator 6

 1.5 Testing Location 8

 1.6 Test Software 8

 1.7 Applied Standards 8

 1.8 Specification of Accessory 9

2 Test Configuration of Equipment Under Test 10

 2.1 Test Mode..... 10

 2.2 Connection Diagram of Test System 11

 2.3 Support Unit used in test configuration 12

 2.4 Measurement Results Explanation Example 12

 2.5 Frequency List of Low/Middle/High Channels..... 12

3 Conducted Test Items 15

 3.1 Measuring Instruments..... 15

 3.2 Test Setup 15

 3.3 Conducted Output Power 16

 3.4 EIRP 18

 3.5 Occupied Bandwidth 19

 3.6 Conducted Band Edge 20

 3.7 Conducted Spurious Emission 21

 3.8 Frequency Stability..... 22

4 Radiated Test Items 23

 4.1 Measuring Instruments..... 23

 4.2 Test Setup 23

 4.3 Test Result of Radiated Test..... 24

 4.4 Radiated Spurious Emission 25

5 List of Measuring Equipment..... 26

6 Measurement Uncertainty 27

Appendix A. Test Results of Conducted Test

Appendix B. Test Results of Radiated Test

Appendix C. Test Setup Photographs



Summary of Test Result

Report Clause	Ref Std. Clause	Test Items	Result (PASS/FAIL)	Remark
3.3	§2.1046	Conducted Output Power	Reporting only	-
-	§96.41	Peak-to-Average Ratio	Not Applicable	Not applicable for End User Devices
3.4	§96.41	Maximum E.I.R.P	Pass	-
		Maximum Power Spectral Density	Not Applicable	Not applicable for End User Devices
3.5	§2.1049 §96.41	Occupied Bandwidth	Reporting only	-
3.6	§2.1051 §96.41	Conducted Band Edge Measurement Adjacent Channel Leakage Ratio	Pass	-
3.7	§2.1051 §96.41	Conducted Spurious Emission	Pass	
3.8	§2.1055	Frequency Stability for Temperature & Voltage	Pass	-
4.4	§2.1051 §96.41	Radiated Spurious Emission	Pass	Under limit 4.19 dB at 10848.00 MHz

Conformity Assessment Condition:
1. The test results (PASS/FAIL) with all measurement uncertainty excluded are presented against the regulation limits or in accordance with the requirements stipulated by the applicant/manufacturer who shall bear all the risks of non-compliance that may potentially occur if measurement uncertainty is taken into account.
2. The measurement uncertainty please refer to each test result in the section "Measurement Uncertainty"
Disclaimer:
The product specifications of the EUT presented in the test report that may affect the test assessments are declared by the manufacturer who shall take full responsibility for the authenticity.



1 General Description

1.1 Applicant

Motorola Mobility LLC
222 W,Merchandise Mart Plaza, Chicago IL 60654 USA

1.2 Manufacturer

Motorola Mobility LLC
222 W,Merchandise Mart Plaza, Chicago IL 60654 USA

1.3 Feature of Equipment Under Test

Product Feature	
Equipment	Mobile Cellular Phone
Brand Name	Motorola
Model Name	XT2551-1, XT2551-2, XT2551-6
FCC ID	IHDT56AU1
Tx Frequency	LTE Band 42 : 3550 MHz ~ 3600 MHz LTE Band 43 : 3600 MHz ~ 3700 MHz LTE Band 48: 3550 MHz ~ 3700 MHz
Rx Frequency	LTE Band 42 : 3550 MHz ~ 3600 MHz LTE Band 43 : 3600 MHz ~ 3700 MHz LTE Band 48: 3550 MHz ~ 3700 MHz
Bandwidth	5MHz / 10MHz / 15MHz / 20MHz
Maximum Output Power to Antenna	<Ant. 3>: LTE Band 42: 22.27 dBm LTE Band 43: 22.41 dBm LTE Band 48: 23.49 dBm LTE CA_48B: 23.38 dBm LTE CA_48C: 23.48 dBm <Ant. 4>: LTE Band 42: 23.29 dBm LTE Band 43: 23.35 dBm LTE Band 48: 23.70 dBm LTE CA_48B: 23.42 dBm LTE CA_48C: 23.75 dBm <Ant. 5>: LTE Band 42: 22.49 dBm LTE Band 43: 22.59 dBm LTE Band 48: 22.60 dBm LTE CA_48B: 22.53 dBm LTE CA_48C: 22.54 dBm <Ant. 8>: LTE Band 42: 23.15 dBm LTE Band 43: 23.57 dBm LTE Band 48: 23.59 dBm LTE CA_48B: 23.24 dBm LTE CA_48C: 23.38 dBm
Antenna Gain	<Ant. 3>:



	LTE Band 42: -2.49 dBi LTE Band 43: -2.39 dBi LTE Band 48: -2.39 dBi <Ant. 4>: LTE Band 42: -2.60 dBi LTE Band 43: -2.60 dBi LTE Band 48: -2.60 dBi <Ant. 5>: LTE Band 42: -4.80 dBi LTE Band 43: -2.70 dBi LTE Band 48: -2.70 dBi <Ant. 8>: LTE Band 42: -2.20 dBi LTE Band 43: -2.20 dBi LTE Band 48: -2.20 dBi
Type of Modulation	QPSK / 16QAM / 64QAM / 256QAM
IMEI Code	Conducted: 350086570034095/350086570034103 Radiation: 350086570035852/350086570035860
HW Version	DVT2
SW Version	V2VL35.5
EUT Stage	Identical Prototype

Remark:

1. The above EUT's information was declared by manufacturer. Please refer to the specifications or user's manual for more detailed description.
2. The three model name XT2551-1, XT2551-2, XT2551-6 are the same product except model name different for market segment.
3. The maximum EIRP is calculated from max output power and antenna gain, only the maximum EIRP of Ant. 8 LTE B48/48B/48C/42/43 are shown in the report.
4. The maximum conducted power located ant.4, conducted items with ant.4 have assessed to test.
5. The device supports two Path for LTE Band 42/43/48, we chose higher power of 1st Path to test.
6. The device does not support LTE Band 42C for Part 96.

1.4 Maximum EIRP Power and Emission Designator

LTE Band 42		QPSK		16QAM/64QAM/256QAM	
BW (MHz)	Frequency Range (MHz)	Maximum EIRP(W)	Emission Designator (99%OBW)	Maximum EIRP(W)	Emission Designator (99%OBW)
5	3552.5~3597.5	0.1216	4M50G7D	0.0986	4M47W7D
10	3555.0~3595.0	0.1227	9M09G7D	0.0966	9M07W7D
15	3557.5~3592.5	0.1236	13M5G7D	0.0977	13M5W7D
20	3560.0~3590.0	0.1245	17M9G7D	0.0991	17M9W7D



LTE Band 43		QPSK		16QAM/64QAM/256QAM	
BW (MHz)	Frequency Range (MHz)	Maximum EIRP(W)	Emission Designator (99%OBW)	Maximum EIRP(W)	Emission Designator (99%OBW)
5	3602.5~3697.5	0.1365	4M50G7D	0.1091	4M47W7D
10	3605.0~3695.0	0.1368	9M09G7D	0.1096	9M07W7D
15	3607.5~3692.5	0.1368	13M5G7D	0.1094	13M5W7D
20	3610.0~3690.0	0.1371	17M9G7D	0.1109	17M9W7D

LTE Band 48		QPSK		16QAM/64QAM/256QAM	
BW (MHz)	Frequency Range (MHz)	Maximum EIRP(W)	Emission Designator (99%OBW)	Maximum EIRP(W)	Emission Designator (99%OBW)
5	3552.5~3697.5	0.1365	4M50G7D	0.1089	4M47W7D
10	3555~3695	0.1368	9M09G7D	0.1086	9M07W7D
15	3557.5~3692.5	0.1346	13M5G7D	0.1086	13M5W7D
20	3560~3690	0.1377	17M9G7D	0.1107	17M9W7D

LTE Band 48B_CA		QPSK		16QAM/64QAM/256QAM	
BW (MHz)	Frequency (MHz)	Maximum EIRP(W)	Emission Designator (99%OBW)	Maximum EIRP(W)	Emission Designator (99%OBW)
10MHz+10MHz	(3555 ~ 3695 MHz)	0.1271	18M9G7D	0.1045	18M9W7D

LTE Band 48 CA		QPSK		16QAM/64QAM/256QAM	
BW (MHz)	Frequency (MHz)	Maximum EIRP(W)	Emission Designator (99%OBW)	Maximum EIRP(W)	Emission Designator (99%OBW)
5MHz+20MHz	(3553.5 ~ 3690 MHz)	0.1262	23M3G7D	0.0989	23M2W7D
10MHz+20MHz	(3555.5 ~ 3690 MHz)	0.1230	28M1G7D	0.0984	28M0W7D
15MHz+20MHz	(3557.8 ~ 3690 MHz)	0.1274	32M9G7D	0.0964	33M1W7D
20MHz+5MHz	(3560 ~ 3696.7 MHz)	0.1245	23M2G7D	0.0986	23M2W7D
20MHz+10MHz	(3560 ~ 3694.5 MHz)	0.1236	28M2G7D	0.0966	27M9W7D
20MHz+15MHz	(3560 ~ 3692.2 MHz)	0.1222	32M7G7D	0.0971	32M9W7D
20MHz+20MHz	(3560 ~ 3690 MHz)	0.1312	37M6G7D	0.1074	37M9W7D

Note:

1. All modulations have been tested, only the worst test results of PSK & QAM are shown in the report.



- 2. LTE Band 48 overlaps the entire frequency range of LTE Band 42/43. Therefore, the test results provided in this report covers Band 48 as well as Band 42/43.

1.5 Testing Location

Sporton International Inc. (Kunshan) is accredited to ISO/IEC 17025:2017 by American Association for Laboratory Accreditation with Certificate Number 5145.02.

Test Firm	Sporton International Inc. (Kunshan)		
Test Site Location	No. 1098, Pengxi North Road, Kunshan Economic Development Zone Jiangsu Province 215300 People’s Republic of China TEL : +86-512-57900158		
Test Site No.	Sporton Site No.	FCC Designation No.	FCC Test Firm Registration No.
	03CH03-KS TH01-KS	CN1257	314309

1.6 Test Software

Item	Site	Manufacturer	Name	Version
1.	TH01-KS	SPORTON	Part2224_Ver5.0 200330	5.0
2.	03CH03-KS	AUDIX	E3	210616

1.7 Applied Standards

According to the specifications of the manufacturer, the EUT must comply with the requirements of the following standards:

- ♦ ANSI C63.26-2015
- ♦ 47 CFR Part 96
- ♦ FCC KDB 971168 D01 Power Meas. License Digital Systems v03r01
- ♦ FCC KDB 940660 D01 Part 96 CBRS v03
- ♦ FCC KDB 412172 D01 Determining ERP and EIRP v01r01

Remark:

1. All test items were verified and recorded according to the standards and without any deviation during the test.
2. This EUT has also been tested and complied with the requirements of FCC Part 15, Subpart B, recorded in a separate test report.



1.8 Specification of Accessory

Accessories Information				
AC Adapter 1(US)	Brand Name	Motorola(Chenyang)	Model Name	MC-681N
AC Adapter 1(EU)	Brand Name	Motorola(Chenyang)	Model Name	MC-682N
AC Adapter 1(UK)	Brand Name	Motorola(Chenyang)	Model Name	MC-683N
AC Adapter 1(AU)	Brand Name	Motorola(Chenyang)	Model Name	MC-685N
AC Adapter 1(AR)	Brand Name	Motorola(Chenyang)	Model Name	MC-686N
AC Adapter 1(BR)	Brand Name	Motorola(Chenyang)	Model Name	MC-687N
AC Adapter 1(Chile)	Brand Name	Motorola(Chenyang)	Model Name	MC-689N
AC Adapter 2(US)	Brand Name	Motorola(Acbel)	Model Name	MC-681N
AC Adapter 2(EU)	Brand Name	Motorola(Acbel)	Model Name	MC-682N
AC Adapter 2(UK)	Brand Name	Motorola(Acbel)	Model Name	MC-683N
AC Adapter 2(AU)	Brand Name	Motorola(Acbel)	Model Name	MC-685N
AC Adapter 2(AR)	Brand Name	Motorola(Acbel)	Model Name	MC-686N
AC Adapter 2(BR)	Brand Name	Motorola(Acbel)	Model Name	MC-687N
Battery 1	Brand Name	Motorola(ATL)	Model Name	RS13
Battery 2	Brand Name	Motorola(ATL)	Model Name	RS35
USB Cable 1	Brand Name	Motorola(saibao)	Model Name	SC18D71644
USB Cable 2	Brand Name	Motorola(Luxshare)	Model Name	SC18E08104
USB Cable 3	Brand Name	Motorola(saibao)	Model Name	SC18D86731
USB Cable 4	Brand Name	Motorola(Luxshare)	Model Name	SC18E08103



2 Test Configuration of Equipment Under Test

2.1 Test Mode

Antenna port conducted and radiated test items listed below are performed according to KDB 971168 D01 Power Meas. License Digital Systems v03r01 with maximum output power.

For radiated measurement, pre-scanned in three orthogonal panels, X, Y, Z. The worst cases (X Plane) were recorded in this report.

The EUT is a folding phone, pretest the open status and closed status, only the worst status perform final test and record in the report. For the accessories, pretest standalone mode / Earphone mode / Adapter mode / Wireless charging mode, only the worst status perform final test and record in the report

Test Items	Band	Bandwidth (MHz)						Modulation				RB #			Test Channel			
		1.4	3	5	10	15	20	QPSK	16 QAM	64 QAM	256 QAM	1	Half	Full	L	M	H	
Max. Output Power	42	-	-	v	v	v	v	v	v	v	v	v	v	v	v	v	v	
	43	-	-	v	v	v	v	v	v	v	v	v	v	v	v	v	v	
	48	-	-	v	v	v	v	v	v	v	v	v	v	v	v	v	v	
Adjacent Channel Leakage Ratio	48	-	-	v	v	v	v	v	v	v	v	v		v	v	v	v	
26dB and 99% Bandwidth	48	-	-	v	v	v	v	v	v					v		v		
Conducted Band Edge	48	-	-	v	v	v	v	v	v	v	v	v		v	v	v	v	
Conducted Spurious Emission	48	-	-	v	v	v	v	v					v			v	v	
E.I.R.P	42	-	-	v	v	v	v	v	v	v	v	v	v	v	v	v	v	
	43	-	-	v	v	v	v	v	v	v	v	v	v	v	v	v	v	
	48	-	-	v	v	v	v	v	v	v	v	v	v	v	v	v	v	
Frequency Stability	48	-	-		v			v					v				v	
Radiated Spurious Emission	48	Worst Case															v	
Remark	1. The mark "v " means that this configuration is chosen for testing 2. The mark "- " means that this bandwidth is not supported. 3. The device is investigated from 30MHz to 10 times of fundamental signal for radiated spurious emission test under different RB size/offset and modulations in exploratory test. Subsequently, only the worst case emissions are reported. 4. All test items are based on engineering evaluation.																	



Test Items	Band	Bandwidth (MHz)								Modulation			RB #			Test Channel			
		20+20	20+15	15+20	20+10	10+20	10+10	20+5	5+20	QPSK	16 QAM	64 QAM	256 QAM	1	Half	Full	L	M	H
Max. Output Power	48B	-	-	-	-	-	v	-	-	v	v	v	v	v			v	v	v
	48C	v	v	v	v	v	-	v	v	v	v	v	v	v			v	v	v
26dB and 99% Bandwidth	48B	-	-	-	-	-	v	-	-	v	v					v		v	
	48C	v	v	v	v	v	-	v	v	v	v					v		v	
Conducted Band Edge	48B	-	-	-	-	-	v	-	-	v	v	v	v	v		v	v	v	v
	48C	v	v	v	v	v	-	v	v	v	v	v	v	v		v	v	v	v
Conducted Spurious Emission	48B	-	-	-	-	-	v	-	-	v				v			v	v	v
	48C	v	v	v	v	v	-	v	v	v				v			v	v	v
Adjacent Channel Leakage Ratio	48B	-	-	-	-	-	v	-	-	v	v	v	v	v		v	v	v	v
	48C	v	v	v	v	v	-	v	v	v	v	v	v	v		v	v	v	v
E.I.R.P.	48B	-	-	-	-	-	v	-	-	v	v	v	v	v			v	v	v
	48C	v	v	v	v	v	-	v	v	v	v	v	v	v			v	v	v
Radiated Spurious Emission	48B	Worst Case																v	
	48C	Worst Case																v	
Note	<ol style="list-style-type: none"> The mark "v" means that this configuration is chosen for testing The mark "-" means that this bandwidth is not supported. The device is investigated from 30MHz to 10 times of fundamental signal for radiated spurious emission test under different RB size/offset and modulations in exploratory test. Subsequently, only the worst case emissions are reported. All test items are based on engineering evaluation. 																		

2.2 Connection Diagram of Test System

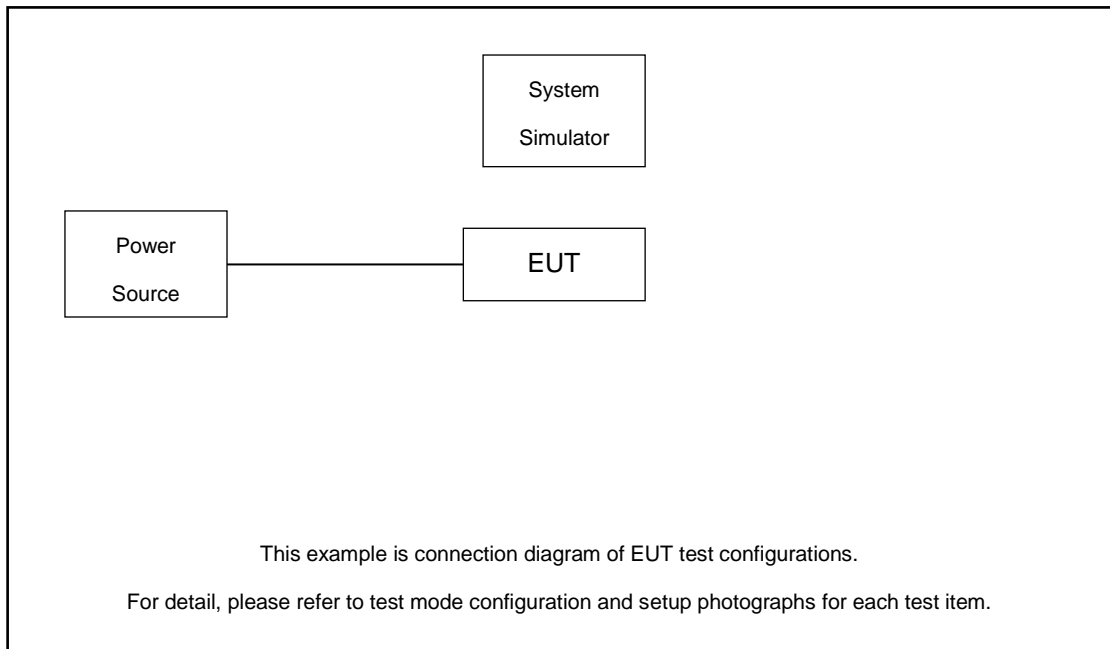

2.3 Support Unit used in test configuration

Item	Equipment	Trade Name	Model No.	FCC ID	Data Cable	Power Cord
1.	Power Supply	GWINSTEK	PSS-2002	N/A	N/A	Unshielded, 1.8 m
2.	LTE Base Station	Anritsu	MT8821C	N/A	N/A	Unshielded, 1.8 m

2.4 Measurement Results Explanation Example

For all conducted test items:

The offset level is set in the spectrum analyzer to compensate the RF cable loss between EUT conducted output port and spectrum analyzer. With the offset compensation, the spectrum analyzer reading level is exactly the EUT RF output level.

The spectrum analyzer offset is derived from RF cable loss.

Offset = RF cable loss.

Following shows an offset computation example with cable loss 8.72 dB.

Example :

$$\begin{aligned} \text{Offset(dB)} &= \text{RF cable loss(dB)}. \\ &= 8.72 \text{ (dB)} \end{aligned}$$

2.5 Frequency List of Low/Middle/High Channels

LTE Band 48 Channel and Frequency List				
BW [MHz]	Channel/Frequency(MHz)	Lowest	Middle	Highest
20	Channel	55340	55990	56640
	Frequency	3560.0	3625.0	3690.0
15	Channel	55315	55990	56665
	Frequency	3557.5	3625.0	3692.5
10	Channel	55290	55990	56690
	Frequency	3555.0	3625.0	3695.0
5	Channel	55265	55990	56715
	Frequency	3552.5	3625.0	3697.5



LTE Band 42 Channel and Frequency List				
BW [MHz]	Channel/Frequency(MHz)	Lowest	Middle	Highest
20	Channel	43190	43340	43490
	Frequency	3560	3575	3590
15	Channel	43165	43340	43515
	Frequency	3557.5	3575	3592.5
10	Channel	43140	43340	43540
	Frequency	3555	3575	3595
5	Channel	43115	43340	43565
	Frequency	3552.5	3575	3597.5

LTE Band 43 Channel and Frequency List				
BW [MHz]	Channel/Frequency(MHz)	Lowest	Middle	Highest
20	Channel	43690	44090	44490
	Frequency	3610	3650	3690
15	Channel	43665	44090	44515
	Frequency	3607.5	3650	3692.5
10	Channel	43640	44090	44540
	Frequency	3605	3650	3695
5	Channel	43615	44090	44565
	Frequency	3602.5	3650	3697.5

LTE Band 48B_CA Channel and Frequency List					
BW [MHz]	Channel/Frequency(MHz)	Lowest	Middle	Highest	
10 + 10	PCC	Channel	55290	55941	56591
		Frequency	3555	3620.1	3685.1
	SCC	Channel	55389	56039	56690
		Frequency	3564.9	3629.9	3695



LTE Band 48C_CA Channel and Frequency List					
BW [MHz]	Channel/Frequency(MHz)		Lowest	Middle	Highest
5 + 20	PCC	Channel	55273	55898	56523
		Frequency	3553.3	3615.8	3678.3
	SCC	Channel	55390	56015	56640
		Frequency	3565	3627.5	3690
20 + 5	PCC	Channel	55340	55965	56590
		Frequency	3560	3622.5	3685
	SCC	Channel	55457	56082	56707
		Frequency	3571.7	3634.2	3696.7
10 + 20	PCC	Channel	55295	55896	56496
		Frequency	3555.5	3615.6	3675.6
	SCC	Channel	55439	56040	56640
		Frequency	3569.9	3630	3690
20 + 10	PCC	Channel	55340	55941	56541
		Frequency	3560	3620.1	3680.1
	SCC	Channel	55484	56085	56685
		Frequency	3574.4	3634.5	3694.5

LTE Band 48C_CA Channel and Frequency List					
BW [MHz]	Channel/Frequency(MHz)		Lowest	Middle	Highest
15 + 20	PCC	Channel	55318	55893	56469
		Frequency	3557.8	3615.3	3672.9
	SCC	Channel	55489	56064	56640
		Frequency	3574.9	3632.4	3690
20 + 15	PCC	Channel	55340	55916	56491
		Frequency	3560	3617.6	3675.1
	SCC	Channel	55511	56087	56662
		Frequency	3577.1	3634.7	3692.2
20 + 20	PCC	Channel	55340	55891	56442
		Frequency	3560	3615.1	3670.2
	SCC	Channel	55538	56089	56640
		Frequency	3579.8	3634.9	3690

3 Conducted Test Items

3.1 Measuring Instruments

See list of measuring instruments of this test report.

3.2 Test Setup

3.2.1 Conducted Output Power / ACLR

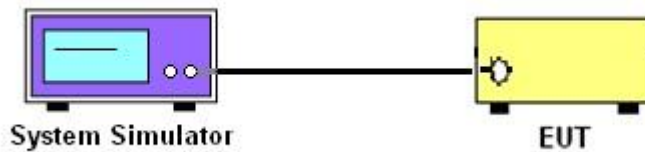

3.2.2 26dB & 99% Occupied Bandwidth, Conducted Band-Edge and Conducted Spurious Emission

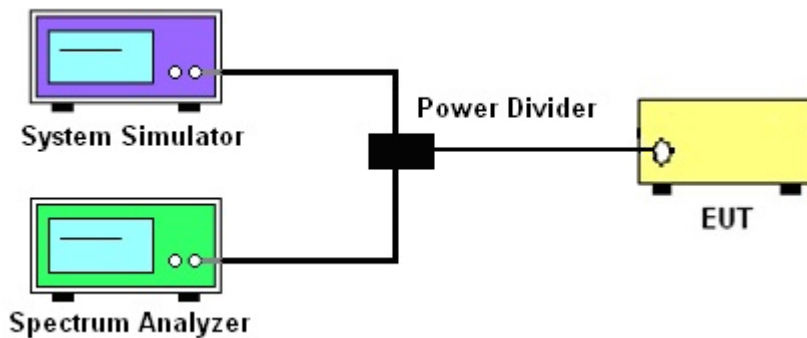

3.2.3 Frequency Stability

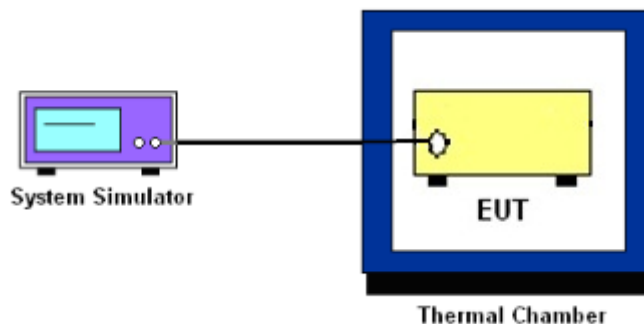

3.2.4 Test Result of Conducted Test

Please refer to Appendix A.



3.3 Conducted Output Power

3.3.1 Description of the Conducted Output Power Measurement

A system simulator was used to establish communication with the EUT. Its parameters were set to force the EUT transmitting at maximum output power. The measured power in the radio frequency on the transmitter output terminals shall be reported.

3.3.2 Test Procedures

1. The transmitter output port was connected to the system simulator.
2. Set EUT at maximum power through the system simulator.
3. Select lowest, middle, and highest channels for each band and different modulation.
4. Measure and record the power level from the system simulator.

3.3.3 Test Procedures for LTE ULCA

1. The testing follows ANSI C63.26 Section 5.2
2. The transmitter PCC & SCC output ports were connected to the system simulator.
3. Set EUT at maximum power, set the PCC/SCC CA band, channel, bandwidth and RB config.

PCC config_(Channel Bandwidth / Channel / Band) SCC config_(Channel Bandwidth / Channel / Band)

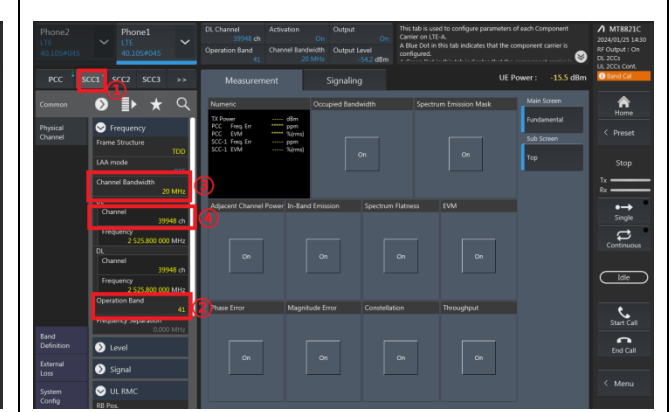
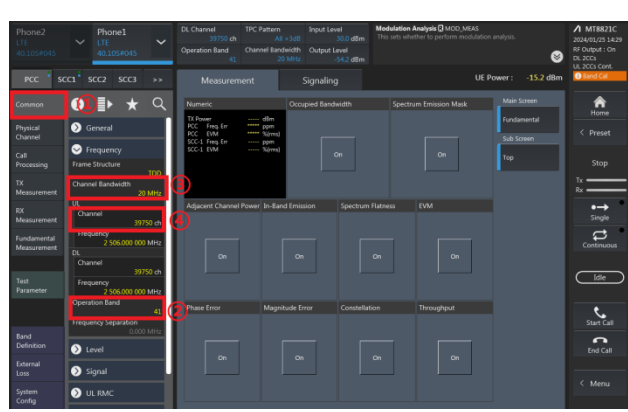

PCC config_(Number of RB / Starting RB)

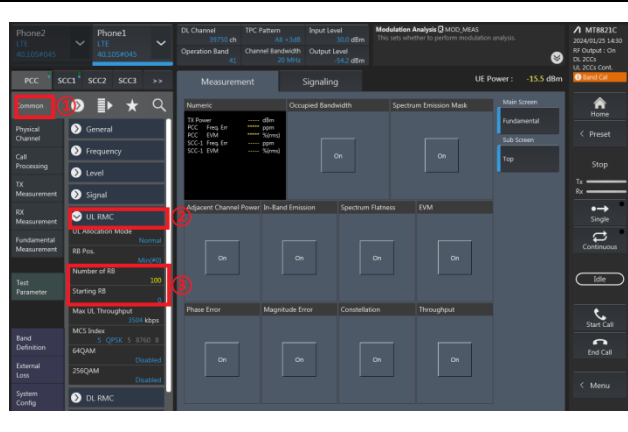

SCC config_(Number of RB / Starting RB)

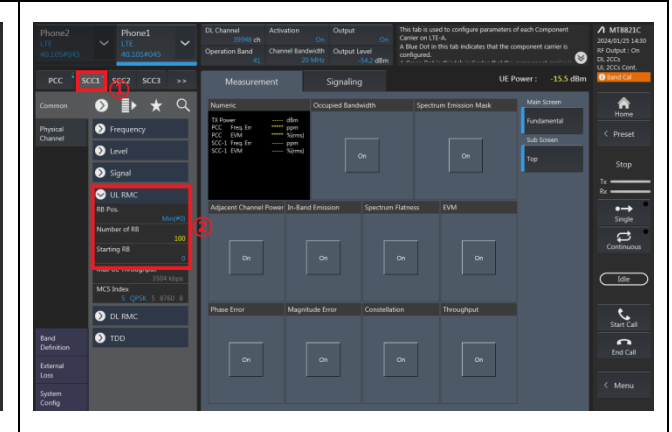

4. Select lowest, middle, and highest channels for each ULCA band and different modulation.
5. Check the ULCA spectrum and record the total power from the system simulator.

Check the ULCA spectrum (eg. 20M+20M)

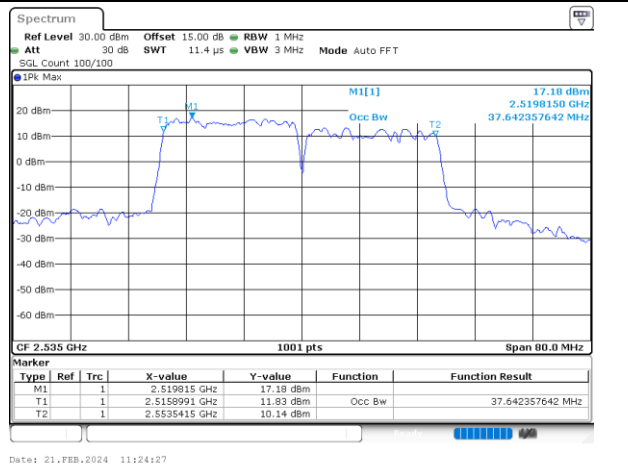

Read the Total UL CA output power (PCC+SCC)

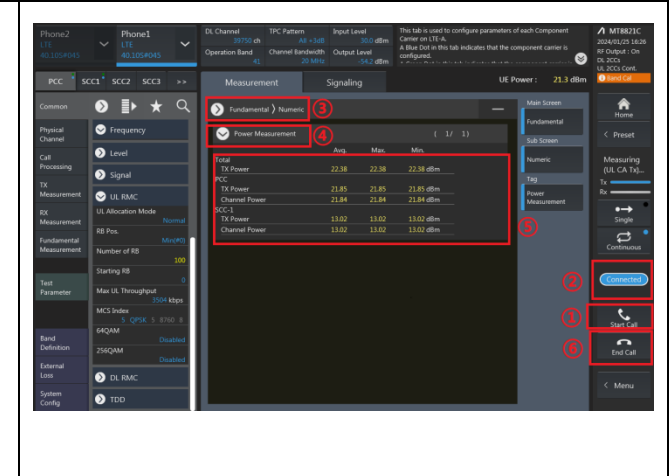



3.4 EIRP

3.4.1 Description of the EIRP Measurement

EIRP limits for CBRS equipment as below table:

Device		Maximum EIRP (dBm/10 MHz)	Maximum PSD (dBm/MHz)
Applied	End User Device	23	n/a
<input type="checkbox"/>	Category A CBSD	30	20
<input type="checkbox"/>	Category B CBSD	47	37

Remark:

1. The worst case EIRP shown in this section is found with LTE operating only using 1RB. As such, the EIRP/10MHz and full channel EIRP values will be identical since 1RB is fully contained within all available channel bandwidths for LTE Band 48 (i.e. 5, 10, 15, 20MHz)

3.4.2 Test Procedures for EIRP

1. Establishing a communications link with the call box (Base station) to measure the Maximum conducted power, the parameters were set to force the EUT transmitting at maximum output power level. Use the average power measurement function to measure total channel power of each channel bandwidth (per ANSI C63.26-2015 Section 5.2.1)
2. Determining ERP and/or EIRP from conducted RF output power measurements (Per ANSI C63.26-2015 Section 5.2.5.5)

$EIRP = P_T + G_T - L_C$, $ERP = EIRP - 2.15$, where

P_T = transmitter output power in dBm

G_T = gain of the transmitting antenna in dBi

L_C = signal attenuation in the connecting cable between the transmitter and antenna in dB



3.5 Occupied Bandwidth

3.5.1 Description of Occupied Bandwidth Measurement

The occupied bandwidth is the width of a frequency band such that, below the lower and above the upper frequency limits, the mean powers emitted are each equal to a specified percentage 0.5% of the total mean transmitted power.

The 26 dB emission bandwidth is defined as the frequency range between two points, one above and one below the carrier frequency, at which the spectral density of the emission is attenuated 26 dB below the maximum in-band spectral density of the modulated signal. Spectral density (power per unit bandwidth) is to be measured with a detector of resolution bandwidth equal to approximately 1.0% of the emission bandwidth.

3.5.2 Test Procedures

The testing follows ANSI C63.26-2015 Section 5.4.3 (26dB) and Section 5.4.4 (99OB)

1. The EUT was connected to spectrum analyzer and system simulator via a power divider.
2. The spectrum analyzer center frequency is set to the nominal EUT channel center frequency. The span range for the spectrum analyzer shall be between two and five times the anticipated OBW.
3. The nominal resolution bandwidth (RBW) shall be in the range of 1 to 5 % of the anticipated OBW, and the VBW shall be at least 3 times the RBW.
4. Set the detection mode to peak, and the trace mode to max hold.
5. Determine the reference value: Set the EUT to transmit a modulated signal. Allow the trace to stabilize. Set the spectrum analyzer marker to the highest level of the displayed trace.
(this is the reference value)
6. Determine the “-26 dB down amplitude” as equal to (Reference Value – X).
7. Place two markers, one at the lowest and the other at the highest frequency of the envelope of the spectral display such that each marker is at or slightly below the “-X dB down amplitude” determined in step 6. If a marker is below this “-X dB down amplitude” value it shall be placed as close as possible to this value. The OBW is the positive frequency difference between the two markers.
8. Use the 99 % power bandwidth function of the spectrum analyzer and report the measured bandwidth.



3.6 Conducted Band Edge

3.6.1 Description of Conducted Band Edge Measurement

Part 96.41 (e) (1) (ii)

For End User Devices the emission limits outside the fundamental are as follows:

Within 0 MHz to B MHz above and below the assigned channel ≤ -13 dBm/MHz

Greater than B MHz above and below the assigned channel ≤ -25 dBm/MHz

where B is the bandwidth in megahertz of the assigned channel or multiple contiguous channels of the End User Device.

Notwithstanding the emission limits in this paragraph, the Adjacent Channel Leakage Ratio for End User Devices shall be at least 30 dB.

Part 96.41 (e) (2)

For CBSDs and End User Devices, the conducted power of emissions below 3540 MHz or above 3710 MHz shall not exceed -25 dBm/MHz, and the conducted power of emissions below 3530 MHz or above 3720 MHz shall not exceed -40 dBm/MHz

3.6.2 Test Procedures

The testing follows FCC KDB 971168 D01 v03r01 Section 6.1.

1. The EUT was connected to spectrum analyzer and system simulator via a power divider.
2. The band edges of low and high channels for the highest RF powers were measured.
3. Set RBW $\geq 1\%$ EBW in the 1MHz band immediately outside and adjacent to the band edge.
4. Beyond the 1 MHz band from the band edge, RBW=1MHz was used
5. Offset has included the duty factor for LTE Band 48. Duty factor $=10 \log (1/x)$, where x is the measured duty cycle.
6. Set spectrum analyzer with RMS detector.
7. The RF fundamental frequency should be excluded against the limit line in the operating frequency band.



3.7 Conducted Spurious Emission

3.7.1 Description of Conducted Spurious Emission Measurement

96.41 (e)(2)

The conducted power of any emissions below 3530 MHz or above 3720 MHz shall not exceed -40dBm/MHz.

3.7.2 Test Procedures

The testing follows FCC KDB 971168 D01 v03r01 Section 6.1.

1. The EUT was connected to spectrum analyzer and system simulator via a power divider.
2. The RF output of EUT was connected to the spectrum analyzer by RF cable and attenuator. The path loss was compensated to the results for each measurement.
3. The middle channel for the highest RF power within the transmitting frequency was measured.
4. The conducted spurious emission for the whole frequency range was taken.
5. Make the measurement with the spectrum analyzer's RBW = 1MHz, VBW = 3MHz.
6. Set spectrum analyzer with RMS detector.
7. Offset has included the duty factor for LTE Band 48. Duty factor = $10 \log (1/x)$, where x is the measured duty cycle.
8. Taking the record of maximum spurious emission.
9. The RF fundamental frequency should be excluded against the limit line in the operating frequency band.
10. The limit line is -40dBm/MHz.



3.8 Frequency Stability

3.8.1 Description of Frequency Stability Measurement

The frequency stability shall be measured by variation of ambient temperature and variation of primary supply voltage to ensure that the fundamental emission stays within the authorized frequency block.

3.8.2 Test Procedures for Temperature Variation

The testing follows FCC KDB 971168 D01 v03r01 Section 9.0.

1. The EUT was set up in the thermal chamber and connected with the system simulator.
2. With power OFF, the temperature was decreased to -30°C and the EUT was stabilized before testing. Power was applied and the maximum change in frequency was recorded within one minute.
3. With power OFF, the temperature was raised in 10°C step up to 50°C . The EUT was stabilized at each step for at least half an hour. Power was applied and the maximum frequency change was recorded within one minute.

3.8.3 Test Procedures for Voltage Variation

The testing follows FCC KDB 971168 D01 v03r01 Section 9.0.

1. The EUT was placed in a temperature chamber at $25\pm 5^{\circ}\text{C}$ and connected with the system simulator.
2. The power supply voltage to the EUT was varied from 85% to 115% of the nominal value measured at the input to the EUT.
3. The variation in frequency was measured for the worst case.

4 Radiated Test Items

4.1 Measuring Instruments

See list of measuring instruments of this test report.

4.2 Test Setup

4.2.1 For radiated test below 30MHz

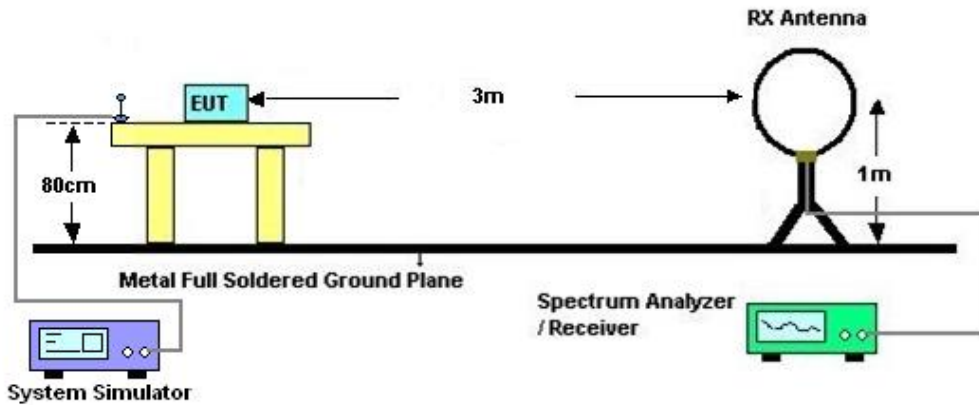

4.2.2 For radiated test from 30MHz to 1GHz

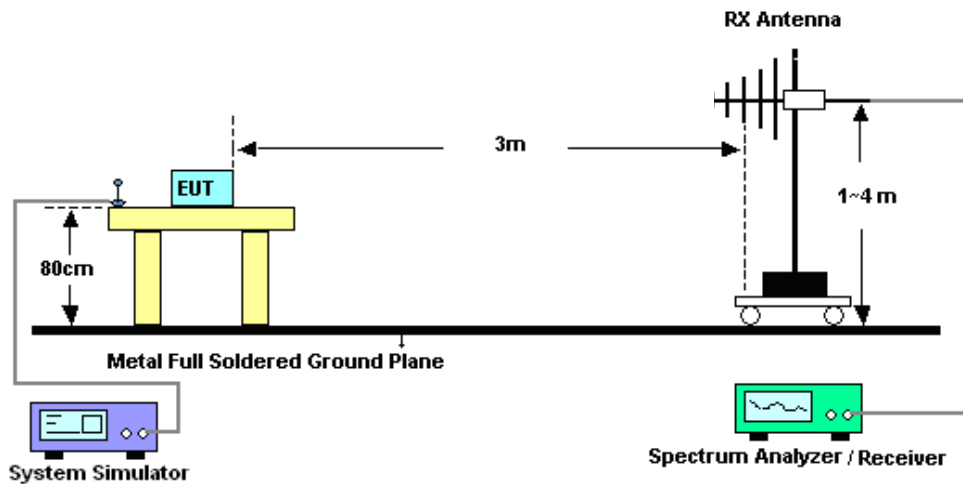

4.2.3 For radiated test above 1GHz

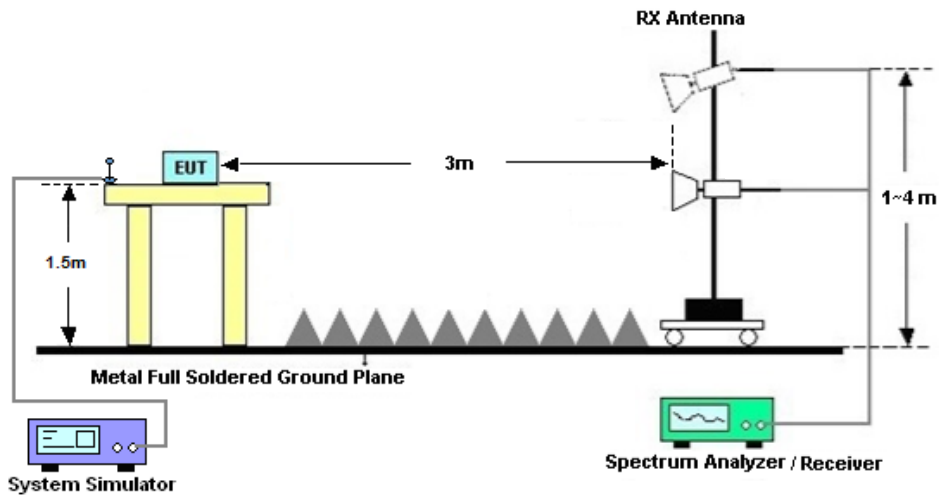

4.3 Test Result of Radiated Test

The low frequency, which started from 9 kHz to 30MHz, was pre-scanned and the result which was 20dB lower than the limit line was not reported.

Please refer to Appendix B.



4.4 Radiated Spurious Emission

4.4.1 Description of Radiated Spurious Emission Measurement

The radiated spurious emission was measured by substitution method according to ANSI C63.26-2015. The power of any emission outside of the authorized operating frequency ranges must be attenuated below the transmitter power (P) by a factor of at least -40dBm / MHz. The spectrum is scanned from 30 MHz up to a frequency including its 10th harmonic.

4.4.2 Test Procedures

1. The EUT was placed on a turntable with 0.8 meter height for frequency below 1GHz and 1.5 meter height for frequency above 1GHz respectively above ground.
2. The EUT was set 3 meters from the receiving antenna mounted on the antenna tower.
3. The table was rotated 360 degrees to determine the position of the highest spurious emission.
4. The height of the receiving antenna is varied between 1m to 4m to search the maximum spurious emission for both horizontal and vertical polarizations.
5. During the measurement, the system simulator parameters were set to force the EUT transmitting at maximum output power.
6. Make the measurement with the spectrum analyzer's RBW = 1MHz, VBW = 3MHz, taking the record of maximum spurious emission.
7. A horn antenna was substituted in place of the EUT and was driven by a signal generator. Tune the output power of signal generator to the same emission level with EUT maximum spurious emission.
$$\text{EIRP (dBm)} = \text{S.G. Power} - \text{Tx Cable Loss} + \text{Tx Antenna Gain}$$
$$\text{ERP (dBm)} = \text{EIRP} - 2.15$$
8. The RF fundamental frequency should be excluded against the limit line in the operating frequency band.
The limit line is -40dBm/MHz



5 List of Measuring Equipment

Instrument	Manufacturer	Model No.	Serial No.	Characteristics	Calibration Date	Test Date	Due Date	Remark
Spectrum Analyzer	R&S	FSV40	101040	10Hz~40GHz	Oct. 10, 2024	Dec. 03, 2024~Jan. 02, 2025	Oct. 09, 2025	Conducted (TH01-KS)
Power divider	STI	STI08-0055	-	0.5~40GHz	NCR	Dec. 03, 2024~Jan. 02, 2025	NCR	Conducted (TH01-KS)
Temperature & humidity chamber	Hongzhan	LP-150U	H2014011440	-40~+150°C 20%~95%RH	Jul. 04, 2024	Dec. 03, 2024~Jan. 02, 2025	Jul. 03, 2025	Conducted (TH01-KS)
EMI Test Receiver	Keysight	N9038A	MY56400004	3Hz~8.5GHz;Max 30dBm	Oct. 11, 2024	Dec. 31, 2024	Oct. 10, 2025	Radiation (03CH03-KS)
EXA Spectrum Analyzer	Keysight	N9010A	MY55150244	10Hz~44GHz	Apr. 18, 2024	Dec. 31, 2024	Apr. 17, 2025	Radiation (03CH03-KS)
Loop Antenna	R&S	HFH2-Z2E	101125	9kHz~30MHz	Sep. 08, 2024	Dec. 31, 2024	Sep. 07, 2025	Radiation (03CH03-KS)
Bilog Antenna	TeseQ	CBL6112D	23182	30MHz~1GHz	Dec. 05, 2024	Dec. 31, 2024	Dec. 04, 2025	Radiation (03CH03-KS)
Double Ridge Horn Antenna	ETS-Lindgren	3117	00251982	1GHz~18GHz	Aug. 16, 2024	Dec. 31, 2024	Aug. 15, 2025	Radiation (03CH03-KS)
SHF-EHF Horn	com-power	AH-840	101093	18GHz~40GHz	Jan. 06, 2024	Dec. 31, 2024	Jan. 05, 2025	Radiation (03CH03-KS)
Amplifier	SONOMA	310N	413740	30MHz ~1000MHz	Jan. 03, 2024	Dec. 31, 2024	Jan. 02, 2025	Radiation (03CH03-KS)
Amplifier	EM	EM18G40G A	060851	18~40GHz	Jan. 03, 2024	Dec. 31, 2024	Jan. 02, 2025	Radiation (03CH03-KS)
high gain Amplifier	MITEQ	AMF-7D-00 101800-30-1 0P	2082394	1Ghz-18Ghz	Jan. 03, 2024	Dec. 31, 2024	Jan. 02, 2025	Radiation (03CH03-KS)
Amplifier	Keysight	83017A	MY53270319	1GHz~26.5GHz	Oct. 09, 2024	Dec. 31, 2024	Oct. 08, 2025	Radiation (03CH03-KS)
AC Power Source	Chroma	61601	F104090004	N/A	NCR	Dec. 31, 2024	NCR	Radiation (03CH03-KS)
Turn Table	ChamPro	EM 1000-T	060762-T	0~360 degree	NCR	Dec. 31, 2024	NCR	Radiation (03CH03-KS)
Antenna Mast	ChamPro	EM 1000-A	060762-A	1 m~4 m	NCR	Dec. 31, 2024	NCR	Radiation (03CH03-KS)

NCR: No Calibration Required



6 Measurement Uncertainty

Uncertainty of Conducted Measurement

Test Item	Uncertainty
Conducted Spurious Emission & Bandedge	±2.22 dB
Occupied Channel Bandwidth	±0.1%
Conducted Power	±0.50 dB
Peak to Average Ratio	±0.50 dB
Frequency Stability	±0.04 ppm

Uncertainty of Radiated Emission Measurement (30 MHz ~ 1000 MHz)

Measuring Uncertainty for a Level of Confidence of 95% (U = 2Uc(y))	2.84 dB
---	---------

Uncertainty of Radiated Emission Measurement (1 GHz ~ 18 GHz)

Measuring Uncertainty for a Level of Confidence of 95% (U = 2Uc(y))	2.84 dB
---	---------

Uncertainty of Radiated Emission Measurement (18 GHz ~ 40 GHz)

Measuring Uncertainty for a Level of Confidence of 95% (U = 2Uc(y))	2.83 dB
---	---------

----- THE END -----



Appendix A. Test Results of Conducted Test

Test Engineer :	Smile Wang	Temperature :	22~23°C
		Relative Humidity :	40~42%

Conducted Output Power(Average power) and EIRP

LTE Band 42_ANT8:

BW [MHz]	Modulation	RB Size	RB Offset	Power Low Ch. / Freq.	Power Middle Ch. / Freq.	Power High Ch. / Freq.	EIRP(W)		
Channel				43190	43340	43490	EIRP(W)		
Frequency (MHz)				3560	3575	3590	L	M	H
20	QPSK	1	0	23.08	23.15	23.11	0.1225	0.1245	0.1233
20	QPSK	1	99	22.96	23.12	23.04	0.1191	0.1236	0.1213
20	QPSK	100	0	22.02	22.17	22.13	0.0959	0.0993	0.0984
20	16QAM	1	0	22.07	22.16	22.09	0.0971	0.0991	0.0975
20	64QAM	1	0	21.05	21.13	21.05	0.0767	0.0782	0.0767
20	256QAM	1	0	18.16	18.21	18.14	0.0394	0.0399	0.0393
Channel				43165	43340	43515	EIRP(W)		
Frequency (MHz)				3557.5	3575	3592.5	L	M	H
15	QPSK	1	0	22.99	23.12	23.03	0.1199	0.1236	0.1211
15	16QAM	1	0	22.03	22.10	21.95	0.0962	0.0977	0.0944
Channel				43140	43340	43540	EIRP(W)		
Frequency (MHz)				3555	3575	3595	L	M	H
10	QPSK	1	0	22.97	23.09	22.98	0.1194	0.1227	0.1197
10	16QAM	1	0	22.05	22.04	22.04	0.0966	0.0964	0.0964
Channel				43115	43340	43565	EIRP(W)		
Frequency (MHz)				3552.5	3575	3597.5	L	M	H
5	QPSK	1	0	22.99	23.05	23.04	0.1199	0.1216	0.1213
5	16QAM	1	0	21.97	22.14	22.07	0.0948	0.0986	0.0971



LTE Band 43_ANT8:

BW [MHz]	Modulation	RB Size	RB Offset	Power Low Ch. / Freq.	Power Middle Ch. / Freq.	Power High Ch. / Freq.	EIRP(W)		
Channel				43690	44090	44490			
Frequency (MHz)				3610	3650	3690	L	M	H
20	QPSK	1	0	23.49	23.54	23.57	0.1346	0.1361	0.1371
20	QPSK	1	99	23.51	23.52	23.45	0.1352	0.1355	0.1334
20	QPSK	100	0	22.61	22.64	22.56	0.1099	0.1107	0.1086
20	16QAM	1	0	22.65	22.61	22.59	0.1109	0.1099	0.1094
20	64QAM	1	0	21.70	21.59	21.64	0.0891	0.0869	0.0879
20	256QAM	1	0	18.57	18.72	18.67	0.0434	0.0449	0.0444
Channel				43665	44090	44515	EIRP(W)		
Frequency (MHz)				3607.5	3650	3692.5	L	M	H
15	QPSK	1	0	23.56	23.52	23.51	0.1368	0.1355	0.1352
15	16QAM	1	0	22.53	22.59	22.46	0.1079	0.1094	0.1062
Channel				43640	44090	44540	EIRP(W)		
Frequency (MHz)				3605	3650	3695	L	M	H
10	QPSK	1	0	23.56	23.55	23.52	0.1368	0.1365	0.1355
10	16QAM	1	0	22.60	22.55	22.48	0.1096	0.1084	0.1067
Channel				43615	44090	44565	EIRP(W)		
Frequency (MHz)				3602.5	3650	3697.5	L	M	H
5	QPSK	1	0	23.50	23.55	23.45	0.1349	0.1365	0.1334
5	16QAM	1	0	22.58	22.58	22.51	0.1091	0.1091	0.1074



LTE Band 48_ANT8:

BW [MHz]	Modulation	RB Size	RB Offset	Power Low Ch. / Freq.	Power Middle Ch. / Freq.	Power High Ch. / Freq.	EIRP(W)		
Channel				55340	55990	56640			
Frequency (MHz)				3560	3625	3690	L	M	H
20	QPSK	1	0	23.59	23.55	23.58	0.1377	0.1365	0.1374
20	QPSK	1	99	23.45	23.54	23.51	0.1334	0.1361	0.1352
20	QPSK	100	0	22.63	22.57	22.52	0.1104	0.1089	0.1076
20	16QAM	1	0	22.64	22.63	22.55	0.1107	0.1104	0.1084
20	64QAM	1	0	21.67	21.54	21.55	0.0885	0.0859	0.0861
20	256QAM	1	0	18.65	18.53	18.53	0.0442	0.0430	0.0430
Channel				55315	55990	56665	EIRP(W)		
Frequency (MHz)				3557.5	3625	3692.5	L	M	H
15	QPSK	1	0	23.45	23.49	23.45	0.1334	0.1346	0.1334
15	16QAM	1	0	22.56	22.49	22.52	0.1086	0.1069	0.1076
Channel				55290	55990	56690	EIRP(W)		
Frequency (MHz)				3555	3625	3695	L	M	H
10	QPSK	1	0	23.56	23.53	23.54	0.1368	0.1358	0.1361
10	16QAM	1	0	22.56	22.51	22.52	0.1086	0.1074	0.1076
Channel				55265	55990	56715	EIRP(W)		
Frequency (MHz)				3552.5	3625	3697.5	L	M	H
5	QPSK	1	0	23.54	23.52	23.55	0.1361	0.1355	0.1365
5	16QAM	1	0	22.57	22.46	22.44	0.1089	0.1062	0.1057

LTE CA_48B_ANT8:

Combination 10MHz+10MHz (50RB+50RB)							
Channel	Modulation	PCC		SCC		Measured Power	EIRP(W)
		RB Size	RB offset	RB Size	RB offset		
L	QPSK	1	Max	1	0	23.13	0.1239
M	QPSK	1	Max	1	0	23.19	0.1256
H	QPSK	1	Max	1	0	23.24	0.1271
L	16QAM	1	Max	1	0	22.39	0.1045
M	16QAM	1	Max	1	0	22.13	0.0984
H	16QAM	1	Max	1	0	21.96	0.0946
L	64QAM	1	Max	1	0	21.34	0.0820
M	64QAM	1	Max	1	0	21.21	0.0796
H	64QAM	1	Max	1	0	21.26	0.0805
L	256QAM	1	Max	1	0	18.30	0.0407
M	256QAM	1	Max	1	0	18.09	0.0388
H	256QAM	1	Max	1	0	17.96	0.0377



LTE CA_48C_ANT8:

Combination 20MHz+20MHz (100RB+100RB)							
Channel	Modulation	PCC		SCC		Measured Power	EIRP(W)
		RB Size	RB offset	RB Size	RB offset		
L	QPSK	1	Max	1	0	23.36	0.1306
M	QPSK	1	Max	1	0	23.32	0.1294
H	QPSK	1	Max	1	0	23.38	0.1312
L	16QAM	1	Max	1	0	22.51	0.1074
M	16QAM	1	Max	1	0	22.28	0.1019
H	16QAM	1	Max	1	0	22.17	0.0993
L	64QAM	1	Max	1	0	21.57	0.0865
M	64QAM	1	Max	1	0	21.38	0.0828
H	64QAM	1	Max	1	0	21.33	0.0818
L	256QAM	1	Max	1	0	18.54	0.0431
M	256QAM	1	Max	1	0	18.27	0.0405
H	256QAM	1	Max	1	0	18.18	0.0396
Combination 20MHz+15MHz (100RB+75RB)							
Channel	Modulation	PCC		SCC		Measured Power	EIRP(W)
		RB Size	RB offset	RB Size	RB offset		
H	QPSK	1	Max	1	0	23.07	0.1222
L	16QAM	1	Max	1	0	22.07	0.0971
Combination 15MHz+20MHz (100RB+75RB)							
Channel	Modulation	PCC		SCC		Measured Power	EIRP(W)
		RB Size	RB offset	RB Size	RB offset		
H	QPSK	1	Max	1	0	23.25	0.1274
L	16QAM	1	Max	1	0	22.04	0.0964
Combination 20MHz+10MHz (100RB+50RB)							
Channel	Modulation	PCC		SCC		Measured Power	EIRP(W)
		RB Size	RB offset	RB Size	RB offset		
H	QPSK	1	Max	1	0	23.12	0.1236
L	16QAM	1	Max	1	0	22.05	0.0966
Combination 10MHz+20MHz (50RB+100RB)							
Channel	Modulation	PCC		SCC		Measured Power	EIRP(W)
		RB Size	RB offset	RB Size	RB offset		
H	QPSK	1	Max	1	0	23.10	0.1230
L	16QAM	1	Max	1	0	22.13	0.0984
Combination 20MHz+5MHz (100RB+25RB)							
Channel	Modulation	PCC		SCC		Measured Power	EIRP(W)
		RB Size	RB offset	RB Size	RB offset		
H	QPSK	1	Max	1	0	23.15	0.1245
L	16QAM	1	Max	1	0	22.14	0.0986
Combination 5MHz+20MHz (25RB+100RB)							
Channel	Modulation	PCC		SCC		Measured Power	EIRP(W)
		RB Size	RB offset	RB Size	RB offset		
H	QPSK	1	Max	1	0	23.21	0.1262
L	16QAM	1	Max	1	0	22.15	0.0989



LTE Band 48

Peak-to-Average Ratio

Mode	LTE Band 48 / 20MHz				
Mod.	QPSK	16QAM	64QAM	256QAM	Limit: 13dB
RB Size	Full RB				Result
Middle CH	4.35	5.57	6.35	6.41	PASS

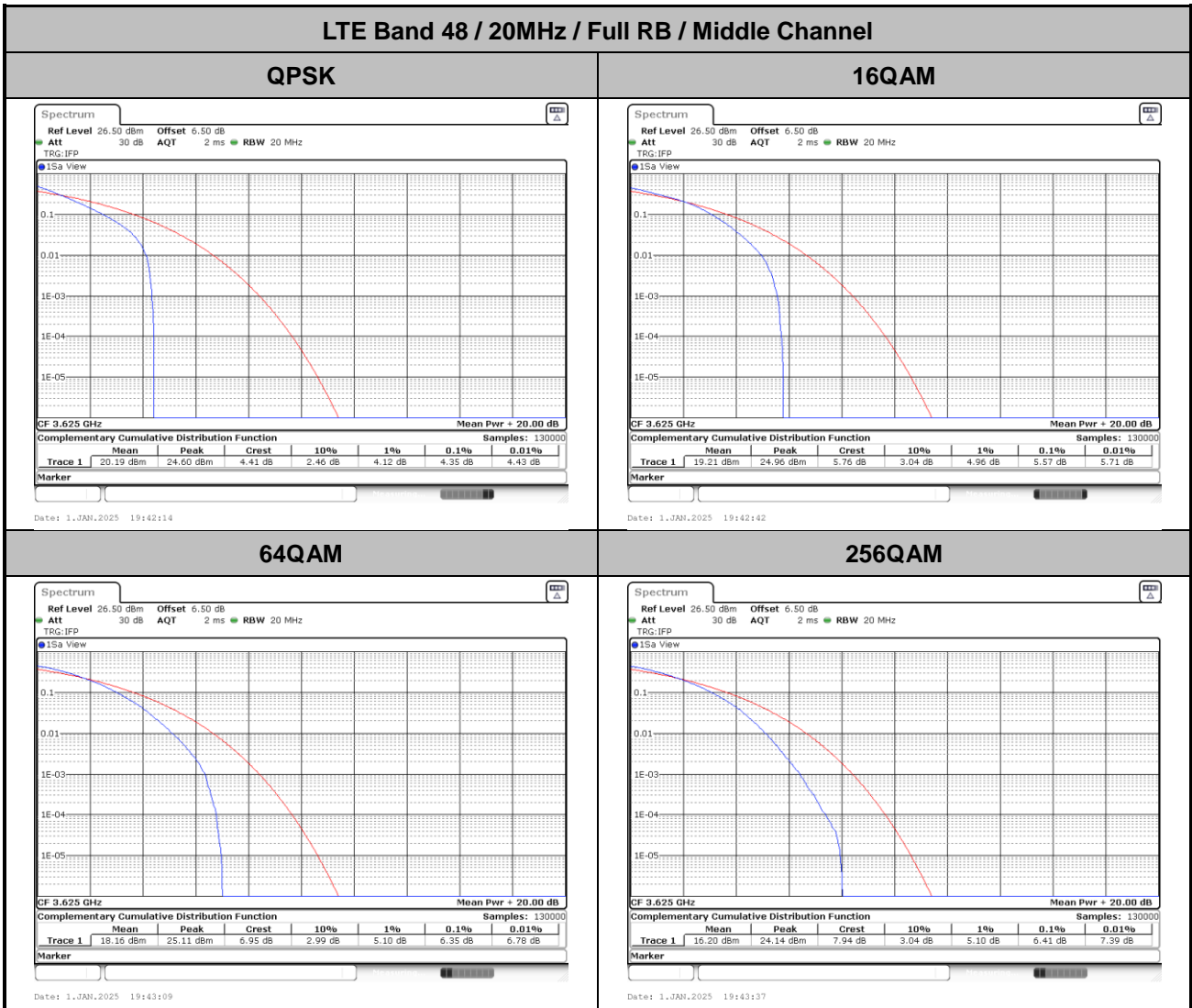



ACLR

LTE Band 48 / 5MHz

QPSK

Lowest Channel / 1RB0

Lowest Channel / 1RBmax

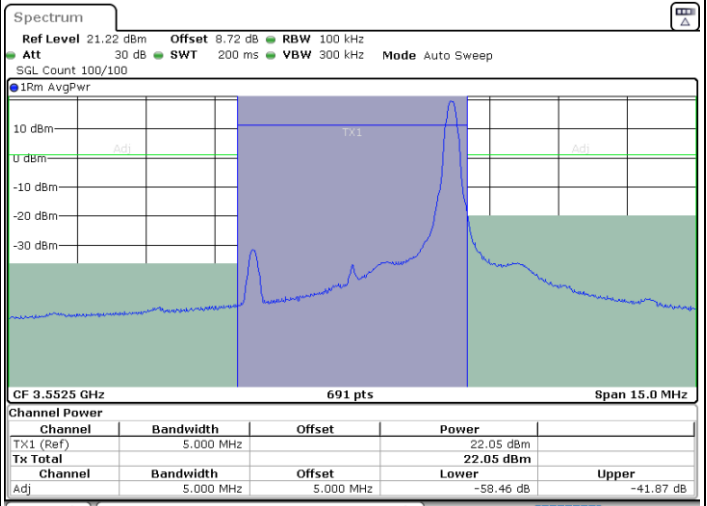
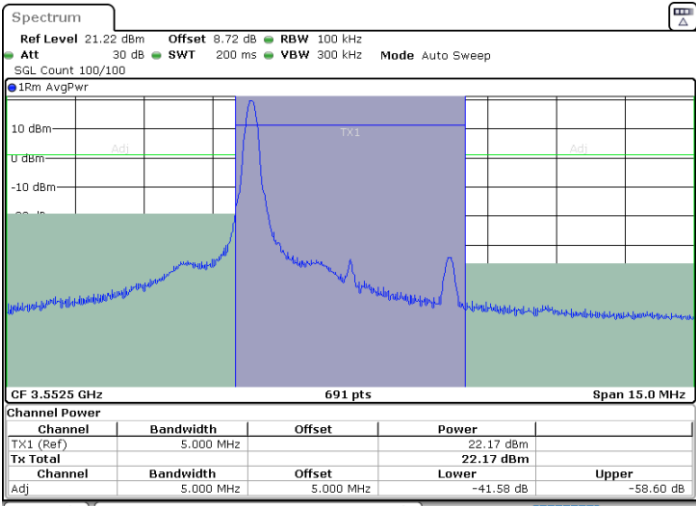

Date: 1. JAN. 2025 19:49:53

Date: 1. JAN. 2025 19:52:57

Lowest Channel / FullIRB

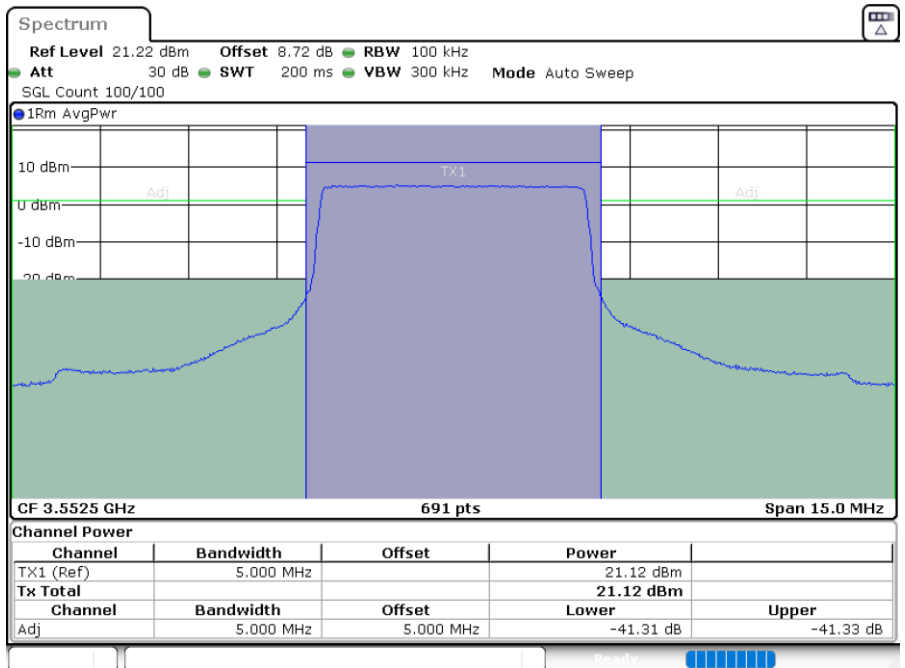

Date: 1. JAN. 2025 19:56:01



LTE Band 48 / 5MHz

QPSK

Middle Channel / 1RB0

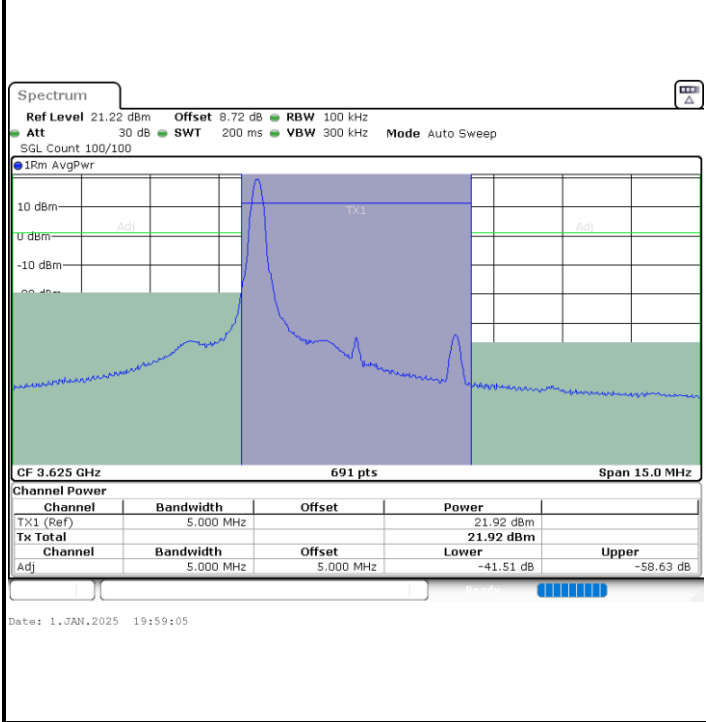

Middle Channel / 1RBmax

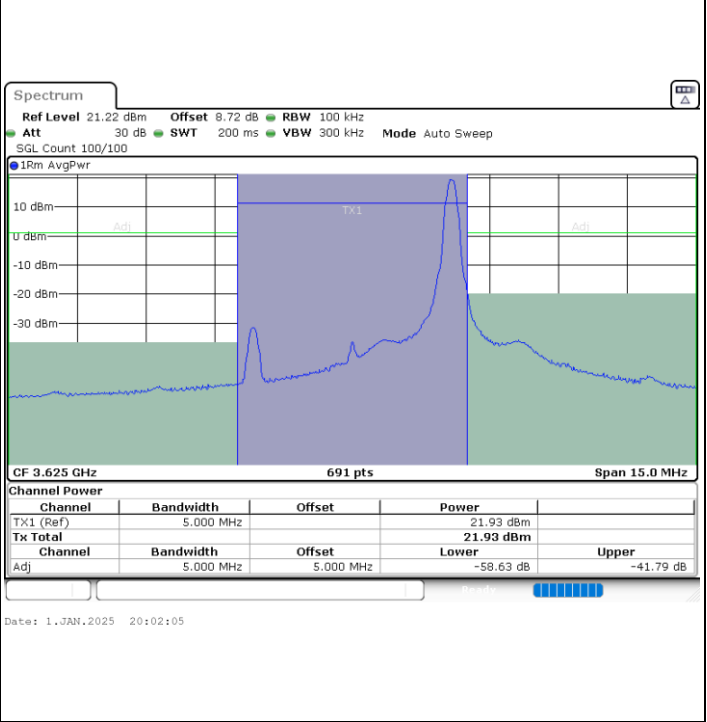

Middle Channel / FullRB

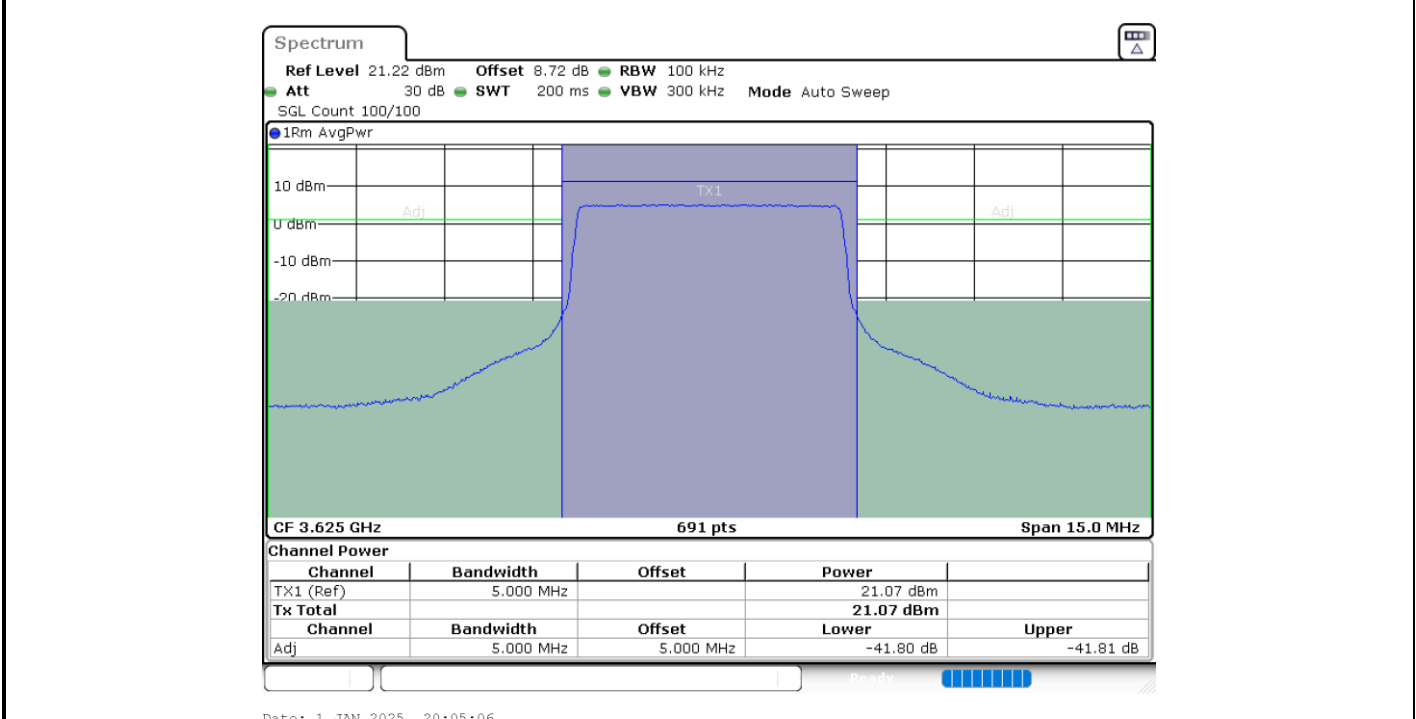



LTE Band 48 / 5MHz

QPSK

Highest Channel / 1RB0

Highest Channel / 1RBmax

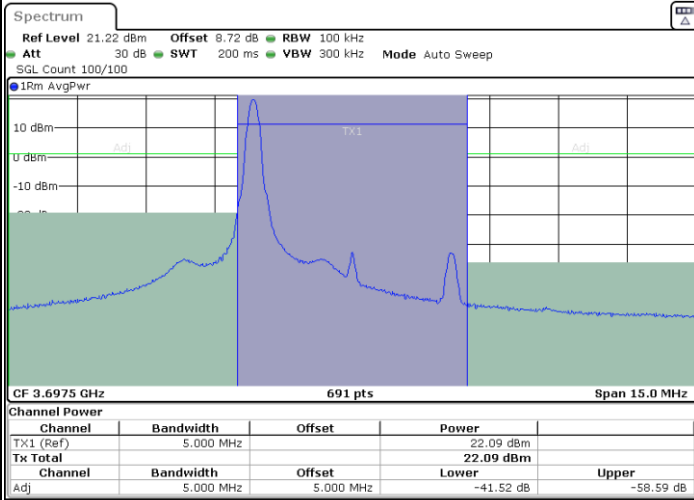

Date: 1. JAN. 2025 20:08:07

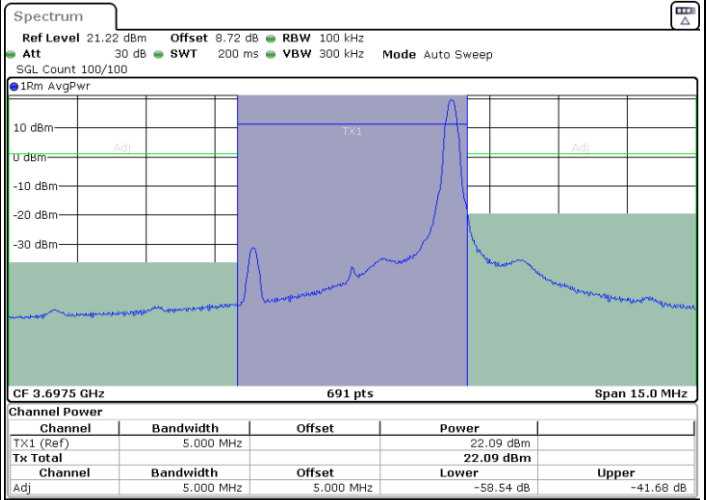

Date: 1. JAN. 2025 20:11:15

Highest Channel / FullRB

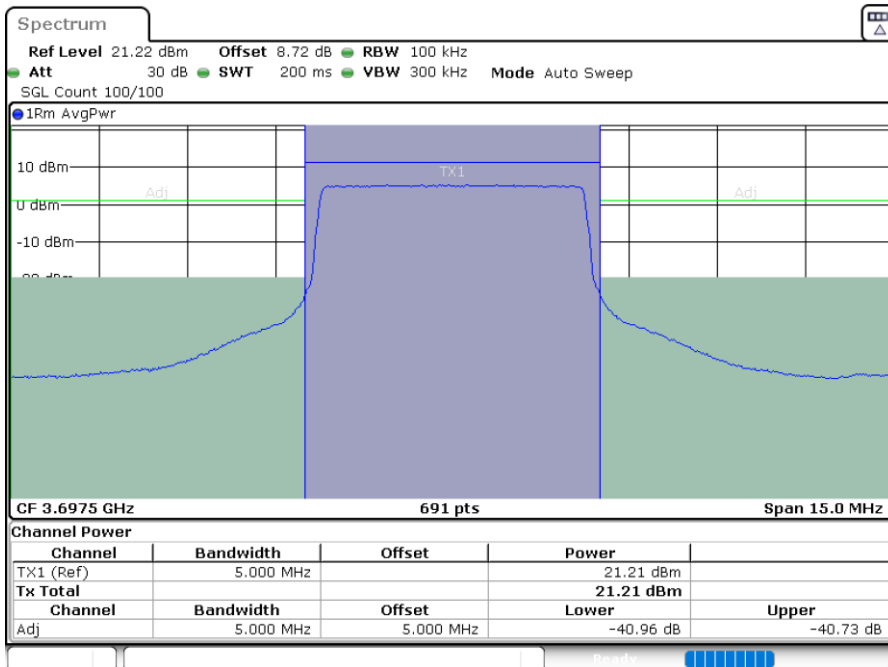

Date: 1. JAN. 2025 20:14:23



LTE Band 48 / 5MHz

16QAM

Lowest Channel / 1RB0

Lowest Channel / 1RBmax

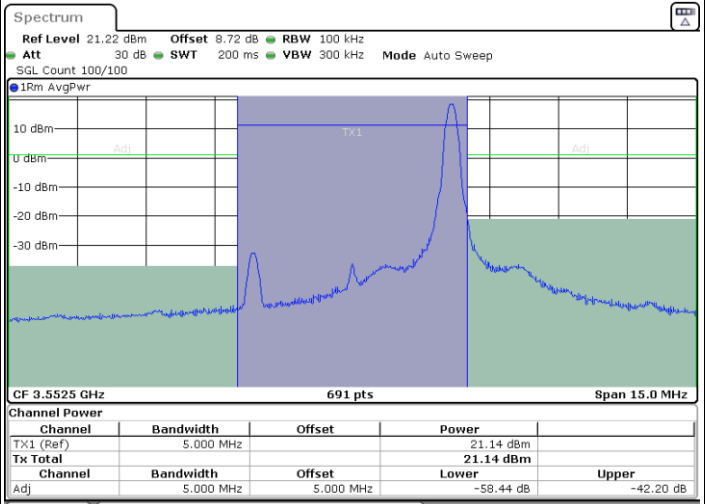
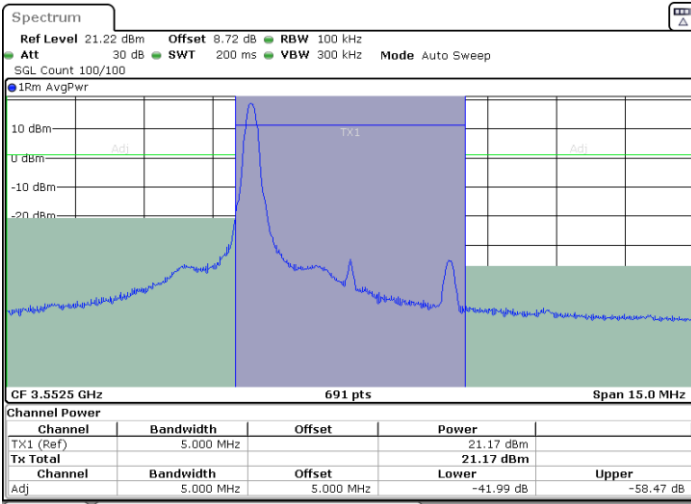

Date: 1. JAN. 2025 19:50:39

Date: 1. JAN. 2025 19:53:43

Lowest Channel / FullRB

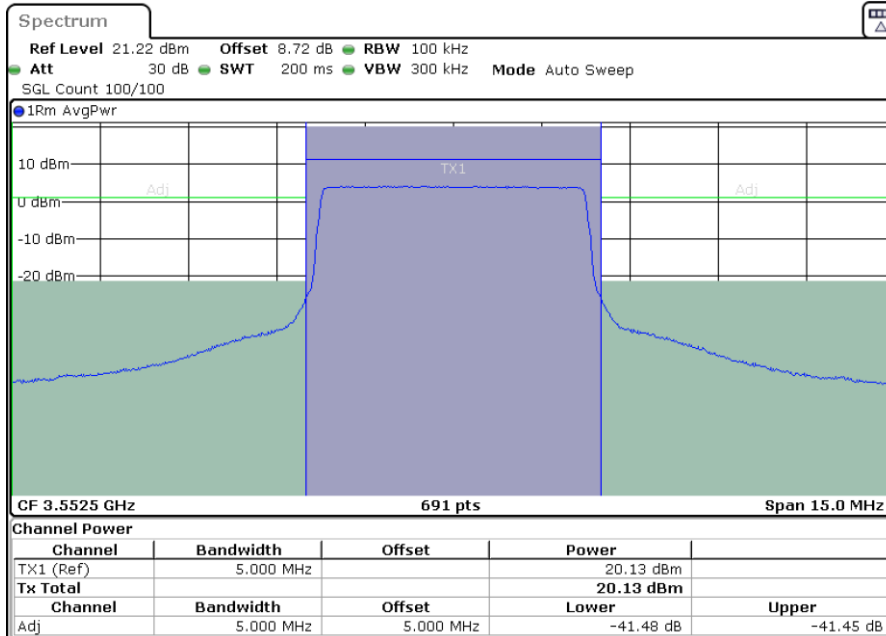

Date: 1. JAN. 2025 19:56:47



LTE Band 48 / 5MHz

16QAM

Middle Channel / 1RB0

Middle Channel / 1RBmax

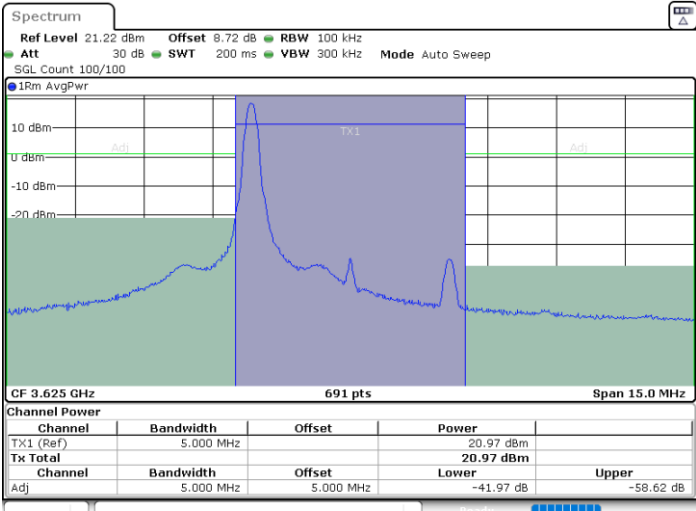

Date: 1. JAN. 2025 19:59:50

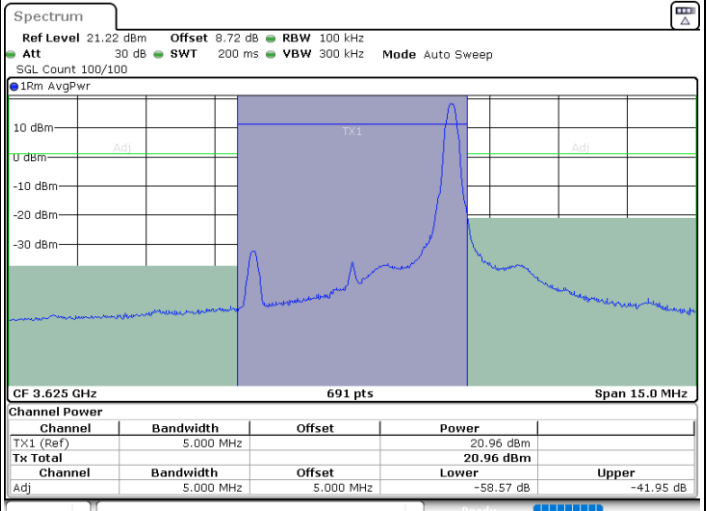

Date: 1. JAN. 2025 20:02:50

Middle Channel / FullRB

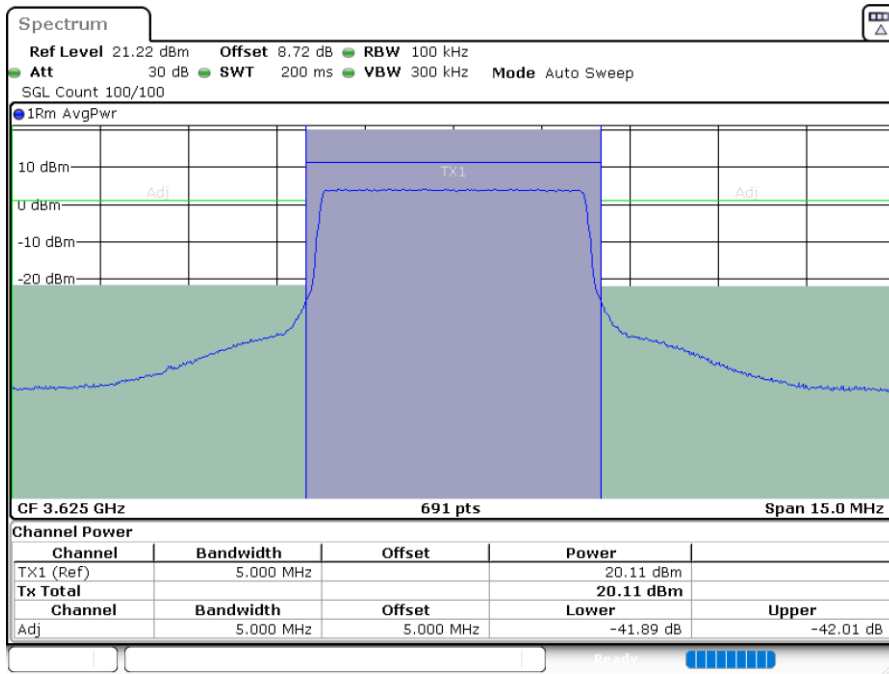

Date: 1. JAN. 2025 20:05:51



LTE Band 48 / 5MHz

16QAM

Highest Channel / 1RB0

Highest Channel / 1RBmax

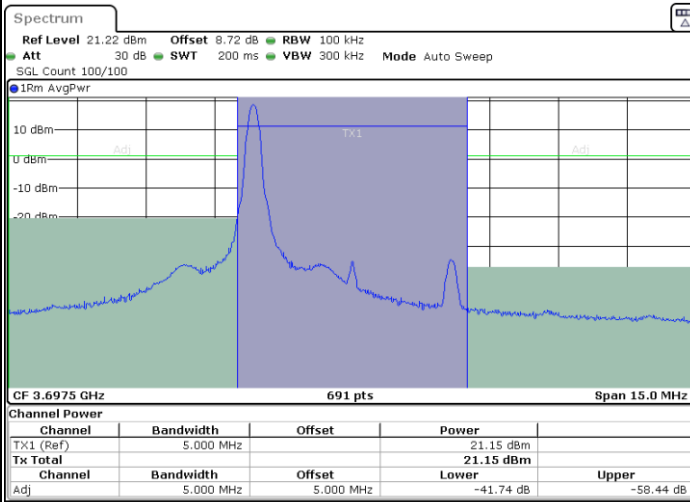

Date: 1.JAN.2025 20:08:54

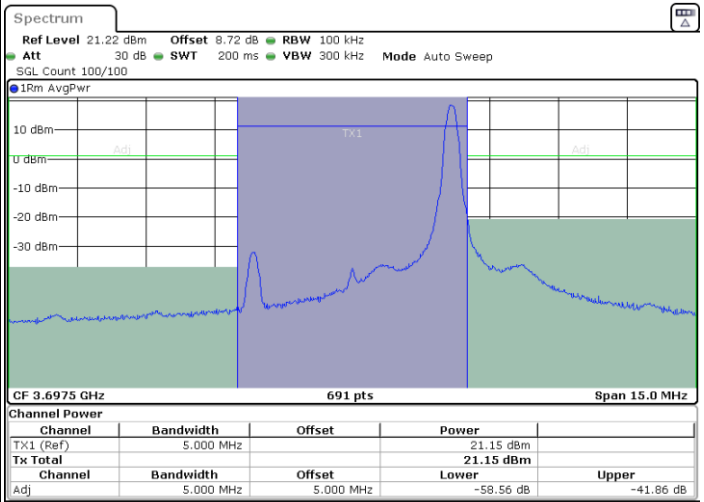

Date: 1.JAN.2025 20:12:02

Highest Channel / FullRB

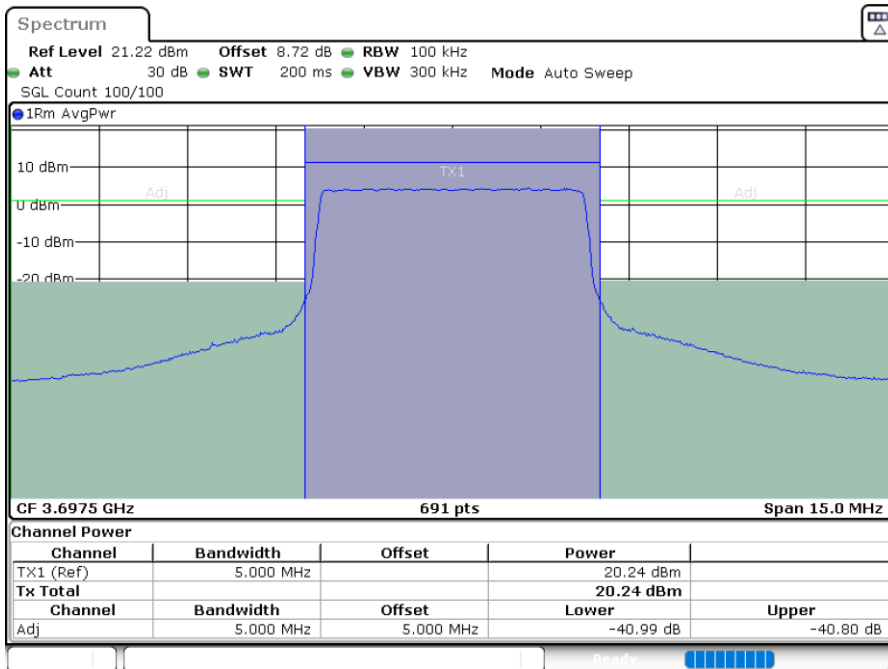

Date: 1.JAN.2025 20:15:10



LTE Band 48 / 5MHz

64QAM

Lowest Channel / 1RB0

Lowest Channel / 1RBmax

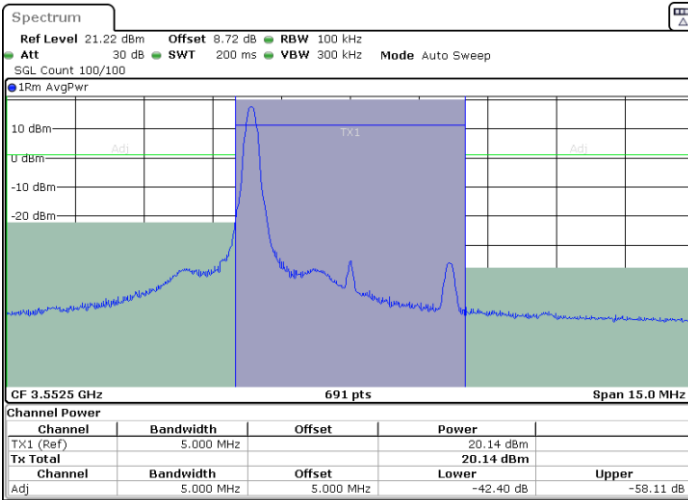

Date: 1. JAN. 2025 19:51:25

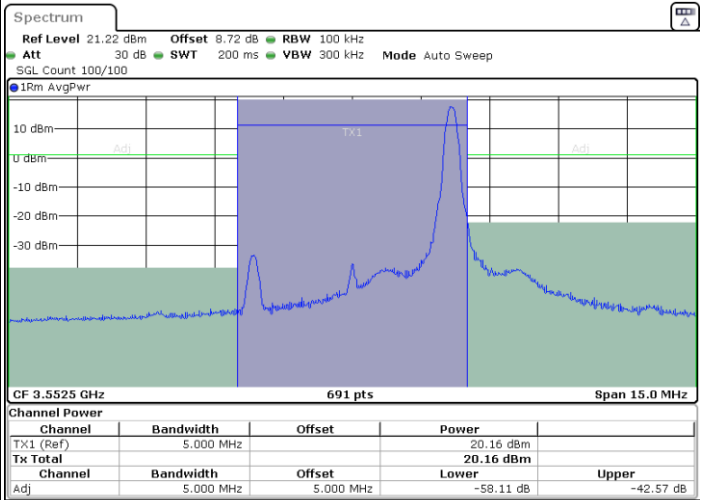

Date: 1. JAN. 2025 19:54:29

Lowest Channel / FullRB

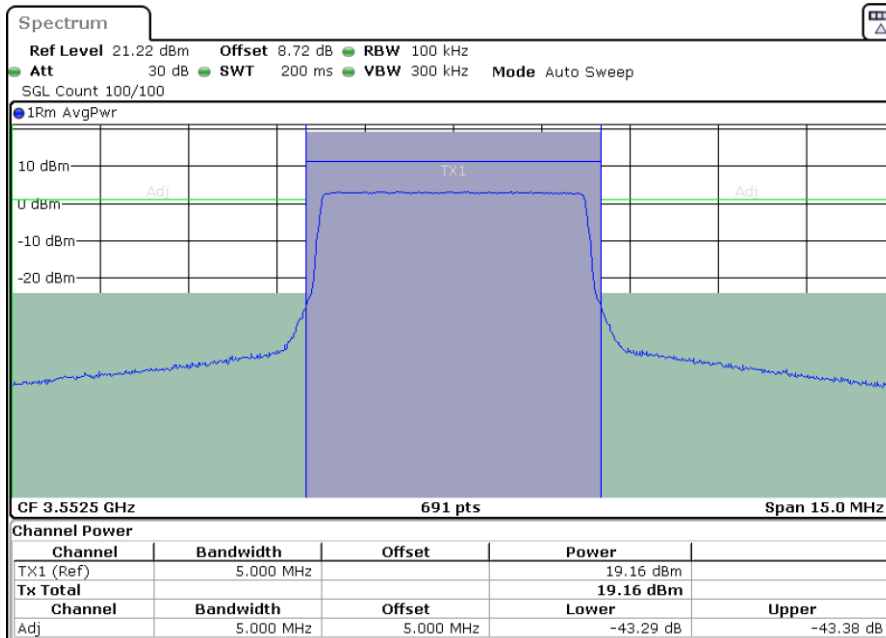

Date: 1. JAN. 2025 19:57:33



LTE Band 48 / 5MHz

64QAM

Middle Channel / 1RB0

Middle Channel / 1RBmax

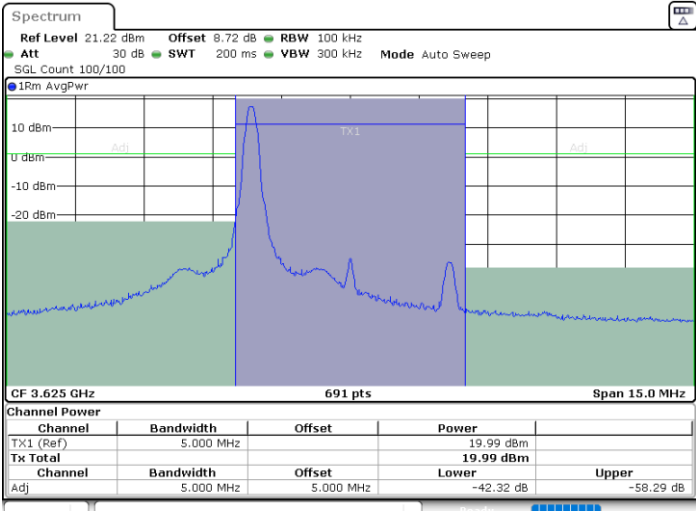

Date: 1. JAN. 2025 20:00:35

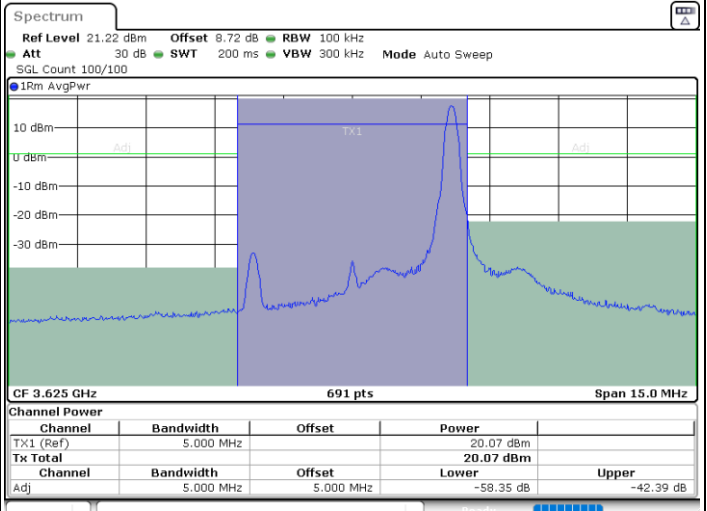

Date: 1. JAN. 2025 20:03:35

Middle Channel / FullRB

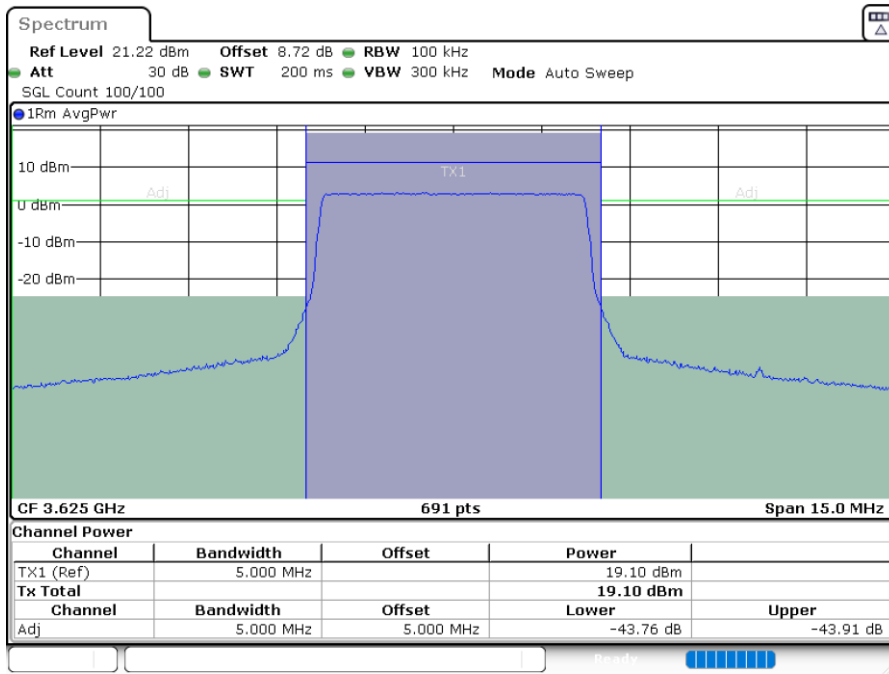

Date: 1. JAN. 2025 20:06:36



LTE Band 48 / 5MHz

64QAM

Highest Channel / 1RB0

Highest Channel / 1RBmax

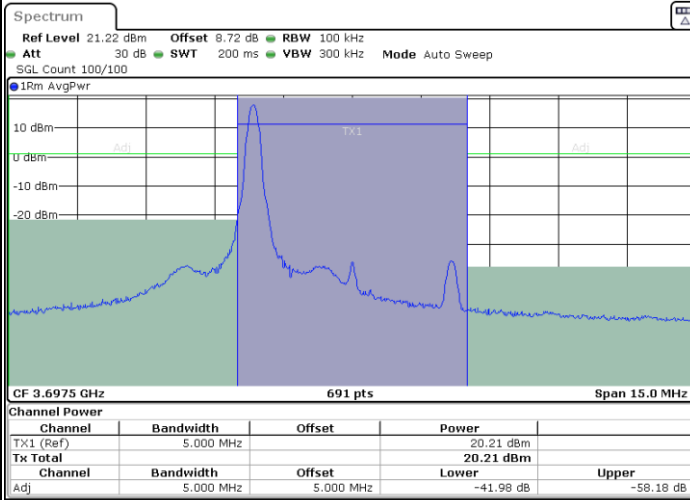

Date: 1. JAN. 2025 20:09:41

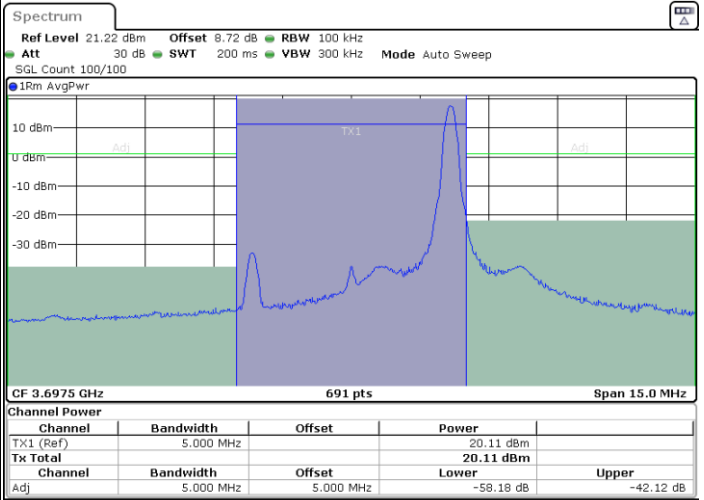

Date: 1. JAN. 2025 20:12:49

Highest Channel / FullRB

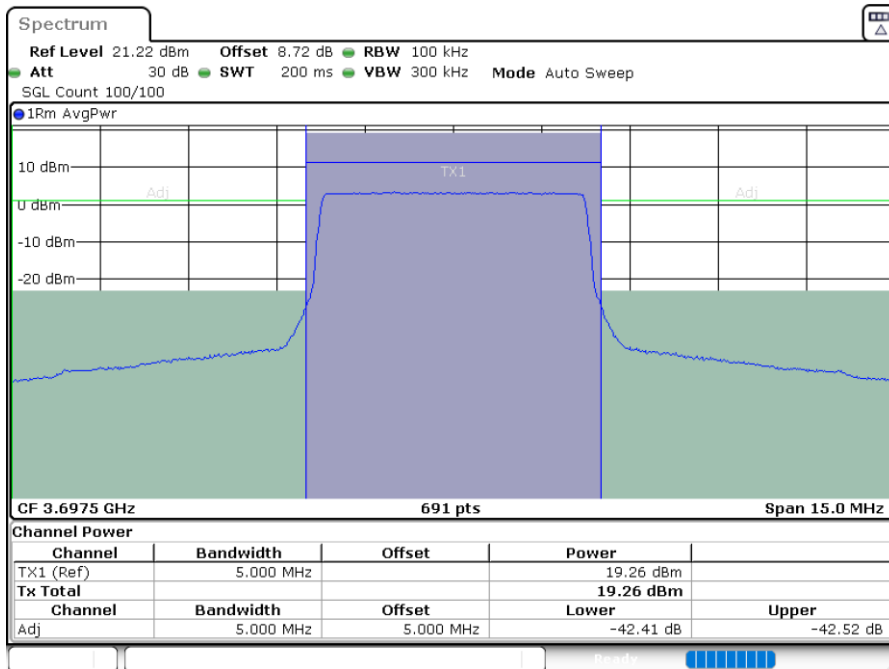

Date: 1. JAN. 2025 20:15:57



LTE Band 48 / 5MHz

256QAM

Lowest Channel / 1RB0

Lowest Channel / 1RBmax

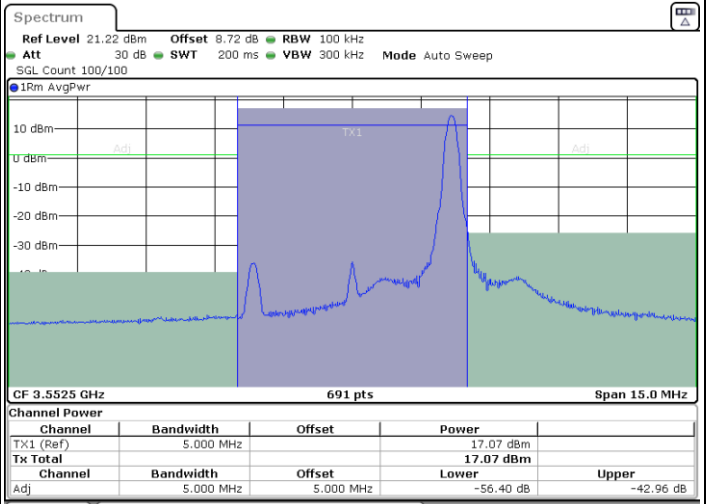
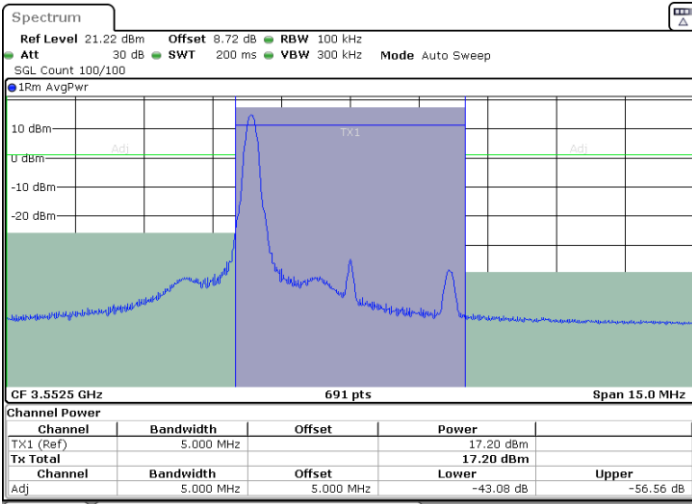

Date: 1. JAN. 2025 19:52:11

Date: 1. JAN. 2025 19:55:15

Lowest Channel / FullRB

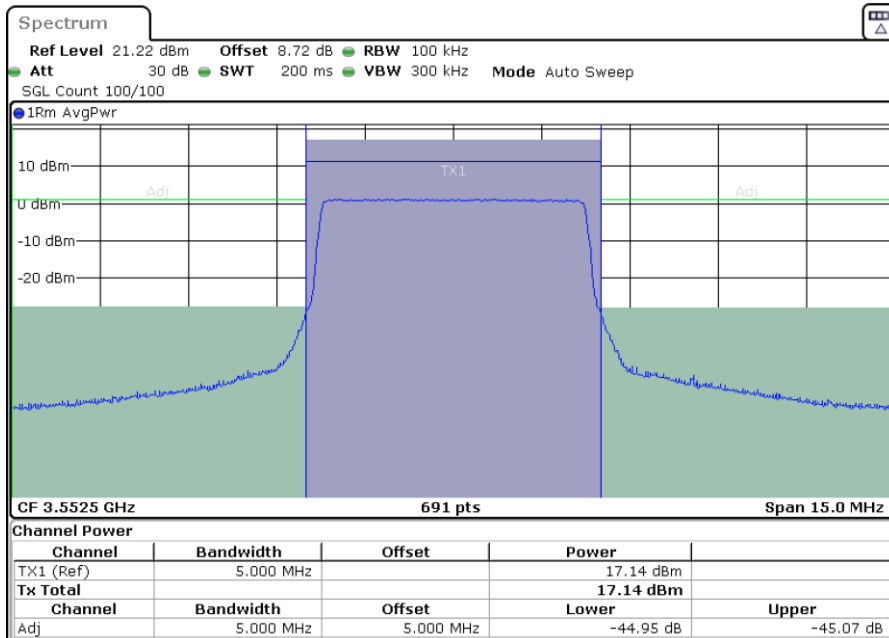

Date: 1. JAN. 2025 19:58:19



LTE Band 48 / 5MHz

256QAM

Middle Channel / 1RB0

Middle Channel / 1RBmax

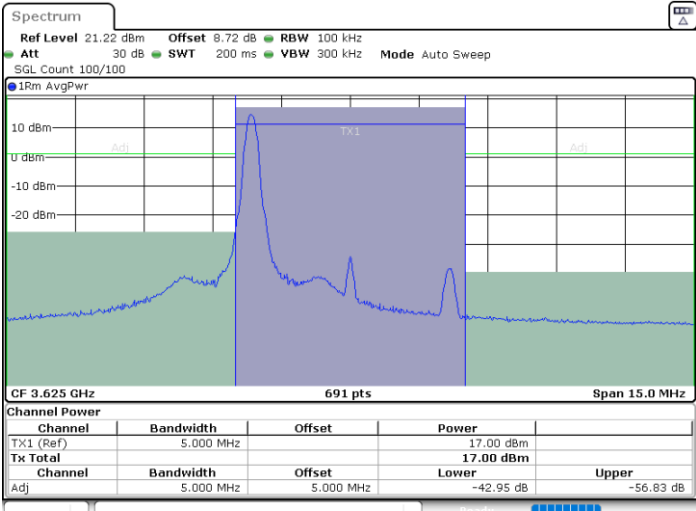

Date: 1. JAN. 2025 20:01:20

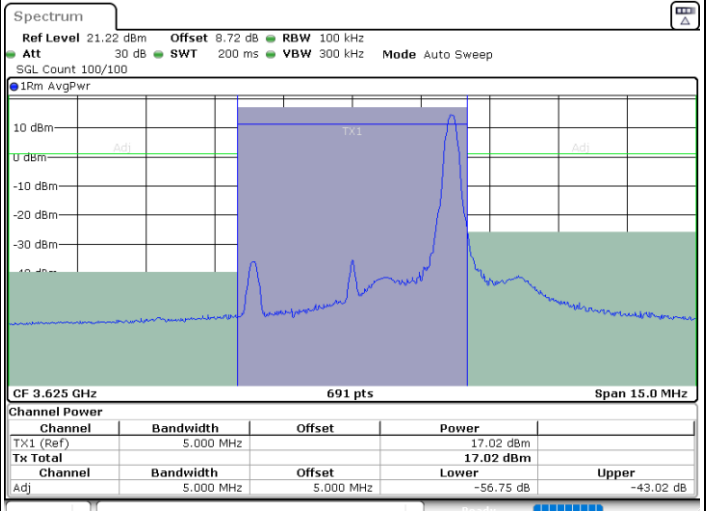

Date: 1. JAN. 2025 20:04:20

Middle Channel / FullRB

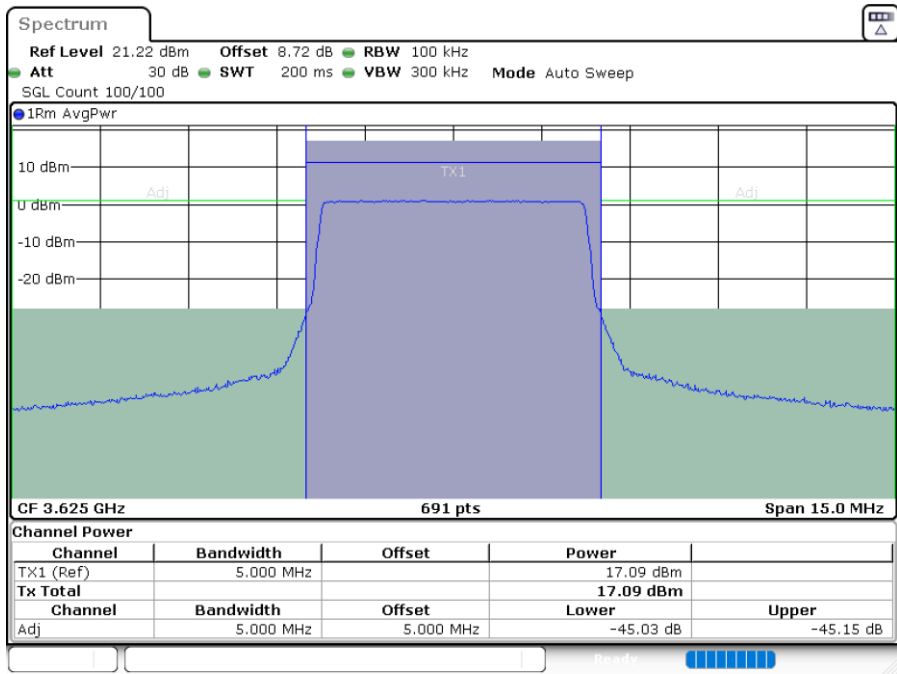

Date: 1. JAN. 2025 20:07:21



LTE Band 48 / 5MHz

256QAM

Highest Channel / 1RB0

Highest Channel / 1RBmax

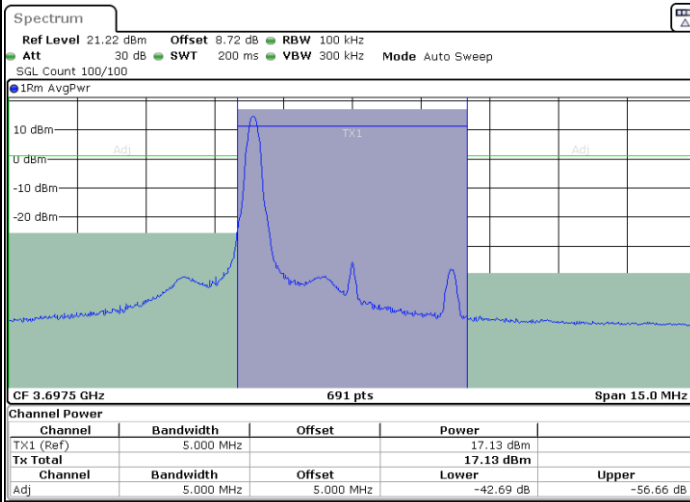

Date: 1. JAN. 2025 20:10:28

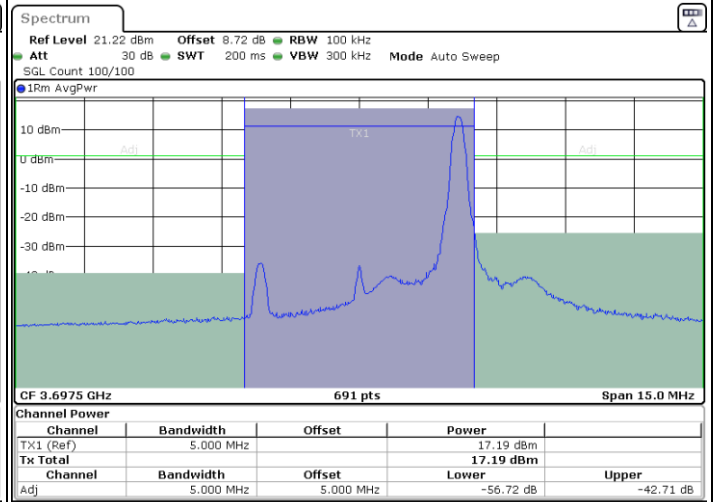

Date: 1. JAN. 2025 20:13:36

Highest Channel / FullRB

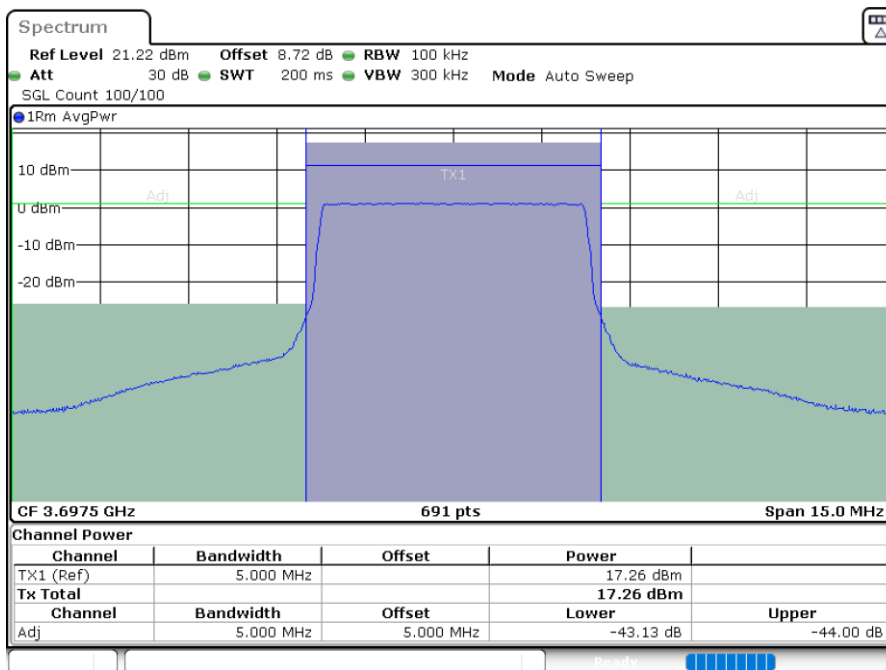

Date: 1. JAN. 2025 20:16:43



LTE Band 48 / 10MHz

QPSK

Lowest Channel / 1RB0

Lowest Channel / 1RBmax

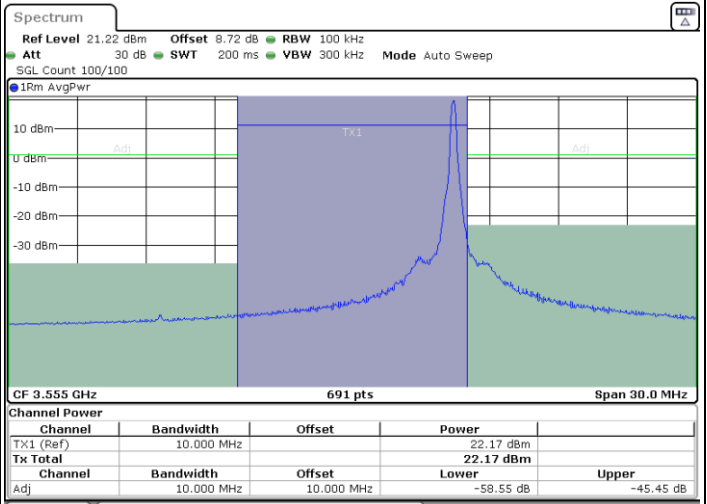
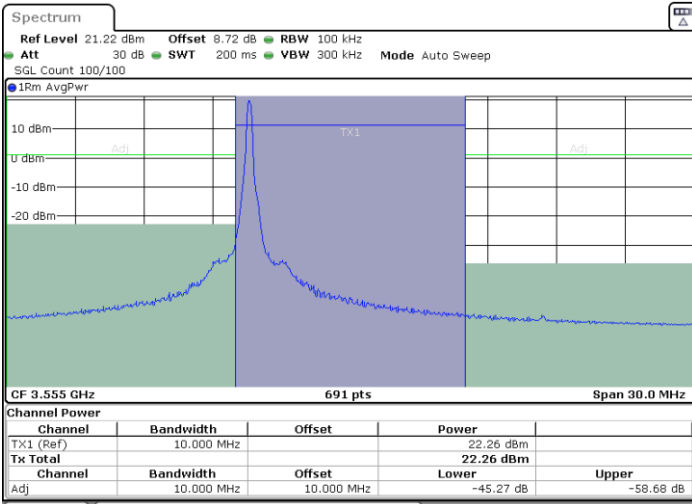

Date: 1. JAN. 2025 20:18:13

Date: 1. JAN. 2025 20:21:18

Lowest Channel / FullIRB

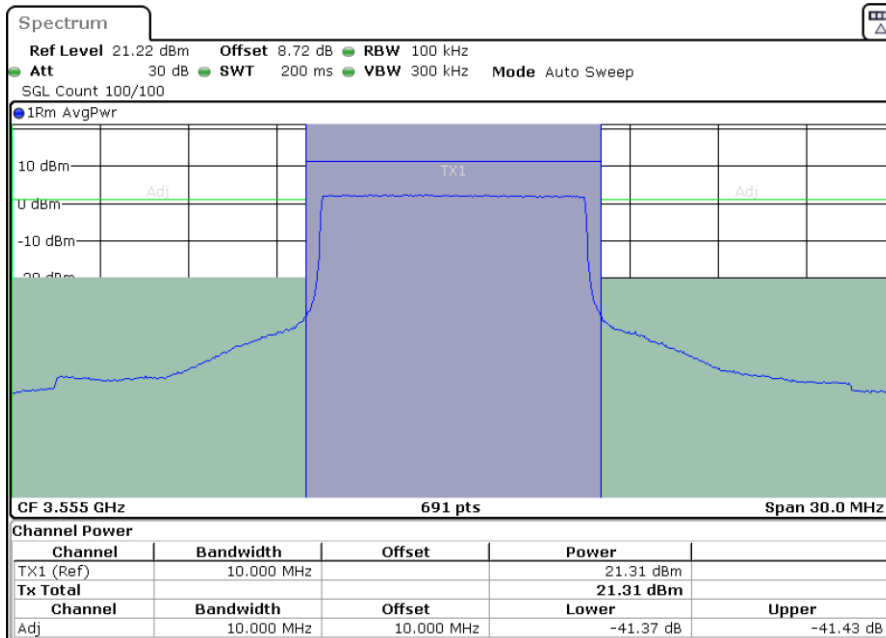

Date: 1. JAN. 2025 20:24:24



LTE Band 48 / 10MHz

QPSK

Middle Channel / 1RB0

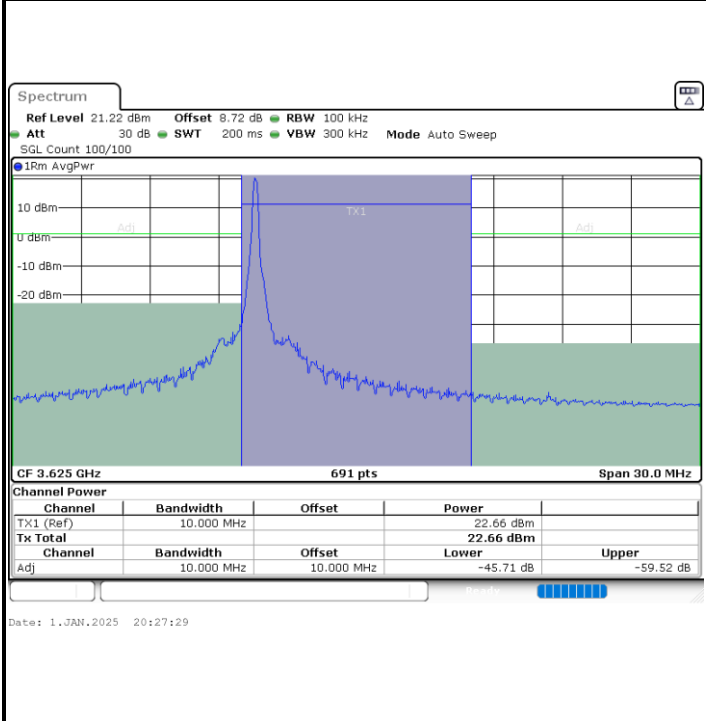

Middle Channel / 1RBmax

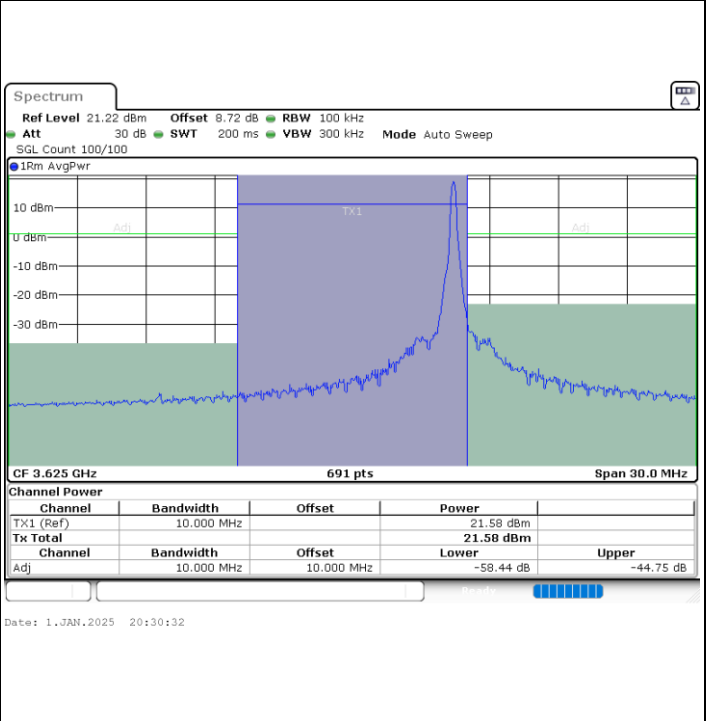

Middle Channel / FullRB

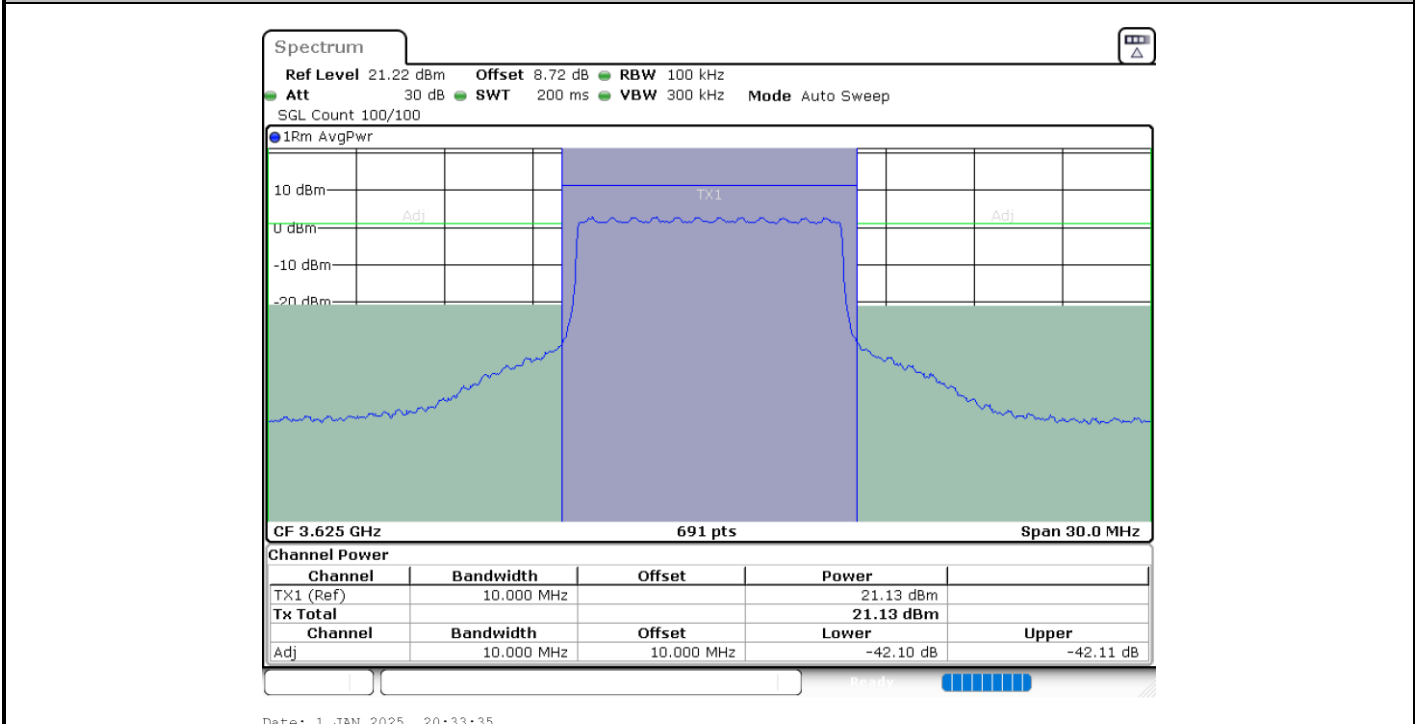



LTE Band 48 / 10MHz

QPSK

Highest Channel / 1RB0

Highest Channel / 1RBmax

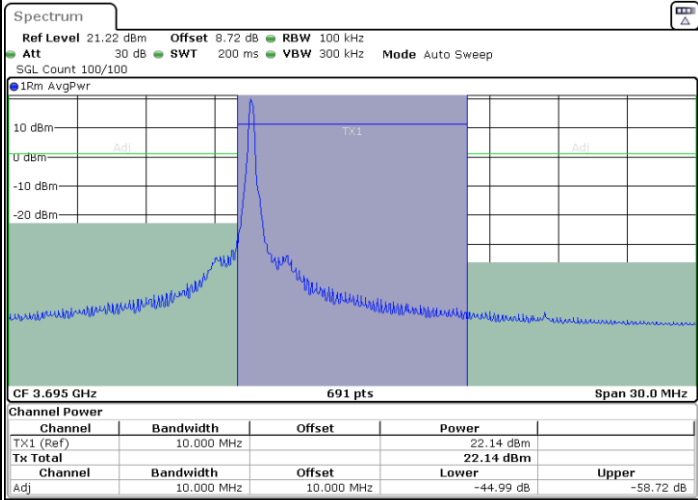

Date: 1. JAN. 2025 20:36:58

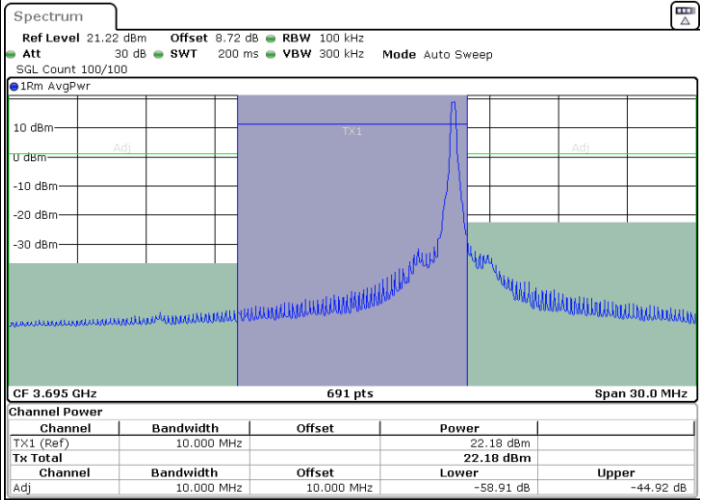

Date: 1. JAN. 2025 20:40:07

Highest Channel / FullRB

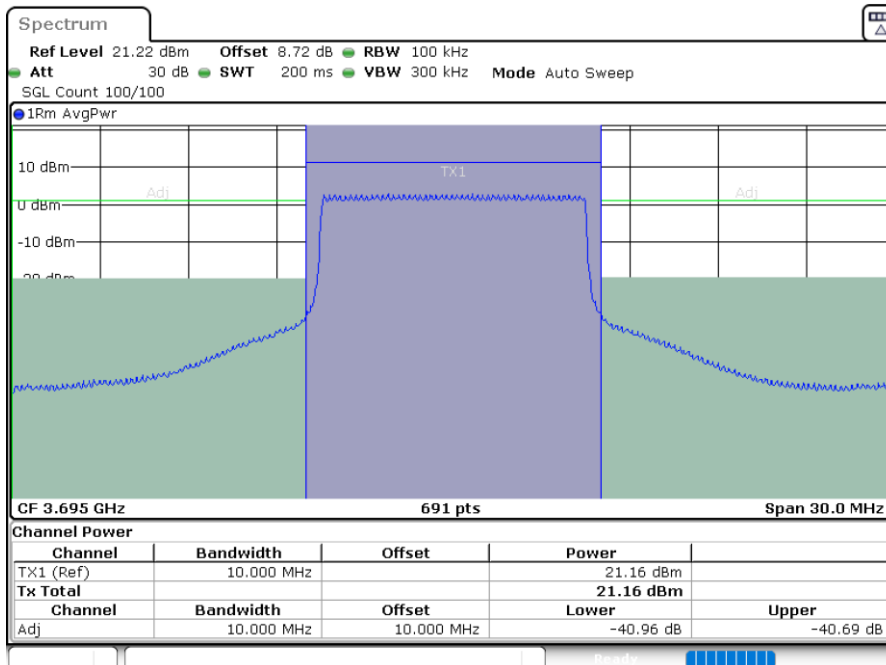

Date: 1. JAN. 2025 20:43:15



LTE Band 48 / 10MHz

16QAM

Lowest Channel / 1RB0

Lowest Channel / 1RBmax

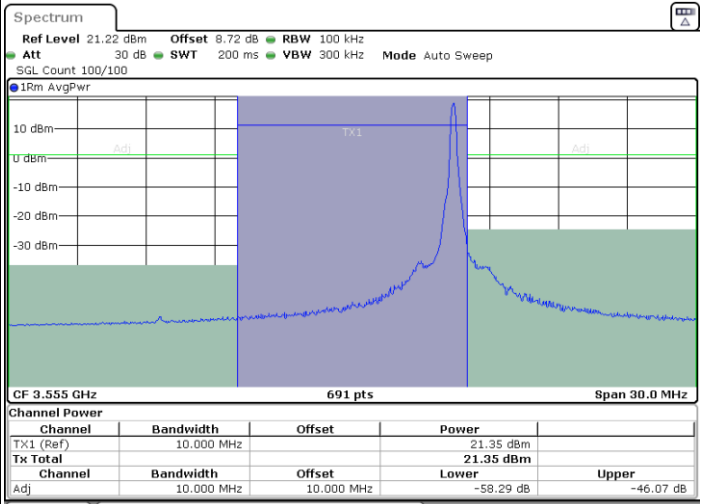
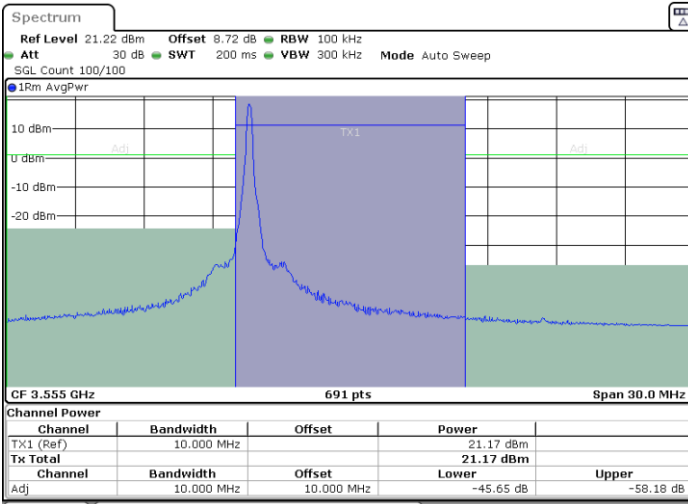

Date: 1. JAN. 2025 20:18:59

Date: 1. JAN. 2025 20:22:05

Lowest Channel / FullRB

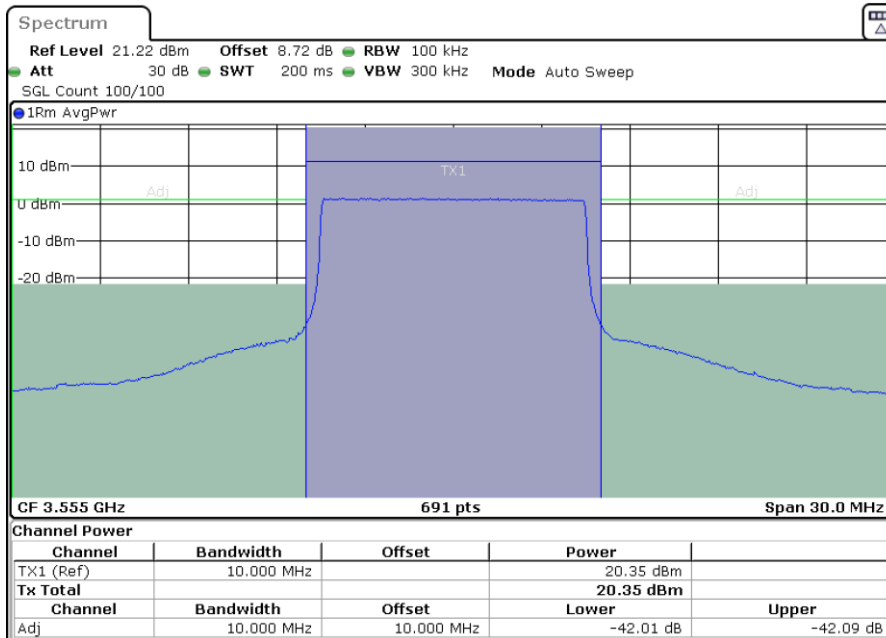

Date: 1. JAN. 2025 20:25:10



LTE Band 48 / 10MHz

16QAM

Middle Channel / 1RB0

Middle Channel / 1RBmax

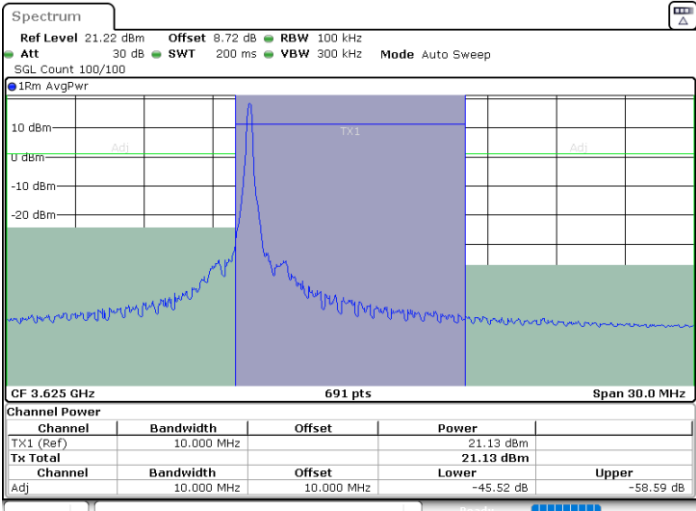

Date: 1.JAN.2025 20:28:14

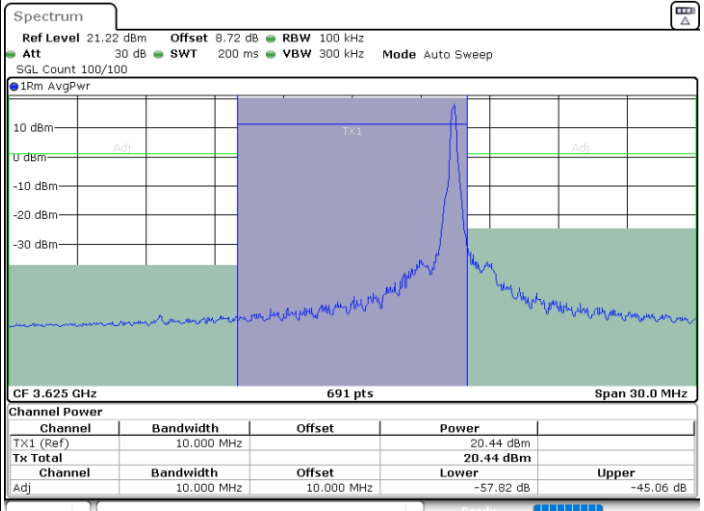

Date: 1.JAN.2025 20:31:18

Middle Channel / FullRB

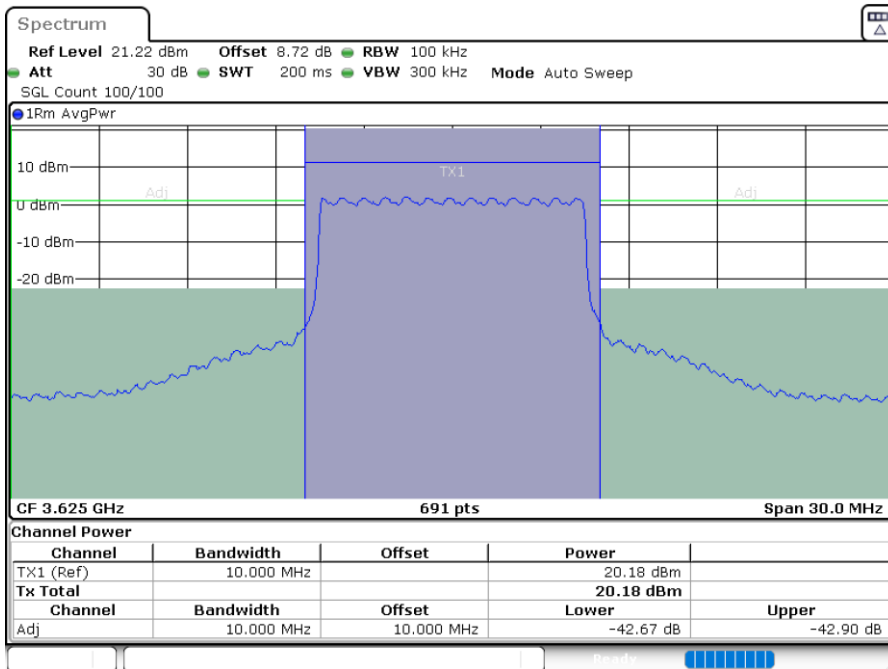

Date: 1.JAN.2025 20:34:40



LTE Band 48 / 10MHz

16QAM

Highest Channel / 1RB0

Highest Channel / 1RBmax

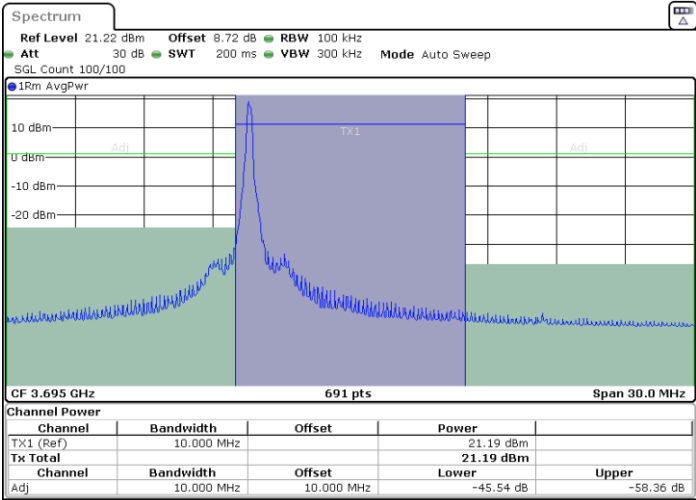

Date: 1. JAN. 2025 20:37:45

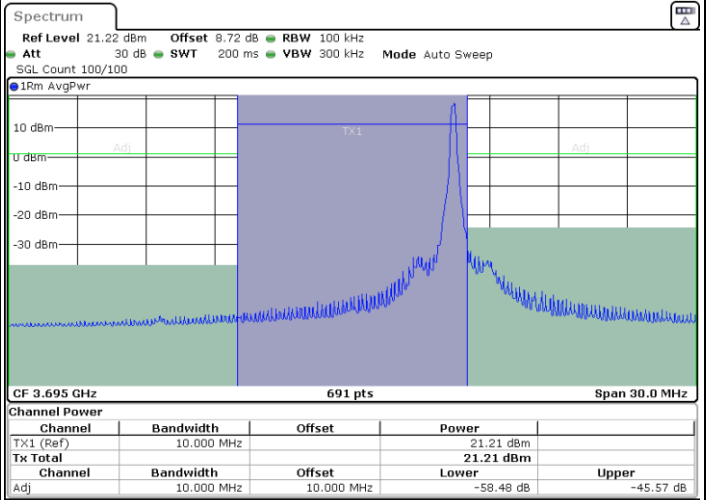

Date: 1. JAN. 2025 20:40:54

Highest Channel / FullRB

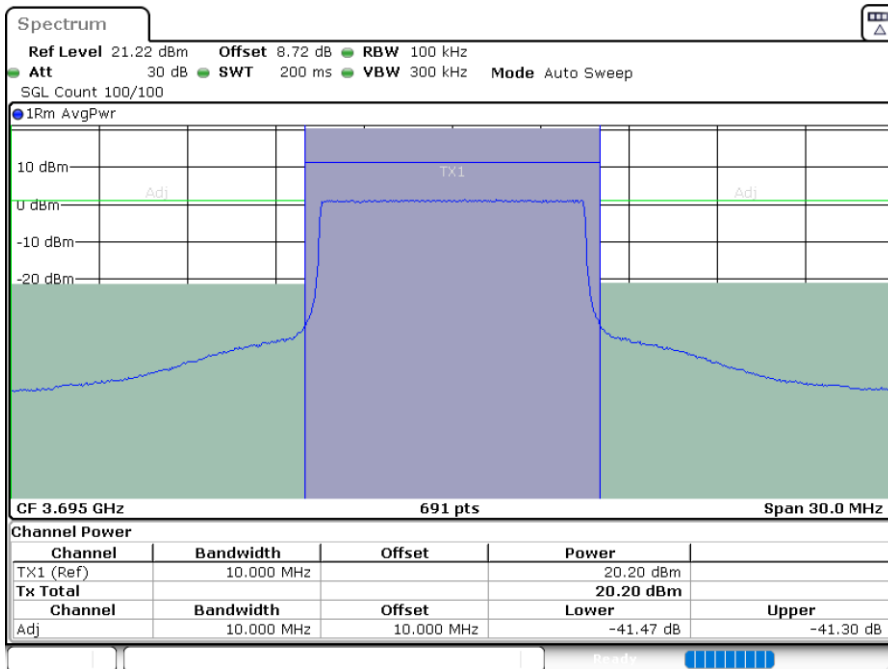

Date: 1. JAN. 2025 20:44:02



LTE Band 48 / 10MHz

64QAM

Lowest Channel / 1RB0

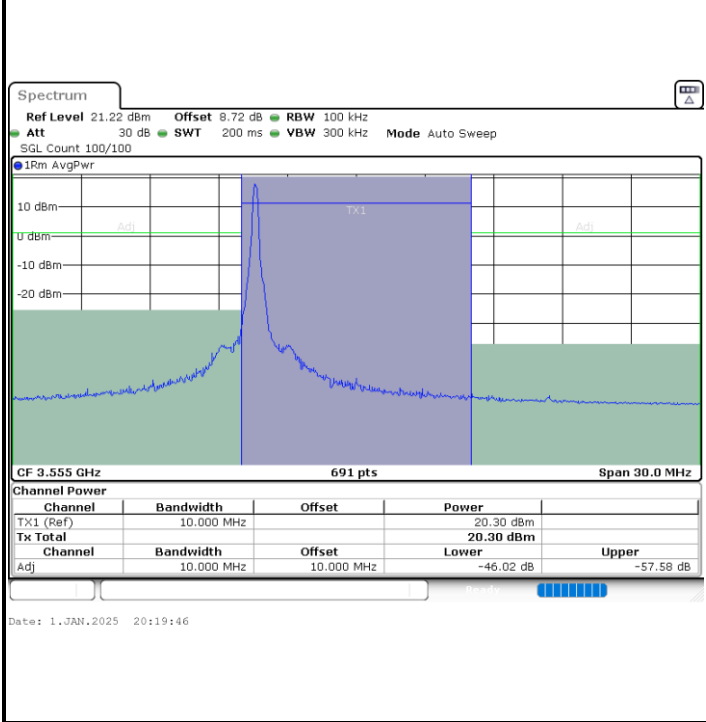

Lowest Channel / 1RBmax

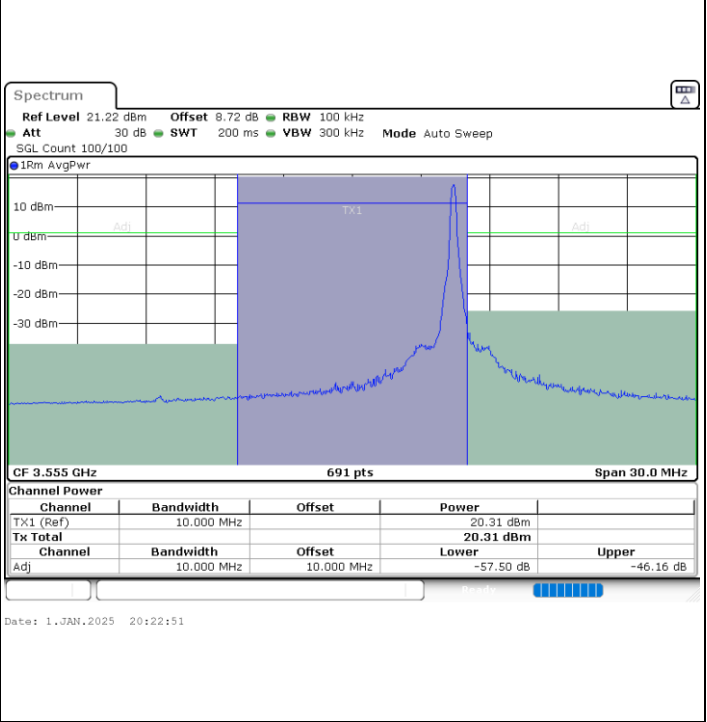

Lowest Channel / FullRB

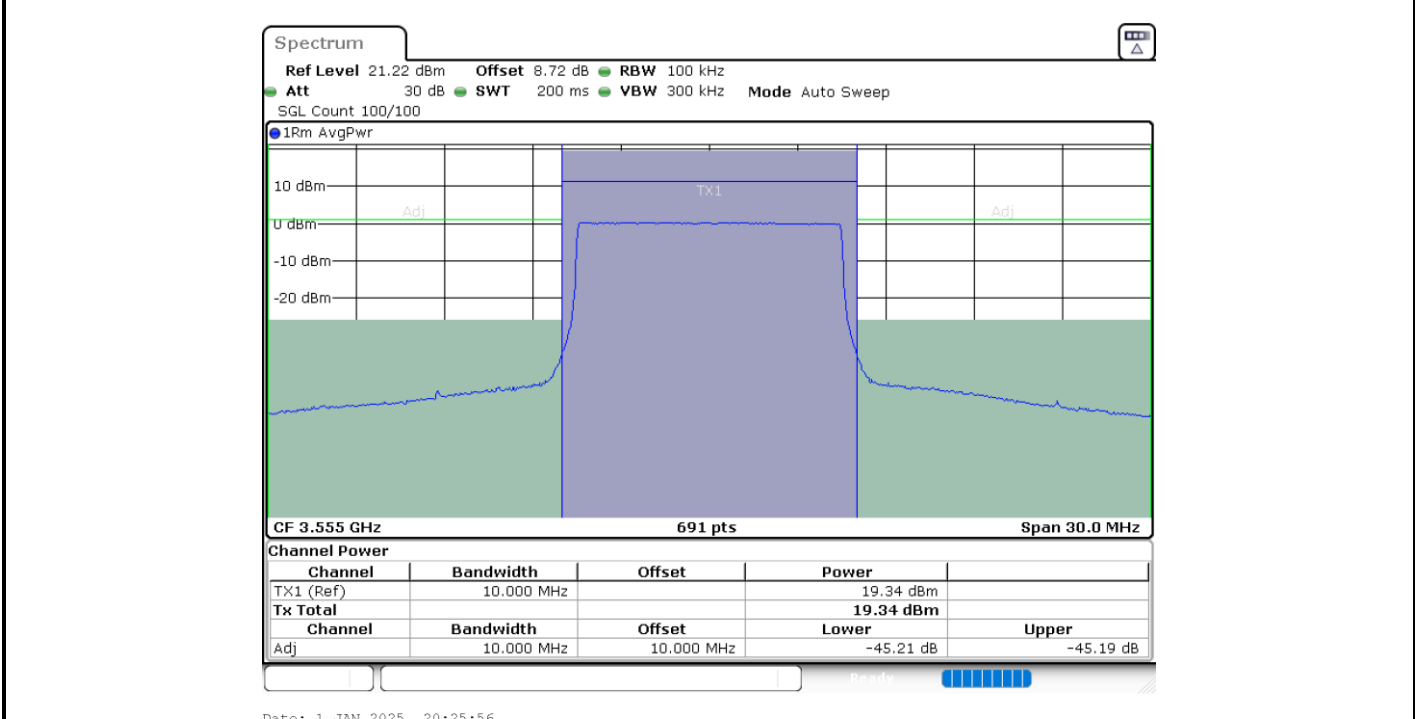



LTE Band 48 / 10MHz

64QAM

Middle Channel / 1RB0

Middle Channel / 1RBmax

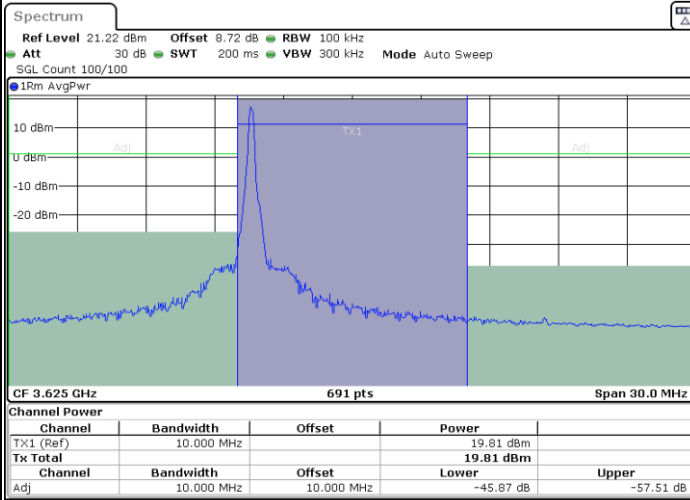

Date: 1. JAN. 2025 20:29:00

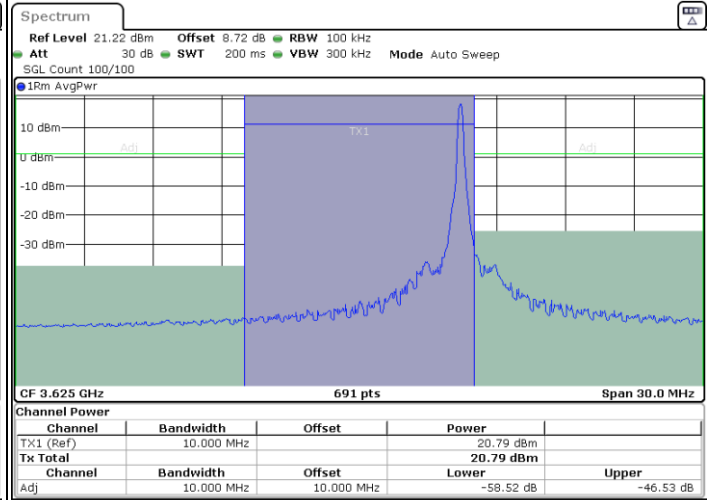

Date: 1. JAN. 2025 20:32:04

Middle Channel / FullRB

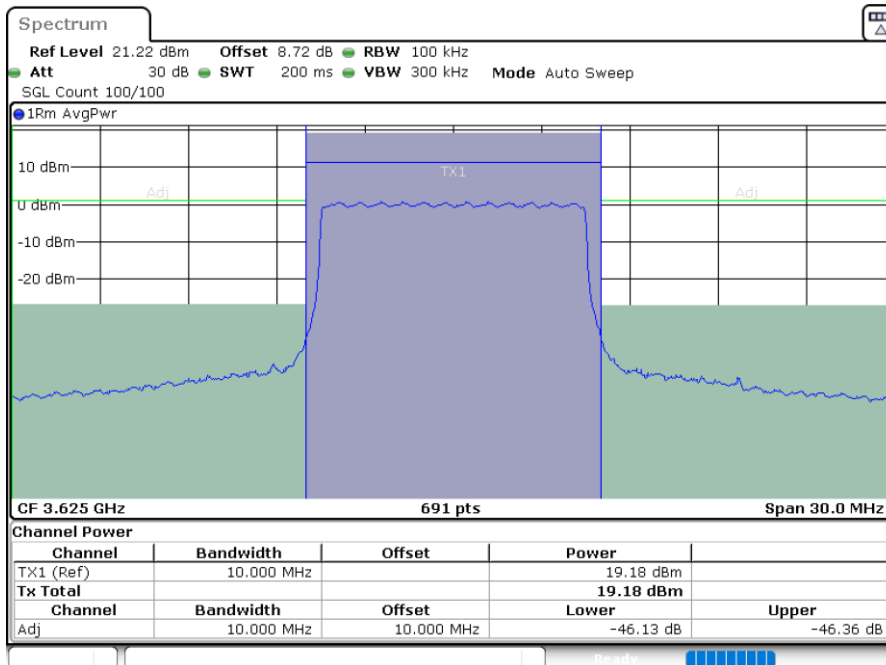

Date: 1. JAN. 2025 20:35:26



LTE Band 48 / 10MHz

64QAM

Highest Channel / 1RB0

Highest Channel / 1RBmax

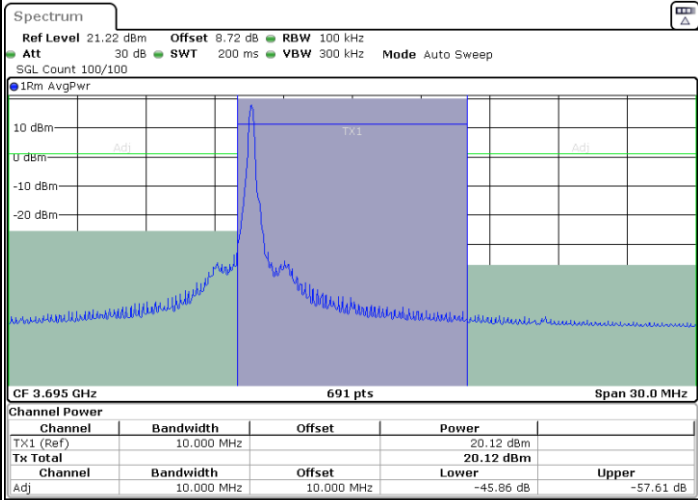

Date: 1. JAN. 2025 20:38:33

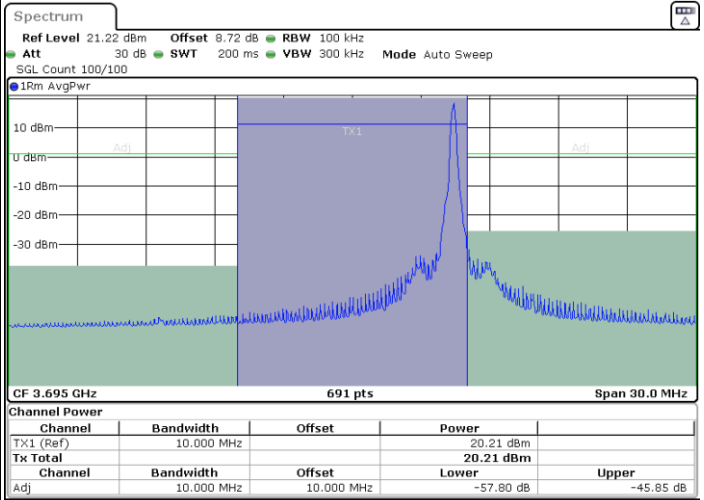

Date: 1. JAN. 2025 20:41:41

Highest Channel / FullRB

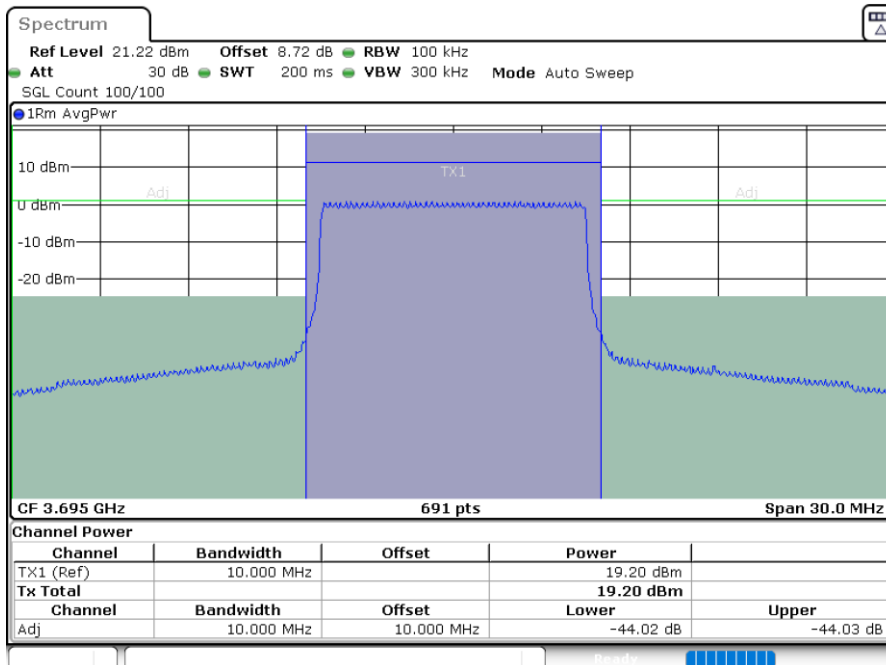

Date: 1. JAN. 2025 20:44:50



LTE Band 48 / 10MHz

256QAM

Lowest Channel / 1RB0

Lowest Channel / 1RBmax

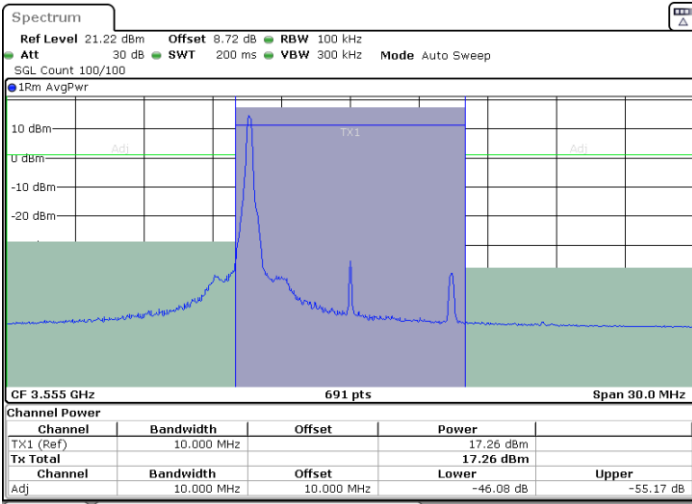

Date: 1. JAN. 2025 20:20:32

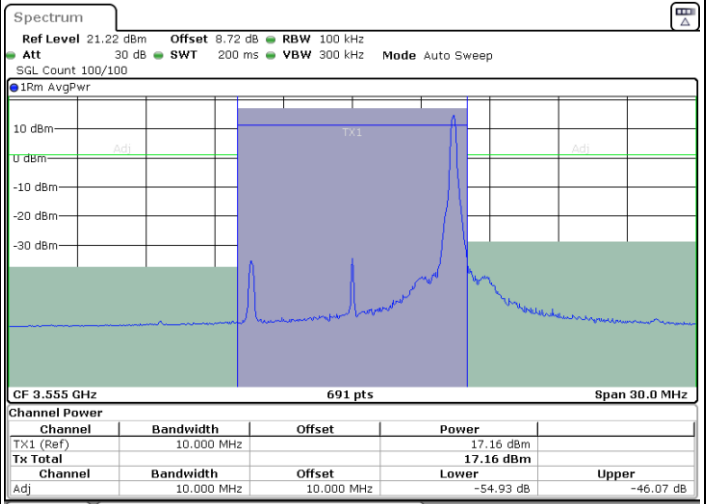

Date: 1. JAN. 2025 20:23:37

Lowest Channel / FullRB

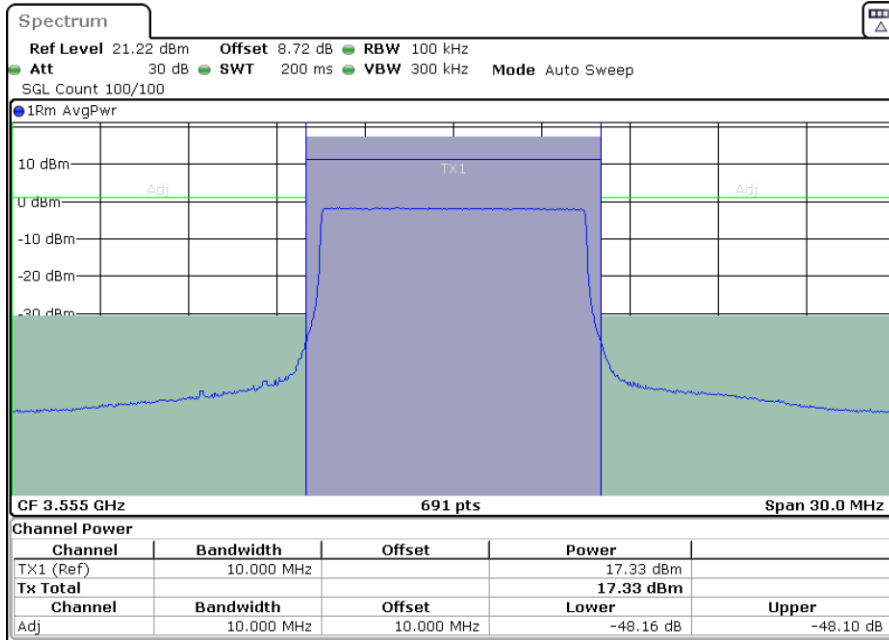

Date: 1. JAN. 2025 20:26:42



LTE Band 48 / 10MHz

256QAM

Middle Channel / 1RB0

Middle Channel / 1RBmax

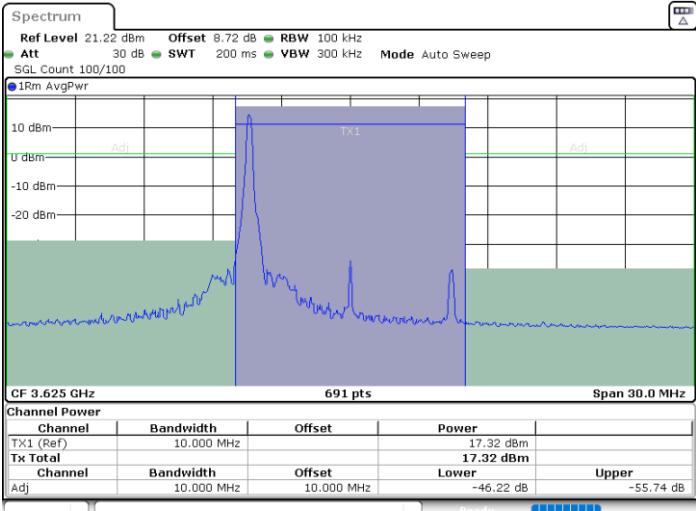

Date: 1. JAN. 2025 20:29:46

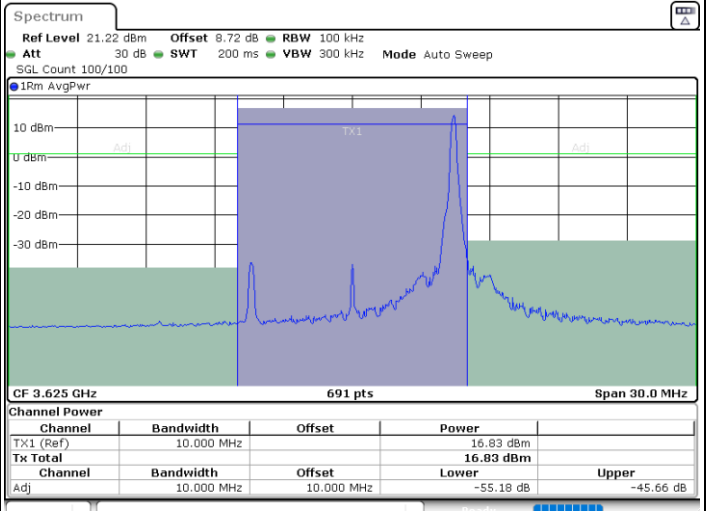

Date: 1. JAN. 2025 20:32:49

Middle Channel / FullRB

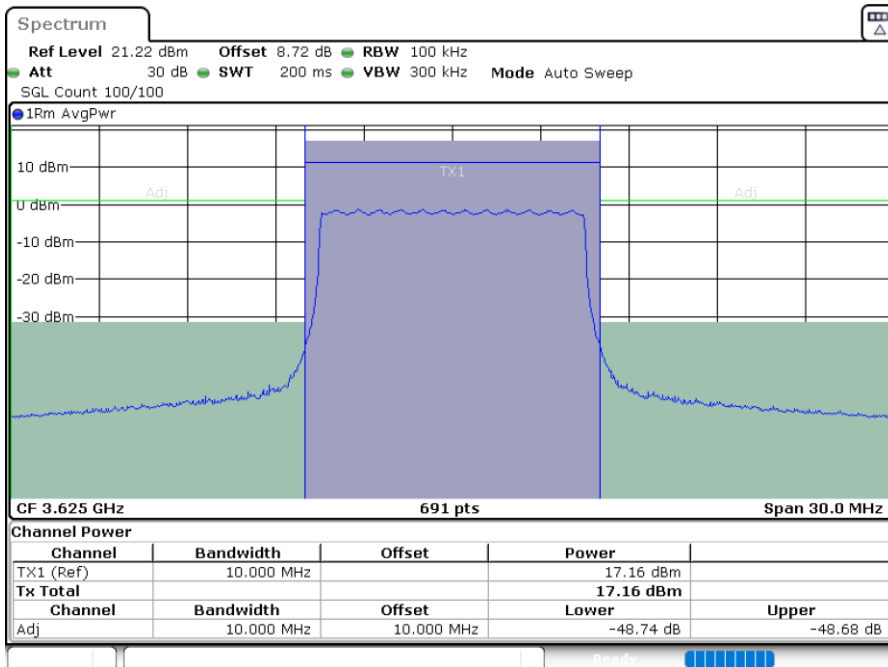

Date: 1. JAN. 2025 20:36:12



LTE Band 48 / 10MHz

256QAM

Highest Channel / 1RB0

Highest Channel / 1RBmax

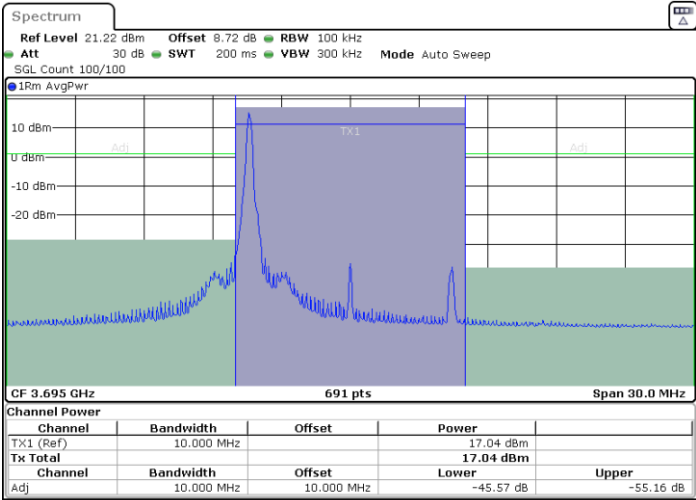

Date: 1. JAN. 2025 20:39:20

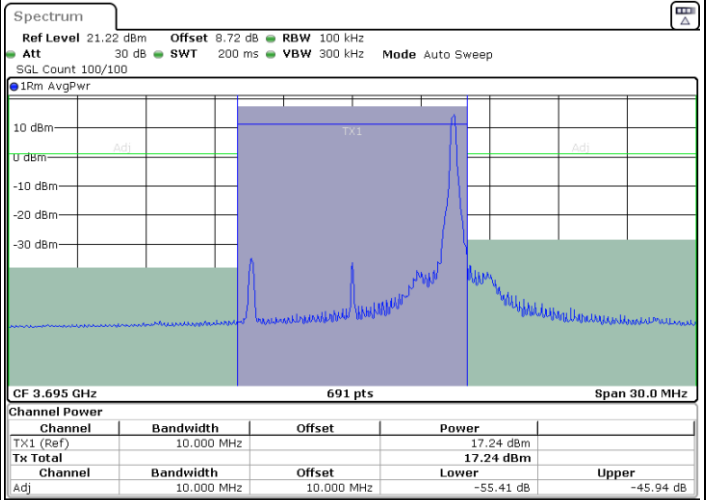

Date: 1. JAN. 2025 20:42:28

Highest Channel / FullRB

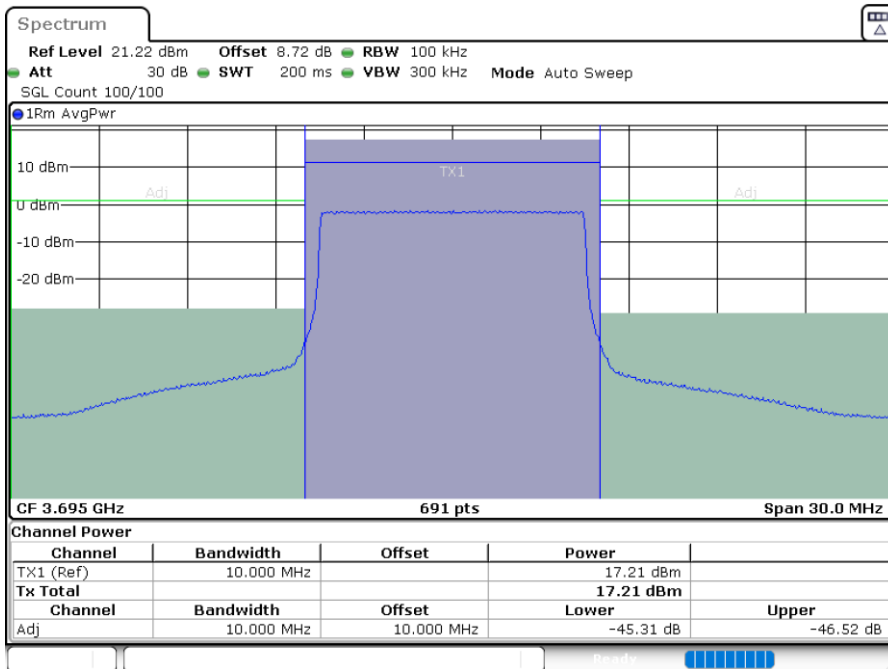

Date: 1. JAN. 2025 20:45:37



LTE Band 48 / 15MHz

QPSK

Lowest Channel / 1RB0

Lowest Channel / 1RBmax

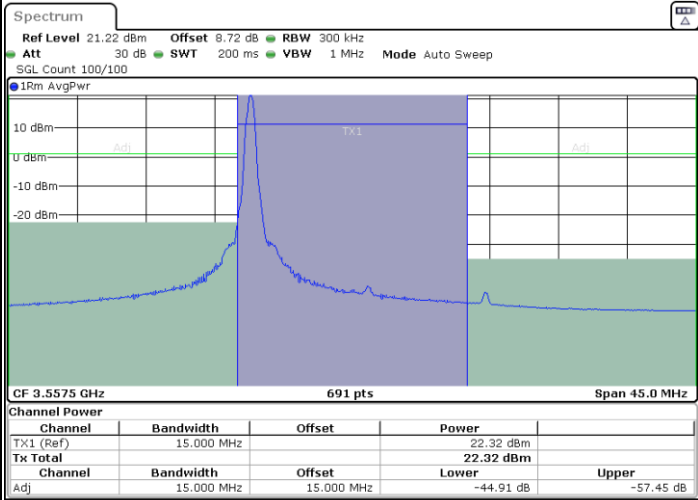

Date: 1. JAN. 2025 20:47:05

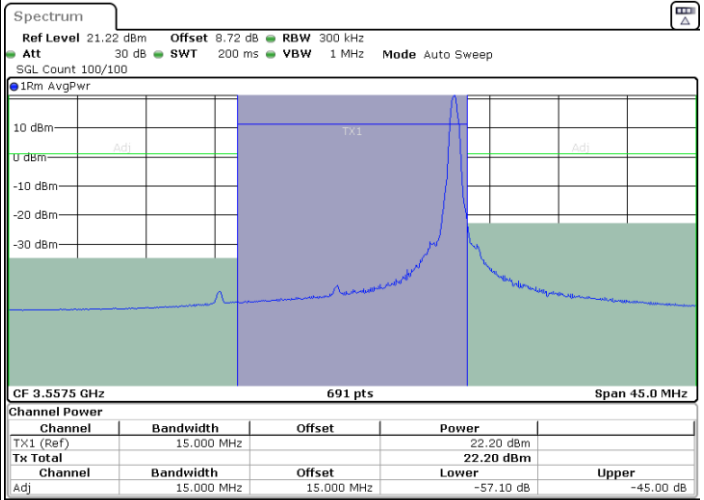

Date: 1. JAN. 2025 20:50:08

Lowest Channel / FullRB

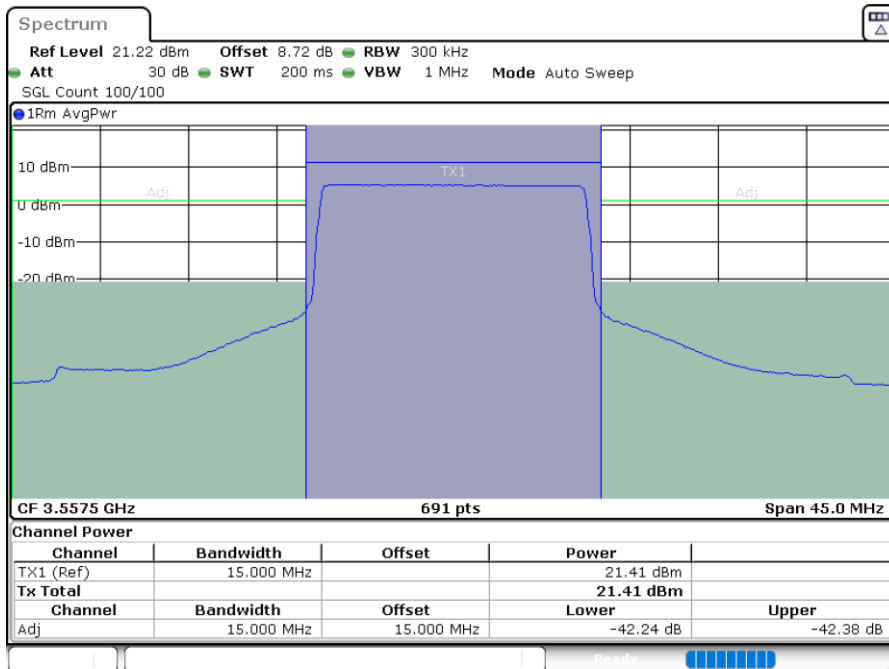

Date: 1. JAN. 2025 20:53:11



LTE Band 48 / 15MHz

QPSK

Middle Channel / 1RB0

Middle Channel / 1RBmax

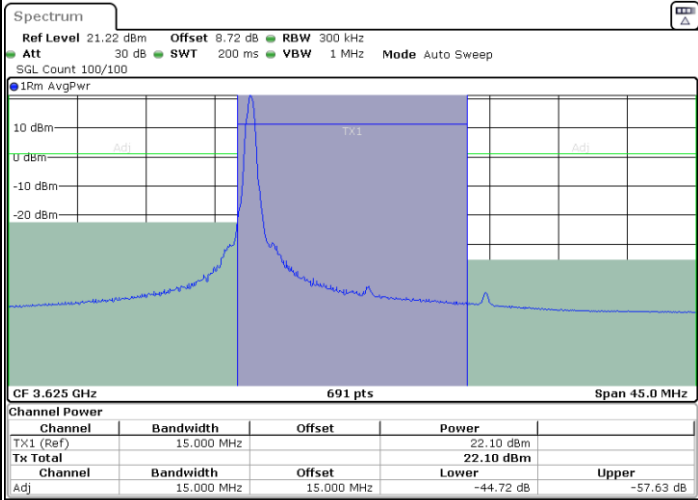

Date: 1.JAN.2025 20:56:17

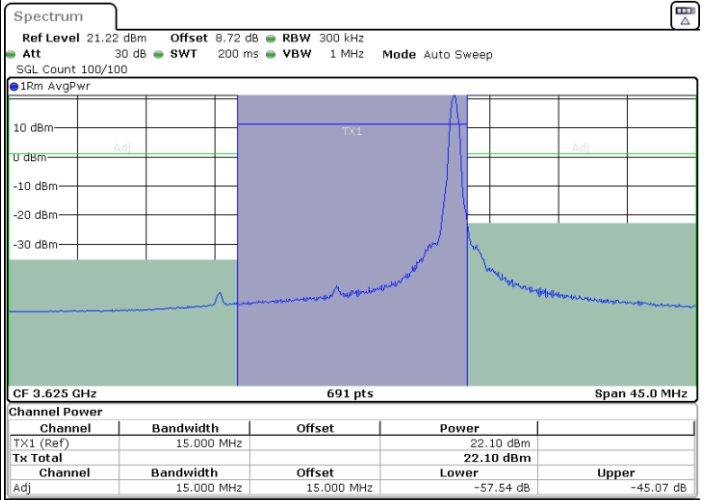

Date: 1.JAN.2025 20:59:17

Middle Channel / FullRB

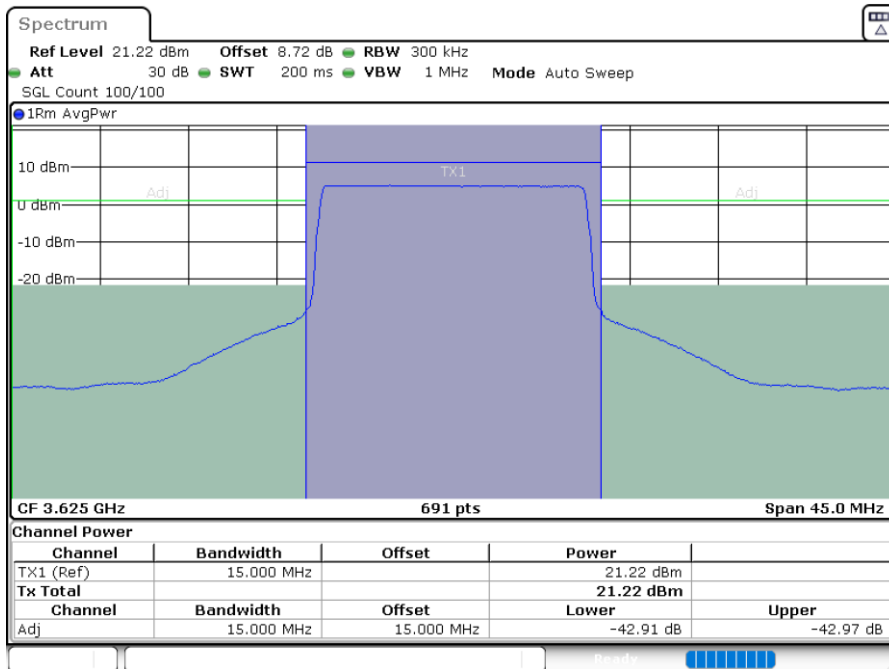

Date: 1.JAN.2025 21:02:17



LTE Band 48 / 15MHz

QPSK

Highest Channel / 1RB0

Highest Channel / 1RBmax

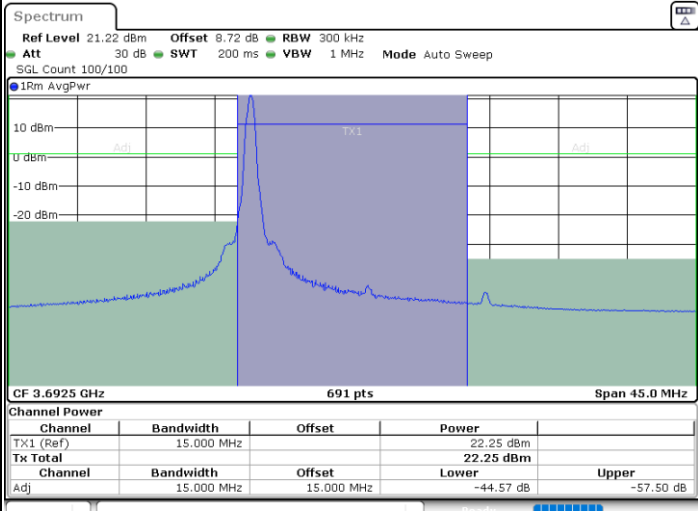

Date: 1. JAN. 2025 21:05:17

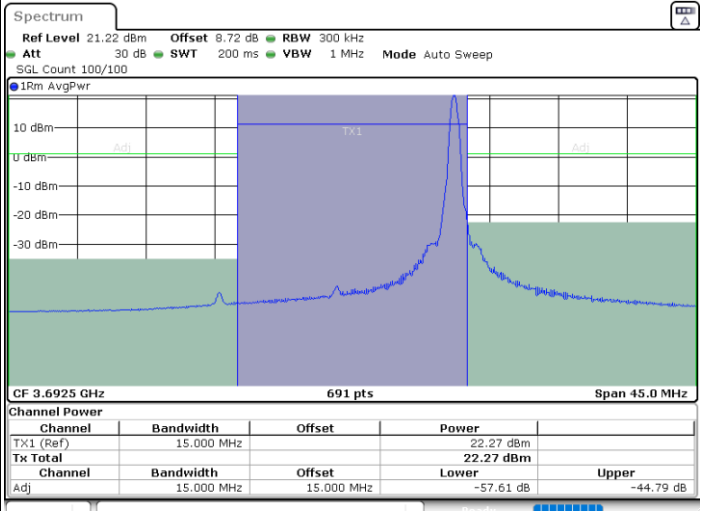

Date: 1. JAN. 2025 21:08:19

Highest Channel / FullRB

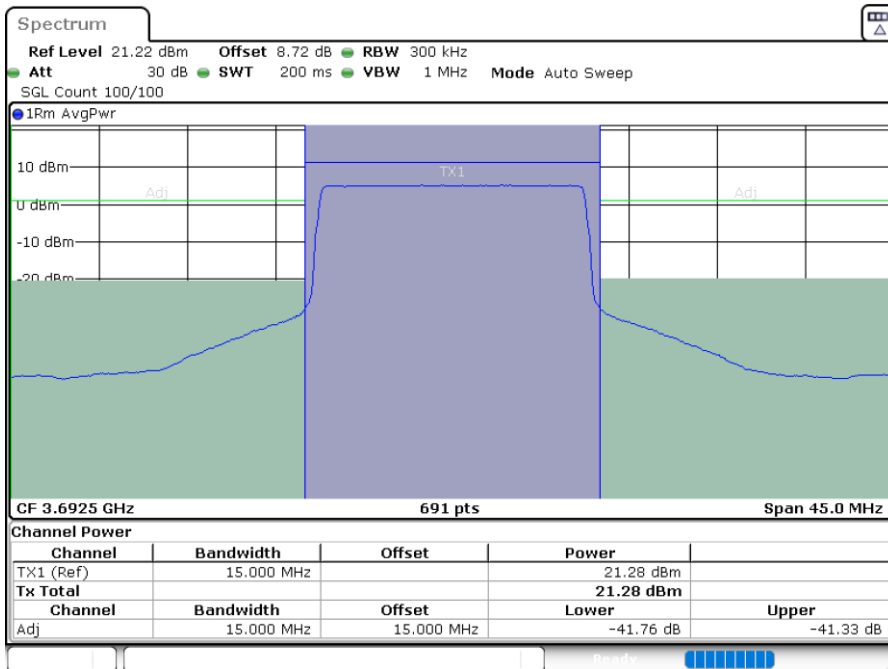

Date: 1. JAN. 2025 21:11:22