



# FCC RF Test Report

**APPLICANT** : Motorola Mobility LLC  
**EQUIPMENT** : Mobile Cellular Phone  
**BRAND NAME** : Motorola  
**MODEL NAME** : XT2513-1, XT2513-2, XT2513-3, XT2513V  
**FCC ID** : IHDT56AT9  
**STANDARD** : FCC Part 15 Subpart C §15.225  
**CLASSIFICATION** : (DXX) Low Power Communication Device Transmitter  
**TEST DATE(S)** : Aug. 30, 2024 ~ Sep. 10, 2024

We, Sporton International Inc. (Shenzhen), would like to declare that the tested sample has been evaluated in accordance with the test procedures and has been in compliance with the applicable technical standards.

The test results in this report apply exclusively to the tested model / sample. Without written approval of Sporton International Inc. (Shenzhen), the test report shall not be reproduced except in full.

Jason Jia



Approved by: Jason Jia

**Sporton International Inc. (ShenZhen)**

**1/F, 2/F, Bldg 5, Shiling Industrial Zone, Xinwei Village, Xili, Nanshan, Shenzhen, 518055**

**People's Republic of China**



# TABLE OF CONTENTS

**TABLE OF CONTENTS** .....2

**REVISION HISTORY** .....3

**SUMMARY OF THE TEST RESULT** .....4

**1. GENERAL DESCRIPTION** .....5

    1.1 Applicant..... 5

    1.2 Manufacturer ..... 5

    1.3 Product Feature of Equipment Under Test ..... 5

    1.4 Product Specification of Equipment Under Test ..... 5

    1.5 Modification of EUT ..... 5

    1.6 Testing Location ..... 6

    1.7 Test Software ..... 6

    1.8 Applicable Standards..... 7

    1.9 Specification of Accessory..... 7

**2. TEST CONFIGURATION OF EQUIPMENT UNDER TEST** .....8

    2.1 Descriptions of Test Mode ..... 8

    2.2 Connection Diagram of Test System ..... 9

    2.3 Table for Supporting Units ..... 10

    2.4 EUT Operation Test Setup ..... 10

**3. TEST RESULTS**.....11

    3.1 AC Power Line Conducted Emissions Measurement ..... 11

    3.2 20dB and 99% OBW Spectrum Bandwidth Measurement..... 13

    3.3 Frequency Stability Measurement ..... 14

    3.4 Field Strength of Fundamental Emissions and Mask Measurement..... 15

    3.5 Radiated Emissions Measurement ..... 17

    3.6 Antenna Requirements..... 20

**4. LIST OF MEASURING EQUIPMENT** .....21

**5. UNCERTAINTY OF EVALUATION** .....22

**APPENDIX A. TEST RESULTS OF CONDUCTED EMISSION TEST**

**APPENDIX B. TEST RESULTS OF CONDUCTED TEST ITEMS**

    B1. Test Result of 20dB Spectrum Bandwidth

    B2. Test Result of Frequency Stability

**APPENDIX C. TEST RESULTS OF RADIATED TEST ITEMS**

    C2 Test Result of Field Strength of Fundamental Emissions

    C2. Results of Radiated Emissions (9 kHz~30MHz)

    C3. Results of Radiated Emissions (30MHz~1GHz)

**APPENDIX D. SETUP PHOTOGRAPHS**





### SUMMARY OF THE TEST RESULT

Report Section	FCC Rule	Description of Test	Result	Remark
3.1	15.207	AC Power Line Conducted Emissions	Complies	Under limit 8.71 dB at 0.53MHz
3.2	15.215(c)	20dB Spectrum Bandwidth	Complies	-
	-	99% OBW Spectrum Bandwidth	Complies	-
3.3	15.225(e)	Frequency Stability	Complies	-
3.4	15.225(a)(b)(c)	Field Strength of Fundamental Emissions	Complies	Max level 17.65 dBµV/m at 13.56 MHz @30m
3.5	15.225(d) & 15.209	Radiated Spurious Emissions	Complies	Under limit 4.87 dB at 40.67MHz
3.6	15.203	Antenna Requirements	Complies	-

**Conformity Assessment Condition:**

1. The test results (PASS/FAIL) with all measurement uncertainty excluded are presented against the regulation limits or in accordance with the requirements stipulated by the applicant/manufacturer who shall bear all the risks of non-compliance that may potentially occur if measurement uncertainty is taken into account.
2. The measurement uncertainty please refer to each test result in the section "Measurement Uncertainty"

**Disclaimer:**

The product specifications of the EUT presented in the test report that may affect the test assessments are declared by the manufacturer who shall take full responsibility for the authenticity.



# 1. General Description

## 1.1 Applicant

Motorola Mobility LLC  
222 W,Merchandise Mart Plaza, Chicago IL 60654 USA

## 1.2 Manufacturer

Motorola Mobility LLC  
222 W,Merchandise Mart Plaza, Chicago IL 60654 USA

## 1.3 Product Feature of Equipment Under Test

Product Feature	
Equipment	Mobile Cellular Phone
Brand Name	Motorola
Model Name	XT2513-1, XT2513-2, XT2513-3, XT2513V
FCC ID	IHDT56AT9
IMEI Code	Conducted: 352291420070137/352291420070145 Conduction: 352291420056433/352291420056441 Radiation: 35229140054834/352291420054842
HW Version	DVT2
SW Version	VVK35.48
EUT Stage	Identical Prototype

Remark: The above EUT's information was declared by manufacturer. Please refer to the specifications or user's manual for more detailed description.

## 1.4 Product Specification of Equipment Under Test

Standards-related Product Specification	
Tx/Rx Frequency Range	13.553 ~ 13.567MHz
Channel Number	1
20dBW	2.577 KHz
99%OBW	2.188 KHz
Antenna Type	loop Antenna
Type of Modulation	ASK

## 1.5 Modification of EUT

No modifications are made to the EUT during all test items.



### 1.6 Testing Location

Sporton International Inc. (ShenZhen) is accredited to ISO/IEC 17025:2017 by American Association for Laboratory Accreditation with Certificate Number 5145.01.

<b>Test Firm</b>	Sporton International Inc. (ShenZhen)		
<b>Test Site Location</b>	1/F, 2/F, Bldg 5, Shiling Industrial Zone, Xinwei Village, Xili, Nanshan, Shenzhen, 518055 People's Republic of China TEL: +86-755-86379589 FAX: +86-755-86379595		
<b>Test Site No.</b>	<b>Sporton Site No.</b>		<b>FCC Designation No.</b>
	TH01-SZ	CO01-SZ	
<b>Test Engineer</b>	Jason Zhang	Chase Nathon	CN1256
<b>Temperature</b>	24~26°C	22~24°C	
<b>Relative Humidity</b>	50~53%	44~50%	
			421272

<b>Test Firm</b>	Sporton International Inc. (ShenZhen)		
<b>Test Site Location</b>	101, 1st Floor, Block B, Building 1, No. 2, Tengfeng 4th Road, Fenghuang Community, Fuyong Street, Baoan District, Shenzhen City, Guangdong Province 518103 People's Republic of China TEL: +86-755-86066985		
<b>Test Site No.</b>	<b>Sporton Site No.</b>		<b>FCC Designation No.</b>
	03CH05-SZ		
<b>Test Engineer</b>	ZhanShengLiu		CN1256
<b>Temperature</b>	23~25°C		
<b>Relative Humidity</b>	48~52%		
			421272

### 1.7 Test Software

Item	Site	Manufacturer	Name	Version
1.	03CH05-SZ	AUDIX	E3	6.2009-8-24
2.	CO01-SZ	AUDIX	E3	6.120613b



### 1.8 Applicable Standards

According to the specifications of the manufacturer, the EUT must comply with the requirements of the following standards:

- ♦ 47 CFR Part 15 Subpart C §15.225
- ♦ ANSI C63.10-2013

### 1.9 Specification of Accessory

Specification of Accessory				
AC Adapter 1	Brand Name	Motorola(AOHAI)	Model Name	MC-201L
AC Adapter 2	Brand Name	Motorola(Salcomp)	Model Name	MC-201L
USB Cable 1	Brand Name	Motorola(WASHIN)	Model Name	HX-TL-04
USB Cable 2	Brand Name	Motorola(SAIBAO)	Model Name	STN-A131A
USB Cable 3	Brand Name	Motorola(WASHIN)	Model Name	HX-TL-07
USB Cable 4	Brand Name	Motorola(SAIBAO)	Model Name	STN-A132A
Battery 1	Brand Name	Motorola(CosMX)	Model Name	RA50
Battery 2	Brand Name	Motorola(ATL)	Model Name	RA50



## 2. Test Configuration of Equipment Under Test

### 2.1 Descriptions of Test Mode

Investigation has been done on all the possible configurations.

The following table is a list of the test modes shown in this test report.

Test Items	
AC Power Line Conducted Emissions	Field Strength of Fundamental Emissions
20dB Spectrum Bandwidth	Frequency Stability
Radiated Emissions 9kHz~30MHz	Radiated Emissions 30MHz~1GHz

The EUT pre-scanned in four NFC type, A, B, F, V. The worst type (type F) was recorded in this report. Pre-scanned tests, X, Y, Z in three orthogonal panels to determine the final configuration (Z plane as worst plane) from all possible combinations.

Test Cases	
<b>AC Conducted Emission</b>	Mode 1: GSM 850 Idle + WLAN Link(2.4G) + NFC TX + Adapter 1 + USB Cable + Battery 1 + Earphone
<b>Remark:</b> For Radiated Test Cases, The tests were performance with Adapter 1, Earphone and USB Cable 1 .	

## 2.2 Connection Diagram of Test System

<Radiated Emission >

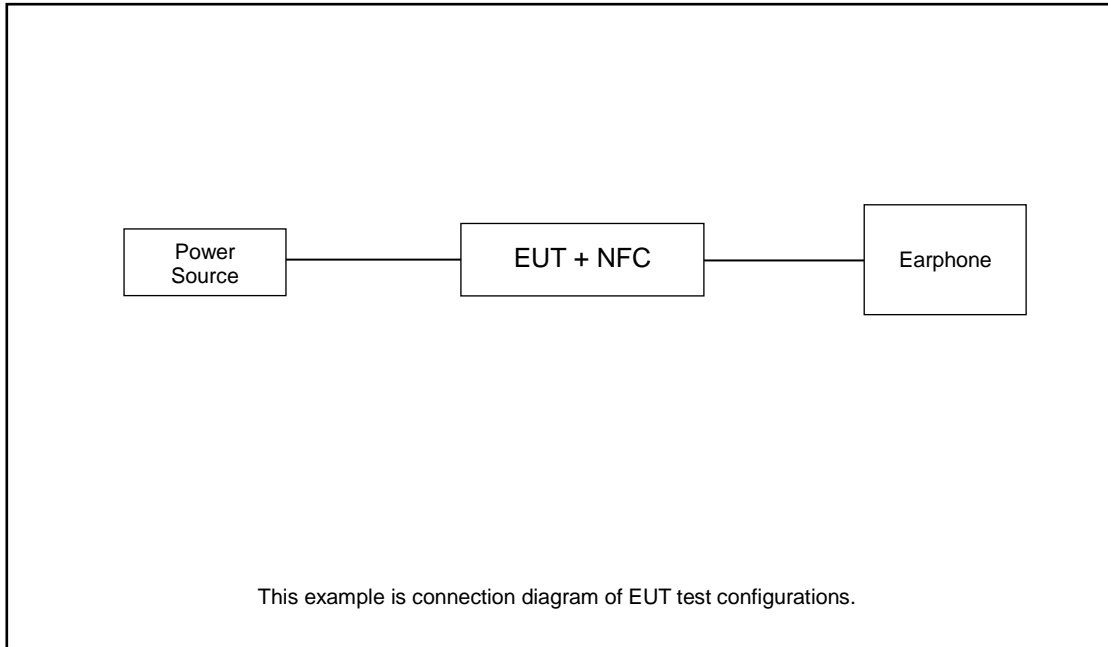

< AC Conducted Emission >

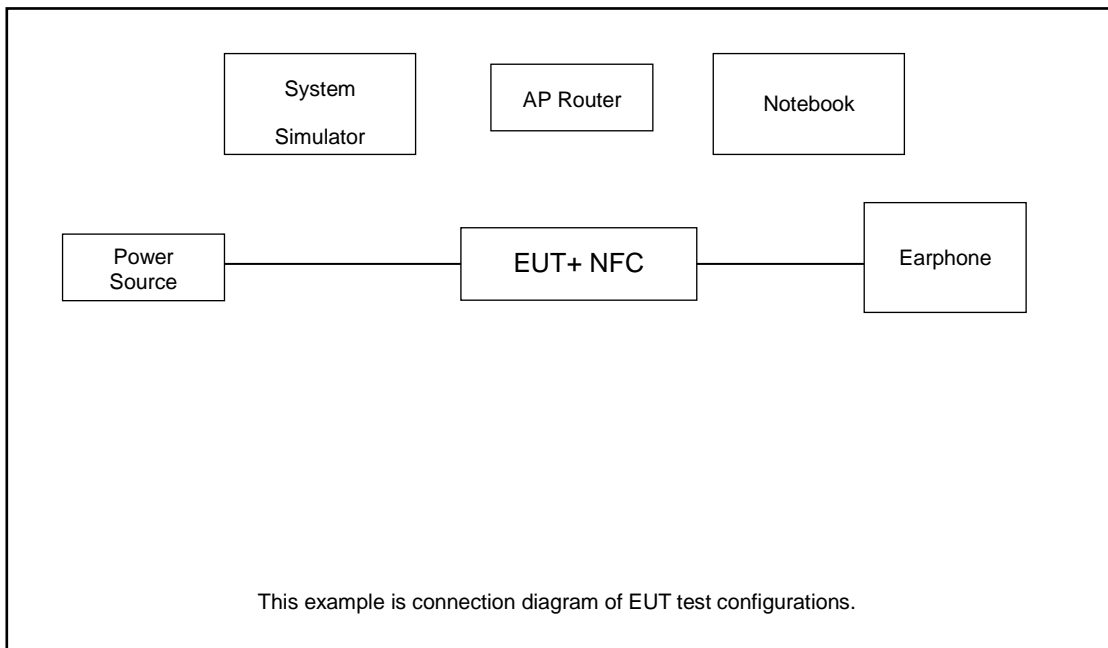



### 2.3 Table for Supporting Units

Item	Equipment	Trade Name	Model Name	FCC ID	Data Cable	Power Cord
1.	Base Station	Anritsu	MT8820C	N/A	N/A	Unshielded,1.8m
2.	Earphone	apple	N/A	N/A	N/A	N/A
3.	NOTE BOOK	Lenovo	E540	FCC DoC	N/A	AC I/P : Unshielded, 1.2m DC O/P : Shielded, 1.8m
4.	WLAN AP	Dlink	DIR-820L	KA2IR820LA1	N/A	Unshielded,1.8m
5.	NFC Card	N/A	N/A	N/A	N/A	N/A

### 2.4 EUT Operation Test Setup

The EUT was programmed to be in continuously transmitting mode.

The ancillary equipment, NFC card, is used to make the EUT (NFC) continuously transmit at 13.56MHz and is placed around 0 cm gap to the EUT.

### 3. Test Results

#### 3.1 AC Power Line Conducted Emissions Measurement

##### 3.1.1 Limit of AC Conducted Emission

For equipment that is designed to be connected to the public utility (AC) power line, the radio frequency voltage that is conducted back onto the AC power line on any frequency or frequencies within the band 150 kHz to 30 MHz shall not exceed the limits in the following table.

Frequency of Emission (MHz)	Conducted Limit (dB $\mu$ V)	
	Quasi-Peak	Average
0.15-0.5	66 to 56*	56 to 46*
0.5-5	56	46
5-30	60	50

\*Decreases with the logarithm of the frequency.

##### 3.1.2 Measuring Instruments

See list of measuring instruments of this test report.

##### 3.1.3 Test Procedures

1. The EUT was placed 0.4 meter from the conducting wall of the shielding room, and it was kept at least 80 centimeters from any other grounded conducting surface.
2. Connect EUT to the power mains through a line impedance stabilization network (LISN).
3. All the support units are connecting to the other LISN.
4. The LISN provides 50 ohm coupling impedance for the measuring instrument.
5. The FCC states that a 50 ohm, 50 microhenry LISN should be used.
6. Both sides of AC line were checked for maximum conducted interference.
7. The frequency range from 150 kHz to 30 MHz was searched.
8. Set the test-receiver system to Peak Detect Function and specified bandwidth (IF Bandwidth = 9kHz) with Maximum Hold Mode. Then measurement is also conducted by Average Detector and Quasi-Peak Detector Function respectively.

### 3.1.4 Test setup

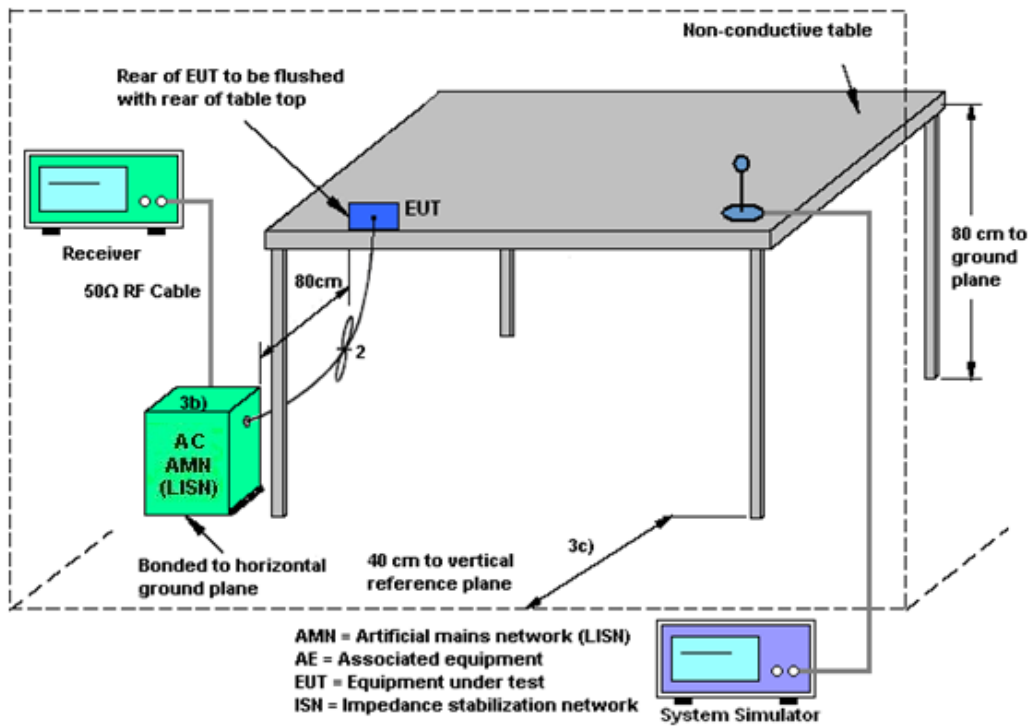

### 3.1.5 Test Result of AC Conducted Emission

Please refer to Appendix A.

## 3.2 20dB and 99% OBW Spectrum Bandwidth Measurement

### 3.2.1 Limit

Intentional radiators must be designed to ensure that the 20dB and 99% emission bandwidth in the specific band 13.553~13.567MHz.

### 3.2.2 Measuring Instruments

See list of measuring instruments of this test report.

### 3.2.3 Test Procedures

1. The spectrum analyzer connected via a receive antenna placed near the EUT in peak Max hold mode.
2. The resolution bandwidth of 1 kHz and the video bandwidth of 3 kHz were used.
3. Measured the spectrum width with power higher than 20dB below carrier.
4. Measured the 99% OBW.

### 3.2.4 Test Setup

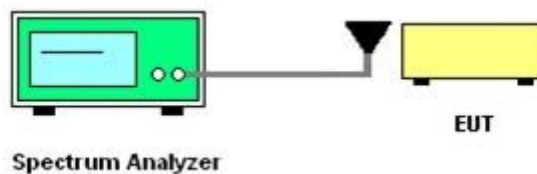

### 3.2.5 Test Result of Conducted Test Items

Please refer to Appendix B.

### 3.3 Frequency Stability Measurement

#### 3.3.1 Limit

The frequency tolerance of the carrier signal shall be maintained within +/- 0.01% (100ppm) of the operating frequency over a temperature variation of -20 degrees to +50 degrees C at normal supply voltage, and for a variation in the primary supply voltage from 85% to 115% of the rated supply voltage at a temperature of 20 degrees C. For battery operated equipment, the equipment tests shall be performed using a new battery.

#### 3.3.2 Measuring Instruments

See list of measuring instruments of this test report.

#### 3.3.3 Test Procedures

1. The spectrum analyzer connected via a receive antenna placed near the EUT.
2. EUT have transmitted signal and fixed channelize.
3. Set the spectrum analyzer span to view the entire emissions bandwidth.
4. Set RBW = 1 kHz, VBW = 3 kHz with peak detector and maxhold settings.
5. The  $f_c$  is declaring of channel frequency. Then the frequency error formula is  $(f_c - f) / f_c \times 10^6$  ppm and the limit is less than  $\pm 100$ ppm.
6. Extreme temperature rule is -20°C~50°C.

#### 3.3.4 Test Setup

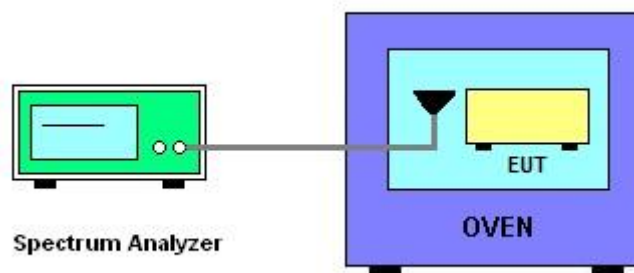

#### 3.3.5 Test Result of Conducted Test Items

Please refer to Appendix B.



### 3.4 Field Strength of Fundamental Emissions and Mask Measurement

#### 3.4.1 Limit

Rules and specifications	FCC CFR 47 Part 15 section 15.225	
Description	Compliance with the spectrum mask is tested with RBW set to 9kHz.	
Freq. of Emission (MHz)	Field Strength ( $\mu\text{V}/\text{m}$ ) at 30m	Field Strength ( $\text{dB}\mu\text{V}/\text{m}$ ) at 30m
1.705~13.110	30	29.5
13.110~13.410	106	40.5
13.410~13.553	334	50.5
13.553~13.567	15848	84.0
13.567~13.710	334	50.5
13.710~14.010	106	40.5
14.010~30.000	30	29.5

#### 3.4.2 Measuring Instruments

See list of measuring instruments of this test report.

### 3.4.3 Test Procedures

1. Configure the EUT according to ANSI C63.10. The EUT was placed on the top of the turntable 0.8 meter above ground. The phase center of the loop receiving antenna mounted antenna tower was placed 3 meters far away from the turntable.
2. Power on the EUT and all the supporting units. The turntable was rotated by 360 degrees to determine the position of the highest radiation.
3. The height of the receiving antenna was fixed at one meter above ground to find the maximum emissions field strength.
4. For Fundamental emissions, use the receiver to measure QP reading.
5. When the radiated emissions limits are expressed in terms of the average value of the emissions, and pulsed operation is employed, the measurement field strength shall be determined by averaging over one complete pulse train, including blanking intervals, as long as the pulse train does not exceed 0.1 seconds. As an alternative (provided the transmitter operates for longer than 0.1 seconds) or in cases where the pulse train exceeds 0.1 seconds, the measured field strength shall be determined from the average absolute voltage during a 0.1 second interval during which the field strength is at its maximum value.
6. Compliance with the spectrum mask is tested with RBW set to 9kHz.  
Note: Emission level (dB $\mu$ V/m) = 20 log Emission level ( $\mu$ V/m).
7. The field strength is tested at 3m distance then convert to 30m by adding distance factor  $40 \cdot \log(d1/d2)$ .

### 3.4.4 Test Setup

For radiated emissions below 30MHz

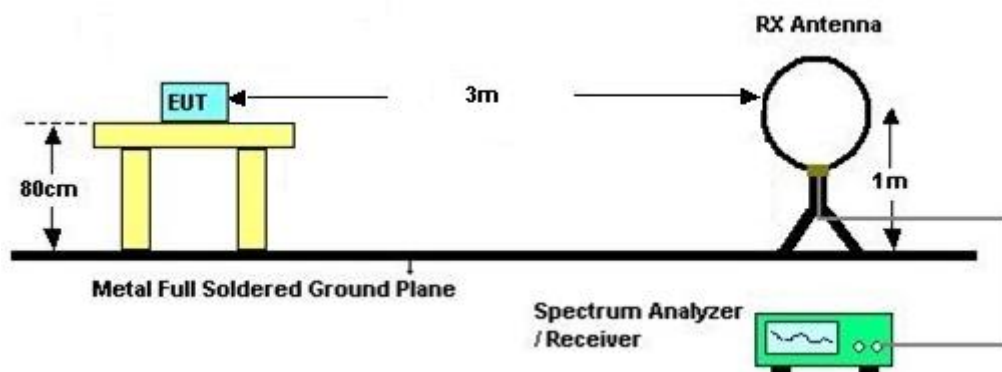

### 3.4.5 Test Result of Field Strength of Fundamental Emissions and Mask

Please refer to Appendix C.

### 3.5 Radiated Emissions Measurement

#### 3.5.1 Limit

The field strength of any emissions which appear outside of 13.110 ~14.010MHz band shall not exceed the general radiated emissions limits.

<FCC Limit>

Frequencies (MHz)	Field Strength (µV/m)	Measurement Distance (meters)
0.009~0.490	2400/F(kHz)	300
0.490~1.705	24000/F(kHz)	30
1.705~30.0	30	30
30~88	100	3
88~216	150	3
216~960	200	3
Above 960	500	3

#### 3.5.2 Measuring Instruments

See list of measuring instruments of this test report.

#### 3.5.3 Measuring Instrument Setting

The following table is the setting of receiver.

Receiver Parameter	Setting
Attenuation	Auto
Frequency Range: 9kHz~150kHz	RBW 200Hz for QP
Frequency Range: 150kHz~30MHz	RBW 9kHz for QP
Frequency Range: 30MHz~1000MHz	RBW 120kHz for Peak

**Note:** The emission limits shown in the above table are based on measurements employing a CISPR quasi-peak detector except for the frequency bands 9-90 kHz, 110-490 kHz. Radiated emission limits in these two bands are based on measurements employing an average detector.



### **3.5.4 Test Procedures**

1. Configure the EUT according to ANSI C63.10. The EUT was placed on the top of the turntable 0.8 meter above ground. The phase center of the receiving antenna mounted on the top of a height-variable antenna tower was placed 3 meters far away from the turntable.
2. Power on the EUT and all the supporting units. The turntable was rotated by 360 degrees to determine the position of the highest radiation.
3. The height of the broadband receiving antenna was varied between one meter and four meters above ground to find the maximum emissions field strength of both horizontal and vertical polarization.
4. For each suspected emissions, the antenna tower was scan (from 1 M to 4 M) and then the turntable was rotated (from 0 degree to 360 degrees) to find the maximum reading.
5. Set the test-receiver system to Peak or CISPR quasi-peak Detect Function with specified bandwidth under Maximum Hold Mode.
6. When the radiated emissions limits are expressed in terms of the average value of the emissions, and pulsed operation is employed, the measurement field strength shall be determined by averaging over one complete pulse train, including blanking intervals, as long as the pulse train does not exceed 0.1 seconds. As an alternative (provided the transmitter operates for longer than 0.1 seconds) or in cases where the pulse train exceeds 0.1 seconds, the measured field strength shall be determined from the average absolute voltage during a 0.1 second interval during which the field strength is at its maximum value.
7. In case the emission is lower than 30MHz, loop antenna has to be used for measurement and the recorded data should be QP measured by receiver. Antenna Requirements

### 3.5.5 Test Setup

For radiated emissions below 30MHz

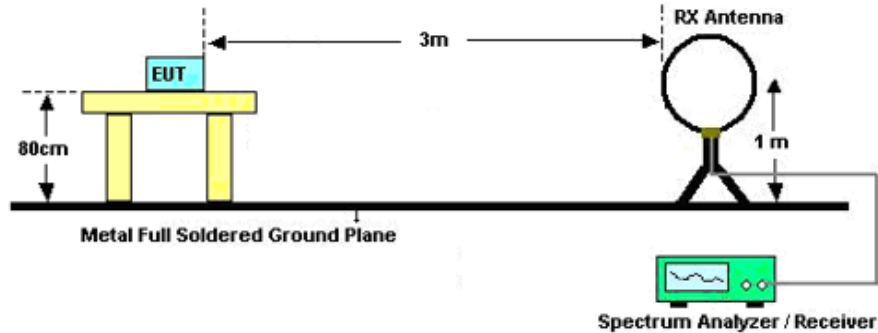

For radiated emissions above 30MHz

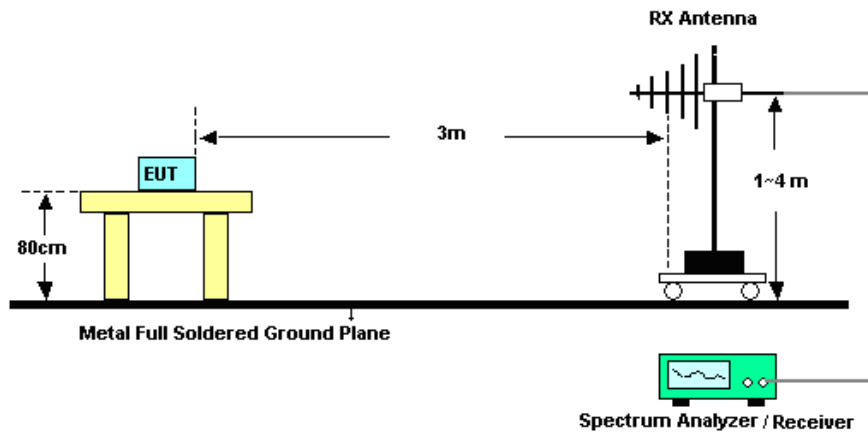

### 3.5.6 Test Result of Radiated Emissions Measurement

Please refer to Appendix C.

**Note:**

1. There is a comparison data of both open-field test site and semi-Anechoic chamber, and the result came out very similar.
2. Tested for radiated below 30 MHz using a loop antenna in accordance with C63.10, the antenna was positioned in three antenna orientations: parallel, perpendicular, and ground-parallel. Pre-scanned the three antenna orientations, the worst case is parallel & perpendicular polarization, and test data of two mode was reported. (Parallel: The loop antenna is placed vertical axis and aligned along the site axis; Perpendicular: The loop antenna is placed vertical axis and orthogonal to the axis; ground-parallel: The loop antenna is placed horizontal axis and parallel with the ground).



## **3.6 Antenna Requirements**

### **3.6.1 Standard Applicable**

Except for special regulations, the Low-power Radio-frequency Devices must not be equipped with any jacket for installing an antenna with extension cable. An intentional radiator shall be designed to ensure that no antenna other than that furnished by the responsible party shall be used with the device. The use of a permanently attached antenna or of an antenna that uses a unique coupling to the intentional radiator shall be considered sufficient to comply with the provisions of this Section. The manufacturer may design the unit so that the user can replace a broken antenna, but the use of a standard antenna jack or electrical connector is prohibited.

The use of a permanently attached antenna or of an antenna that uses a unique coupling to the intentional radiator shall be considered sufficient to comply with the rule.

### **3.6.2 Antenna Anti-Replacement Construction**

An embedded-in antenna design is used.



### 4. List of Measuring Equipment

Instrument	Manufacturer	Model No.	Serial No.	Characteristics	Calibration Date	Test Date	Due Date	Remark
EMI Test Receiver	R&S	ESR7	102261	9kHz~7GHz	Apr. 09, 2024	Aug. 30, 2024~ Aug. 31, 2024	Apr. 08, 2025	Radiation (03CH05-SZ)
EXA Spectrum Analyzer	KEYSIGHT	N9010B	MY590711 91	10Hz~44GHz	Apr. 09, 2024	Aug. 30, 2024~ Aug. 31, 2024	Apr. 08, 2025	Radiation (03CH05-SZ)
Loop Antenna	R&S	HFH2-Z2E	101141	9kHz~30MHz	Dec. 29, 2023	Aug. 30, 2024~ Aug. 31, 2024	Dec. 28, 2024	Radiation (03CH05-SZ)
Log-periodic Antenna	SCHWARZBECK	VULB 9168	01001	20MHz~1.5GHz	Jul. 08, 2024	Aug. 30, 2024~ Aug. 31, 2024	Jul. 07, 2025	Radiation (03CH05-SZ)
Amplifier	EM Electronics	EM330	060756	0.01Hz ~3000MHz	Apr. 09, 2024	Aug. 30, 2024~ Aug. 31, 2024	Apr. 08, 2025	Radiation (03CH05-SZ)
AC Power Source	APC	AFV-S-600	F11905001 3	N/A	Oct. 18, 2023	Aug. 30, 2024~ Aug. 31, 2024	Oct. 17, 2024	Radiation (03CH05-SZ)
Turn Table	EMEC	T-200-S-1	060925-T	0~360 degree	NCR	Aug. 30, 2024~ Aug. 31, 2024	NCR	Radiation (03CH05-SZ)
Antenna Mast	EMEC	MBS-400-1	060927	1 m~4 m	NCR	Aug. 30, 2024~ Aug. 31, 2024	NCR	Radiation (03CH05-SZ)
EMI Receiver	R&S	ESR7	101630	9kHz~7GHz;	Jul. 04, 2024	Sep. 06, 2024~ Sep. 09, 2024	Jul. 03, 2025	Conduction (CO01-SZ)
AC LISN	R&S	ENV216	100063	9kHz~30MHz	Jul. 04, 2024	Sep. 06, 2024~ Sep. 09, 2024	Jul. 03, 2025	Conduction (CO01-SZ)
AC LISN (for auxiliary equipment)	EMCO	3816/2SH	00103892	9kHz~30MHz	Oct. 16, 2023	Sep. 06, 2024~ Sep. 09, 2024	Oct. 15, 2024	Conduction (CO01-SZ)
AC Power Source	Chroma	61602	616020000 891	100Vac~250Vac	Aug. 14, 2024	Sep. 06, 2024~ Sep. 09, 2024	Aug. 13, 2025	Conduction (CO01-SZ)
Spectrum Analyzer	R&S	FSV40	101078	10Hz~40GHz	Apr. 09, 2024	Sep. 10, 2024	Apr. 08, 2025	Conducted (TH01-SZ)
Thermal Chamber	Ten Billion Hongzhangroup	LP-150U	H2014081 803	-40~+150°C	Jul. 03, 2024	Sep. 10, 2024	Jul. 02, 2025	Conducted (TH01-SZ)
Thermo meter	Anymetre	JR593	#7	- 10°C ~ 50°C 10%RH~99%RH	Apr. 09, 2024	Sep. 10, 2024	Apr. 08, 2025	Conducted (TH01-SZ)

NCR: No Calibration Required



### 5. Uncertainty of Evaluation

The measurement uncertainties shown below were calculated in accordance with the requirements of ANSI 63.10-2013. All the measurement uncertainty value were shown with a coverage K=2 to indicate 95% level of confidence. The measurement data show herein meets or exceeds the CISPR measurement uncertainty values specified in CISPR 16-4-2 and can be compared directly to specified limit to determine compliance.

#### Uncertainty of Conducted Measurement

Test Item	Uncertainty
Occupied Channel Bandwidth	±0.012 MHz
Frequency	±1.3 Hz

#### Uncertainty of AC Conducted Emission Measurement (0.15 MHz ~ 30 MHz)

Measuring Uncertainty for a Level of Confidence of 95% (U = 2Uc(y))	2.5 dB
---	--------

#### Uncertainty of Radiated Emission Measurement (9 kHz ~ 30 MHz)

Measuring Uncertainty for a Level of Confidence of 95% (U = 2Uc(y))	2.5 dB
---	--------

#### Uncertainty of Radiated Emission Measurement (30 MHz ~ 1000 MHz)

Measuring Uncertainty for a Level of Confidence of 95% (U = 2Uc(y))	4.2 dB
---	--------

----- THE END -----



## Appendix A. Test Results of Conducted Emission Test

Test Engineer :	Chase Nathon	Temperature :	22~24°C
		Relative Humidity :	44~50%
Test Voltage :	120Vac / 60Hz	Phase :	Line
Remark :	All emissions not reported here are more than 10 dB below the prescribed limit.		

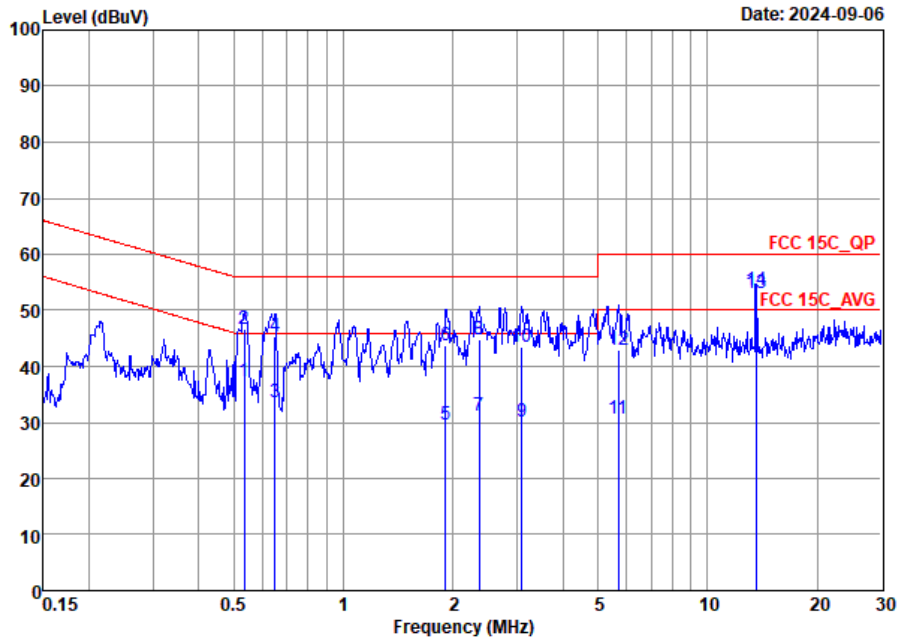

Site : C001-SZ  
 Condition: FCC 15C\_QP AC LISN 100063\_L LINE

	Freq	Level	Over Limit	Limit Line	Read Level	LISN Factor	Cable Loss	Remark
	MHz	dBuV	dB	dBuV	dBuV	dB	dB	
1	0.53	37.29	-8.71	46.00	17.40	9.73	10.16	Average
2	0.53	46.59	-9.41	56.00	26.70	9.73	10.16	QP
3	0.65	33.68	-12.32	46.00	13.80	9.72	10.16	Average
4	0.65	45.38	-10.62	56.00	25.50	9.72	10.16	QP
5	1.91	29.55	-16.45	46.00	9.60	9.72	10.23	Average
6	1.91	43.85	-12.15	56.00	23.90	9.72	10.23	QP
7	2.36	31.28	-14.72	46.00	11.30	9.73	10.25	Average
8	2.36	44.88	-11.12	56.00	24.90	9.73	10.25	QP
9	3.09	30.05	-15.95	46.00	10.00	9.76	10.29	Average
10	3.09	43.45	-12.55	56.00	23.40	9.76	10.29	QP
11	5.68	30.61	-19.39	50.00	10.49	9.76	10.36	Average
12	5.68	42.89	-17.11	60.00	22.77	9.76	10.36	QP
13 *	13.56	53.17			32.80	9.91	10.46	Average
14	13.56	53.47			33.10	9.91	10.46	QP

(1) with antenna

Remark: 13.560MHz is the NFC RF fundamental signal.



Test Engineer :	Chase Nathon	Temperature :	22~24°C
		Relative Humidity :	44~50%
Test Voltage :	120Vac / 60Hz	Phase :	Neutral
Remark :	All emissions not reported here are more than 10 dB below the prescribed limit.		

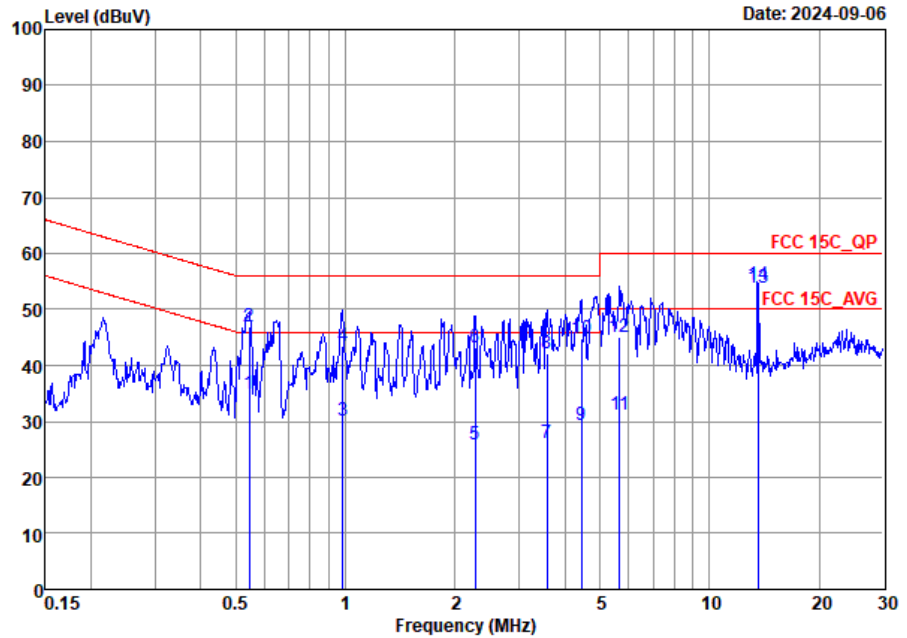

Site : C001-SZ  
 Condition: FCC 15C\_QP AC LISN 100063\_N NEUTRAL

	Freq	Level	Over Limit	Limit Line	Read Level	LISN Factor	Cable Loss	Remark
	MHz	dBuV	dB	dBuV	dBuV	dB	dB	
1	0.54	34.99	-11.01	46.00	15.10	9.73	10.16	Average
2	0.54	46.99	-9.01	56.00	27.10	9.73	10.16	QP
3	0.98	30.25	-15.75	46.00	10.40	9.69	10.16	Average
4	0.98	43.45	-12.55	56.00	23.60	9.69	10.16	QP
5	2.27	25.87	-20.13	46.00	5.90	9.72	10.25	Average
6	2.27	43.07	-12.93	56.00	23.10	9.72	10.25	QP
7	3.58	26.12	-19.88	46.00	6.10	9.71	10.31	Average
8	3.58	42.12	-13.88	56.00	22.10	9.71	10.31	QP
9	4.45	29.25	-16.75	46.00	9.19	9.72	10.34	Average
10	4.45	44.85	-11.15	56.00	24.79	9.72	10.34	QP
11	5.65	31.09	-18.91	50.00	10.99	9.74	10.36	Average
12	5.65	45.09	-14.91	60.00	24.99	9.74	10.36	QP
13 *	13.56	53.95			33.71	9.78	10.46	Average
14	13.56	54.35			34.11	9.78	10.46	QP

(1) with antenna

Remark: 13.560MHz is the NFC RF fundamental signal.



Test Engineer :	Chase Nathon	Temperature :	22~24°C
		Relative Humidity :	44~50%
Test Voltage :	120Vac / 60Hz	Phase :	Line
Remark :	All emissions not reported here are more than 10 dB below the prescribed limit.		

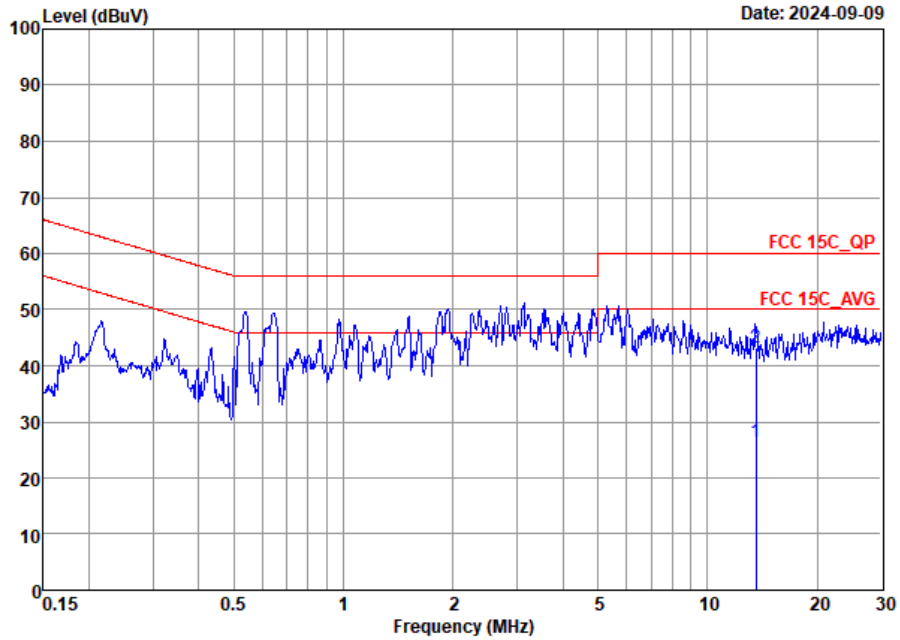

Site : CO01-SZ  
 Condition: FCC 15C\_QP AC LISN 100063\_L LINE

	Freq	Level	Over Limit	Limit Line	Read Level	LISN Factor	Cable Loss	Remark
	MHz	dBuV	dB	dBuV	dBuV	dB	dB	
1	13.56	26.27	-23.73	50.00	5.90	9.91	10.46	Average
2 *	13.56	43.27	-16.73	60.00	22.90	9.91	10.46	QP

(2) With dummy load

Remark: Only the fundamental NFC signal needs to be retested per KDB 174176.



Test Engineer :	Chase Nathon	Temperature :	22~24°C
		Relative Humidity :	44~50%
Test Voltage :	120Vac / 60Hz	Phase :	Neutral
Remark :	All emissions not reported here are more than 10 dB below the prescribed limit.		

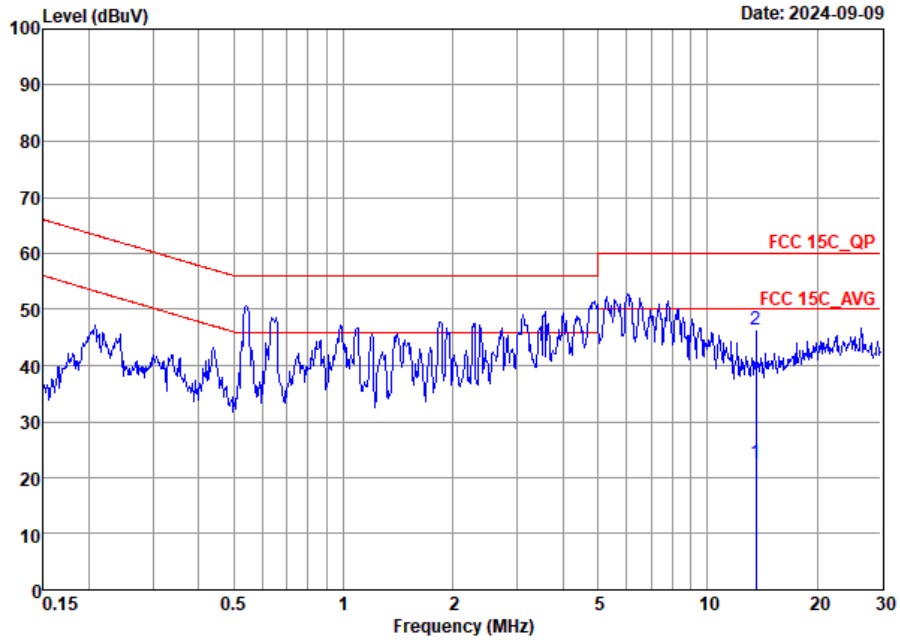

Site : CO01-SZ  
 Condition: FCC 15C\_QP AC LISN 100063\_N NEUTRAL

	Freq	Level	Over Limit	Limit	Read	LISN	Cable	
	MHz	dBuV	dB	dBuV	dBuV	dB	dB	Remark
1	13.56	22.65	-27.35	50.00	2.41	9.78	10.46	Average
2 *	13.56	46.45	-13.55	60.00	26.21	9.78	10.46	QP

(2) With dummy load

Remark: Only the fundamental NFC signal needs to be retested per KDB 174176.

Note:

- Level(dBμV) = Read Level(dBμV) + LISN Factor(dB) + Cable Loss(dB)
- Over Limit(dB) = Level(dBμV) – Limit Line(dBμV)



# Appendix B. Test Results of Conducted Test Items

## B1. Test Result of 20dB Spectrum Bandwidth

Test mode		NFC Tx		Test Frequency (MHz)		13.56	
<b>20dB Bandwidth (kHz)</b>	2.577		<b>99% Occupied BW(kHz)</b>	2.188			
<b>Frequency range (MHz)</b>	$f_L > 13.553$		13.559281		<b>Test Result</b>		
	$f_H < 13.567$		13.561858		<b>Complies</b>		

**Remark:** Because the measured signal is CW adjusting the RBW per C63.10 would not be practical since measured bandwidth will always follow the RBW and the result will be approximately twice the RBW.



**B2. Test Result of Frequency Stability**

**Startup:**

Voltage vs. Frequency Stability		Temperature vs. Frequency Stability		
Voltage (Vdc)	Measurement Frequency (MHz)	Temperature (°C)	Time	Measurement Frequency (MHz)
3.45	13.560570	-20	0	13.560670
3.91	13.560600		2	13.560665
4.50	13.560594		5	13.560655
			10	13.560645
		-10	0	13.560640
			2	13.560635
			5	13.560620
			10	13.560670
		0	0	13.560610
			2	13.560605
			5	13.560605
			10	13.560600
		10	0	13.560600
			2	13.560600
			5	13.560595
			10	13.560595
		20	0	13.560595
			2	13.560590
			5	13.560590
			10	13.560585
		30	0	13.560585
			2	13.560585
			5	13.560585
			10	13.560585
		40	0	13.560585
			2	13.560580
			5	13.560580
			10	13.560580
		50	0	13.560580
			2	13.560575
			5	13.560575
			10	13.560575
Max.Deviation (MHz)	0.000599	Max.Deviation (MHz)	0.000669	
Max.Deviation (ppm)	44.2109	Max.Deviation (ppm)	49.3732	
Limit	FS < ±100 ppm	Limit	FS < ±100 ppm	
Test Result	<b>PASS</b>	Test Result	<b>PASS</b>	



## Appendix C. Test Results of Radiated Test Items

### C.1 Test Result of Field Strength of Fundamental Emissions

Frequency (MHz)	Level @3m (dBuV/m)	Distance Factor (dB)	Corrected Level @30m (dBuV/m)	Limit Line (dBuV/m)	Over Limit (dB)	Read Level (dBuV)	Antenna Factor (dB/m)	Cable Loss (dB)	Remark	Pol/Phase
13.56	57.65	40	17.65	84.0	-66.35	36.47	20.27	0.91	QP	Perpendicular
13.56	49.76	40	9.76	84.0	-74.24	25.58	20.27	0.91	QP	Parallel

**Note:** The field strength is tested at 3m distance then convert to 30m by adding distance factor  $40 \cdot \log(d1/d2)$ .

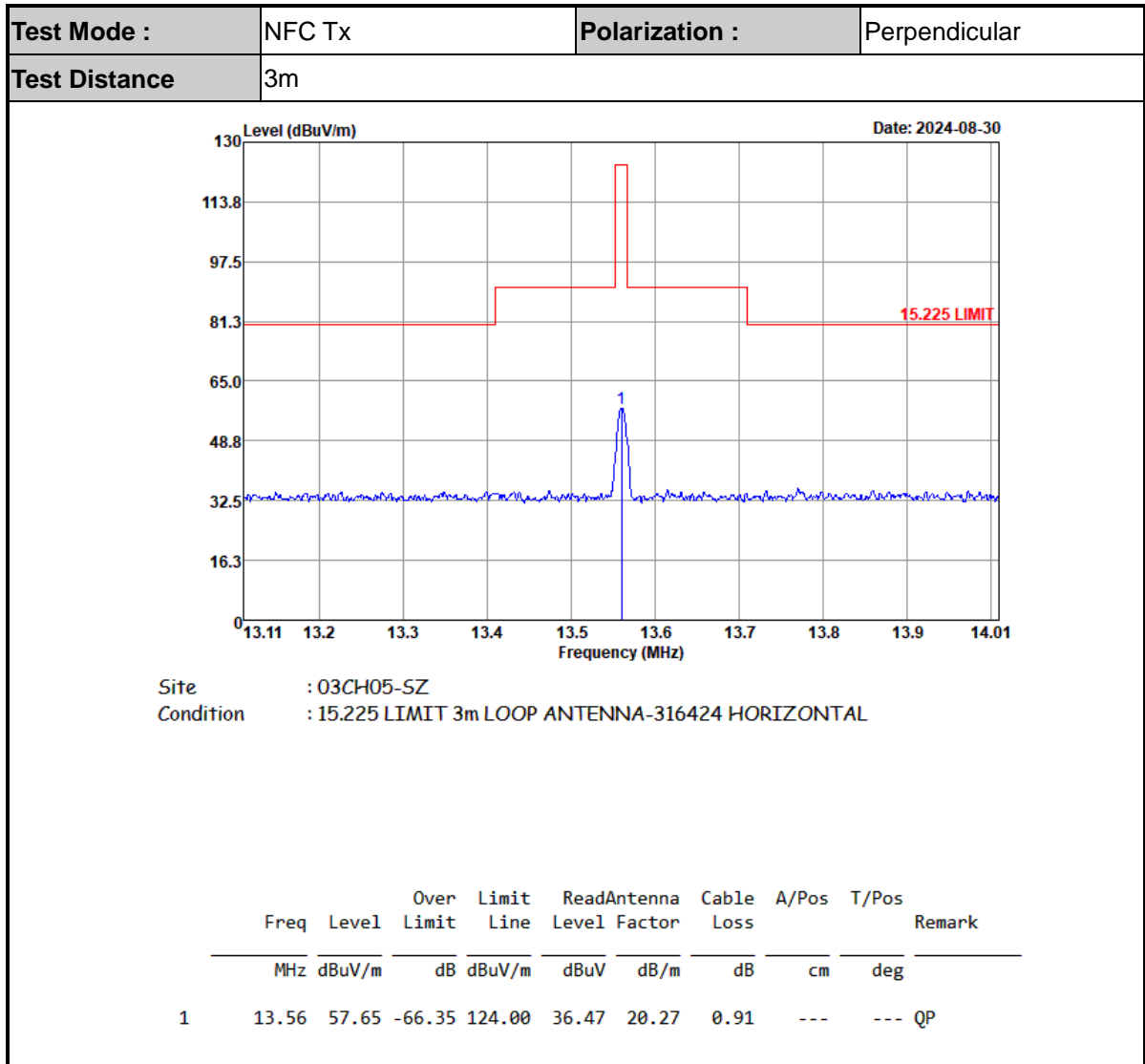



Test Mode :	NFC Tx	Polarization :	Parallel
Test Distance	3m		

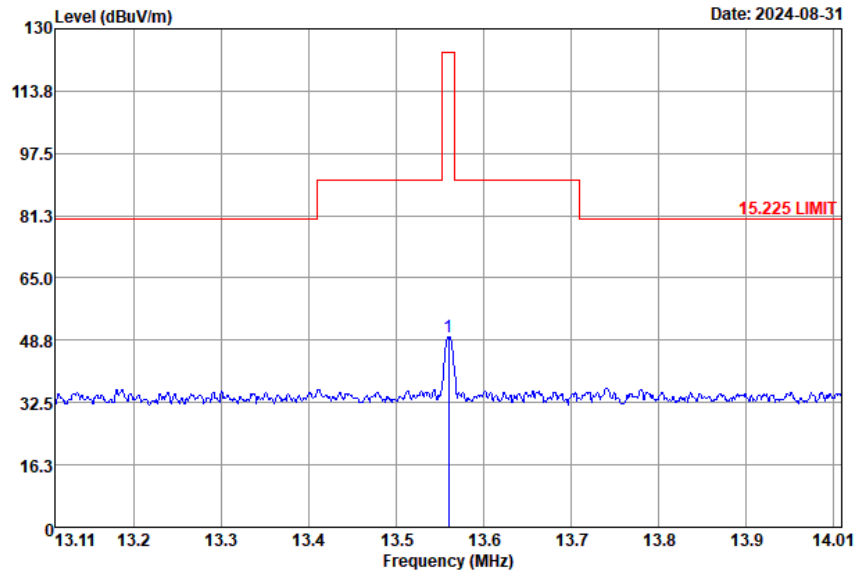

Site : 03CH05-SZ  
 Condition : 15.225 LIMIT 3m LOOP ANTENNA-316424 VERTICAL

	Over	Limit	ReadAntenna	Cable	A/Pos	T/Pos	Remark
Freq	Level	Limit	Level	Loss			
MHz	dBuV/m	dB	dBuV/m	dB	cm	deg	
1	49.76	-74.24	124.00	28.58	20.27	0.91	--- QP

Note:

- Level(dBμV/m) = Read Level(dBμV) + Antenna Factor(dB/m) + Cable Loss(dB)
- Over Limit(dB) = Level(dBμV/m) – Limit Line(dBμV/m)
- Distance extrapolation factor = 40 log (specific distance / test distance) (dB);
- Corrected Level = Level @3m (dBμV/m) - distance extrapolation factor.



**C2. Results of Radiated Spurious Emissions (9 kHz~30MHz)**

Test Mode :		NFC Tx				Polarization :		Perpendicular			
Frequency ( MHz )	Level @3m ( dBμV/m )	Distance Factor ( dB )	Corrected Level ( dBμV/m )	Over Limit ( dB )	Limit Line ( dBμV/m )	Read Level (dBμV)	Antenna Factor ( dB )	Cable Loss ( dB )	Ant Pos ( cm )	Table Pos ( deg )	Remark
0.04898	48.71	80	-31.29	-65.09	33.8	28.97	19.7	0.04	-	-	Average
0.07419	39.53	80	-40.47	-70.67	30.2	19.77	19.72	0.04	-	-	Average
0.0918	36.54	80	-43.46	-71.81	28.35	16.7	19.81	0.03	-	-	QP
0.1308	37.16	80	-42.84	-68.11	25.27	17.21	19.91	0.04	-	-	Average
1.676	37.36	40	-2.64	-25.76	23.12	16.98	20.17	0.21	-	-	QP
2.21	37.48	40	-2.52	-32.06	29.54	17.15	20.14	0.19	-	-	QP
9.336	35.98	40	-4.02	-33.56	29.54	14.98	20.23	0.77	-	-	QP
19.456	37.08	40	-2.92	-32.46	29.54	15.8	20.25	1.03	-	-	QP
26.9	36.74	40	-3.26	-32.8	29.54	15.17	20.4	1.17	-	-	QP

Test Mode :		NFC Tx				Polarization :		Parallel			
Frequency ( MHz )	Level @3m ( dBμV/m )	Distance Factor ( dB )	Corrected Level ( dBμV/m )	Over Limit ( dB )	Limit Line ( dBμV/m )	Read Level (dBμV)	Antenna Factor ( dB )	Cable Loss ( dB )	Ant Pos ( cm )	Table Pos ( deg )	Remark
0.04847	47.65	80	-32.35	-66.24	33.89	27.91	19.7	0.04	-	-	Average
0.08472	42.37	80	-37.63	-66.67	29.04	22.57	19.77	0.03	-	-	Average
0.09048	41.41	80	-38.59	-67.06	28.47	21.58	19.8	0.03	-	-	QP
0.13569	38.09	80	-41.91	-66.86	24.95	18.09	19.96	0.04	-	-	Average
1.669	37.68	40	-2.32	-25.48	23.16	17.3	20.17	0.21	-	-	QP
2.3	38.5	40	-1.5	-31.04	29.54	18.16	20.14	0.2	-	-	QP
10.056	43.26	40	3.26	-26.28	29.54	22.11	20.31	0.84	-	-	QP
22.282	37.65	40	-2.35	-31.89	29.54	16.16	20.4	1.09	-	-	QP
25.07	36.87	40	-3.13	-32.67	29.54	15.23	20.5	1.14	-	-	QP

**Note:**

1. The amplitude of spurious emissions which are attenuated by more than 20dB below the permissible value has no need to be reported.
2. Distance extrapolation factor = 40 log (specific distance / test distance) (dB);
3. Corrected Level = Level @3m (dBμV/m) - distance extrapolation factor.



C3. Results of Radiated Spurious Emissions (30MHz~1GHz)

Test Mode :		NFC Tx				Polarization :		Horizontal			
Frequency ( MHz )	Level ( dBμV/m )	Over Limit ( dB )	Limit Line ( dBμV/m )	Read Level ( dBμV )	Antenna Factor ( dB )	Cable Loss ( dB )	Preamp Factor ( dB )	Ant Pos ( cm )	Table Pos ( deg )	Remark	
40.67	23.3	-16.7	40	37.66	19.28	1.37	35.01	-	-	Peak	
94.99	25.22	-18.28	43.5	43.88	14.39	2.05	35.1	-	-	Peak	
203.63	23.57	-19.93	43.5	39.46	16.24	2.77	34.9	-	-	Peak	
474.26	24.45	-21.55	46	32.25	23.47	3.43	34.7	-	-	Peak	
731.31	27.53	-18.47	46	30.61	27.56	3.73	34.37	-	-	Peak	
908.82	31.41	-14.59	46	31.94	29.16	4.44	34.13	-	-	Peak	

Test Mode :		NFC Tx				Polarization :		Vertical			
Frequency ( MHz )	Level ( dBμV/m )	Over Limit ( dB )	Limit Line ( dBμV/m )	Read Level ( dBμV )	Antenna Factor ( dB )	Cable Loss ( dB )	Preamp Factor ( dB )	Ant Pos ( cm )	Table Pos ( deg )	Remark	
40.67	35.13	-4.87	40	49.49	19.28	1.37	35.01	-	-	Peak	
66.86	22.9	-17.1	40	38.65	17.53	1.82	35.1	-	-	Peak	
94.99	21.14	-22.36	43.5	39.8	14.39	2.05	35.1	-	-	Peak	
159.98	20.46	-23.04	43.5	34.7	18.36	2.38	34.98	-	-	Peak	
514.03	24.87	-21.13	46	32.03	24.1	3.41	34.67	-	-	Peak	
797.27	30.2	-15.8	46	30.99	29.07	4.35	34.21	-	-	Peak	

Note:

1. The amplitude of spurious emissions which are attenuated by more than 20dB below the permissible value has no need to be reported.
2. Emission level (dBμV/m) = 20 log Emission level (μV/m).
3. Corrected Reading: Antenna Factor + Cable Loss + Read Level - Preamp Factor= Level.