

FCC RF Test Report

APPLICANT : Motorola Mobility LLC
EQUIPMENT : Mobile Cellular Phone
BRAND NAME : Motorola
MODEL NAME : XT2315-1, XT2315-4, XT2315-5
FCC ID : IHDT56AL2
STANDARD : 47 CFR Part 2, 90(R)
CLASSIFICATION : PCS Licensed Transmitter Held to Ear (PCE)
TEST DATE(S) : Dec. 09, 2022 ~ Dec. 25, 2022

We, Sporton International Inc. (Shenzhen), would like to declare that the tested sample has been evaluated in accordance with the procedures given in ANSI C63.26 and shown compliance with the applicable technical standards.

The test results in this report apply exclusively to the tested model / sample. Without written approval of Sporton International Inc. (Shenzhen), the test report shall not be reproduced except in full.

Jason Jia



Approved by: Jason Jia

Sporton International Inc. (ShenZhen)

1/F, 2/F, Bldg 5, Shiling Industrial Zone, Xinwei Village, Xili, Nanshan, Shenzhen, 518055

People's Republic of China



TABLE OF CONTENTS

REVISION HISTORY... 3
SUMMARY OF TEST RESULT ... 4
1 GENERAL DESCRIPTION ... 5
1.1 Applicant ... 5
1.2 Manufacturer ... 5
1.3 Feature of Equipment Under Test ... 5
1.4 Maximum ERP Power, and Emission Designator ... 6
1.5 Specification of Accessory ... 7
1.6 Testing Site ... 6
1.7 Test Software ... 6
1.8 Applied Standards ... 7
2 TEST CONFIGURATION OF EQUIPMENT UNDER TEST ... 8
2.1 Test Mode ... 8
2.2 Connection Diagram of Test System ... 9
2.3 Support Unit used in test configuration and system ... 9
2.4 Measurement Results Explanation Example ... 9
3 CONDUCTED TEST ITEMS ... 10
3.1 Measuring Instruments ... 10
3.2 Conducted Output Power and ERP ... 11
3.3 Peak-to-Average Ratio ... 12
3.4 Occupied Bandwidth ... 13
3.5 Conducted Band Edge Measurement ... 14
3.6 Emission Mask ... 15
3.7 Conducted Spurious Emission Measurement ... 16
3.8 Frequency Stability Measurement ... 17
4 RADIATED TEST ITEMS ... 18
4.1 Measuring Instruments ... 18
4.2 Test Setup ... 18
4.3 Test Result of Radiated Test ... 19
4.4 Radiated Spurious Emission Measurement ... 20
5 LIST OF MEASURING EQUIPMENT ... 21
6 UNCERTAINTY OF EVALUATION ... 22
APPENDIX A. TEST RESULTS OF CONDUCTED TEST
APPENDIX B. TEST RESULTS OF RADIATED TEST
APPENDIX C. TEST SETUP PHOTOGRAPHS

SUMMARY OF TEST RESULT

Report Section	FCC Rule	Description	Limit	Result	Remark
3.2	§2.1046	Conducted Output Power	—	Reporting only	-
	§90.542 (a)(7)	Effective Radiated Power	ERP < 3Watt	PASS	-
3.3	-	Peak-to-Average Ratio	—	Reporting only	-
3.4	§2.1049	Occupied Bandwidth	—	Reporting only	-
3.5	§2.1053 §90.543 (e)(2)(3)	Conducted Band Edge Measurement	Refer standard	PASS	-
3.6	§2.1051 §90.210(n)	Emission Mask	Mask B	PASS	-
3.7	§2.1053 §90.543 (e)(3)	Conducted Spurious Emission	< 43+10log ₁₀ (P[Watts])	PASS	-
3.8	§2.1055 §90.539 (e)	Frequency Stability Temperature & Voltage	< ±1.25 ppm	PASS	-
4.4	§2.1053 §90.543 (e)(3) §90.543 (f)	Radiated Spurious Emission	< 43+10log ₁₀ (P[Watts])	PASS	Under limit 24.42 dB at 1576.932 MHz

Declaration of Conformity:

The test results with all measurement uncertainty excluded are presented in accordance with the regulation limits or requirements declared by manufacturers.

Comments and Explanations:

The declared of product specification for EUT presented in the report are provided by the manufacturer, and the manufacturer takes all the responsibilities for the accuracy of product specification.



1 General Description

1.1 Applicant

Motorola Mobility LLC
222 W,Merchandise Mart Plaza, Chicago IL 60654 USA

1.2 Manufacturer

Motorola Mobility LLC
222 W,Merchandise Mart Plaza, Chicago IL 60654 USA

1.3 Feature of Equipment Under Test

Product Feature	
Equipment	Mobile Cellular Phone
Brand Name	Motorola
Model Name	XT2315-1, XT2315-4, XT2315-5
FCC ID	IHDT56AL2
Tx Frequency	5G NR n14 : 788 MHz ~ 798 MHz
Rx Frequency	5G NR n14 : 758 MHz ~ 768 MHz
Bandwidth	5MHz / 10MHz
SCS	15kHz
Antenna Gain	Ant 0: -7.6 dBi Ant 1: -7.5 dBi
Type of Modulation	DFT-s-OFDM (PI/2 BPSK / QPSK / 16QAM / 64QAM / 256QAM) CP-OFDM (QPSK / 16QAM / 64QAM / 256QAM)
IMEI Code	Conducted: 359709930025070/359709930025112 Radiation: 359709930025237/359709930025245
HW Version	DVT2
SW Version	T1TGN33.33
EUT Stage	Identical Prototype

Remark:

- 5G NR n14 only support SA mode.
- The maximum ERP is calculated from max output power and max antenna gain, only the maximum ERP are shown in the report, 5G NR n14 for Ant.0

1.4 Maximum ERP Power, and Emission Designator

5G NR n14		PI/2 BPSK/QPSK		16QAM/64QAM/256QAM	
BW (MHz)	Frequency Range (MHz)	Maximum ERP(W)	Emission Designator (99%OBW)	Maximum ERP(W)	Emission Designator (99%OBW)
5	790.5~795.5	0.0195	4M48G7D	0.0183	4M49W7D
10	793	0.0195	9M27G7D	0.0172	9M28W7D

1.5 Testing Site

Sporton International Inc. (ShenZhen) is accredited to ISO/IEC 17025:2017 by American Association for Laboratory Accreditation with Certificate Number 5145.01.

Test Firm	Sporton International Inc. (ShenZhen)		
Test Site Location	1/F, 2/F, Bldg 5, Shiling Industrial Zone, Xinwei Village, Xili, Nanshan, Shenzhen, 518055 People's Republic of China TEL: +86-755-86379589 FAX: +86-755-86379595		
Test Site No.	Sporton Site No.	FCC Designation No.	FCC Test Firm Registration No.
	TH01-SZ	CN1256	421272

Test Firm	Sporton International Inc. (ShenZhen)		
Test Site Location	101, 1st Floor, Block B, Building 1, No. 2, Tengfeng 4th Road, Fenghuang Community, Fuyong Street, Baoan District, Shenzhen City Guangdong Province China 518103 TEL: +86-755-33202398		
Test Site No.	Sporton Site No.	FCC Designation No.	FCC Test Firm Registration No.
	03CH03-SZ	CN1256	421272

1.6 Test Software

Item	Site	Manufacturer	Name	Version
1.	03CH03-SZ	AUDIX	E3	6.2009-8-24

1.7 Specification of Accessory

Specification of Accessory				
AC Adapter 1	Brand Name	Motorola(Chenyang)	Model Name	MC-101
AC Adapter 2	Brand Name	Motorola(Salcomp)	Model Name	MC-101
AC Adapter 3	Brand Name	Motorola(AOHAI)	Model Name	MC-101
AC Adapter 4	Brand Name	Motorola(Salcomp)	Model Name	MC-101
Battery 1	Brand Name	Motorola(ATL)	Model Name	PG50
Battery 2	Brand Name	Motorola(SCUD)	Model Name	PG50
USB Cable 1	Brand Name	Motorola(Saibao)	Model Name	SC18D22297
USB Cable 2	Brand Name	Motorola(Cabletech)	Model Name	SC18D22298
USB Cable 3	Brand Name	Motorola(Luxshare)	Model Name	SC18D22299

1.8 Applied Standards

According to the specifications of the manufacturer, the EUT must comply with the requirements of the following standards:

- ♦ 47 CFR Part 2, Part 90(R)
- ♦ ANSI C63.26
- ♦ KDB 971168 D01 Power Meas License Digital Systems v03r01
- ♦ KDB 412172 D01 Determining ERP and EIRP v01r01

Remark:

1. All test items were verified and recorded according to the standards and without any deviation during the test.
2. This EUT has also been tested and complied with the requirements of FCC Part 15, Subpart B, recorded in a separate test report.



2 Test Configuration of Equipment Under Test

2.1 Test Mode

Antenna port conducted and radiated test items listed below are performed according to KDB 971168 D01 Power Meas License Digital Systems v03r01 with maximum output power.

Radiated measurements are performed by rotating the EUT in three different orthogonal test planes to find the maximum emission.

Conducted Test Cases	Band	Bandwidth (MHz)						Modulation					RB #			Test Channel		
		1.4	3	5	10	15	20	PI/2 BPSK	QPSK	16QAM	64QAM	256QAM	1	Half	Full	L	M	H
Max. Output Power	n14	-	-	V		-	-	V	V	V	V	V	V		V	V	V	V
	n14	-	-		V	-	-	V	V	V	V	V		V			V	
Peak-to-Average Ratio	n14	-	-	V		-	-	V	V				V		V	V	V	V
		-	-		V	-	-	V	V				V		V		V	
26dB and 99% Bandwidth	n14	-	-	V	V	-	-	V	V	V	V	V			V		V	
Conducted Band Edge	n14	-	-	V		-	-	V	V				V		V	V		V
	n14	-	-		V	-	-	V	V				V		V		V	
Emission Mask	n14	-	-	V		-	-	V	V				V		V	V	V	V
	n14	-	-		V	-	-	V	V				V		V		V	
Conducted Spurious Emission	n14	-	-	V		-	-	V	V				V			V	V	V
	n14	-	-		V	-	-	V	V				V				V	
Frequency Stability	n14	-	-	V	V	-	-		V						V		V	
E.R.P	n14	-	-	V		-	-	V	V	V	V	V	V		V	V	V	V
	n14	-	-		V	-	-	V	V	V	V	V	V		V		V	
Radiated Spurious Emission	n14	Worst Case													V	V	V	
Note	<ol style="list-style-type: none"> The mark "v" means that this configuration is chosen for testing The mark "-" means that this bandwidth is not supported. The device is investigated from 30MHz to 10 times of fundamental signal for radiated spurious emission test under different RB size/offset and modulations in exploratory test. Subsequently, only the worst case emissions are reported. Frequency Stability : Normal Voltage = 3.89V ; Low Voltage =3.50V. ; High Voltage =4.48V 																	

2.2 Connection Diagram of Test System

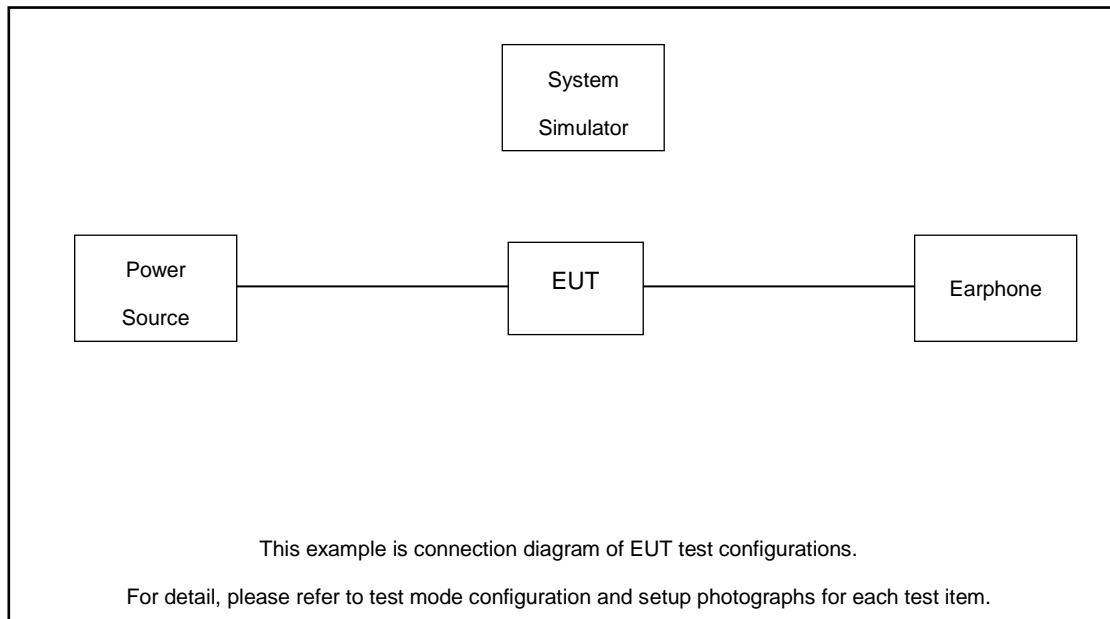

2.3 Support Unit used in test configuration and system

Item	Equipment	Trade Name	Model No.	FCC ID	Data Cable	Power Cord
1.	DC Power Supply	GW	GPS-3030D	N/A	N/A	Unshielded, 1.8 m
2.	NR Base Station	Anritsu	MT8000A	N/A	N/A	Unshielded, 1.8m
3.	Earphone	Moto	N/A	N/A	N/A	N/A

2.4 Measurement Results Explanation Example

For all conducted test items:

The offset level is set in the spectrum analyzer to compensate the RF cable loss between EUT conducted output port and spectrum analyzer. With the offset compensation, the spectrum analyzer reading level is exactly the EUT RF output level.

The spectrum analyzer offset is derived from RF cable loss.

Offset = RF cable loss.

Following shows an offset computation example with cable loss 7.6 dB.

Example :

$$\begin{aligned} \text{Offset(dB)} &= \text{RF cable loss(dB)}. \\ &= 7.6 \text{ (dB)} \end{aligned}$$

3 Conducted Test Items

3.1 Measuring Instruments

See list of measuring instruments of this test report.

3.1.1 Test Setup

3.1.2 Conducted Output Power

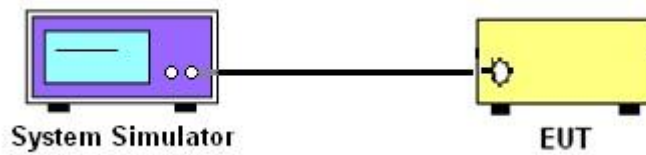

3.1.3 Peak-to-Average Ratio, Occupied Bandwidth, Conducted Band-Edge, Emission Mask, and Conducted Spurious Emission

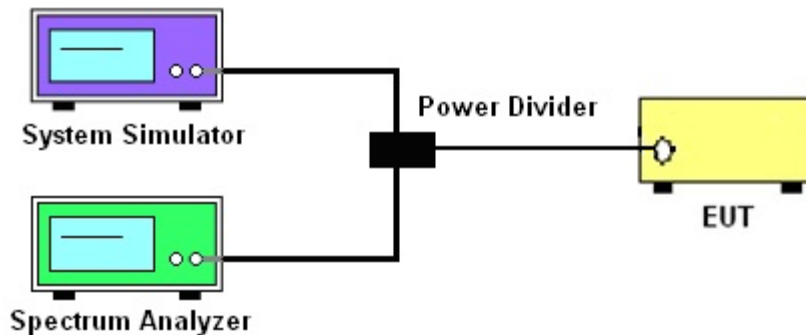

3.1.4 Frequency Stability

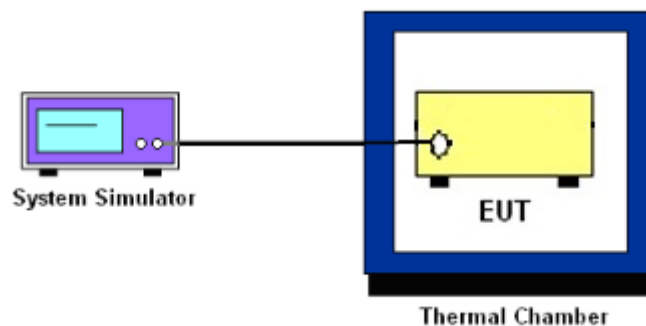

3.1.5 Test Result of Conducted Test

Please refer to Appendix A.

3.2 Conducted Output Power and ERP

3.2.1 Description of the Conducted Output Power Measurement and ERP

A base station simulator was used to establish communication with the EUT. Its parameters were set to transmit the maximum power on the EUT. The measured power in the radio frequency on the transmitter output terminals shall be reported.

The ERP of mobile transmitters must not exceed 3 Watts for LTE Band 14.

According to KDB 412172 D01 Power Approach,

$EIRP = P_T + G_T - L_C$, $ERP = EIRP - 2.15$, where

P_T = transmitter output power in dBm

G_T = gain of the transmitting antenna in dBi

L_C = signal attenuation in the connecting cable between the transmitter and antenna in dB

3.2.2 Test Procedures

1. The testing follows ANSI C63.26 Section 5.2
2. The transmitter output port was connected to the system simulator.
3. Set EUT at maximum power through the system simulator.
4. Select lowest, middle, and highest channels for each band and different modulation.
5. Measure and record the power level from the system simulator.

3.3 Peak-to-Average Ratio

3.3.1 Description of the PAR Measurement

Power Complementary Cumulative Distribution Function (CCDF) curves provide a means for characterizing the power peaks of a digitally modulated signal on a statistical basis. A CCDF curve depicts the probability of the peak signal amplitude exceeding the average power level. Most contemporary measurement instrumentation include the capability to produce CCDF curves for an input signal provided that the instrument's resolution bandwidth can be set wide enough to accommodate the entire input signal bandwidth. In measuring transmissions in this band using an average power technique, the peak-to-average ratio (PAR) of the transmission may not exceed 13 dB.

3.3.2 Test Procedures

1. The EUT was connected to spectrum and system simulator via a power divider.
2. Set the CCDF (Complementary Cumulative Distribution Function) option in spectrum analyzer.
3. The highest RF powers were measured and recorded the maximum PAPR level associated with a probability of 0.1 %.
4. Record the deviation as Peak to Average Ratio.

3.4 Occupied Bandwidth

3.4.1 Description of Occupied Bandwidth Measurement

The occupied bandwidth is the width of a frequency band such that, below the lower and above the upper frequency limits, the mean powers emitted are each equal to a specified percentage 0.5% of the total mean transmitted power.

The 26 dB emission bandwidth is defined as the frequency range between two points, one above and one below the carrier frequency, at which the spectral density of the emission is attenuated 26 dB below the maximum in-band spectral density of the modulated signal. Spectral density (power per unit bandwidth) is to be measured with a detector of resolution bandwidth equal to approximately 1.0% of the emission bandwidth.

3.4.2 Test Procedures

1. The testing follows ANSI C63.26 Section 5.4
2. The EUT was connected to spectrum analyzer and system simulator via a power divider.
3. The spectrum analyzer center frequency is set to the nominal EUT channel center frequency. The span range for the spectrum analyzer shall be between two and five times the anticipated OBW.
4. The nominal resolution bandwidth (RBW) shall be in the range of 1 to 5 % of the anticipated OBW, and the VBW shall be at least 3 times the RBW.
5. Set the detection mode to peak, and the trace mode to max hold.
6. Determine the reference value: Set the EUT to transmit a modulated signal. Allow the trace to stabilize. Set the spectrum analyzer marker to the highest level of the displayed trace.
(this is the reference value)
7. Determine the “-26 dB down amplitude” as equal to (Reference Value – X).
8. Place two markers, one at the lowest and the other at the highest frequency of the envelope of the spectral display such that each marker is at or slightly below the “-X dB down amplitude” determined in step 6. If a marker is below this “-X dB down amplitude” value it shall be placed as close as possible to this value. The OBW is the positive frequency difference between the two markers.
9. Use the 99 % power bandwidth function of the spectrum analyzer and report the measured bandwidth.

3.5 Conducted Band Edge Measurement

3.5.1 Description of Conducted Band Edge Measurement

For operations in the 758-768 MHz and the 788-798 MHz bands

- (1) On all frequencies between 769-775 MHz and 799-805 MHz, by a factor not less than $76 + 10 \log (P)$ dB in a 6.25 kHz band segment, for base and fixed stations.
- (2) On all frequencies between 769-775 MHz and 799-805 MHz, by a factor not less than $65 + 10 \log (P)$ dB in a 6.25 kHz band segment, for mobile and portable stations.
- (3) On any frequency between 775-788 MHz, above 805 MHz, and below 758 MHz, by at least $43 + 10 \log (P)$ dB.

3.5.2 Test Procedures

1. The testing follows ANSI C63.26 section 5.7
2. The EUT was connected to spectrum analyzer and system simulator via a power divider.
3. The band edges of low and high channels for the highest RF powers were measured.
4. Set spectrum analyzer with RMS detector.
5. The RF fundamental frequency should be excluded against the limit line in the operating frequency band.
6. Checked that all the results comply with the emission limit line.

Example:

$$\begin{aligned} & \text{The limit line is derived from } 43 + 10\log(P)\text{dB below the transmitter power } P(\text{Watts}) \\ & = P(\text{W}) - [43 + 10\log(P)] \text{ (dB)} \\ & = [30 + 10\log(P)] \text{ (dBm)} - [43 + 10\log(P)] \text{ (dB)} = -13\text{dBm}. \end{aligned}$$

3.6 Emission Mask

3.6.1 Description of Emission Mask

<Emission Mask B>.

For transmitters that are equipped with an audio low-pass filter, the power of any emission must be attenuated below the unmodulated carrier power (P) as follows:

- (1) On any frequency removed from the assigned frequency by more than 50 percent, but not more than 100 percent of the authorized bandwidth: At least 25 dB.
- (2) On any frequency removed from the assigned frequency by more than 100 percent, but not more than 250 percent of the authorized bandwidth: At least 35 dB.
- (3) On any frequency removed from the assigned frequency by more than 250 percent of the authorized bandwidth: At least $43 + 10 \log (P)$ dB.

3.6.2 Test Procedures

1. The testing follows ANSI C63.26 section 5.7
2. The EUT was connected to spectrum analyzer and system simulator via a power divider.
3. The RF output of EUT was connected to the spectrum analyzer by RF cable and attenuator. The path loss was compensated to the results for each measurement.
4. Make the measurement with the spectrum analyzer's RBW = 1MHz, VBW = 3MHz.
5. Set spectrum analyzer with RMS detector.
6. Taking the record of maximum spurious emission.
7. The RF fundamental frequency should be excluded against the limit line in the operating frequency band.
8. The limit line is derived from $43 + 10\log(P)$ dB below the transmitter power P(Watts)
= $P(W) - [43 + 10\log(P)]$ (dB)
= $[30 + 10\log(P)]$ (dBm) - $[43 + 10\log(P)]$ (dB)
= -13dBm.

3.7 Conducted Spurious Emission Measurement

3.7.1 Description of Conducted Spurious Emission Measurement

The power of any emission outside of the authorized operating frequency ranges must be lower than the transmitter power (P) by a factor of at least $43 + 10 \log (P)$ dB.

It is measured by means of a calibrated spectrum analyzer and scanned from 30MHz up to a frequency including its 10th harmonic.

3.7.2 Test Procedures

1. The testing follows ANSI C63.26 section 5.7
2. The EUT was connected to spectrum analyzer and base station via power divider.
3. The RF output of EUT was connected to the spectrum analyzer by RF cable and attenuator. The path loss was compensated to the results for each measurement.
4. The middle channel for the highest RF power within the transmitting frequency was measured.
5. The conducted spurious emission for the whole frequency range was taken.
6. Make the measurement with the spectrum analyzer's, for under 1GHz RBW = 100kHz, VBW = 300kHz and for above 1GHz RBW = 1MHz, VBW = 3MHz, taking the record of maximum spurious emission.
7. Set spectrum analyzer with RMS detector.
8. The RF fundamental frequency should be excluded against the limit line in the operating frequency band.
9. The limit line is derived from $43 + 10\log(P)$ dB below the transmitter power P(Watts)
= P(W)- [43 + 10log(P)] (dB)
= [30 + 10log(P)] (dBm) - [43 + 10log(P)] (dB)
= -13dBm.

3.8 Frequency Stability Measurement

3.8.1 Description of Frequency Stability Measurement

The frequency stability shall be measured by variation of ambient temperature and variation of primary supply voltage to ensure that the fundamental emission stays within the authorized frequency block. The frequency stability of the transmitter shall be maintained within ± 1.25 ppm of the center frequency.

3.8.2 Test Procedures for Temperature Variation

1. The testing follows ANSI C63.26 section 5.6.4
2. The EUT was set up in the thermal chamber and connected with the system simulator.
3. With power OFF, the temperature was decreased to -30°C and the EUT was stabilized before testing. Power was applied and the maximum change in frequency was recorded within one minute.
4. With power OFF, the temperature was raised in 10°C step up to 50°C . The EUT was stabilized at each step for at least half an hour. Power was applied and the maximum frequency change was recorded within one minute.

3.8.3 Test Procedures for Voltage Variation

1. The testing follows ANSI C63.26 section 5.6.5.
2. The EUT was placed in a temperature chamber at $20\pm 5^{\circ}\text{C}$ and connected with the system simulator.
3. The power supply voltage to the EUT was varied from 85% to 115% of the nominal value for other than hand carried battery equipment.
4. For hand carried, battery powered equipment, reduce the primary ac or dc supply voltage to the battery operating end point, which shall be specified by the manufacturer.
5. The variation in frequency was measured for the worst case.

4 Radiated Test Items

4.1 Measuring Instruments

See list of measuring instruments of this test report.

4.2 Test Setup

4.2.1 For radiated test below 30MHz

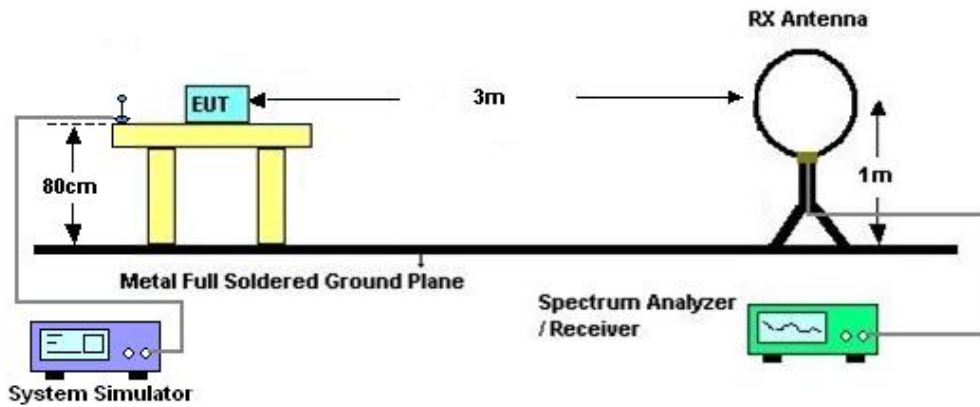

4.2.2 For radiated test from 30MHz to 1GHz

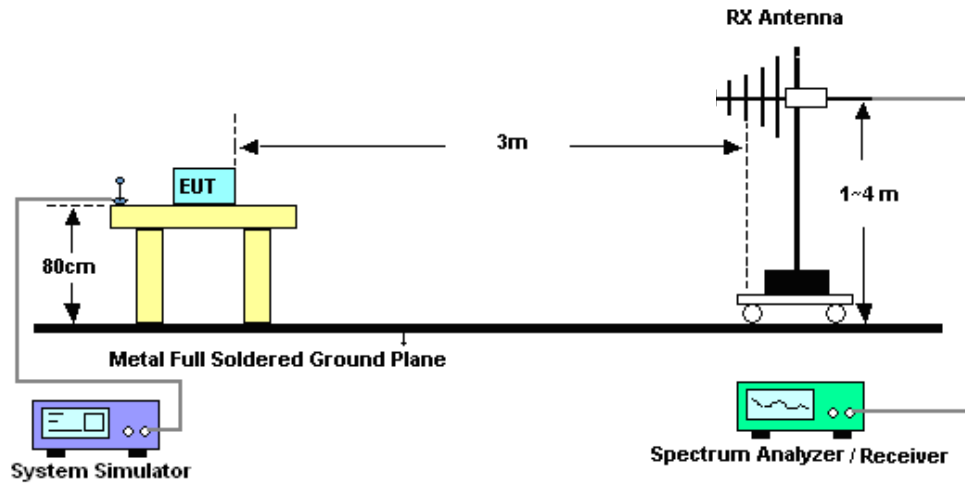

4.2.3 For radiated test above 1GHz

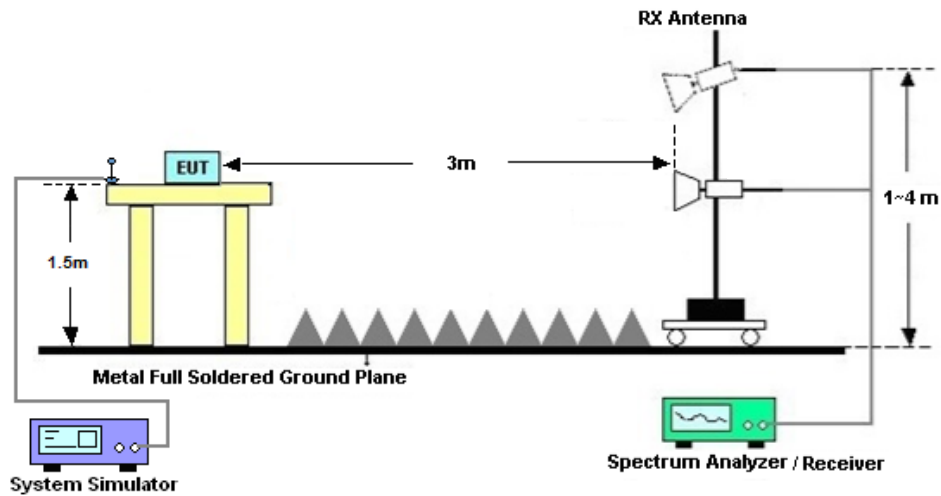

4.3 Test Result of Radiated Test

The low frequency, which started from 9 kHz to 30MHz, was pre-scanned and the result which was 20dB lower than the limit line was not reported.

Please refer to Appendix B.

4.4 Radiated Spurious Emission Measurement

4.4.1 Description of Radiated Spurious Emission

The radiated spurious emission was measured by substitution method according to ANSI C63.26.

The power of any emission outside of the authorized operating frequency ranges must be attenuated below the transmitter power (P) by a factor of at least $43 + 10 \log (P)$ dB.

For operations in the 758-775 MHz and 788-805 MHz bands, all emissions including harmonics in the band 1559–1610 MHz shall be limited to -70 dBW/MHz equivalent isotropically radiated power (EIRP) for wideband signals, and -80 dBW EIRP for discrete emissions of less than 700 Hz bandwidth. For the purpose of equipment authorization, a transmitter shall be tested with an antenna that is representative of the type that will be used with the equipment in normal operation.

4.4.2 Test Procedures

1. The testing follows ANSI C63.26 Section 5.5
2. The EUT was placed on a turntable with 0.8 meter height for frequency below 1GHz and 1.5 meter height for frequency above 1GHz respectively above ground.
3. The EUT was set 3 meters from the receiving antenna mounted on the antenna tower.
4. The table was rotated 360 degrees to determine the position of the highest spurious emission.
5. The height of the receiving antenna is varied between 1m to 4m to search the maximum spurious emission for both horizontal and vertical polarizations.
6. During the measurement, the system simulator parameters were set to force the EUT transmitting at maximum output power.
7. Make the measurement with the spectrum analyzer's RBW = 1MHz, VBW = 3MHz, taking the record of maximum spurious emission.
8. A horn antenna was substituted in place of the EUT and was driven by a signal generator.
9. Tune the output power of signal generator to the same emission level with EUT maximum spurious emission.
10. $EIRP (dBm) = S.G. Power - Tx Cable Loss + Tx Antenna Gain$
11. $ERP (dBm) = EIRP - 2.15$
12. The RF fundamental frequency should be excluded against the limit line in the operating frequency band.

The limit line is derived from $43 + 10\log(P)$ dB below the transmitter power P(Watts)
 $= P(W) - [43 + 10\log(P)] (dB)$
 $= [30 + 10\log(P)] (dBm) - [43 + 10\log(P)] (dB)$
 $= -13dBm.$



5 List of Measuring Equipment

Instrument	Manufacturer	Model No.	Serial No.	Characteristics	Calibration Date	Test Date	Due Date	Remark
Spectrum Analyzer	R&S	FSV40	101078	10Hz~40GHz	Apr. 07, 2022	Dec. 09, 2022	Apr. 08, 2023	Conducted (TH01-SZ)
Power Divider	TOJOIN	PS-2SM-04 265	60.06.020.007 7	0.4GHz~26.5GHz	Dec. 26, 2021	Dec. 09, 2022	Dec. 25, 2022	Conducted (TH01-SZ)
Thermal Chamber	Ten Billion Hongzhangroup	LP-150U	H2014081803	-40~+150°C	Jul. 07, 2022	Dec. 09, 2022	Jul. 06, 2023	Conducted (TH01-SZ)
EMI Test Receiver&SA	KEYSIGHT	N9038A	MY54450083	20Hz~8.4GHz	Apr. 06, 2022	Dec. 25, 2022	Apr. 05, 2023	Radiation (03CH03-SZ)
Loop Antenna	R&S	HFH2-Z2	100354	9kHz~30MHz	Jun. 28, 2022	Dec. 25, 2022	Jun. 27, 2024	Radiation (03CH03-SZ)
EXA Spectrum Analyzer	KEYSIGHT	N9010A	MY55150246	10Hz~44GHz;	Apr. 06, 2022	Dec. 25, 2022	Apr. 05, 2023	Radiation (03CH03-SZ)
Bilog Antenna	TeseQ	CBL6112D	35408	30MHz-2GHz	Aug. 09, 2021	Dec. 25, 2022	Aug. 08, 2023	Radiation (03CH03-SZ)
Double Ridge Horn Antenna	SCHWARZBECK	BBHA9120D	9120D-1355	1GHz~18GHz	Apr. 08, 2022	Dec. 25, 2022	Apr. 07, 2023	Radiation (03CH03-SZ)
Amplifier	Burgeon	BPA-530	102211	0.01Hz ~3000MHz	Oct. 19, 2022	Dec. 25, 2022	Oct. 18, 2023	Radiation (03CH03-SZ)
Amplifier	Agilent Technologies	83017A	MY39501302	500MHz~26.5GHz	Dec. 27, 2021	Dec. 25, 2022	Dec. 26, 2022	Radiation (03CH03-SZ)
AC Power Source	Chroma	61601	616010002729	N/A	Nov. 10, 2022	Dec. 25, 2022	Nov. 09, 2023	Radiation (03CH03-SZ)
Turn Table	EM	EM1000	N/A	0~360 degree	NCR	Dec. 25, 2022	NCR	Radiation (03CH03-SZ)
Antenna Mast	EM	EM1000	N/A	1 m~4 m	NCR	Dec. 25, 2022	NCR	Radiation (03CH03-SZ)

NCR: No Calibration Required

6 Uncertainty of Evaluation

The measurement uncertainties shown below were calculated in accordance with the requirements of ANSI 63.26-2015. All the measurement uncertainty value were shown with a coverage K=2 to indicate 95% level of confidence. The measurement data show herein meets or exceeds the CISPR measurement uncertainty values specified in CISPR 16-4-2 and can be compared directly to specified limit to determine compliance.

Uncertainty of Conducted Measurement

Test Item	Uncertainty
Conducted Power	±1.34 dB
Conducted Emissions	±1.34 dB
Occupied Channel Bandwidth	±0.13 %

Uncertainty of Radiated Emission Measurement (30 MHz ~ 1000 MHz)

Measuring Uncertainty for a Level of Confidence of 95% (U = 2Uc(y))	3.0dB
---	-------

Uncertainty of Radiated Emission Measurement (1GHz ~ 18GHz)

Measuring Uncertainty for a Level of Confidence of 95% (U = 2Uc(y))	3.6dB
---	-------

----- THE END -----



Appendix A. Test Results of Conducted Test

Test Engineer :	Jung Guo	Temperature :	24~26°C
		Relative Humidity :	50~53%

FR1 N14(ANT0)

Transmitter Conducted Output Power And ERP, ($G_T - L_C$)=-7.6dB

NR Band	SCS (kHz)	Bandwidth (MHz)	Arfcn	Freq (MHz)	Modulation	RB	Conducted Power(dBm)	ERP(dBm)	ERP(W)
14	15	5	158100	790.5	DFT-s-OFDM QPSK	1@1	22.57	12.82	0.0191
14	15	5	158100	790.5	DFT-s-OFDM 16 QAM	1@1	22.18	12.43	0.0175
14	15	5	158600	793.0	DFT-s-OFDM QPSK	1@1	22.52	12.77	0.0189
14	15	5	158600	793.0	DFT-s-OFDM 16 QAM	1@1	22.21	12.46	0.0176
14	15	5	159100	795.5	DFT-s-OFDM QPSK	1@1	22.65	12.9	0.0195
14	15	5	159100	795.5	DFT-s-OFDM 16 QAM	1@1	22.38	12.63	0.0183
14	15	10	158600	793.0	DFT-s-OFDM PI/2 BPSK	25@12	22.66	12.91	0.0195
14	15	10	158600	793.0	DFT-s-OFDM PI/2 BPSK	1@1	22.35	12.6	0.0182
14	15	10	158600	793.0	DFT-s-OFDM PI/2 BPSK	1@50	22.19	12.44	0.0175
14	15	10	158600	793.0	DFT-s-OFDM QPSK	25@12	22.37	12.62	0.0183
14	15	10	158600	793.0	DFT-s-OFDM QPSK	1@1	22.36	12.61	0.0182
14	15	10	158600	793.0	DFT-s-OFDM QPSK	1@50	22.3	12.55	0.0180
14	15	10	158600	793.0	DFT-s-OFDM 16 QAM	25@12	22.09	12.34	0.0171
14	15	10	158600	793.0	DFT-s-OFDM 16 QAM	1@1	22.1	12.35	0.0172
14	15	10	158600	793.0	DFT-s-OFDM 16 QAM	1@50	22.03	12.28	0.0169
14	15	10	158600	793.0	DFT-s-OFDM 64 QAM	25@12	21.29	11.54	0.0143
14	15	10	158600	793.0	DFT-s-OFDM 64 QAM	1@1	21.33	11.58	0.0144
14	15	10	158600	793.0	DFT-s-OFDM 64 QAM	1@50	21.29	11.54	0.0143
14	15	10	158600	793.0	DFT-s-OFDM 256 QAM	25@12	19.29	9.54	0.0090

14	15	10	158600	793.0	DFT-s-OFDM 256 QAM	1@1	18.83	9.08	0.0081
14	15	10	158600	793.0	DFT-s-OFDM 256 QAM	1@50	18.84	9.09	0.0081
14	15	10	158600	793.0	CP-OFDM QPSK	26@13	22.37	12.62	0.0183
14	15	10	158600	793.0	CP-OFDM QPSK	1@1	22.36	12.61	0.0182
14	15	10	158600	793.0	CP-OFDM QPSK	1@50	21.88	12.13	0.0163

Frequency Stability

NR Band	SCS (kHz)	Bandwidth (MHz)	Arfcn	Freq (MHz)	Modulation	RB	Deviation (ppm)	Verdict	Environment
14	15	5	158600	793.0	DFT-s-OFDM QPSK	25@0	0.0000	PASS	NV
14	15	5	158600	793.0	DFT-s-OFDM QPSK	25@0	0.0068	PASS	LV
14	15	5	158600	793.0	DFT-s-OFDM QPSK	25@0	0.0086	PASS	HV
14	15	5	158600	793.0	DFT-s-OFDM QPSK	25@0	0.0112	PASS	-30°C
14	15	5	158600	793.0	DFT-s-OFDM QPSK	25@0	0.0044	PASS	-20°C
14	15	5	158600	793.0	DFT-s-OFDM QPSK	25@0	0.0010	PASS	-10°C
14	15	5	158600	793.0	DFT-s-OFDM QPSK	25@0	0.0108	PASS	0°C
14	15	5	158600	793.0	DFT-s-OFDM QPSK	25@0	0.0042	PASS	10°C
14	15	5	158600	793.0	DFT-s-OFDM QPSK	25@0	0.0000	PASS	20°C
14	15	5	158600	793.0	DFT-s-OFDM QPSK	25@0	0.0050	PASS	30°C
14	15	5	158600	793.0	DFT-s-OFDM QPSK	25@0	0.0010	PASS	40°C
14	15	5	158600	793.0	DFT-s-OFDM QPSK	25@0	0.0023	PASS	50°C

NR Band	SCS (kHz)	Bandwidth (MHz)	Arfcn	Freq (MHz)	Modulation	RB	Deviation (ppm)	Verdict	Environment
14	15	10	158600	793.0	DFT-s-OFDM QPSK	50@0	0.0000	PASS	NV
14	15	10	158600	793.0	DFT-s-OFDM QPSK	50@0	0.0013	PASS	LV
14	15	10	158600	793.0	DFT-s-OFDM QPSK	50@0	0.0035	PASS	HV
14	15	10	158600	793.0	DFT-s-OFDM QPSK	50@0	0.0035	PASS	-30°C
14	15	10	158600	793.0	DFT-s-OFDM QPSK	50@0	0.0076	PASS	-20°C
14	15	10	158600	793.0	DFT-s-OFDM QPSK	50@0	0.0054	PASS	-10°C
14	15	10	158600	793.0	DFT-s-OFDM QPSK	50@0	0.0013	PASS	0°C
14	15	10	158600	793.0	DFT-s-OFDM QPSK	50@0	0.0029	PASS	10°C
14	15	10	158600	793.0	DFT-s-OFDM QPSK	50@0	0.0000	PASS	20°C
14	15	10	158600	793.0	DFT-s-OFDM QPSK	50@0	0.0064	PASS	30°C
14	15	10	158600	793.0	DFT-s-OFDM QPSK	50@0	0.0014	PASS	40°C
14	15	10	158600	793.0	DFT-s-OFDM QPSK	50@0	0.0076	PASS	50°C

Peak to Average Ratio

NR Band	SCS (kHz)	Bandwidth (MHz)	Arfcn	Freq (MHz)	Modulation	RB	Result (dB)	Limit (dB)	Verdict
14	15	5	158100	790.5	DFT-s-OFDM PI/2 BPSK	25@0	4.07	13	PASS
14	15	5	158100	790.5	DFT-s-OFDM PI/2 BPSK	1@0	3.9	13	PASS
14	15	5	158100	790.5	DFT-s-OFDM QPSK	25@0	5.4	13	PASS
14	15	5	158100	790.5	DFT-s-OFDM QPSK	1@0	5.57	13	PASS
14	15	5	158600	793.0	DFT-s-OFDM PI/2 BPSK	25@0	3.95	13	PASS
14	15	5	158600	793.0	DFT-s-OFDM PI/2 BPSK	1@0	3.87	13	PASS
14	15	5	158600	793.0	DFT-s-OFDM QPSK	25@0	5.39	13	PASS
14	15	5	158600	793.0	DFT-s-OFDM QPSK	1@0	5.44	13	PASS
14	15	5	159100	795.5	DFT-s-OFDM PI/2 BPSK	25@0	4.18	13	PASS
14	15	5	159100	795.5	DFT-s-OFDM PI/2 BPSK	1@0	3.87	13	PASS
14	15	5	159100	795.5	DFT-s-OFDM QPSK	25@0	5.34	13	PASS
14	15	5	159100	795.5	DFT-s-OFDM QPSK	1@0	5.13	13	PASS
14	15	10	158600	793.0	DFT-s-OFDM PI/2 BPSK	50@0	3.82	13	PASS
14	15	10	158600	793.0	DFT-s-OFDM PI/2 BPSK	1@0	3.88	13	PASS
14	15	10	158600	793.0	DFT-s-OFDM QPSK	50@0	5.46	13	PASS
14	15	10	158600	793.0	DFT-s-OFDM QPSK	1@0	5.5	13	PASS

N14(5M)_DFT-s-OFDM_PI_2-BPSK_Outer_Full_Low_CH



N14(5M)_DFT-s-OFDM_PI_2-BPSK_Edge_1RB_Left_Low_CH



N14(5M)_DFT-s-OFDM_QPSK_Outer_Full_Low_CH



N14(5M)_DFT-s-OFDM_QPSK_Edge_1RB_Left_Low_CH



N14(5M)_DFT-s-OFDM_PI_2-BPSK_Outer_Full_Mid_CH



N14(5M)_DFT-s-OFDM_PI_2-BPSK_Edge_1RB_Left_Mid_CH



N14(5M)_DFT-s-OFDM_QPSK_Outer_Full_Mid_CH



N14(5M)_DFT-s-OFDM_QPSK_Edge_1RB_Left_Mid_CH



N14(5M)_DFT-s-OFDM_PI_2-BPSK_Outer_Full_High_CH



N14(5M)_DFT-s-OFDM_PI_2-BPSK_Edge_1RB_Left_High_CH



N14(5M)_DFT-s-OFDM_QPSK_Outer_Full_High_CH



N14(5M)_DFT-s-OFDM_QPSK_Edge_1RB_Left_High_CH

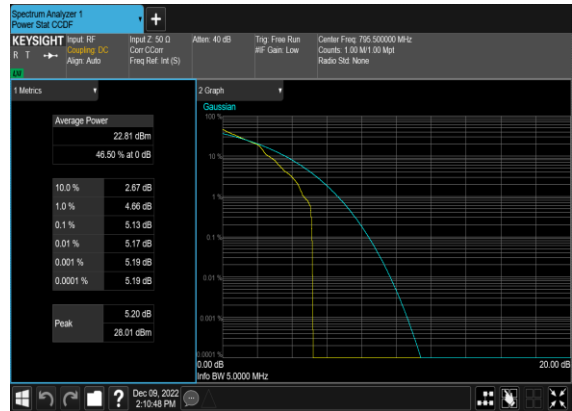

N14(10M)_DFT-s-OFDM_PI_2-BPSK_Outer_Full_Mid_CH

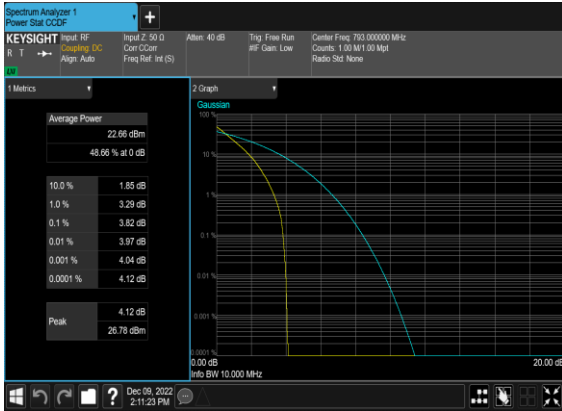

N14(10M)_DFT-s-OFDM_PI_2-BPSK_Edge_1RB_Left_Mid_CH



N14(10M)_DFT-s-OFDM_QPSK_Outer_Full_Mid_CH



N14(10M)_DFT-s-OFDM_QPSK_Edge_1RB_Left_Mid_CH



Occupied Bandwidth

NR Band	SCS (kHz)	Bandwidth (MHz)	Arfcn	Freq (MHz)	Modulation	RB	OBW (MHz)	26dB BW (MHz)
14	15	5	158600	793.0	DFT-s-OFDM PI/2 BPSK	25@0	4.4807	4.891
14	15	5	158600	793.0	DFT-s-OFDM QPSK	25@0	4.4794	4.925
14	15	5	158600	793.0	CP-OFDM QPSK	25@0	4.4692	5.062
14	15	5	158600	793.0	CP-OFDM 16 QAM	25@0	4.4912	5.179
14	15	5	158600	793.0	CP-OFDM 64 QAM	25@0	4.4579	4.96
14	15	5	158600	793.0	CP-OFDM 256 QAM	25@0	4.4793	5.019
14	15	10	158600	793.0	DFT-s-OFDM PI/2 BPSK	50@0	8.8892	9.53
14	15	10	158600	793.0	DFT-s-OFDM QPSK	50@0	8.9028	9.574
14	15	10	158600	793.0	CP-OFDM QPSK	52@0	9.2679	9.947
14	15	10	158600	793.0	CP-OFDM 16 QAM	52@0	9.2553	9.962
14	15	10	158600	793.0	CP-OFDM 64 QAM	52@0	9.2577	9.874
14	15	10	158600	793.0	CP-OFDM 256 QAM	52@0	9.275	9.867

N14(5M)_DFT-s-OFDM_PI_2-
BPSK_Outer_Full_Mid_CH



N14(5M)_DFT-s-
OFDM_QPSK_Outer_Full_Mid_CH

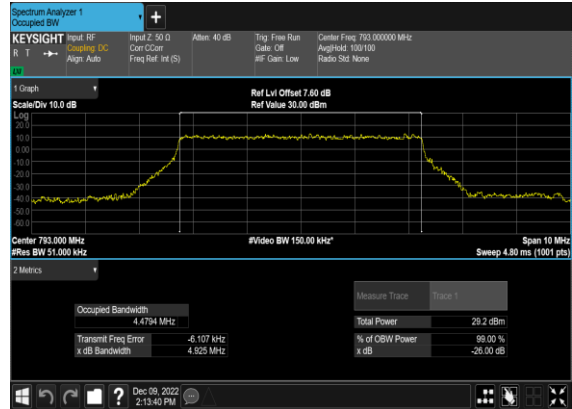

N14(5M)_CP-
OFDM_QPSK_Outer_Full_Mid_CH



N14(5M)_CP-OFDM_16
QAM_Outer_Full_Mid_CH



N14(5M)_CP-OFDM_64
QAM_Outer_Full_Mid_CH

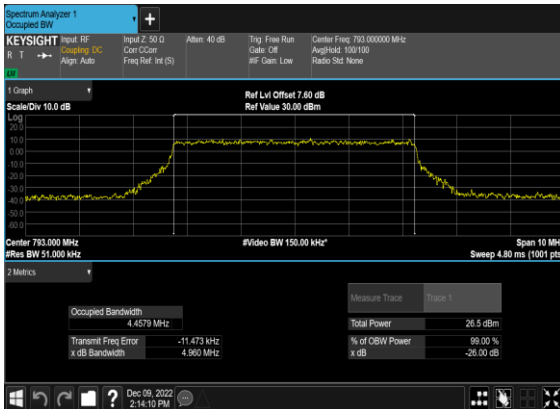

N14(5M)_CP-OFDM_256
QAM_Outer_Full_Mid_CH

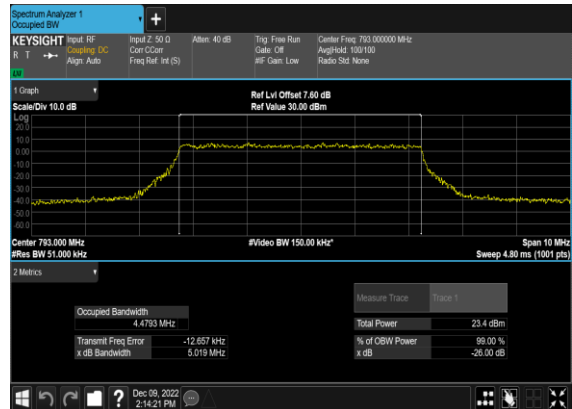

N14(10M)_DFT-s-OFDM_PI_2-
BPSK_Outer_Full_Mid_CH

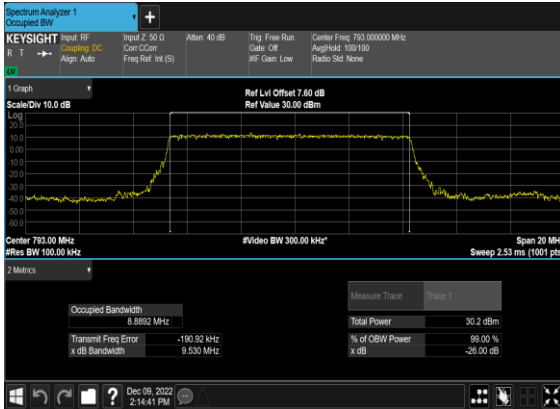

N14(10M)_DFT-s-
OFDM_QPSK_Outer_Full_Mid_CH

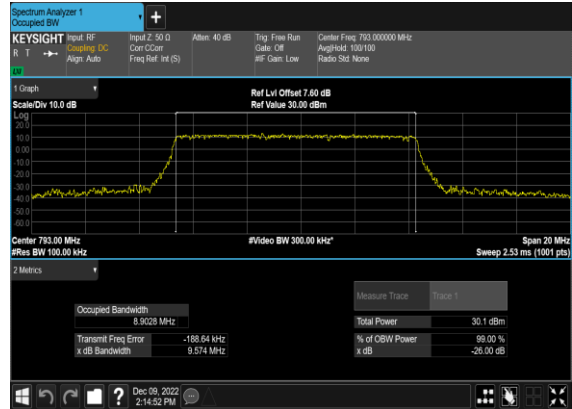

N14(10M)_CP-
OFDM_QPSK_Outer_Full_Mid_CH



N14(10M)_CP-OFDM_16
QAM_Outer_Full_Mid_CH



N14(10M)_CP-OFDM_64
QAM_Outer_Full_Mid_CH

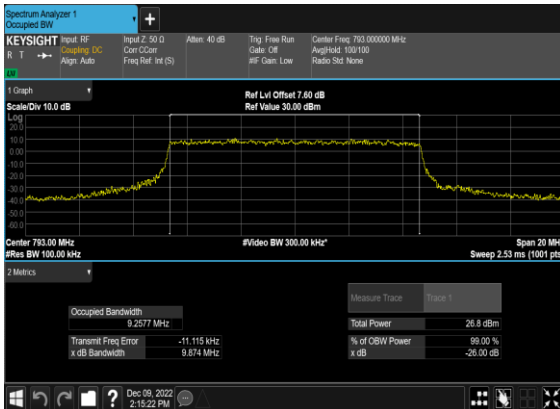

N14(10M)_CP-OFDM_256
QAM_Outer_Full_Mid_CH

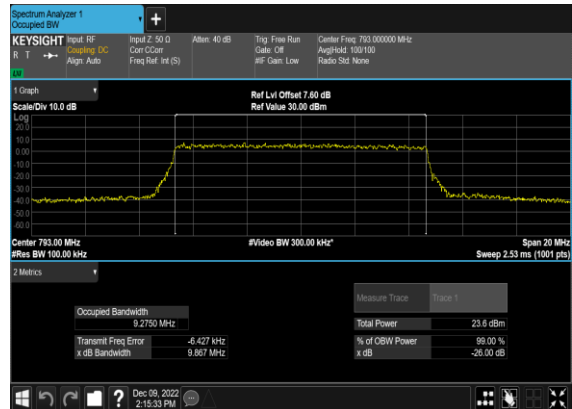

Emission Mask

NR Band	SCS (kHz)	Bandwidth (MHz)	Arfcn	Freq (MHz)	Modulation	RB	Limit (dBm/MHz)	Verdict
14	15	5	158100	790.5	DFT-s-OFDM BPSK	1@0	see graph	PASS
14	15	5	158100	790.5	DFT-s-OFDM QPSK	1@0	see graph	PASS
14	15	5	158100	790.5	DFT-s-OFDM BPSK	1@24	see graph	PASS
14	15	5	158100	790.5	DFT-s-OFDM QPSK	1@24	see graph	PASS
14	15	5	158100	790.5	DFT-s-OFDM BPSK	25@0	see graph	PASS
14	15	5	158100	790.5	DFT-s-OFDM QPSK	25@0	see graph	PASS
14	15	5	158600	793.0	DFT-s-OFDM BPSK	1@0	see graph	PASS
14	15	5	158600	793.0	DFT-s-OFDM QPSK	1@0	see graph	PASS
14	15	5	158600	793.0	DFT-s-OFDM BPSK	1@24	see graph	PASS
14	15	5	158600	793.0	DFT-s-OFDM QPSK	1@24	see graph	PASS
14	15	5	158600	793.0	DFT-s-OFDM BPSK	25@0	see graph	PASS
14	15	5	158600	793.0	DFT-s-OFDM QPSK	25@0	see graph	PASS
14	15	5	159100	795.5	DFT-s-OFDM BPSK	1@0	see graph	PASS
14	15	5	159100	795.5	DFT-s-OFDM QPSK	1@0	see graph	PASS
14	15	5	159100	795.5	DFT-s-OFDM BPSK	1@24	see graph	PASS
14	15	5	159100	795.5	DFT-s-OFDM QPSK	1@24	see graph	PASS
14	15	5	159100	795.5	DFT-s-OFDM BPSK	25@0	see graph	PASS
14	15	5	159100	795.5	DFT-s-OFDM QPSK	25@0	see graph	PASS
14	15	10	158600	793.0	DFT-s-OFDM BPSK	1@0	see graph	PASS
14	15	10	158600	793.0	DFT-s-OFDM QPSK	1@0	see graph	PASS
14	15	10	158600	793.0	DFT-s-OFDM BPSK	1@51	see graph	PASS
14	15	10	158600	793.0	DFT-s-OFDM QPSK	1@51	see graph	PASS
14	15	10	158600	793.0	DFT-s-OFDM BPSK	50@0	see graph	PASS
14	15	10	158600	793.0	DFT-s-OFDM QPSK	50@0	see graph	PASS

N14(5M)_DFT-s-OFDM_BPSK_Edge_1RB_Left_Low_CH

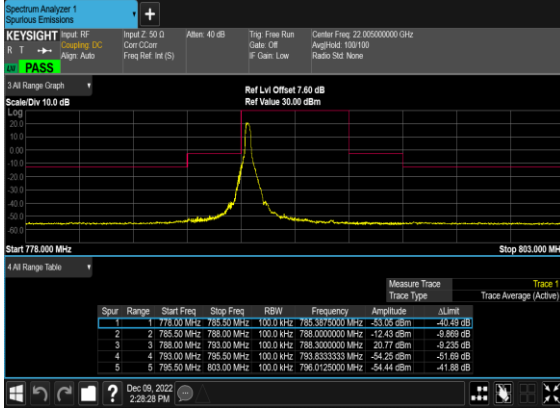

N14(5M)_DFT-s-OFDM_QPSK_Edge_1RB_Left_Low_CH

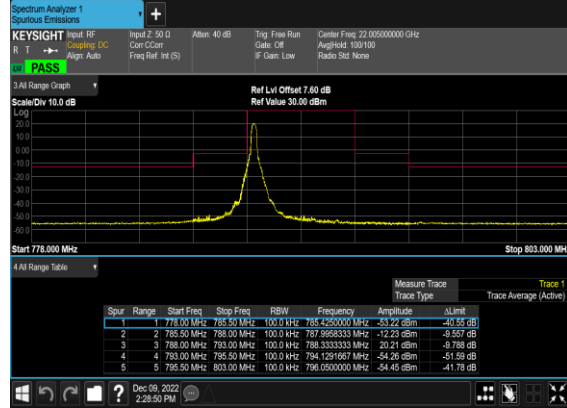

N14(5M)_DFT-s-OFDM_BPSK_Edge_1RB_Right_Low_CH

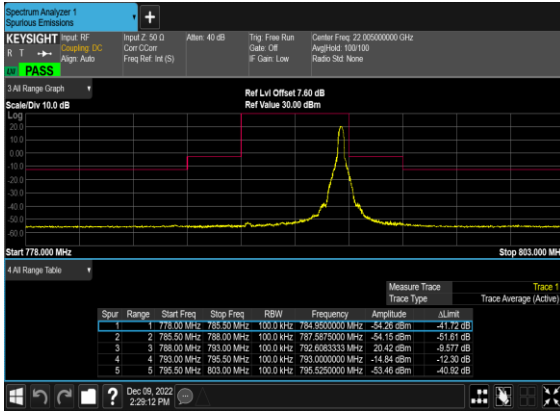

N14(5M)_DFT-s-OFDM_QPSK_Edge_1RB_Right_Low_CH

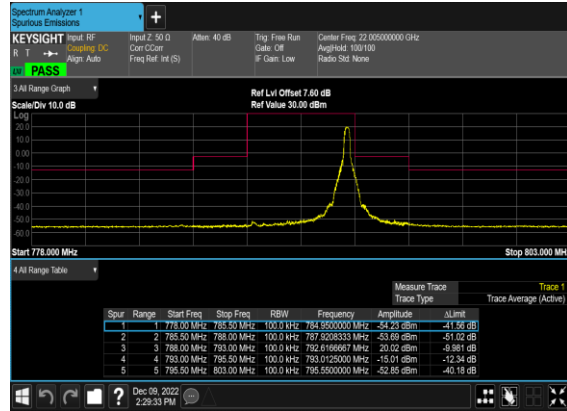

N14(5M)_DFT-s-OFDM_BPSK_Outer_Full_Low_CH

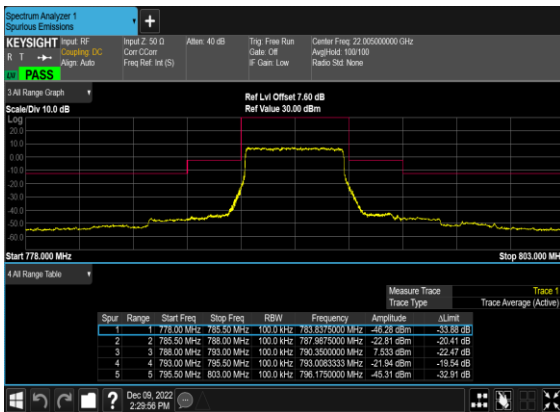

N14(5M)_DFT-s-OFDM_QPSK_Outer_Full_Low_CH

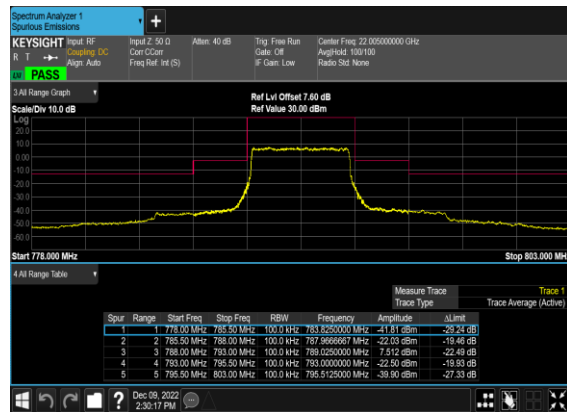

N14(5M)_DFT-s-
OFDM_BPSK_Edge_1RB_Left_Mid_CH

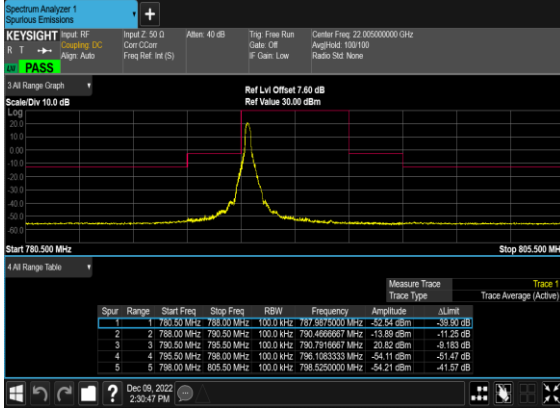

N14(5M)_DFT-s-
OFDM_QPSK_Edge_1RB_Left_Mid_CH

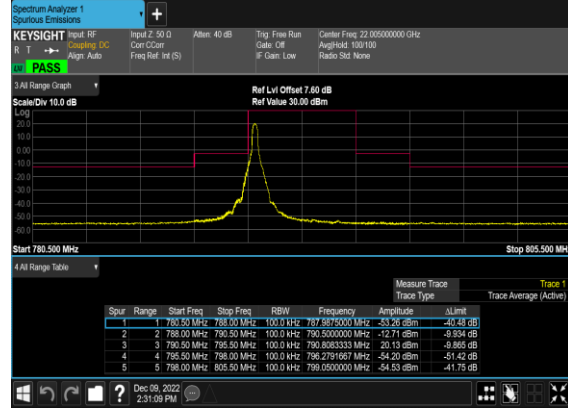

N14(5M)_DFT-s-
OFDM_BPSK_Edge_1RB_Right_Mid_CH

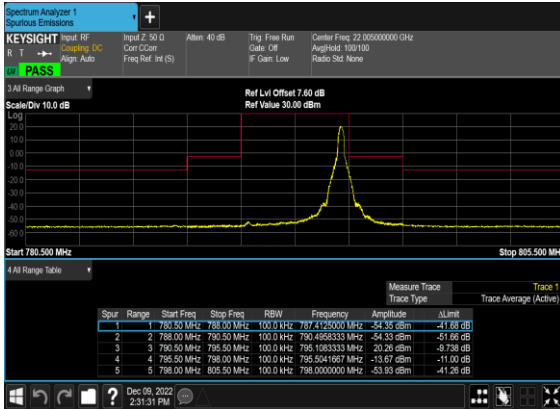

N14(5M)_DFT-s-
OFDM_QPSK_Edge_1RB_Right_Mid_CH

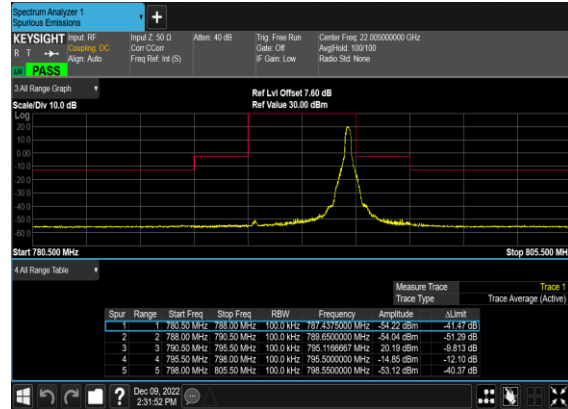

N14(5M)_DFT-s-
OFDM_BPSK_Outer_Full_Mid_CH

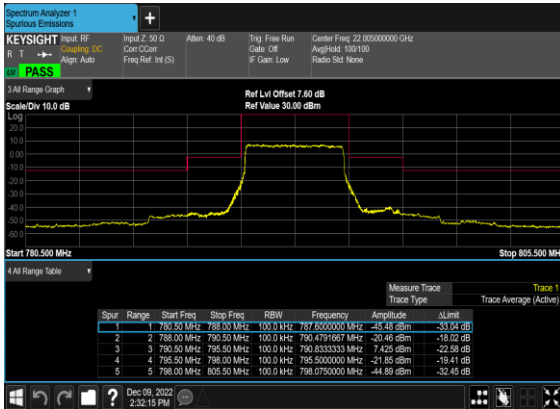

N14(5M)_DFT-s-
OFDM_QPSK_Outer_Full_Mid_CH

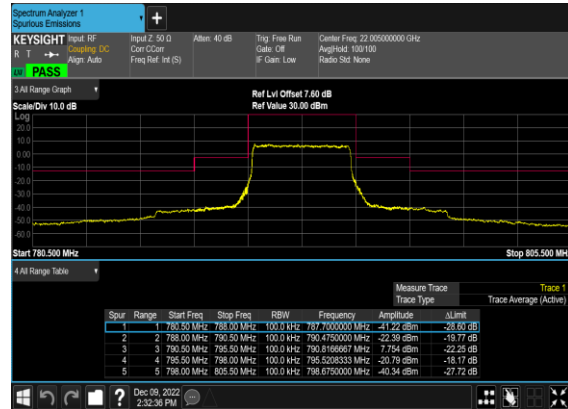

N14(5M)_DFT-s-
OFDM_BPSK_Edge_1RB_Left_High_CH

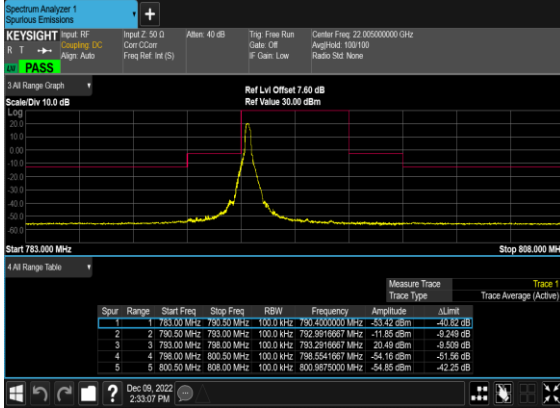

N14(5M)_DFT-s-
OFDM_QPSK_Edge_1RB_Left_High_CH

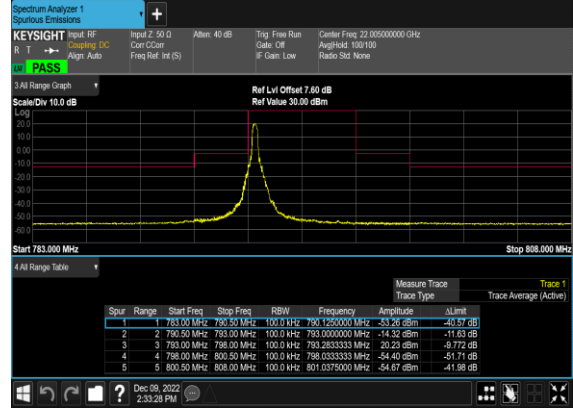

N14(5M)_DFT-s-
OFDM_BPSK_Edge_1RB_Right_High_CH

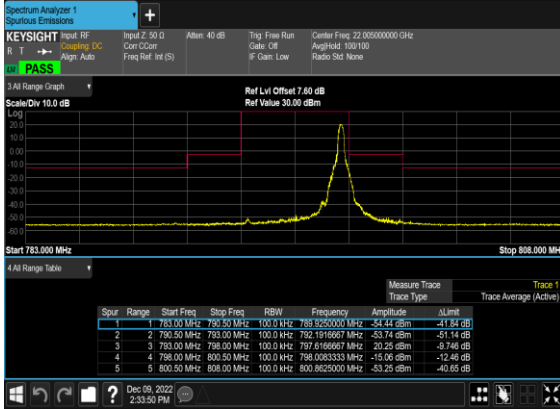

N14(5M)_DFT-s-
OFDM_QPSK_Edge_1RB_Right_High_CH

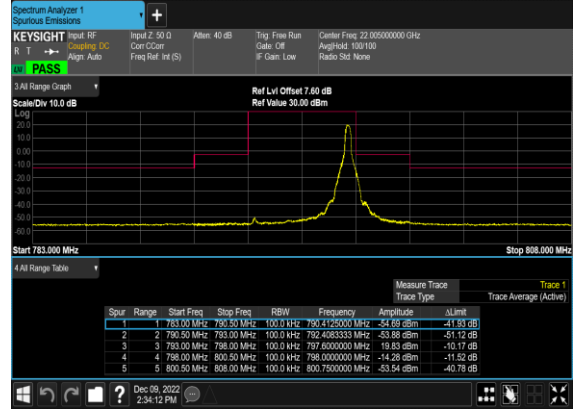

N14(5M)_DFT-s-
OFDM_BPSK_Outer_Full_High_CH

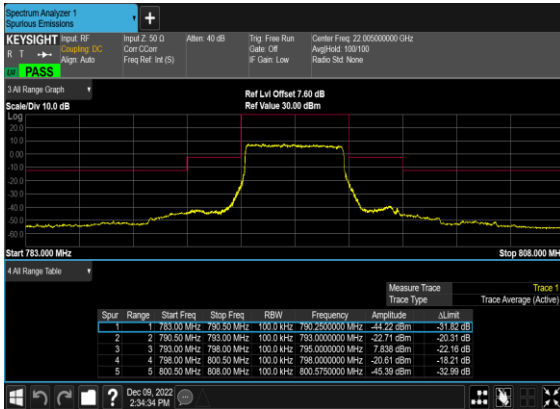

N14(5M)_DFT-s-
OFDM_QPSK_Outer_Full_High_CH

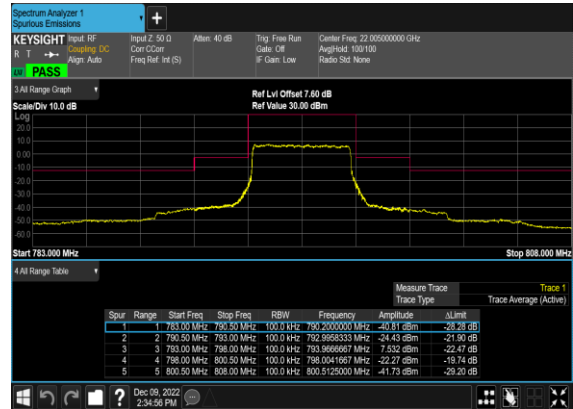

N14(10M)_DFT-s-
OFDM_BPSK_Edge_1RB_Left_Mid_CH

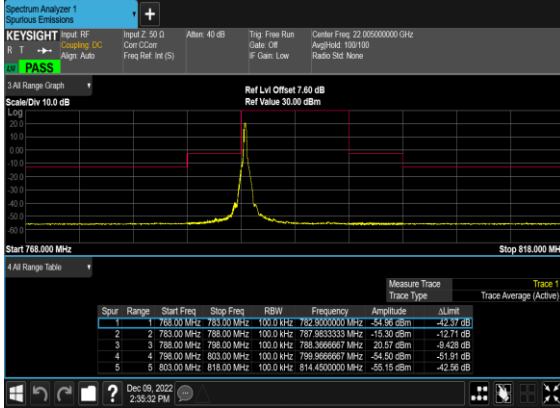

N14(10M)_DFT-s-
OFDM_QPSK_Edge_1RB_Left_Mid_CH

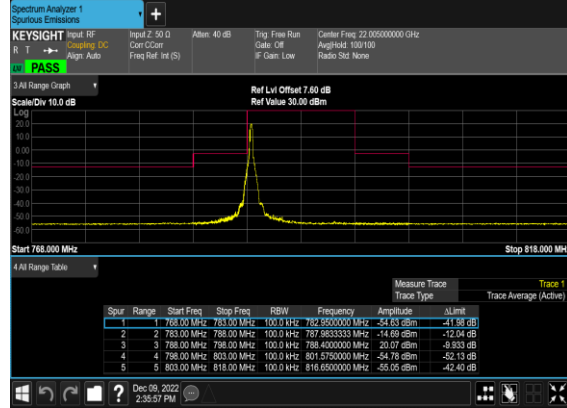

N14(10M)_DFT-s-
OFDM_BPSK_Edge_1RB_Right_Mid_CH

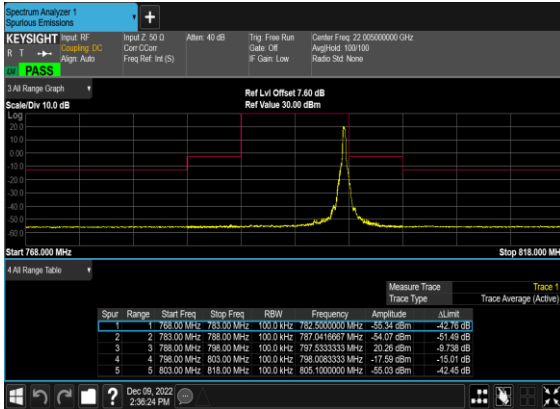

N14(10M)_DFT-s-
OFDM_QPSK_Edge_1RB_Right_Mid_CH

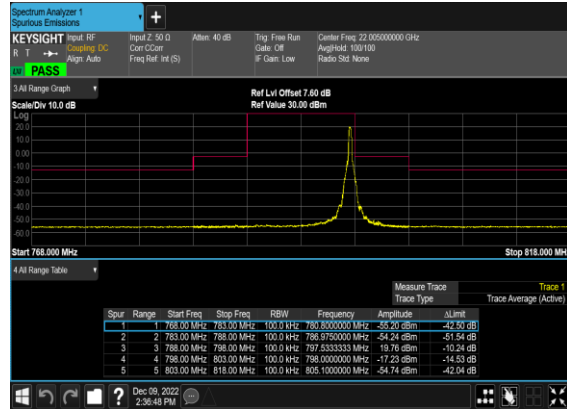

N14(10M)_DFT-s-
OFDM_BPSK_Outer_Full_Mid_CH

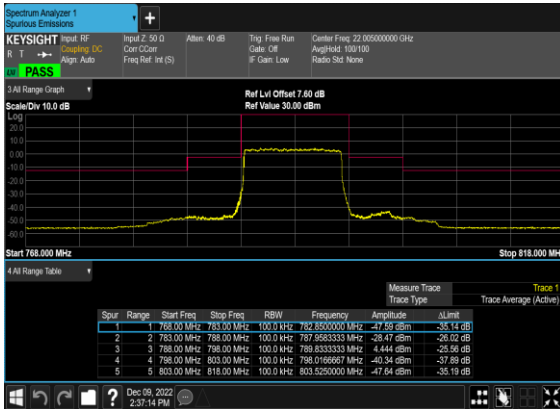

N14(10M)_DFT-s-
OFDM_QPSK_Outer_Full_Mid_CH

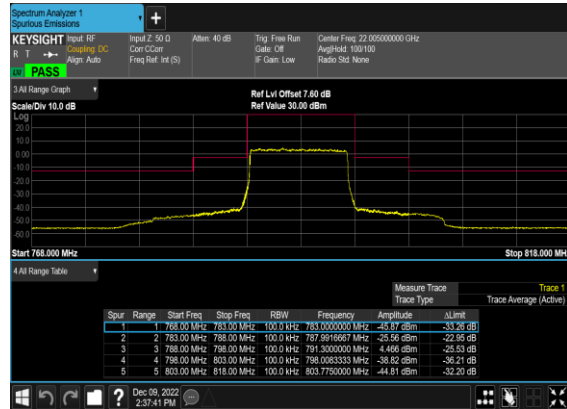

Conducted Spurious Emissions

NR Band	SCS (kHz)	Bandwidth (MHz)	Arfcn	Freq (MHz)	Modulation	RB	Result	Verdict
14	15	5	158100	790.5	DFT-s-OFDM BPSK	1@0	see graph	---
14	15	5	158100	790.5	DFT-s-OFDM BPSK	1@0	see graph	PASS
14	15	5	158100	790.5	DFT-s-OFDM QPSK	1@0	see graph	---
14	15	5	158100	790.5	DFT-s-OFDM QPSK	1@0	see graph	PASS
14	15	5	158600	793.0	DFT-s-OFDM BPSK	1@0	see graph	---
14	15	5	158600	793.0	DFT-s-OFDM BPSK	1@0	see graph	PASS
14	15	5	158600	793.0	DFT-s-OFDM QPSK	1@0	see graph	---
14	15	5	158600	793.0	DFT-s-OFDM QPSK	1@0	see graph	PASS
14	15	5	159100	795.5	DFT-s-OFDM BPSK	1@0	see graph	---
14	15	5	159100	795.5	DFT-s-OFDM BPSK	1@0	see graph	PASS
14	15	5	159100	795.5	DFT-s-OFDM QPSK	1@0	see graph	---
14	15	5	159100	795.5	DFT-s-OFDM QPSK	1@0	see graph	PASS
14	15	10	158600	793.0	DFT-s-OFDM BPSK	1@0	see graph	---
14	15	10	158600	793.0	DFT-s-OFDM BPSK	1@0	see graph	PASS
14	15	10	158600	793.0	DFT-s-OFDM QPSK	1@0	see graph	---
14	15	10	158600	793.0	DFT-s-OFDM QPSK	1@0	see graph	PASS

N14(5M)_DFT-s-OFDM_BPSK_Edge_1RB_Left_Low_CH



N14(5M)_DFT-s-OFDM_QPSK_Edge_1RB_Left_Low_CH

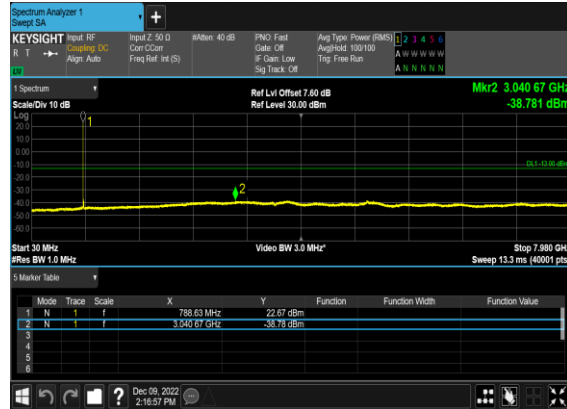

N14(5M)_DFT-s-OFDM_BPSK_Edge_1RB_Left_Mid_CH



N14(5M)_DFT-s-OFDM_QPSK_Edge_1RB_Left_Mid_CH

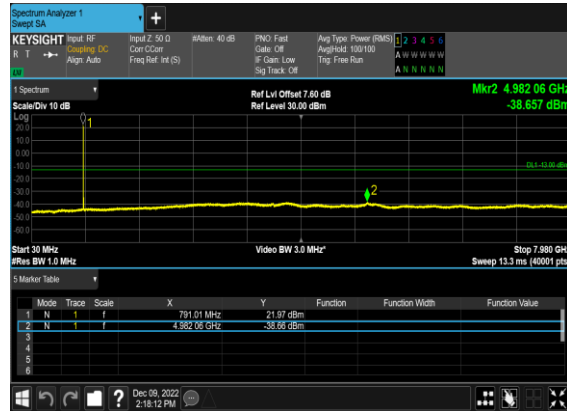

N14(5M)_DFT-s-OFDM_BPSK_Edge_1RB_Left_High_CH

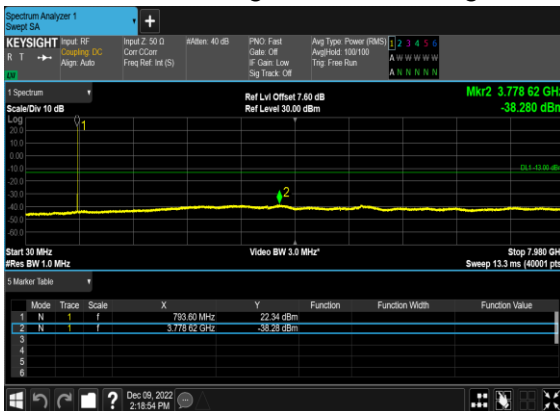

N14(5M)_DFT-s-OFDM_QPSK_Edge_1RB_Left_High_CH

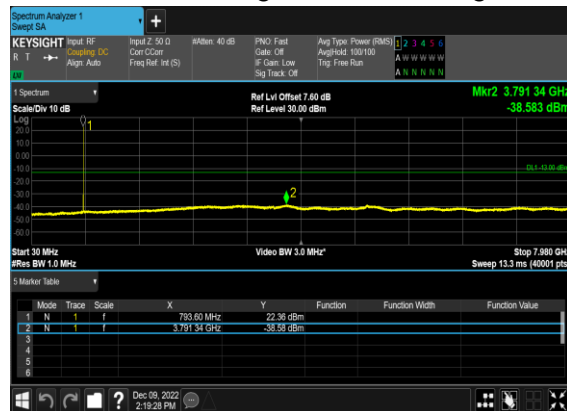

N14(10M)_DFT-s-OFDM_BPSK_Edge_1RB_Left_Mid_CH

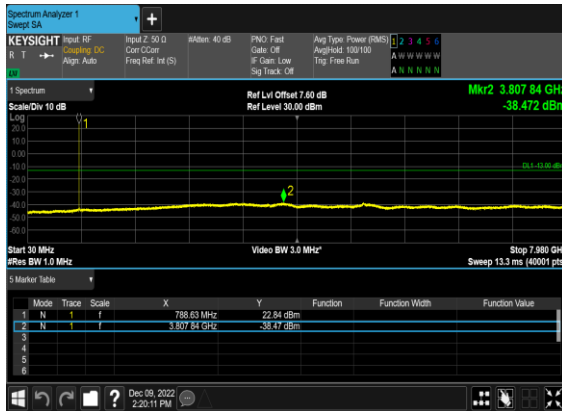

N14(10M)_DFT-s-OFDM_QPSK_Edge_1RB_Left_Mid_CH

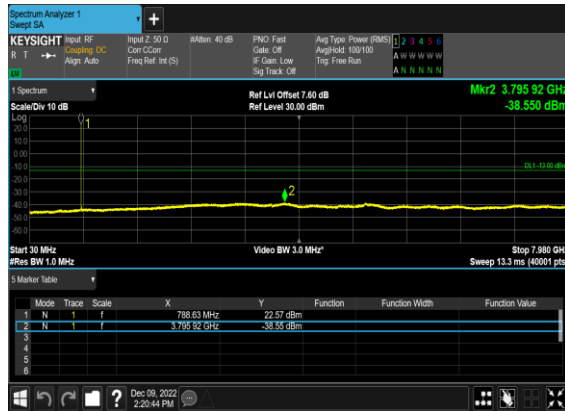

Conducted Band Edge

NR Band	SCS (kHz)	Bandwidth (MHz)	Arfcn	Freq (MHz)	Modulation	RB	Result	Verdict
14	15	5	158100	790.5	DFT-s-OFDM BPSK	1@0	see graph	PASS
14	15	5	158100	790.5	DFT-s-OFDM QPSK	1@0	see graph	PASS
14	15	5	158100	790.5	DFT-s-OFDM BPSK	25@0	see graph	PASS
14	15	5	158100	790.5	DFT-s-OFDM QPSK	25@0	see graph	PASS
14	15	5	159100	795.5	DFT-s-OFDM BPSK	1@24	see graph	PASS
14	15	5	159100	795.5	DFT-s-OFDM QPSK	1@24	see graph	PASS
14	15	5	159100	795.5	DFT-s-OFDM BPSK	25@0	see graph	PASS
14	15	5	159100	795.5	DFT-s-OFDM QPSK	25@0	see graph	PASS
14	15	10	158600	793.0	DFT-s-OFDM BPSK	1@0	see graph	PASS
14	15	10	158600	793.0	DFT-s-OFDM QPSK	1@0	see graph	PASS
14	15	10	158600	793.0	DFT-s-OFDM BPSK	1@51	see graph	PASS
14	15	10	158600	793.0	DFT-s-OFDM QPSK	1@51	see graph	PASS
14	15	10	158600	793.0	DFT-s-OFDM BPSK	50@0	see graph	PASS
14	15	10	158600	793.0	DFT-s-OFDM QPSK	50@0	see graph	PASS

N14(5M)_DFT-s-OFDM_BPSK_Edge_1RB_Left_Low_CH

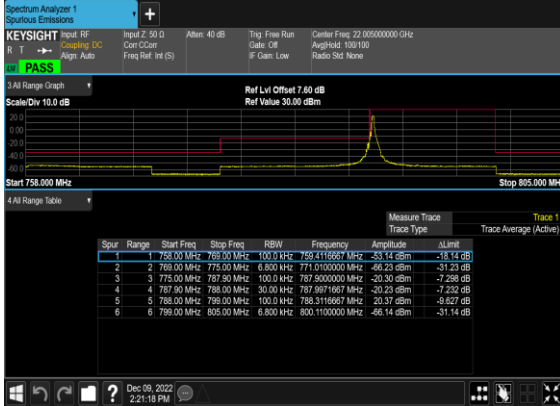

N14(5M)_DFT-s-OFDM_QPSK_Edge_1RB_Left_Low_CH

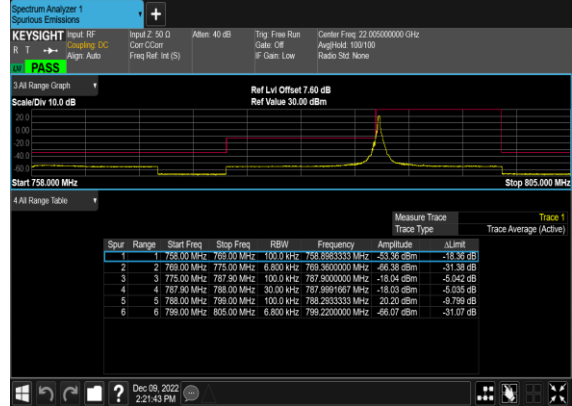

N14(5M)_DFT-s-OFDM_BPSK_Outer_Full_Low_CH

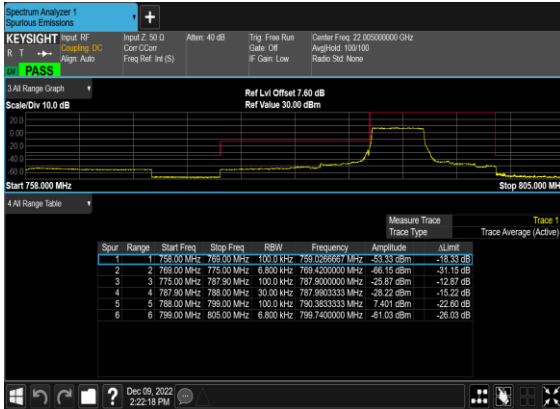

N14(5M)_DFT-s-OFDM_QPSK_Outer_Full_Low_CH

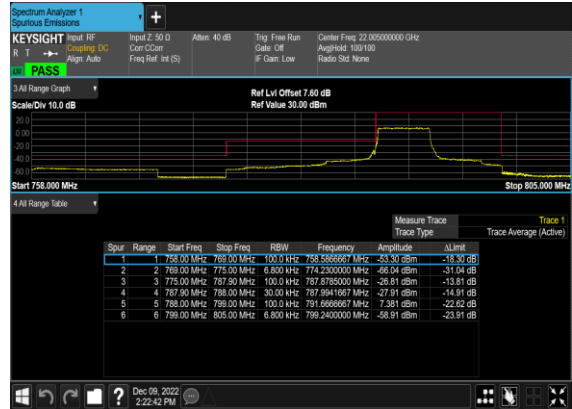

N14(5M)_DFT-s-OFDM_BPSK_Edge_1RB_Right_High_CH

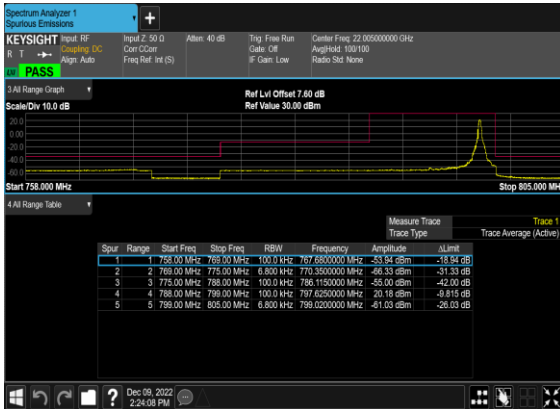

N14(5M)_DFT-s-OFDM_QPSK_Edge_1RB_Right_High_CH



N14(5M)_DFT-s-OFDM_BPSK_Outer_Full_High_CH

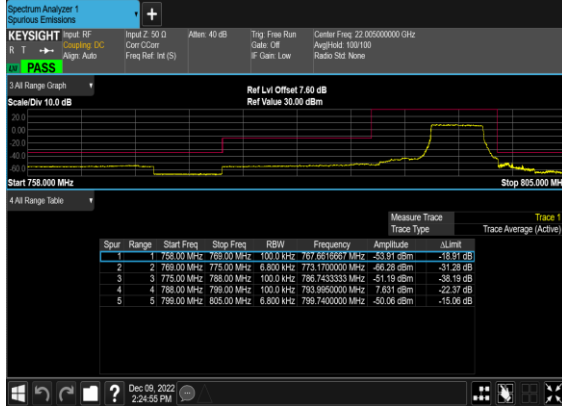

N14(5M)_DFT-s-OFDM_QPSK_Outer_Full_High_CH

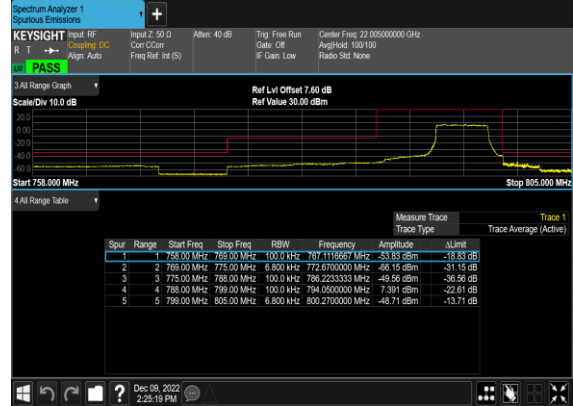

N14(10M)_DFT-s-OFDM_BPSK_Edge_1RB_Left_Mid_CH

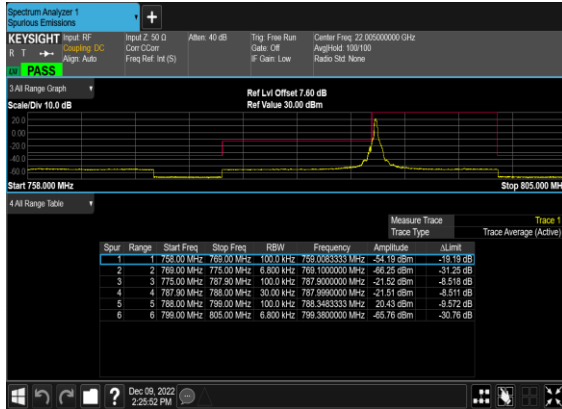

N14(10M)_DFT-s-OFDM_QPSK_Edge_1RB_Left_Mid_CH

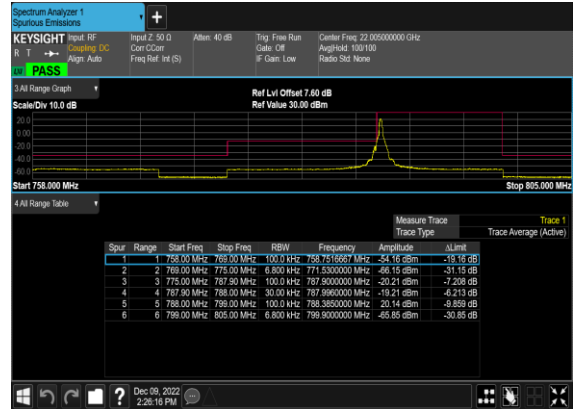

N14(10M)_DFT-s-OFDM_BPSK_Edge_1RB_Right_Mid_CH

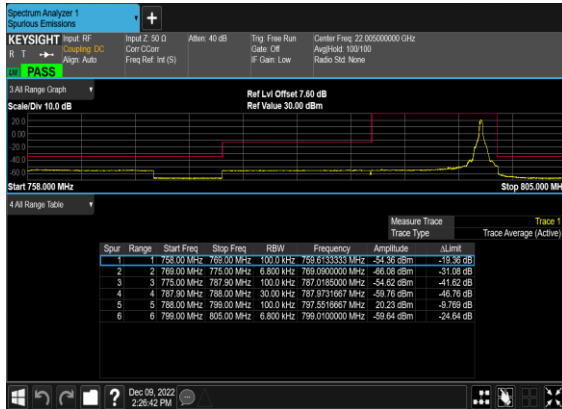

N14(10M)_DFT-s-OFDM_QPSK_Edge_1RB_Right_Mid_CH

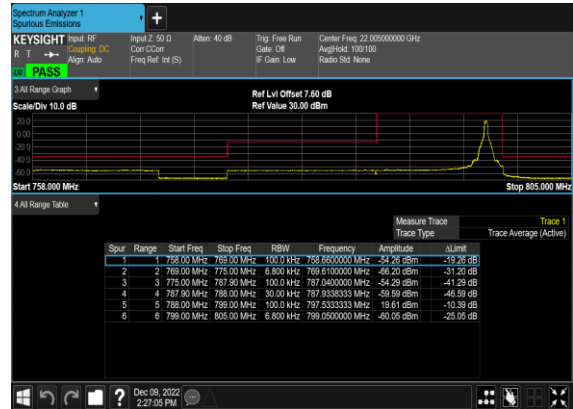

N14(10M)_DFT-s-OFDM_BPSK_Outer_Full_Mid_CH

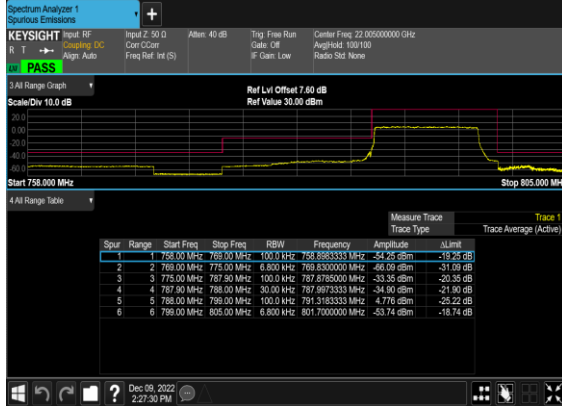

N14(10M)_DFT-s-OFDM_QPSK_Outer_Full_Mid_CH



Appendix B. Test Results of Radiated Test

Field Strength of Spurious Radiated

Test Engineer :	Hua Cong Liang	Temperature :	22~25°C
		Relative Humidity :	48~52%

SA 5G NR n14 / 5MHz / QPSK ANT0									
Channel	Frequency (MHz)	ERP (dBm)	Limit (dBm)	Over Limit (dB)	SPA Reading (dBm)	S.G. Power (dBm)	TX Cable loss (dB)	TX Antenna Gain (dBi)	Polarization (H/V)
Lowest	1576.808	-67.20	-42.15	-25.05	-73.63	-70.43	3.98	9.36	H
	2365.212	-62.57	-13	-49.57	-73.14	-66.12	4.85	10.55	H
	3153.616	-63.50	-13	-50.50	-76.32	-68.43	5.50	12.58	H
	1576.808	-67.26	-42.15	-25.11	-73.92	-70.49	3.98	9.36	V
	2365.212	-62.62	-13	-49.62	-73.59	-66.17	4.85	10.55	V
	3153.616	-63.11	-13	-50.11	-76.48	-68.04	5.50	12.58	V
Middle	1581.808	-67.76	-42.15	-25.61	-74.17	-71.01	4.00	9.40	H
	2372.712	-63.92	-13	-50.92	-74.45	-67.49	4.88	10.60	H
	3163.616	-63.35	-13	-50.35	-76.20	-68.28	5.52	12.60	H
	1581.808	-67.73	-42.15	-25.58	-74.37	-70.98	4.00	9.40	V
	2372.712	-63.52	-13	-50.52	-74.46	-67.09	4.88	10.60	V
	3160	-63.18	-13	-50.18	-76.58	-68.11	5.52	12.60	V
Highest	1586.8	-67.64	-42.15	-25.49	-73.99	-70.81	4.10	9.42	H
	2380.2	-63.07	-13	-50.07	-73.57	-66.65	4.90	10.63	H
	3173.6	-63.48	-13	-50.48	-76.38	-68.40	5.55	12.62	H
	1586.8	-67.76	-42.15	-25.61	-74.35	-70.93	4.10	9.42	V
	2380.2	-63.58	-13	-50.58	-74.49	-67.16	4.90	10.63	V
	3173.6	-63.24	-13	-50.24	-76.72	-68.16	5.55	12.62	V

Remark: Spurious emissions within 30-1000MHz were found more than 20dB below limit line.

SA 5G NR n14 / 10MHz / QPSK ANT0									
Channel	Frequency (MHz)	ERP (dBm)	Limit (dBm)	Over Limit (dB)	SPA Reading (dBm)	S.G. Power (dBm)	TX Cable loss (dB)	TX Antenna Gain (dBi)	Polarization (H/V)
Middle	1576.932	-66.87	-42.15	-24.72	-73.30	-70.12	4.00	9.40	H
	2365.398	-64.17	-13	-51.17	-74.74	-67.74	4.88	10.60	H
	3153.864	-63.24	-13	-50.24	-76.06	-68.17	5.52	12.60	H
	1576.932	-66.57	-42.15	-24.42	-73.23	-69.82	4.00	9.40	V
	2365.398	-63.83	-13	-50.83	-74.80	-67.40	4.88	10.60	V
	3153.864	-62.79	-13	-49.79	-76.16	-67.72	5.52	12.60	V

Remark: Spurious emissions within 30-1000MHz were found more than 20dB below limit line.