



FCC RF Test Report

APPLICANT : Motorola Mobility LLC
EQUIPMENT : Mobile Cellular Phone
BRAND NAME : Motorola
MODEL NAME : XT2315-1, XT2315-4, XT2315-5
FCC ID : IHDT56AL2
STANDARD : 47 CFR Part 2, 27 Subpart Q
CLASSIFICATION : PCS Licensed Transmitter Held to Ear (PCE)
TEST DATE(S) : Dec. 09, 2022 ~ Dec. 25, 2022

We, Sporton International Inc. (ShenZhen), would like to declare that the tested sample has been evaluated in accordance with the procedures given in ANSI C63.26-2015 and shown compliance with the applicable technical standards.

The test results in this report apply exclusively to the tested model / sample. Without written approval of Sporton International Inc. (ShenZhen), the test report shall not be reproduced except in full.

Jason Jia



Approved by: Jason Jia

Sporton International Inc. (ShenZhen)

1/F, 2/F, Bldg 5, Shiling Industrial Zone, Xinwei Village, Xili, Nanshan, Shenzhen, 518055

People's Republic of China



TABLE OF CONTENTS

REVISION HISTORY..... 3
SUMMARY OF TEST RESULT 4
1 GENERAL DESCRIPTION 5
1.1. Applicant 5
1.2. Manufacturer 5
1.3. Product Feature of Equipment Under Test 5
1.4. Product Specification of Equipment Under Test 5
1.5. Modification of EUT 6
1.6. Specification of Accessory 6
1.7. Maximum EIRP Power and Emission Designator 7
1.8. Testing Site 8
1.9. Test Software 8
1.10. Applied Standards 8
2 TEST CONFIGURATION OF EQUIPMENT UNDER TEST 9
1.11. Test Mode 9
1.12. Connection Diagram of Test System 10
1.13. Support Unit used in test configuration and system 10
1.14. Measurement Results Explanation Example 10
1.15. Frequency List of Low/Middle/High Channels 11
3 CONDUCTED TEST ITEMS 12
1.16. Measuring Instruments 12
1.17. Test Setup 12
1.18. Test Result of Conducted Test 12
1.19. Conducted Output Power Measurement 13
1.20. Peak-to-Average Ratio 14
1.21. EIRP 15
1.22. Occupied Bandwidth 16
1.23. Conducted Band Edge Measurement 17
1.24. Conducted Spurious Emission Measurement 18
1.25. Frequency Stability Measurement 19
4 RADIATED TEST ITEMS 20
1.26. Measuring Instruments 20
1.27. Test Setup 20
1.28. Test Result of Radiated Test 21
1.29. Radiated Spurious Emission Measurement 22
5 LIST OF MEASURING EQUIPMENT 23
6 UNCERTAINTY OF EVALUATION 24
APPENDIX A. TEST RESULTS OF CONDUCTED TEST
APPENDIX B. TEST RESULTS OF RADIATED TEST
APPENDIX C. TEST SETUP PHOTOGRAPHS



SUMMARY OF TEST RESULT

Report Section	FCC Rule	Description	Limit	Result	Remark
1.19	§2.1046	Conducted Output Power	—	Report Only	-
1.20	§27.50 (k)(4)	Peak-to-Average Ratio	<13dB	PASS	
1.21	§27.50 (k)(3)	EIRP	EIRP < 1W (30dBm)	PASS	-
1.22	§2.1049	Occupied Bandwidth	—	Report Only	-
1.23	§2.1051 §27.53 (n)(2)	Conducted Band Edge Measurement	-13dBm/MHz	PASS	-
1.24	§2.1051 §27.53 (n)(2)	Conducted Spurious Emission	-13dBm/MHz	PASS	-
1.25	§2.1055 §27.54	Frequency Stability Temperature & Voltage	Within the band	PASS	-
1.29	§2.1053 §27.53 (n)(2)	Radiated Spurious Emission	-13dBm/MHz	PASS	Under limit 23.18 dB at 6902.400 MHz

Declaration of Conformity:
The test results with all measurement uncertainty excluded are presented in accordance with the regulation limits or requirements declared by manufacturers.

Comments and Explanations:
The declared of product specification for EUT presented in the report are provided by the manufacturer, and the manufacturer takes all the responsibilities for the accuracy of product specification.



1 General Description

1.1. Applicant

Motorola Mobility LLC
222 W, Merchandise Mart Plaza, Chicago IL 60654 USA

1.2. Manufacturer

Motorola Mobility LLC
222 W, Merchandise Mart Plaza, Chicago IL 60654 USA

1.3. Product Feature of Equipment Under Test

Product Feature	
Equipment	Mobile Cellular Phone
Brand Name	Motorola
Model Name	XT2315-1, XT2315-4, XT2315-5
FCC ID	IHDT56AL2
IMEI Code	Conducted : 359709930025070/359709930025112 Radiation : 359709930025237/359709930025245
HW Version	DVT2
SW Version	T1TGN33.33
EUT Stage	Identical Prototype

Remark: Only 5G NR bands are tested in this report, all the other RF bands are tested in the other reports separately.

1.4. Product Specification of Equipment Under Test

Product Feature	
Tx/Rx Frequency	5G NR n77: 3450 MHz ~ 3550 MHz 5G NR n78: 3450 MHz ~ 3550 MHz
SCS	30kHz
Bandwidth	10 / 15 / 20 / 30 / 40 / 50 / 60 / 70 / 80 / 90 / 100MHz
Antenna Gain	Ant. 2: 5G NR n77: -4.0 dBi 5G NR n78: -4.0 dBi Ant. 5: 5G NR n77: -6.5 dBi 5G NR n78: -6.5 dBi Ant. 8: 5G NR n77: -6.0 dBi 5G NR n78: -6.5 dBi Ant. 10: 5G NR n77: -7.0 dBi 5G NR n78: -7.0 dBi
Type of Modulation	CP-OFDM: QPSK / 16QAM / 64QAM / 256QAM DFT-s-OFDM: PI/2 BPSK / QPSK / 16QAM / 64QAM / 256QAM

Remark:

1. The maximum EIRP is calculated from max output power and max antenna gain, only the maximum EIRP is shown in the report, 5G NR n77/n78 for Antenna 2.
2. The device supports n77(1T4R) SRS resources on Antenna 2/5/8/10, only the test data of worst Antenna 2 is showed in the report according to the maximum power.
3. 5G NR n77/n78 support SA and NSA mode. The whole testing has assessed SA mode for n77 by referring to the higher conducted power for conducted test items.
4. 5G NR Band n77 overlaps the entire frequency range of Band n78, and n77 power > n78 power, therefore the conducted test results of n77 provided in this report cover n78.
5. The device supports HPUE mode for 5G NR n77.
6. For 5G NR n77, all the supported EN-DC combinations are verified conducted power, only the EN-DC combination with highest power are shown in the report.
7. The EN-DC mode combination could be referred to the product spec.

1.5. Modification of EUT

No modifications are made to the EUT during all test items.

1.6. Specification of Accessory

Specification of Accessory				
AC Adapter 1	Brand Name	Motorola(Chenyang)	Model Name	MC-101
AC Adapter 2	Brand Name	Motorola(Salcomp)	Model Name	MC-101
AC Adapter 3	Brand Name	Motorola(AOHAI)	Model Name	MC-101
AC Adapter 4	Brand Name	Motorola(Salcomp)	Model Name	MC-101
Battery 1	Brand Name	Motorola(ATL)	Model Name	PG50
Battery 2	Brand Name	Motorola(SCUD)	Model Name	PG50
USB Cable 1	Brand Name	Motorola(Saibao)	Model Name	SC18D22297
USB Cable 2	Brand Name	Motorola(Cabletech)	Model Name	SC18D22298
USB Cable 3	Brand Name	Motorola(Luxshare)	Model Name	SC18D22299

1.7. Maximum EIRP Power and Emission Designator

5G NR n77 SA		PI/2 BPSK / QPSK		16QAM / 64QAM / 256QAM	
BW (MHz)	Frequency Range (MHz)	Maximum EIRP(W)	Emission Designator (99%OBW)	Maximum EIRP(W)	Emission Designator (99%OBW)
10	3455.01 ~ 3544.98	0.1754	8M59G7D	0.1754	8M60W7D
15	3457.5 ~ 3542.49	0.1824	13M6G7D	0.1828	13M6W7D
20	3460.02 ~ 3540	0.1832	18M2G7D	0.1858	18M2W7D
30	3465 ~ 3534.99	0.1845	27M8G7D	0.1888	27M9W7D
40	3470.01 ~ 3529.98	0.1884	37M8G7D	0.1910	37M9W7D
50	3475.02 ~ 3525	0.1799	47M5G7D	0.1832	47M5W7D
60	3480 ~ 3519.99	0.1799	57M9G7D	0.1828	57M9W7D
70	3485.01 ~ 3514.98	0.1786	67M5G7D	0.1824	67M4W7D
80	3490.02 ~ 3510	0.1750	77M4G7D	0.1786	77M5W7D
90	3495 ~ 3504.99	0.1762	87M4G7D	0.1778	87M5W7D
100	3500.01 ~ 3500.01	0.1919	97M4G7D	0.1791	97M5W7D

5G NR n78 SA		PI/2 BPSK / QPSK		16QAM / 64QAM / 256QAM	
BW (MHz)	Frequency Range (MHz)	Maximum EIRP(W)	Emission Designator (99%OBW)	Maximum EIRP(W)	Emission Designator (99%OBW)
10	3455.01 ~ 3544.98	0.0847	8M59G7D	0.0853	8M60W7D
15	3457.5 ~ 3542.49	0.0861	13M6G7D	0.0889	13M6W7D
20	3460.02 ~ 3540	0.0883	18M2G7D	0.0899	18M2W7D
30	3465 ~ 3534.99	0.0904	27M8G7D	0.0914	27M9W7D
40	3470.01 ~ 3529.98	0.0908	37M8G7D	0.0910	37M9W7D
50	3475.02 ~ 3525	0.0857	47M5G7D	0.0853	47M5W7D
60	3480 ~ 3519.99	0.0875	57M9G7D	0.0879	57M9W7D
70	3485.01 ~ 3514.98	0.0849	67M5G7D	0.0857	67M4W7D
80	3490.02 ~ 3510	0.0843	77M4G7D	0.0863	77M5W7D
90	3495 ~ 3504.99	0.0830	87M4G7D	0.0857	87M5W7D
100	3500.01 ~ 3500.01	0.0927	97M4G7D	0.0857	97M5W7D

Note:

- 5G NR Band n77 overlaps the entire frequency range of Band n78, and n77 power > n78 power, therefore the conducted test results of n77 provided in this report cover n78.
- All modulations have been tested, and only the worst test results of PSK & QAM are shown in the report.



1.8. Testing Site

Sporton International Inc. (Shenzhen) is accredited to ISO/IEC 17025:2017 by American Association for Laboratory Accreditation with Certificate Number 5145.01.

Test Firm	Sporton International Inc. (Shenzhen)		
Test Site Location	1/F, 2/F, Bldg 5, Shiling Industrial Zone, Xinwei Village, Xili, Nanshan, Shenzhen, 518055 People's Republic of China TEL: +86-755-86379589 FAX: +86-755-86379595		
Test Site No.	Sporton Site No.	FCC Designation No.	FCC Test Firm Registration No.
	TH01-SZ	CN1256	421272

Test Firm	Sporton International Inc. (Shenzhen)		
Test Site Location	101, 1st Floor, Block B, Building 1, No. 2, Tengfeng 4th Road, Fenghuang Community, Fuyong Street, Baoan District, Shenzhen City Guangdong Province China 518103 TEL: +86-755-33202398		
Test Site No.	Sporton Site No.	FCC Designation No.	FCC Test Firm Registration No.
	03CH03-SZ	CN1256	421272

1.9. Test Software

Item	Site	Manufacturer	Name	Version
1.	03CH03-SZ	AUDIX	E3	6.2009-8-24

1.10. Applied Standards

According to the specifications of the manufacturer, the EUT must comply with the requirements of the following standards:

- 47 CFR Part 2, 27Q
- ANSI C63.26-2015
- FCC KDB 971168 Power Meas License Digital Systems D01 v03r01
- FCC KDB 412172 D01 Determining ERP and EIRP v01r01

Remark: All test items were verified and recorded according to the standards and without any deviation during the test.

2 Test Configuration of Equipment Under Test

1.11. Test Mode

Antenna port conducted and radiated test items listed below are performed according to KDB 971168 D01 Power Meas. License Digital Systems v03r01 with maximum output power.

For radiated measurement, pre-scanned in three orthogonal panels, X, Y, Z. The worst cases (Y plane) were recorded in this report.

Test Items	5G NR	Bandwidth (MHz)									Modulation					RB #		Test Channel		
		10	15	20	25	30	40	50	60-90	100	PI/2 BPSK	QPSK	16QAM	64QAM	256 QAM	1	Full	L	M	H
Max. Output Power	n77	v	v	v		v	v	v	v	v	v	v	v	v	v	v	v	v	v	v
	n78	v	v	v		v	v	v	v	v	v	v	v	v	v	v	v	v	v	v
Peak-to-Average Ratio	n77			v							v	v				v	v	v	v	v
26dB and 99% Bandwidth	n77	v	v	v		v	v	v	v	v	v	v	v	v	v		v		v	
Conducted Band Edge	n77	v						v		v	v	v				v	v	v		v
Conducted Spurious Emission	n77	v						v		v	v	v				v		v	v	v
Frequency Stability	n77			v								v					v		v	
E.I.R.P.	n77	v	v	v		v	v	v	v	v	v	v	v	v	v	v	v	v	v	v
Radiated Spurious Emission	n77	Worst Case																v	v	v
Note	<ol style="list-style-type: none"> The mark "v " means that this configuration is chosen for testing The mark "-" means that this bandwidth is not supported. The device is investigated from 30MHz to 10 times of fundamental signal for radiated spurious emission test under different RB size/offset and modulations in exploratory test. Subsequently, only the worst case emissions are reported. Normal Voltage: 3.89Vdc, Extreme Voltage: 3.5Vdc ~4.48Vdc 																			

1.12. Connection Diagram of Test System

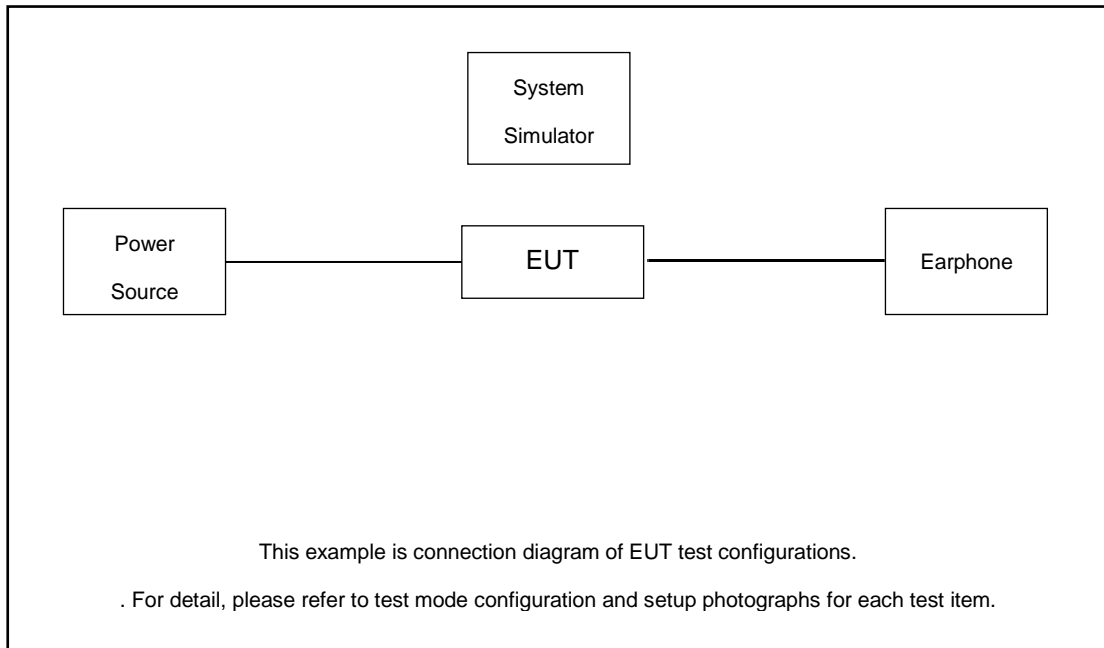

1.13. Support Unit used in test configuration and system

Item	Equipment	Trade Name	Model No.	FCC ID	Data Cable	Power Cord
1.	Power Supply	GWINSTEK	PSS-2002	N/A	N/A	Unshielded, 1.8 m
2.	LTE Base Station	Anritsu	MT8821C	N/A	N/A	Unshielded, 1.8 m
3.	NR Base Station	Anritsu	MT8000A	N/A	N/A	Unshielded, 1.8 m
4.	Earphone	Moto	N/A	N/A	N/A	N/A

1.14. Measurement Results Explanation Example

For all conducted test items:

The offset level is set in the spectrum analyzer to compensate the RF cable loss between EUT conducted output port and spectrum analyzer. With the offset compensation, the spectrum analyzer reading level is exactly the EUT RF output level.

The spectrum analyzer offset is derived from RF cable loss.

$$\text{Offset} = \text{RF cable loss.}$$

Following shows an offset computation example with cable loss 8.7 dB.

Example :

$$\text{Offset(dB)} = \text{RF cable loss(dB).}$$

= 8.7 (dB)

1.15. Frequency List of Low/Middle/High Channels

5G n77/n78 Channel and Frequency List-30kHz				
BW [MHz]	Channel/Frequency(MHz)	Lowest	Middle	Highest
100	Channel	-	633334	-
	Frequency	-	3500.01	-
90	Channel	633000	633334	633666
	Frequency	3495	3500.01	3504.99
80	Channel	632668	633334	634000
	Frequency	3490.02	3500.01	3510
70	Channel	632334	633334	634332
	Frequency	3485.01	3500.01	3514.98
60	Channel	632000	633334	634666
	Frequency	3480	3500.01	3519.99
50	Channel	631668	633334	635000
	Frequency	3475.02	3500.01	3525
40	Channel	631334	633334	635332
	Frequency	3470.01	3500.01	3529.98
30	Channel	631000	633334	635666
	Frequency	3465	3500.01	3534.99
20	Channel	630668	633334	636000
	Frequency	3460.02	3500.01	3540
15	Channel	630500	633334	636166
	Frequency	3457.5	3500.01	3542.49
10	Channel	630334	633334	636332
	Frequency	3455.01	3500.01	3544.98

3 Conducted Test Items

1.16. Measuring Instruments

See list of measuring instruments of this test report.

1.17. Test Setup

3.1.1 Conducted Output Power

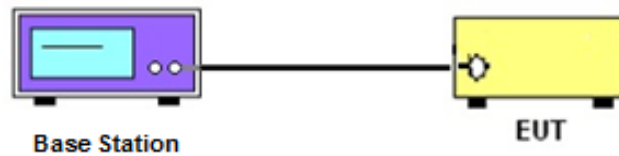

3.1.2 Peak-to-Average Ratio, Occupied / 26dB Bandwidth ,Band-Edge and Conducted Spurious Emission

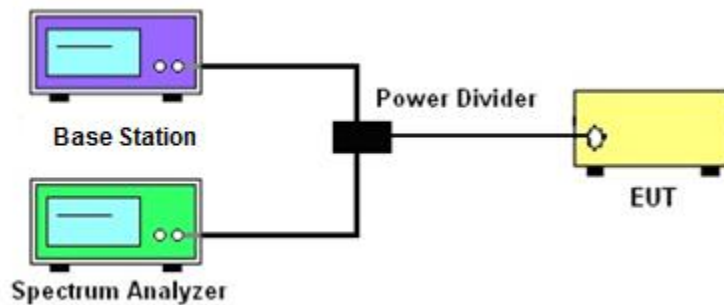

3.1.3 Frequency Stability

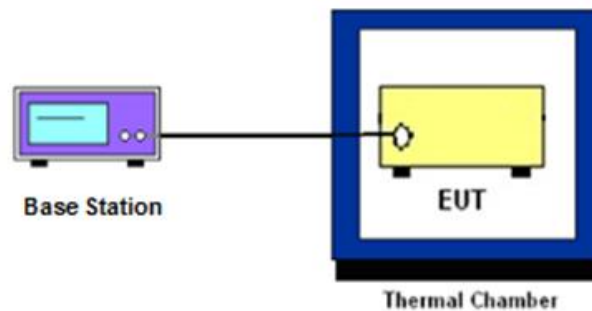

1.18. Test Result of Conducted Test

Please refer to Appendix A.

1.19. Conducted Output Power Measurement

3.1.4 Description of the Conducted Output Power Measurement

A base station simulator was used to establish communication with the EUT. Its parameters were set to transmit the maximum power on the EUT. The measured power in the radio frequency on the transmitter output terminals shall be reported.

3.1.5 Test Procedures

1. The testing follows ANSI C63.26 Section 5.2
2. The transmitter output port was connected to the system simulator.
3. Set EUT at maximum power through the system simulator.
4. Select lowest, middle, and highest channels for each band and different modulation.
5. Measure and record the power level from the system simulator.

1.20. Peak-to-Average Ratio

3.1.6 Description of the PAR Measurement

Power Complementary Cumulative Distribution Function (CCDF) curves provide a means for characterizing the power peaks of a digitally modulated signal on a statistical basis. A CCDF curve depicts the probability of the peak signal amplitude exceeding the average power level. Most contemporary measurement instrumentation include the capability to produce CCDF curves for an input signal provided that the instrument's resolution bandwidth can be set wide enough to accommodate the entire input signal bandwidth. In measuring transmissions in this band using an average power technique, the peak-to-average ratio (PAR) of the transmission may not exceed 13 dB.

3.1.7 Test Procedures

1. The testing follows ANSI C63.26 Section 5.2.3.4 (CCDF).
2. The EUT was connected to spectrum and system simulator via a power divider.
3. Set the CCDF (Complementary Cumulative Distribution Function) option in spectrum analyzer.
4. The highest RF powers were measured and recorded the maximum PAPR level associated with a probability of 0.1 %.
5. Record the deviation as Peak to Average Ratio.



1.21. EIRP

3.1.8 Description of EIRP Limit

§ 27.50 (k)(3)

Mobile devices are limited to 1Watt (30 dBm) EIRP. Mobile devices operating in these bands must employ a means for limiting power to the minimum necessary for successful communications

3.1.9 Test Procedures

1. According to KDB 412172 D01 Power Approach,
2. $EIRP = P_T + G_T - L_C$, $ERP = EIRP - 2.15$, where
 P_T = transmitter output power in dBm
 G_T = gain of the transmitting antenna in dBi
 L_C = signal attenuation in the connecting cable between the transmitter and antenna in dB

1.22. Occupied Bandwidth

3.1.10 Description of Occupied Bandwidth Measurement

The occupied bandwidth is the width of a frequency band such that, below the lower and above the upper frequency limits, the mean powers emitted are each equal to a specified percentage 0.5% of the total mean transmitted power.

The 26 dB emission bandwidth is defined as the frequency range between two points, one above and one below the carrier frequency, at which the spectral density of the emission is attenuated 26 dB below the maximum in-band spectral density of the modulated signal. Spectral density (power per unit bandwidth) is to be measured with a detector of resolution bandwidth equal to approximately 1.0% of the emission bandwidth.

3.1.11 Test Procedures

1. The testing follows ANSI C63.26 Section 5.4
2. The EUT was connected to spectrum analyzer and system simulator via a power divider.
3. The spectrum analyzer center frequency is set to the nominal EUT channel center frequency. The span range for the spectrum analyzer shall be between two and five times the anticipated OBW.
4. The nominal resolution bandwidth (RBW) shall be in the range of 1 to 5 % of the anticipated OBW, and the VBW shall be at least 3 times the RBW.
5. Set the detection mode to peak, and the trace mode to max hold.
6. Determine the reference value: Set the EUT to transmit a modulated signal. Allow the trace to stabilize. Set the spectrum analyzer marker to the highest level of the displayed trace.
(this is the reference value)
7. Determine the “-26 dB down amplitude” as equal to (Reference Value – X).
8. Place two markers, one at the lowest and the other at the highest frequency of the envelope of the spectral display such that each marker is at or slightly below the “-X dB down amplitude” determined in step 6. If a marker is below this “-X dB down amplitude” value it shall be placed as close as possible to this value. The OBW is the positive frequency difference between the two markers.
9. Use the 99 % power bandwidth function of the spectrum analyzer and report the measured bandwidth.

1.23. Conducted Band Edge Measurement

3.1.12 Description of Conducted Band Edge Measurement

§ 27.53 (n)(2)

For mobile operations in the 3450-3550 MHz band, the conducted power of any emission outside the licensee's authorized bandwidth shall not exceed -13 dBm/MHz.

Compliance with this paragraph is based on the use of measurement instrumentation employing a resolution bandwidth of 1 megahertz or greater. However, in the 1 megahertz bands immediately outside and adjacent to the licensee's frequency block, a resolution bandwidth of at least one percent of the emission bandwidth of the fundamental emission of the transmitter may be employed, but limited to a maximum of 200 kHz. In the bands between 1 and 5 MHz removed from the licensee's frequency block, the minimum resolution bandwidth for the measurement shall be 500 kHz.

3.1.13 Test Procedures

1. The testing follows ANSI C63.26 section 5.7
2. The EUT was connected to spectrum analyzer and system simulator via a power divider.
3. The band edges of low and high channels for the highest RF powers were measured.
4. Set RBW \geq 1% EBW but limited to a maximum of 200 kHz in the 1MHz band immediately outside and adjacent to the band edge.
5. Beyond the 1 MHz and 5 MHz removed from the band edge, set RBW \geq 500KHz.
6. Beyond the 5 MHz removed from the band edge, set RBW = 1MHz.
7. Set spectrum analyzer with RMS detector.
8. The RF fundamental frequency should be excluded against the limit line in the operating frequency band.
9. Checked that all the results comply with the emission limit line.

1.24. Conducted Spurious Emission Measurement

3.1.14 Description of Conducted Spurious Emission Measurement

The power of any emission outside of the authorized operating frequency ranges shall not exceed -13 dBm/MHz.

It is measured by means of a calibrated spectrum analyzer and scanned from 9 kHz up to a frequency including its 10th harmonic.

3.1.15 Test Procedures

1. The testing follows ANSI C63.26 section 5.7
2. The EUT was connected to spectrum analyzer and system simulator via a power divider.
3. The RF output of EUT was connected to the spectrum analyzer by RF cable and attenuator. The path loss was compensated to the results for each measurement.
4. The middle channel for the highest RF power within the transmitting frequency was measured.
5. The conducted spurious emission for the whole frequency range was taken.
6. Make the measurement with the spectrum analyzer's RBW = 1MHz, VBW = 3MHz.
7. Set spectrum analyzer with RMS detector.
8. Taking the record of maximum spurious emission.
9. The RF fundamental frequency should be excluded against the limit line in the operating frequency band.
10. Checked that all the results comply with the emission limit line.

1.25. Frequency Stability Measurement

3.1.16 Description of Frequency Stability Measurement

The frequency stability shall be measured by variation of ambient temperature and variation of primary supply voltage to ensure that the fundamental emission stays within the authorized frequency block.

3.1.17 Test Procedures for Temperature Variation

1. The testing follows ANSI C63.26 section 5.6.4
2. The EUT was set up in the thermal chamber and connected with the system simulator.
3. With power OFF, the temperature was decreased to -30°C and the EUT was stabilized before testing. Power was applied and the maximum change in frequency was recorded within one minute.
4. With power OFF, the temperature was raised in 10°C step up to 50°C . The EUT was stabilized at each step for at least half an hour. Power was applied and the maximum frequency change was recorded within one minute.

3.1.18 Test Procedures for Voltage Variation

1. The testing follows ANSI C63.26 section 5.6.5.
2. The EUT was placed in a temperature chamber at $20\pm 5^{\circ}\text{C}$ and connected with the system simulator.
3. The power supply voltage to the EUT was varied from 85% to 115% of the nominal value for other than hand carried battery equipment.
4. For hand carried, battery powered equipment, reduce the primary ac or dc supply voltage to the battery operating end point, which shall be specified by the manufacturer.
5. The variation in frequency was measured for the worst case.

4 Radiated Test Items

1.26. Measuring Instruments

See list of measuring instruments of this test report.

1.27. Test Setup

4.1.1 For radiated test below 30MHz

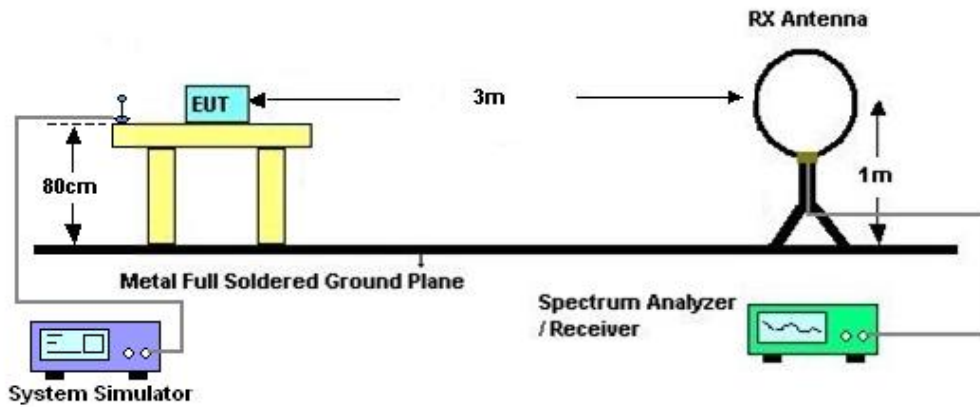

4.1.2 For radiated test from 30MHz to 1GHz

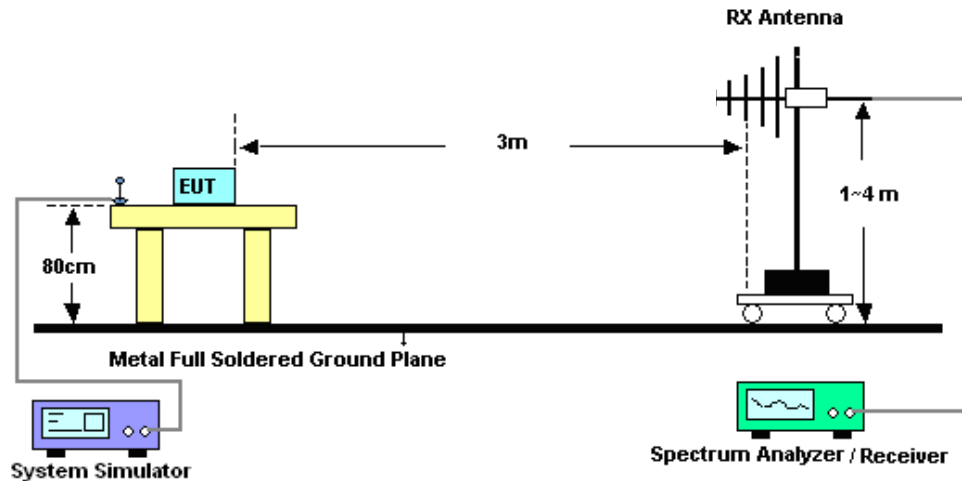

4.1.3 For radiated test above 1GHz

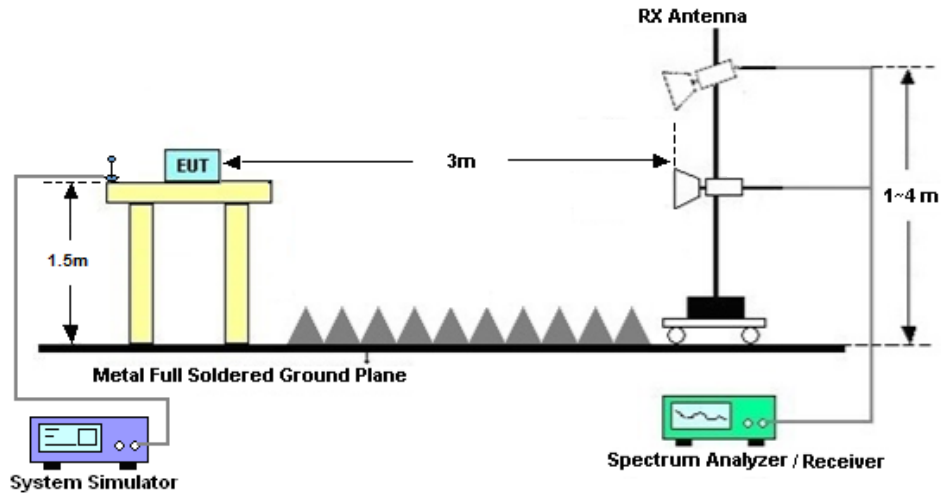

1.28. Test Result of Radiated Test

The low frequency, which started from 9 kHz to 30MHz, was pre-scanned and the result which was 20dB lower than the limit line was not reported.

Please refer to Appendix B.

1.29. Radiated Spurious Emission Measurement

4.1.4 Description of Radiated Spurious Emission

The radiated spurious emission was measured by substitution method according to ANSI/TIA-603-E. The power of any emission outside of the authorized operating frequency ranges shall not exceed -13 dBm/MHz.

The spectrum is scanned from 30 MHz up to a frequency including its 10th harmonic.

4.1.5 Test Procedures

1. The testing follows ANSI C63.26 Section 5.5
2. The EUT was placed on a turntable with 0.8 meter height for frequency below 1GHz and 1.5 meter height for frequency above 1GHz respectively above ground.
3. The EUT was set 3 meters from the receiving antenna mounted on the antenna tower.
4. The table was rotated 360 degrees to determine the position of the highest spurious emission.
5. The height of the receiving antenna is varied between 1m to 4m to search the maximum spurious emission for both horizontal and vertical polarizations.
6. During the measurement, the system simulator parameters were set to force the EUT transmitting at maximum output power.
7. Make the measurement with the spectrum analyzer's RBW = 1MHz, VBW = 3MHz, taking the record of maximum spurious emission.
8. A horn antenna was substituted in place of the EUT and was driven by a signal generator.
9. Tune the output power of signal generator to the same emission level with EUT maximum spurious emission.
$$\text{EIRP (dBm)} = \text{S.G. Power} - \text{Tx Cable Loss} + \text{Tx Antenna Gain}$$
$$\text{ERP (dBm)} = \text{EIRP} - 2.15$$
10. The RF fundamental frequency should be excluded against the limit line in the operating frequency band.



5 List of Measuring Equipment

Instrument	Manufacturer	Model No.	Serial No.	Characteristics	Calibration Date	Test Date	Due Date	Remark
Spectrum Analyzer	R&S	FSV40	101078	10Hz~40GHz	Apr. 07, 2022	Dec. 09, 2022	Apr. 08, 2023	Conducted (TH01-SZ)
Power Divider	TOJOIN	PS-2SM-04 265	60.06.020.007 7	0.4GHz~26.5GHz	Dec. 26, 2021	Dec. 09, 2022	Dec. 25, 2022	Conducted (TH01-SZ)
Thermal Chamber	Ten Billion Hongzhangroup	LP-150U	H2014081803	-40~+150°C	Jul. 07, 2022	Dec. 09, 2022	Jul. 06, 2023	Conducted (TH01-SZ)
EMI Test Receiver&SA	KEYSIGHT	N9038A	MY54450083	20Hz~8.4GHz	Apr. 06, 2022	Dec. 25, 2022	Apr. 05, 2023	Radiation (03CH03-SZ)
Loop Antenna	R&S	HFH2-Z2	100354	9kHz~30MHz	Jun. 28, 2022	Dec. 25, 2022	Jun. 27, 2023	Radiation (03CH03-SZ)
EXA Spectrum Analyzer	KEYSIGHT	N9010A	MY55150246	10Hz~44GHz;	Apr. 06, 2022	Dec. 25, 2022	Apr. 05, 2023	Radiation (03CH03-SZ)
Bilog Antenna	TeseQ	CBL6112D	35408	30MHz-2GHz	Aug. 09, 2022	Dec. 25, 2022	Aug. 08, 2023	Radiation (03CH03-SZ)
Double Ridge Horn Antenna	SCHWARZBECK	BBHA9120D	9120D-1355	1GHz~18GHz	Apr. 08, 2022	Dec. 25, 2022	Apr. 07, 2023	Radiation (03CH03-SZ)
Amplifier	Burgeon	BPA-530	102211	0.01Hz ~3000MHz	Oct. 19, 2022	Dec. 25, 2022	Oct. 18, 2023	Radiation (03CH03-SZ)
HF Amplifier	MITEQ	TTA1840-35 -HG	1871923	18GHz~40GHz	Jul. 06, 2022	Dec. 25, 2022	Jul. 05, 2023	Radiation (03CH03-SZ)
SHF-EHF Horn	com-power	AH-840	101071	18Ghz-40GHz	Apr. 10, 2022	Dec. 25, 2022	Apr. 09, 2023	Radiation (03CH03-SZ)
Amplifier	Agilent Technologies	83017A	MY39501302	500MHz~26.5GHz	Dec. 27, 2021	Dec. 25, 2022	Dec. 26, 2022	Radiation (03CH03-SZ)
AC Power Source	Chroma	61601	616010002729	N/A	Nov. 10, 2022	Dec. 25, 2022	Nov. 09, 2023	Radiation (03CH03-SZ)
Turn Table	EM	EM1000	N/A	0~360 degree	NCR	Dec. 25, 2022	NCR	Radiation (03CH03-SZ)
Antenna Mast	EM	EM1000	N/A	1 m~4 m	NCR	Dec. 25, 2022	NCR	Radiation (03CH03-SZ)

NCR: No Calibration Required

6 Uncertainty of Evaluation

The measurement uncertainties shown below were calculated in accordance with the requirements of ANSI 63.26-2015. All the measurement uncertainty value were shown with a coverage K=2 to indicate 95% level of confidence. The measurement data show herein meets or exceeds the CISPR measurement uncertainty values specified in CISPR 16-4-2 and can be compared directly to specified limit to determine compliance.

Uncertainty of Conducted Measurement

Test Item	Uncertainty
Conducted Power	±1.34 dB
Conducted Emissions	±1.34 dB
Occupied Channel Bandwidth	±0.13 %

Uncertainty of Radiated Emission Measurement (30 MHz ~ 1000 MHz)

Measuring Uncertainty for a Level of Confidence of 95% (U = 2Uc(y))	3.0dB
---	-------

Uncertainty of Radiated Emission Measurement (1 GHz ~ 18 GHz)

Measuring Uncertainty for a Level of Confidence of 95% (U = 2Uc(y))	3.6dB
---	-------

Uncertainty of Radiated Emission Measurement (18 GHz ~ 40 GHz)

Measuring Uncertainty for a Level of Confidence of 95% (U = 2Uc(y))	3.8dB
---	-------

----- THE END -----



Appendix A. Test Results of Conducted Test

Test Engineer :	Jung Kuo	Temperature :	22~23°C
		Relative Humidity :	40~42%

FR1 N77**Transmitter Conducted Output Power And EIRP, (G_T - L_C)=-4.0dB**

NR Band	SCS (kHz)	Bandwidth (MHz)	Arfcn	Freq (MHz)	Modulation	RB	Conducted Power(dBm)	EIRP (dBm)	EIRP (W)
77	30	10	630334	3455.01	DFT-s-OFDM QPSK	1@1	26.44	22.44	0.1754
77	30	10	630334	3455.01	DFT-s-OFDM 16 QAM	1@1	26.44	22.44	0.1754
77	30	10	633334	3500.01	DFT-s-OFDM QPSK	1@1	26.39	22.39	0.1734
77	30	10	633334	3500.01	DFT-s-OFDM 16 QAM	1@1	26.32	22.32	0.1706
77	30	10	636332	3544.98	DFT-s-OFDM QPSK	1@1	26.24	22.24	0.1675
77	30	10	636332	3544.98	DFT-s-OFDM 16 QAM	1@1	26.19	22.19	0.1656
77	30	15	630500	3457.5	DFT-s-OFDM QPSK	1@1	26.61	22.61	0.1824
77	30	15	630500	3457.5	DFT-s-OFDM 16 QAM	1@1	26.62	22.62	0.1828
77	30	15	633334	3500.01	DFT-s-OFDM QPSK	1@1	26.59	22.59	0.1816
77	30	15	633334	3500.01	DFT-s-OFDM 16 QAM	1@1	26.58	22.58	0.1811
77	30	15	636166	3542.49	DFT-s-OFDM QPSK	1@1	26.33	22.33	0.1710
77	30	15	636166	3542.49	DFT-s-OFDM 16 QAM	1@1	26.34	22.34	0.1714
77	30	20	630668	3460.02	DFT-s-OFDM QPSK	1@1	26.63	22.63	0.1832
77	30	20	630668	3460.02	DFT-s-OFDM 16 QAM	1@1	26.69	22.69	0.1858
77	30	20	633334	3500.01	DFT-s-OFDM QPSK	1@1	26.55	22.55	0.1799
77	30	20	633334	3500.01	DFT-s-OFDM 16 QAM	1@1	26.65	22.65	0.1841
77	30	20	636000	3540.0	DFT-s-OFDM QPSK	1@1	26.34	22.34	0.1714
77	30	20	636000	3540.0	DFT-s-OFDM 16 QAM	1@1	26.38	22.38	0.1730
77	30	30	631000	3465.0	DFT-s-OFDM QPSK	1@1	26.66	22.66	0.1845

77	30	30	631000	3465.0	DFT-s-OFDM 16 QAM	1@1	26.76	22.76	0.1888
77	30	30	633334	3500.01	DFT-s-OFDM QPSK	1@1	26.63	22.63	0.1832
77	30	30	633334	3500.01	DFT-s-OFDM 16 QAM	1@1	26.68	22.68	0.1854
77	30	30	635666	3534.99	DFT-s-OFDM QPSK	1@1	26.59	22.59	0.1816
77	30	30	635666	3534.99	DFT-s-OFDM 16 QAM	1@1	26.72	22.72	0.1871
77	30	40	631334	3470.01	DFT-s-OFDM QPSK	1@1	26.75	22.75	0.1884
77	30	40	631334	3470.01	DFT-s-OFDM 16 QAM	1@1	26.81	22.81	0.1910
77	30	40	633334	3500.01	DFT-s-OFDM QPSK	1@1	26.67	22.67	0.1849
77	30	40	633334	3500.01	DFT-s-OFDM 16 QAM	1@1	26.69	22.69	0.1858
77	30	40	635332	3529.98	DFT-s-OFDM QPSK	1@1	26.69	22.69	0.1858
77	30	40	635332	3529.98	DFT-s-OFDM 16 QAM	1@1	26.71	22.71	0.1866
77	30	50	631668	3475.02	DFT-s-OFDM QPSK	1@1	26.52	22.52	0.1786
77	30	50	631668	3475.02	DFT-s-OFDM 16 QAM	1@1	26.63	22.63	0.1832
77	30	50	633334	3500.01	DFT-s-OFDM QPSK	1@1	26.55	22.55	0.1799
77	30	50	633334	3500.01	DFT-s-OFDM 16 QAM	1@1	26.61	22.61	0.1824
77	30	50	635000	3525.0	DFT-s-OFDM QPSK	1@1	26.52	22.52	0.1786
77	30	50	635000	3525.0	DFT-s-OFDM 16 QAM	1@1	26.6	22.6	0.1820
77	30	60	632000	3480.0	DFT-s-OFDM QPSK	1@1	26.55	22.55	0.1799
77	30	60	632000	3480.0	DFT-s-OFDM 16 QAM	1@1	26.62	22.62	0.1828
77	30	60	633334	3500.01	DFT-s-OFDM QPSK	1@1	26.55	22.55	0.1799
77	30	60	633334	3500.01	DFT-s-OFDM 16 QAM	1@1	26.6	22.6	0.1820
77	30	60	634666	3519.99	DFT-s-OFDM QPSK	1@1	26.52	22.52	0.1786
77	30	60	634666	3519.99	DFT-s-OFDM 16 QAM	1@1	26.57	22.57	0.1807
77	30	70	632334	3485.01	DFT-s-OFDM QPSK	1@1	26.52	22.52	0.1786

77	30	70	632334	3485.01	DFT-s-OFDM 16 QAM	1@1	26.61	22.61	0.1824
77	30	70	633334	3500.01	DFT-s-OFDM QPSK	1@1	26.41	22.41	0.1742
77	30	70	633334	3500.01	DFT-s-OFDM 16 QAM	1@1	26.46	22.46	0.1762
77	30	70	634332	3514.98	DFT-s-OFDM QPSK	1@1	26.38	22.38	0.1730
77	30	70	634332	3514.98	DFT-s-OFDM 16 QAM	1@1	26.5	22.5	0.1778
77	30	80	632668	3490.02	DFT-s-OFDM QPSK	1@1	26.36	22.36	0.1722
77	30	80	632668	3490.02	DFT-s-OFDM 16 QAM	1@1	26.48	22.48	0.1770
77	30	80	633334	3500.01	DFT-s-OFDM QPSK	1@1	26.43	22.43	0.1750
77	30	80	633334	3500.01	DFT-s-OFDM 16 QAM	1@1	26.44	22.44	0.1754
77	30	80	634000	3510.0	DFT-s-OFDM QPSK	1@1	26.42	22.42	0.1746
77	30	80	634000	3510.0	DFT-s-OFDM 16 QAM	1@1	26.52	22.52	0.1786
77	30	90	633000	3495.0	DFT-s-OFDM QPSK	1@1	26.38	22.38	0.1730
77	30	90	633000	3495.0	DFT-s-OFDM 16 QAM	1@1	26.46	22.46	0.1762
77	30	90	633334	3500.01	DFT-s-OFDM QPSK	1@1	26.45	22.45	0.1758
77	30	90	633334	3500.01	DFT-s-OFDM 16 QAM	1@1	26.49	22.49	0.1774
77	30	90	633666	3504.99	DFT-s-OFDM QPSK	1@1	26.46	22.46	0.1762
77	30	90	633666	3504.99	DFT-s-OFDM 16 QAM	1@1	26.5	22.5	0.1778
77	30	100	633334	3500.01	DFT-s-OFDM PI/2 BPSK	135@67	26.32	22.32	0.1706
77	30	100	633334	3500.01	DFT-s-OFDM PI/2 BPSK	1@1	26.77	22.77	0.1892
77	30	100	633334	3500.01	DFT-s-OFDM PI/2 BPSK	1@271	25.84	21.84	0.1528
77	30	100	633334	3500.01	DFT-s-OFDM QPSK	135@67	26.24	22.24	0.1675
77	30	100	633334	3500.01	DFT-s-OFDM QPSK	1@1	26.83	22.83	0.1919
77	30	100	633334	3500.01	DFT-s-OFDM QPSK	1@271	25.86	21.86	0.1535
77	30	100	633334	3500.01	DFT-s-OFDM 16 QAM	135@67	26.29	22.29	0.1694

77	30	100	633334	3500.01	DFT-s-OFDM 16 QAM	1@1	26.53	22.53	0.1791
77	30	100	633334	3500.01	DFT-s-OFDM 16 QAM	1@271	26.02	22.02	0.1592
77	30	100	633334	3500.01	DFT-s-OFDM 64 QAM	135@67	25.29	21.29	0.1346
77	30	100	633334	3500.01	DFT-s-OFDM 64 QAM	1@1	25.54	21.54	0.1426
77	30	100	633334	3500.01	DFT-s-OFDM 64 QAM	1@271	24.99	20.99	0.1256
77	30	100	633334	3500.01	DFT-s-OFDM 256 QAM	135@67	23.32	19.32	0.0855
77	30	100	633334	3500.01	DFT-s-OFDM 256 QAM	1@1	23.4	19.4	0.0871
77	30	100	633334	3500.01	DFT-s-OFDM 256 QAM	1@271	22.82	18.82	0.0762
77	30	100	633334	3500.01	CP-OFDM QPSK	137@68	26.26	22.26	0.1683
77	30	100	633334	3500.01	CP-OFDM QPSK	1@1	26.39	22.39	0.1734
77	30	100	633334	3500.01	CP-OFDM QPSK	1@271	25.86	21.86	0.1535

Frequency Stability

NR Band	SCS (kHz)	Bandwidth (MHz)	Arfcn	Freq (MHz)	Modulation	RB	Deviation (ppm)	Verdict	Environment
77	30	20	633334	3500.01	DFT-s-OFDM QPSK	50@0	0.0052	PASS	NV
77	30	20	633334	3500.01	DFT-s-OFDM QPSK	50@0	0.0043	PASS	LV
77	30	20	633334	3500.01	DFT-s-OFDM QPSK	50@0	0.0070	PASS	HV
77	30	20	633334	3500.01	DFT-s-OFDM QPSK	50@0	0.0046	PASS	-30°C
77	30	20	633334	3500.01	DFT-s-OFDM QPSK	50@0	0.0047	PASS	-20°C
77	30	20	633334	3500.01	DFT-s-OFDM QPSK	50@0	0.0050	PASS	-10°C
77	30	20	633334	3500.01	DFT-s-OFDM QPSK	50@0	0.0062	PASS	0°C
77	30	20	633334	3500.01	DFT-s-OFDM QPSK	50@0	0.0036	PASS	10°C
77	30	20	633334	3500.01	DFT-s-OFDM QPSK	50@0	0.0052	PASS	20°C
77	30	20	633334	3500.01	DFT-s-OFDM QPSK	50@0	0.0035	PASS	30°C
77	30	20	633334	3500.01	DFT-s-OFDM QPSK	50@0	0.0037	PASS	40°C
77	30	20	633334	3500.01	DFT-s-OFDM QPSK	50@0	0.0037	PASS	50°C

Peak to Average Ratio

NR Band	SCS (kHz)	Bandwidth (MHz)	Arfcn	Freq (MHz)	Modulation	RB	Result (dB)	Limit (dB)	Verdict
77	30	20	630668	3460.02	DFT-s-OFDM PI/2 BPSK	50@0	6.89	13	PASS
77	30	20	630668	3460.02	DFT-s-OFDM PI/2 BPSK	1@0	7.3	13	PASS
77	30	20	630668	3460.02	DFT-s-OFDM QPSK	50@0	8.01	13	PASS
77	30	20	630668	3460.02	DFT-s-OFDM QPSK	1@0	8.05	13	PASS
77	30	20	633334	3500.01	DFT-s-OFDM PI/2 BPSK	50@0	6.81	13	PASS
77	30	20	633334	3500.01	DFT-s-OFDM PI/2 BPSK	1@0	7.22	13	PASS
77	30	20	633334	3500.01	DFT-s-OFDM QPSK	50@0	8.09	13	PASS
77	30	20	633334	3500.01	DFT-s-OFDM QPSK	1@0	8.08	13	PASS
77	30	20	636000	3540.0	DFT-s-OFDM PI/2 BPSK	50@0	6.89	13	PASS
77	30	20	636000	3540.0	DFT-s-OFDM PI/2 BPSK	1@0	7.43	13	PASS
77	30	20	636000	3540.0	DFT-s-OFDM QPSK	50@0	8.02	13	PASS
77	30	20	636000	3540.0	DFT-s-OFDM QPSK	1@0	8.1	13	PASS

N77(20M)_DFT-s-OFDM_PI_2-BPSK_Outer_Full_Low_CH

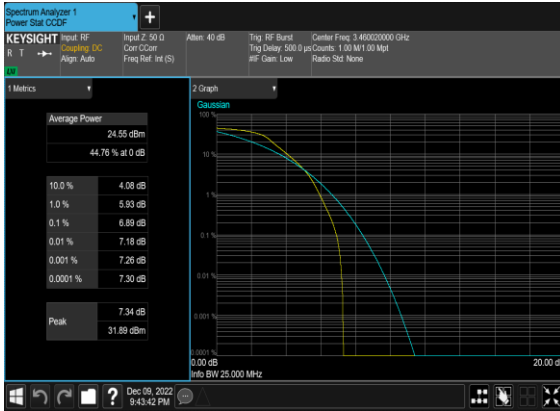

N77(20M)_DFT-s-OFDM_PI_2-BPSK_Edge_1RB_Left_Low_CH



N77(20M)_DFT-s-OFDM_QPSK_Outer_Full_Low_CH



N77(20M)_DFT-s-OFDM_QPSK_Edge_1RB_Left_Low_CH

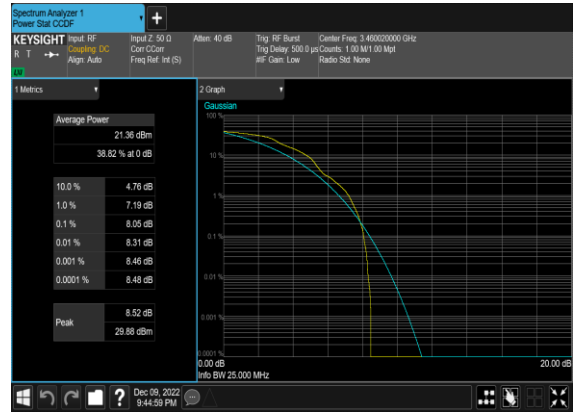

N77(20M)_DFT-s-OFDM_PI_2-BPSK_Outer_Full_Mid_CH

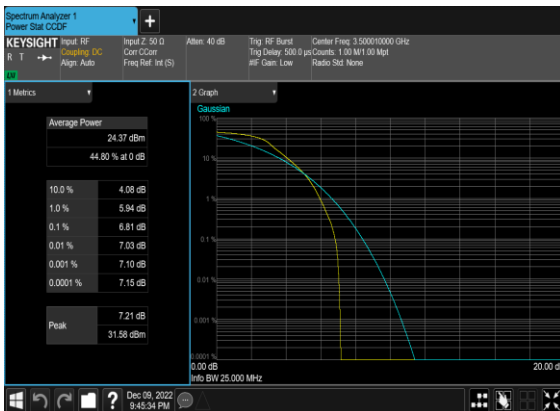

N77(20M)_DFT-s-OFDM_PI_2-BPSK_Edge_1RB_Left_Mid_CH

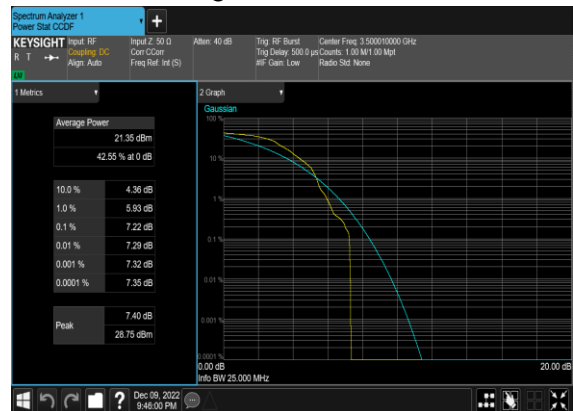

N77(20M)_DFT-s-OFDM_QPSK_Outer_Full_Mid_CH



N77(20M)_DFT-s-OFDM_QPSK_Edge_1RB_Left_Mid_CH

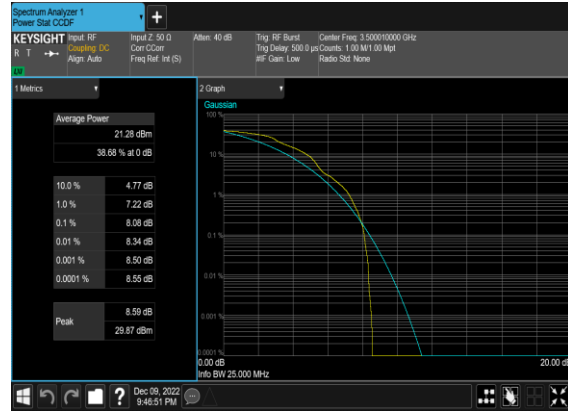

N77(20M)_DFT-s-OFDM_PI_2-BPSK_Outer_Full_High_CH



N77(20M)_DFT-s-OFDM_PI_2-BPSK_Edge_1RB_Left_High_CH



N77(20M)_DFT-s-OFDM_QPSK_Outer_Full_High_CH



N77(20M)_DFT-s-OFDM_QPSK_Edge_1RB_Left_High_CH

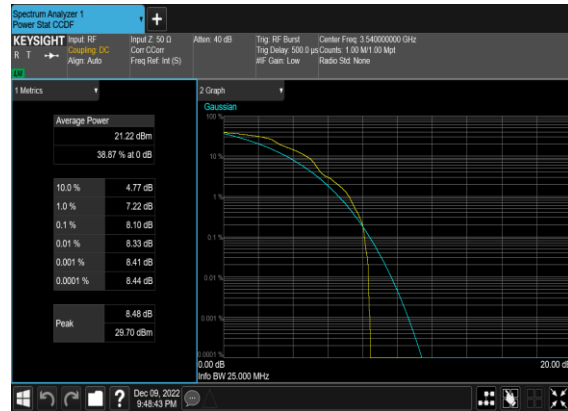

Occupied Bandwidth

NR Band	SCS (kHz)	Bandwidth (MHz)	Arfcn	Freq (MHz)	Modulation	RB	OBW (MHz)	26dB BW (MHz)
77	30	10	633334	3500.01	DFT-s-OFDM PI/2 BPSK	24@0	8.5922	9.572
77	30	10	633334	3500.01	DFT-s-OFDM QPSK	24@0	8.5709	9.577
77	30	10	633334	3500.01	CP-OFDM QPSK	24@0	8.5866	9.706
77	30	10	633334	3500.01	CP-OFDM 16 QAM	24@0	8.5804	9.501
77	30	10	633334	3500.01	CP-OFDM 64 QAM	24@0	8.6042	9.531
77	30	10	633334	3500.01	CP-OFDM 256 QAM	24@0	8.5578	9.247
77	30	15	633334	3500.01	DFT-s-OFDM PI/2 BPSK	36@0	12.804	14.01
77	30	15	633334	3500.01	DFT-s-OFDM QPSK	36@0	12.845	13.9
77	30	15	633334	3500.01	CP-OFDM QPSK	38@0	13.57	14.87
77	30	15	633334	3500.01	CP-OFDM 16 QAM	38@0	13.595	14.58
77	30	15	633334	3500.01	CP-OFDM 64 QAM	38@0	13.569	14.38
77	30	15	633334	3500.01	CP-OFDM 256 QAM	38@0	13.576	14.72
77	30	20	633334	3500.01	DFT-s-OFDM PI/2 BPSK	50@0	17.841	18.99
77	30	20	633334	3500.01	DFT-s-OFDM QPSK	50@0	17.854	18.93
77	30	20	633334	3500.01	CP-OFDM QPSK	51@0	18.205	19.51
77	30	20	633334	3500.01	CP-OFDM 16 QAM	51@0	18.197	19.54
77	30	20	633334	3500.01	CP-OFDM 64 QAM	51@0	18.199	19.34
77	30	20	633334	3500.01	CP-OFDM 256 QAM	51@0	18.209	19.62
77	30	30	633334	3500.01	DFT-s-OFDM PI/2 BPSK	75@0	26.796	27.88
77	30	30	633334	3500.01	DFT-s-OFDM QPSK	75@0	26.765	28.28
77	30	30	633334	3500.01	CP-OFDM QPSK	78@0	27.808	29.2
77	30	30	633334	3500.01	CP-OFDM 16 QAM	78@0	27.833	29.48
77	30	30	633334	3500.01	CP-OFDM 64 QAM	78@0	27.806	28.88
77	30	30	633334	3500.01	CP-OFDM 256 QAM	78@0	27.889	29.23

77	30	40	633334	3500.01	DFT-s-OFDM PI/2 BPSK	100@0	35.762	37.06
77	30	40	633334	3500.01	DFT-s-OFDM QPSK	100@0	35.584	36.91
77	30	40	633334	3500.01	CP-OFDM QPSK	106@0	37.827	39.68
77	30	40	633334	3500.01	CP-OFDM 16 QAM	106@0	37.767	39.26
77	30	40	633334	3500.01	CP-OFDM 64 QAM	106@0	37.867	39.28
77	30	40	633334	3500.01	CP-OFDM 256 QAM	106@0	37.758	39.42
77	30	50	633334	3500.01	DFT-s-OFDM PI/2 BPSK	128@0	45.814	47.58
77	30	50	633334	3500.01	DFT-s-OFDM QPSK	128@0	45.656	47.18
77	30	50	633334	3500.01	CP-OFDM QPSK	133@0	47.488	49.06
77	30	50	633334	3500.01	CP-OFDM 16 QAM	133@0	47.471	49.02
77	30	50	633334	3500.01	CP-OFDM 64 QAM	133@0	47.514	49.06
77	30	50	633334	3500.01	CP-OFDM 256 QAM	133@0	47.383	48.98
77	30	60	633334	3500.01	DFT-s-OFDM PI/2 BPSK	162@0	57.943	60.01
77	30	60	633334	3500.01	DFT-s-OFDM QPSK	162@0	57.773	59.75
77	30	60	633334	3500.01	CP-OFDM QPSK	162@0	57.682	59.8
77	30	60	633334	3500.01	CP-OFDM 16 QAM	162@0	57.7	59.8
77	30	60	633334	3500.01	CP-OFDM 64 QAM	162@0	57.9	59.69
77	30	60	633334	3500.01	CP-OFDM 256 QAM	162@0	57.702	60.1
77	30	70	633334	3500.01	DFT-s-OFDM PI/2 BPSK	180@0	64.422	66.46
77	30	70	633334	3500.01	DFT-s-OFDM QPSK	180@0	64.205	66.42
77	30	70	633334	3500.01	CP-OFDM QPSK	189@0	67.499	69.93
77	30	70	633334	3500.01	CP-OFDM 16 QAM	189@0	67.357	70.0
77	30	70	633334	3500.01	CP-OFDM 64 QAM	189@0	67.389	69.72
77	30	70	633334	3500.01	CP-OFDM 256 QAM	189@0	67.446	69.99
77	30	80	633334	3500.01	DFT-s-OFDM PI/2 BPSK	216@0	77.372	79.48
77	30	80	633334	3500.01	DFT-s-OFDM	216@0	77.065	79.6

QPSK								
77	30	80	633334	3500.01	CP-OFDM QPSK	217@0	77.445	79.85
77	30	80	633334	3500.01	CP-OFDM 16 QAM	217@0	77.473	79.86
77	30	80	633334	3500.01	CP-OFDM 64 QAM	217@0	77.494	80.13
77	30	80	633334	3500.01	CP-OFDM 256 QAM	217@0	77.496	79.98
77	30	90	633334	3500.01	DFT-s- OFDM PI/2 BPSK	240@0	85.781	88.44
77	30	90	633334	3500.01	DFT-s- OFDM QPSK	240@0	85.825	88.46
77	30	90	633334	3500.01	CP-OFDM QPSK	245@0	87.399	90.29
77	30	90	633334	3500.01	CP-OFDM 16 QAM	245@0	87.435	90.16
77	30	90	633334	3500.01	CP-OFDM 64 QAM	245@0	87.427	90.28
77	30	90	633334	3500.01	CP-OFDM 256 QAM	245@0	87.528	90.19
77	30	100	633334	3500.01	DFT-s- OFDM PI/2 BPSK	270@0	96.457	99.48
77	30	100	633334	3500.01	DFT-s- OFDM QPSK	270@0	96.362	99.46
77	30	100	633334	3500.01	CP-OFDM QPSK	273@0	97.375	100.5
77	30	100	633334	3500.01	CP-OFDM 16 QAM	273@0	97.336	100.4
77	30	100	633334	3500.01	CP-OFDM 64 QAM	273@0	97.423	100.5
77	30	100	633334	3500.01	CP-OFDM 256 QAM	273@0	97.494	100.5

N77(10M)_DFT-s-OFDM_PI_2- BPSK_Outer_Full_Mid_CH

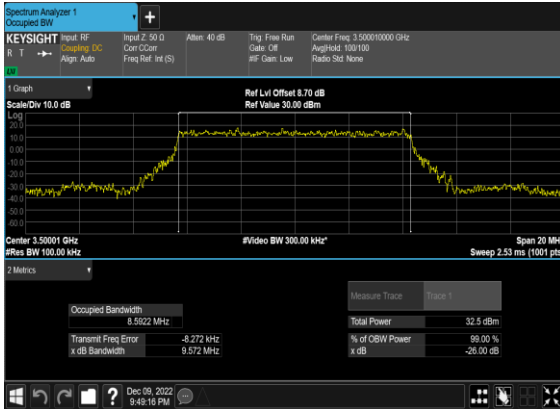

N77(10M)_DFT-s- OFDM_QPSK_Outer_Full_Mid_CH



N77(10M)_CP- OFDM_QPSK_Outer_Full_Mid_CH



N77(10M)_CP-OFDM_16 QAM_Outer_Full_Mid_CH

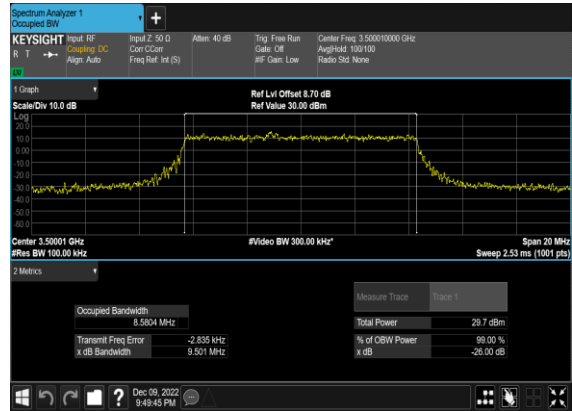

N77(10M)_CP-OFDM_64 QAM_Outer_Full_Mid_CH

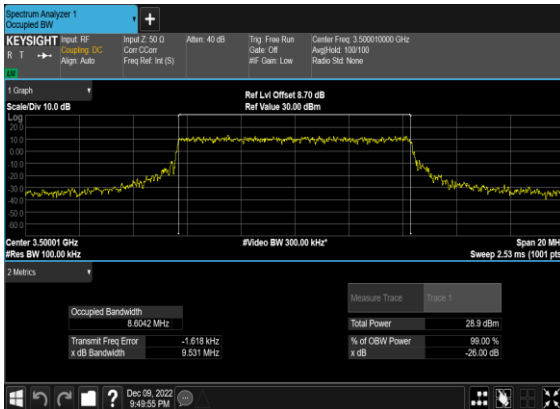

N77(10M)_CP-OFDM_256 QAM_Outer_Full_Mid_CH

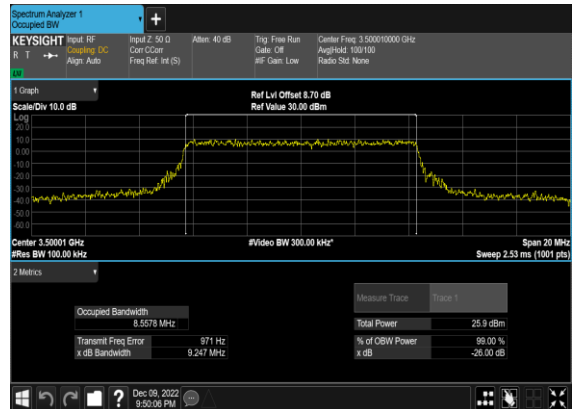

N77(15M)_DFT-s-OFDM_PI_2-
BPSK_Outer_Full_Mid_CH

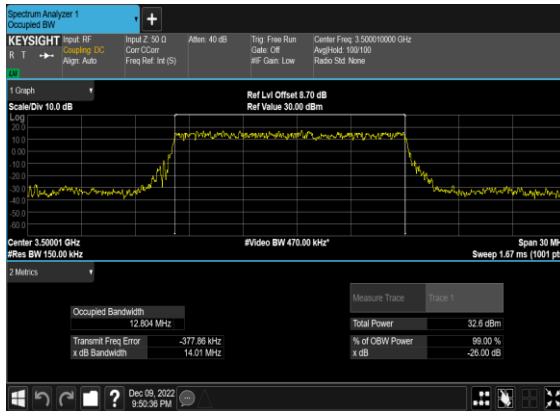

N77(15M)_DFT-s-
OFDM_QPSK_Outer_Full_Mid_CH

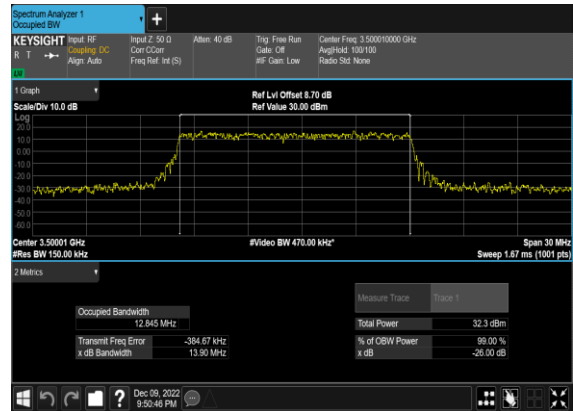

N77(15M)_CP-
OFDM_QPSK_Outer_Full_Mid_CH



N77(15M)_CP-OFDM_16
QAM_Outer_Full_Mid_CH

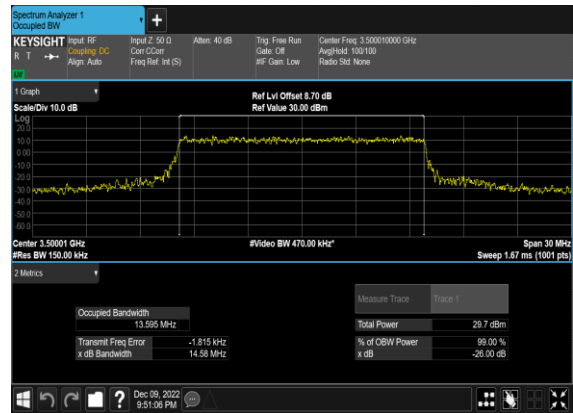

N77(15M)_CP-OFDM_64
QAM_Outer_Full_Mid_CH

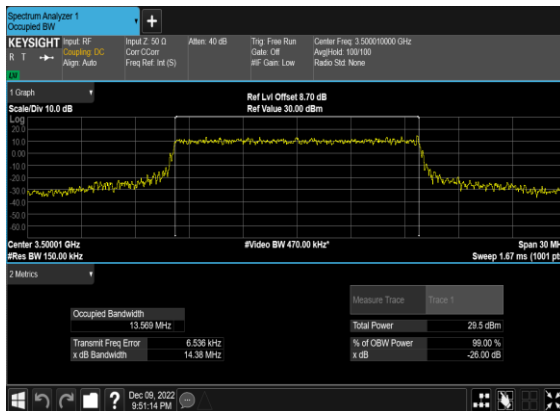

N77(15M)_CP-OFDM_256
QAM_Outer_Full_Mid_CH

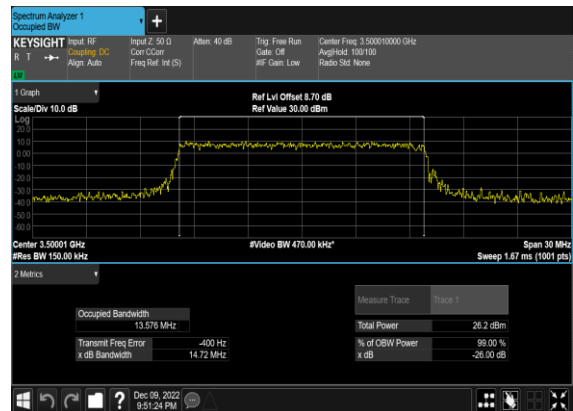

N77(20M)_DFT-s-OFDM_PI_2- BPSK_Outer_Full_Mid_CH

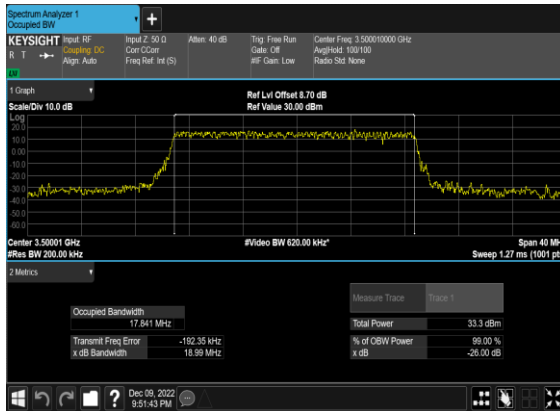

N77(20M)_DFT-s- OFDM_QPSK_Outer_Full_Mid_CH

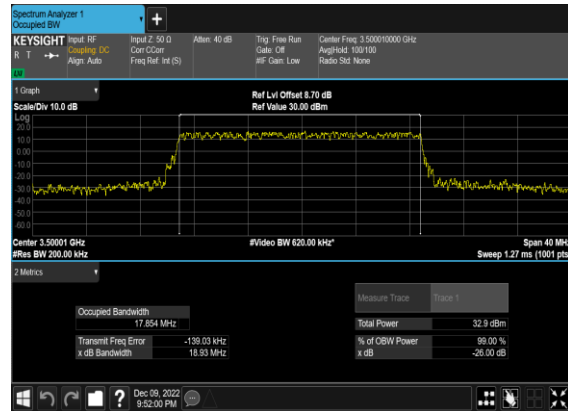

N77(20M)_CP- OFDM_QPSK_Outer_Full_Mid_CH

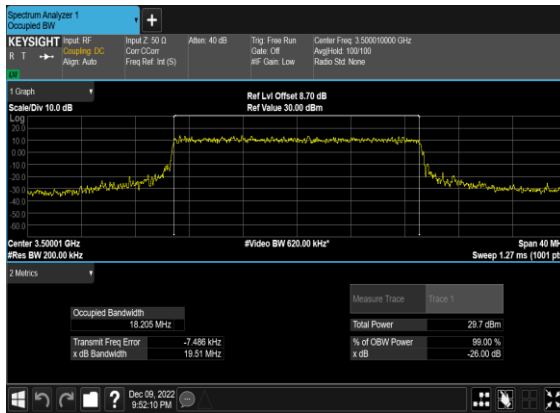

N77(20M)_CP-OFDM_16 QAM_Outer_Full_Mid_CH

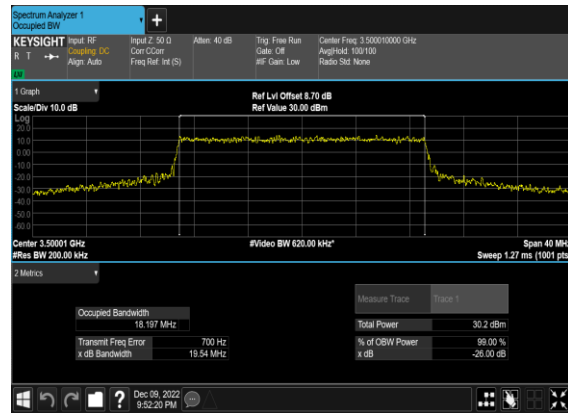

N77(20M)_CP-OFDM_64 QAM_Outer_Full_Mid_CH

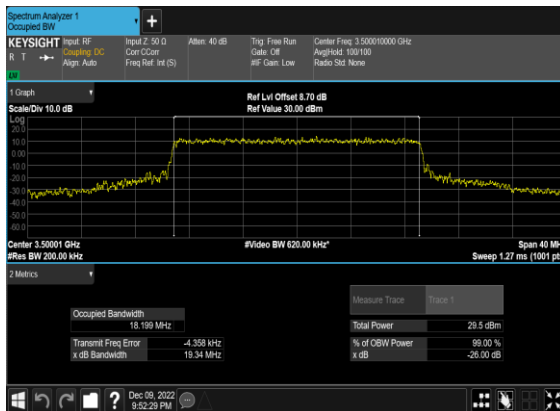

N77(20M)_CP-OFDM_256 QAM_Outer_Full_Mid_CH

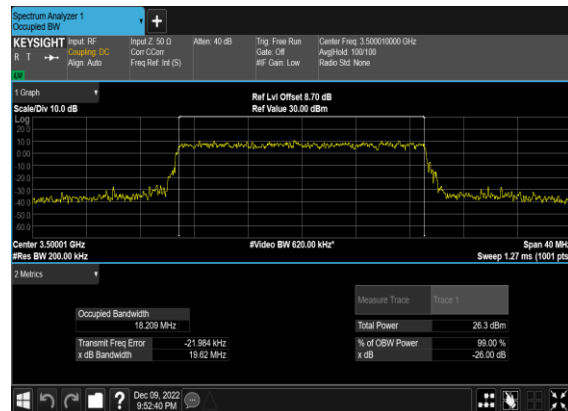

N77(30M)_DFT-s-OFDM_PI_2-BPSK_Outer_Full_Mid_CH

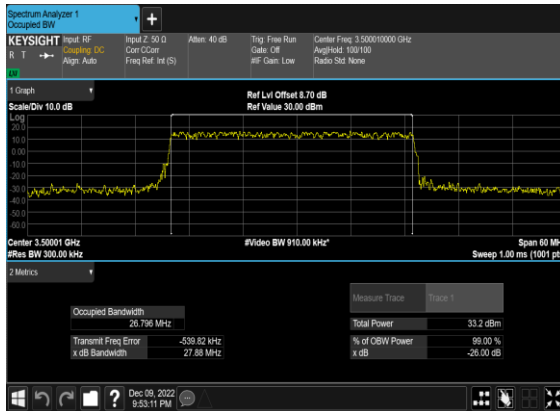

N77(30M)_DFT-s-OFDM_QPSK_Outer_Full_Mid_CH

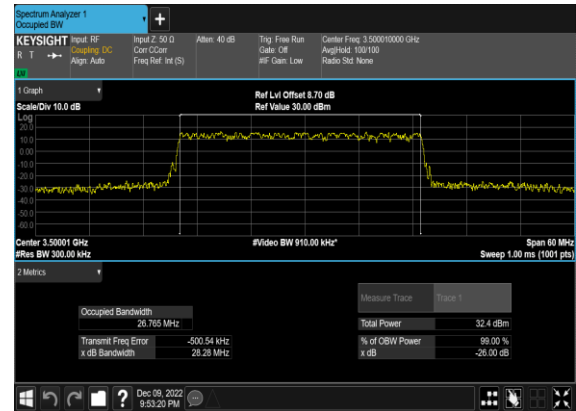

N77(30M)_CP-OFDM_QPSK_Outer_Full_Mid_CH

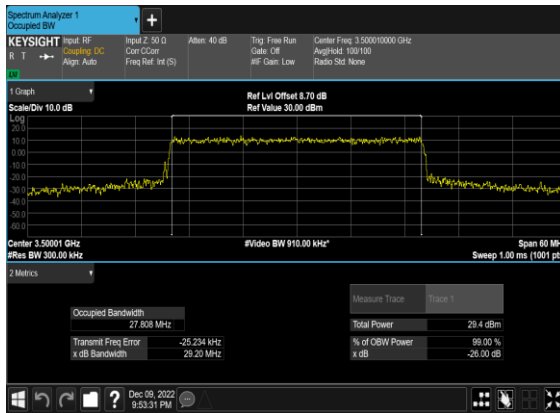

N77(30M)_CP-OFDM_16QAM_Outer_Full_Mid_CH

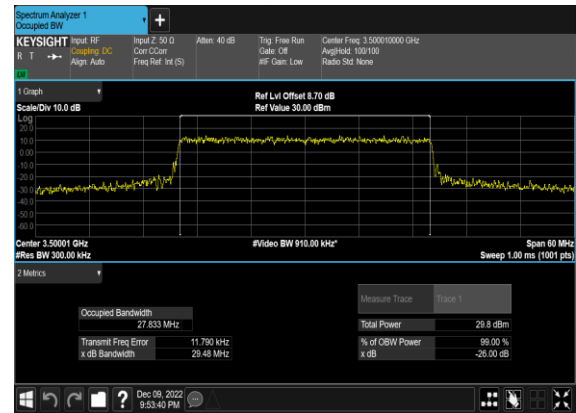

N77(30M)_CP-OFDM_64QAM_Outer_Full_Mid_CH

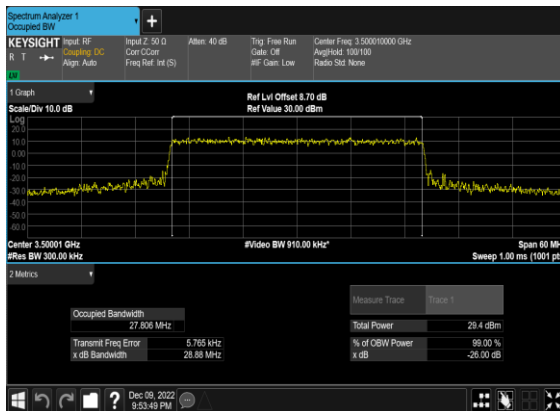

N77(30M)_CP-OFDM_256QAM_Outer_Full_Mid_CH

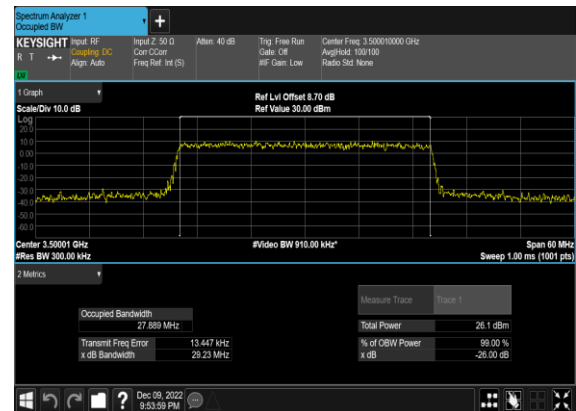

N77(40M)_DFT-s-OFDM_PI_2-BPSK_Outer_Full_Mid_CH

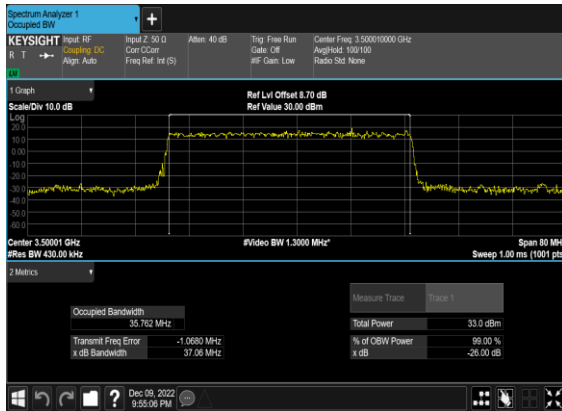

N77(40M)_DFT-s-OFDM_QPSK_Outer_Full_Mid_CH

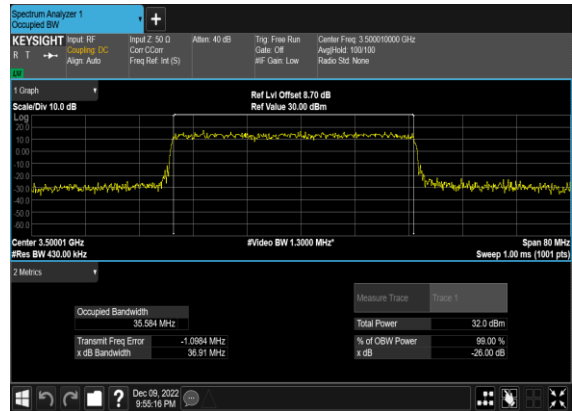

N77(40M)_CP-OFDM_QPSK_Outer_Full_Mid_CH

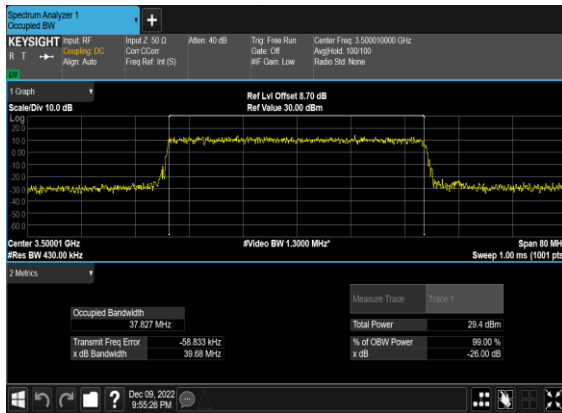

N77(40M)_CP-OFDM_16QAM_Outer_Full_Mid_CH

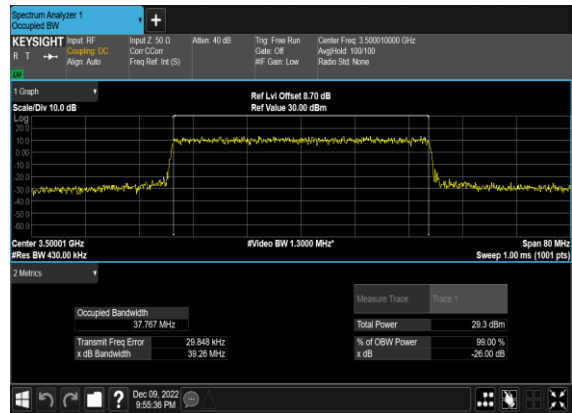

N77(40M)_CP-OFDM_64QAM_Outer_Full_Mid_CH

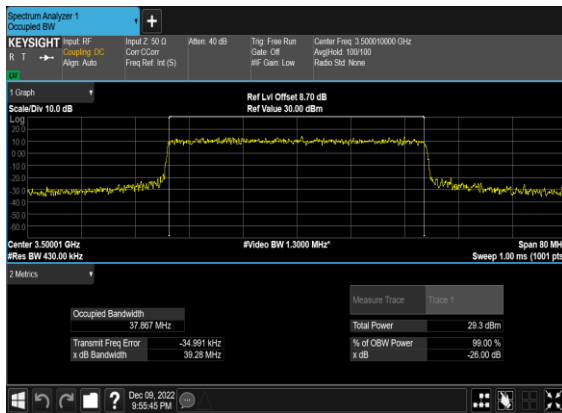

N77(40M)_CP-OFDM_256QAM_Outer_Full_Mid_CH

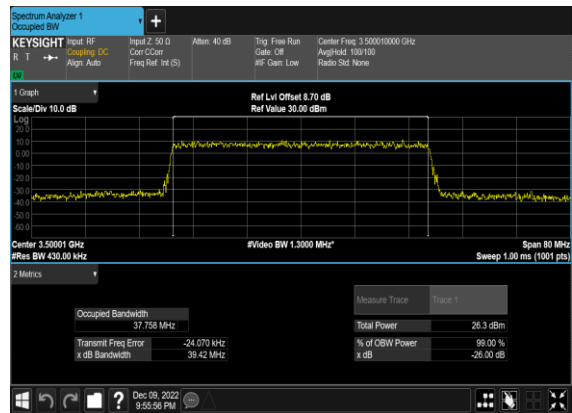

N77(50M)_DFT-s-OFDM_PI_2-
BPSK_Outer_Full_Mid_CH

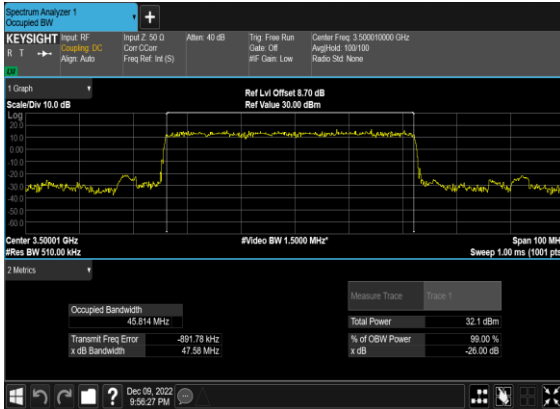

N77(50M)_DFT-s-
OFDM_QPSK_Outer_Full_Mid_CH

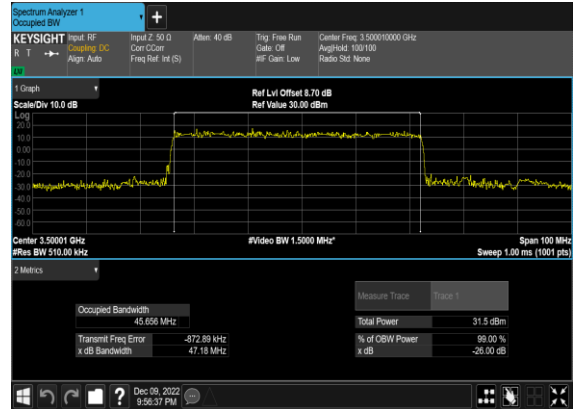

N77(50M)_CP-
OFDM_QPSK_Outer_Full_Mid_CH



N77(50M)_CP-OFDM_16
QAM_Outer_Full_Mid_CH



N77(50M)_CP-OFDM_64
QAM_Outer_Full_Mid_CH

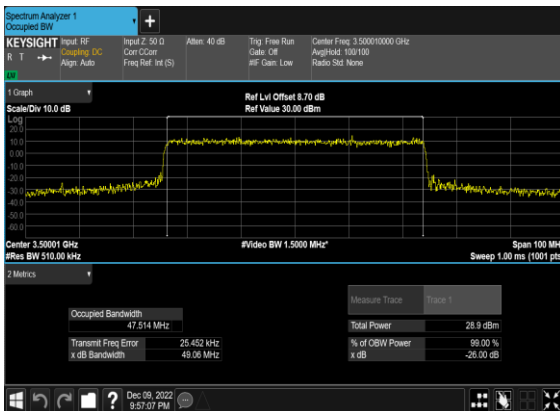

N77(50M)_CP-OFDM_256
QAM_Outer_Full_Mid_CH

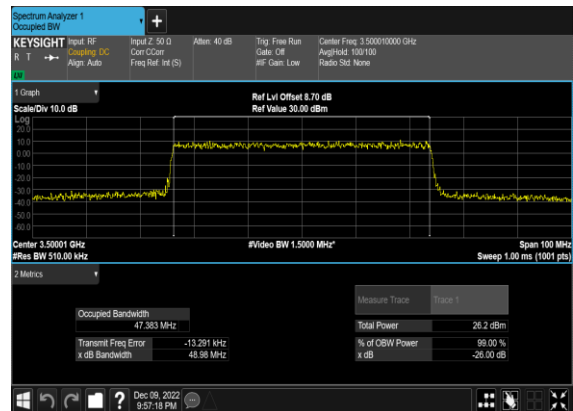

N77(60M)_DFT-s-OFDM_PI_2-BPSK_Outer_Full_Mid_CH

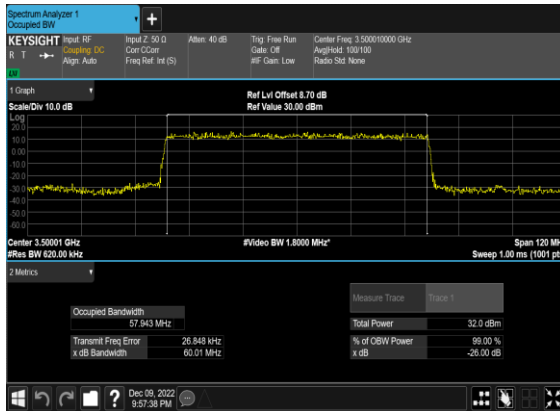

N77(60M)_DFT-s-OFDM_QPSK_Outer_Full_Mid_CH

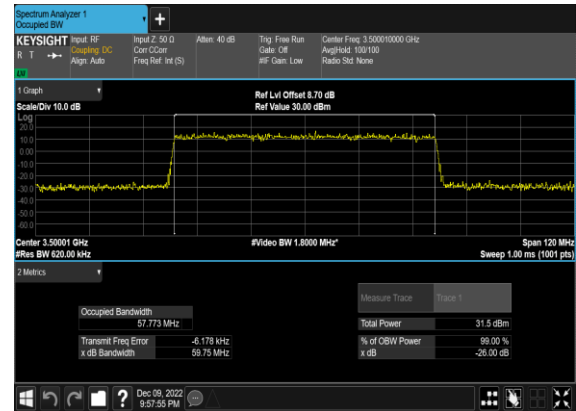

N77(60M)_CP-OFDM_QPSK_Outer_Full_Mid_CH

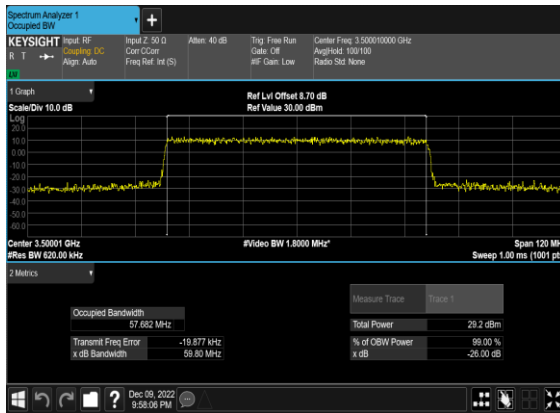

N77(60M)_CP-OFDM_16QAM_Outer_Full_Mid_CH

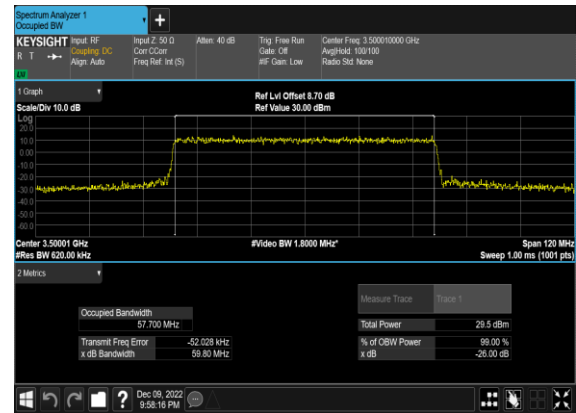

N77(60M)_CP-OFDM_64QAM_Outer_Full_Mid_CH

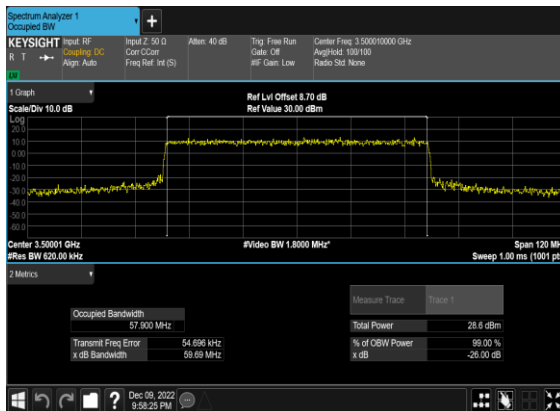

N77(60M)_CP-OFDM_256QAM_Outer_Full_Mid_CH

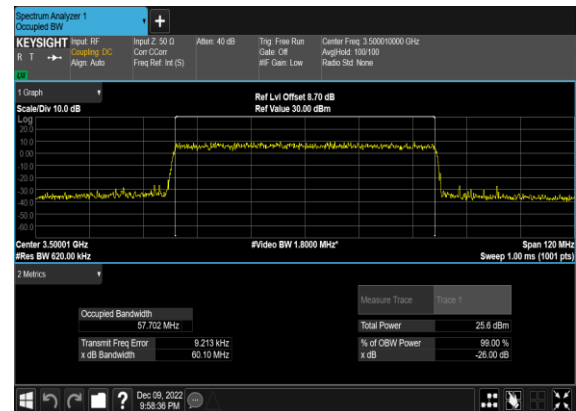

N77(70M)_DFT-s-OFDM_PI_2-BPSK_Outer_Full_Mid_CH

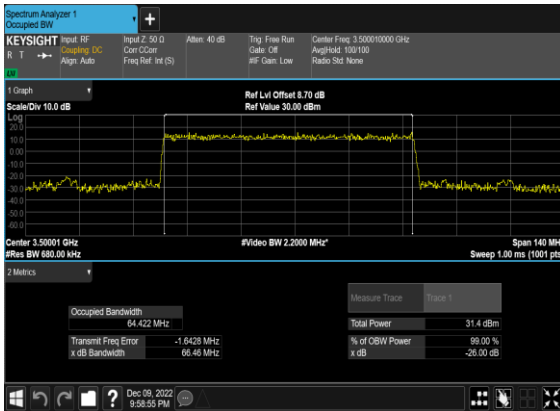

N77(70M)_DFT-s-OFDM_QPSK_Outer_Full_Mid_CH

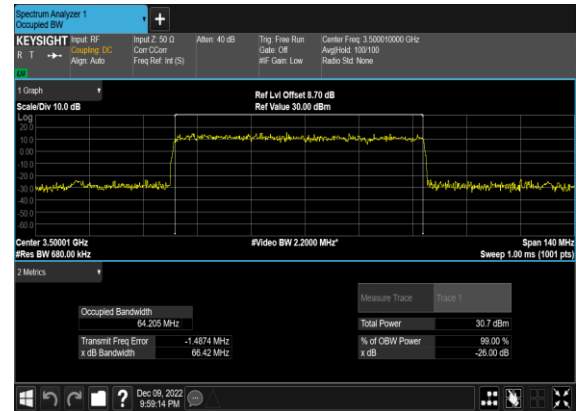

N77(70M)_CP-OFDM_QPSK_Outer_Full_Mid_CH

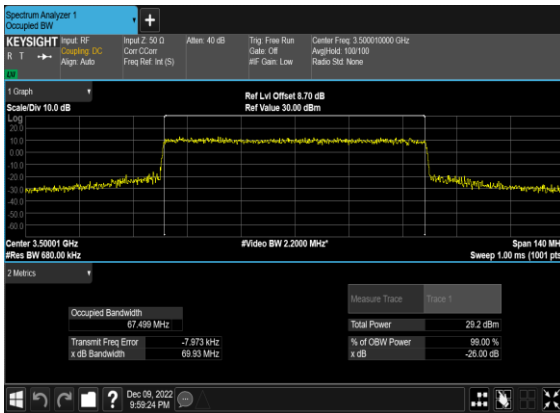

N77(70M)_CP-OFDM_16QAM_Outer_Full_Mid_CH

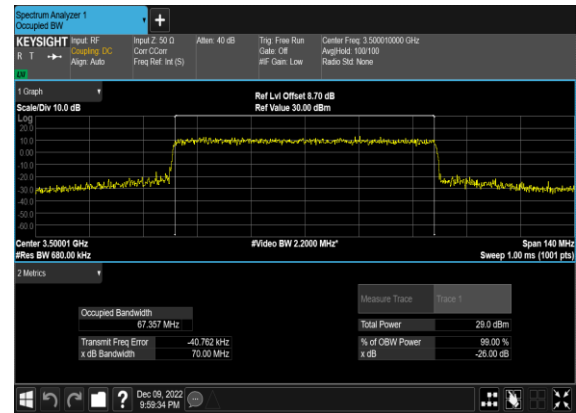

N77(70M)_CP-OFDM_64QAM_Outer_Full_Mid_CH

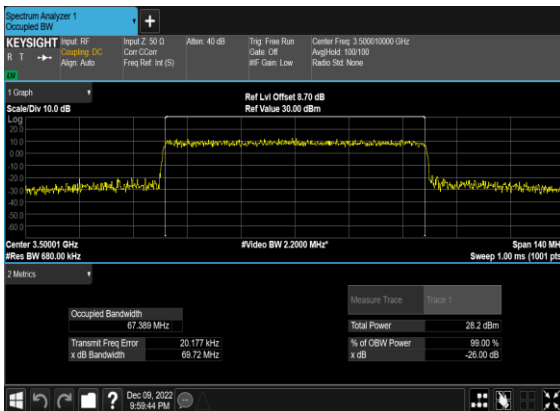

N77(70M)_CP-OFDM_256QAM_Outer_Full_Mid_CH

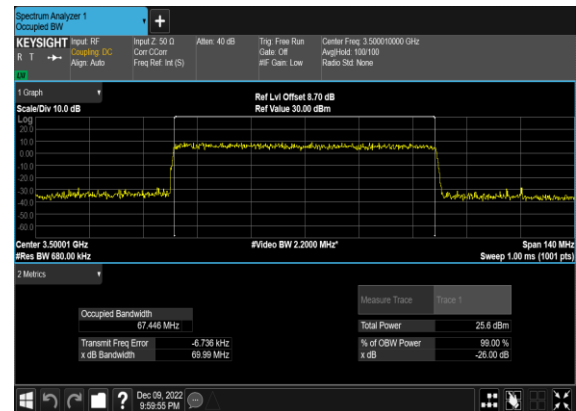

N77(80M)_DFT-s-OFDM_PI_2-BPSK_Outer_Full_Mid_CH

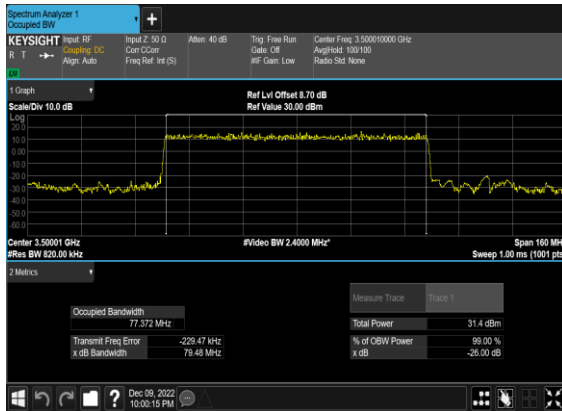

N77(80M)_DFT-s-OFDM_QPSK_Outer_Full_Mid_CH

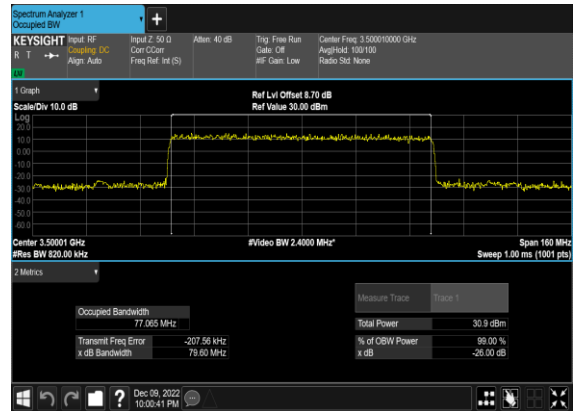

N77(80M)_CP-OFDM_QPSK_Outer_Full_Mid_CH

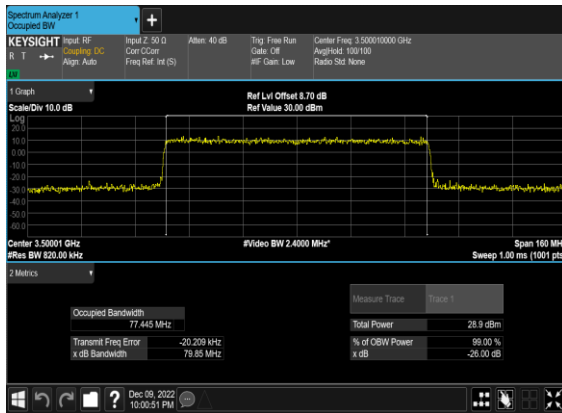

N77(80M)_CP-OFDM_16QAM_Outer_Full_Mid_CH

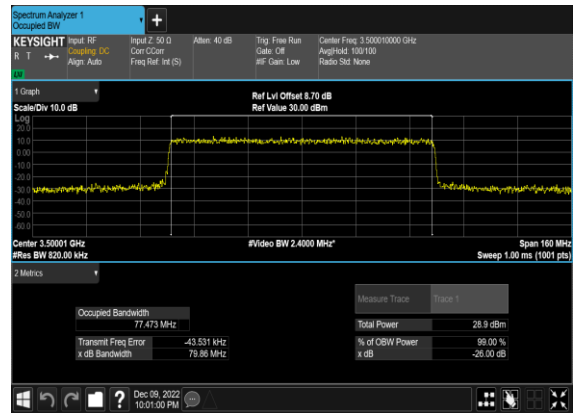

N77(80M)_CP-OFDM_64QAM_Outer_Full_Mid_CH

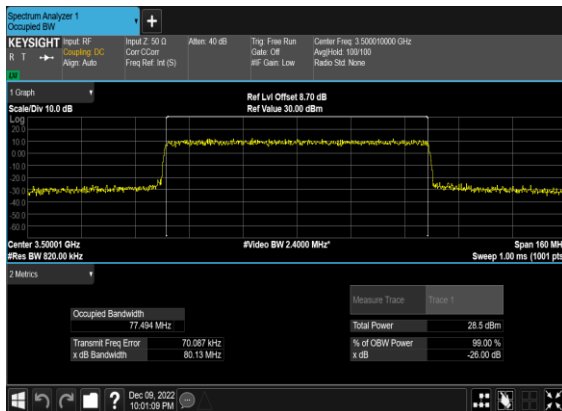

N77(80M)_CP-OFDM_256QAM_Outer_Full_Mid_CH

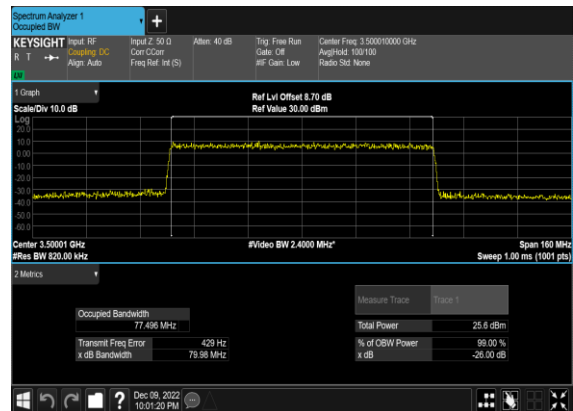

N77(90M)_DFT-s-OFDM_PI_2- BPSK_Outer_Full_Mid_CH

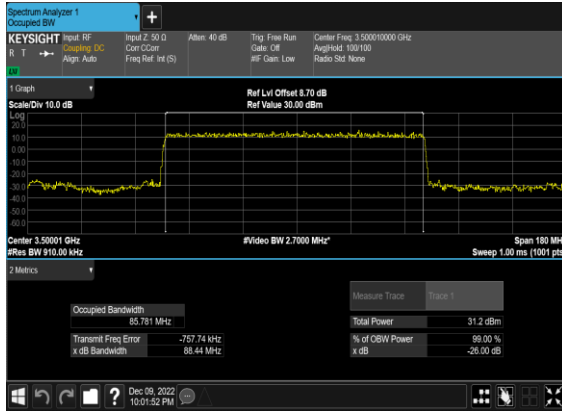

N77(90M)_DFT-s- OFDM_QPSK_Outer_Full_Mid_CH

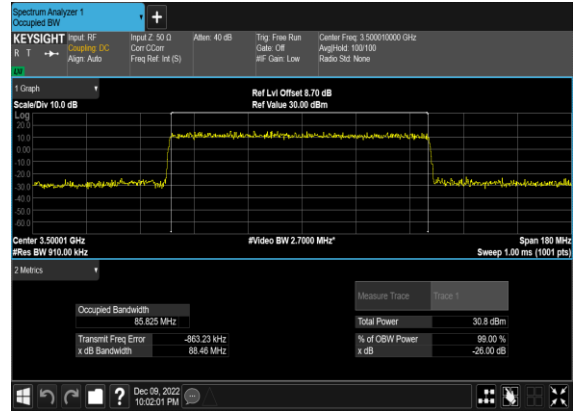

N77(90M)_CP- OFDM_QPSK_Outer_Full_Mid_CH

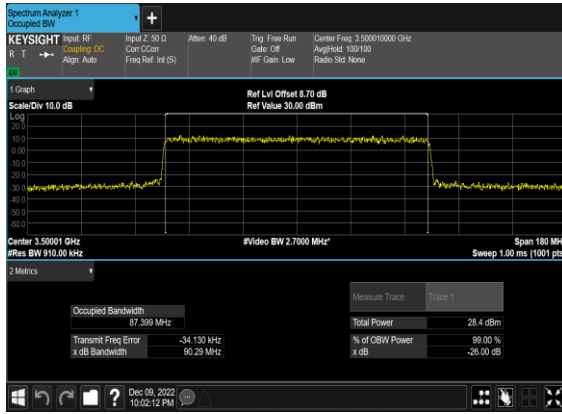

N77(90M)_CP-OFDM_16 QAM_Outer_Full_Mid_CH

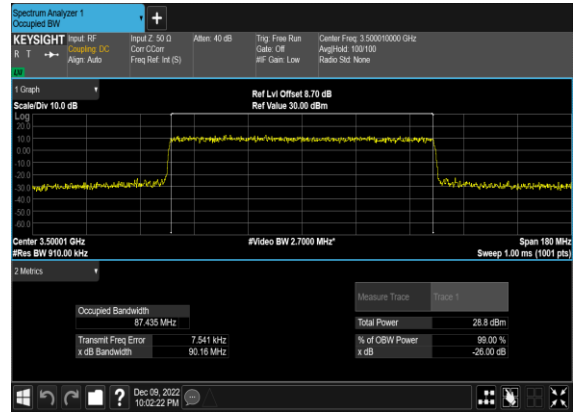

N77(90M)_CP-OFDM_64 QAM_Outer_Full_Mid_CH

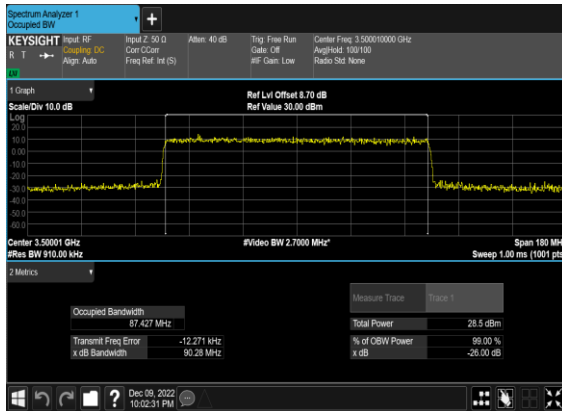

N77(90M)_CP-OFDM_256 QAM_Outer_Full_Mid_CH

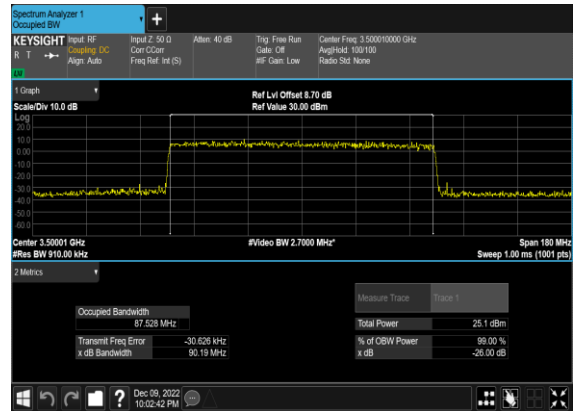

N77(100M)_DFT-s-OFDM_PI_2- BPSK_Outer_Full_Mid_CH

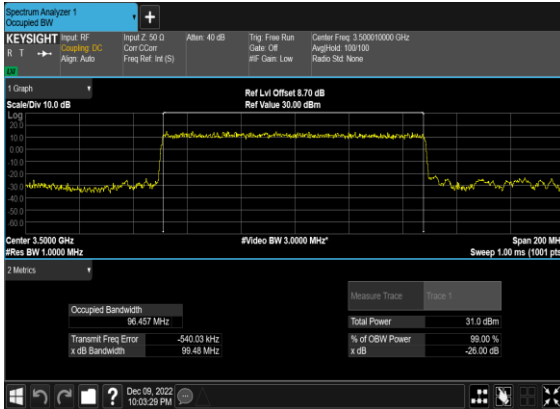

N77(100M)_DFT-s- OFDM_QPSK_Outer_Full_Mid_CH

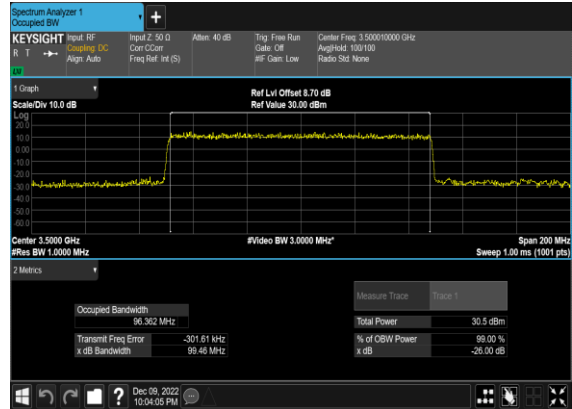

N77(100M)_CP- OFDM_QPSK_Outer_Full_Mid_CH

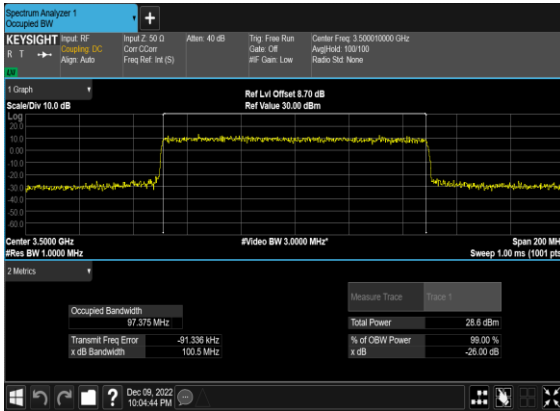

N77(100M)_CP-OFDM_16 QAM_Outer_Full_Mid_CH

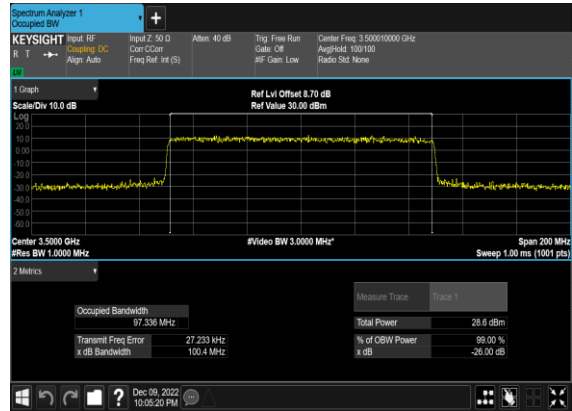

N77(100M)_CP-OFDM_64 QAM_Outer_Full_Mid_CH

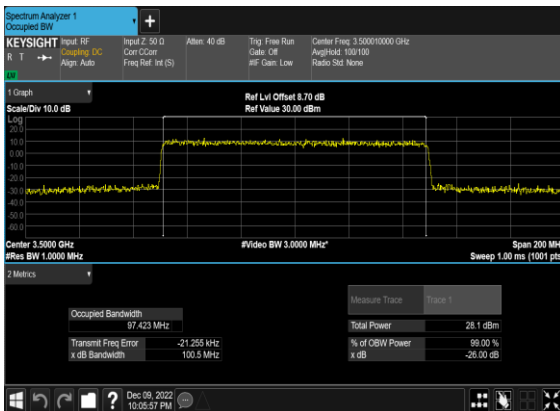

N77(100M)_CP-OFDM_256 QAM_Outer_Full_Mid_CH

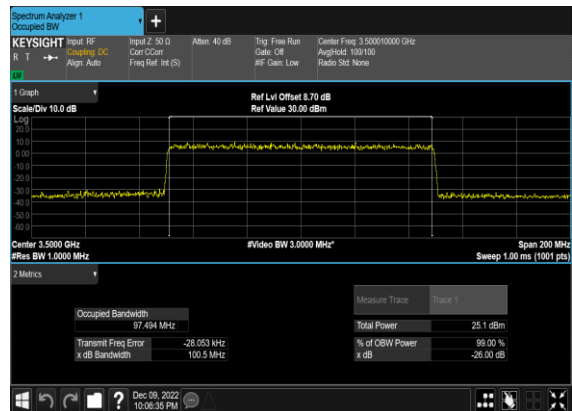

Conducted Spurious Emissions

NR Band	SCS (kHz)	Bandwidth (MHz)	Arfcn	Freq (MHz)	Modulation	RB	Result	Verdict
77	30	10	630334	3455.01	DFT-s-OFDM BPSK	1@0	see graph	---
77	30	10	630334	3455.01	DFT-s-OFDM BPSK	1@0	see graph	PASS
77	30	10	630334	3455.01	DFT-s-OFDM BPSK	1@0	see graph	PASS
77	30	10	630334	3455.01	DFT-s-OFDM QPSK	1@0	see graph	---
77	30	10	630334	3455.01	DFT-s-OFDM QPSK	1@0	see graph	PASS
77	30	10	630334	3455.01	DFT-s-OFDM QPSK	1@0	see graph	PASS
77	30	10	633334	3500.01	DFT-s-OFDM BPSK	1@0	see graph	---
77	30	10	633334	3500.01	DFT-s-OFDM BPSK	1@0	see graph	PASS
77	30	10	633334	3500.01	DFT-s-OFDM BPSK	1@0	see graph	PASS
77	30	10	633334	3500.01	DFT-s-OFDM QPSK	1@0	see graph	---
77	30	10	633334	3500.01	DFT-s-OFDM QPSK	1@0	see graph	PASS
77	30	10	633334	3500.01	DFT-s-OFDM QPSK	1@0	see graph	PASS
77	30	10	636332	3544.98	DFT-s-OFDM BPSK	1@0	see graph	---
77	30	10	636332	3544.98	DFT-s-OFDM BPSK	1@0	see graph	PASS
77	30	10	636332	3544.98	DFT-s-OFDM BPSK	1@0	see graph	PASS
77	30	10	636332	3544.98	DFT-s-OFDM QPSK	1@0	see graph	---
77	30	10	636332	3544.98	DFT-s-OFDM QPSK	1@0	see graph	PASS
77	30	10	636332	3544.98	DFT-s-OFDM QPSK	1@0	see graph	PASS
77	30	50	631668	3475.02	DFT-s-OFDM BPSK	1@0	see graph	---
77	30	50	631668	3475.02	DFT-s-OFDM BPSK	1@0	see graph	PASS
77	30	50	631668	3475.02	DFT-s-OFDM BPSK	1@0	see graph	PASS
77	30	50	631668	3475.02	DFT-s-OFDM QPSK	1@0	see graph	---

77	30	50	631668	3475.02	DFT-s-OFDM QPSK	1@0	see graph	PASS
77	30	50	631668	3475.02	DFT-s-OFDM QPSK	1@0	see graph	PASS
77	30	50	633334	3500.01	DFT-s-OFDM BPSK	1@0	see graph	---
77	30	50	633334	3500.01	DFT-s-OFDM BPSK	1@0	see graph	PASS
77	30	50	633334	3500.01	DFT-s-OFDM BPSK	1@0	see graph	PASS
77	30	50	633334	3500.01	DFT-s-OFDM QPSK	1@0	see graph	---
77	30	50	633334	3500.01	DFT-s-OFDM QPSK	1@0	see graph	PASS
77	30	50	633334	3500.01	DFT-s-OFDM QPSK	1@0	see graph	PASS
77	30	50	635000	3525.0	DFT-s-OFDM BPSK	1@0	see graph	---
77	30	50	635000	3525.0	DFT-s-OFDM BPSK	1@0	see graph	PASS
77	30	50	635000	3525.0	DFT-s-OFDM BPSK	1@0	see graph	PASS
77	30	50	635000	3525.0	DFT-s-OFDM QPSK	1@0	see graph	---
77	30	50	635000	3525.0	DFT-s-OFDM QPSK	1@0	see graph	PASS
77	30	50	635000	3525.0	DFT-s-OFDM QPSK	1@0	see graph	PASS
77	30	100	633334	3500.01	DFT-s-OFDM BPSK	1@0	see graph	---
77	30	100	633334	3500.01	DFT-s-OFDM BPSK	1@0	see graph	PASS
77	30	100	633334	3500.01	DFT-s-OFDM BPSK	1@0	see graph	PASS
77	30	100	633334	3500.01	DFT-s-OFDM QPSK	1@0	see graph	---
77	30	100	633334	3500.01	DFT-s-OFDM QPSK	1@0	see graph	PASS
77	30	100	633334	3500.01	DFT-s-OFDM QPSK	1@0	see graph	PASS

N77(10M)_DFT-s-OFDM_BPSK_Edge_1RB_Left_Low_CH



N77(10M)_DFT-s-OFDM_BPSK_Edge_1RB_Left_Low_CH

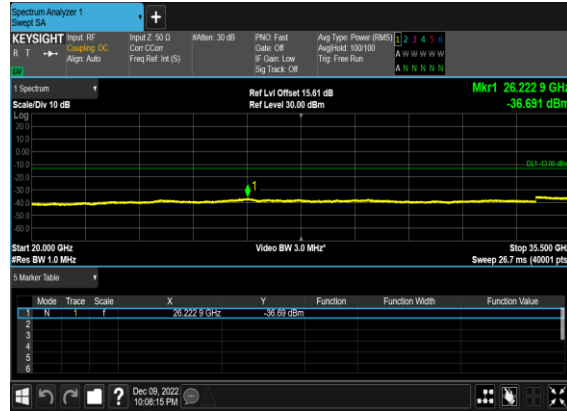

N77(10M)_DFT-s-OFDM_QPSK_Edge_1RB_Left_Low_CH



N77(10M)_DFT-s-OFDM_QPSK_Edge_1RB_Left_Low_CH

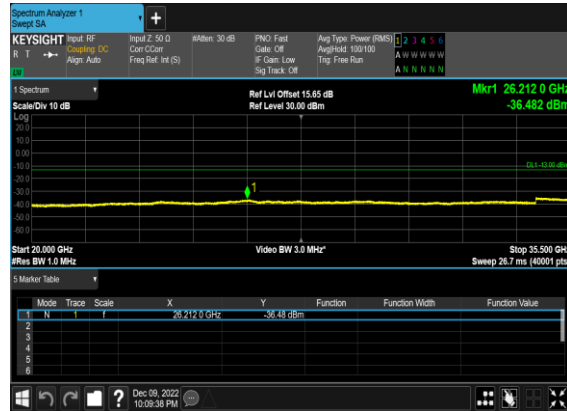

N77(10M)_DFT-s-OFDM_BPSK_Edge_1RB_Left_Mid_CH

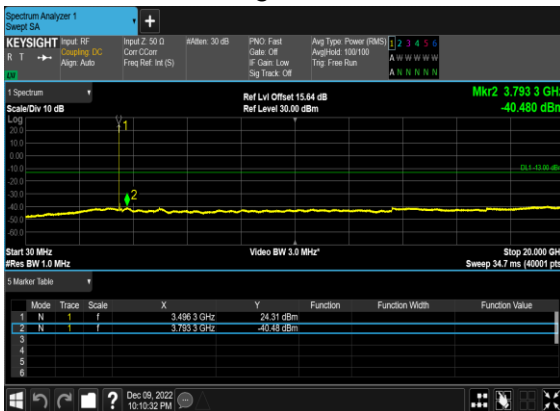

N77(10M)_DFT-s-OFDM_BPSK_Edge_1RB_Left_Mid_CH

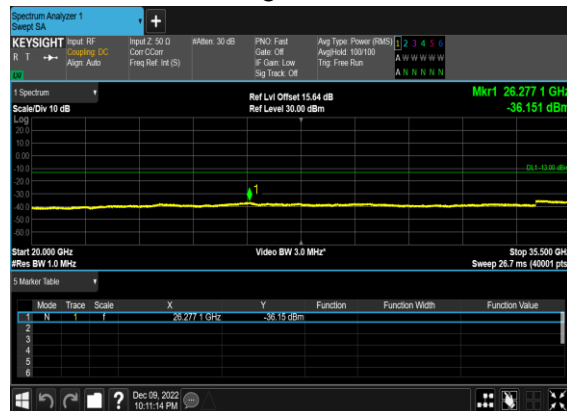

N77(10M)_DFT-s-OFDM_QPSK_Edge_1RB_Left_Mid_CH



N77(10M)_DFT-s-OFDM_QPSK_Edge_1RB_Left_Mid_CH

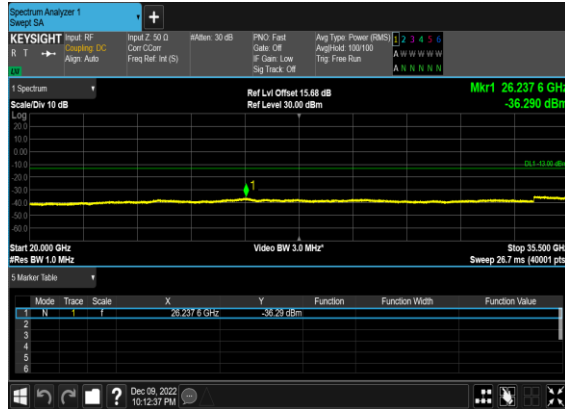

N77(10M)_DFT-s-OFDM_BPSK_Edge_1RB_Left_High_CH

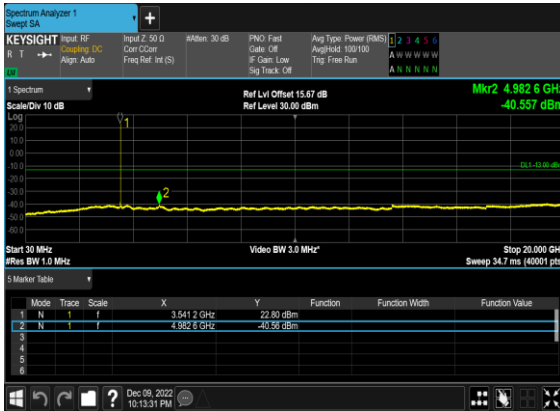

N77(10M)_DFT-s-OFDM_BPSK_Edge_1RB_Left_High_CH

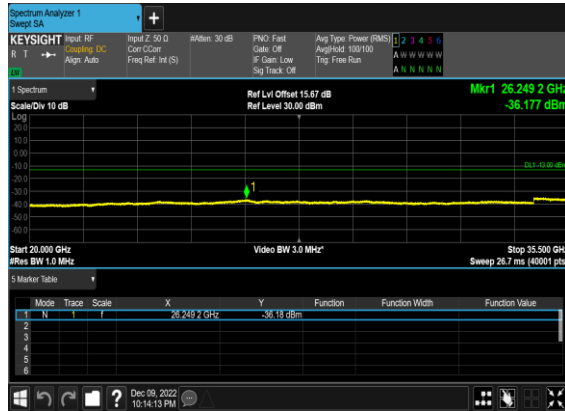

N77(10M)_DFT-s-OFDM_QPSK_Edge_1RB_Left_High_CH

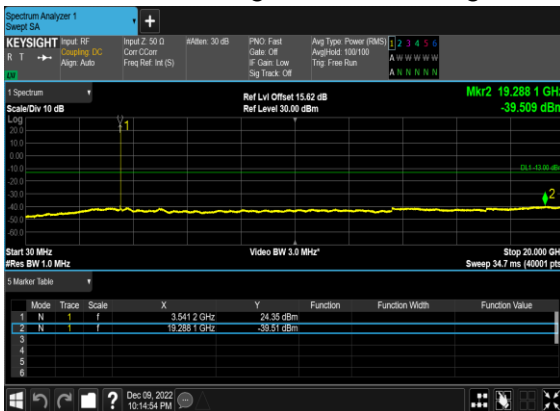

N77(10M)_DFT-s-OFDM_QPSK_Edge_1RB_Left_High_CH

