



FCC RF Test Report

APPLICANT : Motorola Mobility LLC
EQUIPMENT : Mobile Cellular Phone
BRAND NAME : Motorola
MODEL NAME : XT2315-1, XT2315-4, XT2315-5
FCC ID : IHDT56AL2
STANDARD : 47 CFR Part 2, 27
CLASSIFICATION : PCS Licensed Transmitter Held to Ear (PCE)
TEST DATE(S) : Dec. 09, 2022 ~ Jan. 16, 2023

We, Sporton International Inc. (ShenZhen), would like to declare that the tested sample has been evaluated in accordance with the procedures given in ANSI C63.26-2015 and shown compliance with the applicable technical standards.

The test results in this report apply exclusively to the tested model / sample. Without written approval of Sporton International Inc. (ShenZhen), the test report shall not be reproduced except in full.

Jason Jia



Approved by: Jason Jia

Sporton International Inc. (ShenZhen)

1/F, 2/F, Bldg 5, Shiling Industrial Zone, Xinwei Village, Xili, Nanshan, Shenzhen, 518055

People's Republic of China



TABLE OF CONTENTS

REVISION HISTORY..... 3
SUMMARY OF TEST RESULT 4
1 GENERAL DESCRIPTION 5
1.1 Applicant 5
1.2 Manufacturer 5
1.3 Product Feature of Equipment Under Test 5
1.4 Specification of Accessory 6
1.5 Product Specification of Equipment Under Test 5
1.6 Modification of EUT 6
1.7 Maximum EIRP Power and Emission Designator 6
1.8 Testing Site 7
1.9 Test Software 7
1.10 Applied Standards 7
2 TEST CONFIGURATION OF EQUIPMENT UNDER TEST 8
2.1 Test Mode 8
2.2 Connection Diagram of Test System 9
2.3 Support Unit used in test configuration and system 9
2.4 Measurement Results Explanation Example 9
2.5 Frequency List of Low/Middle/High Channels 10
3 CONDUCTED TEST ITEMS 11
3.1 Measuring Instruments 11
3.2 Test Setup 11
3.3 Test Result of Conducted Test 11
3.4 Conducted Output Power Measurement 12
3.5 Peak-to-Average Ratio 13
3.6 EIRP 14
3.7 Occupied Bandwidth 15
3.8 Conducted Band Edge Measurement 16
3.9 Conducted Spurious Emission Measurement 17
3.10 Frequency Stability Measurement 18
4 RADIATED TEST ITEMS 19
4.1 Measuring Instruments 19
4.2 Test Setup 19
4.3 Test Result of Radiated Test 20
4.4 Radiated Spurious Emission Measurement 21
5 LIST OF MEASURING EQUIPMENT 22
6 UNCERTAINTY OF EVALUATION 23
APPENDIX A. TEST RESULTS OF CONDUCTED TEST
APPENDIX B. TEST RESULTS OF RADIATED TEST
APPENDIX C. TEST SETUP PHOTOGRAPHS

SUMMARY OF TEST RESULT

Report Section	FCC Rule	Description	Limit	Result	Remark
3.4	§2.1046	Conducted Output Power	—	Report Only	-
3.5	-	Peak-to-Average Ratio	—	Report Only	-
3.6	§27.50 (a)(3)	EIRP	EIRP < 250mW/5MHz	PASS	-
3.7	§2.1049	Occupied Bandwidth	—	Report Only	-
3.8	§2.1051 §27.53 (a)(4)	Conducted Band Edge Measurement	Refer standard	PASS	-
3.9	§2.1051 §27.53 (a)(4)	Conducted Spurious Emission	< 70+10log ₁₀ (P[Watts])	PASS	-
3.10	§2.1055 §27.54	Frequency Stability Temperature & Voltage	Within the band	PASS	-
4.4	§2.1053 §27.53 (a)(4)	Radiated Spurious Emission	< 70+10log ₁₀ (P[Watts])	PASS	Under limit 5.09 dB at 6916.410 MHz

Declaration of Conformity:

The test results with all measurement uncertainty excluded are presented in accordance with the regulation limits or requirements declared by manufacturers.

Comments and Explanations:

The declared of product specification for EUT presented in the report are provided by the manufacturer, and the manufacturer takes all the responsibilities for the accuracy of product specification.

1 General Description

1.1 Applicant

Motorola Mobility LLC
 222 W, Merchandise Mart Plaza, Chicago IL 60654 USA

1.2 Manufacturer

Motorola Mobility LLC
 222 W, Merchandise Mart Plaza, Chicago IL 60654 USA

1.3 Product Feature of Equipment Under Test

Product Feature	
Equipment	Mobile Cellular Phone
Brand Name	Motorola
Model Name	XT2315-1, XT2315-4, XT2315-5
FCC ID	IHDT56AL2
IMEI Code	Conducted : 359709930025070/359709930025112 Radiation : 359709930025237/359709930025245
HW Version	DVT2
SW Version	T1TGN33.33
EUT Stage	Identical Prototype

1.4 Product Specification of Equipment Under Test

Product Feature	
Tx Frequency	5G NR n30 : 2305 MHz ~ 2315 MHz
Rx Frequency	5G NR n30 : 2350 MHz ~ 2360 MHz
Bandwidth	5MHz / 10MHz
SCS	15kHz
Maximum Output Power	Ant. 1 : 22.27 dBm
Antenna Gain / Type	Ant. 1 : -5.00 dBi / IFA Antenna Ant. 7 : -6.70 dBi / LOOP Antenna
Type of Modulation	5G NR: DFT-s-OFDM (PI/2 BPSK / QPSK / 16QAM / 64QAM / 256QAM) CP-OFDM (QPSK / 16QAM / 64QAM / 256QAM)

Remark: .

1. 5G NR n30 supports SA and NSA mode. According to the maximum power between SA and NSA mode, SA covers NSA mode for conducted test items.
2. The maximum EIRP is calculated from max output power and max antenna gain, only the maximum EIRP of Antenna 1 is shown in the report.
3. For NSA mode of all EN-DC combination, we only show the combination of the maximum power among all NSA combinations in the report.

- 4. The EN-DC mode combination could be referred to the product spec.

1.5 Modification of EUT

No modifications are made to the EUT during all test items.

1.6 Specification of Accessory

Specification of Accessory				
AC Adapter 1	Brand Name	Motorola (Chenyang)	Model Name	MC-101
AC Adapter 2	Brand Name	Motorola (Salcomp)	Model Name	MC-101
AC Adapter 3	Brand Name	Motorola (AOHAI)	Model Name	MC-101
AC Adapter 4	Brand Name	Motorola(Salcomp)	Model Name	MC-101
Battery 1	Brand Name	Motorola(ATL)	Model Name	PG50
Battery 2	Brand Name	Motorola(SCUD)	Model Name	PG50
USB Cable 1	Brand Name	Motorola(Saibao)	Model Name	SC18D22297
USB Cable 2	Brand Name	Motorola(Cabletech)	Model Name	SC18D22298
USB Cable 3	Brand Name	Motorola(Luxshare)	Model Name	SC18D22299

1.7 Maximum EIRP Power and Emission Designator

5G NR n30		PI/2 BPSK / QPSK		16QAM / 64QAM / 256QAM	
BW (MHz)	Frequency Range (MHz)	Maximum EIRP(W)	Emission Designator (99%OBW)	Maximum EIRP(W)	Emission Designator (99%OBW)
5	2307.5 ~ 2312.5	0.0527	4M48G7D	0.0421	4M49W7D
10	2310.0	0.0533	9M28G7D	0.0425	9M28W7D

Note: All modulations have been tested, and only the worst test results of PSK & QAM are shown in the report.

1.8 Testing Site

Sporton International Inc. (ShenZhen) is accredited to ISO/IEC 17025:2017 by American Association for Laboratory Accreditation with Certificate Number 5145.01.

Test Firm	Sporton International Inc. (ShenZhen)		
Test Site Location	1/F, 2/F, Bldg 5, Shiling Industrial Zone, Xinwei Village, Xili, Nanshan, Shenzhen, 518055 People's Republic of China TEL: +86-755-86379589 FAX: +86-755-86379595		
Test Site No.	Sporton Site No.	FCC Designation No.	FCC Test Firm Registration No.
	TH01-SZ	CN1256	421272

Test Firm	Sporton International Inc. (ShenZhen)		
Test Site Location	101, 1st Floor, Block B, Building 1, No. 2, Tengfeng 4th Road, Fenghuang Community, Fuyong Street, Baoan District, Shenzhen City Guangdong Province China 518103 TEL: +86-755-33202398		
Test Site No.	Sporton Site No.	FCC Designation No.	FCC Test Firm Registration No.
	03CH03-SZ	CN1256	421272

1.9 Test Software

Item	Site	Manufacturer	Name	Version
1.	03CH03-KS	AUDIX	E3	6.2009-8-24a

1.10 Applied Standards

According to the specifications of the manufacturer, the EUT must comply with the requirements of the following standards:

- ♦ 47 CFR Part 2, Part 27(D)
- ♦ ANSI C63.26-2015
- ♦ FCC KDB 971168 Power Meas License Digital Systems D01 v03r01
- ♦ FCC KDB 412172 D01 Determining ERP and EIRP v01r01

Remark:

1. All test items were verified and recorded according to the standards and without any deviation during the test.
2. This EUT has also been tested and complied with the requirements of FCC Part 15, Subpart B, recorded in a separate test report.



2 Test Configuration of Equipment Under Test

2.1 Test Mode

Antenna port conducted and radiated test items listed below are performed according to KDB 971168 D01 Power Meas. License Digital Systems v03r01 with maximum output power.

Radiated measurements are performed by rotating the EUT in three different orthogonal test planes (X, Y, Z) to find the maximum emission(Z plane).

Conducted Test Cases	Band	Bandwidth (MHz)				Modulation					RB #			Test Channel		
		1.4	3	5	10	PI/2 BPSK	QPSK	16QAM	64QAM	256QAM	1	Half	Full	L	M	H
Max. Output Power	n30	-	-	v		v	v	v	v	v	v		v	v	v	v
		-	-		v	v	v	v	v	v	v		v		v	
Peak-to-Average Ratio	n30	-	-		v	v	v				v		v		v	
E.I.R.P	n30	-	-	v		v	v	v	v	v	v		v	v	v	v
		-	-		v	v	v	v	v	v	v		v		v	
26dB and 99% Bandwidth	n30	-	-	v	v	v	v	v	v	v			v		v	
Conducted Band Edge	n30	-	-	v		v	v				v		v	v		v
		-	-		v	v	v				v		v		v	
Conducted Spurious Emission	n30	-	-	v		v	v				v			v	v	v
		-	-		v	v	v				v				v	
Frequency Stability	n30	-	-		v		v						v		v	
Radiated Spurious Emission	n30	Worst Case											v	v	v	
Note	1. The mark "v " means that this configuration is chosen for testing 2. The mark "- " means that this bandwidth is not supported. 3. The device is investigated from 30MHz to 10 times of fundamental signal for radiated spurious emission test under different RB size/offset and modulations in exploratory test. Subsequently, only the worst case emissions are reported. 4. Frequency Stability : Normal Voltage = 3.89V ; Low Voltage =3.5V ; High Voltage =4.48V															

2.2 Connection Diagram of Test System

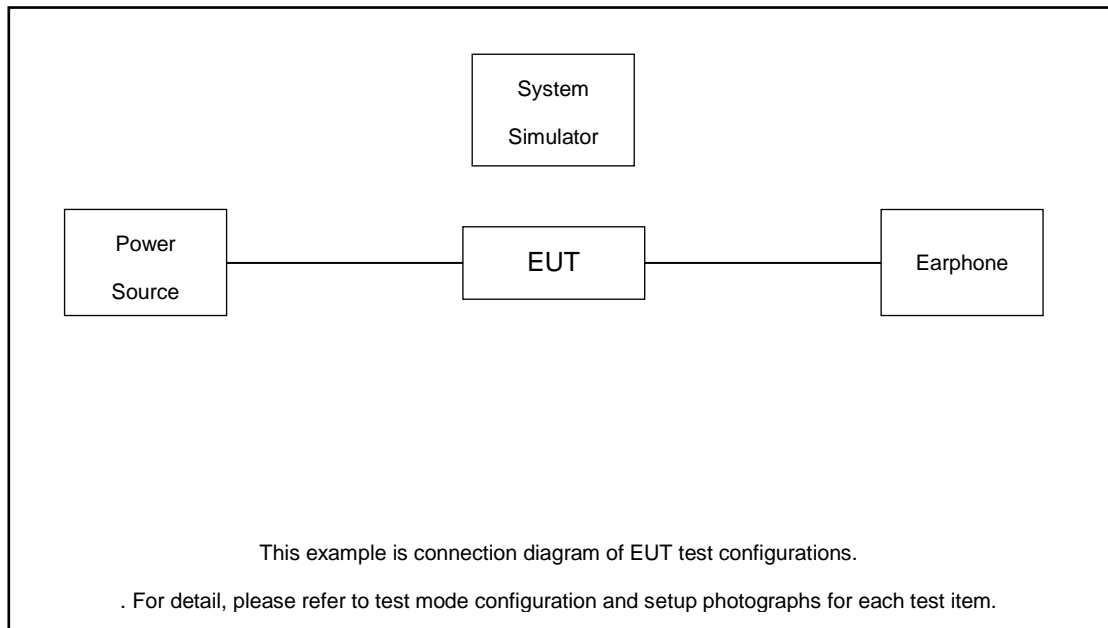

2.3 Support Unit used in test configuration and system

Item	Equipment	Trade Name	Model No.	FCC ID	Data Cable	Power Cord
1.	Power Supply	GWINSTEK	PSS-2002	N/A	N/A	Unshielded, 1.8 m
2.	LTE Base Station	Anritsu	MT8821C	N/A	N/A	Unshielded, 1.8 m
3.	NR Base Station	Anritsu	MT8000A	N/A	N/A	Unshielded, 1.8 m

2.4 Measurement Results Explanation Example

For all conducted test items:

The offset level is set in the spectrum analyzer to compensate the RF cable loss between EUT conducted output port and spectrum analyzer. With the offset compensation, the spectrum analyzer reading level is exactly the EUT RF output level.

The spectrum analyzer offset is derived from RF cable loss.

$$\text{Offset} = \text{RF cable loss}.$$

Following shows an offset computation example with cable loss 8.4 dB.

Example :

$$\begin{aligned} \text{Offset(dB)} &= \text{RF cable loss(dB)}. \\ &= 8.4 \text{ (dB)} \end{aligned}$$



2.5 Frequency List of Low/Middle/High Channels

5G NR n30 Channel and Frequency List				
BW [MHz]	Channel/Frequency(MHz)	Lowest	Middle	Highest
10	Channel	-	462000	-
	Frequency	-	2310	-
5	Channel	461500	462000	462500
	Frequency	2307.5	2310	2312.5

3 Conducted Test Items

3.1 Measuring Instruments

See list of measuring instruments of this test report.

3.2 Test Setup

3.2.1 Conducted Output Power

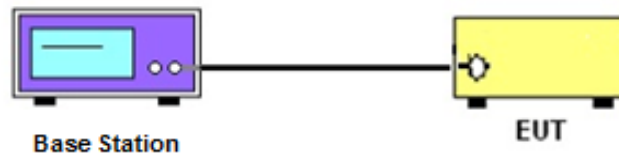

3.2.2 Peak-to-Average Ratio, Occupied / 26dB Bandwidth, Band-Edge and Conducted Spurious Emission

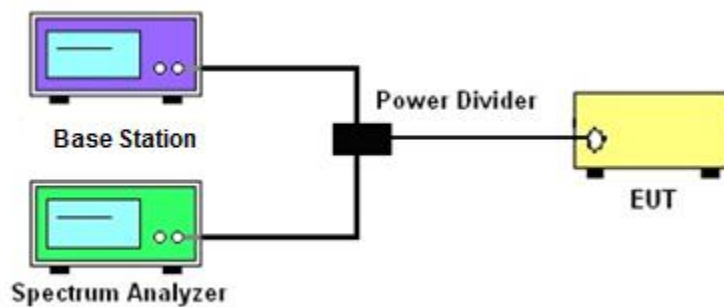

3.2.3 Frequency Stability

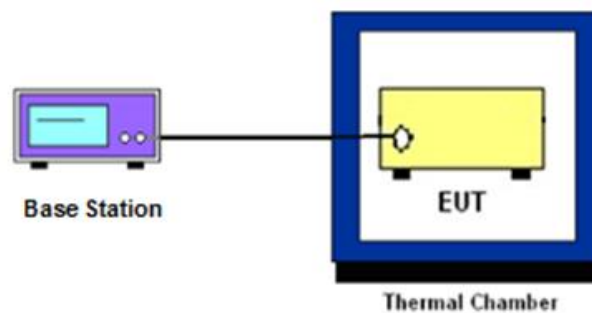

3.3 Test Result of Conducted Test

Please refer to Appendix A.

3.4 Conducted Output Power Measurement

3.4.1 Description of the Conducted Output Power Measurement

A base station simulator was used to establish communication with the EUT. Its parameters were set to transmit the maximum power on the EUT. The measured power in the radio frequency on the transmitter output terminals shall be reported.

3.4.2 Test Procedures

1. The testing follows ANSI C63.26 Section 5.2
2. The transmitter output port was connected to the system simulator.
3. Set EUT at maximum power through the system simulator.
4. Select lowest, middle, and highest channels for each band and different modulation.
5. Measure and record the power level from the system simulator.



3.5 Peak-to-Average Ratio

3.5.1 Description of the PAR Measurement

Power Complementary Cumulative Distribution Function (CCDF) curves provide a means for characterizing the power peaks of a digitally modulated signal on a statistical basis. A CCDF curve depicts the probability of the peak signal amplitude exceeding the average power level. Most contemporary measurement instrumentation include the capability to produce CCDF curves for an input signal provided that the instrument's resolution bandwidth can be set wide enough to accommodate the entire input signal bandwidth. In measuring transmissions in this band using an average power technique, the peak-to-average ratio (PAR) of the transmission may not exceed 13 dB.

3.5.2 Test Procedures

1. The testing follows ANSI C63.26 Section 5.2.3.4 (CCDF).
2. The EUT was connected to spectrum and system simulator via a power divider.
3. Set the CCDF (Complementary Cumulative Distribution Function) option in spectrum analyzer.
4. The highest RF powers were measured and recorded the maximum PAPR level associated with a probability of 0.1 %.
5. Record the deviation as Peak to Average Ratio.

3.6 EIRP

3.6.1 Description of EIRP

For mobile and portable stations transmitting in the 2305-2315 MHz band or the 2350-2360 MHz band, the average EIRP must not exceed 50 milliwatts within any 1 megahertz of authorized bandwidth, *except that* for mobile and portable stations compliant with 3GPP LTE standards or another advanced mobile broadband protocol that avoids concentrating energy at the edge of the operating band the average EIRP must not exceed 250 milliwatts within any 5 megahertz of authorized bandwidth but may exceed 50 milliwatts within any 1 megahertz of authorized bandwidth. For mobile and portable stations using time division duplexing (TDD) technology, the duty cycle must not exceed 38 percent in the 2305-2315 MHz and 2350-2360 MHz bands. Mobile and portable stations using FDD technology are restricted to transmitting in the 2305-2315 MHz band. Power averaging shall not include intervals in which the transmitter is off.

3.6.2 Test Procedures

1. According to KDB 412172 D01 Power Approach,
2. $EIRP = P_T + G_T - L_C$, $ERP = EIRP - 2.15$, where

P_T = transmitter output power in dBm

G_T = gain of the transmitting antenna in dBi

L_C = signal attenuation in the connecting cable between the transmitter and antenna in dB

3.7 Occupied Bandwidth

3.7.1 Description of Occupied Bandwidth Measurement

The occupied bandwidth is the width of a frequency band such that, below the lower and above the upper frequency limits, the mean powers emitted are each equal to a specified percentage 0.5% of the total mean transmitted power.

The 26 dB emission bandwidth is defined as the frequency range between two points, one above and one below the carrier frequency, at which the spectral density of the emission is attenuated 26 dB below the maximum in-band spectral density of the modulated signal. Spectral density (power per unit bandwidth) is to be measured with a detector of resolution bandwidth equal to approximately 1.0% of the emission bandwidth.

3.7.2 Test Procedures

1. The testing follows ANSI C63.26 Section 5.4
2. The EUT was connected to spectrum analyzer and system simulator via a power divider.
3. The spectrum analyzer center frequency is set to the nominal EUT channel center frequency. The span range for the spectrum analyzer shall be between two and five times the anticipated OBW.
4. The nominal resolution bandwidth (RBW) shall be in the range of 1 to 5 % of the anticipated OBW, and the VBW shall be at least 3 times the RBW.
5. Set the detection mode to peak, and the trace mode to max hold.
6. Determine the reference value: Set the EUT to transmit a modulated signal. Allow the trace to stabilize. Set the spectrum analyzer marker to the highest level of the displayed trace.
(this is the reference value)
7. Determine the “-26 dB down amplitude” as equal to (Reference Value – X).
8. Place two markers, one at the lowest and the other at the highest frequency of the envelope of the spectral display such that each marker is at or slightly below the “-X dB down amplitude” determined in step 6. If a marker is below this “-X dB down amplitude” value it shall be placed as close as possible to this value. The OBW is the positive frequency difference between the two markers.
9. Use the 99 % power bandwidth function of the spectrum analyzer and report the measured bandwidth.

3.8 Conducted Band Edge Measurement

3.8.1 Description of Conducted Band Edge Measurement

27.53 (a)(4)

For mobile and portable stations operating in the 2305-2315 MHz and 2350-2360 MHz bands:

- (i) By a factor of not less than: $43 + 10 \log (P)$ dB on all frequencies between 2305 and 2320 MHz and on all frequencies between 2345 and 2360 MHz that are outside the licensed band(s) of operation, not less than $55 + 10 \log (P)$ dB on all frequencies between 2320 and 2324 MHz and on all frequencies between 2341 and 2345 MHz, not less than $61 + 10 \log (P)$ dB on all frequencies between 2324 and 2328 MHz and on all frequencies between 2337 and 2341 MHz, and not less than $67 + 10 \log (P)$ dB on all frequencies between 2328 and 2337 MHz;
- (ii) By a factor of not less than $43 + 10 \log (P)$ dB on all frequencies between 2300 and 2305 MHz, $55 + 10 \log (P)$ dB on all frequencies between 2296 and 2300 MHz, $61 + 10 \log (P)$ dB on all frequencies between 2292 and 2296 MHz, $67 + 10 \log (P)$ dB on all frequencies between 2288 and 2292 MHz, and $70 + 10 \log (P)$ dB below 2288 MHz;
- (iii) By a factor of not less than $43 + 10 \log (P)$ dB on all frequencies between 2360 and 2365 MHz, and not less than $70 + 10 \log (P)$ dB above 2365 MHz.

3.8.2 Test Procedures

1. The testing follows ANSI C63.26 section 5.7
2. The EUT was connected to spectrum analyzer and system simulator via a power divider.
3. The band edges of low and high channels for the highest RF powers were measured.
4. Set RBW \geq 1% EBW in the 1MHz band immediately outside and adjacent to the band edge.
5. Beyond the 1 MHz band from the band edge, RBW=1MHz was used.
6. Set spectrum analyzer with RMS detector.
7. The RF fundamental frequency should be excluded against the limit line in the operating frequency band.
8. Checked that all the results comply with the emission limit line.

Example:

$$\begin{aligned} & \text{The limit line is derived from } 43 + 10\log(P)\text{dB below the transmitter power } P(\text{Watts}) \\ & = P(\text{W}) - [43 + 10\log(P)] \text{ (dB)} \\ & = [30 + 10\log(P)] \text{ (dBm)} - [43 + 10\log(P)] \text{ (dB)} = -13\text{dBm}. \end{aligned}$$

3.9 Conducted Spurious Emission Measurement

3.9.1 Description of Conducted Spurious Emission Measurement

The power of any emission outside of the authorized operating frequency ranges must be lower than the transmitter power (P) by a factor of at least $70 + 10 \log (P)$ dB.

It is measured by means of a calibrated spectrum analyzer and scanned from 9 kHz up to a frequency including its 10th harmonic.

3.9.2 Test Procedures

1. The testing follows ANSI C63.26 section 5.7
2. The EUT was connected to spectrum analyzer and system simulator via a power divider.
3. The RF output of EUT was connected to the spectrum analyzer by RF cable and attenuator. The path loss was compensated to the results for each measurement.
4. The middle channel for the highest RF power within the transmitting frequency was measured.
5. The conducted spurious emission for the whole frequency range was taken.
6. Make the measurement with the spectrum analyzer's RBW = 1MHz, VBW = 3MHz.
7. Set spectrum analyzer with RMS detector.
8. Taking the record of maximum spurious emission.
9. The RF fundamental frequency should be excluded against the limit line in the operating frequency band.
10. The limit line is derived from $70 + 10\log(P)$ dB below the transmitter power P(Watts)
= P(W)- [70 + 10log(P)] (dB)
= [30 + 10log(P)] (dBm) - [70 + 10log(P)] (dB)
= -40dBm

3.10 Frequency Stability Measurement

3.10.1 Description of Frequency Stability Measurement

The frequency stability shall be measured by variation of ambient temperature and variation of primary supply voltage to ensure that the fundamental emission stays within the authorized frequency block. The frequency stability of the transmitter shall be maintained within $\pm 0.00025\%$ ($\pm 2.5\text{ppm}$) of the center frequency.

3.10.2 Test Procedures for Temperature Variation

1. The testing follows ANSI C63.26 section 5.6.4
2. The EUT was set up in the thermal chamber and connected with the system simulator.
3. With power OFF, the temperature was decreased to -30°C and the EUT was stabilized before testing. Power was applied and the maximum change in frequency was recorded within one minute.
4. With power OFF, the temperature was raised in 10°C step up to 50°C . The EUT was stabilized at each step for at least half an hour. Power was applied and the maximum frequency change was recorded within one minute.

3.10.3 Test Procedures for Voltage Variation

1. The testing follows ANSI C63.26 section 5.6.5.
2. The EUT was placed in a temperature chamber at $20\pm 5^{\circ}\text{C}$ and connected with the system simulator.
3. The power supply voltage to the EUT was varied from 85% to 115% of the nominal value for other than hand carried battery equipment.
4. For hand carried, battery powered equipment, reduce the primary ac or dc supply voltage to the battery operating end point, which shall be specified by the manufacturer.
5. The variation in frequency was measured for the worst case.

4 Radiated Test Items

4.1 Measuring Instruments

See list of measuring instruments of this test report.

4.2 Test Setup

4.2.1 For radiated test below 30MHz



4.2.2 For radiated test from 30MHz to 1GHz

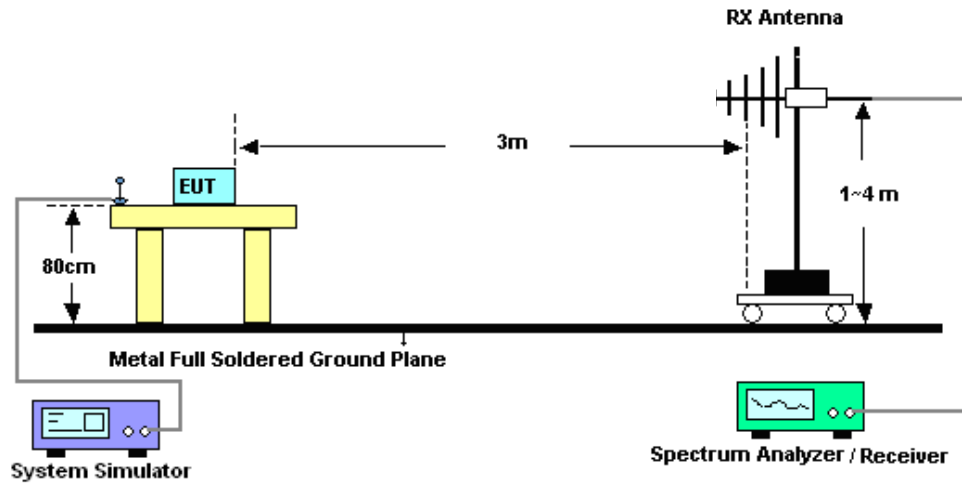

4.2.3 For radiated test above 1GHz

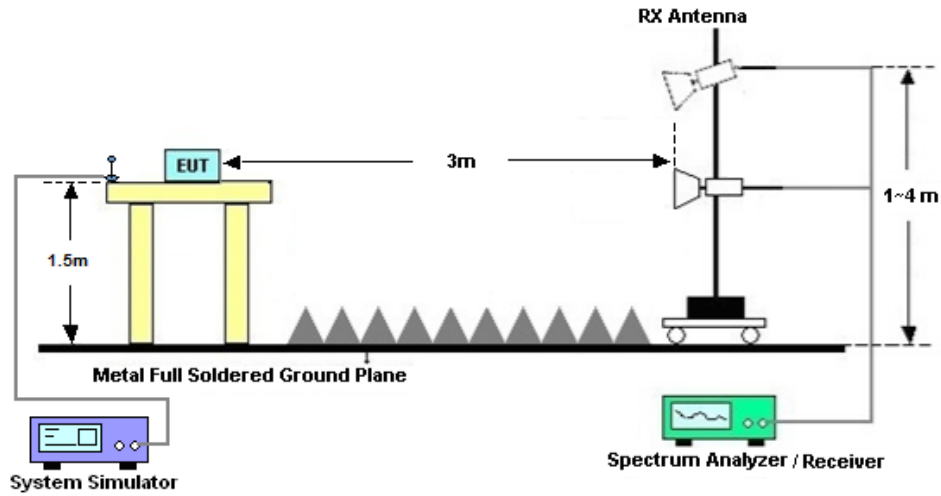

4.3 Test Result of Radiated Test

The low frequency, which started from 9 kHz to 30MHz, was pre-scanned and the result which was 20dB lower than the limit line was not reported.

Please refer to Appendix B.

4.4 Radiated Spurious Emission Measurement

4.4.1 Description of Radiated Spurious Emission

The radiated spurious emission was measured by substitution method according to ANSI C63.26. The power of any emission outside of the authorized operating frequency ranges must be attenuated below the transmitter power (P) by a factor of at least $70 + 10 \log(P)$ dB.

The spectrum is scanned from 30 MHz up to a frequency including its 10th harmonic.

4.4.2 Test Procedures

1. The testing follows ANSI C63.26 Section 5.5
2. The EUT was placed on a turntable with 0.8 meter height for frequency below 1GHz and 1.5 meter height for frequency above 1GHz respectively above ground.
3. The EUT was set 3 meters from the receiving antenna mounted on the antenna tower.
4. The table was rotated 360 degrees to determine the position of the highest spurious emission.
5. The height of the receiving antenna is varied between 1m to 4m to search the maximum spurious emission for both horizontal and vertical polarizations.
6. During the measurement, the system simulator parameters were set to force the EUT transmitting at maximum output power.
7. Make the measurement with the spectrum analyzer's RBW = 1MHz, VBW = 3MHz, taking the record of maximum spurious emission.
8. A horn antenna was substituted in place of the EUT and was driven by a signal generator.
9. Tune the output power of signal generator to the same emission level with EUT maximum spurious emission.

$$\text{EIRP (dBm)} = \text{S.G. Power} - \text{Tx Cable Loss} + \text{Tx Antenna Gain}$$

$$\text{ERP (dBm)} = \text{EIRP} - 2.15$$

10. The RF fundamental frequency should be excluded against the limit line in the operating frequency band.

The limit line is derived from $70 + 10\log(P)$ dB below the transmitter power P(Watts)

$$= P(W) - [70 + 10\log(P)] \text{ (dB)}$$

$$= [30 + 10\log(P)] \text{ (dBm)} - [70 + 10\log(P)] \text{ (dB)}$$

$$= -40\text{dBm.}$$



5 List of Measuring Equipment

Instrument	Manufacturer	Model No.	Serial No.	Characteristics	Calibration Date	Test Date	Due Date	Remark
Spectrum Analyzer	R&S	FSV40	101078	10Hz~40GHz	Apr. 07, 2022	Dec. 09, 2022~ Jan. 16, 2023	Apr. 06, 2023	Conducted (TH01-SZ)
Power Divider	TOJOIN	PS-2SM-04 265	60.06.020.007 7	0.4GHz~26.5GHz	Dec. 26, 2021	Dec. 09, 2022~ Jan. 16, 2023	Dec. 25, 2022	Conducted (TH01-SZ)
Power Divider	TOJOIN	PS-2SM-04 265	60.06.020.007 7	0.4GHz~26.5GHz	Dec. 25, 2022		Dec. 24, 2023	Conducted (TH01-SZ)
Thermal Chamber	Ten Billion Hongzhangroup	LP-150U	H2014081803	-40~+150°C	Jul. 07, 2022	Dec. 09, 2022~ Jan. 16, 2023	Jul. 06, 2023	Conducted (TH01-SZ)
EXA Spectrum Analyzer	KEYSIGHT	N9010A	MY55150213	10Hz~44GHz	Jul. 07, 2022	Dec. 25, 2022	Jul. 06, 2023	Radiation (03CH03-SZ)
Loop Antenna	R&S	HFH2-Z2	100354	9kHz~30MHz	Jul. 28, 2022	Dec. 25, 2022	Jul. 27, 2024	Radiation (03CH03-SZ)
Bilog Antenna	TeseQ	CBL6112D	35407	30MHz-2GHz	Oct. 19, 2022	Dec. 25, 2022	Oct. 18, 2023	Radiation (03CH03-SZ)
Double Ridge Horn Antenna	ETS-Lindgren	3117	00119436	1GHz~18GHz	Jul. 07, 2022	Dec. 25, 2022	Jul. 06, 2023	Radiation (03CH03-SZ)
HF Amplifier	MITEQ	TTA1840-35 -HG	1871923	18GHz~40GHz	Jul. 07, 2022	Dec. 25, 2022	Jul. 06, 2023	Radiation (03CH03-SZ)
SHF-EHF Horn	com-power	AH-840	101071	18Ghz-40GHz	Apr. 10, 2022	Dec. 25, 2022	Apr. 09, 2023	Radiation (03CH03-SZ)
LF Amplifier	Burgeon	BPA-530	102211	0.01~3000Mhz	Oct. 19, 2022	Dec. 25, 2022	Oct. 18, 2023	Radiation (03CH03-SZ)
HF Amplifier	KEYSIGHT	83017A	MY53270105	0.5GHz~26.5Ghz	Oct. 19, 2022	Dec. 25, 2022	Oct. 18, 2023	Radiation (03CH03-SZ)
AC Power Source	Chroma	61601	61601000304 3	N/A	Nov. 10, 2022	Dec. 25, 2022	Nov. 09, 2023	Radiation (03CH03-SZ)
Turn Table	Chaintek	T-200	N/A	0~360 degree	NCR	Dec. 25, 2022	NCR	Radiation (03CH03-SZ)
Antenna Mast	Chaintek	MBS-400	N/A	1 m~4 m	NCR	Dec. 25, 2022	NCR	Radiation (03CH03-SZ)

NCR: No Calibration Required

6 Uncertainty of Evaluation

The measurement uncertainties shown below were calculated in accordance with the requirements of ANSI 63.26-2015. All the measurement uncertainty value were shown with a coverage K=2 to indicate 95% level of confidence. The measurement data show herein meets or exceeds the CISPR measurement uncertainty values specified in CISPR 16-4-2 and can be compared directly to specified limit to determine compliance.

Uncertainty of Conducted Measurement

Test Item	Uncertainty
Conducted Power	±1.34 dB
Conducted Emissions	±1.34 dB
Occupied Channel Bandwidth	±0.13 %

Uncertainty of Radiated Emission Measurement (30 MHz ~ 1000 MHz)

Measuring Uncertainty for a Level of Confidence of 95% (U = 2Uc(y))	3.0dB
---	-------

Uncertainty of Radiated Emission Measurement (1 GHz ~ 18 GHz)

Measuring Uncertainty for a Level of Confidence of 95% (U = 2Uc(y))	3.6dB
---	-------

Uncertainty of Radiated Emission Measurement (18 GHz ~ 40 GHz)

Measuring Uncertainty for a Level of Confidence of 95% (U = 2Uc(y))	3.8dB
---	-------

----- THE END -----



Appendix A. Test Results of Conducted Test

Test Engineer :	Jung Kuo	Temperature :	22~23°C
		Relative Humidity :	40~42%

FR1 N30

Transmitter Conducted Output Power And EIRP, (G_T - L_C)=-5.0dB

NR Band	SCS (kHz)	Bandwidth (MHz)	Arfcn	Freq (MHz)	Modulation	RB	Conducted Power(dBm)	EIRP (dBm)	EIRP (W)
30	15	5	461500	2307.5	DFT-s-OFDM QPSK	1@1	21.62	16.62	0.0459
30	15	5	461500	2307.5	DFT-s-OFDM 16 QAM	1@1	20.88	15.88	0.0387
30	15	5	462000	2310.0	DFT-s-OFDM QPSK	1@1	22.22	17.22	0.0527
30	15	5	462000	2310.0	DFT-s-OFDM 16 QAM	1@1	21.13	16.13	0.0410
30	15	5	462500	2312.5	DFT-s-OFDM QPSK	1@1	22.22	17.22	0.0527
30	15	5	462500	2312.5	DFT-s-OFDM 16 QAM	1@1	21.24	16.24	0.0421
30	15	10	462000	2310	DFT-s-OFDM PI/2 BPSK	25@12	22.24	17.24	0.0530
30	15	10	462000	2310	DFT-s-OFDM PI/2 BPSK	1@1	21.59	16.59	0.0456
30	15	10	462000	2310	DFT-s-OFDM PI/2 BPSK	1@50	21.65	16.65	0.0462
30	15	10	462000	2310	DFT-s-OFDM QPSK	25@12	22.27	17.27	0.0533
30	15	10	462000	2310	DFT-s-OFDM QPSK	1@1	21.37	16.37	0.0434
30	15	10	462000	2310	DFT-s-OFDM QPSK	1@50	21.57	16.57	0.0454
30	15	10	462000	2310	DFT-s-OFDM 16 QAM	25@12	21.28	16.28	0.0425
30	15	10	462000	2310	DFT-s-OFDM 16 QAM	1@1	21.23	16.23	0.0420
30	15	10	462000	2310	DFT-s-OFDM 16 QAM	1@50	21.07	16.07	0.0405
30	15	10	462000	2310	DFT-s-OFDM 64 QAM	25@12	19.85	14.85	0.0305
30	15	10	462000	2310	DFT-s-OFDM 64 QAM	1@1	19.9	14.9	0.0309
30	15	10	462000	2310	DFT-s-OFDM 64 QAM	1@50	19.91	14.91	0.0310
30	15	10	462000	2310	DFT-s-OFDM 256 QAM	25@12	17.22	12.22	0.0167

30	15	10	462000	2310	DFT-s-OFDM 256 QAM	1@1	17.3	12.3	0.0170
30	15	10	462000	2310	DFT-s-OFDM 256 QAM	1@50	17.16	12.16	0.0164
30	15	10	462000	2310	CP-OFDM QPSK	26@13	20.68	15.68	0.0370
30	15	10	462000	2310	CP-OFDM QPSK	1@1	20.35	15.35	0.0343
30	15	10	462000	2310	CP-OFDM QPSK	1@50	20.21	15.21	0.0332

Frequency Stability

NR Band	SCS (kHz)	Bandwidth (MHz)	Arfcn	Freq (MHz)	Modulation	RB	Deviation (ppm)	Verdict	Environment
30	15	10	462000	2310.0	DFT-s-OFDM QPSK	50@0	0.0035	PASS	NV
30	15	10	462000	2310.0	DFT-s-OFDM QPSK	50@0	0.0043	PASS	LV
30	15	10	462000	2310.0	DFT-s-OFDM QPSK	50@0	0.0051	PASS	HV
30	15	10	462000	2310.0	DFT-s-OFDM QPSK	50@0	0.0050	PASS	-30°C
30	15	10	462000	2310.0	DFT-s-OFDM QPSK	50@0	0.0044	PASS	-20°C
30	15	10	462000	2310.0	DFT-s-OFDM QPSK	50@0	0.0022	PASS	-10°C
30	15	10	462000	2310.0	DFT-s-OFDM QPSK	50@0	0.0048	PASS	0°C
30	15	10	462000	2310.0	DFT-s-OFDM QPSK	50@0	0.0064	PASS	10°C
30	15	10	462000	2310.0	DFT-s-OFDM QPSK	50@0	0.0035	PASS	20°C
30	15	10	462000	2310.0	DFT-s-OFDM QPSK	50@0	0.0067	PASS	30°C
30	15	10	462000	2310.0	DFT-s-OFDM QPSK	50@0	0.0037	PASS	40°C
30	15	10	462000	2310.0	DFT-s-OFDM QPSK	50@0	0.0063	PASS	50°C

Peak to Average Ratio

NR Band	SCS (kHz)	Bandwidth (MHz)	Arfcn	Freq (MHz)	Modulation	RB	Result (dB)	Limit (dB)	Verdict
30	15	10	462000	2310.0	DFT-s-OFDM PI/2 BPSK	50@0	4.03	13	PASS
30	15	10	462000	2310.0	DFT-s-OFDM PI/2 BPSK	1@0	4.07	13	PASS
30	15	10	462000	2310.0	DFT-s-OFDM QPSK	50@0	4.48	13	PASS
30	15	10	462000	2310.0	DFT-s-OFDM QPSK	1@0	3.98	13	PASS
30	15	10	462000	2310.0	DFT-s-OFDM PI/2 BPSK	50@0	3.93	13	PASS
30	15	10	462000	2310.0	DFT-s-OFDM PI/2 BPSK	1@0	3.92	13	PASS
30	15	10	462000	2310.0	DFT-s-OFDM QPSK	50@0	4.85	13	PASS
30	15	10	462000	2310.0	DFT-s-OFDM QPSK	1@0	3.87	13	PASS
30	15	10	462000	2310.0	DFT-s-OFDM PI/2 BPSK	50@0	3.82	13	PASS
30	15	10	462000	2310.0	DFT-s-OFDM PI/2 BPSK	1@0	3.6	13	PASS
30	15	10	462000	2310.0	DFT-s-OFDM QPSK	50@0	4.77	13	PASS
30	15	10	462000	2310.0	DFT-s-OFDM QPSK	1@0	3.87	13	PASS

N30(10M)_DFT-s-OFDM_PI_2-BPSK_Outer_Full_Low_CH



N30(10M)_DFT-s-OFDM_PI_2-BPSK_Edge_1RB_Left_Low_CH



N30(10M)_DFT-s-OFDM_QPSK_Outer_Full_Low_CH



N30(10M)_DFT-s-OFDM_QPSK_Edge_1RB_Left_Low_CH

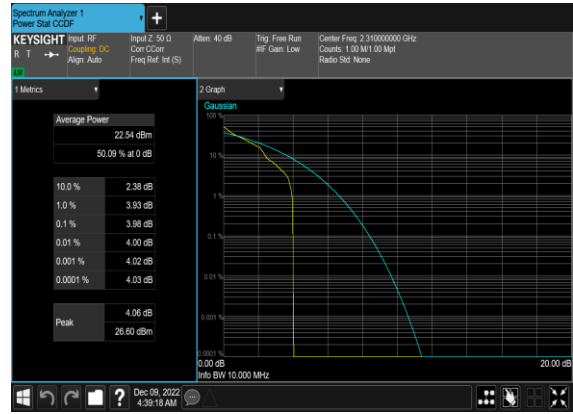

N30(10M)_DFT-s-OFDM_PI_2-BPSK_Outer_Full_Low_CH

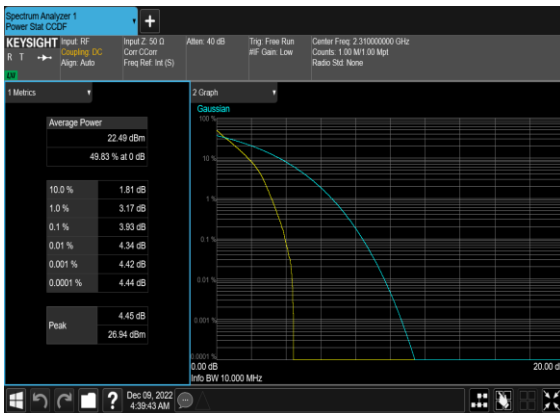

N30(10M)_DFT-s-OFDM_PI_2-BPSK_Edge_1RB_Left_Low_CH



N30(10M)_DFT-s-OFDM_QPSK_Outer_Full_Low_CH



N30(10M)_DFT-s-OFDM_QPSK_Edge_1RB_Left_Low_CH

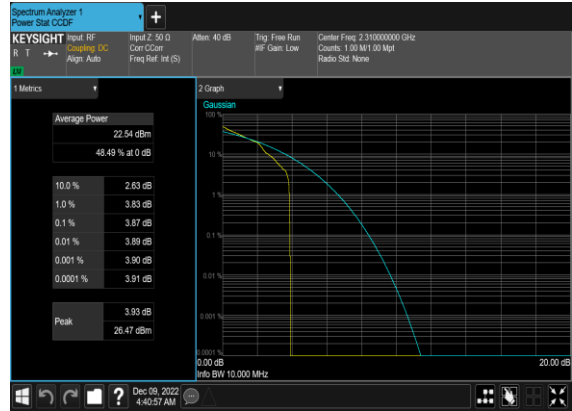

N30(10M)_DFT-s-OFDM_PI_2-BPSK_Outer_Full_Low_CH



N30(10M)_DFT-s-OFDM_PI_2-BPSK_Edge_1RB_Left_Low_CH



N30(10M)_DFT-s-OFDM_QPSK_Outer_Full_Low_CH



N30(10M)_DFT-s-OFDM_QPSK_Edge_1RB_Left_Low_CH



Occupied Bandwidth

NR Band	SCS (kHz)	Bandwidth (MHz)	Arfcn	Freq (MHz)	Modulation	RB	OBW (MHz)	26dB OBW (MHz)
30	15	5	462000	2310.0	DFT-s-OFDM PI/2 BPSK	25@0	4.4815	5.058
30	15	5	462000	2310.0	DFT-s-OFDM QPSK	25@0	4.4701	5.005
30	15	5	462000	2310.0	CP-OFDM QPSK	25@0	4.4723	5.043
30	15	5	462000	2310.0	CP-OFDM 16 QAM	25@0	4.4874	5.159
30	15	5	462000	2310.0	CP-OFDM 64 QAM	25@0	4.4677	5.102
30	15	5	462000	2310.0	CP-OFDM 256 QAM	25@0	4.4779	5.065
30	15	10	462000	2310.0	DFT-s-OFDM PI/2 BPSK	50@0	8.8869	9.508
30	15	10	462000	2310.0	DFT-s-OFDM QPSK	50@0	8.9077	9.655
30	15	10	462000	2310.0	CP-OFDM QPSK	52@0	9.276	10.12
30	15	10	462000	2310.0	CP-OFDM 16 QAM	52@0	9.2839	10.01
30	15	10	462000	2310.0	CP-OFDM 64 QAM	52@0	9.2676	9.967
30	15	10	462000	2310.0	CP-OFDM 256 QAM	52@0	9.2756	10.07

N30(5M)_DFT-s-OFDM_PI_2- BPSK_Outer_Full_Mid_CH

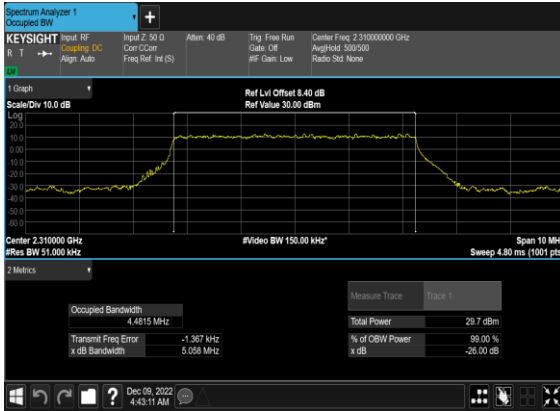

N30(5M)_DFT-s- OFDM_QPSK_Outer_Full_Mid_CH



N30(5M)_CP- OFDM_QPSK_Outer_Full_Mid_CH



N30(5M)_CP-OFDM_16 QAM_Outer_Full_Mid_CH



N30(5M)_CP-OFDM_64 QAM_Outer_Full_Mid_CH

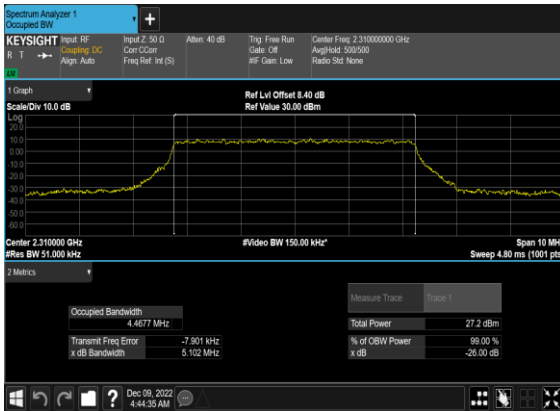

N30(5M)_CP-OFDM_256 QAM_Outer_Full_Mid_CH

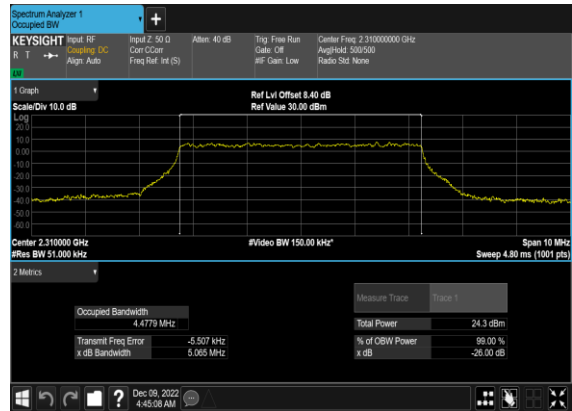

N30(10M)_DFT-s-OFDM_PI_2-BPSK_Outer_Full_Low_CH



N30(10M)_DFT-s-OFDM_QPSK_Outer_Full_Low_CH



N30(10M)_CP-OFDM_QPSK_Outer_Full_Low_CH



N30(10M)_CP-OFDM_16QAM_Outer_Full_Low_CH



N30(10M)_CP-OFDM_64QAM_Outer_Full_Low_CH

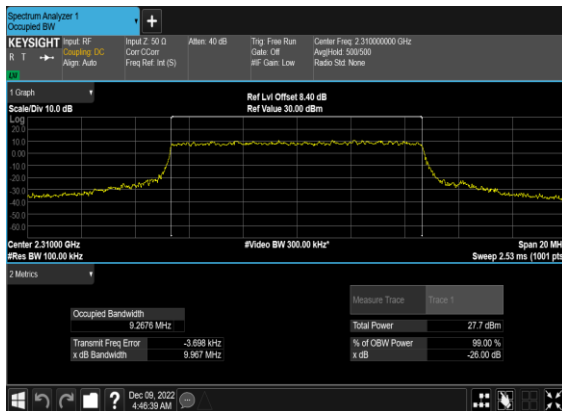

N30(10M)_CP-OFDM_256QAM_Outer_Full_Low_CH

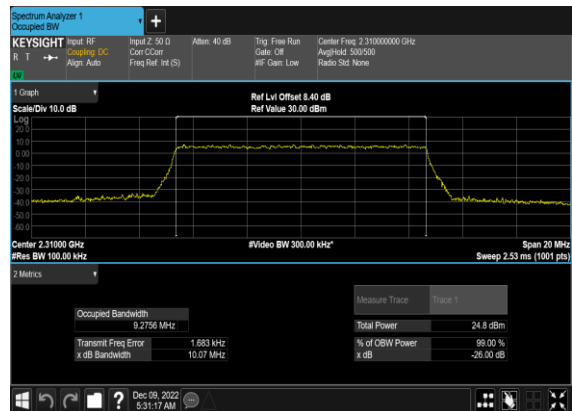

Conducted Spurious Emissions

NR Band	SCS (kHz)	Bandwidth (MHz)	Arfcn	Freq (MHz)	Modulation	RB	Result	Verdict
30	15	5	461500	2307.5	DFT-s-OFDM BPSK	1@0	see graph	---
30	15	5	461500	2307.5	DFT-s-OFDM BPSK	1@0	see graph	PASS
30	15	5	461500	2307.5	DFT-s-OFDM BPSK	1@0	see graph	PASS
30	15	5	461500	2307.5	DFT-s-OFDM QPSK	1@0	see graph	---
30	15	5	461500	2307.5	DFT-s-OFDM QPSK	1@0	see graph	PASS
30	15	5	461500	2307.5	DFT-s-OFDM QPSK	1@0	see graph	PASS
30	15	5	462000	2310.0	DFT-s-OFDM BPSK	1@0	see graph	---
30	15	5	462000	2310.0	DFT-s-OFDM BPSK	1@0	see graph	PASS
30	15	5	462000	2310.0	DFT-s-OFDM BPSK	1@0	see graph	PASS
30	15	5	462000	2310.0	DFT-s-OFDM QPSK	1@0	see graph	---
30	15	5	462000	2310.0	DFT-s-OFDM QPSK	1@0	see graph	PASS
30	15	5	462000	2310.0	DFT-s-OFDM QPSK	1@0	see graph	PASS
30	15	5	462500	2312.5	DFT-s-OFDM BPSK	1@0	see graph	---
30	15	5	462500	2312.5	DFT-s-OFDM BPSK	1@0	see graph	PASS
30	15	5	462500	2312.5	DFT-s-OFDM BPSK	1@0	see graph	PASS
30	15	5	462500	2312.5	DFT-s-OFDM QPSK	1@0	see graph	---
30	15	5	462500	2312.5	DFT-s-OFDM QPSK	1@0	see graph	PASS
30	15	5	462500	2312.5	DFT-s-OFDM QPSK	1@0	see graph	PASS
30	15	10	462000	2310.0	DFT-s-OFDM BPSK	1@0	see graph	---
30	15	10	462000	2310.0	DFT-s-OFDM BPSK	1@0	see graph	PASS
30	15	10	462000	2310.0	DFT-s-OFDM BPSK	1@0	see graph	PASS
30	15	10	462000	2310.0	DFT-s-OFDM QPSK	1@0	see graph	---

30	15	10	462000	2310.0	DFT-s-OFDM QPSK	1@0	see graph	PASS
30	15	10	462000	2310.0	DFT-s-OFDM QPSK	1@0	see graph	PASS
30	15	10	462000	2310.0	DFT-s-OFDM BPSK	1@0	see graph	---
30	15	10	462000	2310.0	DFT-s-OFDM BPSK	1@0	see graph	PASS
30	15	10	462000	2310.0	DFT-s-OFDM BPSK	1@0	see graph	PASS
30	15	10	462000	2310.0	DFT-s-OFDM QPSK	1@0	see graph	---
30	15	10	462000	2310.0	DFT-s-OFDM QPSK	1@0	see graph	PASS
30	15	10	462000	2310.0	DFT-s-OFDM QPSK	1@0	see graph	PASS
30	15	10	462000	2310.0	DFT-s-OFDM BPSK	1@0	see graph	---
30	15	10	462000	2310.0	DFT-s-OFDM BPSK	1@0	see graph	PASS
30	15	10	462000	2310.0	DFT-s-OFDM BPSK	1@0	see graph	PASS
30	15	10	462000	2310.0	DFT-s-OFDM QPSK	1@0	see graph	---
30	15	10	462000	2310.0	DFT-s-OFDM QPSK	1@0	see graph	PASS
30	15	10	462000	2310.0	DFT-s-OFDM QPSK	1@0	see graph	PASS

N30(5M)_DFT-s-OFDM_BPSK_Edge_1RB_Left_Low_CH

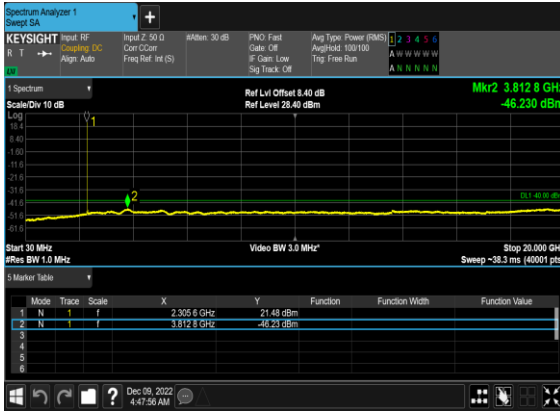

N30(5M)_DFT-s-OFDM_BPSK_Edge_1RB_Left_Low_CH



N30(5M)_DFT-s-OFDM_QPSK_Edge_1RB_Left_Low_CH



N30(5M)_DFT-s-OFDM_QPSK_Edge_1RB_Left_Low_CH



N30(5M)_DFT-s-OFDM_BPSK_Edge_1RB_Left_Mid_CH

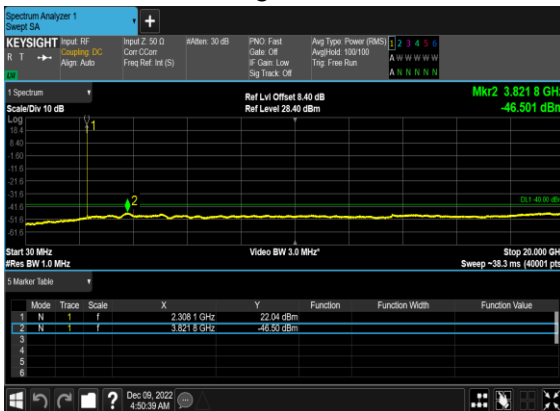

N30(5M)_DFT-s-OFDM_BPSK_Edge_1RB_Left_Mid_CH

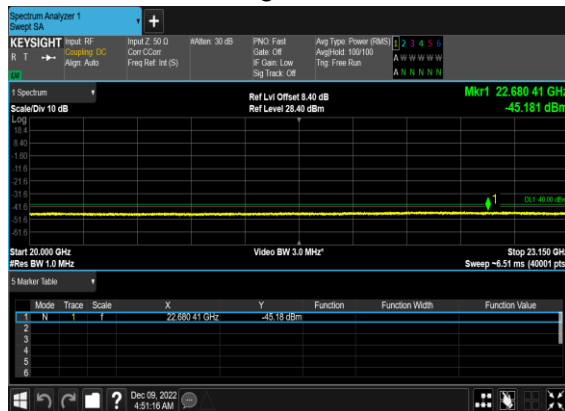

N30(5M)_DFT-s-OFDM_QPSK_Edge_1RB_Left_Mid_CH

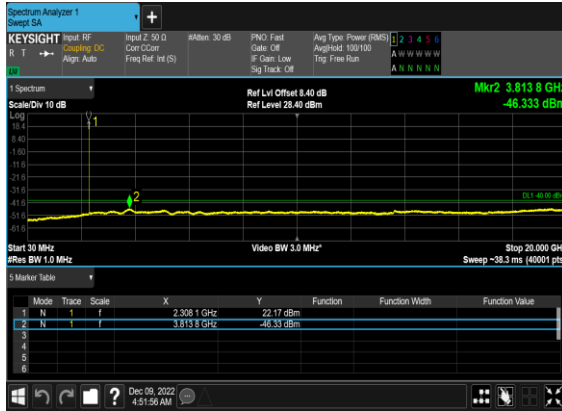

N30(5M)_DFT-s-OFDM_QPSK_Edge_1RB_Left_Mid_CH

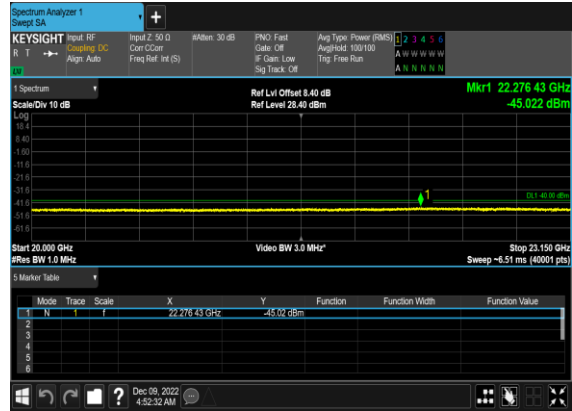

N30(5M)_DFT-s-OFDM_BPSK_Edge_1RB_Left_High_CH



N30(5M)_DFT-s-OFDM_BPSK_Edge_1RB_Left_High_CH



N30(5M)_DFT-s-OFDM_QPSK_Edge_1RB_Left_High_CH

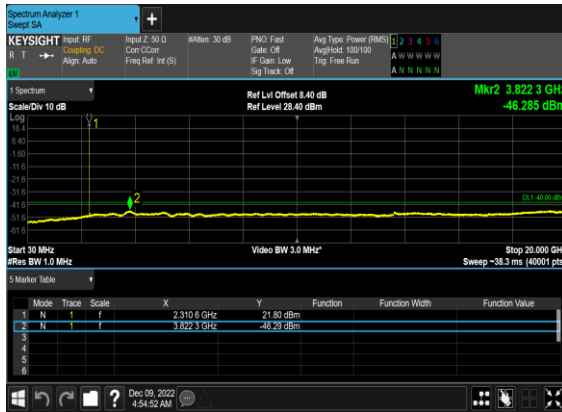

N30(5M)_DFT-s-OFDM_QPSK_Edge_1RB_Left_High_CH

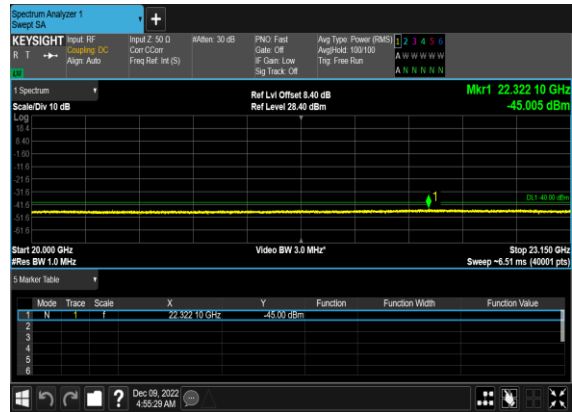

N30(10M)_DFT-s-OFDM_BPSK_Edge_1RB_Left_Low_CH

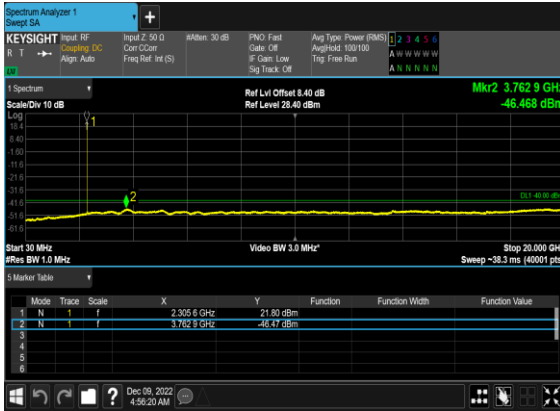

N30(10M)_DFT-s-OFDM_BPSK_Edge_1RB_Left_Low_CH



N30(10M)_DFT-s-OFDM_QPSK_Edge_1RB_Left_Low_CH

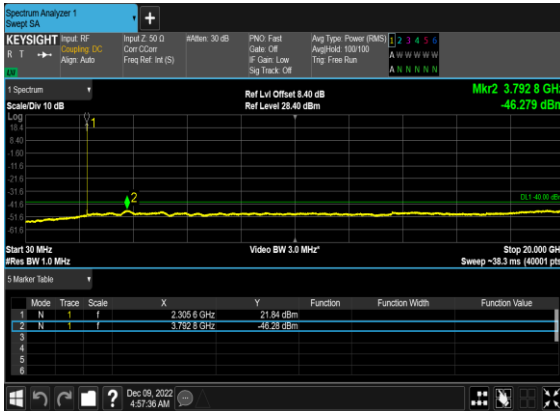

N30(10M)_DFT-s-OFDM_QPSK_Edge_1RB_Left_Low_CH



N30(10M)_DFT-s-OFDM_BPSK_Edge_1RB_Left_Low_CH

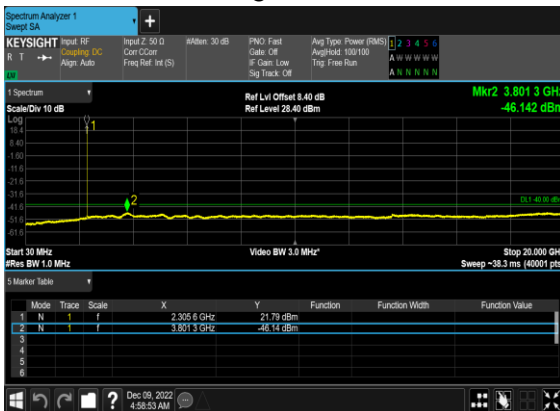

N30(10M)_DFT-s-OFDM_BPSK_Edge_1RB_Left_Low_CH



N30(10M)_DFT-s-OFDM_QPSK_Edge_1RB_Left_Low_CH



N30(10M)_DFT-s-OFDM_QPSK_Edge_1RB_Left_Low_CH

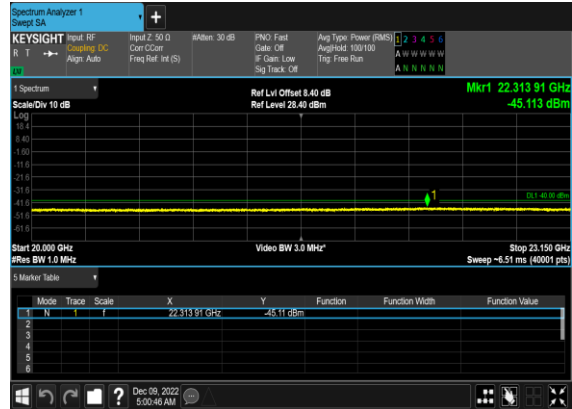

N30(10M)_DFT-s-OFDM_BPSK_Edge_1RB_Left_Low_CH



N30(10M)_DFT-s-OFDM_BPSK_Edge_1RB_Left_Low_CH

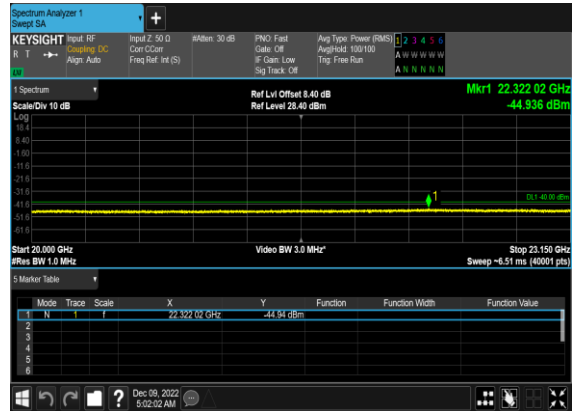

N30(10M)_DFT-s-OFDM_QPSK_Edge_1RB_Left_Low_CH

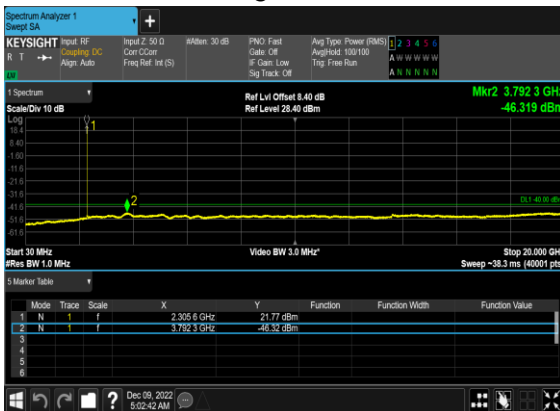

N30(10M)_DFT-s-OFDM_QPSK_Edge_1RB_Left_Low_CH

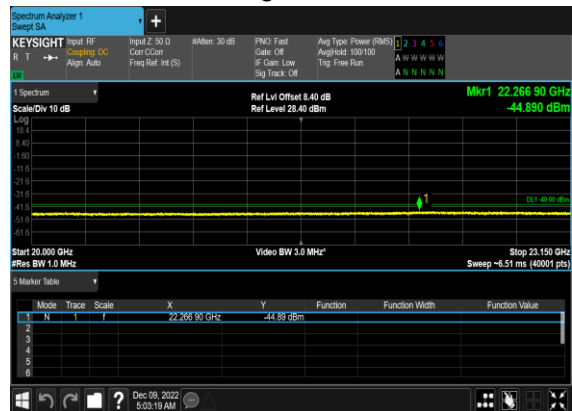

Conducted Band Edge

NR Band	SCS (kHz)	Bandwidth (MHz)	Arfcn	Freq (MHz)	Modulation	RB	Result	Verdict
30	15	5	461500	2307.5	DFT-s-OFDM BPSK	1@0	see graph	PASS
30	15	5	461500	2307.5	DFT-s-OFDM QPSK	1@0	see graph	PASS
30	15	5	461500	2307.5	DFT-s-OFDM BPSK	25@0	see graph	PASS
30	15	5	461500	2307.5	DFT-s-OFDM QPSK	25@0	see graph	PASS
30	15	5	462500	2312.5	DFT-s-OFDM BPSK	1@24	see graph	PASS
30	15	5	462500	2312.5	DFT-s-OFDM QPSK	1@24	see graph	PASS
30	15	5	462500	2312.5	DFT-s-OFDM BPSK	25@0	see graph	PASS
30	15	5	462500	2312.5	DFT-s-OFDM QPSK	25@0	see graph	PASS
30	15	10	462000	2310.0	DFT-s-OFDM BPSK	1@0	see graph	PASS
30	15	10	462000	2310.0	DFT-s-OFDM QPSK	1@0	see graph	PASS
30	15	10	462000	2310.0	DFT-s-OFDM BPSK	1@51	see graph	PASS
30	15	10	462000	2310.0	DFT-s-OFDM QPSK	1@51	see graph	PASS
30	15	10	462000	2310.0	DFT-s-OFDM BPSK	50@0	see graph	PASS
30	15	10	462000	2310.0	DFT-s-OFDM QPSK	50@0	see graph	PASS

N30(5M)_DFT-s-OFDM_BPSK_Edge_1RB_Left_Low_CH

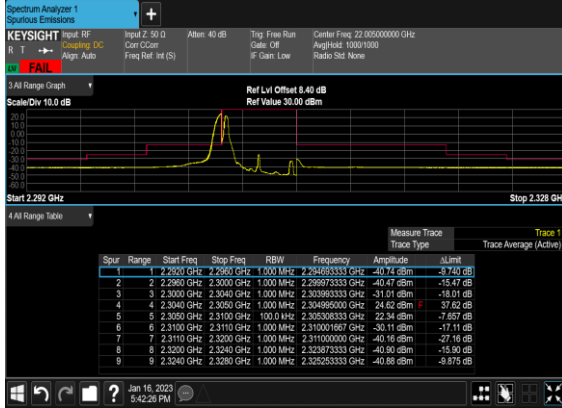

N30(5M)_DFT-s-OFDM_BPSK_Edge_1RB_Left_Low_CH_CHP_PASS



N30(5M)_DFT-s-OFDM_QPSK_Edge_1RB_Left_Low_CH

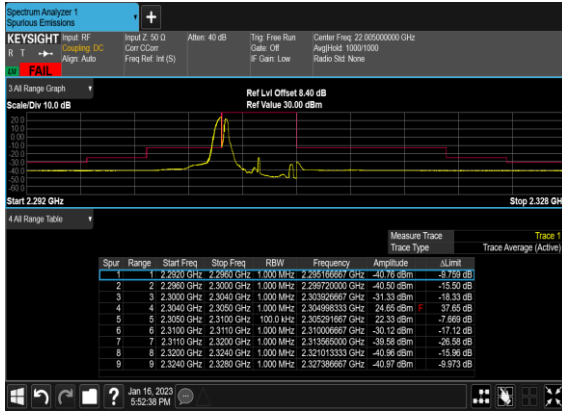

N30(5M)_DFT-s-OFDM_QPSK_Edge_1RB_Left_Low_CH_CHP_PASS



N30(5M)_DFT-s-OFDM_BPSK_Outer_Full_Low_CH

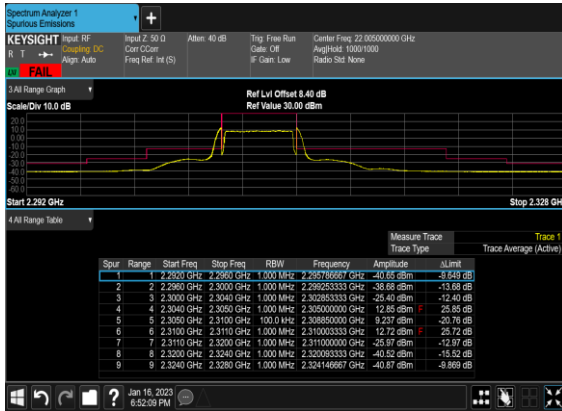

N30(5M)_DFT-s-OFDM_BPSK_Outer_Full_Low_CH_CHP_PASS

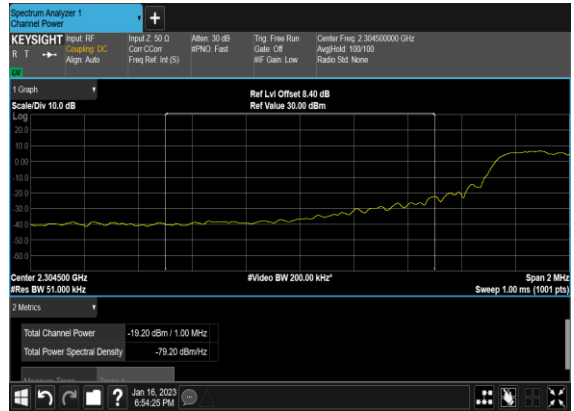

N30(5M)_DFT-s-OFDM_BPSK_Outer_Full_Low_CH_CHP_PASS

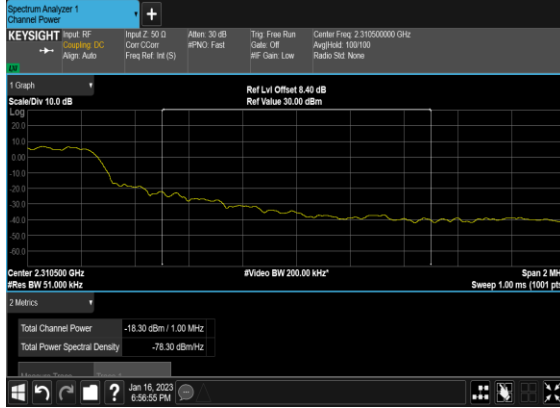

N30(5M)_DFT-s-OFDM_QPSK_Outer_Full_Low_CH

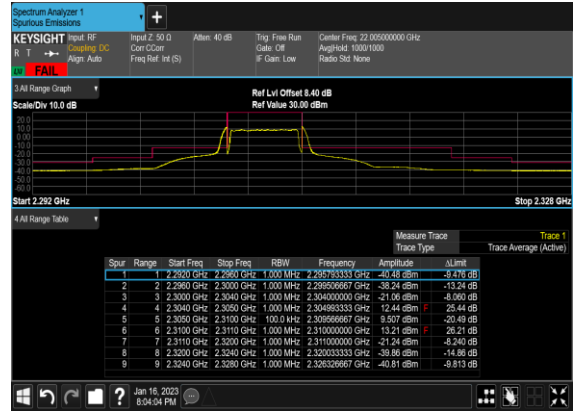

N30(5M)_DFT-s-OFDM_QPSK_Outer_Full_Low_CH_CHP_PASS

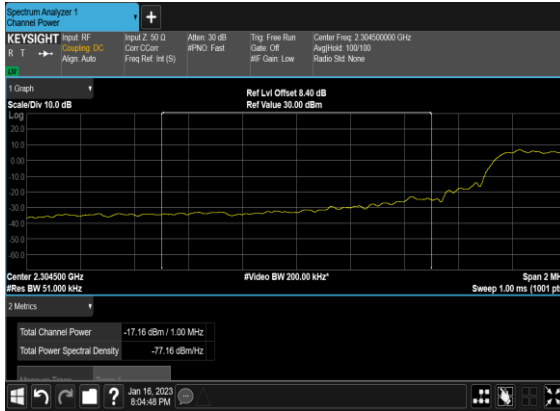

N30(5M)_DFT-s-OFDM_QPSK_Outer_Full_Low_CH_CHP_PASS

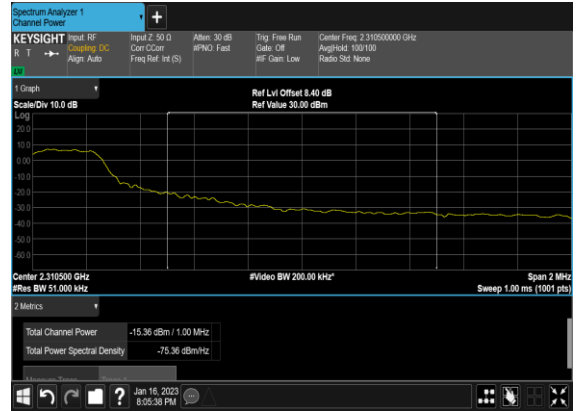

N30(5M)_DFT-s-OFDM_BPSK_Edge_1RB_Right_High_CH

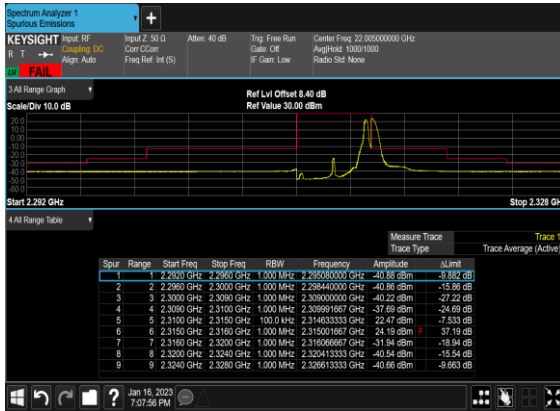

N30(5M)_DFT-s-OFDM_BPSK_Edge_1RB_Right_High_CH_CHP_PASS

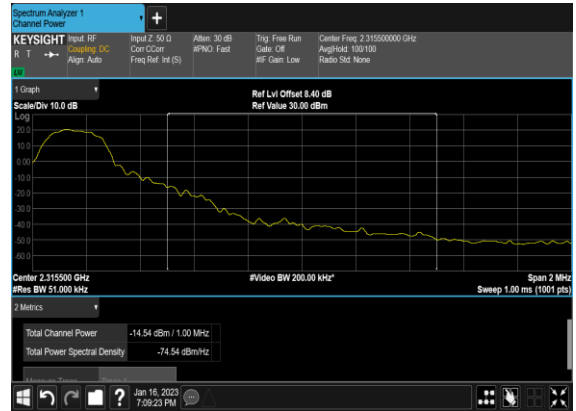

N30(5M)_DFT-s-OFDM_QPSK_Edge_1RB_Right_High_CH



N30(5M)_DFT-s-OFDM_QPSK_Edge_1RB_Right_High_CH_CHP_PASS

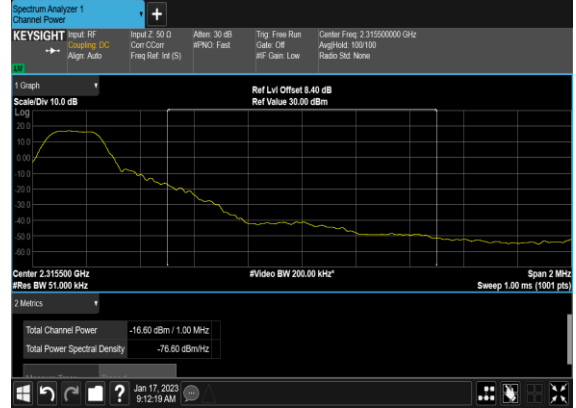

N30(5M)_DFT-s-OFDM_BPSK_Outer_Full_High_CH



N30(5M)_DFT-s-OFDM_BPSK_Outer_Full_High_CH_CHP_PASS

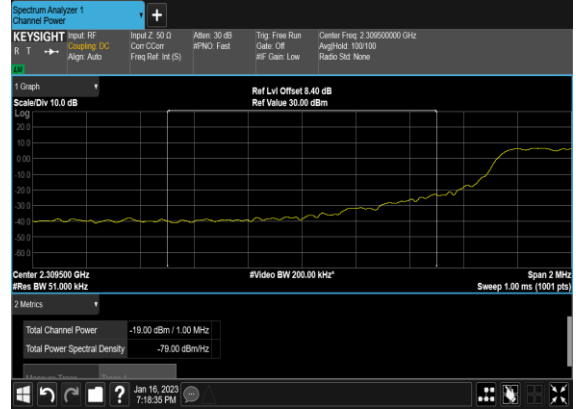

N30(5M)_DFT-s-OFDM_BPSK_Outer_Full_High_CH_CHP_PASS



N30(5M)_DFT-s-OFDM_QPSK_Outer_Full_High_CH

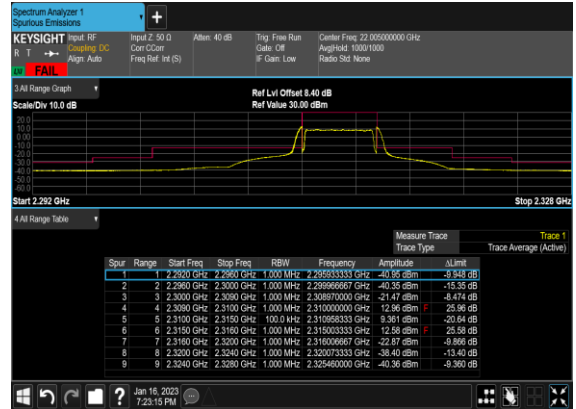

N30(5M)_DFT-s-
OFDM_QPSK_Outer_Full_High_CH_CHP_PASS



N30(5M)_DFT-s-
OFDM_QPSK_Outer_Full_High_CH_CHP_PASS



N30(10M)_DFT-s-
OFDM_BPSK_Edge_1RB_Left_Low_CH



N30(10M)_DFT-s-
OFDM_BPSK_Edge_1RB_Left_Low_CH_CHP_PASS



N30(10M)_DFT-s-
OFDM_QPSK_Edge_1RB_Left_Low_CH



N30(10M)_DFT-s-
OFDM_QPSK_Edge_1RB_Left_Low_CH_CHP_PASS

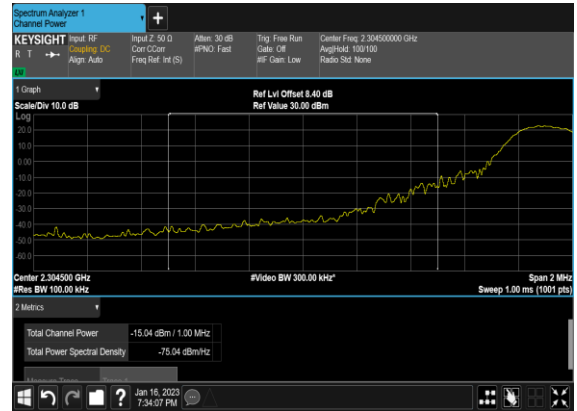

N30(10M)_DFT-s- OFDM_BPSK_Edge_1RB_Right_Low_CH

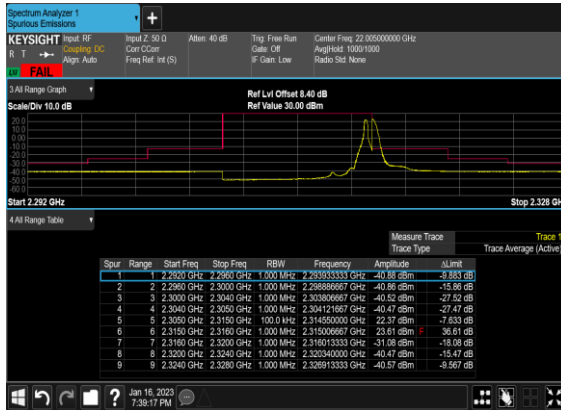

N30(10M)_DFT-s- OFDM_BPSK_Edge_1RB_Right_Low_CH_CHP_PASS

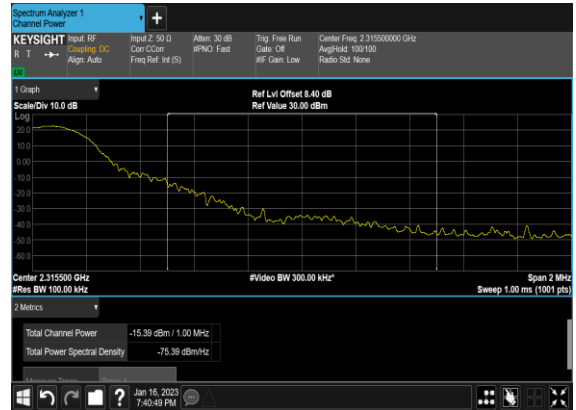

N30(10M)_DFT-s- OFDM_QPSK_Edge_1RB_Right_Low_CH

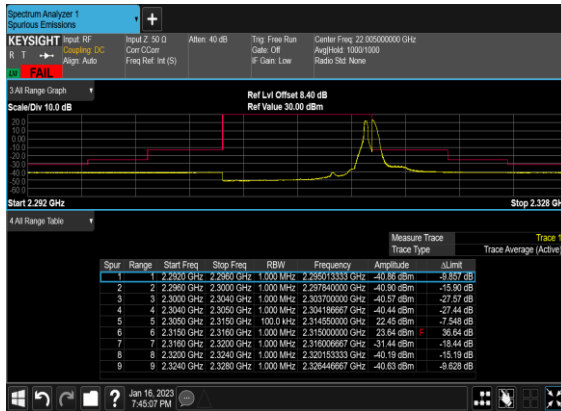

N30(10M)_DFT-s- OFDM_QPSK_Edge_1RB_Right_Low_CH_CHP_PASS

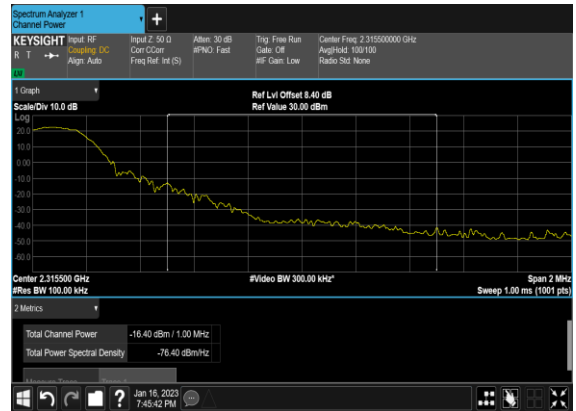

N30(10M)_DFT-s- OFDM_BPSK_Outer_Full_Low_CH

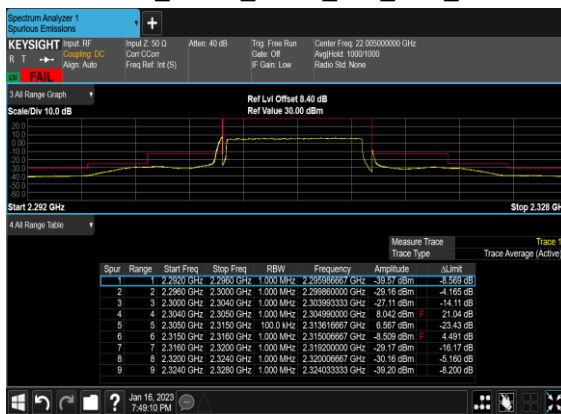

N30(10M)_DFT-s- OFDM_BPSK_Outer_Full_Low_CH_CHP_PASS

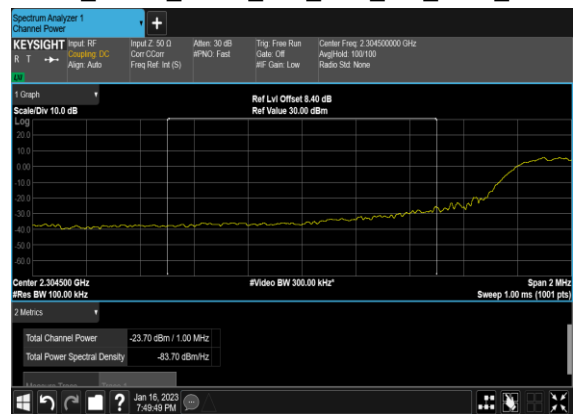

N30(10M)_DFT-s-OFDM_BPSK_Outer_Full_Low_CH_CHP_PASS

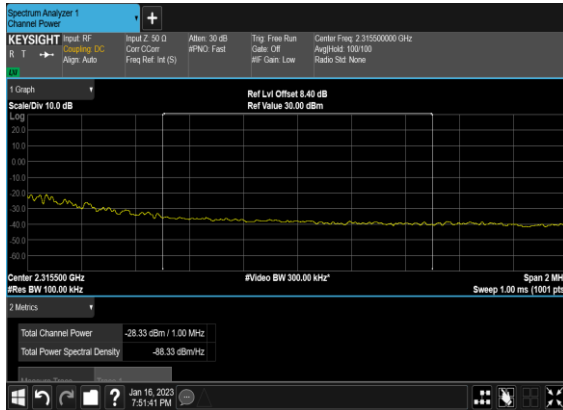

N30(10M)_DFT-s-OFDM_QPSK_Outer_Full_Low_CH

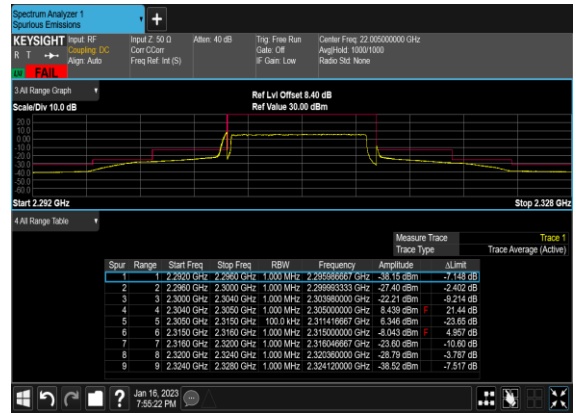

N30(10M)_DFT-s-OFDM_QPSK_Outer_Full_Low_CH_CHP_PASS



N30(10M)_DFT-s-OFDM_QPSK_Outer_Full_Low_CH_CHP_PASS

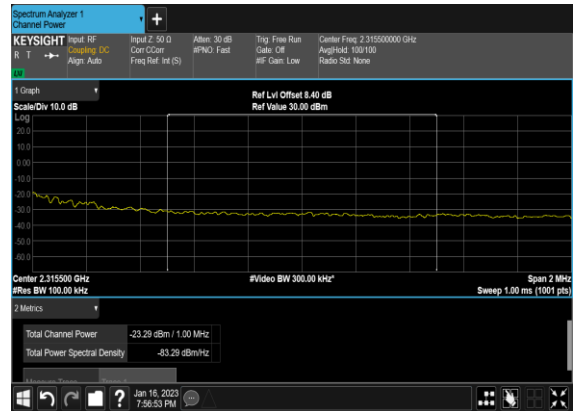

Appendix B. Test Results of Radiated Test

Radiated Spurious Emission

Test Engineer :	Huacong Liang	Temperature :	22~25°C
		Relative Humidity :	48~52%

Note: Pre-scanned harmonic for the different antenna combinations, we choose the worst antenna mode to perform final test.

SA 5G NR n30 / 5MHz / QPSK / ANT7(NR)									
Channel	Frequency (MHz)	EIRP (dBm)	Limit (dBm)	Over Limit (dB)	SPA Reading (dBm)	S.G. Power (dBm)	TX Cable loss (dB)	TX Antenna Gain (dBi)	Polarization (H/V)
Lowest	4610.79	-58.52	-40	-18.52	-55.46	-64.77	6.30	12.55	H
	6916.19	-54.03	-40	-14.03	-53.95	-57.43	8.25	11.65	H
	9221.58	-55.47	-40	-15.47	-64.26	-57.82	9.50	11.85	H
	4610.79	-59.67	-40	-19.67	-56.46	-65.92	6.30	12.55	V
	6916.19	-57.53	-40	-17.53	-57.42	-60.93	8.25	11.65	V
	9221.58	-55.95	-40	-15.95	-64.32	-58.30	9.50	11.85	V
Middle	4615.79	-60.49	-40	-20.49	-57.46	-66.74	6.45	12.70	H
	6923.69	-58.24	-40	-18.24	-58.20	-61.64	8.40	11.80	H
	9231.58	-55.48	-40	-15.48	-64.29	-57.83	9.65	12.00	H
	4615.79	-61.32	-40	-21.32	-58.15	-67.57	6.45	12.70	V
	6923.69	-59.80	-40	-19.80	-59.75	-63.20	8.40	11.80	V
	9231.58	-55.83	-40	-15.83	-64.22	-58.18	9.65	12.00	V
Highest	4620.79	-63.03	-40	-23.03	-60.00	-69.28	6.61	12.86	H
	6931.19	-55.70	-40	-15.70	-55.67	-59.08	8.56	11.94	H
	9241.58	-55.68	-40	-15.68	-64.47	-58.03	9.81	12.16	H
	4620.79	-62.35	-40	-22.35	-59.19	-68.60	6.61	12.86	V
	6931.19	-58.65	-40	-18.65	-58.63	-62.03	8.56	11.94	V
	9241.58	-56.16	-40	-16.16	-64.55	-58.51	9.81	12.16	V

Remark: Spurious emissions within 30-1000MHz were found more than 20dB below limit line.



EN-DC_14A_n30A / LTE 10MHz + NR 5MHz / QPSK / ANT1(LTE) & ANT7(NR)									
Channel	Frequency (MHz)	EIRP (dBm)	Limit (dBm)	Over Limit (dB)	SPA Reading (dBm)	S.G. Power (dBm)	TX Cable loss (dB)	TX Antenna Gain (dBi)	Polarization (H/V)
LTE Band14 Lowest	1577	-66.28	-42.15	-24.13	-72.71	-69.53	4.00	9.40	H
	2365.5	-62.90	-13	-49.90	-73.47	-66.47	4.88	10.60	H
	3154	-66.50	-13	-53.50	-58.75	-71.43	5.52	12.60	H
	1577	-66.57	-42.15	-24.42	-73.22	-69.82	4.00	9.40	V
	2365.5	-63.21	-13	-50.21	-74.18	-66.78	4.88	10.60	V
	3154	-65.66	-13	-52.66	-58.46	-70.59	5.52	12.60	V
NR n30 Lowest	4610.80	-63.73	-40	-23.73	-60.67	-69.98	6.30	12.55	H
	6916.20	-52.38	-40	-12.38	-52.30	-55.78	8.25	11.65	H
	9221.60	-55.26	-40	-15.26	-64.05	-57.61	9.50	11.85	H
	4610.80	-63.81	-40	-23.81	-60.6	-70.06	6.30	12.55	V
	6916.20	-50.86	-40	-10.86	-50.75	-54.26	8.25	11.65	V
	9221.60	-55.72	-40	-15.72	-64.09	-58.07	9.50	11.85	V
LTE Band14 Middle	1577	-66.95	-42.15	-24.80	-73.38	-70.20	4.00	9.40	H
	2365.5	-63.86	-13	-50.86	-74.43	-67.43	4.88	10.60	H
	3154	-66.43	-13	-53.43	-58.68	-71.36	5.52	12.60	H
	1577	-66.45	-42.15	-24.30	-73.10	-69.70	4.00	9.40	V
	2365.5	-63.10	-13	-50.10	-74.07	-66.67	4.88	10.60	V
	3154	-65.72	-13	-52.72	-58.52	-70.65	5.52	12.60	V
NR n30 Middle	4615.80	-64.02	-40	-24.02	-60.99	-70.27	6.45	12.70	H
	6923.70	-50.44	-40	-10.44	-50.40	-53.84	8.40	11.80	H
	9231.60	-55.52	-40	-15.52	-64.33	-57.87	9.65	12.00	H
	4615.80	-64.02	-40	-24.02	-60.85	-70.27	6.45	12.70	V
	6923.70	-54.92	-40	-14.92	-54.87	-58.32	8.40	11.80	V
	9231.60	-55.89	-40	-15.89	-64.28	-58.24	9.65	12.00	V
LTE Band14 Highest	1577	-66.27	-42.15	-24.12	-72.70	-69.52	4.00	9.40	H
	2365.5	-62.81	-13	-49.81	-73.38	-66.38	4.88	10.60	H
	3154	-65.96	-13	-52.96	-58.21	-70.89	5.52	12.60	H
	1577	-66.29	-42.15	-24.14	-72.94	-69.54	4.00	9.40	V
	2365.5	-62.34	-13	-49.34	-73.31	-65.91	4.88	10.60	V
	3154	-65.50	-13	-52.50	-58.30	-70.43	5.52	12.60	V
NR n30 Highest	4620.80	-60.25	-40	-20.25	-57.22	-66.50	6.61	12.86	H
	6931.20	-56.29	-40	-16.29	-56.26	-59.67	8.56	11.94	H
	9241.60	-55.46	-40	-15.46	-64.25	-57.81	9.81	12.16	H
	4620.80	-61.74	-40	-21.74	-58.58	-67.99	6.61	12.86	V
	6931.20	-57.67	-40	-17.67	-57.65	-61.05	8.56	11.94	V
	9241.60	-56.00	-40	-16.00	-64.39	-58.35	9.81	12.16	V

Remark: Spurious emissions within 30-1000MHz were found more than 20dB below limit line.



SA 5G NR n30 / 10MHz / QPSK / ANT7(NR)									
Channel	Frequency (MHz)	EIRP (dBm)	Limit (dBm)	Over Limit (dB)	SPA Reading (dBm)	S.G. Power (dBm)	TX Cable loss (dB)	TX Antenna Gain (dBi)	Polarization (H/V)
Middle	4610.93	-61.82	-40	-21.82	-58.76	-68.07	6.45	12.70	H
	6916.40	-52.73	-40	-12.73	-52.66	-56.13	8.40	11.80	H
	9221.86	-55.73	-40	-15.73	-64.52	-58.08	9.65	12.00	H
	4610.93	-61.21	-40	-21.21	-58	-67.46	6.45	12.70	V
	6916.40	-60.82	-40	-20.82	-60.71	-64.22	8.40	11.80	V
	9221.86	-55.94	-40	-15.94	-64.31	-58.29	9.65	12.00	V

Remark: Spurious emissions within 30-1000MHz were found more than 20dB below limit line.

EN-DC_14A_n30A / LTE 10MHz + NR 10MHz / QPSK / ANT1(LTE) & ANT7(NR)									
Channel	Frequency (MHz)	EIRP (dBm)	Limit (dBm)	Over Limit (dB)	SPA Reading (dBm)	S.G. Power (dBm)	TX Cable loss (dB)	TX Antenna Gain (dBi)	Polarization (H/V)
LTE Band14 Middle	1577	-66.98	-42.15	-24.83	-73.41	-70.23	4.00	9.40	H
	2365.5	-63.68	-13	-50.68	-74.25	-67.25	4.88	10.60	H
	3154	-66.34	-13	-53.34	-58.59	-71.27	5.52	12.60	H
	1577	-67.02	-42.15	-24.87	-73.67	-70.27	4.00	9.40	V
	2365.5	-62.56	-13	-49.56	-73.53	-66.13	4.88	10.60	V
	3154	-65.88	-13	-52.88	-58.68	-70.81	5.52	12.60	V
NR n30 Middle	4610.94	-57.61	-40	-17.61	-54.55	-63.86	6.45	12.70	H
	6916.41	-45.09	-40	-5.09	-45.02	-48.49	8.40	11.80	H
	9221.88	-55.19	-40	-15.19	-63.98	-57.54	9.65	12.00	H
	4610.94	-59.55	-40	-19.55	-56.34	-65.80	6.45	12.70	V
	6916.41	-47.78	-40	-7.78	-47.67	-51.18	8.40	11.80	V
	9221.88	-55.09	-40	-15.09	-63.46	-57.44	9.65	12.00	V

Remark: Spurious emissions within 30-1000MHz were found more than 20dB below limit line.