



FCC 47 CFR PART 15 SUBPART C

TEST REPORT

For

SF600

Model: SF600

Trade Name: MOTOROLA

Issued to

**Motorola Mobility Inc.
8000W.Sunrise Blvd,Suite A. Plantation,FL 33322 U.S.A.**

Issued by

**Compliance Certification Services Inc.
No.11, Wu-Gong 6th Rd., Wugu Industrial Park,
New Taipei City 248, Taiwan (R.O.C.)
<http://www.ccsrf.com>
service@ccsrf.com**

Issued Date: November 24, 2011



Note: This report shall not be reproduced except in full, without the written approval of Compliance Certification Services Inc. This document may be altered or revised by Compliance Certification Services Inc. personnel only, and shall be noted in the revision section of the document.



Revision History

Rev.	Issue Date	Revisions	Effect Page	Revised By
00	November 24, 2011	Initial Issue	ALL	Sandy Lin



TABLE OF CONTENTS

1. TEST RESULT CERTIFICATION.....	4
2. EUT DESCRIPTION	5
3. TEST METHODOLOGY	6
3.1 EUT CONFIGURATION	6
3.2 EUT EXERCISE.....	6
3.3 GENERAL TEST PROCEDURES.....	6
3.4 FCC PART 15.205 RESTRICTED BANDS OF OPERATIONS.....	7
3.5 DESCRIPTION OF TEST MODES	8
4. INSTRUMENT CALIBRATION.....	9
4.1 MEASURING INSTRUMENT CALIBRATION	9
4.2 MEASUREMENT EQUIPMENT USED	9
4.3 MEASUREMENT UNCERTAINTY	10
5. FACILITIES AND ACCREDITATIONS	11
5.1 FACILITIES	11
5.2 EQUIPMENT.....	11
5.3 TABLE OF ACCREDITATIONS AND LISTINGS.....	12
6. SETUP OF EQUIPMENT UNDER TEST	13
6.1 SETUP CONFIGURATION OF EUT.....	13
6.2 SUPPORT EQUIPMENT	13
7. FCC PART 15.247 REQUIREMENTS.....	14
7.1 20 DB BANDWIDTH.....	14
7.2 PEAK POWER.....	21
7.3 BAND EDGES MEASUREMENT	23
7.4 FREQUENCY SEPARATION.....	37
7.5 NUMBER OF HOPPING FREQUENCY.....	43
7.6 TIME OF OCCUPANCY (DWELL TIME)	47
7.7 SPURIOUS EMISSIONS	56
7.8 POWERLINE CONDUCTED EMISSIONS.....	67
APPENDIX I RADIO FREQUENCY EXPOSURE.....	70
APPENDIX II PHOTOGRAPHS OF TEST SETUP	71
APPENDIX 1 - PHOTOGRAPHS OF EUT	



1. TEST RESULT CERTIFICATION

Applicant: Motorola Mobility Inc.
8000W.Sunrise Blvd,Suite A. Plantation,FL 33322 U.S.A.

Equipment Under Test: SF600

Trade Name: MOTOROLA

Model: SF600

Date of Test: October 21 ~ November 22, 2011

APPLICABLE STANDARDS	
STANDARD	TEST RESULT
FCC 47 CFR Part 15 Subpart C	No non-compliance noted

We hereby certify that:

The above equipment was tested by Compliance Certification Services Inc. The test data, data evaluation, test procedures, and equipment configurations shown in this report were made in accordance with the procedures given in **ANSI C63.4: 2003** and the energy emitted by the sample EUT tested as described in this report is in compliance with the requirements of FCC Rules Part 15.207, 15.209, 15.247.

The test results of this report relate only to the tested sample EUT identified in this report.

Approved by:

Reviewed by:

Jason Lin
Section Manager
Compliance Certification Services Inc.

Gina Lo
Section Manager
Compliance Certification Services Inc.



2. EUT DESCRIPTION

Product	SF600
Trade Name	MOTOROLA
Model Number	SF600
Model Discrepancy	N/A
Received Date	November 10, 2011
Power Supply	1. Powered from Power Adapter MOTOROLA / DC4050US0301 I/P: 100-240V, 50/60Hz, 0.2A O/P: 5.1V, 850mA 2. Powered via USB Cable 3. Powered from Battery
Frequency Range	2402 ~ 2480 MHz
Transmit Power	5.15 dBm
Modulation Technique	GFSK for 1Mbps; $\pi/4$ -DQPSK for 2Mbps; 8DPSK for 3Mbps
Transmit Data Rate	1, 2, 3Mbps
Number of Channels	79 Channels
Antenna Specification	Gain: -6.65 dBi
Antenna Designation	Chip Antenna

Remark:

1. The sample selected for test was production product and was provided by manufacturer.
2. This submittal(s) (test report) is intended for FCC ID: **IHDP6MD1** filing to comply with Section 15.107, 15.109, 15.207, 15.209, 15.249 (FCC Part 15, Subpart C Rules.)



3. TEST METHODOLOGY

The tests documented in this report were performed in accordance with ANSI C63.4 and FCC CFR 47 Part 15.207, 15.209 and 15.247.

3.1 EUT CONFIGURATION

The EUT configuration for testing is installed on RF field strength measurement to meet the Commissions requirement and operating in a manner that intends to maximize its emission characteristics in a continuous normal application.

3.2 EUT EXERCISE

The EUT was operated in the engineering mode to fix the TX frequency that was for the purpose of the measurements.

According to its specifications, the EUT must comply with the requirements of the Section 15.207, 15.209 and 15.247 under the FCC Rules Part 15 Subpart C.

3.3 GENERAL TEST PROCEDURES

Conducted Emissions

The EUT is placed on the turntable, which is 0.8 m above ground plane. According to the requirements in Section 13.1.4.1 of ANSI C63.4 Conducted emissions from the EUT measured in the frequency range between 0.15 MHz and 30MHz using CISPR Quasi-peak and average detector modes.

Radiated Emissions

The EUT is placed on a turn table, which is 0.8 m above ground plane. The turntable shall rotate 360 degrees to determine the position of maximum emission level. EUT is set 3m away from the receiving antenna, which varied from 1m to 4m to find out the highest emission. And also, each emission was to be maximized by changing the polarization of receiving antenna both horizontal and vertical. In order to find out the maximum emissions, exploratory radiated emission measurements were made according to the requirements in Section 13.1.4.1 of ANSI C63.4.



3.4 FCC PART 15.205 RESTRICTED BANDS OF OPERATIONS

(a) Except as shown in paragraph (d) of this section, only spurious emissions are permitted in any of the frequency bands listed below:

MHz	MHz	MHz	GHz
0.090 - 0.110	16.42 - 16.423	399.9 - 410	4.5 - 5.15
¹ 0.495 - 0.505	16.69475 - 16.69525	608 - 614	5.35 - 5.46
2.1735 - 2.1905	16.80425 - 16.80475	960 - 1240	7.25 - 7.75
4.125 - 4.128	25.5 - 25.67	1300 - 1427	8.025 - 8.5
4.17725 - 4.17775	37.5 - 38.25	1435 - 1626.5	9.0 - 9.2
4.20725 - 4.20775	73 - 74.6	1645.5 - 1646.5	9.3 - 9.5
6.215 - 6.218	74.8 - 75.2	1660 - 1710	10.6 - 12.7
6.26775 - 6.26825	108 - 121.94	1718.8 - 1722.2	13.25 - 13.4
6.31175 - 6.31225	123 - 138	2200 - 2300	14.47 - 14.5
8.291 - 8.294	149.9 - 150.05	2310 - 2390	15.35 - 16.2
8.362 - 8.366	156.52475 -	2483.5 - 2500	17.7 - 21.4
8.37625 - 8.38675	156.52525	2655 - 2900	22.01 - 23.12
8.41425 - 8.41475	156.7 - 156.9	3260 - 3267	23.6 - 24.0
12.29 - 12.293	162.0125 - 167.17	3332 - 3339	31.2 - 31.8
12.51975 - 12.52025	167.72 - 173.2	3345.8 - 3358	36.43 - 36.5
12.57675 - 12.57725	240 - 285	3600 - 4400	(²)
13.36 - 13.41	322 - 335.4		

¹ Until February 1, 1999, this restricted band shall be 0.490-0.510 MHz.

² Above 38.6

(b) Except as provided in paragraphs (d) and (e), the field strength of emissions appearing within these frequency bands shall not exceed the limits shown in Section 15.209. At frequencies equal to or less than 1000 MHz, compliance with the limits in Section 15.209 shall be demonstrated using measurement instrumentation employing a CISPR quasi-peak detector. Above 1000 MHz, compliance with the emission limits in Section 15.209 shall be demonstrated based on the average value of the measured emissions. The provisions in Section 15.35 apply to these measurements.



3.5 DESCRIPTION OF TEST MODES

The EUT (model: SF600) had been tested under operating condition.

Test program used to control the EUT for staying in continuous transmitting mode was programmed.

Software used to control the EUT for staying in continuous transmitting mode was programmed.

The worst case data rate is determined as the data rate with highest output power.

After verification, all tests were carried out with the worst case test modes as shown below except radiated spurious emission below 1GHz and power line conducted emissions below 30MHz, which worst case was in normal link mode only.

During the preliminary test, GFSK, $\pi/4$ -QPSK & 8DPSK with DH1 were pre-tested and found that 8DPSK emits the highest output power. Then the tests were carried on with DH1 compare to DH3 & DH5 and found that 8DPSK with DH5 emit the highest output power, and therefore had been tested under operating condition.

Following channels were selected for the radiated emission testing only as listed below:

Tested Channel	Modulation Type	Packet Type	Date Rate	Axis
Low, Mid, High	GFSK	DH 5	1	Z
Low, Mid, High	8DPSK	DH 5	3	Z

The field strength of spurious emission was measured in the following position: EUT stand-up position (Z mode), lie-down position (X, Y mode). The worst emission was found in stand-up position (Z mode) and the worst case was recorded.

The Bluetooth 4.0 function in left ear was disabled by software. There is no RF function in left ear. This report tested right ear and focused on Bluetooth 2.1 function.



4. INSTRUMENT CALIBRATION

4.1 MEASURING INSTRUMENT CALIBRATION

The measuring equipment, which was utilized in performing the tests documented herein, has been calibrated in accordance with the manufacturer's recommendations for utilizing calibration equipment, which is traceable to recognized national standards.

4.2 MEASUREMENT EQUIPMENT USED

Equipment Used for Emissions Measurement

Remark: Each piece of equipment is scheduled for calibration once a year and Loop Antenna is scheduled for calibration once three years.

Conducted Emissions Test Site				
Name of Equipment	Manufacturer	Model	Serial Number	Calibration Due
Spectrum Analyzer	Agilent	E4446A	MY43360131	03/17/2012
Power Meter	Anritsu	ML2495A	1012009	04/27/2012
Power Sensor	Anritsu	MA2411B	0917072	04/27/2012

Wugu 966 Chamber A				
Name of Equipment	Manufacturer	Model	Serial Number	Calibration Due
Spectrum Analyzer	Agilent	E4446A	US42510252	11/02/2012
EMI Test Receiver	R&S	ESCI	100064	02/17/2012
Pre-Amplifier	Mini-Circuits	ZFL-1000LN	SF350700823	01/13/2012
Pre-Amplifier	MITEQ	AFS44-00102650-42-10P-44	1415367	11/19/2012
Bilog Antenna	Sunol Sciences	JB3	A030105	10/03/2012
Horn Antenna	EMCO	3117	00055165	01/12/2012
Horn Antenna	EMCO	3116	00026370	10/12/2012
Loop Antenna	EMCO	6502	8905/2356	06/10/2013
Turn Table	CCS	CC-T-1F	N/A	N.C.R
Antenna Tower	CCS	CC-A-1F	N/A	N.C.R
Controller	CCS	CC-C-1F	N/A	N.C.R
Site NSA	CCS	N/A	N/A	12/26/2011
Test S/W	EZ-EMC (CCS-3A1RE)			

Conducted Emission room # A				
Name of Equipment	Manufacturer	Model	Serial Number	Calibration Due
EMI Test Receiver	R&S	ESHS10	843743/015	05/01/2012
LISN	SCHWARZBECK	NSLK 8127	8127-541	12/18/2011
LISN	SCHAFFNER	NNB 41	03/10013	N.C.R.
Test S/W	CCS-3A1-CE			



4.3 MEASUREMENT UNCERTAINTY

PARAMETER	UNCERTAINTY
Powerline Conducted Emission	+/- 1.2159
3M Semi Anechoic Chamber / 30M~200M	+/- 4.0138
3M Semi Anechoic Chamber / 200M~1000M	+/- 3.9483
3M Semi Anechoic Chamber / 1G~8G	+/- 2.5975
3M Semi Anechoic Chamber / 8G~18G	+/- 2.6112
3M Semi Anechoic Chamber / 18G~26G	+/- 2.7389
3M Semi Anechoic Chamber / 26G~40G	+/- 2.9683

Remark: This uncertainty represents an expanded uncertainty expressed at approximately the 95% confidence level using a coverage factor of $k=2$.



5. FACILITIES AND ACCREDITATIONS

5.1 FACILITIES

All measurement facilities used to collect the measurement data are located at

- No.199, Chungshen Road, Hsintien City, Taipei Hsien, Taiwan, R.O.C.
Tel: 886-2-2217-0894 / Fax: 886-2-2217-1029
- No.11, Wu-Gong 6th Rd., Wugu Industrial Park, New Taipei City 248, Taiwan (R.O.C.)
Tel: 886-2-2299-9720 / Fax: 886-2-2298-4045
- No.81-1, Lane 210, Bade 2nd Rd., Lujhu Township, Taoyuan County 33841, TAIWAN, R.O.C.
Tel: 886-3-324-0332 / Fax: 886-3-324-5235

The sites are constructed in conformance with the requirements of ANSI C63.7, ANSI C63.4 and CISPR Publication 22.

5.2 EQUIPMENT

Radiated emissions are measured with one or more of the following types of linearly polarized antennas: tuned dipole, biconical, log periodic, bi-log, and/or ridged waveguide, horn. Spectrum analyzers with pre-selectors and quasi-peak detectors are used to perform radiated measurements.



Conducted emissions are measured with Line Impedance Stabilization Networks and EMI Test Receivers.

Calibrated wideband preamplifiers, coaxial cables, and coaxial attenuators are also used for making measurements.

All receiving equipment conforms to CISPR Publication 16-1, "Radio Interference Measuring Apparatus and Measurement Methods."



5.3 TABLE OF ACCREDITATIONS AND LISTINGS

Country	Agency	Scope of Accreditation	Logo
USA	FCC	3M Semi Anechoic Chamber (FCC MRA: TW1039) to perform FCC Part 15 measurements	 FCC MRA: TW1039
Taiwan	TAF	LP0002, RTTE01, FCC Method-47 CFR Part 15 Subpart C, D, E, RSS-210, RSS-310 IDA TS SRD, AS/NZS 4268, AS/NZS 4771, TS 12.1 & 12.2, ETSI EN 300 440-1, ETSI EN 300 440-2, ETSI EN 300 328, ETSI EN 300 220-1, ETSI EN 300 220-2, ETSI EN 301 893, ETSI EN 301 489-1/3/7/17 FCC OET Bulletin 65 + Supplement C, EN 50360, EN 50361, EN 50371, RSS 102, EN 50383, EN 50385, EN 50392, IEC 62209, CNS 14958-1, CNS 14959 FCC Method -47 CFR Part 15 Subpart B IEC / EN 61000-3-2, IEC / EN 61000-3-3, IEC / EN 61000-4-2/3/4/5/6/8/11	
Canada	Industry Canada	3M Semi Anechoic Chamber (IC 2324G-1 / IC 2324G-2) to perform	 IC 2324G-1 IC 2324G-2

* No part of this report may be used to claim or imply product endorsement by A2LA or any agency of the US Government.



6. SETUP OF EQUIPMENT UNDER TEST

6.1 SETUP CONFIGURATION OF EUT

See test photographs attached in Appendix II for the actual connections between EUT and support equipment.

6.2 SUPPORT EQUIPMENT

No.	Device Type	Model	Series No.	FCC ID	Brand	Data Cable	Power Cord
1.	Notebook PC	HP	dv6-1332TX	CNF9491GM9	PD9112BNHU	N/A	AC I/P: Unshielded, 1.8m DC O/P: Unshielded, 1.8m with a core
2	Test Kit	N/A	N/A	N/A	N/A	N/A	N/A

Remark:

1. All the equipment/cables were placed in the worst-case configuration to maximize the emission during the test.
2. Grounding was established in accordance with the manufacturer's requirements and conditions for the intended use.



7. FCC PART 15.247 REQUIREMENTS

7.1 20 DB BANDWIDTH

LIMIT

None; for reporting purposes only.

Test Configuration

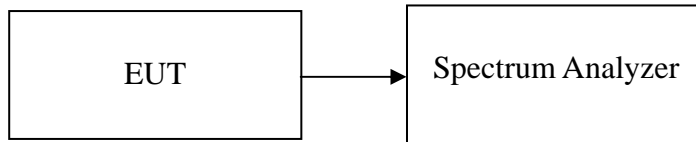

TEST PROCEDURE

1. Place the EUT on the table and set it in the transmitting mode.
2. Remove the antenna from the EUT and then connect a low loss RF cable from the antenna port to the spectrum analyzer.
3. Set the spectrum analyzer as for GFSK RBW=30 kHz, VBW = 100 kHz, Span = 3MHz, Sweep = auto. / for 8DPSK RBW=30 kHz, VBW = 100 kHz, Span = 3MHz, Sweep = auto.
4. Mark the peak frequency and 20dB (upper and lower) frequency.
5. Repeat until all the rest channels are investigated.

TEST RESULTS

No non-compliance noted.

Test Data

For GFSK / DH5

Channel	Frequency (MHz)	20dB Bandwidth (MHz)
Low	2402	0.93
Mid	2441	0.955
High	2480	0.935

For 8DPSK / DH5

Channel	Frequency (MHz)	20dB Bandwidth (MHz)
Low	2402	1.285
Mid	2441	1.26
High	2480	1.26



Test Plot

For GFSK / DH5

20dB Bandwidth (CH Low)

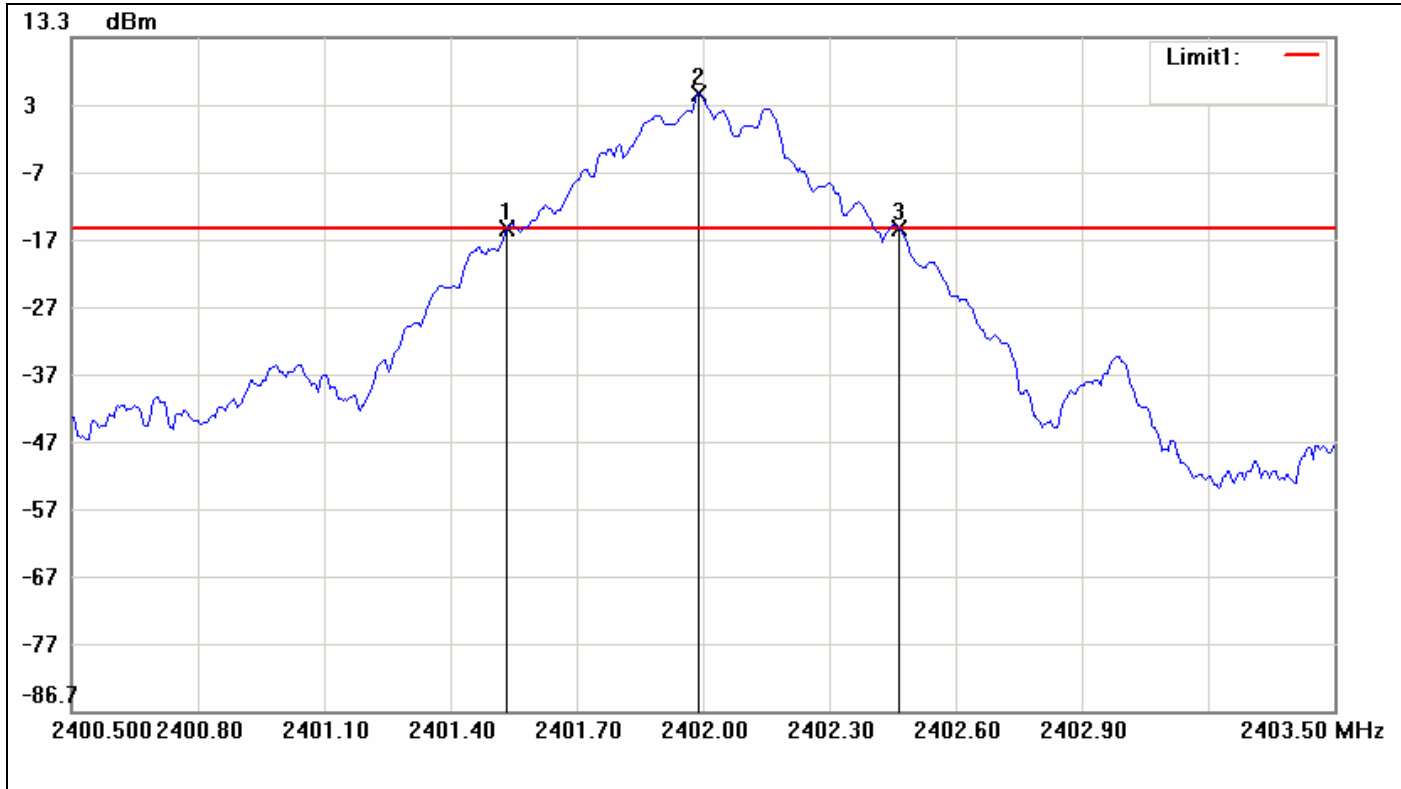

No.	Frequency(MHz)	Level(dBm)	Limit(dBm)	Margin(dBm)
1	2401.5350	-15.21	-15.00	-0.21
2	2401.9900	5.00	-15.00	20.00
3	2402.4650	-15.15	-15.00	-0.15

No.		Δ Frequency(MHz)	Δ Level(dB)
1	mk3-mk1	0.93	0.06



20dB Bandwidth (CH Mid)

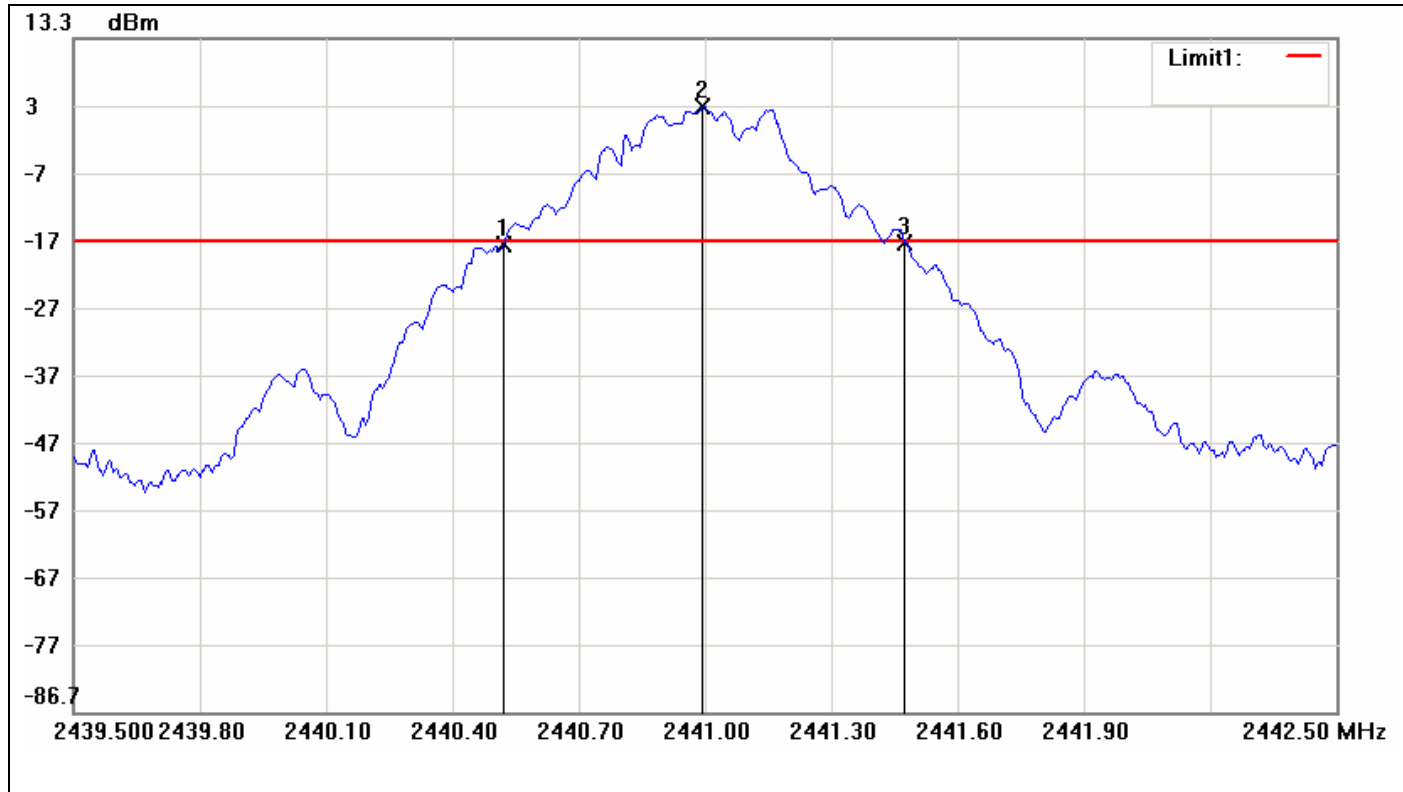

No.	Frequency(MHz)	Level(dBm)	Limit(dBm)	Margin(dBm)
1	2440.5200	-17.37	-16.87	-0.50
2	2440.9950	3.13	-16.87	20.00
3	2441.4750	-17.05	-16.87	-0.18

No.		Δ Frequency(MHz)	Δ Level(dB)
1	mk3-mk1	0.955	0.32



20dB Bandwidth (CH High)

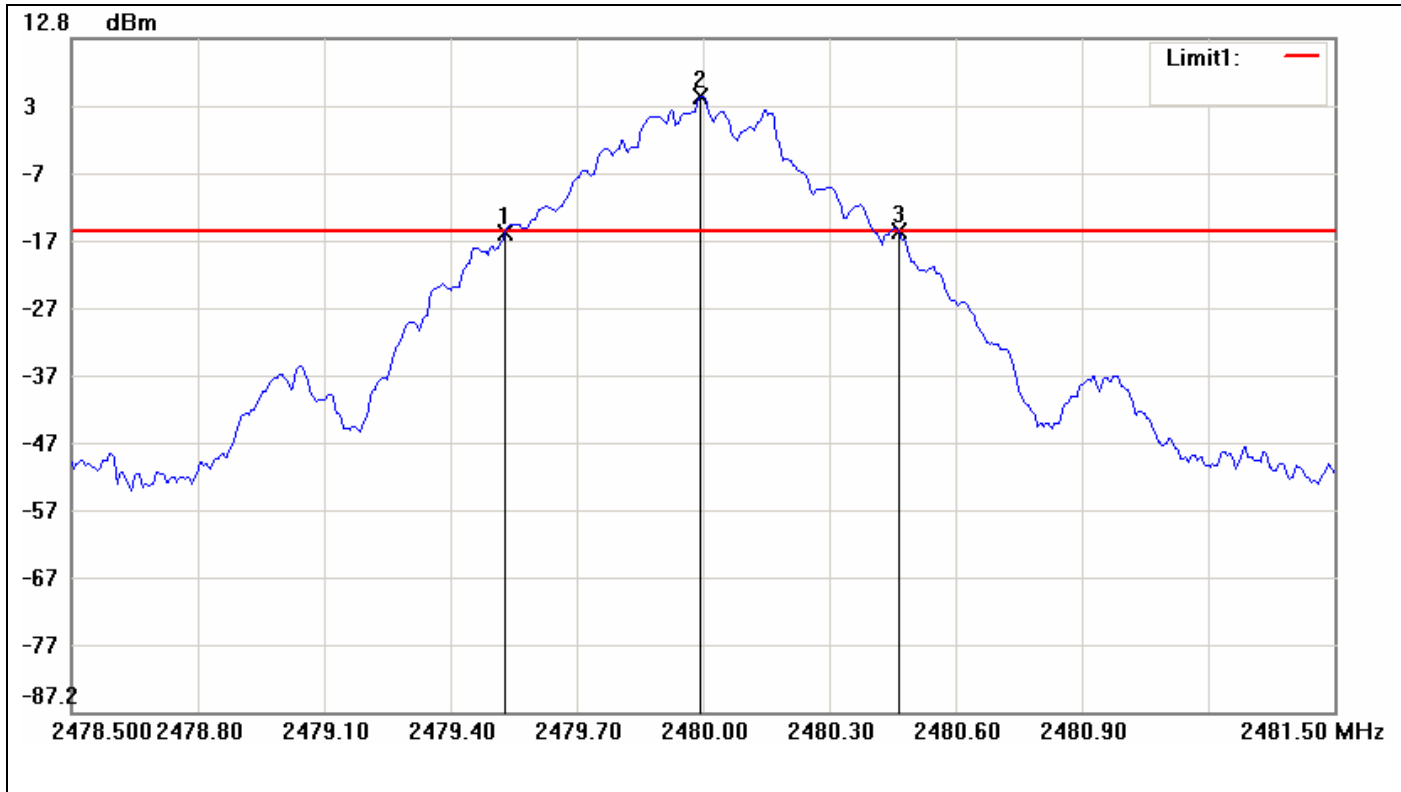

No.	Frequency(MHz)	Level(dBm)	Limit(dBm)	Margin(dBm)
1	2479.5300	-16.07	-15.85	-0.22
2	2479.9950	4.15	-15.85	20.00
3	2480.4650	-15.90	-15.85	-0.05

No.		Δ Frequency(MHz)	Δ Level(dB)
1	mk3-mk1	0.935	0.17



For 8DPSK / DH5

20dB Bandwidth (CH Low)

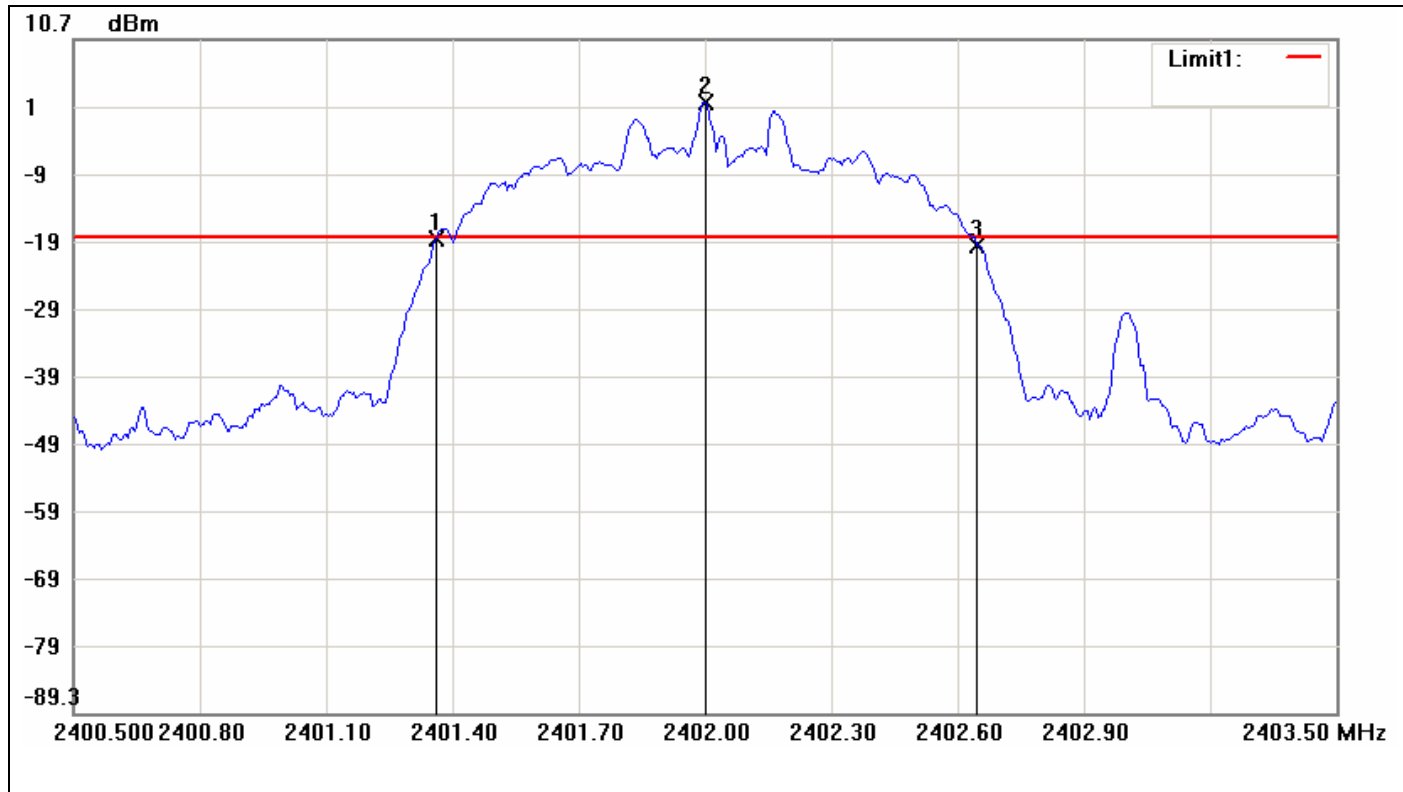

No.	Frequency(MHz)	Level(dBm)	Limit(dBm)	Margin(dBm)
1	2401.3600	-18.84	-18.75	-0.09
2	2402.0000	1.25	-18.75	20.00
3	2402.6450	-19.91	-18.75	-1.16

No.		Δ Frequency(MHz)	Δ Level(dB)
1	mk3-mk1	1.285	-1.07



20dB Bandwidth (CH Mid)

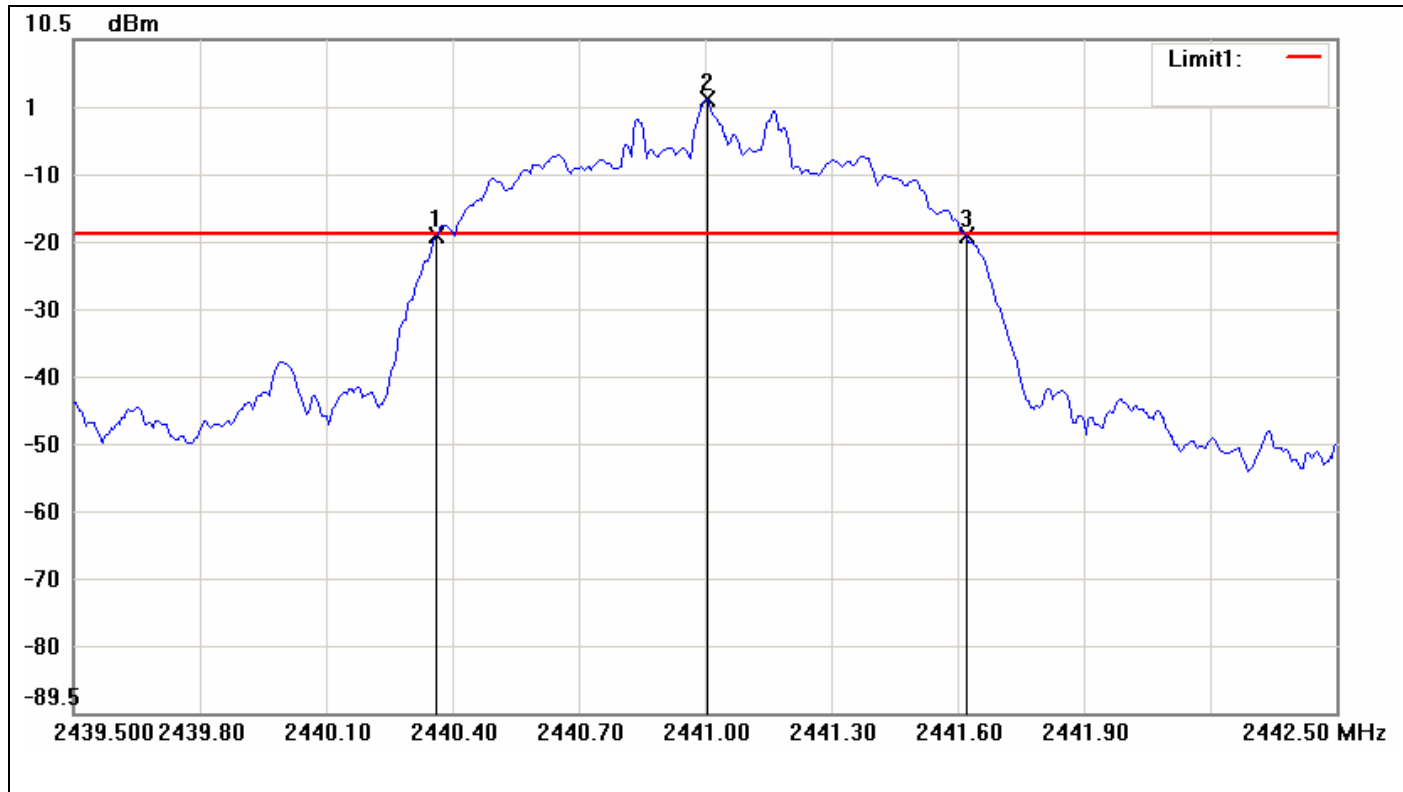

No.	Frequency(MHz)	Level(dBm)	Limit(dBm)	Margin(dBm)
1	2440.3600	-18.71	-18.47	-0.24
2	2441.0050	1.53	-18.47	20.00
3	2441.6200	-18.70	-18.47	-0.23

No.		Δ Frequency(MHz)	Δ Level(dB)
1	mk3-mk1	1.26	0.01



20dB Bandwidth (CH High)

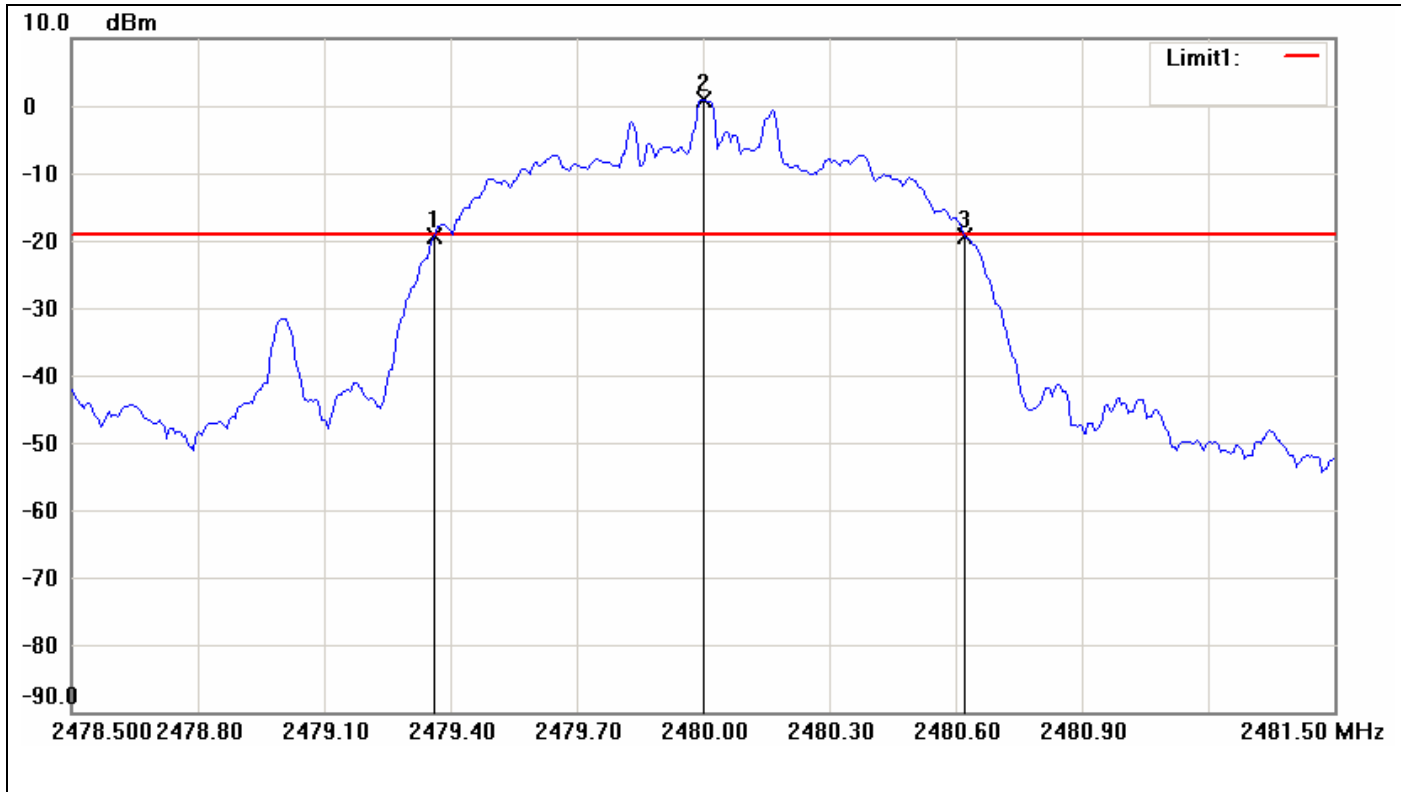

No.	Frequency(MHz)	Level(dBm)	Limit(dBm)	Margin(dBm)
1	2479.3600	-19.37	-19.11	-0.26
2	2480.0000	0.89	-19.11	20.00
3	2480.6200	-19.41	-19.11	-0.30

No.		Δ Frequency(MHz)	Δ Level(dB)
1	mk3-mk1	1.26	-0.04



7.2 PEAK POWER

LIMIT

The maximum peak output power of the intentional radiator shall not exceed the following:

1. According to §15.247(a)(1), Frequency hopping systems shall have hopping channel carrier frequencies separated by a minimum of 25 kHz or the 20 dB bandwidth of the hopping channel, whichever is greater. Alternatively, frequency hopping systems operating in the 2400-2483.5 MHz band may have hopping channel carrier frequencies that are separated by 25 kHz or two-thirds of the 20 dB bandwidth of the hopping channel, whichever is greater, provided the systems operate with an output power no greater than 125 mW.
2. According to §15.247(b)(3), for systems using digital modulation in the bands of 902-928 MHz, 2400-2483.5 MHz, and 5725-5850 MHz: 1 Watt.
3. According to §15.247(b)(4), the conducted output power limit specified in paragraph (b) of this section is based on the use of antennas with directional gains that do not exceed 6 dBi. Except as shown in paragraph (c) of this section, if transmitting antennas of directional gain greater than 6 dBi are used, the conducted output power from the intentional radiator shall be reduced below the stated values in paragraphs (b)(1), (b)(2), and (b)(3) of this section, as appropriate, by the amount in dB that the directional gain of the antenna exceeds 6 dBi.

Test Configuration

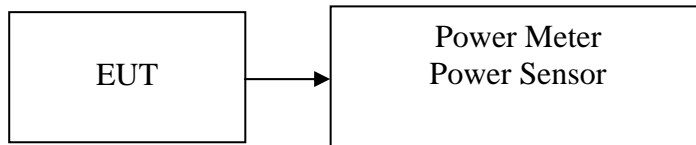

TEST PROCEDURE

The transmitter output is connected to the Power Meter. The Power Meter is set to the peak power detection.

TEST RESULTS

No non-compliance noted.



Test Data

For GFSK / DH5

Channel	Frequency (MHz)	Output Power (dBm)	Output Power (W)	Limit (W)	Result
Low	2402	5.15	0.00327	0.125	PASS
Mid	2441	4.88	0.00308		PASS
High	2480	4.73	0.00297		PASS

For 8DPSK / DH5

Channel	Frequency (MHz)	Output Power (dBm)	Output Power (W)	Limit (W)	Result
Low	2402	3.19	0.00208	0.125	PASS
Mid	2441	2.94	0.00197		PASS
High	2480	2.36	0.00172		PASS



7.3 BAND EDGES MEASUREMENT

LIMIT

According to §15.247(d), in any 100 kHz bandwidth outside the frequency band in which the spread spectrum or digitally modulated intentional radiator is operating, the radio frequency power that is produced by the intentional radiator shall be at least 20 dB below that in the 100 kHz bandwidth within the band that contains the highest level of the desired power, based on either an RF conducted or a radiated measurement, provided the transmitter demonstrates compliance with the peak conducted power limits. If the transmitter complies with the conducted power limits based on the use of RMS averaging over a time interval, as permitted under paragraph (b)(3) of this section, the attenuation required under this paragraph shall be 30 dB instead of 20 dB. Attenuation below the general limits specified in §15.209(a) is not required. In addition, radiated emissions which fall in the restricted bands, as defined in §15.205(a), must also comply with the radiated emission limits specified in §15.209(a) (see §15.205(c)).

For Radiated

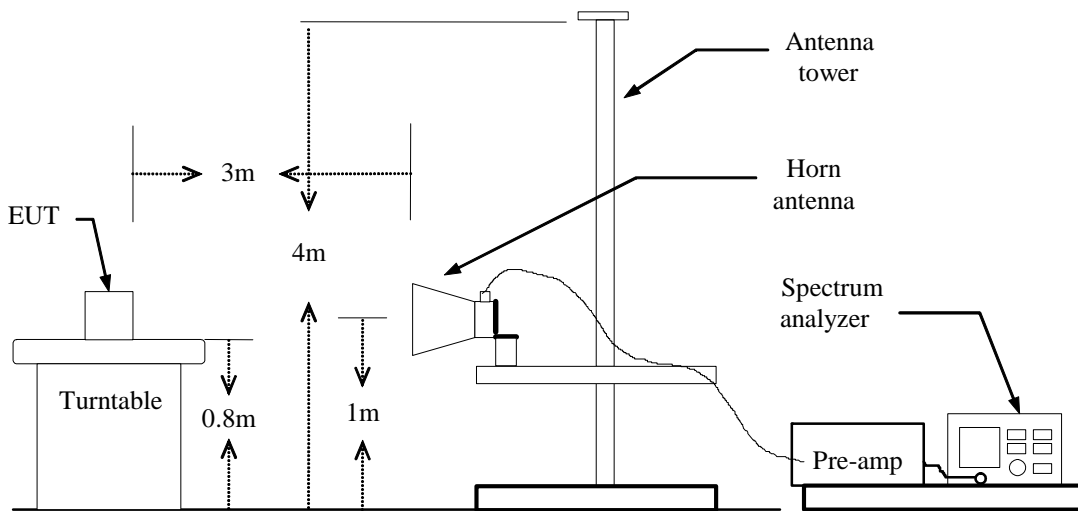

For Conducted

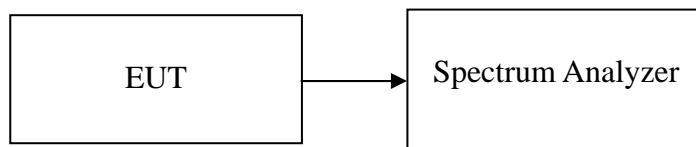



TEST PROCEDURE

For Radiated

1. The EUT is placed on a turntable, which is 0.8m above the ground plane.
2. The turntable shall be rotated for 360 degrees to determine the position of maximum emission level.
3. EUT is set 3m away from the receiving antenna, which is varied from 1m to 4m to find out the highest emission.
4. Set the spectrum analyzer in the following setting in order to capture the lower and upper band-edges of the emission:
 - (a) PEAK: RBW=VBW=1MHz / Sweep=AUTO
 - (b) AVERAGE: RBW=1MHz / VBW=10Hz / Sweep=AUTO
5. Repeat the procedures until all the PEAK and AVERAGE versus POLARIZATION are measured.

For Conducted

Conducted RF measurements of the transmitter output were made to confirm that the EUT antenna port conducted emissions meet the specified limit and to identify any spurious signals that require further investigation or measurements on the radiated emissions site.

The transmitter output is connected to the spectrum analyzer. The resolution bandwidth is set to 300 kHz. The video bandwidth is set to 300 kHz.

TEST RESULTS

Refer to attach spectrum analyzer data chart.



For GFSK / DH5

Band Edges (CH Low)

Detector mode: Peak

Polarity: Vertical

Agilent 09:52:10 22 Nov 2011

R T

Mkr3 2.402 15 GHz
81.28 dB μ V/m

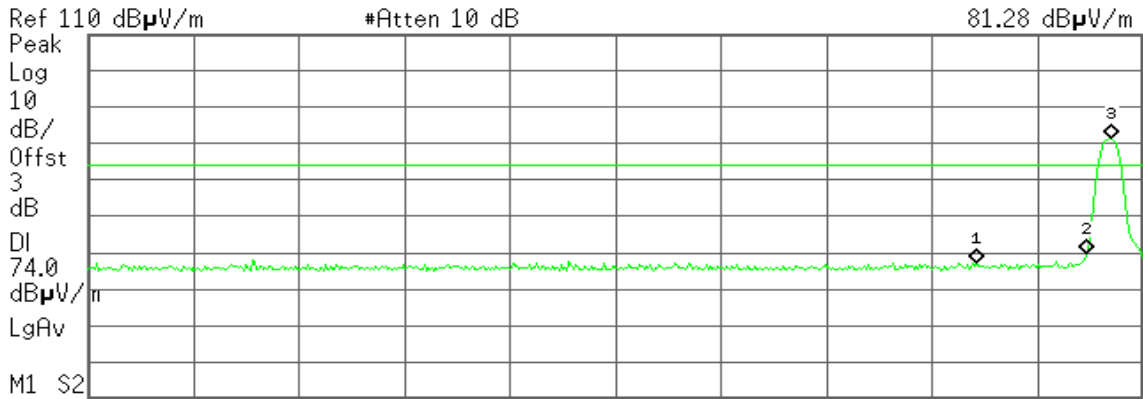

Start 2.310 00 GHz Stop 2.405 00 GHz
#Res BW 1 MHz #VBW 1 MHz #Sweep 100 ms (601 pts)

Marker	Trace	Type	X Axis	Amplitude
1	(1)	Freq	2.390 00 GHz	47.39 dB μ V/m
2	(1)	Freq	2.400 00 GHz	50.00 dB μ V/m
3	(1)	Freq	2.402 15 GHz	81.28 dB μ V/m

Detector mode: Average

Polarity: Vertical

Agilent 09:52:30 22 Nov 2011

R T

Mkr3 2.402 15 GHz
71.18 dB μ V/m

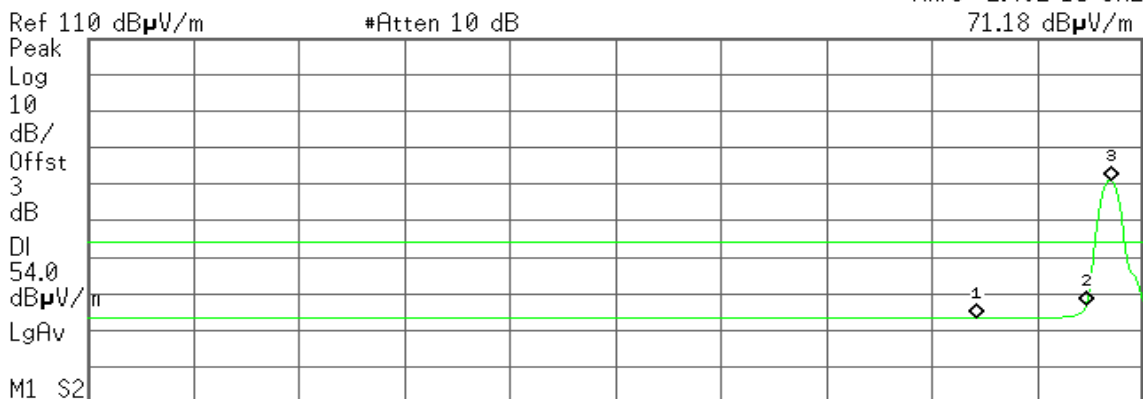

Start 2.310 00 GHz Stop 2.405 00 GHz
#Res BW 1 MHz #VBW 10 Hz Sweep 7.408 s (601 pts)

Marker	Trace	Type	X Axis	Amplitude
1	(1)	Freq	2.390 00 GHz	33.42 dB μ V/m
2	(1)	Freq	2.400 00 GHz	36.77 dB μ V/m
3	(1)	Freq	2.402 15 GHz	71.18 dB μ V/m



Detector mode: Peak

Polarity: Horizontal

Agilent 09:48:15 22 Nov 2011

R T

Mkr3 2.402 15 GHz
87.56 dB μ V/m

Ref 110 dB μ V/m

#Atten 10 dB

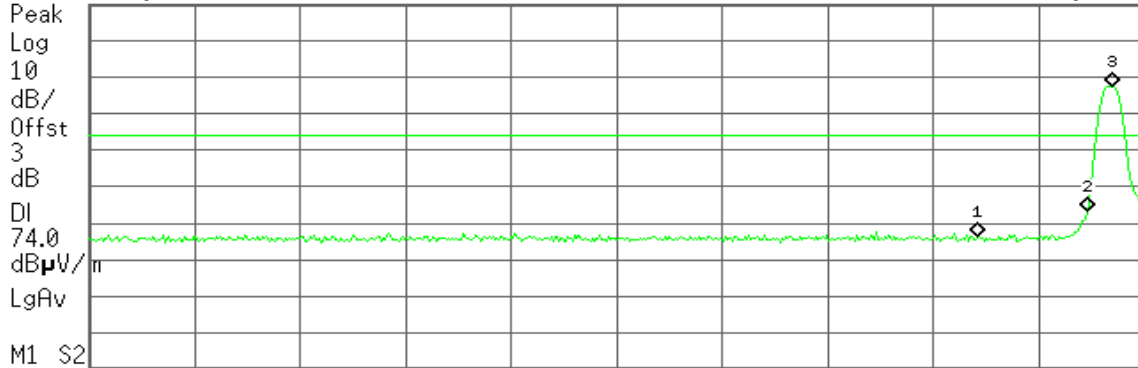

Start 2.310 00 GHz

Stop 2.405 00 GHz

#Res BW 1 MHz

#VBW 1 MHz

#Sweep 100 ms (601 pts)

Marker	Trace	Type	X Axis	Amplitude
1	(1)	Freq	2.390 00 GHz	46.44 dB μ V/m
2	(1)	Freq	2.400 00 GHz	53.19 dB μ V/m
3	(1)	Freq	2.402 15 GHz	87.56 dB μ V/m

Detector mode: Average

Polarity: Horizontal

Agilent 09:48:34 22 Nov 2011

R T

Mkr3 2.402 15 GHz
76.48 dB μ V/m

Ref 110 dB μ V/m

#Atten 10 dB

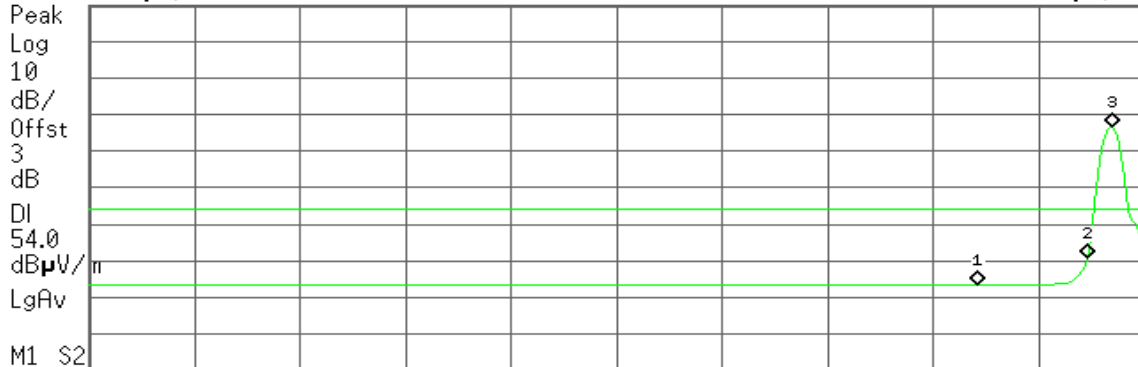

Start 2.310 00 GHz

Stop 2.405 00 GHz

#Res BW 1 MHz

#VBW 10 Hz

Sweep 7.408 s (601 pts)

Marker	Trace	Type	X Axis	Amplitude
1	(1)	Freq	2.390 00 GHz	33.40 dB μ V/m
2	(1)	Freq	2.400 00 GHz	40.66 dB μ V/m
3	(1)	Freq	2.402 15 GHz	76.48 dB μ V/m



Band Edges (CH High)

Detector mode: Peak

Polarity: Vertical

Agilent 10:05:15 22 Nov 2011

R T

Mkr1 2.483 50 GHz

46.22 dB μ V/m

Ref 110 dB μ V/m

#Atten 10 dB

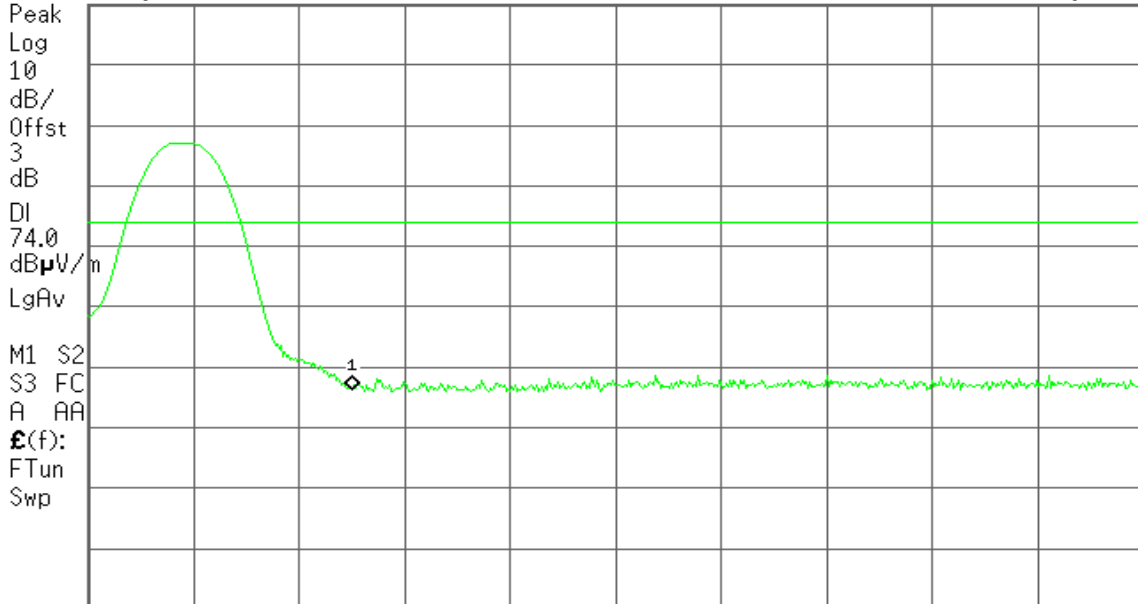

Start 2.478 00 GHz

Stop 2.500 00 GHz

#Res BW 1 MHz

#VBW 1 MHz

#Sweep 100 ms (601 pts)

Detector mode: Average

Polarity: Vertical

Agilent 10:05:49 22 Nov 2011

R T

Mkr1 2.483 50 GHz

34.70 dB μ V/m

Ref 110 dB μ V/m

#Atten 10 dB

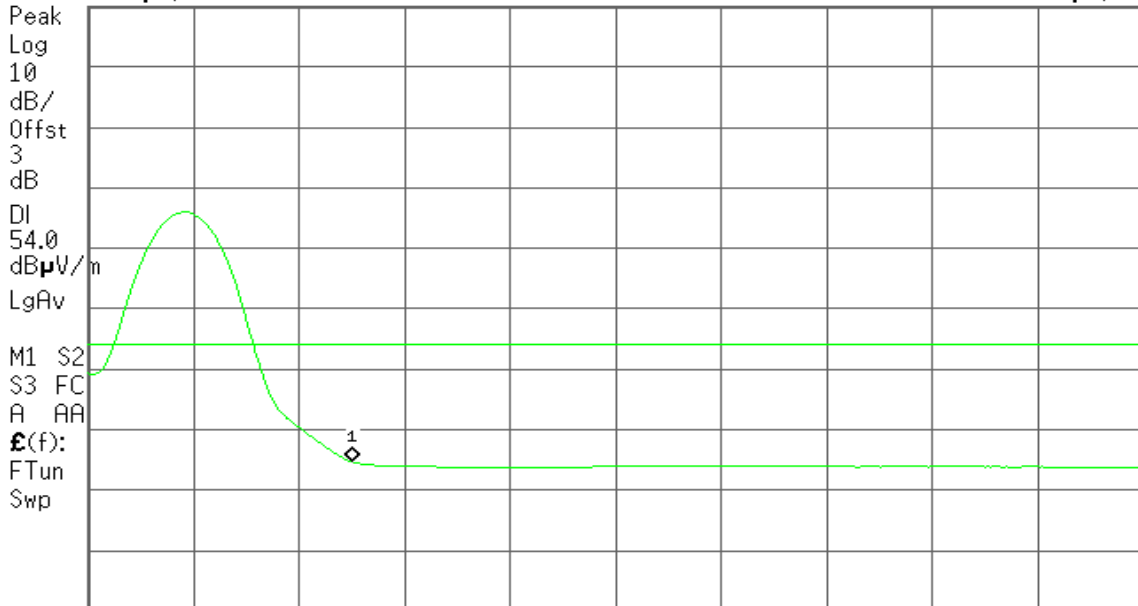

Start 2.478 00 GHz

Stop 2.500 00 GHz

#Res BW 1 MHz

#VBW 10 Hz

Sweep 1.715 s (601 pts)



Detector mode: Peak

Polarity: Horizontal

Agilent 09:59:35 22 Nov 2011

R T

Mkr1 2.483 50 GHz
47.37 dB μ V/m

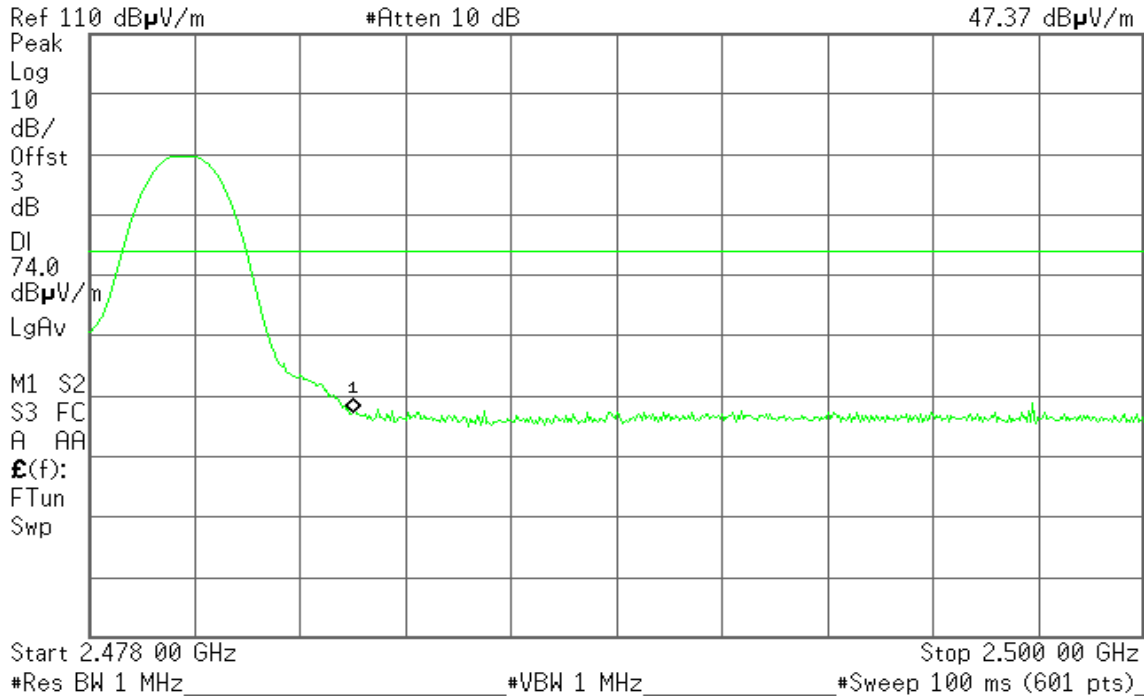

Detector mode: Average

Polarity: Horizontal

Agilent 09:59:53 22 Nov 2011

R T

Mkr1 2.483 50 GHz
35.36 dB μ V/m

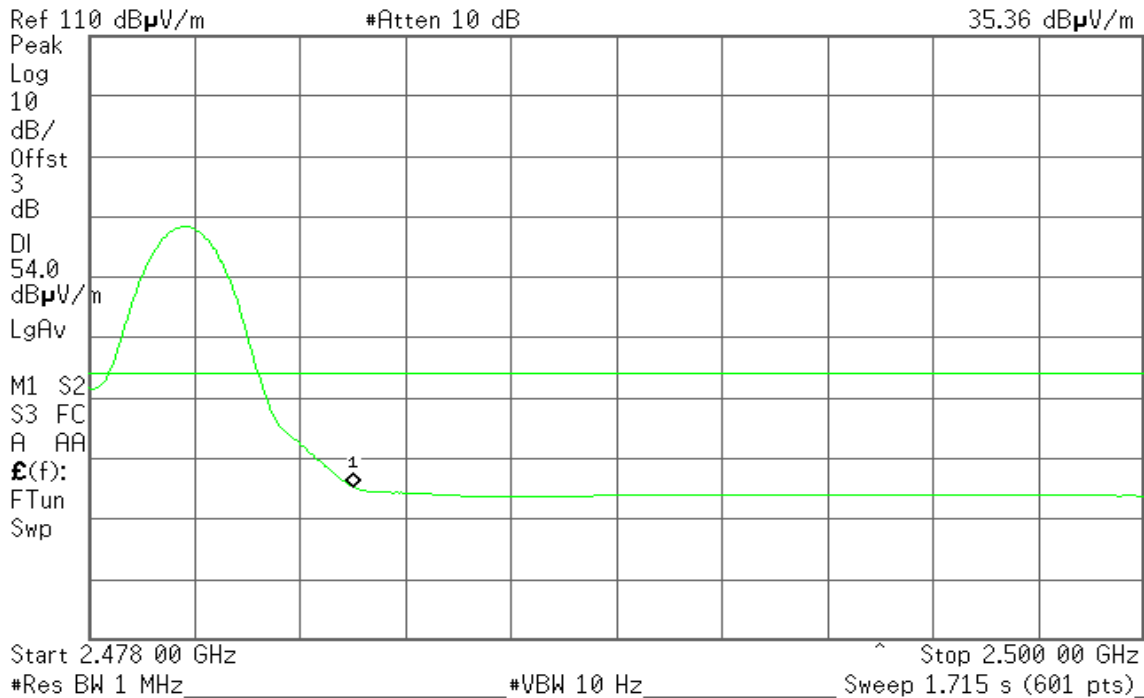



For 8DPSK / DH5

Band Edges (CH Low)

Detector mode: Peak

Polarity: Vertical

Agilent 13:38:09 22 Nov 2011

R T

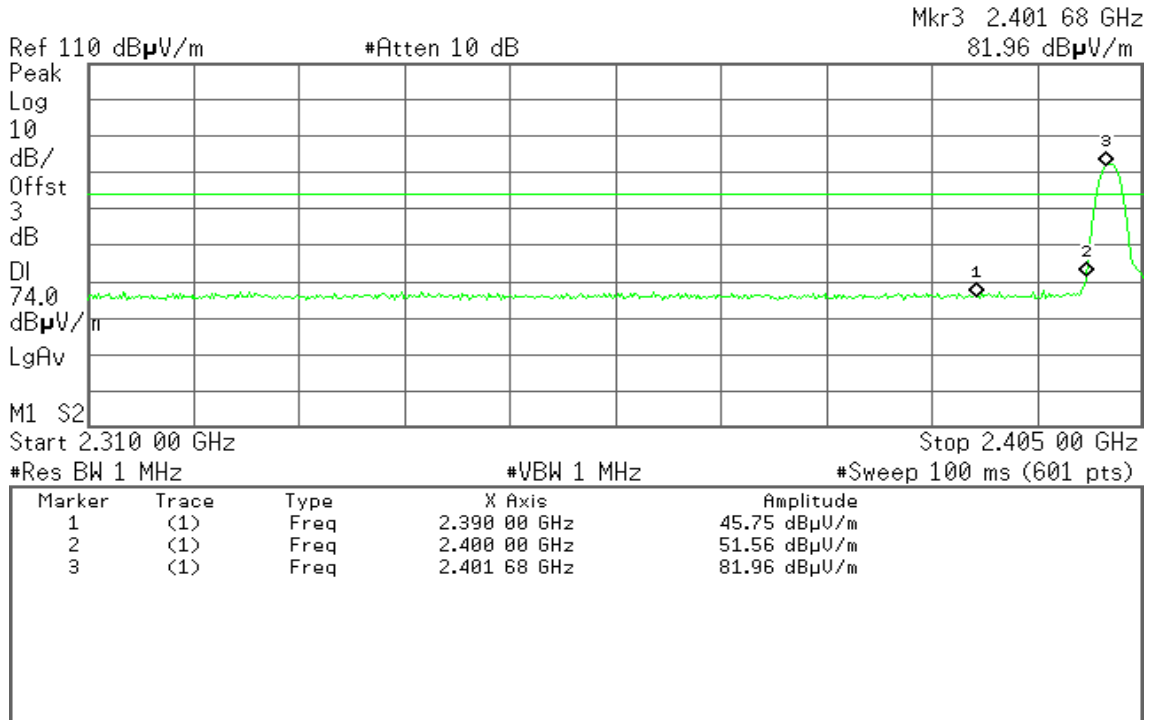

Detector mode: Average

Polarity: Vertical

Agilent 13:38:31 22 Nov 2011

R T

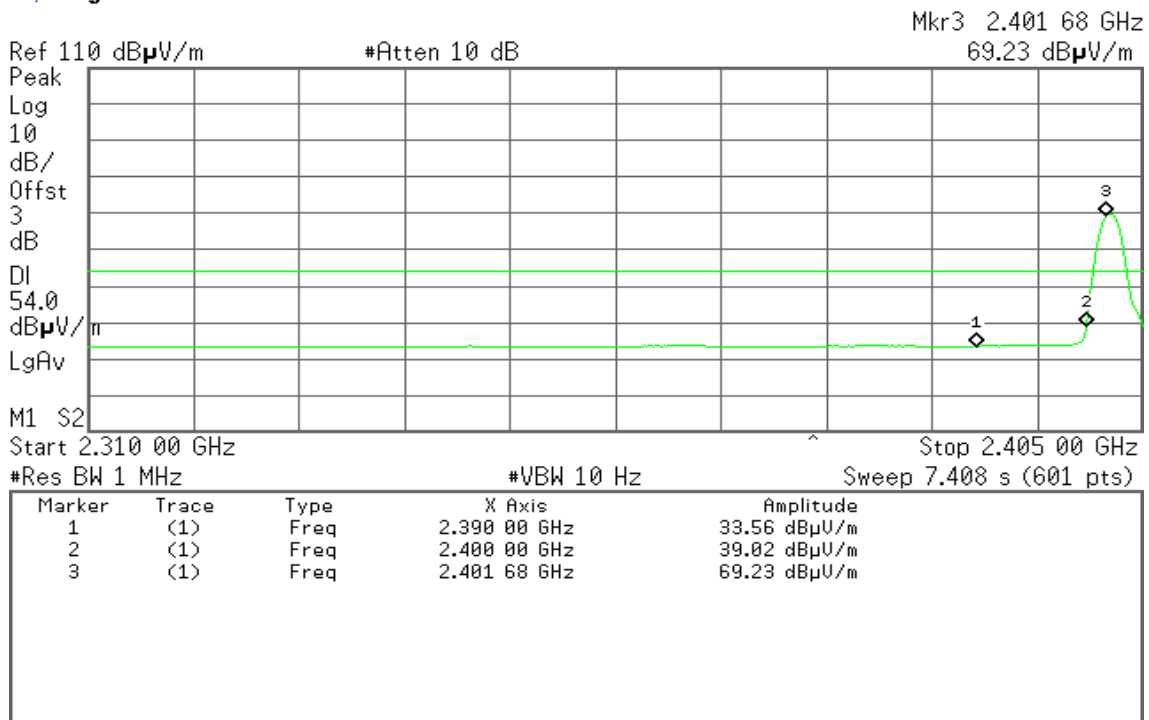



Detector mode: Peak

Polarity: Horizontal

Agilent 13:42:15 22 Nov 2011

R T

Mkr3 2.401 83 GHz
83.97 dBµV/m

Ref 110 dBµV/m

#Atten 10 dB

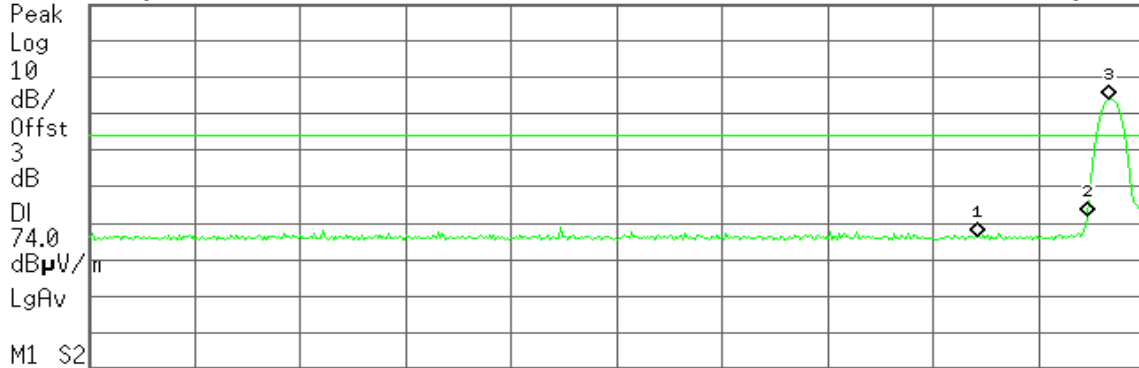

Start 2.310 00 GHz

Stop 2.405 00 GHz

#Res BW 1 MHz

#VBW 1 MHz

#Sweep 100 ms (601 pts)

Marker	Trace	Type	X Axis	Amplitude
1	(1)	Freq	2.390 00 GHz	46.23 dBµV/m
2	(1)	Freq	2.400 00 GHz	52.00 dBµV/m
3	(1)	Freq	2.401 83 GHz	83.97 dBµV/m

Detector mode: Average

Polarity: Horizontal

Agilent 13:42:35 22 Nov 2011

T

Mkr3 2.402 15 GHz
66.30 dBµV/m

Ref 110 dBµV/m

#Atten 10 dB

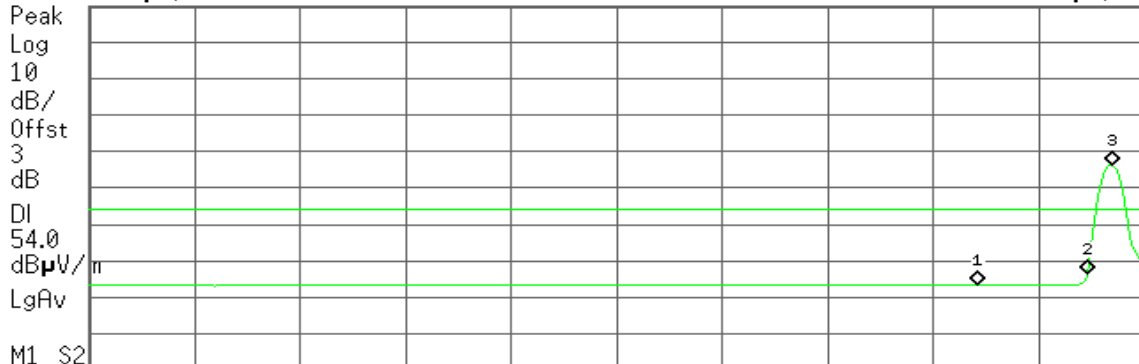

Start 2.310 00 GHz

Stop 2.405 00 GHz

#Res BW 1 MHz

#VBW 10 Hz

Sweep 7.408 s (601 pts)

Marker	Trace	Type	X Axis	Amplitude
1	(1)	Freq	2.390 00 GHz	33.37 dBµV/m
2	(1)	Freq	2.400 00 GHz	36.58 dBµV/m
3	(1)	Freq	2.402 15 GHz	66.30 dBµV/m



Band Edges (CH High)

Detector mode: Peak

Polarity: Vertical

Agilent 13:51:52 22 Nov 2011

R T

Mkr1 2.483 50 GHz
46.76 dB μ V/m

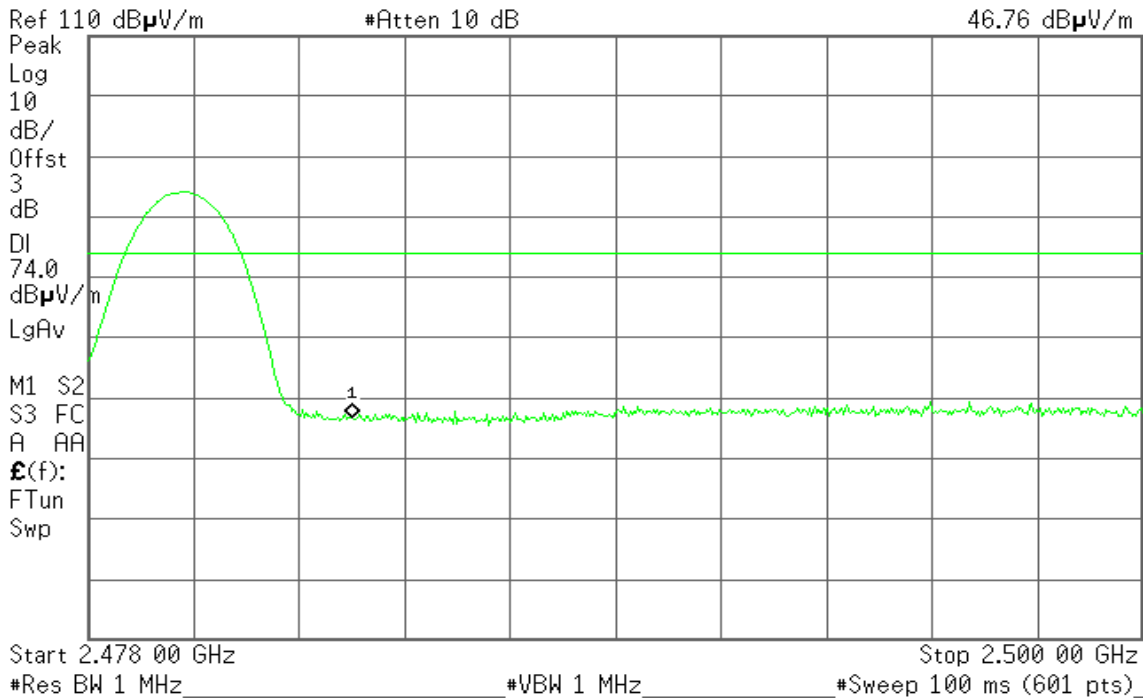

Detector mode: Average

Polarity: Vertical

Agilent 13:52:08 22 Nov 2011

R T

Mkr1 2.483 50 GHz
34.06 dB μ V/m

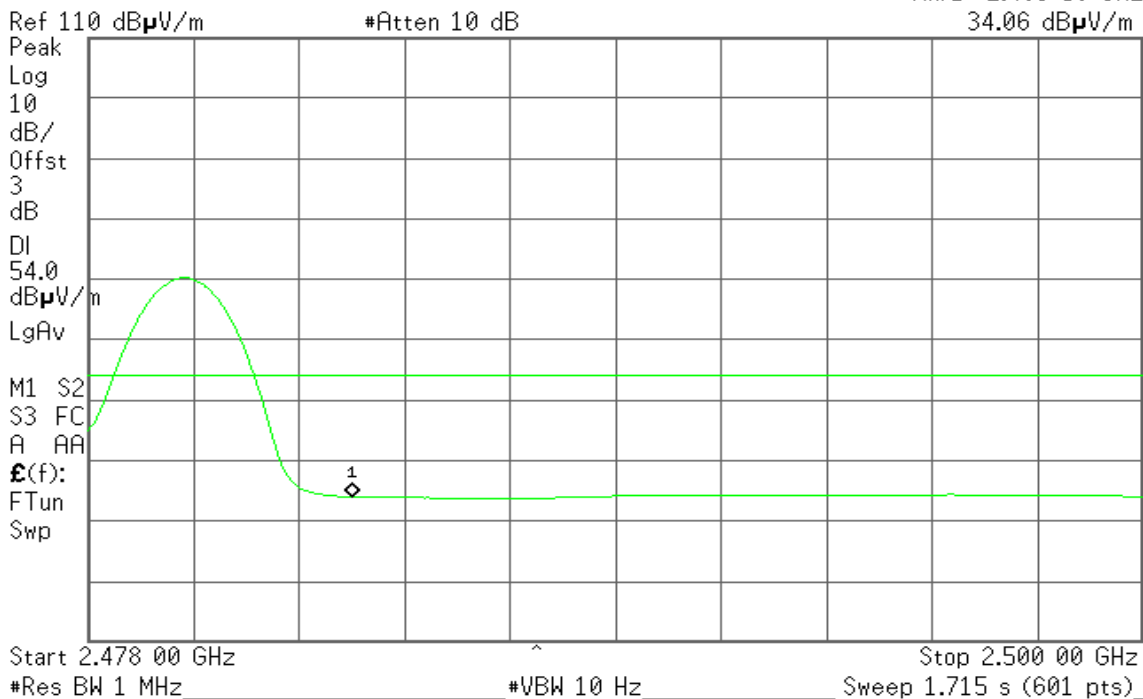



Detector mode: Peak

Polarity: Horizontal

Agilent 13:56:12 22 Nov 2011

R T

Mkr1 2.483 50 GHz
46.24 dB μ V/m

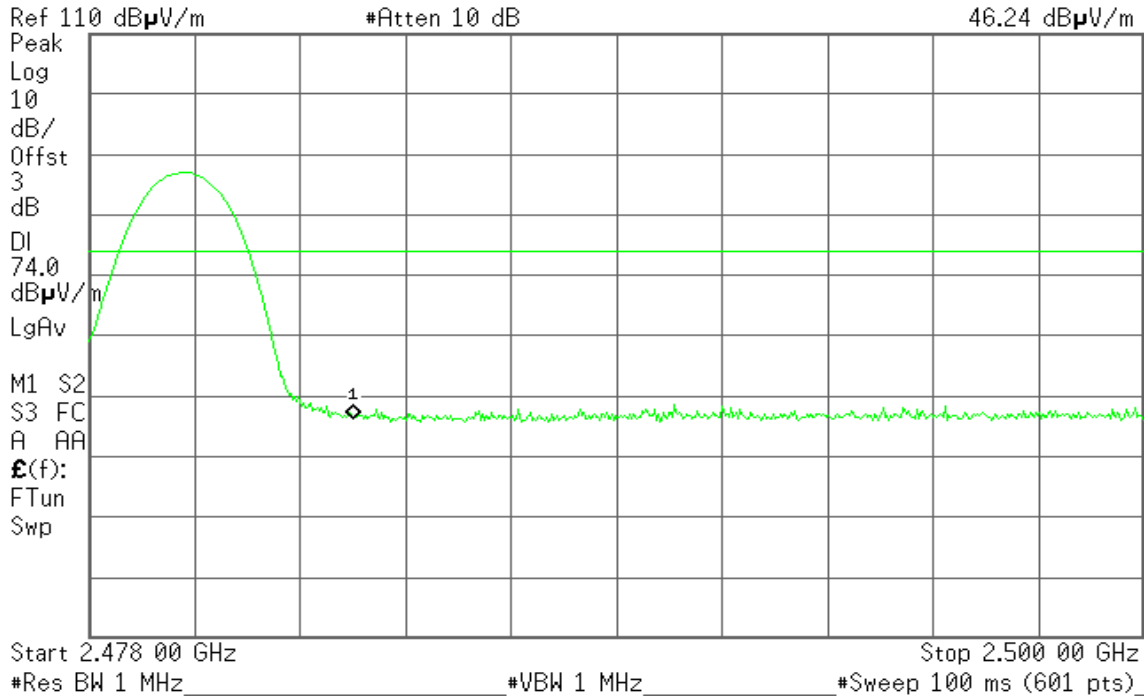

Detector mode: Average

Polarity: Horizontal

Agilent 13:56:31 22 Nov 2011

R T

Mkr1 2.483 50 GHz
34.36 dB μ V/m

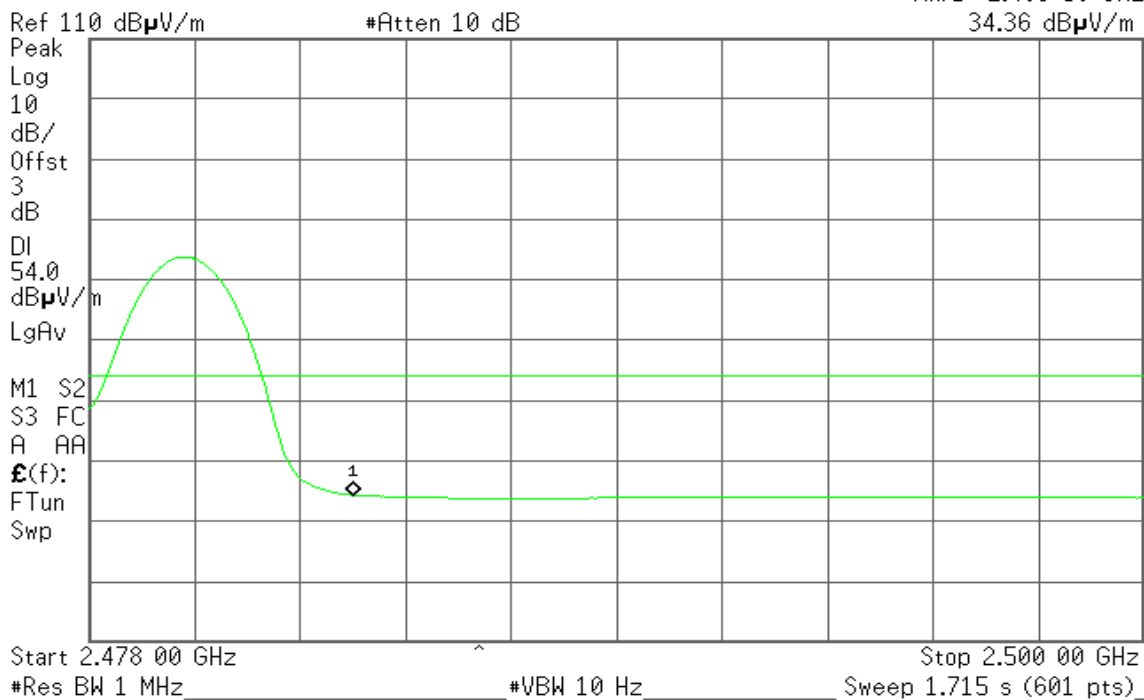



GFSK

Hopping Mode

(CH Low)

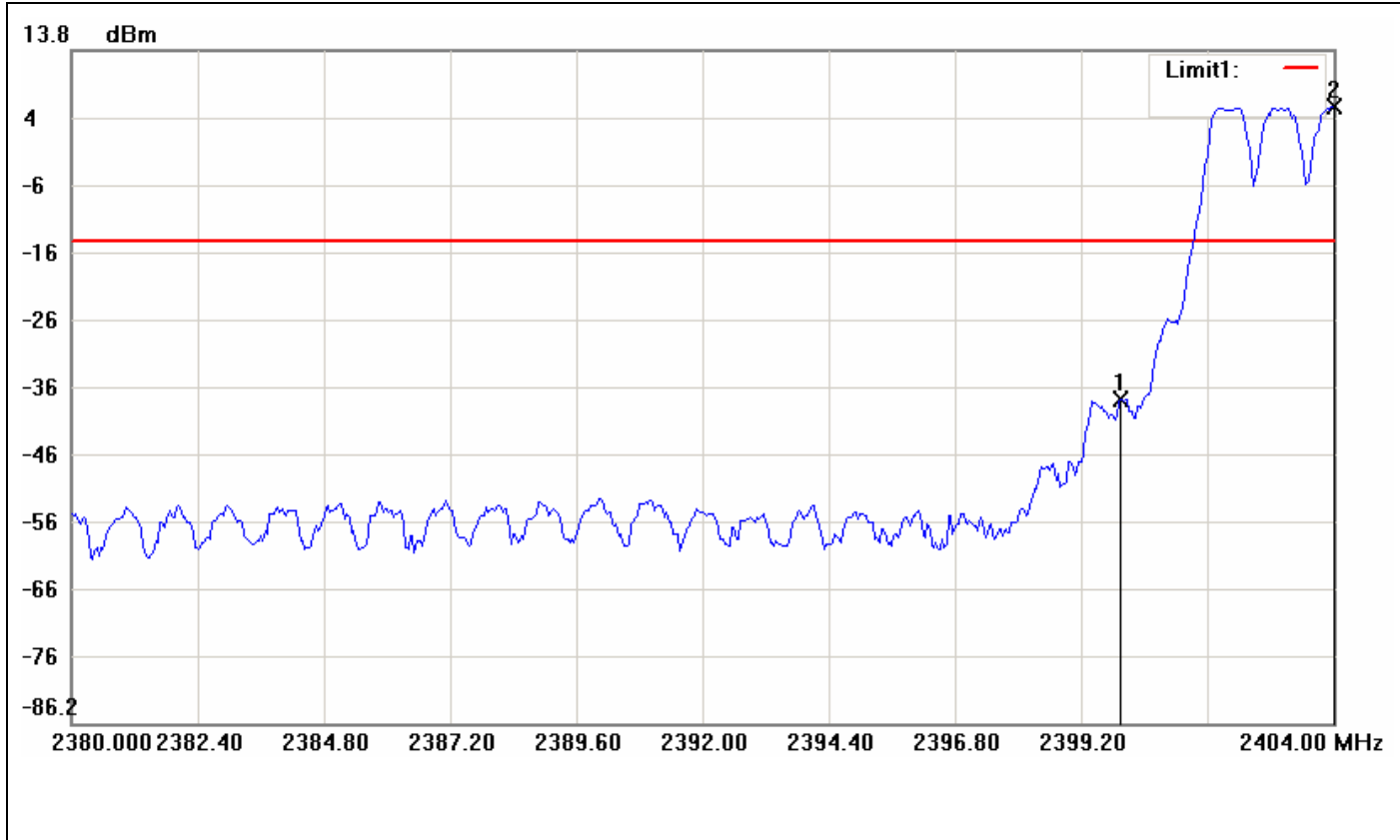

No.	Frequency(MHz)	Level(dBm)	Limit(dBm)	Margin(dBm)
1	2399.9600	-38.15	-14.64	-23.51
2	2404.0000	5.36	-14.64	20.00



(CH High)

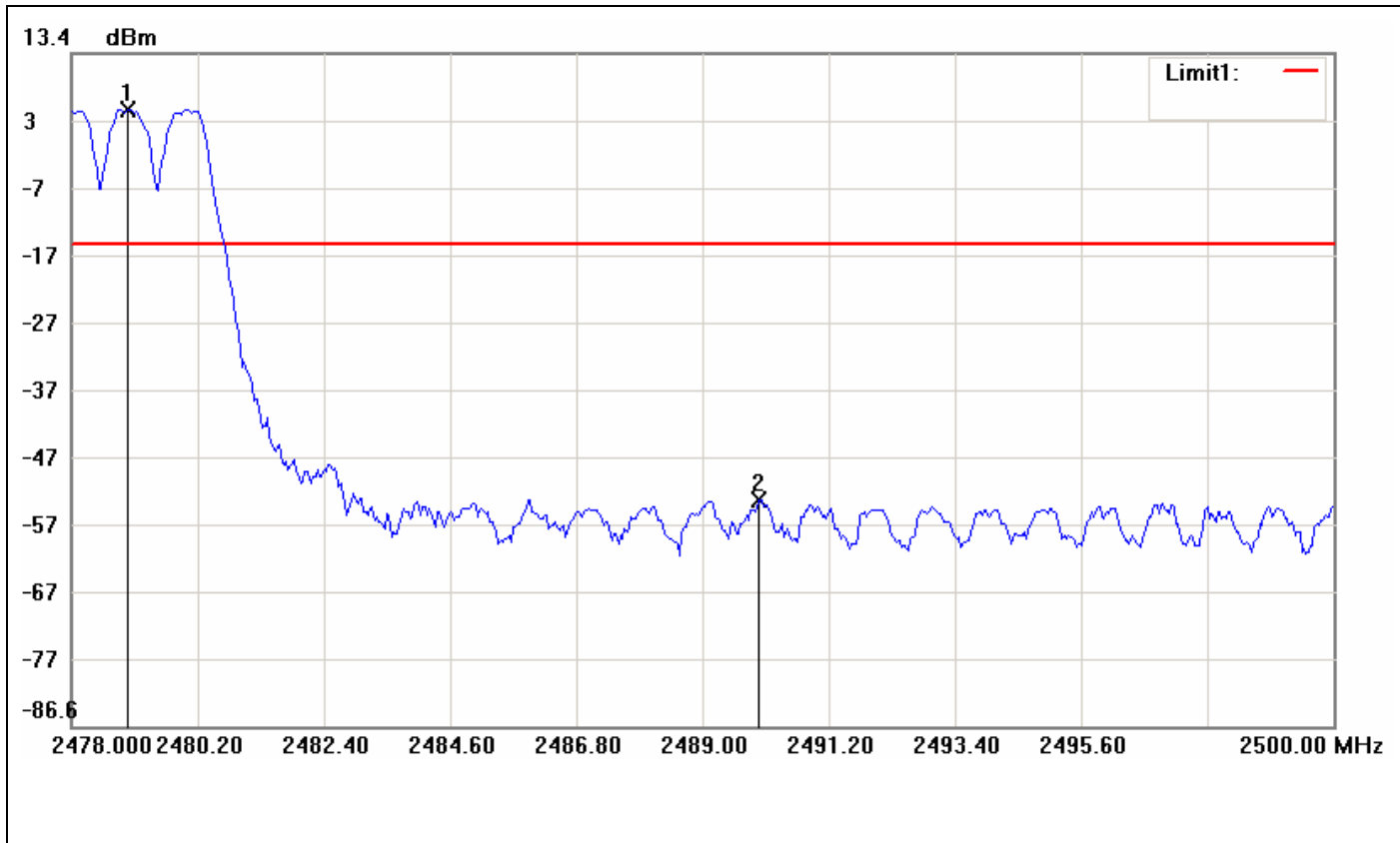

No.	Frequency(MHz)	Level(dBm)	Limit(dBm)	Margin(dBm)
1	2478.9900	4.95	-15.05	20.00
2	2489.9900	-52.98	-15.05	-37.93



8DPSK

Hopping Mode

(CH Low)

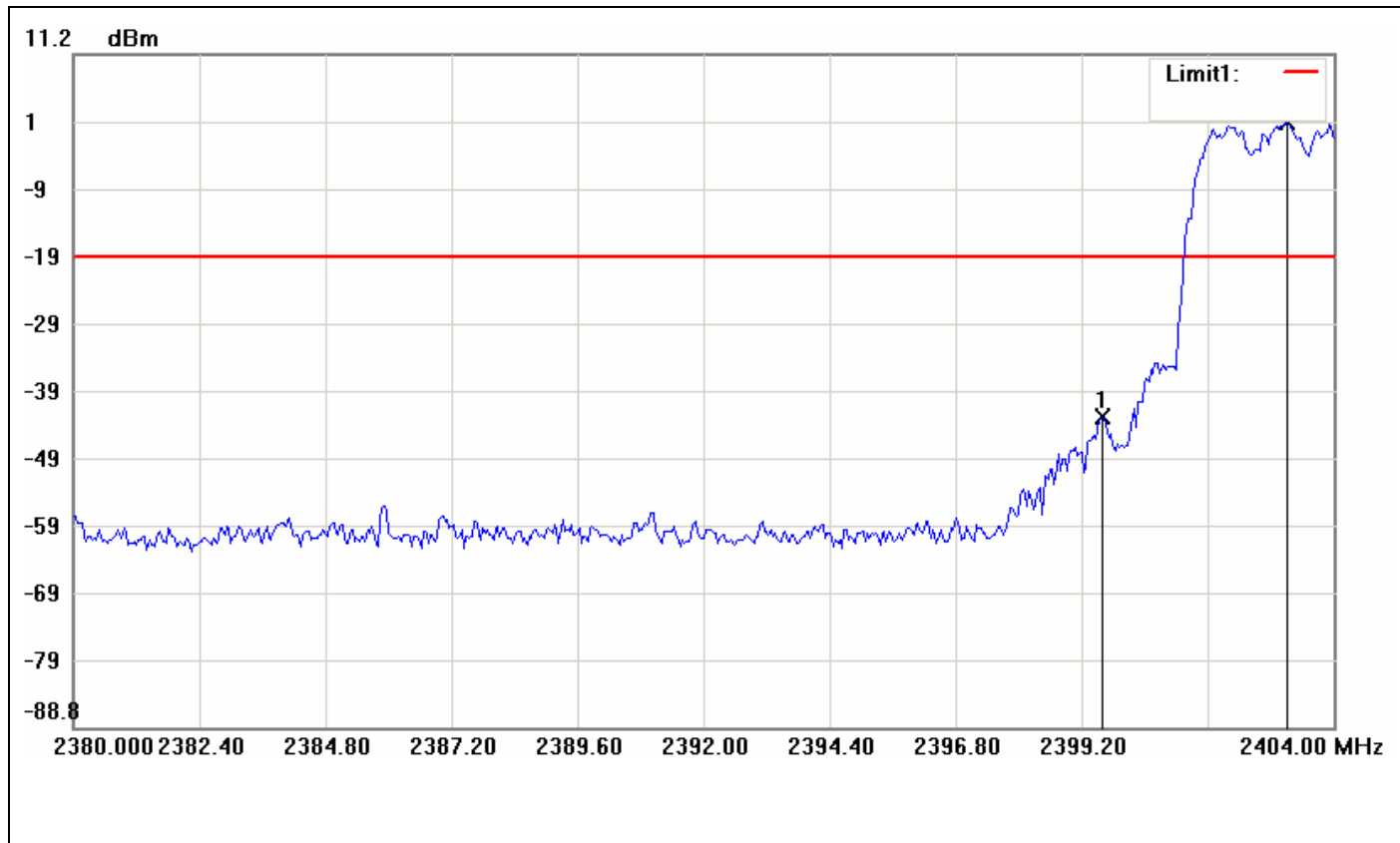

No.	Frequency(MHz)	Level(dBm)	Limit(dBm)	Margin(dBm)
1	2399.6000	-42.73	-18.95	-23.78
2	2403.1200	1.05	-18.95	20.00



(CH High)

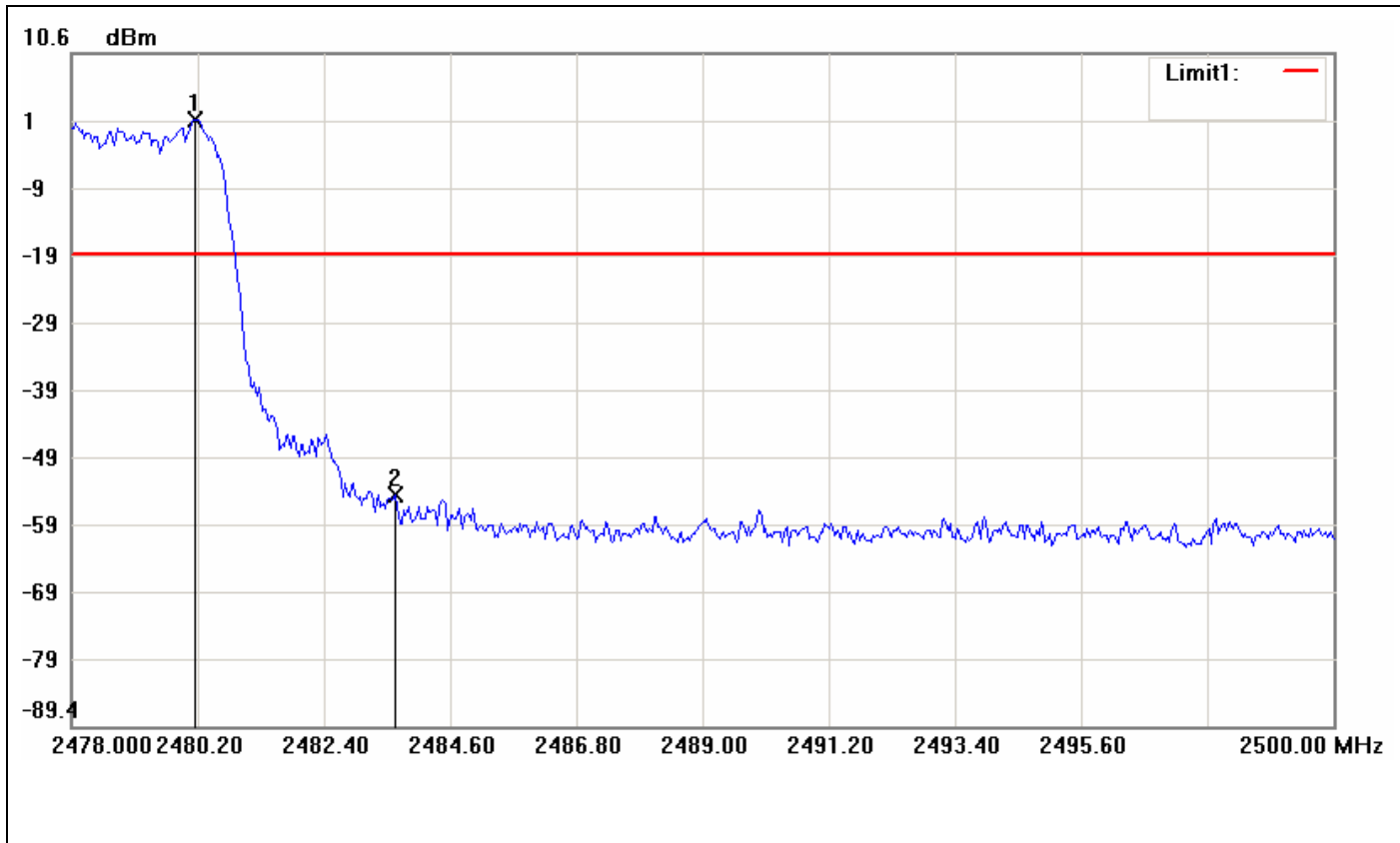

No.	Frequency(MHz)	Level(dBm)	Limit(dBm)	Margin(dBm)
1	2480.1633	0.68	-19.32	20.00
2	2483.6467	-55.11	-19.32	-35.79



7.4 FREQUENCY SEPARATION

LIMIT

According to §15.247(a)(1), Frequency hopping systems shall have hopping channel carrier frequencies separated by a minimum of 25 kHz or the 20 dB bandwidth of the hopping channel, whichever is greater. Alternatively, frequency hopping systems operating in the 2400-2483.5 MHz band may have hopping channel carrier frequencies that are separated by 25 kHz or two-thirds of the 20 dB bandwidth of the hopping channel, whichever is greater, provided the systems operate with an output power no greater than 125 mW.

Test Configuration

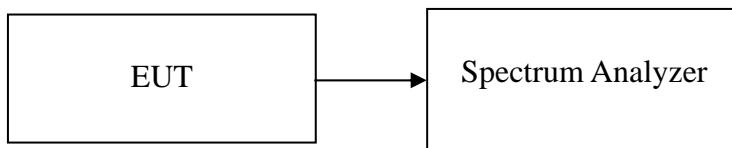

TEST PROCEDURE

1. Place the EUT on the table and set it in transmitting mode.
2. Remove the antenna from the EUT and then connect a low loss RF cable from the antenna port to the spectrum analyzer.
3. Set center frequency of spectrum analyzer = middle of hopping channel.
4. Set the spectrum analyzer as for GFSK RBW=30 kHz, VBW = 1000 kHz, Span = 3MHz, Sweep = auto. / for 8DPSK RBW=30 kHz, VBW = 100 kHz, Span = 3MHz, Sweep = auto.
5. Max hold, mark 3 peaks of hopping channel and record the 3 peaks frequency.

TEST RESULTS

No non-compliance noted



Test Data

For GFSK / DH5

Channel Separation (MHz)	two-thirds of the 20 dB bandwidth (kHz)	Channel Separation Limit	Result
1.005	636.66	>two-thirds of the 20 dB bandwidth	Pass

For 8DPSK / DH5

Channel Separation (MHz)	two-thirds of the 20 dB bandwidth (kHz)	Channel Separation Limit	Result
1.185	856.66	>two-thirds of the 20 dB bandwidth	Pass



Test Plot

For GFSK / DH5

Measurement of Channel Separation

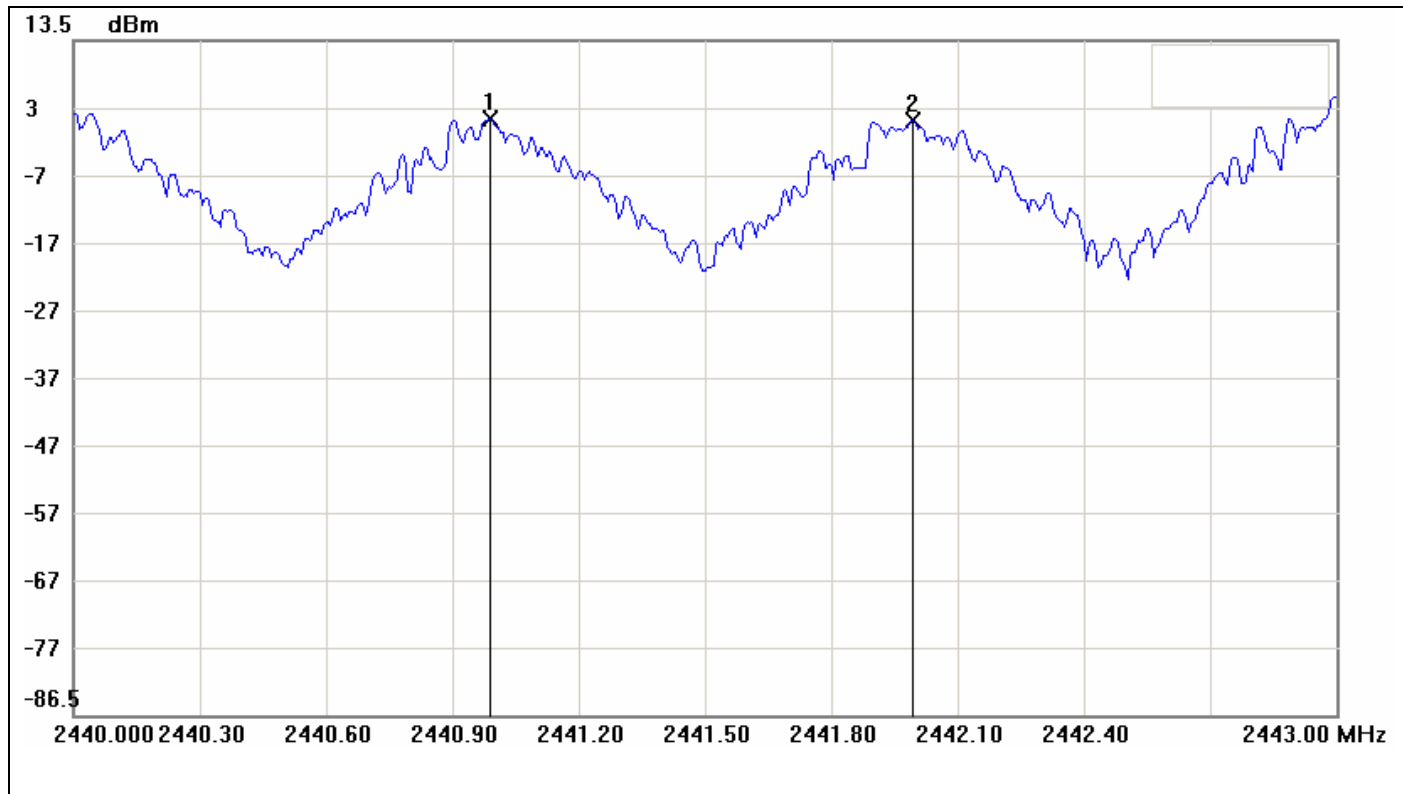

No.	Frequency(MHz)	Level(dBm)	Limit(dBm)	Margin(dBm)
1	2440.9900	1.84		
2	2441.9950	1.58		

No.		Δ Frequency(MHz)	Δ Level(dB)
1	mk2-mk1	1.005	-0.26



Measurement of 20dB Bandwidth

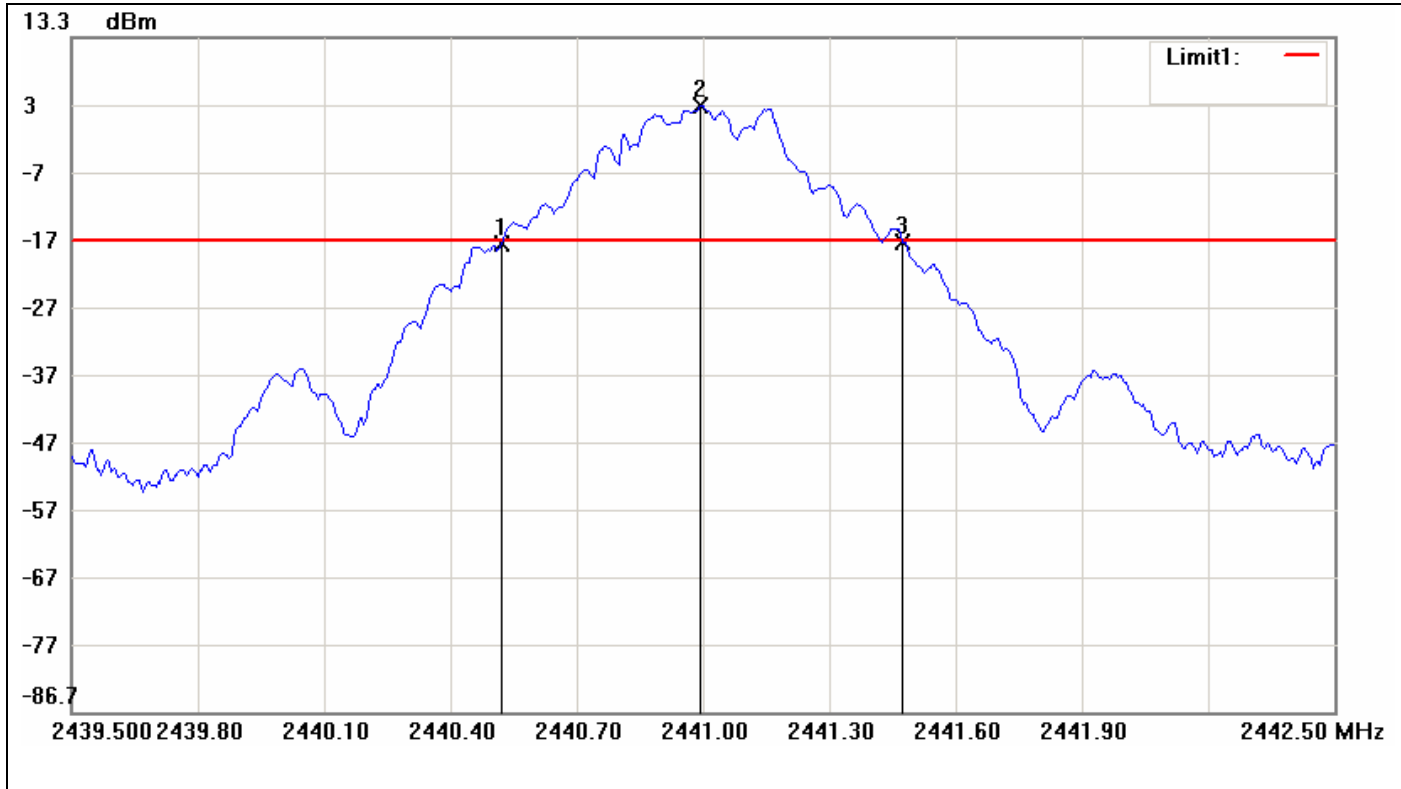

No.	Frequency(MHz)	Level(dBm)	Limit(dBm)	Margin(dBm)
1	2440.5200	-17.37	-16.87	-0.50
2	2440.9950	3.13	-16.87	20.00
3	2441.4750	-17.05	-16.87	-0.18

No.		Δ Frequency(MHz)	Δ Level(dB)
1	mk3-mk1	0.955	0.32



For 8DPSK / DH5

Measurement of Channel Separation

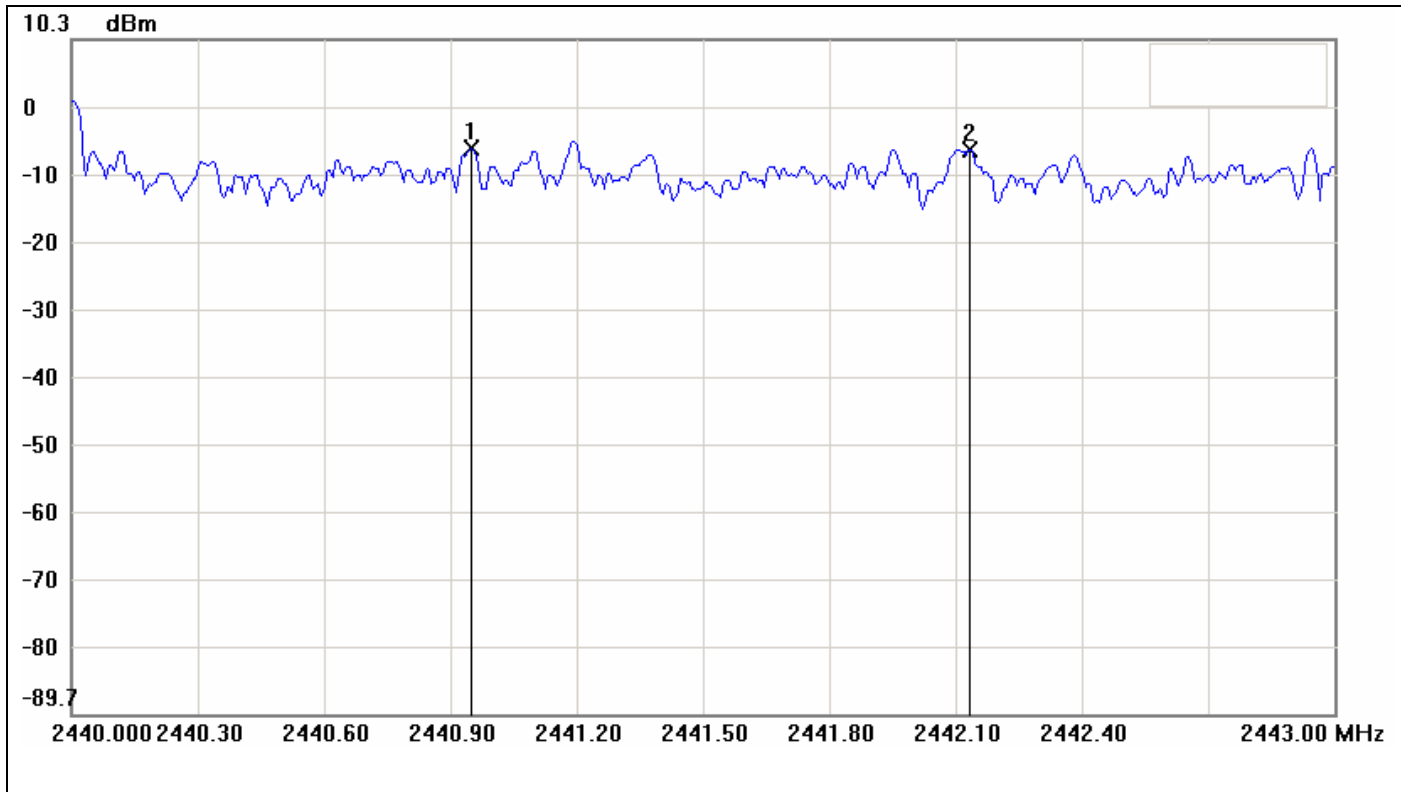

No.	Frequency(MHz)	Level(dBm)	Limit(dBm)	Margin(dBm)
1	2440.9500	-5.95		
2	2442.1350	-6.00		

No.		Δ Frequency(MHz)	Δ Level(dB)
1	mk2-mk1	1.185	-0.05



Measurement of 20dB Bandwidth

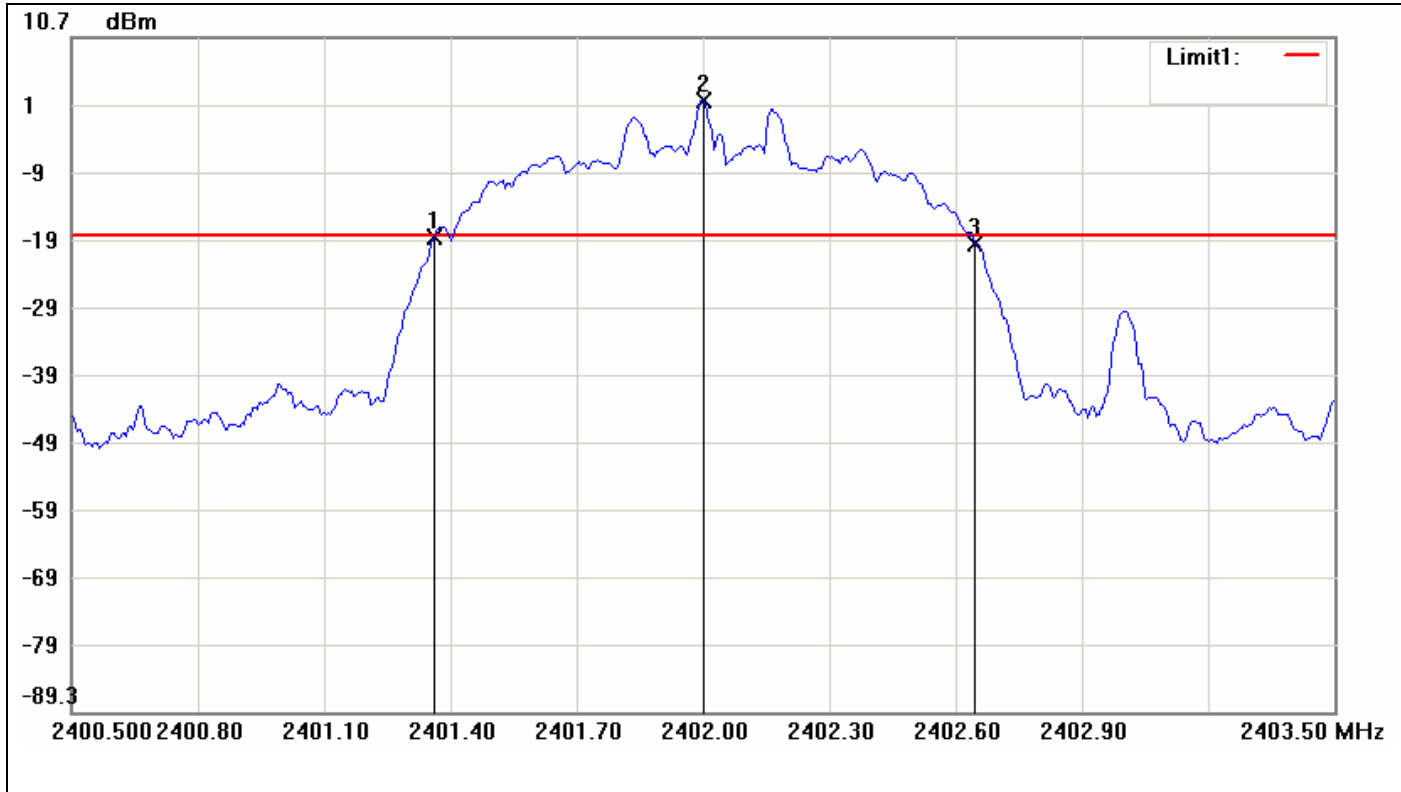

No.	Frequency(MHz)	Level(dBm)	Limit(dBm)	Margin(dBm)
1	2401.3600	-18.84	-18.75	-0.09
2	2402.0000	1.25	-18.75	20.00
3	2402.6450	-19.91	-18.75	-1.16

No.		Δ Frequency(MHz)	Δ Level(dB)
1	mk3-mk1	1.285	-1.07



7.5 NUMBER OF HOPPING FREQUENCY

LIMIT

According to §15.247(a)(1)(iii), Frequency hopping systems operating in the 2400MHz-2483.5 MHz bands shall use at least 15 hopping frequencies.

Test Configuration

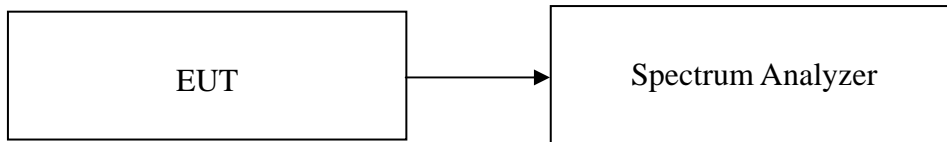

TEST PROCEDURE

1. Place the EUT on the table and set it in transmitting mode.
2. Remove the antenna from the EUT and then connect a low loss RF cable from the antenna port to the spectrum analyzer.
3. Set spectrum analyzer Start=2400MHz, Stop = 2430.5MHz, Sweep = auto, Start=2430.5MHz, Stop = 2460.5MHz, Sweep = auto and Start=2460.5MHz, Stop = 2485.5MHz, Sweep = auto.
4. Set the spectrum analyzer as RBW, VBW=510kHz.
5. Max hold, view and count how many channel in the band.

TEST RESULTS

No non-compliance noted

Test Data

For GFSK / 8DPSK

Result (No. of CH)	Limit (No. of CH)	Result
79	>15	PASS



Test Plot

For GFSK

Channel Number

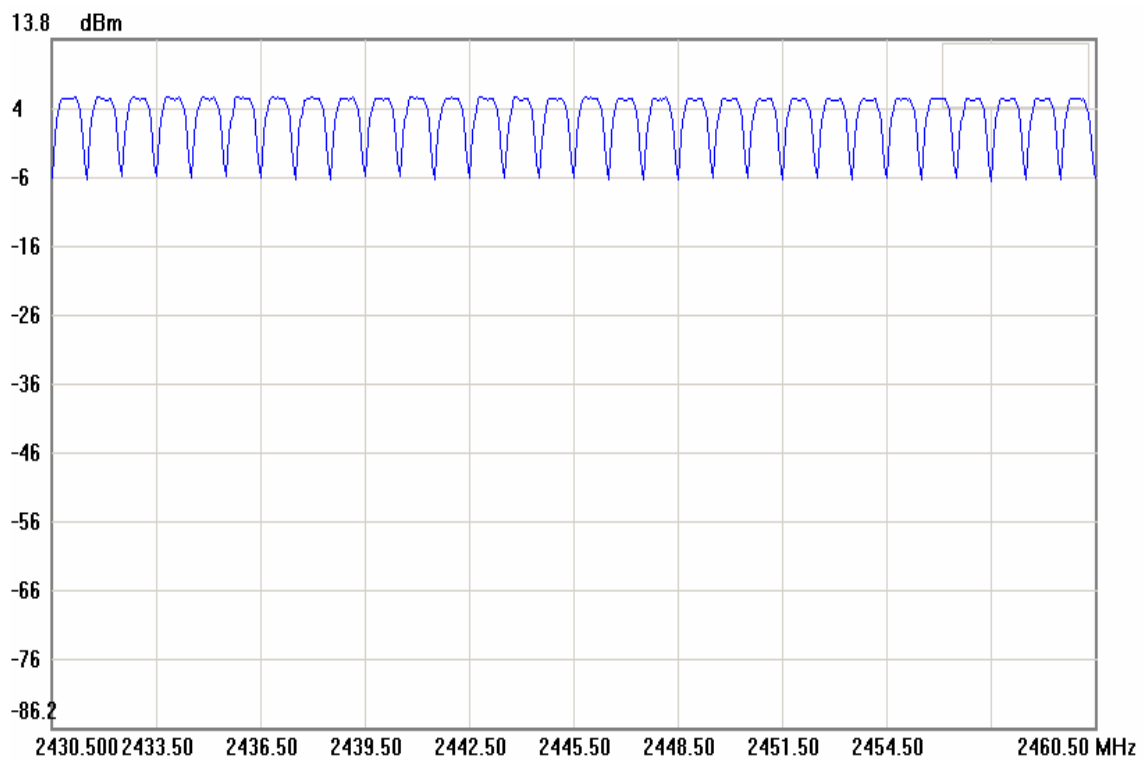
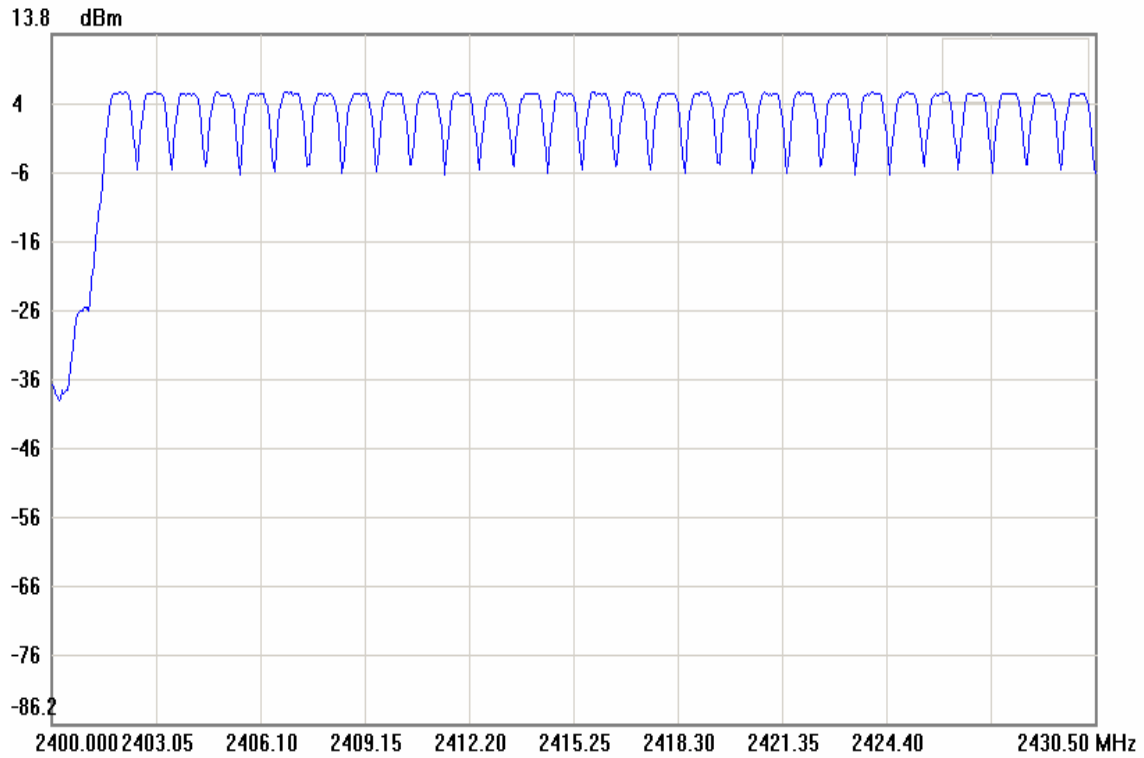

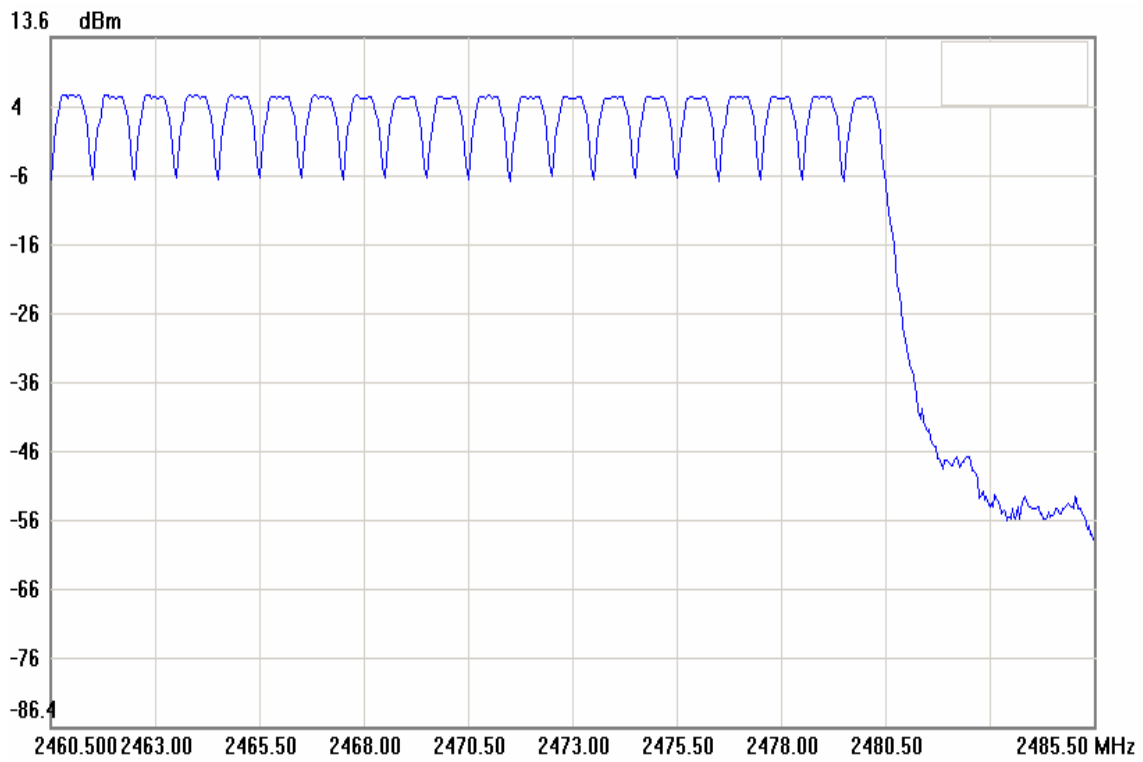

For 8DPSK

Channel Number

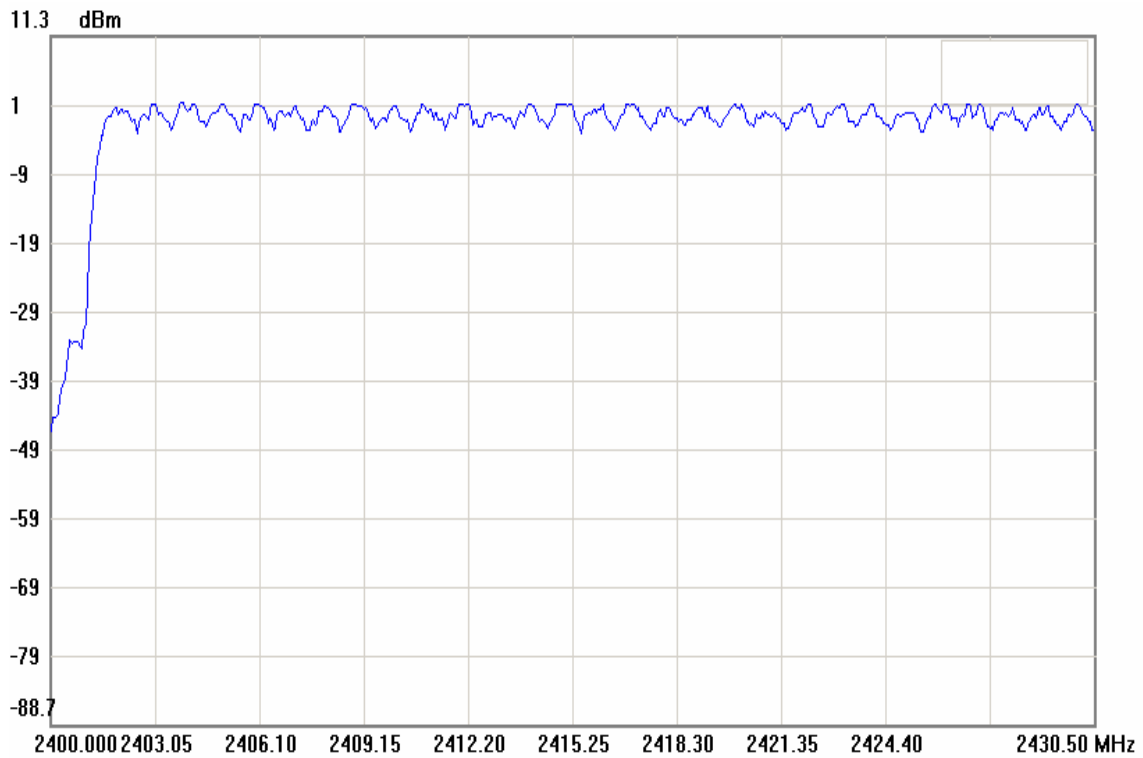

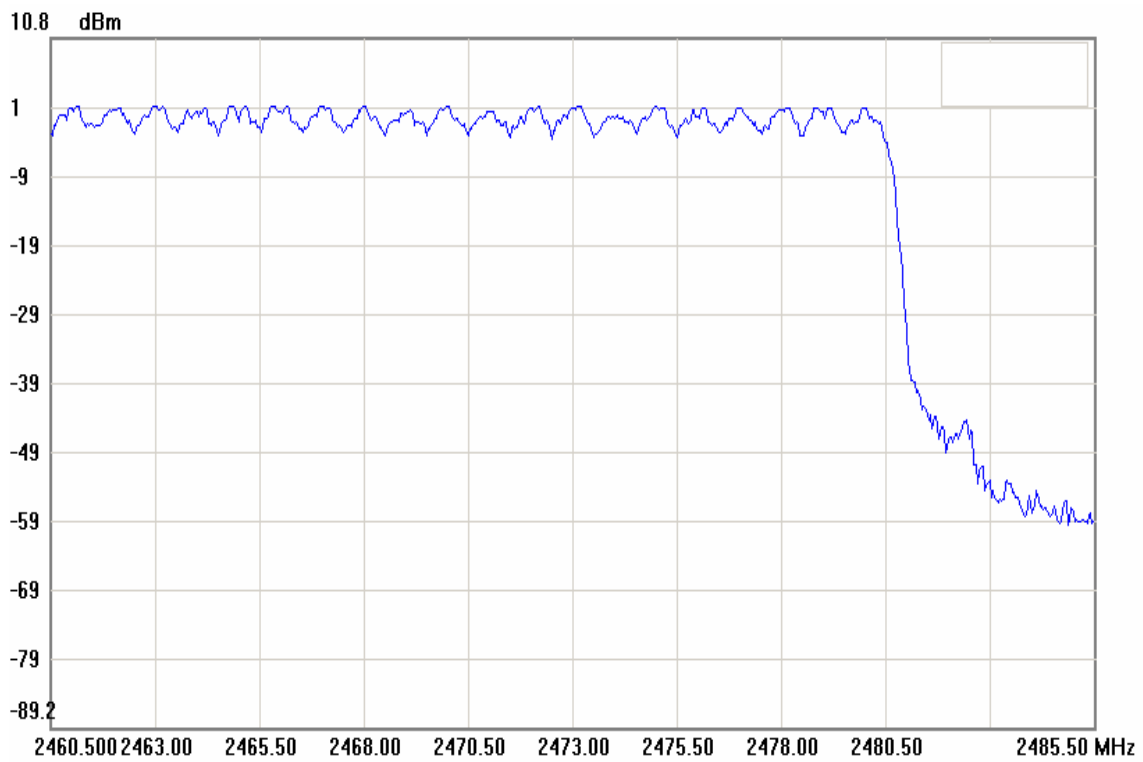
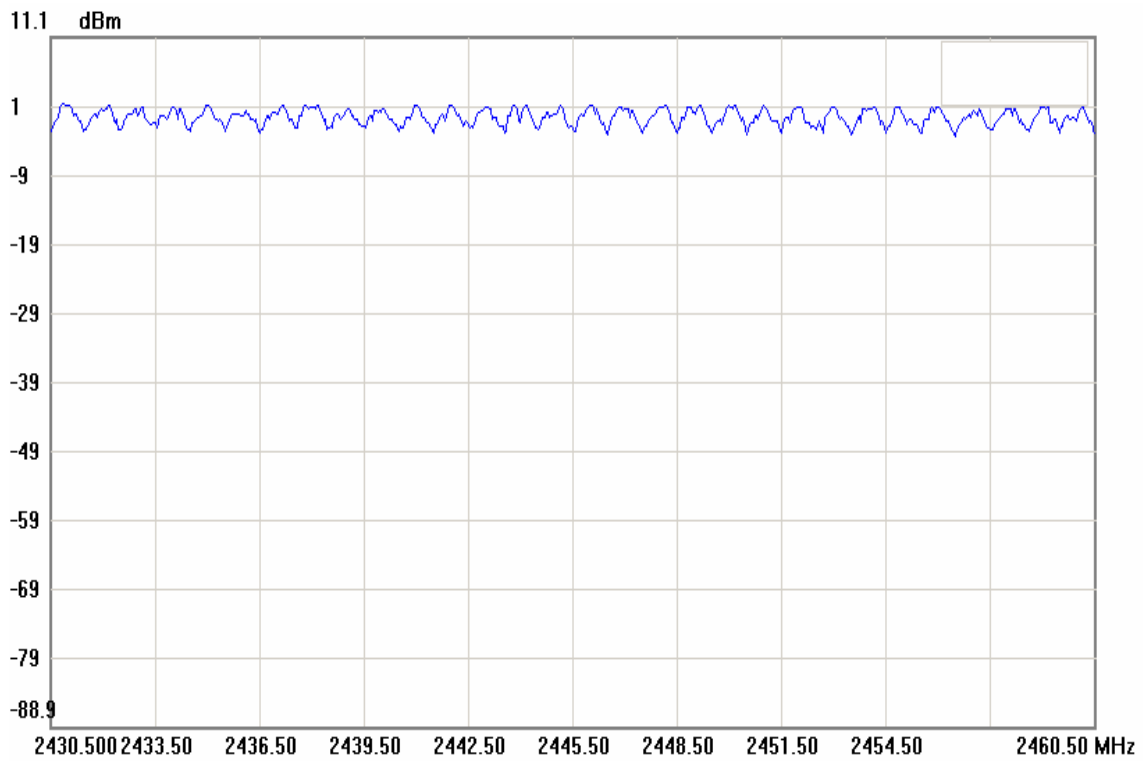



7.6 TIME OF OCCUPANCY (DWELL TIME)

LIMIT

According to §15.247(a)(1)(iii), Frequency hopping systems operating in the 2400MHz-2483.5 MHz bands. The average time of occupancy on any channels shall not greater than 0.4 s within a period 0.4 s multiplied by the number of hopping channels employed.

Test Configuration

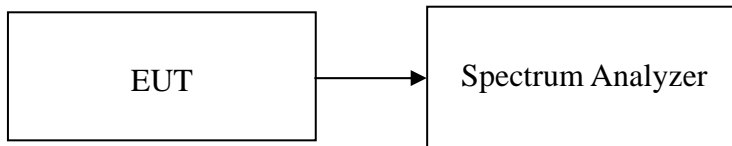

TEST PROCEDURE

1. Place the EUT on the table and set it in transmitting mode.
2. Remove the antenna from the EUT and then connect a low loss RF cable from the antenna port to the spectrum analyzer.
3. Set center frequency of spectrum analyzer = operating frequency.
4. Set the spectrum analyzer as RBW, VBW=1MHz, Span = 0Hz, Sweep = auto.
5. Repeat above procedures until all frequency measured were complete.



For GFSK

Test Data

DH 1: $0.4066 * (1600/2)/79 * 31.6 = 130.112$ (ms)

DH 3: $1.6700 * (1600/4)/79 * 31.6 = 267.200$ (ms)

DH 5: $2.9250 * (1600/6)/79 * 31.6 = 312.000$ (ms)

	Pulse Time (ms)	Total of Dwell (ms)	Period Time (s)	Limit (ms)	Result
DH 1	0.4066	130.112	31.60	400.00	PASS
DH 3	1.6700	267.200	31.60		PASS
DH 5	2.9250	312.000	31.60		PASS



Test Plot

DH 1

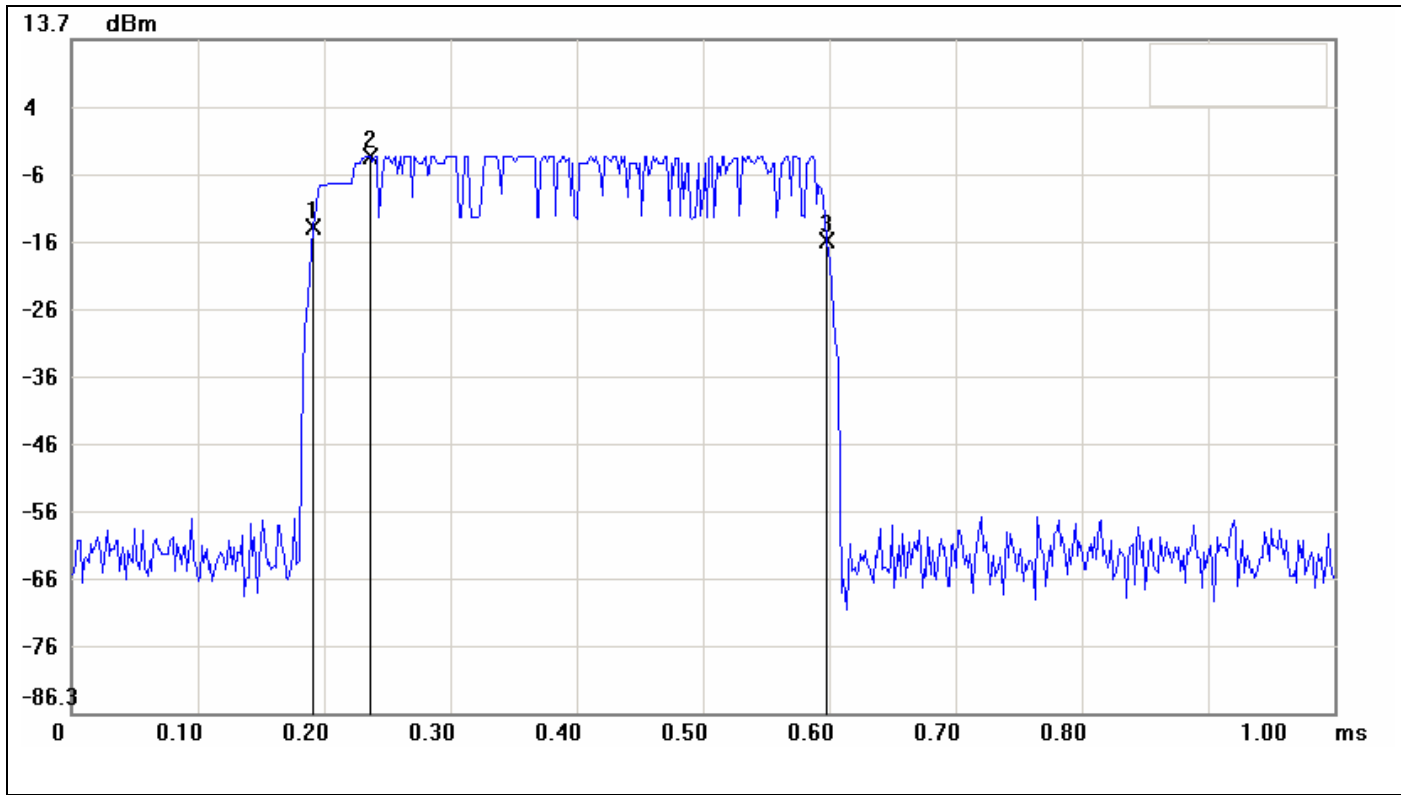

No.	Sweep time(ms)	Level(dBm)	Limit(dBm)	Margin(dBm)
1	0.1917	-14.14		
2	0.2367	-3.62		
3	0.5983	-16.19		

No.		Δ Time(ms)	Δ Level(dB)
1	mk3-mk1	0.4066	-2.05



DH 3

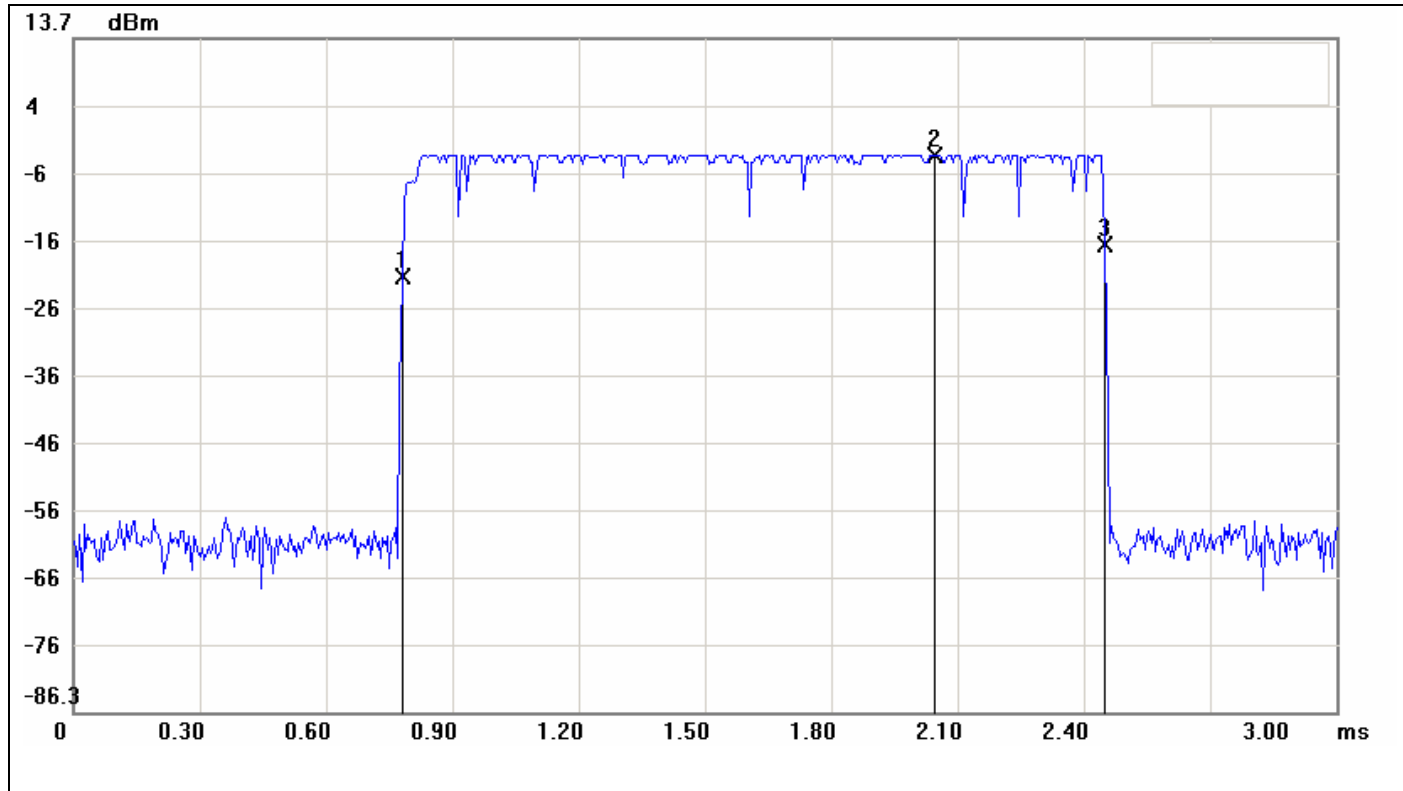

No.	Sweep time(ms)	Level(dBm)	Limit(dBm)	Margin(dBm)
1	0.7800	-21.84		
2	2.0450	-3.61		
3	2.4500	-17.02		

No.		Δ Time(ms)	Δ Level(dB)
1	mk3-mk1	1.67	4.82



DH 5

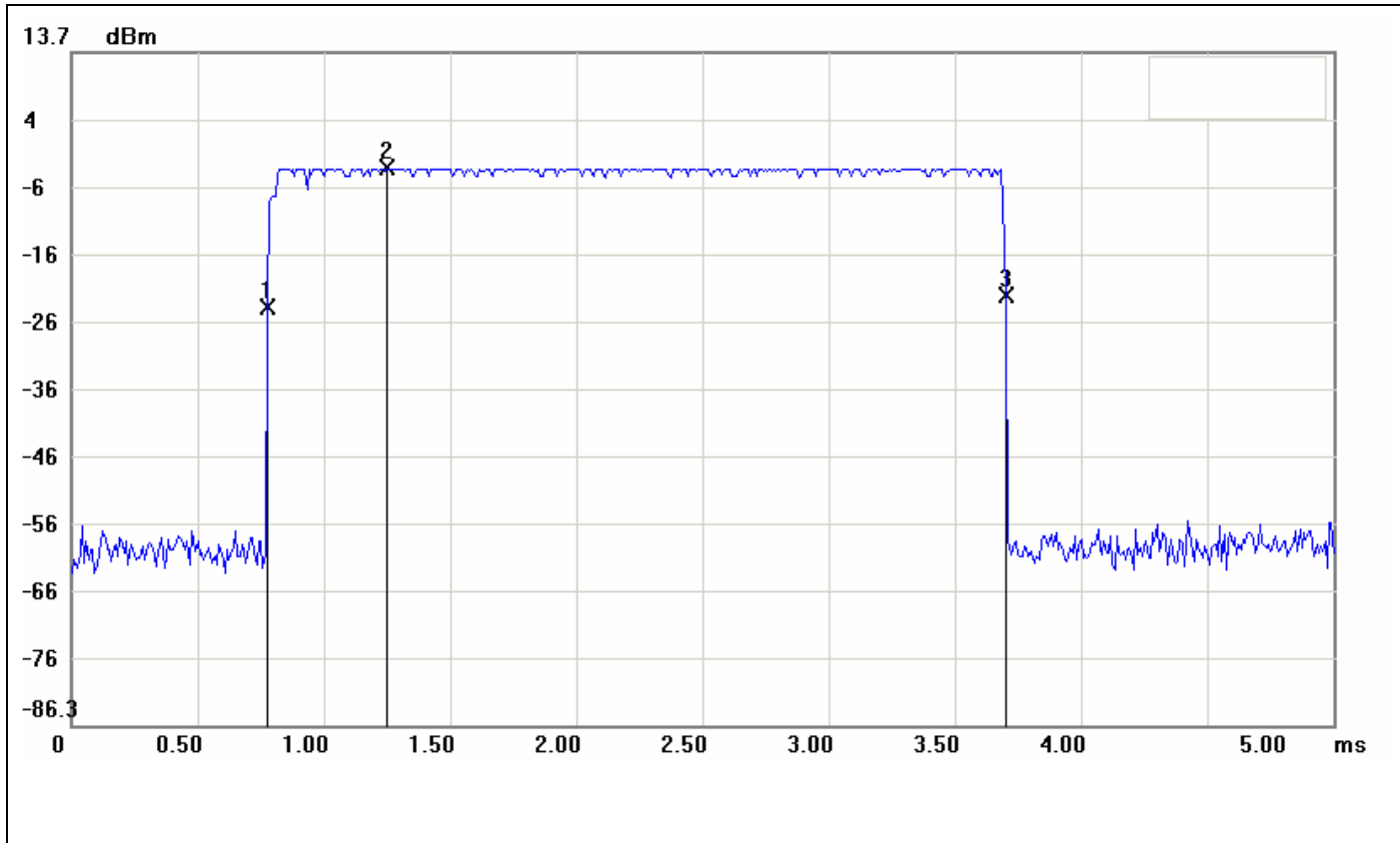

No.	Sweep time(ms)	Level(dBm)	Limit(dBm)	Margin(dBm)
1	0.7750	-24.16		
2	1.2500	-3.59		
3	3.7000	-22.49		

No.		Δ Time(ms)	Δ Level(dB)
1	mk3-mk1	2.925	1.67



For 8DPSK

Test Data

DH 1: $0.4167 * (1600/2)/79 * 31.6 = 133.344$ (ms)

DH 3: $1.6750 * (1600/4)/79 * 31.6 = 268.000$ (ms)

DH 5: $2.9333 * (1600/6)/79 * 31.6 = 312.885$ (ms)

	Pulse Time (ms)	Total of Dwell (ms)	Period Time (s)	Limit (ms)	Result
DH 1	0.4167	133.344	31.60	400.00	PASS
DH 3	1.6750	268.000	31.60		PASS
DH 5	2.9333	312.885	31.60		PASS



For 8DPSK

DH 1

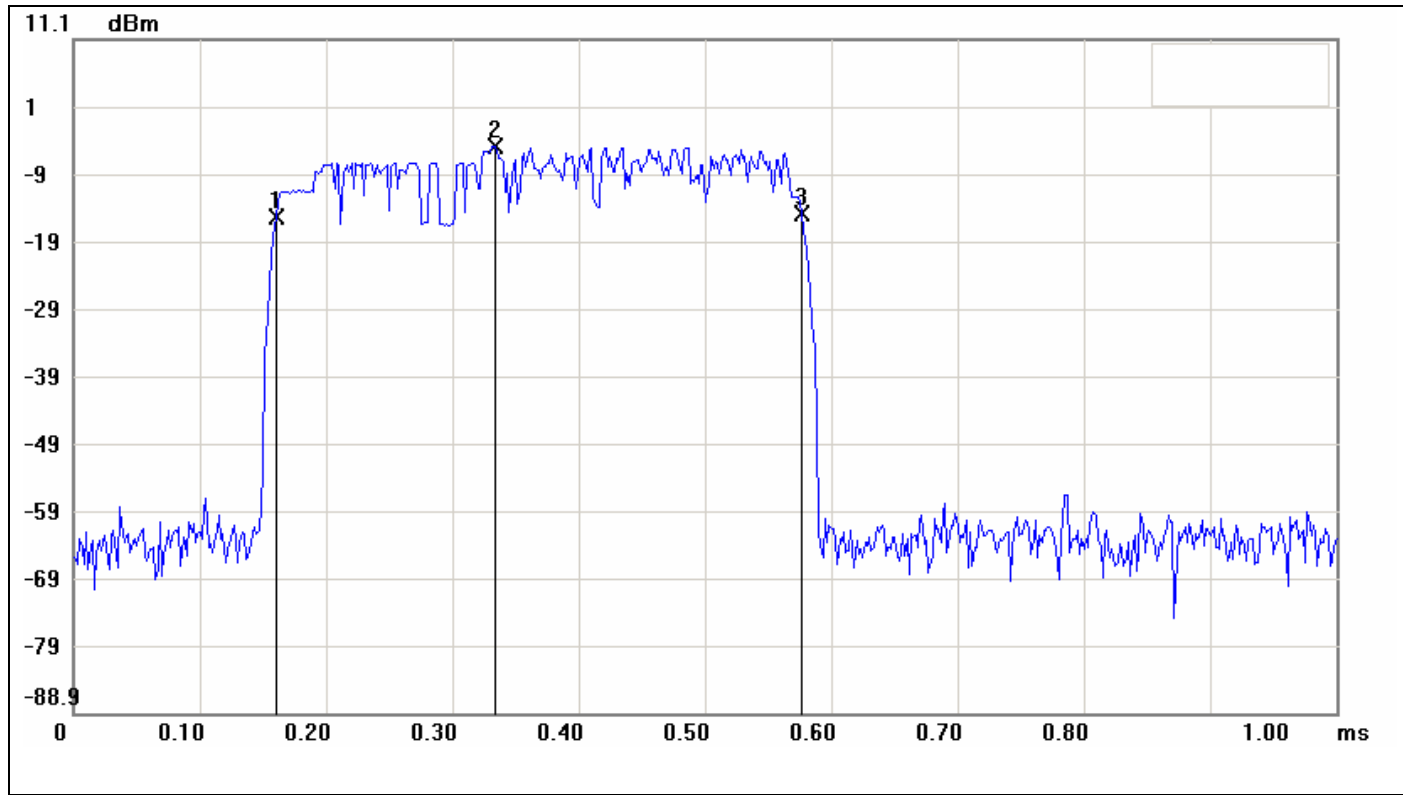

No.	Sweep time(ms)	Level(dBm)	Limit(dBm)	Margin(dBm)
1	0.1600	-15.20		
2	0.3333	-4.77		
3	0.5767	-14.78		

No.		Δ Time(ms)	Δ Level(dB)
1	mk3-mk1	0.4167	0.42



DH 3

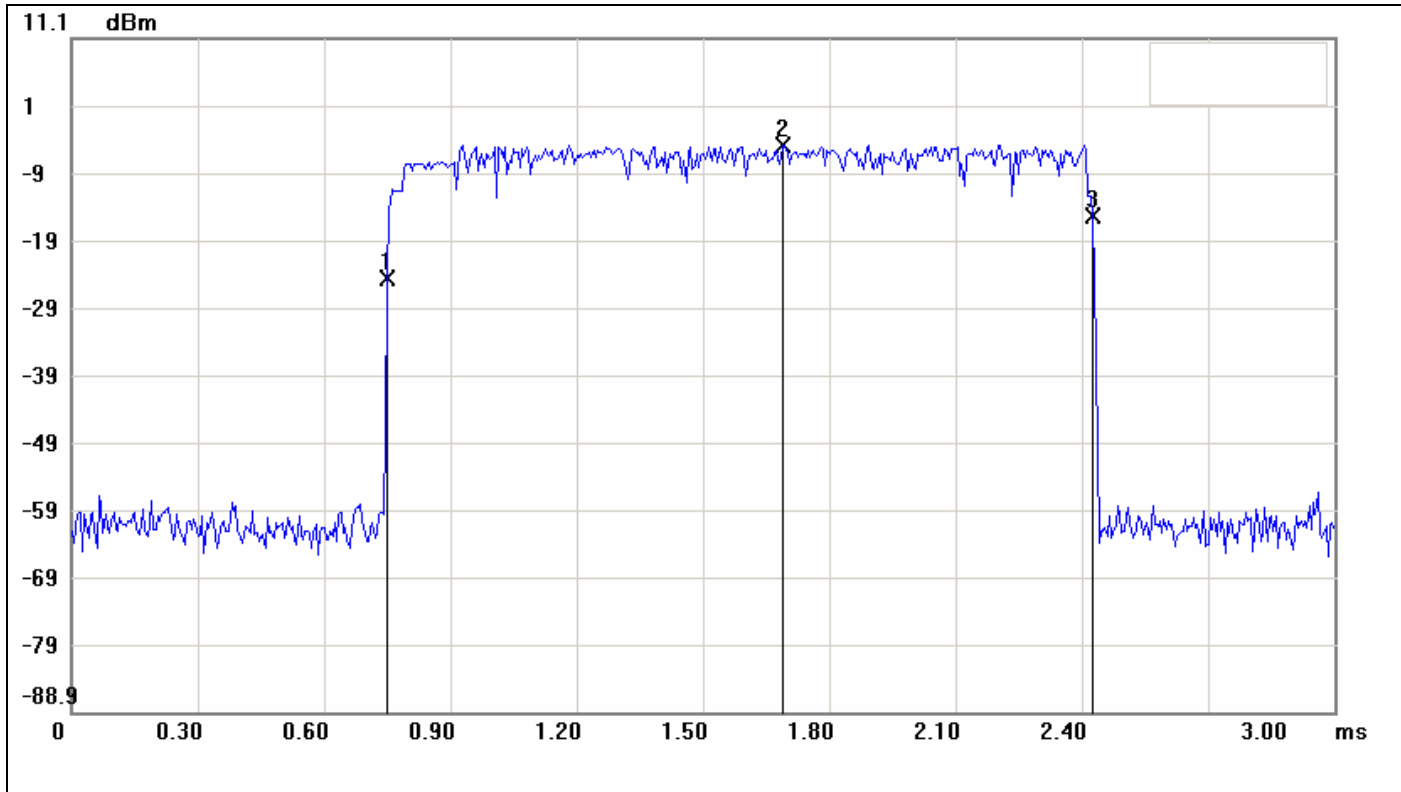

No.	Sweep time(ms)	Level(dBm)	Limit(dBm)	Margin(dBm)
1	0.7500	-24.56		
2	1.6900	-4.73		
3	2.4250	-15.21		

No.		Δ Time(ms)	Δ Level(dB)
1	mk3-mk1	1.675	9.35



DH 5

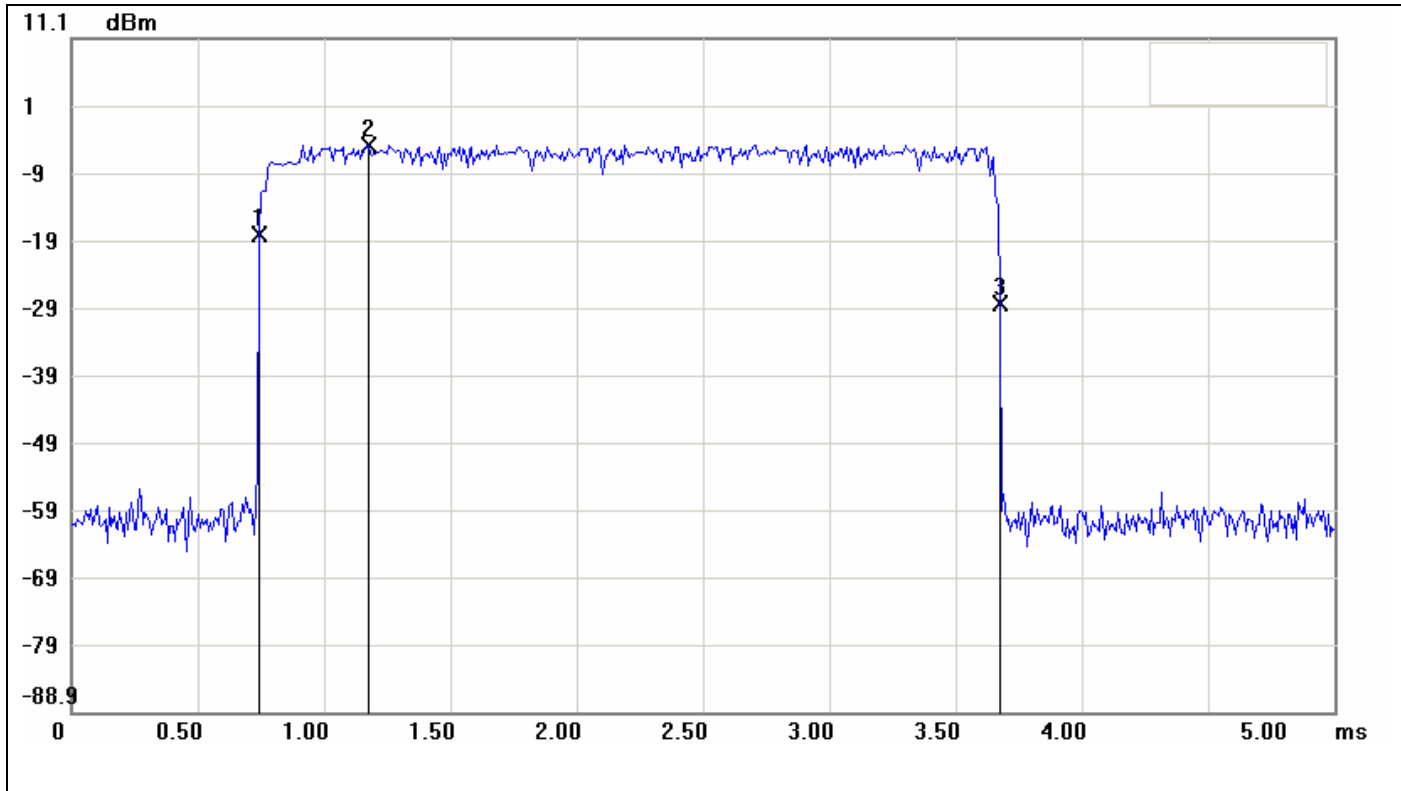

No.	Sweep time(ms)	Level(dBm)	Limit(dBm)	Margin(dBm)
1	0.7417	-18.13		
2	1.1750	-4.72		
3	3.6750	-28.19		

No.		Δ Time(ms)	Δ Level(dB)
1	mk3-mk1	2.9333	-10.06



7.7 SPURIOUS EMISSIONS

7.7.1 Radiated Emissions

LIMIT

1. According to §15.209(a), except as provided elsewhere in this Subpart, the emissions from an intentional radiator shall not exceed the field strength levels specified in the following table:

Frequency (MHz)	Field Strength ($\mu\text{V/m}$)	Measurement Distance (m)
30-88	100*	3
88-216	150*	3
216-960	200*	3
Above 960	500	3

Remark: Except as provided in paragraph (g), fundamental emissions from intentional radiators operating under this Section shall not be located in the frequency bands 54-72 MHz, 76-88 MHz, 174-216 MHz or 470-806 MHz. However, operation within these frequency bands is permitted under other sections of this Part, e.g., Sections 15.231 and 15.241.

2. In the emission table above, the tighter limit applies at the band edges.

Frequency (MHz)	Field Strength ($\mu\text{V/m}$ at 3-meter)	Field Strength (dB $\mu\text{V/m}$ at 3-meter)
30-88	100	40
88-216	150	43.5
216-960	200	46
Above 960	500	54



Test Configuration

9kHz ~ 30MHz

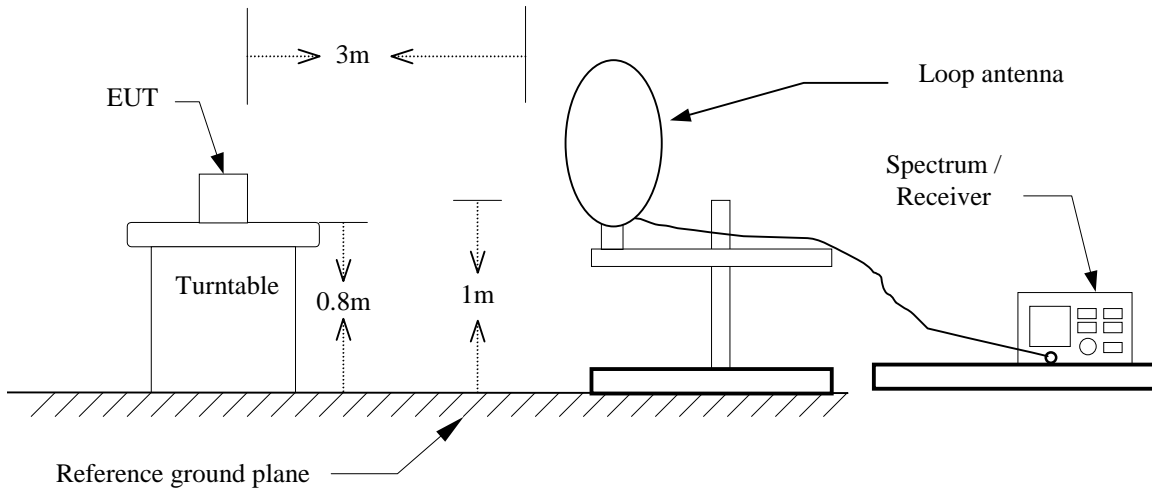

30MHz ~ 1GHz

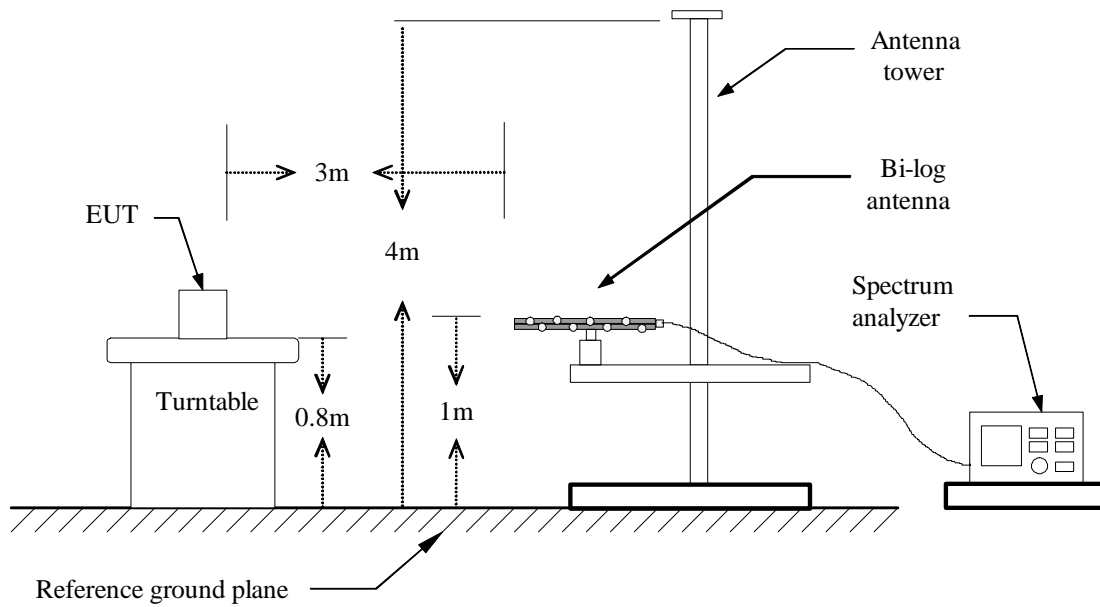



Above 1 GHz

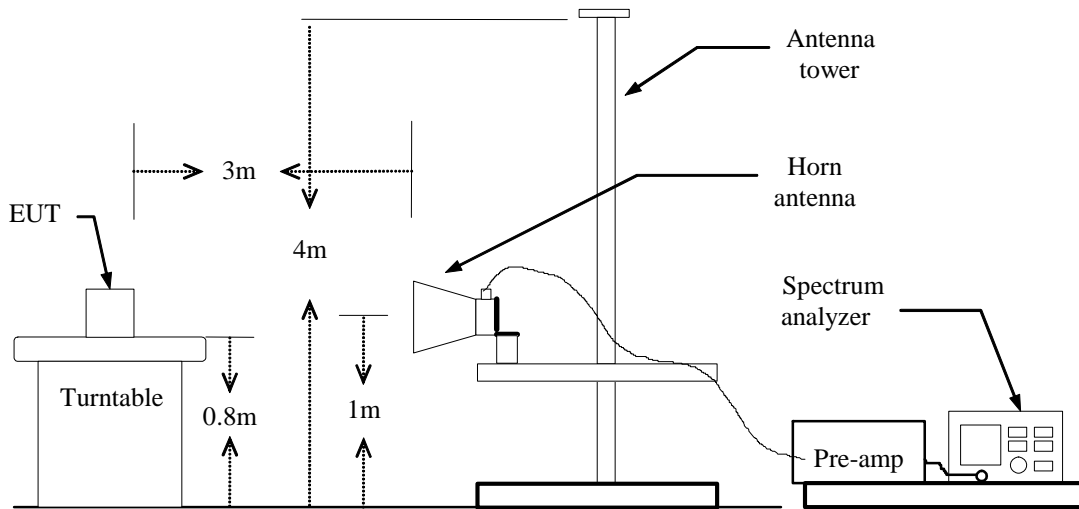



TEST PROCEDURE

1. The EUT is placed on a turntable, which is 0.8m above ground plane.
2. The turntable shall be rotated for 360 degrees to determine the position of maximum emission level.
3. EUT is set 3m away from the receiving antenna, which is varied from 1m to 4m to find out the highest emissions.
4. Maximum procedure was performed on the six highest emissions to ensure EUT compliance.
5. And also, each emission was to be maximized by changing the polarization of receiving antenna both horizontal and vertical.
6. Set the spectrum analyzer in the following setting as:
Below 1GHz:
RBW=100kHz / VBW=300kHz / Sweep=AUTO
Above 1GHz:
(a) PEAK: RBW=VBW=1MHz / Sweep=AUTO
(b) AVERAGE: RBW=1MHz / VBW=10Hz / Sweep=AUTO
7. Repeat above procedures until the measurements for all frequencies are complete.



Below 1 GHz

Operation Mode: Normal Link

Test Date: November 22, 2011

Temperature: 25°C

Tested by: Sehni Hu

Humidity: 50% RH

Polarity: Ver. / Hor.

Frequency (MHz)	Reading (dBuV)	Correction Factor (dB/m)	Result (dBuV/m)	Limit (dBuV/m)	Margin (dB)	Remark	Ant.Pol. (H/V)
63.95	49.20	-17.23	31.97	40.00	-8.03	Peak	V
120.53	41.80	-11.44	30.36	43.50	-13.14	Peak	V
248.25	44.75	-12.93	31.81	46.00	-14.19	Peak	V
288.67	41.56	-11.05	30.51	46.00	-15.49	Peak	V
384.05	41.90	-9.58	32.31	46.00	-13.69	Peak	V
584.52	44.07	-6.98	37.09	46.00	-8.91	Peak	V
232.08	51.74	-13.26	38.48	46.00	-7.52	Peak	H
248.25	49.01	-12.93	36.08	46.00	-9.92	Peak	H
256.33	53.18	-12.44	40.74	46.00	-5.26	Peak	H
319.38	51.86	-10.56	41.30	46.00	-4.70	Peak	H
384.05	47.89	-9.58	38.31	46.00	-7.69	Peak	H
392.13	46.22	-9.45	36.77	46.00	-9.23	Peak	H

Remark:

1. No emission found between lowest internal used/generated frequency to 30MHz (9kHz~30MHz).
2. Radiated emissions measured were made with an instrument using peak/quasi-peak detector mode.
3. Quasi-peak test would be performed if the peak result were greater than the quasi-peak limit or as required by the applicant.
4. Measurements above show only up to 6 maximum emissions noted, or would be lesser; with " N/A " remark, if no specific emissions from the EUT are recorded (ie: margin>20dB from the applicable limit) and considered that's already beyond the background noise floor.
5. Margin (dB) = Remark result (dBuV/m) – Quasi-peak limit (dBuV/m).



Above 1 GHz

Operation Mode: TX / GFSK / DH5 / CH Low

Test Date: November 22, 2011

Temperature: 25°C

Tested by: Sehni Hu

Humidity: 50% RH

Polarity: Ver. / Hor.

Frequency (MHz)	Reading (Peak) (dBuV)	Reading (Average) (dBuV)	Correction Factor (dB/m)	Result (Peak) (dBuV/m)	Result (Average) (dBuV/m)	Limit (Peak) (dBuV/m)	Limit (Average) (dBuV/m)	Margin (dB)	Remark	Ant.Pol. (H/V)
1603.33	54.00	---	-9.50	44.50	---	74.00	54.00	-9.50	Peak	V
4800.00	56.17	46.15	2.56	58.73	48.71	74.00	54.00	-5.29	AVG	V
N/A										
2146.67	51.61	---	-5.09	46.52	---	74.00	54.00	-7.48	Peak	H
4800.00	55.43	48.83	2.56	57.99	51.39	74.00	54.00	-2.61	AVG	H
N/A										

Remark:

1. Measuring frequencies from 1 GHz to the 10th harmonic of highest fundamental frequency.
2. Radiated emissions measured in frequency above 1000MHz were made with an instrument using peak/average detector mode.
3. Average test would be performed if the peak result were greater than the average limit.
4. Data of measurement within this frequency range shown “ --- ” in the table above means the reading of emissions are attenuated more than 20dB below the permissible limits or the field strength is too small to be measured.
5. Measurements above show only up to 6 maximum emissions noted, or would be lesser, with “ N/A ” remark, if no specific emissions from the EUT are recorded (ie: margin>20dB from the applicable limit) and considered that's already beyond the background noise floor.
6. Margin (dB) = Remark result (dBuV/m) – Average limit (dBuV/m).



Operation Mode: TX / GFSK / DH5 / CH Mid

Test Date: November 22, 2011

Temperature: 25°C

Tested by: Sehni Hu

Humidity: 50% RH

Polarity: Ver. / Hor.

Frequency (MHz)	Reading (Peak) (dBuV)	Reading (Average) (dBuV)	Correction Factor (dB/m)	Result (Peak) (dBuV/m)	Result (Average) (dBuV/m)	Limit (Peak) (dBuV/m)	Limit (Average) (dBuV/m)	Margin (dB)	Remark	Ant.Pol. (H/V)
1626.67	54.57	---	-9.26	45.31	---	74.00	54.00	-8.69	Peak	V
4883.33	49.90	44.19	2.73	52.62	46.92	74.00	54.00	-7.08	AVG	V
N/A										
1680.00	51.67	---	-8.72	42.95	---	74.00	54.00	-11.05	Peak	H
4883.33	57.73	50.21	2.73	60.46	52.94	74.00	54.00	-1.06	AVG	H
N/A										

Remark:

1. Measuring frequencies from 1 GHz to the 10th harmonic of highest fundamental frequency.
2. Radiated emissions measured in frequency above 1000MHz were made with an instrument using peak/average detector mode.
3. Average test would be performed if the peak result were greater than the average limit.
4. Data of measurement within this frequency range shown " --- " in the table above means the reading of emissions are attenuated more than 20dB below the permissible limits or the field strength is too small to be measured.
5. Measurements above show only up to 6 maximum emissions noted, or would be lesser, with " N/A " remark, if no specific emissions from the EUT are recorded (ie: margin > 20dB from the applicable limit) and considered that's already beyond the background noise floor.
6. Margin (dB) = Remark result (dBuV/m) – Average limit (dBuV/m).



Operation Mode: TX / GFSK / DH5 / CH High

Test Date: November 22, 2011

Temperature: 25°C

Tested by: Sehni Hu

Humidity: 50% RH

Polarity: Ver. / Hor.

Frequency (MHz)	Reading (Peak) (dBuV)	Reading (Average) (dBuV)	Correction Factor (dB/m)	Result (Peak) (dBuV/m)	Result (Average) (dBuV/m)	Limit (Peak) (dBuV/m)	Limit (Average) (dBuV/m)	Margin (dB)	Remark	Ant.Pol. (H/V)
1653.33	56.64	---	-8.99	47.65	---	74.00	54.00	-6.35	Peak	V
4958.33	52.34	45.96	2.88	55.22	48.84	74.00	54.00	-5.16	AVG	V
N/A										
1653.33	52.65	---	-8.99	43.66	---	74.00	54.00	-10.34	Peak	H
4958.33	52.40	46.64	2.88	55.27	49.52	74.00	54.00	-4.48	AVG	H
N/A										

Remark:

1. Measuring frequencies from 1 GHz to the 10th harmonic of highest fundamental frequency.
2. Radiated emissions measured in frequency above 1000MHz were made with an instrument using peak/average detector mode.
3. Average test would be performed if the peak result were greater than the average limit.
4. Data of measurement within this frequency range shown " --- " in the table above means the reading of emissions are attenuated more than 20dB below the permissible limits or the field strength is too small to be measured.
5. Measurements above show only up to 6 maximum emissions noted, or would be lesser, with " N/A " remark, if no specific emissions from the EUT are recorded (ie: margin > 20dB from the applicable limit) and considered that's already beyond the background noise floor.
6. Margin (dB) = Remark result (dBuV/m) – Average limit (dBuV/m).



Operation Mode: TX / 8DPSK / DH5 / CH Low

Test Date: November 22, 2011

Temperature: 25°C

Tested by: Sehni Hu

Humidity: 50% RH

Polarity: Ver. / Hor.

Frequency (MHz)	Reading (Peak) (dBuV)	Reading (Average) (dBuV)	Correction Factor (dB/m)	Result (Peak) (dBuV/m)	Result (Average) (dBuV/m)	Limit (Peak) (dBuV/m)	Limit (Average) (dBuV/m)	Margin (dB)	Remark	Ant.Pol. (H/V)
1603.33	55.50	---	-9.50	46.00	---	74.00	54.00	-8.00	Peak	V
N/A										
1946.67	51.90	---	-6.01	45.89	---	74.00	54.00	-8.11	Peak	H
4808.33	53.15	43.53	2.58	55.73	46.11	74.00	54.00	-7.89	AVG	H
N/A										

Remark:

1. Measuring frequencies from 1 GHz to the 10th harmonic of highest fundamental frequency.
2. Radiated emissions measured in frequency above 1000MHz were made with an instrument using peak/average detector mode.
3. Average test would be performed if the peak result were greater than the average limit.
4. Data of measurement within this frequency range shown " --- " in the table above means the reading of emissions are attenuated more than 20dB below the permissible limits or the field strength is too small to be measured.
5. Measurements above show only up to 6 maximum emissions noted, or would be lesser, with " N/A " remark, if no specific emissions from the EUT are recorded (ie: margin>20dB from the applicable limit) and considered that's already beyond the background noise floor.
6. Margin (dB) = Remark result (dBuV/m) – Average limit (dBuV/m).



Operation Mode: TX / 8DPSK / DH5 / CH Mid

Test Date: November 22, 2011

Temperature: 25°C

Tested by: Sehni Hu

Humidity: 50% RH

Polarity: Ver. / Hor.

Frequency (MHz)	Reading (Peak) (dBuV)	Reading (Average) (dBuV)	Correction Factor (dB/m)	Result (Peak) (dBuV/m)	Result (Average) (dBuV/m)	Limit (Peak) (dBuV/m)	Limit (Average) (dBuV/m)	Margin (dB)	Remark	Ant.Pol. (H/V)
1626.67	55.25	---	-9.26	45.99	---	74.00	54.00	-8.01	Peak	V
4883.33	48.68	---	2.73	51.40	---	74.00	54.00	-2.60	Peak	V
N/A										
1943.33	51.23	---	-6.05	45.18	---	74.00	54.00	-8.82	Peak	H
4883.33	55.07	44.57	2.73	57.80	47.30	74.00	54.00	-6.70	AVG	H
N/A										

Remark:

1. Measuring frequencies from 1 GHz to the 10th harmonic of highest fundamental frequency.
2. Radiated emissions measured in frequency above 1000MHz were made with an instrument using peak/average detector mode.
3. Average test would be performed if the peak result were greater than the average limit.
4. Data of measurement within this frequency range shown " --- " in the table above means the reading of emissions are attenuated more than 20dB below the permissible limits or the field strength is too small to be measured.
5. Measurements above show only up to 6 maximum emissions noted, or would be lesser, with " N/A " remark, if no specific emissions from the EUT are recorded (ie: margin>20dB from the applicable limit) and considered that's already beyond the background noise floor.
6. Margin (dB) = Remark result (dBuV/m) – Average limit (dBuV/m).



Operation Mode: TX / 8DPSK / DH5 / CH High

Test Date: November 22, 2011

Temperature: 25°C

Tested by: Sehni Hu

Humidity: 50% RH

Polarity: Ver. / Hor.

Frequency (MHz)	Reading (Peak) (dBuV)	Reading (Average) (dBuV)	Correction Factor (dB/m)	Result (Peak) (dBuV/m)	Result (Average) (dBuV/m)	Limit (Peak) (dBuV/m)	Limit (Average) (dBuV/m)	Margin (dB)	Remark	Ant.Pol. (H/V)
1653.33	56.80	---	-8.99	47.80	---	74.00	54.00	-6.20	Peak	V
4850.00	46.86	---	2.66	49.52	---	74.00	54.00	-4.48	Peak	V
N/A										
1653.33	53.59	---	-8.99	44.59	---	74.00	54.00	-9.41	Peak	H
4800.00	52.56	43.52	2.56	55.12	46.08	74.00	54.00	-7.92	AVG	H
N/A										

Remark:

1. Measuring frequencies from 1 GHz to the 10th harmonic of highest fundamental frequency.
2. Radiated emissions measured in frequency above 1000MHz were made with an instrument using peak/average detector mode.
3. Average test would be performed if the peak result were greater than the average limit.
4. Data of measurement within this frequency range shown " --- " in the table above means the reading of emissions are attenuated more than 20dB below the permissible limits or the field strength is too small to be measured.
5. Measurements above show only up to 6 maximum emissions noted, or would be lesser, with " N/A " remark, if no specific emissions from the EUT are recorded (ie: margin > 20dB from the applicable limit) and considered that's already beyond the background noise floor.
6. Margin (dB) = Remark result (dBuV/m) – Average limit (dBuV/m).



7.8 POWERLINE CONDUCTED EMISSIONS

LIMIT

According to §15.207(a), except as shown in paragraphs (b) and (c) of this section, for an intentional radiator that is designed to be connected to the public utility (AC) power line, the radio frequency voltage that is conducted back onto the AC power line on any frequency or frequencies within the band 150 kHz to 30 MHz shall not exceed the limits in the following table, as measured using a 50 μ H/50 ohms line impedance stabilization network (LISN). Compliance with the provisions of this paragraph shall be based on the measurement of the radio frequency voltage between each power line and ground at the power terminal. The lower limit applies at the boundary between the frequency ranges.

Frequency Range (MHz)	Limits (dB μ V)	
	Quasi-peak	Average
0.15 to 0.50	66 to 56*	56 to 46*
0.50 to 5	56	46
5 to 30	60	50

* Decreases with the logarithm of the frequency.

Test Configuration

See test photographs attached in Appendix II for the actual connections between EUT and support equipment.

TEST PROCEDURE

1. The EUT was placed on a table, which is 0.8m above ground plane.
2. Maximum procedure was performed on the six highest emissions to ensure EUT compliance.
3. Repeat above procedures until all frequency measured were complete.



TEST RESULTS

The initial step in collecting conducted data is a spectrum analyzer peak scan of the measurement range. Significant peaks are then marked as shown on the following data page, and these signals are then quasi-peaked.

Test Data

Operation Mode: Normal Link

Test Date: October 21, 2011

Temperature: 26°C

Tested by: David Shi

Humidity: 60% RH

Freq. (MHz)	QP Reading (dBuV)	AV Reading (dBuV)	Corr. factor (dB)	QP Result (dBuV)	AV Result (dBuV)	QP Limit (dBuV)	AV Limit (dBuV)	QP Margin (dB)	AV Margin (dB)	Note
0.1818	18.49	12.40	0.16	18.65	12.56	64.40	54.40	-45.75	-41.84	L1
0.2283	0.40	-3.35	0.16	0.56	-3.19	62.51	52.51	-61.95	-55.70	L1
0.6491	16.11	12.33	0.16	16.27	12.49	56.00	46.00	-39.73	-33.51	L1
0.7669	12.77	8.84	0.17	12.94	9.01	56.00	46.00	-43.06	-36.99	L1
2.6767	9.73	3.69	0.22	9.95	3.91	56.00	46.00	-46.05	-42.09	L1
3.6605	7.71	0.87	0.26	7.97	1.13	56.00	46.00	-48.03	-44.87	L1
0.6485	14.97	12.11	0.25	15.22	12.36	56.00	46.00	-40.78	-33.64	L2
0.7740	3.15	-0.73	0.26	3.41	-0.47	56.00	46.00	-52.59	-46.47	L2
2.6435	8.74	2.66	0.28	9.02	2.94	56.00	46.00	-46.98	-43.06	L2
3.6630	7.89	0.96	0.30	8.19	1.26	56.00	46.00	-47.81	-44.74	L2
11.0708	0.28	-4.91	0.47	0.75	-4.44	60.00	50.00	-59.25	-54.44	L2
11.0708	0.08	-5.04	0.47	0.55	-4.57	60.00	50.00	-59.45	-54.57	L2

Remark:

1. Measuring frequencies from 0.15 MHz to 30MHz.
2. The emissions measured in frequency range from 0.15 MHz to 30MHz were made with an instrument using Quasi-peak detector and average detector.
3. The IF bandwidth of SPA between 0.15MHz and 30MHz was 10kHz; the IF bandwidth of Test Receiver between 0.15MHz and 30MHz was 9kHz;
4. L1 = Line One (Live Line) / L2 = Line Two (Neutral Line)



Test Plots

Conducted emissions (Line 1)

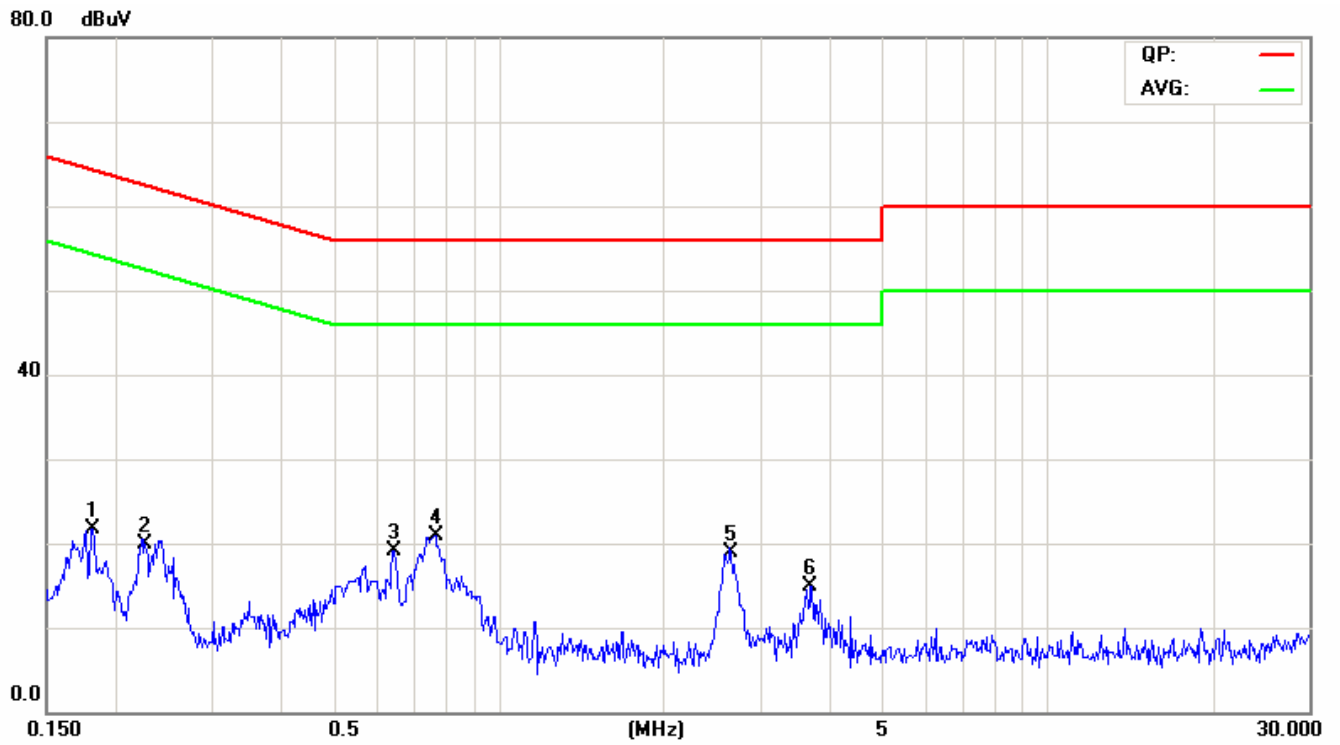

Conducted emissions (Line 2)

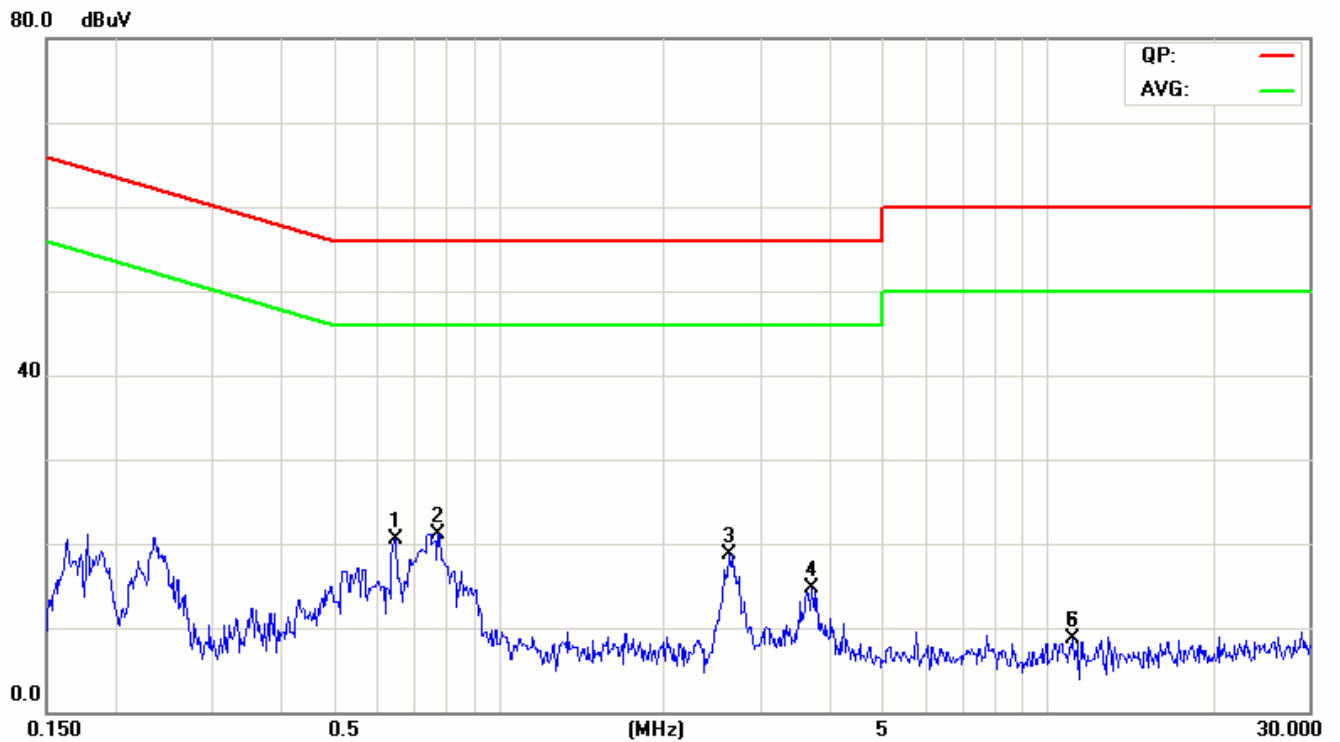



APPENDIX I RADIO FREQUENCY EXPOSURE

LIMIT

According to §15.247(i), systems operating under the provisions of this section shall be operated in a manner that ensures that the public is not exposed to radio frequency energy levels in excess of the Commission's guidelines. See § 1.1307(b)(1) of this chapter.

EUT Specification

EUT	SF600
Frequency band (Operating)	<input type="checkbox"/> WLAN: 2.412GHz ~ 2.462GHz <input type="checkbox"/> WLAN: 5.18GHz ~ 5.32GHz / 5.50GHz ~ 5.70GHz <input type="checkbox"/> WLAN: 5.745GHz ~ 5.825GHz <input checked="" type="checkbox"/> Others: <u>Bluetooth: 2.402GHz ~ 2.480GHz</u>
Device category	<input checked="" type="checkbox"/> Portable (<20cm separation) <input type="checkbox"/> Mobile (>20cm separation) <input type="checkbox"/> Others _____
Exposure classification	<input type="checkbox"/> Occupational/Controlled exposure ($S = 5mW/cm^2$) <input checked="" type="checkbox"/> General Population/Uncontrolled exposure ($S=1mW/cm^2$)
Antenna diversity	<input checked="" type="checkbox"/> Single antenna <input type="checkbox"/> Multiple antennas <input type="checkbox"/> Tx diversity <input type="checkbox"/> Rx diversity <input type="checkbox"/> Tx/Rx diversity
Max. output power	5.15 dBm (3.27 mW)
Antenna gain (Max)	-6.65 dBi (Numeric gain: 0.22)
Evaluation applied	<input type="checkbox"/> MPE Evaluation <input type="checkbox"/> SAR Evaluation <input checked="" type="checkbox"/> N/A*
Remark: <i>The maximum output power is <u>5.15dBm (3.27mW) at 2402MHz</u> (with <u>0.22 numeric antenna gain.</u>)</i>	

TEST RESULTS

No non-compliance noted.

(SAR evaluation is not required for the PORTABLE device while its maximum output power is lower than the general population low threshold: $60/f_{(GHz)}=60/2.441=24.58mW$)

MPE EVALUATION

Not applicable.