



FCC TEST REPORT

REPORT NO.: RF980624L24

MODEL NO.: GC450

RECEIVED: Jun. 22, 2009

TESTED: Aug. 01 ~ Aug. 03, 2009

ISSUED: Aug. 05, 2009

APPLICANT: Motorola, Inc.

ADDRESS: 600 NORTH US HIGHWAY 45 LIBERTYVILLE,
IL 60048

ISSUED BY: Bureau Veritas Consumer Products Services
(H.K.) Ltd., Taoyuan Branch

LAB ADDRESS: No. 47, 14th Ling, Chia Pau Tsuen, Lin Kou
Hsiang, Taipei Hsien 244, Taiwan, R.O.C.

TEST LOCATION: No. 19, Hwa Ya 2nd Rd, Wen Hwa Tsuen, Kwei
Shan Hsiang, Taoyuan Hsien 333, Taiwan,
R.O.C.

This test report consists of 62 pages in total. It may be duplicated completely for legal use with the approval of the applicant. It should not be reproduced except in full, without the written approval of our laboratory. The client should not use it to claim product endorsement by TAF or any government agencies. The test results in the report only apply to the tested sample.





TABLE OF CONTENTS

1.	CERTIFICATION	4
2.	SUMMARY OF TEST RESULTS	5
2.1	MEASUREMENT UNCERTAINTY	5
3.	GENERAL INFORMATION	6
3.1	GENERAL DESCRIPTION OF EUT	6
3.2	DESCRIPTION OF TEST MODES	7
3.2.1	CONFIGURATION OF SYSTEM UNDER TEST	7
3.2.2	TEST MODE APPLICABILITY AND TESTED CHANNEL DETAIL	8
3.3	GENERAL DESCRIPTION OF APPLIED STANDARDS	10
3.4	DESCRIPTION OF SUPPORT UNITS	10
4.	TEST TYPES AND RESULTS	11
4.1	RADIATED EMISSION MEASUREMENT	11
4.1.1	LIMITS OF RADIATED EMISSION MEASUREMENT	11
4.1.2	TEST INSTRUMENTS	12
4.1.3	TEST PROCEDURES	13
4.1.4	DEVIATION FROM TEST STANDARD	13
4.1.5	TEST SETUP	14
4.1.6	EUT OPERATING CONDITIONS	14
4.1.7	TEST RESULTS	15
4.2	NUMBER OF HOPPING FREQUENCY USED	24
4.2.1	LIMIT OF HOPPING FREQUENCY USED	24
4.2.2	TEST INSTRUMENTS	24
4.2.3	TEST PROCEDURES	24
4.2.4	DEVIATION FROM TEST STANDARD	25
4.2.5	TEST SETUP	25
4.2.6	TEST RESULTS	25
4.3	DWELL TIME ON EACH CHANNEL	28
4.3.1	LIMIT OF DWELL TIME USED	28
4.3.2	TEST INSTRUMENTS	28
4.3.3	TEST PROCEDURES	28
4.3.4	DEVIATION FROM TEST STANDARD	28
4.3.5	TEST SETUP	28
4.3.6	TEST RESULTS	29
4.4	CHANNEL BANDWIDTH	37
4.4.1	LIMITS OF CHANNEL BANDWIDTH	37
4.4.2	TEST INSTRUMENTS	37
4.4.3	TEST PROCEDURE	37
4.4.4	DEVIATION FROM TEST STANDARD	37
4.4.5	TEST SETUP	37
4.4.6	EUT OPERATING CONDITION	37
4.4.7	TEST RESULTS	38
4.5	HOPPING CHANNEL SEPARATION	42
4.5.1	LIMIT OF HOPPING CHANNEL SEPARATION	42
4.5.2	TEST INSTRUMENTS	42
4.5.3	TEST PROCEDURES	42
4.5.4	DEVIATION FROM TEST STANDARD	42
4.5.5	TEST SETUP	42
4.5.6	TEST RESULTS	43



A D T

4.6	MAXIMUM PEAK OUTPUT POWER	47
4.6.1	LIMITS OF MAXIMUM PEAK OUTPUT POWER MEASUREMENT	47
4.6.2	TEST INSTRUMENTS	47
4.6.3	TEST PROCEDURES	47
4.6.4	DEVIATION FROM TEST STANDARD	47
4.6.5	TEST SETUP	47
4.6.6	EUT OPERATING CONDITION	47
4.6.7	TEST RESULTS	48
4.7	BAND EDGES MEASUREMENT	52
4.7.1	LIMITS OF BAND EDGES MEASUREMENT	52
4.7.2	TEST INSTRUMENTS	52
4.7.3	TEST PROCEDURE	52
4.7.4	DEVIATION FROM TEST STANDARD	52
4.7.5	EUT OPERATING CONDITION	52
4.7.6	TEST RESULTS	53
4.8	ANTENNA REQUIREMENT	59
4.8.1	STANDARD APPLICABLE	59
4.8.2	ANTENNA CONNECTED CONSTRUCTION	59
5.	PHOTOGRAPHS OF THE TEST CONFIGURATION	60
6.	INFORMATION ON THE TESTING LABORATORIES	61
7.	APPENDIX A - MODIFICATIONS RECORDERS FOR ENGINEERING CHANGES TO THE EUT BY THE LAB	62



1. CERTIFICATION

PRODUCT: GPS Navigation Device
MODEL NO.: GC450
BRAND: Motorola
APPLICANT: Motorola, Inc.
TESTED: Aug. 01 ~ Aug. 03, 2009
TEST SAMPLE: ENGINEERING SAMPLE
STANDARDS: **FCC Part 15, Subpart C (Section 15.247)**
ANSI C63.4-2003

The above equipment (model: GC450) has been tested by **Bureau Veritas Consumer Products Services (H.K.) Ltd., Taoyuan Branch**, and found compliance with the requirement of the above standards. The test record, data evaluation & Equipment Under Test (EUT) configurations represented herein are true and accurate accounts of the measurements of the sample's EMC characteristics under the conditions specified in this report.

PREPARED BY : Andrea Hsia **DATE:** Aug. 05, 2009
Andrea Hsia / Specialist

TECHNICAL ACCEPTANCE : Long Chen **DATE:** Aug. 05, 2009
Responsible for RF Long Chen / Senior Engineer

APPROVED BY : Gary Chang **DATE:** Aug. 05, 2009
Gary Chang / Assistant Manager

2. SUMMARY OF TEST RESULTS

The EUT has been tested according to the following specifications:

APPLIED STANDARD: FCC Part 15, Subpart C			
STANDARD SECTION	TEST TYPE AND LIMIT	RESULT	REMARK
15.207	AC Power Conducted Emission	NA	Power supply is 5.4Vdc from car charger or 3.7Vdc from battery
15.247(a)(1)(iii)	Number of Hopping Frequency Used Spec.: At least 15 channels	PASS	Meet the requirement of limit.
15.247(a)(1)(iii)	Dwell Time on Each Channel Spec.: Max. 0.4 second within 31.6 second	PASS	Meet the requirement of limit.
15.247(a)(1)	1. Hopping Channel Separation Spec. : Min. 25 kHz or $\frac{2}{3}$ *20 dB bandwidth, whichever is greater 2. Spectrum Bandwidth of a Frequency Hopping Sequence Spread Spectrum System	PASS	Meet the requirement of limit.
15.247(b)	Maximum Peak Output Power Spec.: max. 21dBm	PASS	Meet the requirement of limit.
15.247(d)	Transmitter Radiated Emissions Spec.: Table 15.209	PASS	Meet the requirement of limit. Minimum passing margin is -2.19dB at 206.83MHz.
15.247(d)	Band Edge Measurement	PASS	Meet the requirement of limit.

NOTE: If The Frequency Hopping System operating in 2400-2483.5MHz band and the output power less than 125mW. The hopping channel carrier frequencies separated by a minimum of 25kHz or two-thirds of the 20dB bandwidth of hopping channel whichever is greater.

2.1 MEASUREMENT UNCERTAINTY

Where relevant, the following measurement uncertainty levels have been estimated for tests performed on the EUT as specified in CISPR 16-4-2:

MEASUREMENT	FREQUENCY	UNCERTAINTY
Radiated emissions	30MHz ~ 200MHz	2.93 dB
	200MHz ~1000MHz	2.95 dB
	1GHz ~ 18GHz	2.26 dB
	18GHz ~ 40GHz	1.94 dB

This uncertainty represents an expanded uncertainty expressed at approximately the 95% confidence level using a coverage factor of k=2.



3. GENERAL INFORMATION

3.1 GENERAL DESCRIPTION OF EUT

PRODUCT	GPS Navigation Device
MODEL NO.	GC450
FCC ID	IHDP6KH1
POWER SUPPLY	5.4Vdc from car charger 3.7Vdc from Li-ion battery
MODULATION TYPE	GFSK, $\pi/4$ -DQPSK, 8DPSK for FHSS
MODULATION TECHNOLOGY	FHSS
TRANSFER RATE	1/2/3Mbps
FREQUENCY RANGE	2402MHz ~ 2480MHz
NUMBER OF CHANNEL	79
MAXIMUM OUTPUT POWER	2.410mW
ANTENNA TYPE	PIFA antenna with 2.0dBi gain
I/O PORTS	Refer to user's manual
DATA CABLE	NA
ACCESSORY DEVICES	Car charger, Battery

NOTE:

1. Bluetooth technology is used in this EUT.
2. The EUT was powered by the following car charger:

BRAND	MOTOROLA
MODEL	SPN5579A
INPUT POWER	1.8 ~ 3.3Vdc, 0-1.2A
OUTPUT POWER	5.4Vdc, 1.8A
POWER LINE	1.5m non-shielded cable without core

3. The following accessories are for support units only.

PRODUCT	DESCRIPTION
SD Card	-
USB cable	0.9m shielded cable without core

4. A set of the EUT include GPS Navigation Device and Cradle. For Cradle info. refer to following list:

BRAND	MODEL	REMARK
Motorola	SJYN0126A	Music Cradle: FM RDS/TMC (FM Rx) + FM TX
Motorola	SJYN0129A	Traffic Cradle: FM RDS/TMC (FM Rx)
Motorola	SJYN0125A	Power Cradle: supply only

5. The above EUT information was declared by the manufacturer and for more detailed features description, please refer to the manufacturer's specifications or User's Manual.

3.2 DESCRIPTION OF TEST MODES

79 channels are provided to this EUT:

CHANNEL	FREQ. (MHz)	CHANNEL	FREQ. (MHz)	CHANNEL	FREQ. (MHz)	CHANNEL	FREQ. (MHz)
0	2402	20	2422	40	2442	60	2462
1	2403	21	2423	41	2443	61	2463
2	2404	22	2424	42	2444	62	2464
3	2405	23	2425	43	2445	63	2465
4	2406	24	2426	44	2446	64	2466
5	2407	25	2427	45	2447	65	2467
6	2408	26	2428	46	2448	66	2468
7	2409	27	2429	47	2449	67	2469
8	2410	28	2430	48	2450	68	2470
9	2411	29	2431	49	2451	69	2471
10	2412	30	2432	50	2452	70	2472
11	2413	31	2433	51	2453	71	2473
12	2414	32	2434	52	2454	72	2474
13	2415	33	2435	53	2455	73	2475
14	2416	34	2436	54	2456	74	2476
15	2417	35	2437	55	2457	75	2477
16	2418	36	2438	56	2458	76	2478
17	2419	37	2439	57	2459	77	2479
18	2420	38	2440	58	2460	78	2480
19	2421	39	2441	59	2461		

3.2.1 CONFIGURATION OF SYSTEM UNDER TEST

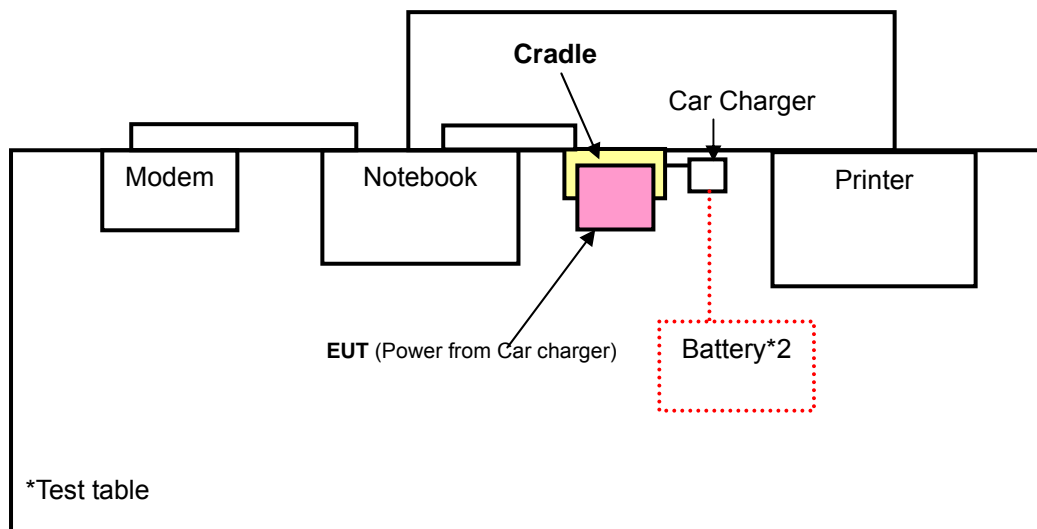

3.2.2 TEST MODE APPLICABILITY AND TESTED CHANNEL DETAIL

EUT CONFIGURE MODE	APPLICABLE TO				DESCRIPTION
	RE \geq 1G	RE $<$ 1G	PLC	APCM	
A	√	√	NOTE 1	√	Traffic Cradle
B	-	√	NOTE 1	-	Music Cradle
C	-	√	NOTE 1	-	Power Cradle

Where **RE \geq 1G**: Radiated Emission above 1GHz

RE $<$ 1G: Radiated Emission below 1GHz

PLC: Power Line Conducted Emission

APCM: Antenna Port Conducted Measurement

NOTE 1: No need to concern of Conducted Emission due to the EUT is powered by car charger or battery.

NOTE 2: "-" means no effect

RADIATED EMISSION TEST (ABOVE 1 GHz):

- Pre-Scan has been conducted to determine the worst-case mode from all possible combinations between available modulations, XYZ axis, antenna ports (if EUT with antenna diversity architecture) and packet type.
- Following channel(s) was (were) selected for the final test as listed below.

EUT CONFIGURE MODE	AVAILABLE CHANNEL	TESTED CHANNEL	MODULATION TECHNOLOGY	MODULATION TYPE	PACKET TYPE	AXIS
A	0 to 78	0, 39, 78	FHSS	GFSK	DH5	Z
A	0 to 78	0, 39, 78	FHSS	8DPSK	DH5	Z

RADIATED EMISSION TEST (BELOW 1 GHz):

- Pre-Scan has been conducted to determine the worst-case mode from all possible combinations between available modulations, XYZ axis, antenna ports (if EUT with antenna diversity architecture) and packet type.
- Following channel(s) was (were) selected for the final test as listed below.

EUT CONFIGURE MODE	AVAILABLE CHANNEL	TESTED CHANNEL	MODULATION TECHNOLOGY	MODULATION TYP	PACKET TYPE	AXIS
A	0 to 78	39	FHSS	GFSK	DH5	Z
B	0 to 78	39	FHSS	GFSK	DH5	Z
C	0 to 78	39	FHSS	GFSK	DH5	Z

BANDEDGE MEASUREMENT:

- Pre-Scan has been conducted to determine the worst-case mode from all possible combinations between available modulations, antenna ports (if EUT with antenna diversity architecture), and packet types.
- Following channel(s) was (were) selected for the final test as listed below.

EUT CONFIGURE MODE	AVAILABLE CHANNEL	TESTED CHANNEL	MODULATION TECHNOLOGY	MODULATION TYPE	PACKET TYPE
A	0 to 78	0, 78	FHSS	GFSK	DH5
A	0 to 78	0, 78	FHSS	8DPSK	DH5

ANTENNA PORT CONDUCTED MEASUREMENT:

- Pre-Scan has been conducted to determine the worst-case mode from all possible combinations between available modulations, antenna ports (if EUT with antenna diversity architecture), and packet types.
- Following channel(s) was (were) selected for the final test as listed below.

EUT CONFIGURE MODE	AVAILABLE CHANNEL	TESTED CHANNEL	MODULATION TECHNOLOGY	MODULATION TYPE	PACKET TYPE
A	0 to 78	0, 39, 78	FHSS	GFSK	DH5
A	0 to 78	0, 39, 78	FHSS	8DPSK	DH5

3.3 GENERAL DESCRIPTION OF APPLIED STANDARDS

The EUT is a RF product. According to the specifications of the manufacturer, it must comply with the requirements of the following standards:

FCC Part 15, Subpart C (15.247)

ANSI C63.4-2003

All test items have been performed and recorded as per the above standards.

NOTE: The EUT is also considered as a kind of computer peripheral, because the connection to computer is necessary for typical use. It has been verified to comply with the requirements of FCC Part 15, Subpart B, Class B (DoC). The test report has been issued separately.

3.4 DESCRIPTION OF SUPPORT UNITS

The EUT has been tested as an independent unit together with other necessary accessories or support units. The following support units or accessories were used to form a representative test configuration during the tests.

NO.	PRODUCT	BRAND	MODEL NO.	SERIAL NO.	FCC ID
1	NOTEBOOK	DELL	PP05L	12130898320	E2K24CLNS
2	MODEM	ACEEX	1414V/3	0401008253	IFAXDM1414
3	PRINTER	EPSON	LQ-300+	DCGY046016	FCC DoC Approved
4	BATTERY	YUASA	80D26R	NA	NA

NO.	SIGNAL CABLE DESCRIPTION OF THE ABOVE SUPPORT UNITS
1	NA
2	1.2m braid shielded wire, DB25 & DB9 connector, w/o core.
3	1.8m braid shielded wire, DB25 connector, w/o core.
4	NA

NOTE: All power cords of the above support units are non shielded (1.8m).

4. TEST TYPES AND RESULTS

4.1 RADIATED EMISSION MEASUREMENT

4.1.1 LIMITS OF RADIATED EMISSION MEASUREMENT

Emissions radiated outside of the specified bands, shall be according to the general radiated limits in 15.209 as following:

FREQUENCIES (MHz)	FIELD STRENGTH (microvolts/meter)	MEASUREMENT DISTANCE (meters)
0.009 ~ 0.490	2400/F(kHz)	300
0.490 ~ 1.705	24000/F(kHz)	30
1.705 ~ 30.0	30	30
30 ~ 88	100	3
88 ~ 216	150	3
216 ~ 960	200	3
Above 960	500	3

NOTE:

1. The lower limit shall apply at the transition frequencies.
2. Emission level (dBuV/m) = 20 log Emission level (uV/m).
3. As shown in 15.35(b), for frequencies above 1000MHz, the field strength limits are based on average detector, however, the peak field strength of any emission shall not exceed the maximum permitted average limits, specified above by more than 20dB under any condition of modulation.

4.1.2 TEST INSTRUMENTS

DESCRIPTION & MANUFACTURER	MODEL NO.	SERIAL NO.	DATE OF CALIBRATION	DUE DATE OF CALIBRATION
Test Receiver ROHDE & SCHWARZ	ESIB7	100212	May 25, 2009	May 24, 2010
Spectrum Analyzer ROHDE & SCHWARZ	FSP40	100269	Aug. 08, 2008	Aug. 07, 2009
BILOG Antenna SCHWARZBECK	VULB9168	9168-156	Apr. 30, 2009	Apr. 29, 2010
HORN Antenna SCHWARZBECK	BBHA 9120 D	9120D-563	Aug. 06, 2008	Aug. 05, 2009
HORN Antenna SCHWARZBECK	BBHA 9170	BBHA9170242	Jan. 06, 2009	Jan. 05, 2010
Preamplifier Agilent	8449B	3008A01911	Sep. 10, 2008	Sep. 09, 2009
Preamplifier Agilent	8447D	2944A10638	Dec. 26, 2008	Dec. 25, 2009
RF signal cable HUBER+SUHNNER	SUCOFLEX 104	218190/4 231241/4	May 13, 2009	May 12, 2010
RF signal cable Worken	8D-FB	Cable-HYCH9-01	Aug. 09, 2008	Aug. 08, 2009
Software	ADT_Radiated_ V7.6.15.9.2	NA	NA	NA
Antenna Tower EMCO	2070/2080	512.835.4684	NA	NA
Turn Table EMCO	2087-2.03	NA	NA	NA
Antenna Tower & Turn Table Controller EMCO	2090	NA	NA	NA

- NOTE:**
1. The calibration interval of the above test instruments is 12 months and the calibrations are traceable to NML/ROC and NIST/USA.
 2. The test was performed in HwaYa Chamber 9.
 3. The horn antenna and HP preamplifier (model: 8449B) are used only for the measurement of emission frequency above 1GHz if tested.
 4. The FCC Site Registration No. is 460141.
 5. The IC Site Registration No. is IC 7450F-4.

4.1.3 TEST PROCEDURES

- a. The EUT was placed on the top of a rotating table 0.8 meters above the ground at a 3 meter semi-anechoic chamber. The table was rotated 360 degrees to determine the position of the highest radiation.
- b. The EUT was set 3 meters away from the interference-receiving antenna, which was mounted on the top of a variable-height antenna tower.
- c. The antenna is a broadband antenna, and its height is varied from one meter to four meters above the ground to determine the maximum value of the field strength. Both horizontal and vertical polarizations of the antenna are set to make the measurement.
- d. For each suspected emission, the EUT was arranged to its worst case and then the antenna was tuned to heights from 1 meter to 4 meters and the rotatable table was turned from 0 degrees to 360 degrees to find the maximum reading.
- e. The test-receiver system was set to Peak Detect Function and Specified Bandwidth with Maximum Hold Mode.
- f. If the emission level of the EUT in peak mode was lower than the limit specified, then testing could be stopped and the peak values of the EUT would be reported. Otherwise the emissions would be re-tested one by one using peak, quasi-peak or average method as specified and then reported in a data sheet.

NOTE:

1. The resolution bandwidth and video bandwidth of test receiver/spectrum analyzer is 120kHz for Quasi-peak detection at frequency below 1GHz.
2. The resolution bandwidth of test receiver/spectrum analyzer is 1 MHz and video bandwidth is 3MHz for Peak detection at frequency above 1GHz.
3. All modes of operation were investigated and the worst-case emissions are reported.

4.1.4 DEVIATION FROM TEST STANDARD

No deviation.

4.1.5 TEST SETUP

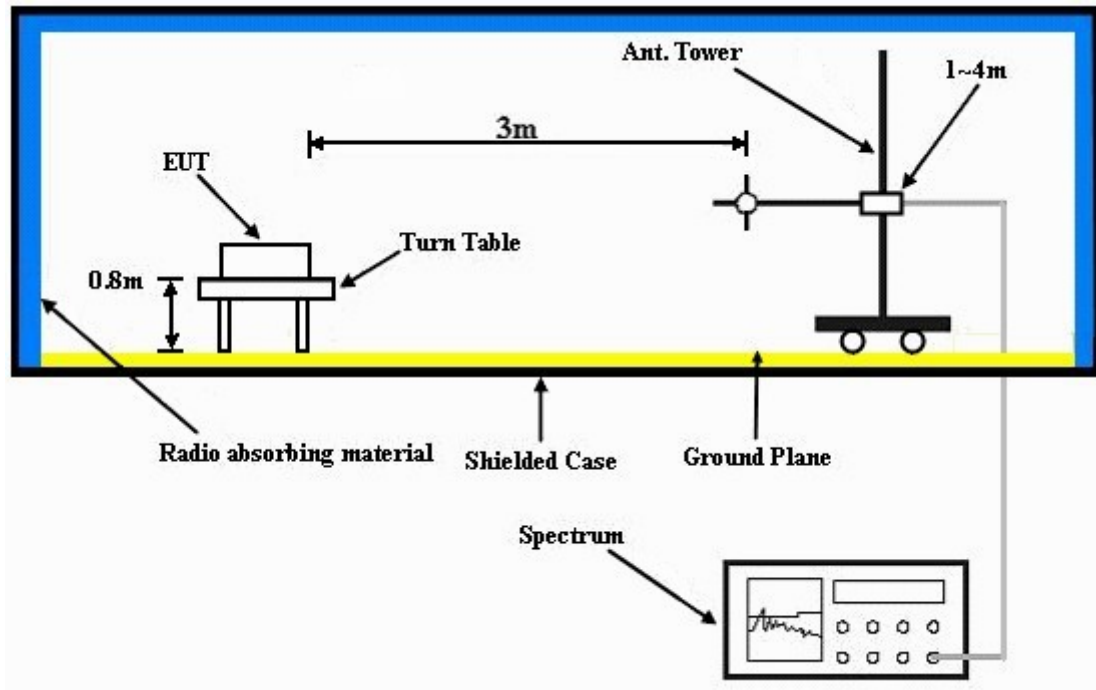

For the actual test configuration, please refer to the attached file (Test Setup Photo).

4.1.6 EUT OPERATING CONDITIONS

- a. Connected EUT to the notebook system and placed on the testing table.
- b. Set the EUT under transmission condition continuously at specific channel frequency.
- c. The necessary accessories enable the system in full functions.

4.1.7 TEST RESULTS

RADIATED WORST CASE DATA: ABOVE 1GHz:

GFSK MODULATION

EUT TEST CONDITION		MEASUREMENT DETAIL	
CHANNEL	Channel 0	FREQUENCY RANGE	1 ~ 25GHz
INPUT POWER (SYSTEM)	120Vac, 60 Hz	DETECTOR FUNCTION	Peak (PK) Average (AV)
ENVIRONMENTAL CONDITIONS	24deg. C, 64%RH 1000 hPa	TESTED BY	Match Tsui

ANTENNA POLARITY & TEST DISTANCE: HORIZONTAL AT 3 M								
NO.	FREQ. (MHz)	EMISSION LEVEL (dBuV/m)	LIMIT (dBuV/m)	MARGIN (dB)	ANTENNA HEIGHT (m)	TABLE ANGLE (Degree)	RAW VALUE (dBuV)	CORRECTION FACTOR (dB/m)
1	2390.00	43.12 PK	74.00	-30.87	1.22 H	313	10.90	32.22
2	2390.00	32.01 AV	54.00	-21.99	1.22 H	313	-0.22	32.22
3	#2400.00	56.59 PK	75.45	-18.86	1.20 H	311	24.33	32.26
4	#2400.00	26.49 AV	45.35	-18.86	1.20 H	311	-5.77	32.26
5	*2402.00	95.45 PK			1.20 H	311	63.18	32.27
6	*2402.00	65.35 AV			1.20 H	311	33.08	32.27
7	4804.00	51.86 PK	74.00	-22.14	1.03 H	306	13.56	38.30
8	4804.00	21.76 AV	54.00	-32.24	1.03 H	306	-16.54	38.30

ANTENNA POLARITY & TEST DISTANCE: VERTICAL AT 3 M								
NO.	FREQ. (MHz)	EMISSION LEVEL (dBuV/m)	LIMIT (dBuV/m)	MARGIN (dB)	ANTENNA HEIGHT (m)	TABLE ANGLE (Degree)	RAW VALUE (dBuV)	CORRECTION FACTOR (dB/m)
1	2390.00	41.86 PK	74.00	-32.14	1.99 V	359	9.64	32.22
2	2390.00	29.82 AV	54.00	-24.18	1.99 V	359	-2.40	32.22
3	#2400.00	57.42 PK	76.28	-18.86	1.09 V	85	25.16	32.26
4	#2400.00	27.32 AV	46.18	-18.86	1.09 V	85	-4.94	32.26
5	*2402.00	96.28 PK			1.09 V	85	64.01	32.27
6	*2402.00	66.18 AV			1.09 V	85	33.91	32.27
7	4804.00	50.71 PK	74.00	-23.29	1.00 V	360	12.41	38.30
8	4804.00	20.61 AV	54.00	-33.39	1.00 V	360	-17.69	38.30

- REMARKS:**
1. Emission level (dBuV/m) = Raw Value (dBuV) + Correction Factor (dB/m).
 2. Correction Factor (dB/m) = Antenna Factor (dB/m) + Cable Factor (dB).
 3. The other emission levels were very low against the limit.
 4. Margin value = Emission level – Limit value.
 5. “ * “: Fundamental frequency.
 6. The DH5 packet was the worse case duty cycle for a transmit dwell time on a channel, based upon bluetooth theory the transmitter is on 0.625 * 5 per 296.25 ms per channel. Therefore, the duty cycle correlation factor be equal to: $20\log(3.125 / 100) = -30.1$ dB.
 7. Average value = peak reading + $20\log(\text{duty cycle})$.
 8. "#":The radiated frequency is out the restricted band.



A D T

EUT TEST CONDITION		MEASUREMENT DETAIL	
CHANNEL	Channel 39	FREQUENCY RANGE	1 ~ 25GHz
INPUT POWER (SYSTEM)	120Vac, 60 Hz	DETECTOR FUNCTION	Peak (PK) Average (AV)
ENVIRONMENTAL CONDITIONS	24deg. C, 64%RH 1000 hPa	TESTED BY	Match Tsui

ANTENNA POLARITY & TEST DISTANCE: HORIZONTAL AT 3 M								
NO.	FREQ. (MHz)	EMISSION LEVEL (dBuV/m)	LIMIT (dBuV/m)	MARGIN (dB)	ANTENNA HEIGHT (m)	TABLE ANGLE (Degree)	RAW VALUE (dBuV)	CORRECTION FACTOR (dB/m)
1	*2441.00	94.83 PK			1.14 H	313	62.42	32.41
2	*2441.00	64.73 AV			1.14 H	313	32.32	32.41
3	4882.00	52.57 PK	74.00	-21.43	1.02 H	312	14.15	38.42
4	4882.00	22.47 AV	54.00	-31.53	1.02 H	312	-15.95	38.42
ANTENNA POLARITY & TEST DISTANCE: VERTICAL AT 3 M								
NO.	FREQ. (MHz)	EMISSION LEVEL (dBuV/m)	LIMIT (dBuV/m)	MARGIN (dB)	ANTENNA HEIGHT (m)	TABLE ANGLE (Degree)	RAW VALUE (dBuV)	CORRECTION FACTOR (dB/m)
1	*2441.00	96.58 PK			1.15 V	51	64.17	32.41
2	*2441.00	66.48 AV			1.15 V	51	34.07	32.41
3	4882.00	51.56 PK	74.00	-22.44	1.00 V	22	13.14	38.42
4	4882.00	21.46 AV	54.00	-32.54	1.00 V	22	-16.96	38.42

- REMARKS:**
1. Emission level (dBuV/m) = Raw Value (dBuV) + Correction Factor (dB/m).
 2. Correction Factor (dB/m) = Antenna Factor (dB/m) + Cable Factor (dB).
 3. The other emission levels were very low against the limit.
 4. Margin value = Emission level – Limit value.
 5. “ * “: Fundamental frequency.
 6. The DH5 packet was the worse case duty cycle for a transmit dwell time on a channel, based upon bluetooth theory the transmitter is on 0.625 * 5 per 296.25 ms per channel. Therefore, the duty cycle correlation factor be equal to: $20\log(3.125 / 100) = -30.1$ dB.
 7. Average value = peak reading + $20\log(\text{duty cycle})$.



A D T

EUT TEST CONDITION		MEASUREMENT DETAIL	
CHANNEL	Channel 78	FREQUENCY RANGE	1 ~ 25GHz
INPUT POWER (SYSTEM)	120Vac, 60 Hz	DETECTOR FUNCTION	Peak (PK) Average (AV)
ENVIRONMENTAL CONDITIONS	24deg. C, 64%RH 1000 hPa	TESTED BY	Match Tsui

ANTENNA POLARITY & TEST DISTANCE: HORIZONTAL AT 3 M								
NO.	FREQ. (MHz)	EMISSION LEVEL (dBuV/m)	LIMIT (dBuV/m)	MARGIN (dB)	ANTENNA HEIGHT (m)	TABLE ANGLE (Degree)	RAW VALUE (dBuV)	CORRECTION FACTOR (dB/m)
1	*2480.00	95.26 PK			1.14 H	313	62.71	32.55
2	*2480.00	65.16 AV			1.14 H	313	32.61	32.55
3	2483.50	36.67 PK	74.00	-37.33	1.14 H	313	4.11	32.56
4	2483.50	6.57 AV	54.00	-47.43	1.14 H	313	-25.99	32.56
5	4960.00	50.15 PK	74.00	-23.85	1.05 H	5	11.54	38.61
6	4960.00	20.05 AV	54.00	-33.95	1.05 H	5	-18.56	38.61

ANTENNA POLARITY & TEST DISTANCE: VERTICAL AT 3 M								
NO.	FREQ. (MHz)	EMISSION LEVEL (dBuV/m)	LIMIT (dBuV/m)	MARGIN (dB)	ANTENNA HEIGHT (m)	TABLE ANGLE (Degree)	RAW VALUE (dBuV)	CORRECTION FACTOR (dB/m)
1	*2480.00	96.08 PK			1.10 V	53	63.53	32.55
2	*2480.00	65.98 AV			1.10 V	53	33.43	32.55
3	2483.50	39.48 PK	74.00	-34.52	1.10 V	53	6.92	32.56
4	2483.50	9.38 AV	54.00	-44.62	1.10 V	53	-23.18	32.56
5	4960.00	49.93 PK	74.00	-24.07	1.23 V	322	11.32	38.61
6	4960.00	19.83 AV	54.00	-34.17	1.23 V	322	-18.78	38.61

- REMARKS:**
1. Emission level (dBuV/m) = Raw Value (dBuV) + Correction Factor (dB/m).
 2. Correction Factor (dB/m) = Antenna Factor (dB/m) + Cable Factor (dB).
 3. The other emission levels were very low against the limit.
 4. Margin value = Emission level – Limit value.
 5. “ * “: Fundamental frequency.
 6. The DH5 packet was the worse case duty cycle for a transmit dwell time on a channel, based upon bluetooth theory the transmitter is on 0.625 * 5 per 296.25 ms per channel. Therefore, the duty cycle correlation factor be equal to: $20\log(3.125 / 100) = -30.1$ dB.
 7. Average value = peak reading + $20\log(\text{duty cycle})$.

8DPSK MODULATION

EUT TEST CONDITION		MEASUREMENT DETAIL	
CHANNEL	Channel 0	FREQUENCY RANGE	1 ~ 25GHz
INPUT POWER (SYSTEM)	120Vac, 60 Hz	DETECTOR FUNCTION	Peak (PK) Average (AV)
ENVIRONMENTAL CONDITIONS	24deg. C, 64%RH 1000 hPa	TESTED BY	Match Tsui

ANTENNA POLARITY & TEST DISTANCE: HORIZONTAL AT 3 M								
NO.	FREQ. (MHz)	EMISSION LEVEL (dBuV/m)	LIMIT (dBuV/m)	MARGIN (dB)	ANTENNA HEIGHT (m)	TABLE ANGLE (Degree)	RAW VALUE (dBuV)	CORRECTION FACTOR (dB/m)
1	2390.00	41.76 PK	74.00	-32.24	1.23 H	313	9.53	32.22
2	2390.00	30.27 AV	54.00	-23.73	1.23 H	313	-1.96	32.22
3	#2400.00	48.73 PK	73.86	-25.13	1.22 H	311	16.47	32.26
4	#2400.00	18.63 AV	43.76	-25.13	1.22 H	311	-13.63	32.26
5	*2402.00	93.86 PK			1.22 H	311	61.59	32.27
6	*2402.00	63.76 AV			1.22 H	311	31.49	32.27
7	4804.00	50.04 PK	74.00	-23.96	1.04 H	309	11.74	38.30
8	4804.00	19.94 AV	54.00	-34.06	1.04 H	309	-18.36	38.30

ANTENNA POLARITY & TEST DISTANCE: VERTICAL AT 3 M								
NO.	FREQ. (MHz)	EMISSION LEVEL (dBuV/m)	LIMIT (dBuV/m)	MARGIN (dB)	ANTENNA HEIGHT (m)	TABLE ANGLE (Degree)	RAW VALUE (dBuV)	CORRECTION FACTOR (dB/m)
1	2390.00	41.75 PK	74.00	-32.25	1.11 V	56	9.52	32.22
2	2390.00	30.82 AV	54.00	-23.18	1.11 V	56	-1.41	32.22
3	#2400.00	51.01 PK	74.97	-23.96	1.08 V	86	18.75	32.26
4	#2400.00	20.91 AV	44.87	-23.96	1.08 V	86	-11.35	32.26
5	*2402.00	94.97 PK			1.08 V	86	62.70	32.27
6	*2402.00	64.87 AV			1.08 V	86	32.60	32.27
7	4804.00	48.42 PK	74.00	-25.58	1.50 V	345	10.12	38.30
8	4804.00	18.32 AV	54.00	-35.68	1.50 V	345	-19.98	38.30

- REMARKS:**
1. Emission level (dBuV/m) = Raw Value (dBuV) + Correction Factor (dB/m).
 2. Correction Factor (dB/m) = Antenna Factor (dB/m) + Cable Factor (dB).
 3. The other emission levels were very low against the limit.
 4. Margin value = Emission level – Limit value.
 5. “ * “: Fundamental frequency.
 6. The DH5 packet was the worse case duty cycle for a transmit dwell time on a channel, based upon bluetooth theory the transmitter is on 0.625 * 5 per 296.25 ms per channel. Therefore, the duty cycle correlation factor be equal to: $20\log(3.125 / 100) = -30.1$ dB.
 7. Average value = peak reading + $20\log(\text{duty cycle})$.
 8. "#":The radiated frequency is out the restricted band.



A D T

EUT TEST CONDITION		MEASUREMENT DETAIL	
CHANNEL	Channel 39	FREQUENCY RANGE	1 ~ 25GHz
INPUT POWER (SYSTEM)	120Vac, 60 Hz	DETECTOR FUNCTION	Peak (PK) Average (AV)
ENVIRONMENTAL CONDITIONS	24deg. C, 64%RH 1000 hPa	TESTED BY	Match Tsui

ANTENNA POLARITY & TEST DISTANCE: HORIZONTAL AT 3 M								
NO.	FREQ. (MHz)	EMISSION LEVEL (dBuV/m)	LIMIT (dBuV/m)	MARGIN (dB)	ANTENNA HEIGHT (m)	TABLE ANGLE (Degree)	RAW VALUE (dBuV)	CORRECTION FACTOR (dB/m)
1	*2441.00	93.39 PK			1.18 H	313	60.98	32.41
2	*2441.00	63.29 AV			1.18 H	313	30.88	32.41
3	4882.00	49.26 PK	74.00	-24.74	1.05 H	360	10.84	38.42
4	4882.00	19.16 AV	54.00	-34.84	1.05 H	360	-19.26	38.42
ANTENNA POLARITY & TEST DISTANCE: VERTICAL AT 3 M								
NO.	FREQ. (MHz)	EMISSION LEVEL (dBuV/m)	LIMIT (dBuV/m)	MARGIN (dB)	ANTENNA HEIGHT (m)	TABLE ANGLE (Degree)	RAW VALUE (dBuV)	CORRECTION FACTOR (dB/m)
1	*2441.00	95.78 PK			1.12 V	53	63.37	32.41
2	*2441.00	65.68 AV			1.12 V	53	33.27	32.41
3	4882.00	48.91 PK	74.00	-25.09	1.29 V	360	10.49	38.42
4	4882.00	18.81 AV	54.00	-35.19	1.29 V	360	-19.61	38.42

- REMARKS:**
1. Emission level (dBuV/m) = Raw Value (dBuV) + Correction Factor (dB/m).
 2. Correction Factor (dB/m) = Antenna Factor (dB/m) + Cable Factor (dB).
 3. The other emission levels were very low against the limit.
 4. Margin value = Emission level – Limit value.
 5. “ * “: Fundamental frequency.
 6. The DH5 packet was the worse case duty cycle for a transmit dwell time on a channel, based upon bluetooth theory the transmitter is on 0.625 * 5 per 296.25 ms per channel. Therefore, the duty cycle correlation factor be equal to: $20\log(3.125 / 100) = -30.1$ dB.
 7. Average value = peak reading + $20\log(\text{duty cycle})$.



A D T

EUT TEST CONDITION		MEASUREMENT DETAIL	
CHANNEL	Channel 78	FREQUENCY RANGE	1 ~ 25GHz
INPUT POWER (SYSTEM)	120Vac, 60 Hz	DETECTOR FUNCTION	Peak (PK) Average (AV)
ENVIRONMENTAL CONDITIONS	24deg. C, 64%RH 1000 hPa	TESTED BY	Match Tsui

ANTENNA POLARITY & TEST DISTANCE: HORIZONTAL AT 3 M								
NO.	FREQ. (MHz)	EMISSION LEVEL (dBuV/m)	LIMIT (dBuV/m)	MARGIN (dB)	ANTENNA HEIGHT (m)	TABLE ANGLE (Degree)	RAW VALUE (dBuV)	CORRECTION FACTOR (dB/m)
1	*2480.00	93.05 PK			1.14 H	313	60.50	32.55
2	*2480.00	62.95 AV			1.14 H	313	30.40	32.55
3	2483.50	37.40 PK	74.00	-36.60	1.14 H	313	4.84	32.56
4	2483.50	7.30 AV	54.00	-46.70	1.14 H	313	-25.26	32.56
5	4960.00	50.14 PK	74.00	-23.86	1.10 H	355	11.53	38.61
6	4960.00	20.04 AV	54.00	-33.96	1.10 H	355	-18.57	38.61

ANTENNA POLARITY & TEST DISTANCE: VERTICAL AT 3 M								
NO.	FREQ. (MHz)	EMISSION LEVEL (dBuV/m)	LIMIT (dBuV/m)	MARGIN (dB)	ANTENNA HEIGHT (m)	TABLE ANGLE (Degree)	RAW VALUE (dBuV)	CORRECTION FACTOR (dB/m)
1	*2480.00	94.46 PK			1.11 V	52	61.91	32.55
2	*2480.00	64.36 AV			1.11 V	52	31.81	32.55
3	2483.50	38.67 PK	74.00	-35.33	1.09 V	52	6.11	32.56
4	2483.50	8.57 AV	54.00	-45.43	1.09 V	52	-23.99	32.56
5	4960.00	48.27 PK	74.00	-25.73	1.48 V	360	9.66	38.61
6	4960.00	18.17 AV	54.00	-35.83	1.48 V	360	-20.44	38.61

- REMARKS:**
1. Emission level (dBuV/m) = Raw Value (dBuV) + Correction Factor (dB/m).
 2. Correction Factor (dB/m) = Antenna Factor (dB/m) + Cable Factor (dB).
 3. The other emission levels were very low against the limit.
 4. Margin value = Emission level – Limit value.
 5. “ * “: Fundamental frequency.
 6. The DH5 packet was the worse case duty cycle for a transmit dwell time on a channel, based upon bluetooth theory the transmitter is on 0.625 * 5 per 296.25 ms per channel. Therefore, the duty cycle correlation factor be equal to: $20\log(3.125 / 100) = -30.1$ dB.
 7. Average value = peak reading + $20\log(\text{duty cycle})$.



A D T

BELOW 1GHz WORST-CASE DATA : GFSK MODULATION

EUT TEST CONDITION		MEASUREMENT DETAIL	
CHANNEL	Channel 39	FREQUENCY RANGE	Below 1000MHz
INPUT POWER (SYSTEM)	120Vac, 60 Hz	DETECTOR FUNCTION	Quasi-Peak
ENVIRONMENTAL CONDITIONS	24deg. C, 64%RH 999 hPa	TEST MODE	A
TESTED BY	Match Tsui		

ANTENNA POLARITY & TEST DISTANCE: HORIZONTAL AT 3 M								
NO.	FREQ. (MHz)	EMISSION LEVEL (dBuV/m)	LIMIT (dBuV/m)	MARGIN (dB)	ANTENNA HEIGHT (m)	TABLE ANGLE (Degree)	RAW VALUE (dBuV)	CORRECTION FACTOR (dB/m)
1	86.28	34.23 QP	40.00	-5.77	2.50 H	52	25.43	8.79
2	113.50	35.76 QP	43.50	-7.74	1.50 H	94	24.79	10.96
3	187.39	38.99 QP	43.50	-4.51	1.50 H	352	27.39	11.61
4	206.83	40.83 QP	43.50	-2.67	1.00 H	73	29.93	10.90
5	239.88	39.49 QP	46.00	-6.51	1.50 H	229	27.12	12.38
6	288.49	36.32 QP	46.00	-9.68	1.00 H	223	22.85	13.47
7	305.99	42.24 QP	46.00	-3.76	1.25 H	217	28.43	13.81
8	331.26	36.36 QP	46.00	-9.64	1.00 H	286	21.96	14.40
9	445.98	39.51 QP	46.00	-6.49	1.50 H	349	21.93	17.59
10	500.42	38.79 QP	46.00	-7.21	1.00 H	37	19.54	19.25
11	665.68	37.48 QP	46.00	-8.52	1.00 H	244	15.04	22.45

ANTENNA POLARITY & TEST DISTANCE: VERTICAL AT 3 M								
NO.	FREQ. (MHz)	EMISSION LEVEL (dBuV/m)	LIMIT (dBuV/m)	MARGIN (dB)	ANTENNA HEIGHT (m)	TABLE ANGLE (Degree)	RAW VALUE (dBuV)	CORRECTION FACTOR (dB/m)
1	62.95	33.44 QP	40.00	-6.56	1.00 V	136	20.59	12.85
2	123.23	39.47 QP	43.50	-4.03	2.00 V	349	27.59	11.88
3	132.95	36.06 QP	43.50	-7.44	2.50 V	10	23.80	12.25
4	177.67	41.17 QP	43.50	-2.33	2.00 V	319	28.80	12.37
5	206.83	41.24 QP	43.50	-2.26	1.00 V	289	30.34	10.90
6	239.88	39.84 QP	46.00	-6.16	2.00 V	184	27.46	12.38
7	270.99	39.36 QP	46.00	-6.64	1.50 V	10	26.19	13.17
8	500.42	40.86 QP	46.00	-5.14	1.00 V	136	21.61	19.25
9	663.74	35.98 QP	46.00	-10.02	1.00 V	100	13.55	22.43

- REMARKS:**
1. Emission level (dBuV/m) = Raw Value (dBuV) + Correction Factor (dB/m).
 2. Correction Factor (dB/m) = Antenna Factor (dB/m) + Cable Factor (dB).
 3. The other emission levels were very low against the limit.
 4. Margin value = Emission level – Limit value.



A D T

EUT TEST CONDITION		MEASUREMENT DETAIL	
CHANNEL	Channel 39	FREQUENCY RANGE	Below 1000MHz
INPUT POWER (SYSTEM)	120Vac, 60 Hz	DETECTOR FUNCTION	Quasi-Peak
ENVIRONMENTAL CONDITIONS	24deg. C, 64%RH 999 hPa	TEST MODE	B
TESTED BY	Match Tsui		

ANTENNA POLARITY & TEST DISTANCE: HORIZONTAL AT 3 M

NO.	FREQ. (MHz)	EMISSION LEVEL (dBuV/m)	LIMIT (dBuV/m)	MARGIN (dB)	ANTENNA HEIGHT (m)	TABLE ANGLE (Degree)	RAW VALUE (dBuV)	CORRECTION FACTOR (dB/m)
1	47.40	34.89 QP	40.00	-5.11	2.00 H	34	21.84	13.06
2	109.62	37.19 QP	43.50	-6.31	2.50 H	64	26.70	10.49
3	183.50	40.69 QP	43.50	-2.81	1.25 H	310	28.77	11.92
4	206.83	41.03 QP	43.50	-2.47	1.00 H	91	30.14	10.90
5	239.88	37.90 QP	46.00	-8.10	1.00 H	244	25.52	12.38
6	261.27	41.42 QP	46.00	-4.58	1.25 H	154	28.39	13.03
7	331.26	37.64 QP	46.00	-8.36	1.00 H	289	23.24	14.40
8	403.20	35.94 QP	46.00	-10.06	2.00 H	31	19.77	16.17
9	455.70	37.84 QP	46.00	-8.16	1.50 H	307	19.94	17.89
10	500.42	38.42 QP	46.00	-7.58	1.00 H	34	19.17	19.25
11	663.74	35.70 QP	46.00	-10.30	1.25 H	94	13.27	22.43

ANTENNA POLARITY & TEST DISTANCE: VERTICAL AT 3 M

NO.	FREQ. (MHz)	EMISSION LEVEL (dBuV/m)	LIMIT (dBuV/m)	MARGIN (dB)	ANTENNA HEIGHT (m)	TABLE ANGLE (Degree)	RAW VALUE (dBuV)	CORRECTION FACTOR (dB/m)
1	78.51	36.97 QP	40.00	-3.03	1.25 V	70	28.38	8.59
2	115.45	40.95 QP	43.50	-2.55	1.00 V	358	29.75	11.20
3	136.84	34.76 QP	43.50	-8.74	1.25 V	313	22.35	12.41
4	183.50	40.19 QP	43.50	-3.31	2.00 V	88	28.27	11.92
5	206.83	40.97 QP	43.50	-2.53	1.00 V	307	30.07	10.90
6	255.44	39.25 QP	46.00	-6.75	1.50 V	61	26.32	12.93
7	270.99	37.99 QP	46.00	-8.01	1.00 V	10	24.82	13.17
8	397.37	36.84 QP	46.00	-9.16	1.25 V	316	20.84	16.00
9	479.03	38.15 QP	46.00	-7.85	1.00 V	10	19.55	18.60
10	500.42	39.17 QP	46.00	-6.83	1.00 V	136	19.91	19.25
11	527.64	39.62 QP	46.00	-6.38	1.25 V	313	19.54	20.08
12	663.74	35.60 QP	46.00	-10.40	1.25 V	346	13.17	22.43
13	842.61	35.44 QP	46.00	-10.56	1.00 V	16	9.86	25.58
14	854.28	35.41 QP	46.00	-10.59	1.50 V	31	9.74	25.67

- REMARKS:**
1. Emission level (dBuV/m) = Raw Value (dBuV) + Correction Factor (dB/m).
 2. Correction Factor (dB/m) = Antenna Factor (dB/m) + Cable Factor (dB).
 3. The other emission levels were very low against the limit.
 4. Margin value = Emission level – Limit value.



A D T

EUT TEST CONDITION		MEASUREMENT DETAIL	
CHANNEL	Channel 39	FREQUENCY RANGE	Below 1000MHz
INPUT POWER (SYSTEM)	120Vac, 60 Hz	DETECTOR FUNCTION	Quasi-Peak
ENVIRONMENTAL CONDITIONS	24deg. C, 64%RH 999 hPa	TEST MODE	C
TESTED BY	Match Tsui		

ANTENNA POLARITY & TEST DISTANCE: HORIZONTAL AT 3 M

NO.	FREQ. (MHz)	EMISSION LEVEL (dBuV/m)	LIMIT (dBuV/m)	MARGIN (dB)	ANTENNA HEIGHT (m)	TABLE ANGLE (Degree)	RAW VALUE (dBuV)	CORRECTION FACTOR (dB/m)
1	59.06	27.94 QP	40.00	-12.06	1.00 H	28	14.53	13.42
2	78.51	27.87 QP	40.00	-12.13	2.00 H	136	19.28	8.59
3	115.45	35.05 QP	43.50	-8.45	1.50 H	247	23.85	11.20
4	175.72	35.80 QP	43.50	-7.70	1.50 H	253	23.28	12.52
5	206.83	41.31 QP	43.50	-2.19	1.00 H	97	30.41	10.90
6	239.88	36.83 QP	46.00	-9.17	1.00 H	229	24.45	12.38
7	304.04	34.82 QP	46.00	-11.18	1.00 H	226	21.05	13.77
8	331.26	39.24 QP	46.00	-6.76	1.00 H	283	24.83	14.40
9	399.31	34.14 QP	46.00	-11.86	2.00 H	172	18.10	16.04
10	444.03	34.20 QP	46.00	-11.80	1.00 H	40	16.68	17.52
11	500.42	34.37 QP	46.00	-11.63	1.50 H	256	15.12	19.25
12	576.25	33.87 QP	46.00	-12.13	1.25 H	169	12.51	21.37
13	655.96	33.06 QP	46.00	-12.94	1.00 H	184	10.69	22.36

ANTENNA POLARITY & TEST DISTANCE: VERTICAL AT 3 M

NO.	FREQ. (MHz)	EMISSION LEVEL (dBuV/m)	LIMIT (dBuV/m)	MARGIN (dB)	ANTENNA HEIGHT (m)	TABLE ANGLE (Degree)	RAW VALUE (dBuV)	CORRECTION FACTOR (dB/m)
1	31.84	37.24 QP	40.00	-2.76	1.00 V	10	25.02	12.22
2	78.51	37.41 QP	40.00	-2.59	1.50 V	91	28.82	8.59
3	99.89	37.41 QP	43.50	-6.09	1.00 V	139	28.08	9.33
4	191.28	35.74 QP	43.50	-7.76	1.25 V	193	24.45	11.29
5	224.33	40.49 QP	46.00	-5.51	1.00 V	103	28.81	11.68
6	255.44	37.85 QP	46.00	-8.15	1.25 V	43	24.92	12.93
7	270.99	37.32 QP	46.00	-8.68	1.00 V	10	24.15	13.17
8	438.20	33.68 QP	46.00	-12.32	1.00 V	112	16.35	17.33
9	500.42	38.04 QP	46.00	-7.96	1.00 V	130	18.79	19.25
10	830.95	33.57 QP	46.00	-12.43	1.25 V	4	8.06	25.51

- REMARKS:**
1. Emission level (dBuV/m) = Raw Value (dBuV) + Correction Factor (dB/m).
 2. Correction Factor (dB/m) = Antenna Factor (dB/m) + Cable Factor (dB).
 3. The other emission levels were very low against the limit.
 4. Margin value = Emission level – Limit value.

4.2 NUMBER OF HOPPING FREQUENCY USED

4.2.1 LIMIT OF HOPPING FREQUENCY USED

At least 15 channels frequencies, and should be equally spaced.

4.2.2 TEST INSTRUMENTS

DESCRIPTION & MANUFACTURER	MODEL NO.	SERIAL NO.	DATE OF CALIBRATION	DUE DATE OF CALIBRATION
R&S SPECTRUM ANALYZER	FSP40	100040	Jul. 07, 2009	Jul. 06, 2010

NOTE: The calibration interval of the above test instruments is 12 months and the calibrations are traceable to NML/ROC and NIST/USA.

4.2.3 TEST PROCEDURES

- a. Check the calibration of the measuring instrument (SA) using either an internal calibrator or a known signal from an external generator.
- b. Turn on the EUT and connect its antenna terminal to measurement via a low loss cable. Then set it to any one measured frequency within its operating range and make sure the instrument is operated in its linear range.
- c. Set the SA on MaxHold Mode, and then keep the EUT in hopping mode. Record all the signals from each channel until each one has been recorded.
- d. Set the SA on View mode and then plot the result on SA screen.
- e. Repeat above procedures until all frequencies measured were complete.

4.2.4 DEVIATION FROM TEST STANDARD

No deviation.

4.2.5 TEST SETUP

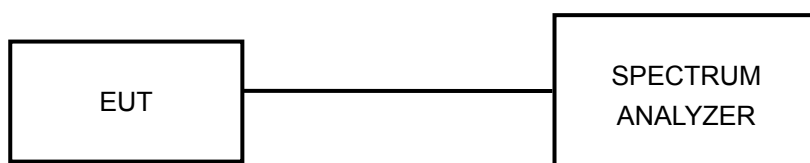

4.2.6 TEST RESULTS

There are 79 hopping frequencies in the hopping mode. Please refer to next two pages for the test result. On the plots, it shows that the hopping frequencies are equally spaced.



A D T

8DPSK MODULATION

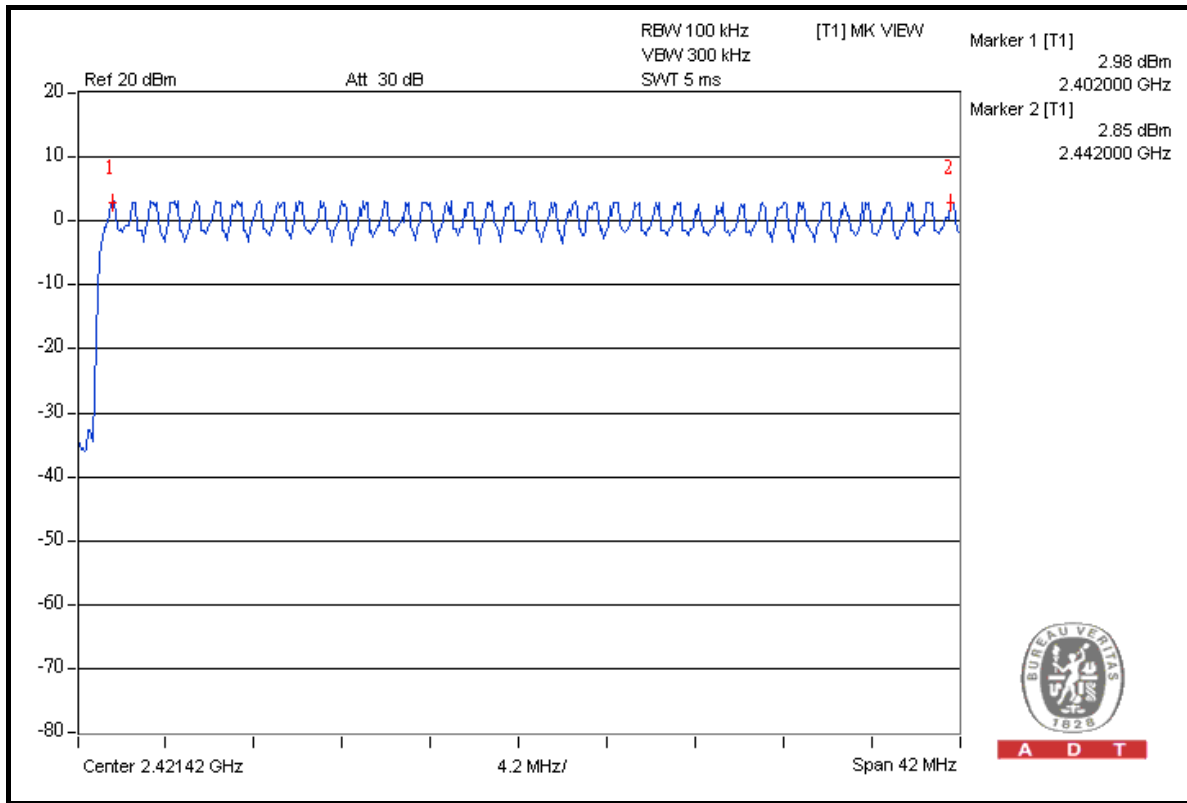

A D T

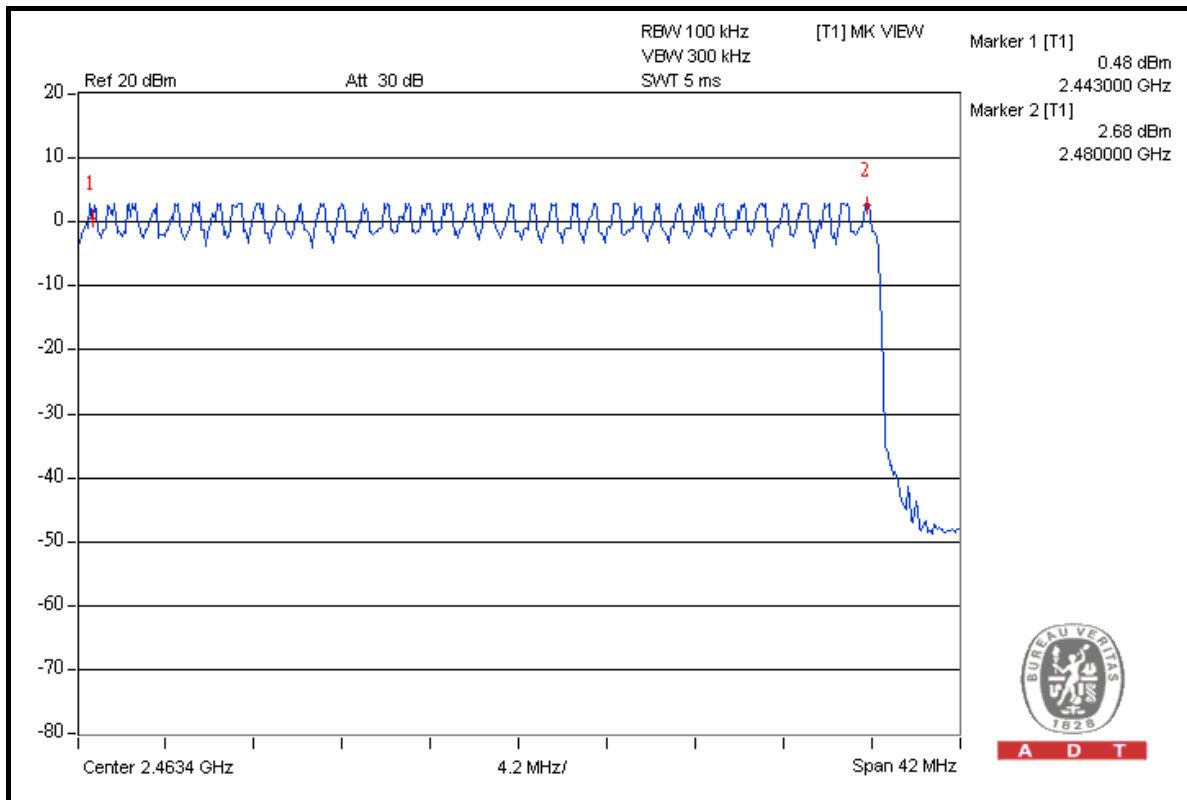

A D T



4.3 DWELL TIME ON EACH CHANNEL

4.3.1 LIMIT OF DWELL TIME USED

The average time of occupancy on any channel shall not be greater than 0.4 seconds within a period of 0.4 seconds multiplied by the number of hopping channels employed.

4.3.2 TEST INSTRUMENTS

DESCRIPTION & MANUFACTURER	MODEL NO.	SERIAL NO.	DATE OF CALIBRATION	DUE DATE OF CALIBRATION
R&S SPECTRUM ANALYZER	FSP40	100040	Jul. 07, 2009	Jul. 06, 2010

NOTE: The calibration interval of the above test instruments is 12 months and the calibrations are traceable to NML/ROC and NIST/USA.

4.3.3 TEST PROCEDURES

- a. Check the calibration of the measuring instrument (SA) using either an internal calibrator or a known signal from an external generator.
- b. Turn on the EUT and connect its antenna terminal to measurement via a low loss cable. Then set it to any one measured frequency within its operating range and make sure the instrument is operated in its linear range.
- c. Adjust the center frequency of SA on any frequency be measured and set SA to zero span mode. And then, set RBW and VBW of spectrum analyzer to proper value.
- d. Measure the time duration of one transmission on the measured frequency. And then plot the result with time difference of this time duration.
- e. Repeat above procedures until all different time-slot modes have been completed.

4.3.4 DEVIATION FROM TEST STANDARD

No deviation.

4.3.5 TEST SETUP

Same as 4.2.5.

4.3.6 TEST RESULTS

GFSK MODULATION

Mode	Number of transmission in a 31.6 (79Hopping*0.4)	Length of transmission time (msec)	Result (msec)	Limit (msec)
DH1	50 (times / 5 sec) * 6.32 = 316.00 times	0.450	142.200	400
DH3	25 (times / 5 sec) * 6.32 = 158.00 times	1.788	282.504	400
DH5	16 (times / 5 sec) * 6.32 = 101.22 times	2.960	299.315	400

NOTE: Test plots of the transmitting time slot are shown on next 3 pages.



A D T

DH1

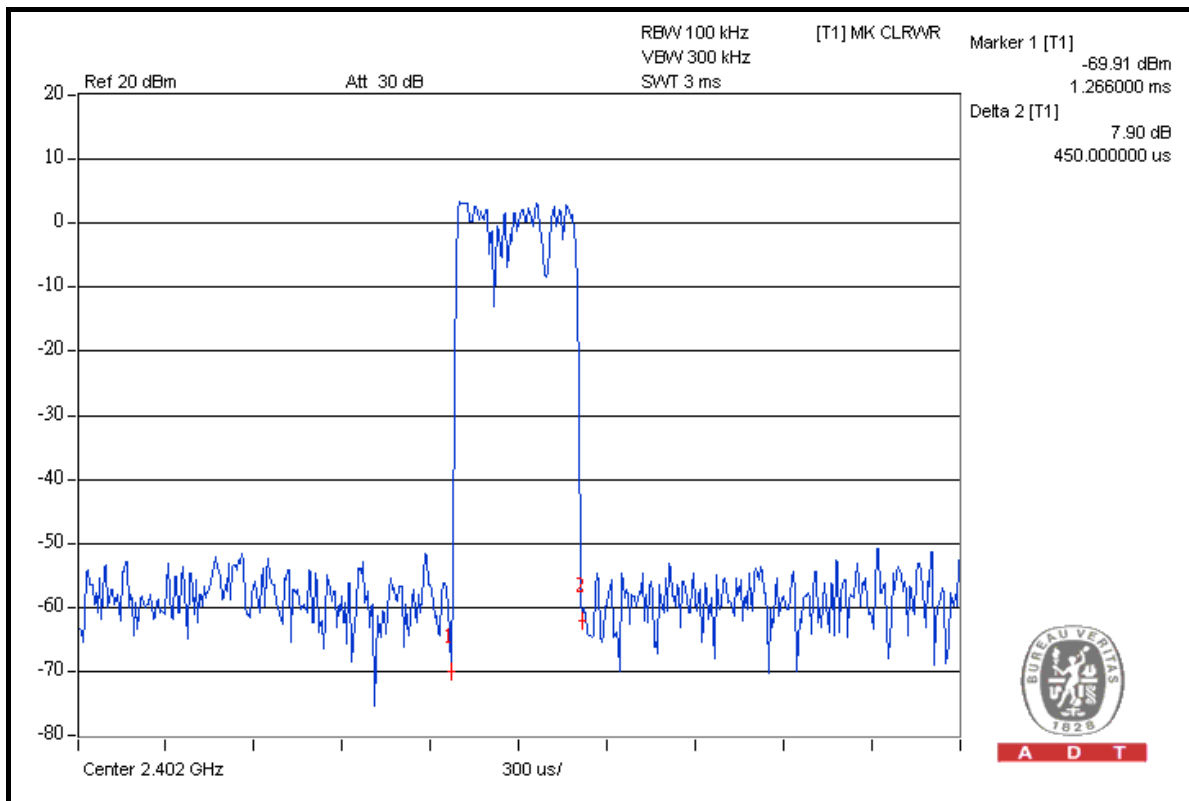
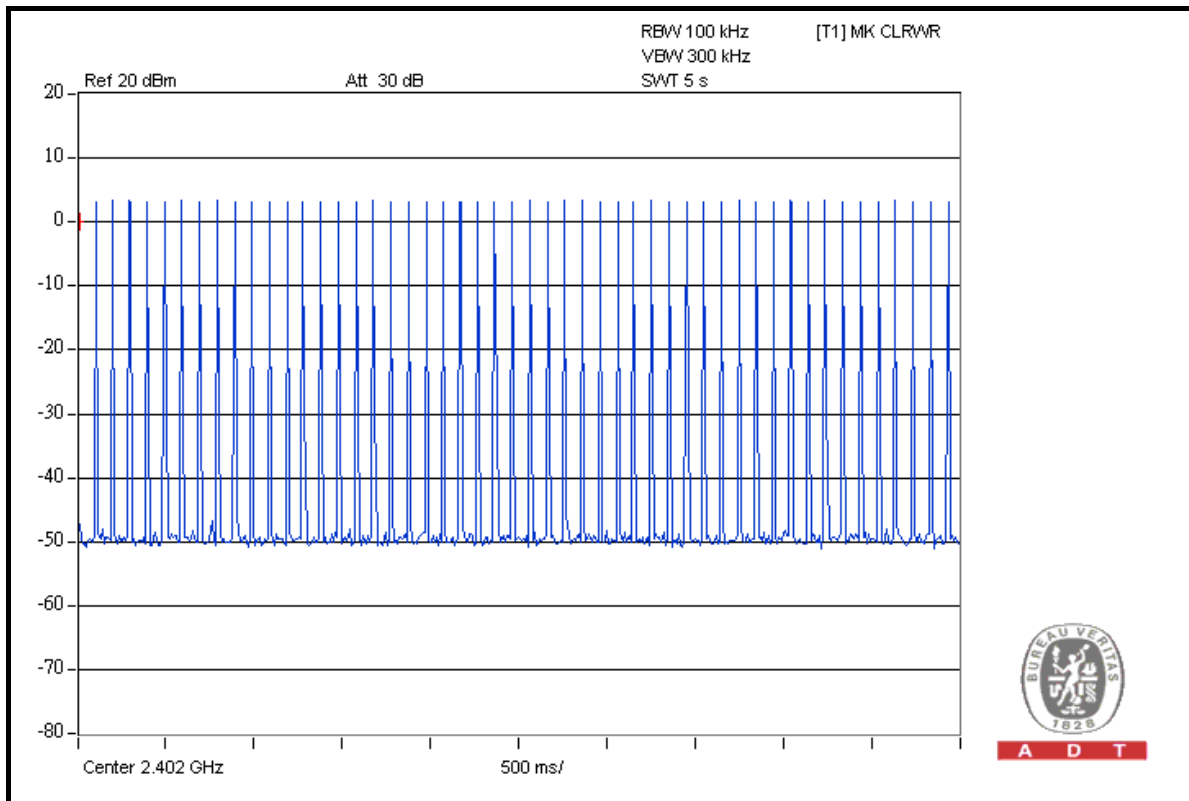



A D T

DH3

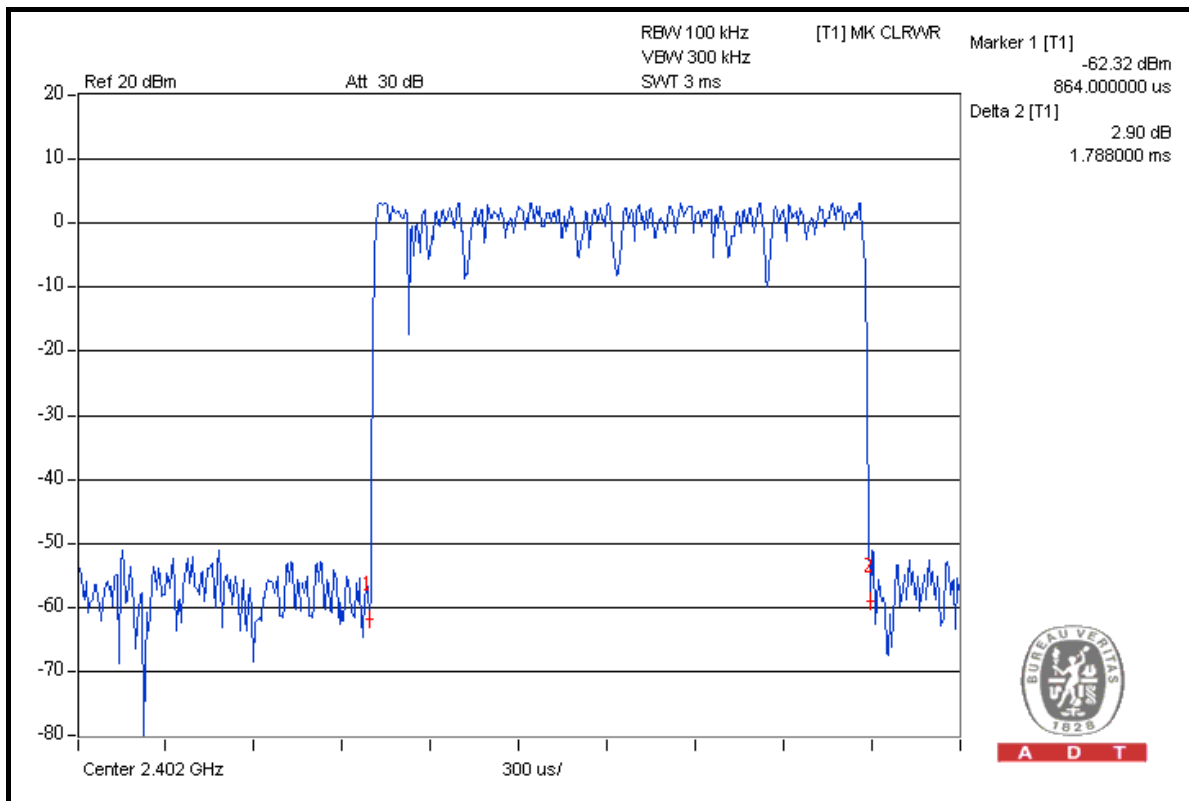
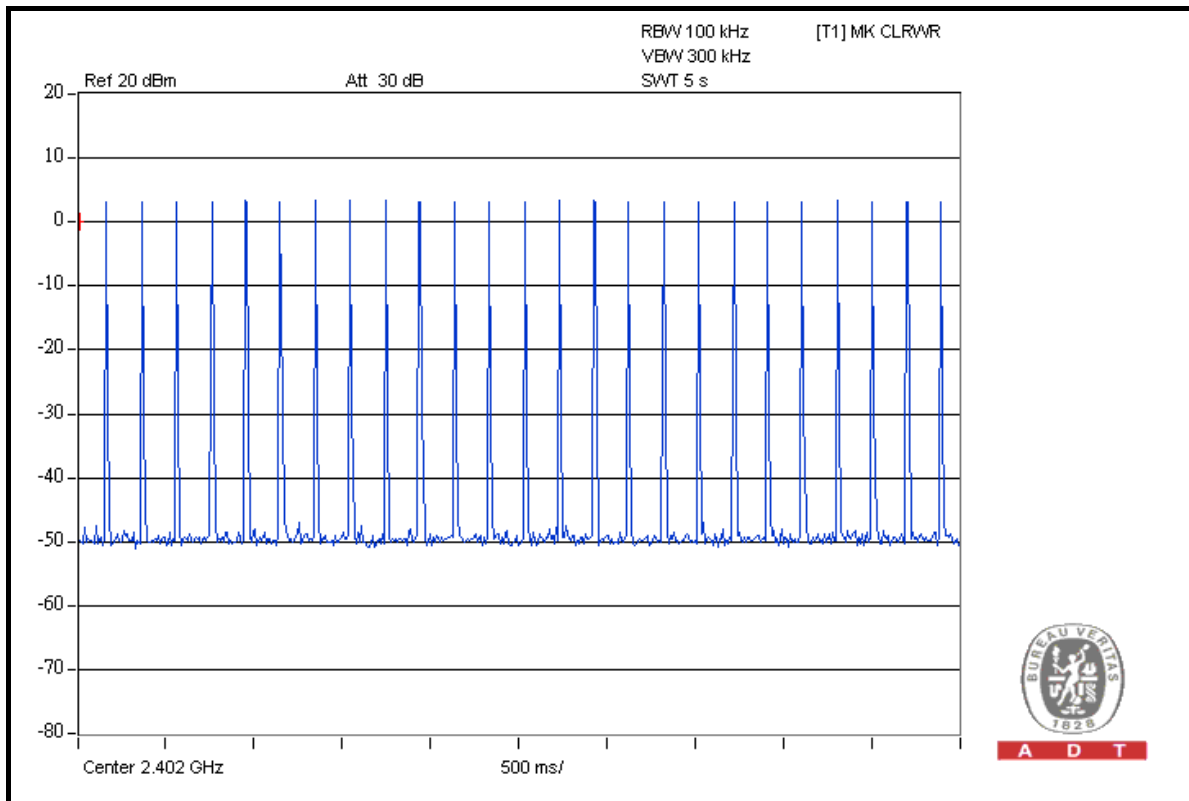



A D T

DH5

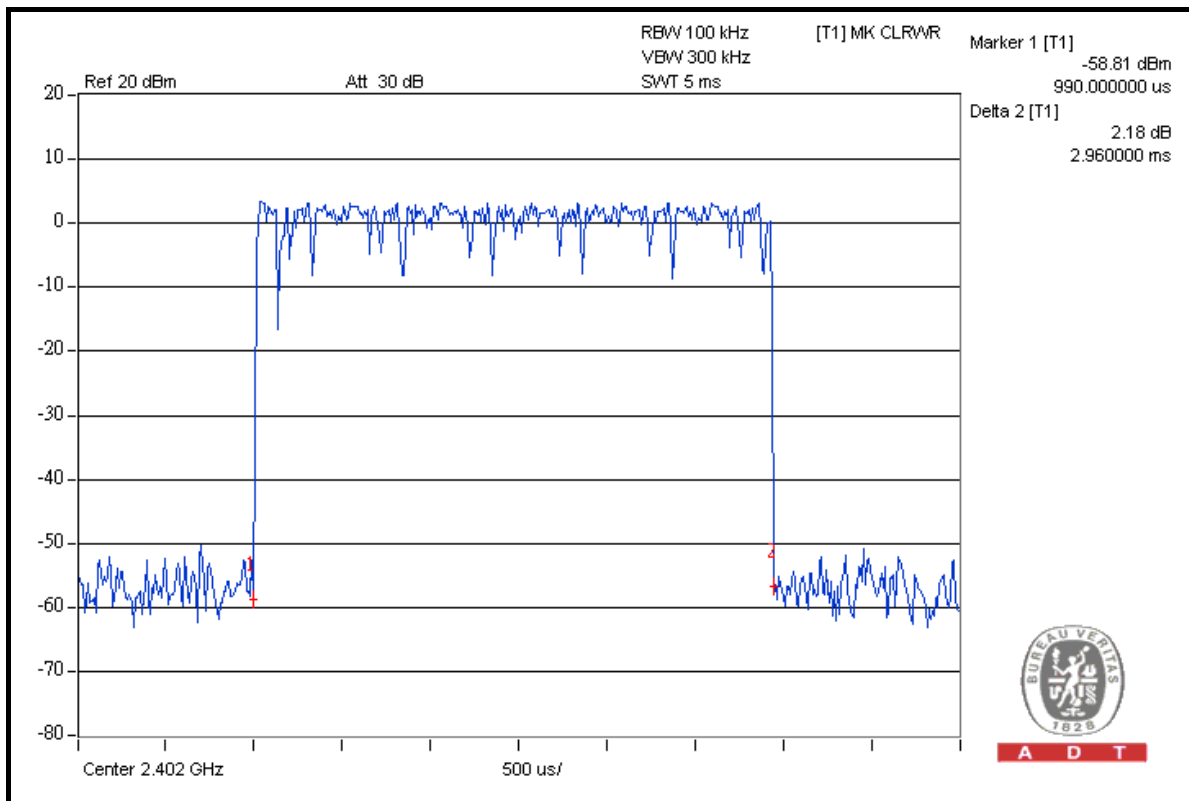
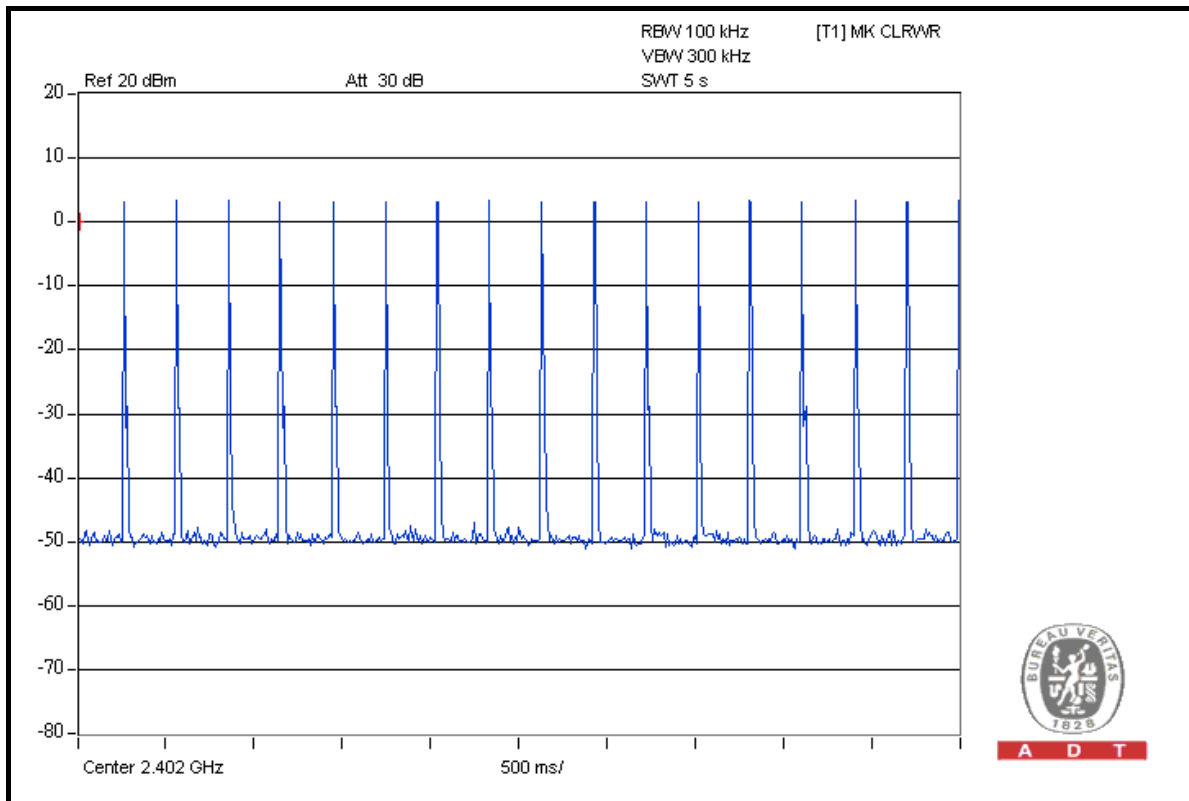

8DPSK MODULATION

Mode	Number of transmission in a 31.6 (79Hopping*0.4)	Length of transmission time (msec)	Result (msec)	Limit (msec)
DH1	$51 \text{ (times / 5 sec)} * 6.32 = 322.32 \text{ times}$	0.480	154.714	400
DH3	$25 \text{ (times / 5 sec)} * 6.32 = 158.00 \text{ times}$	1.722	272.076	400
DH5	$16 \text{ (times / 5 sec)} * 6.32 = 101.12 \text{ times}$	3.030	306.394	400

NOTE: Test plots of the transmitting time slot are shown on next 3 pages.



A D T

DH1

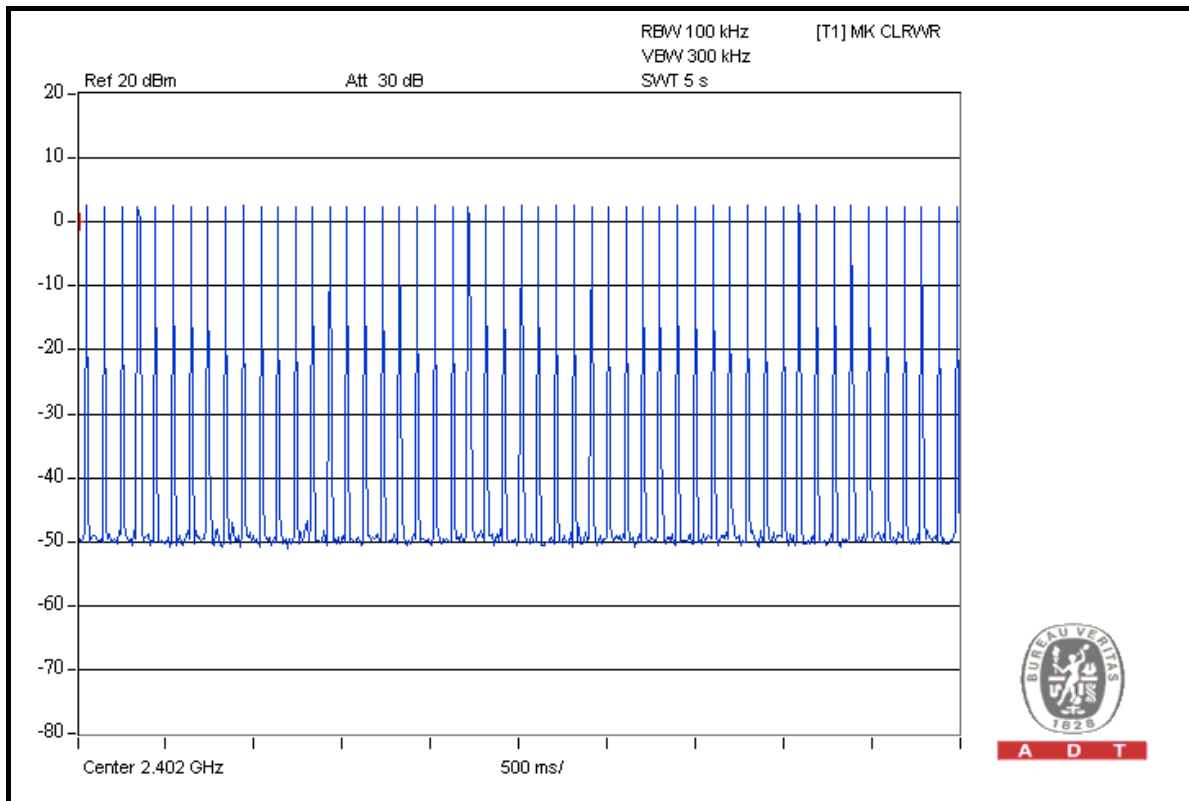

A D T

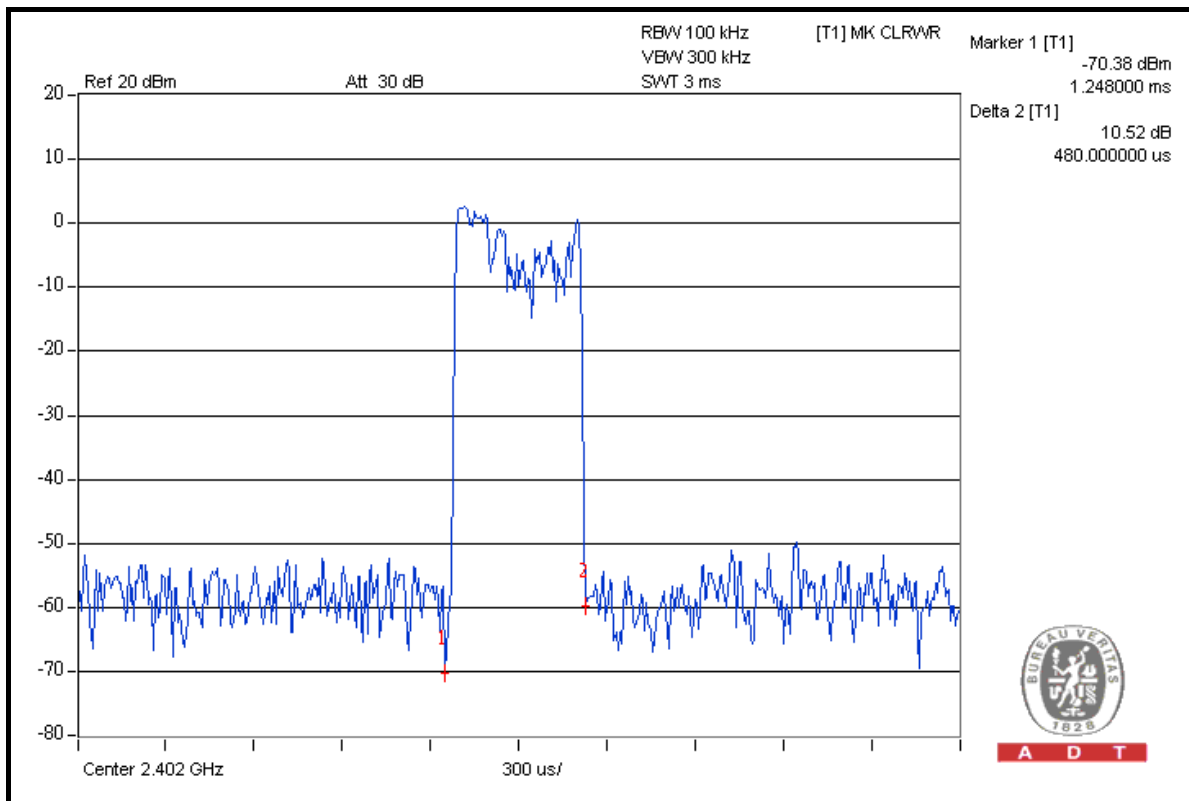

A D T



A D T

DH3

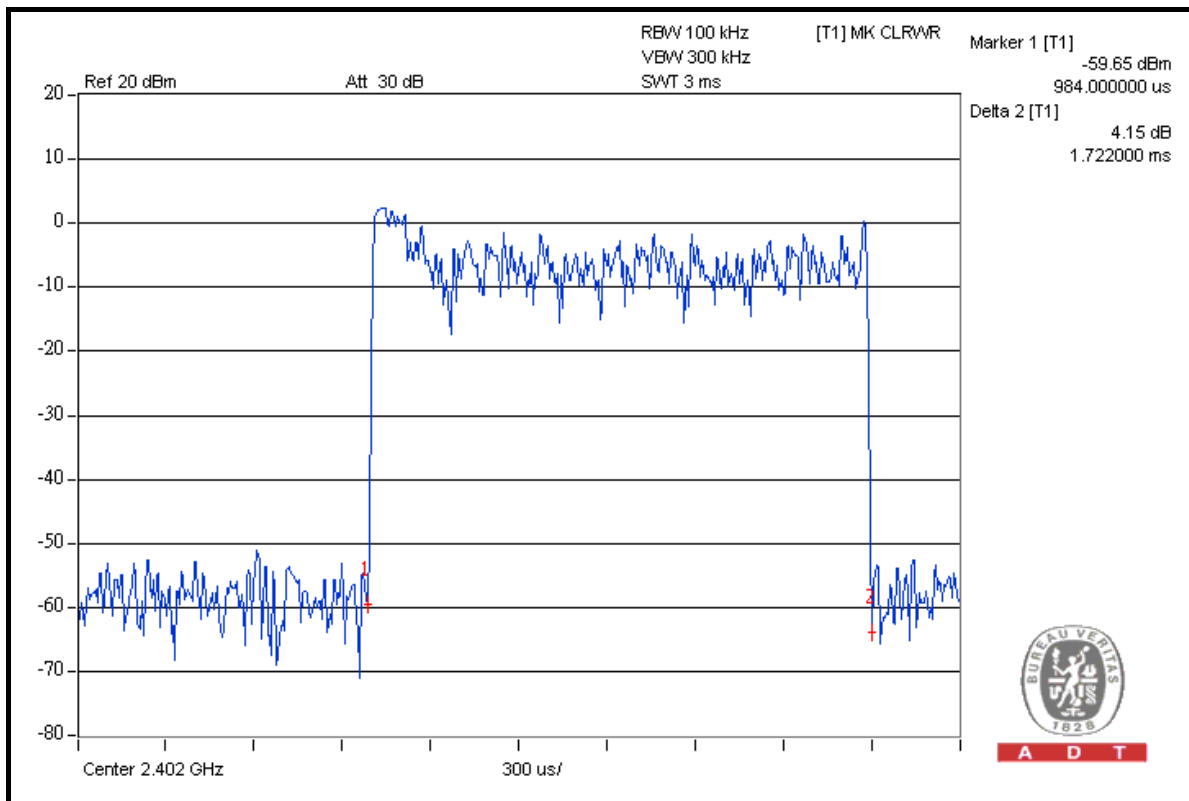
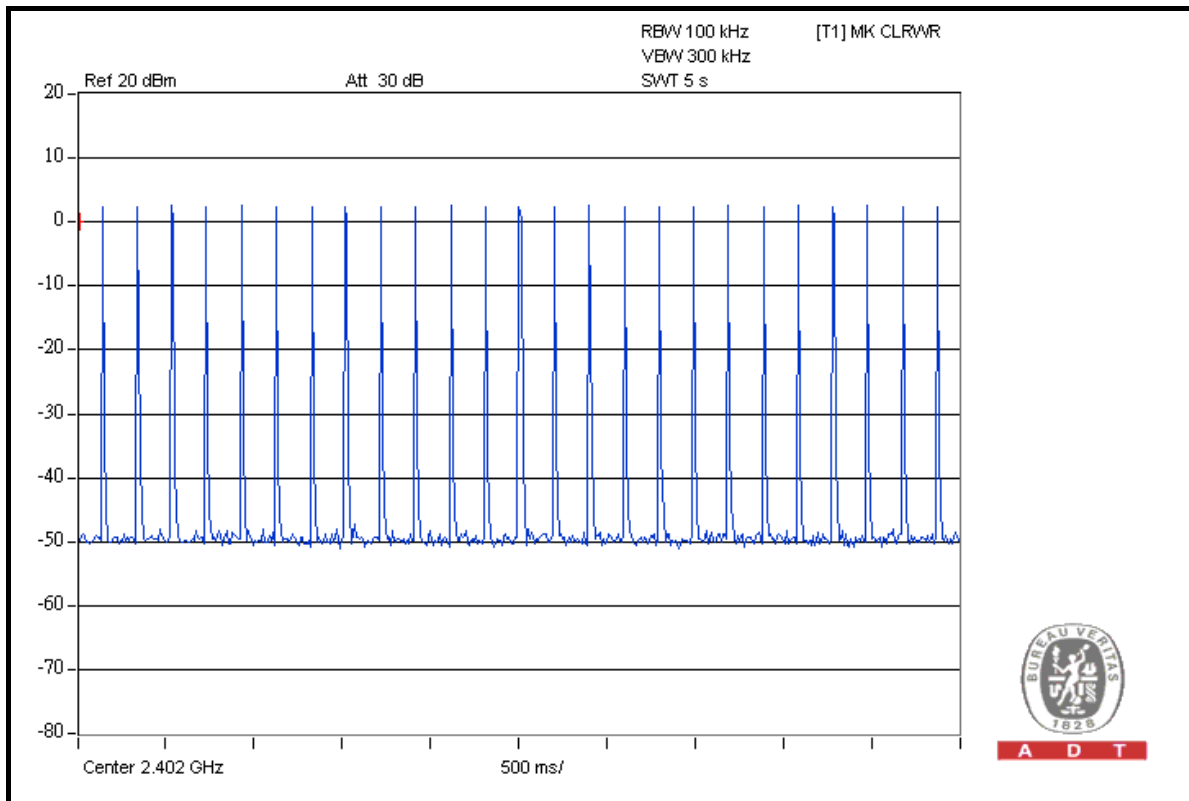



A D T

DH5

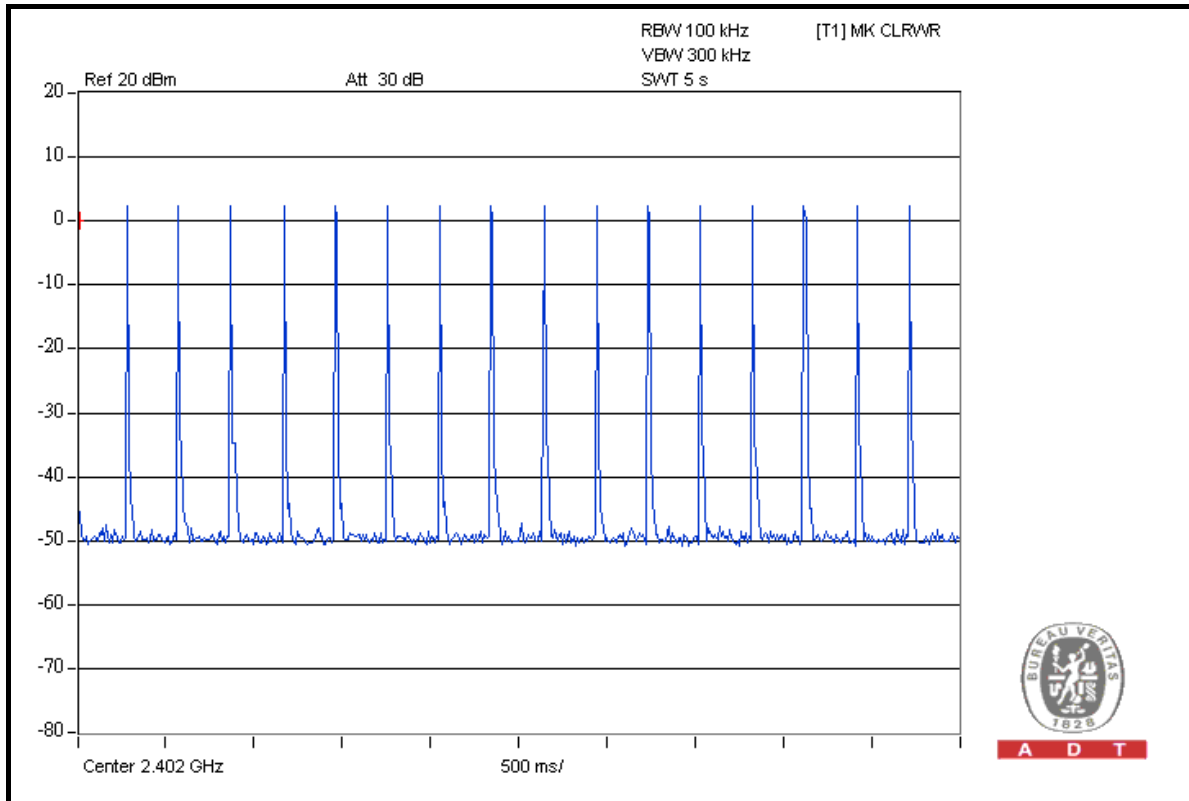

A D T

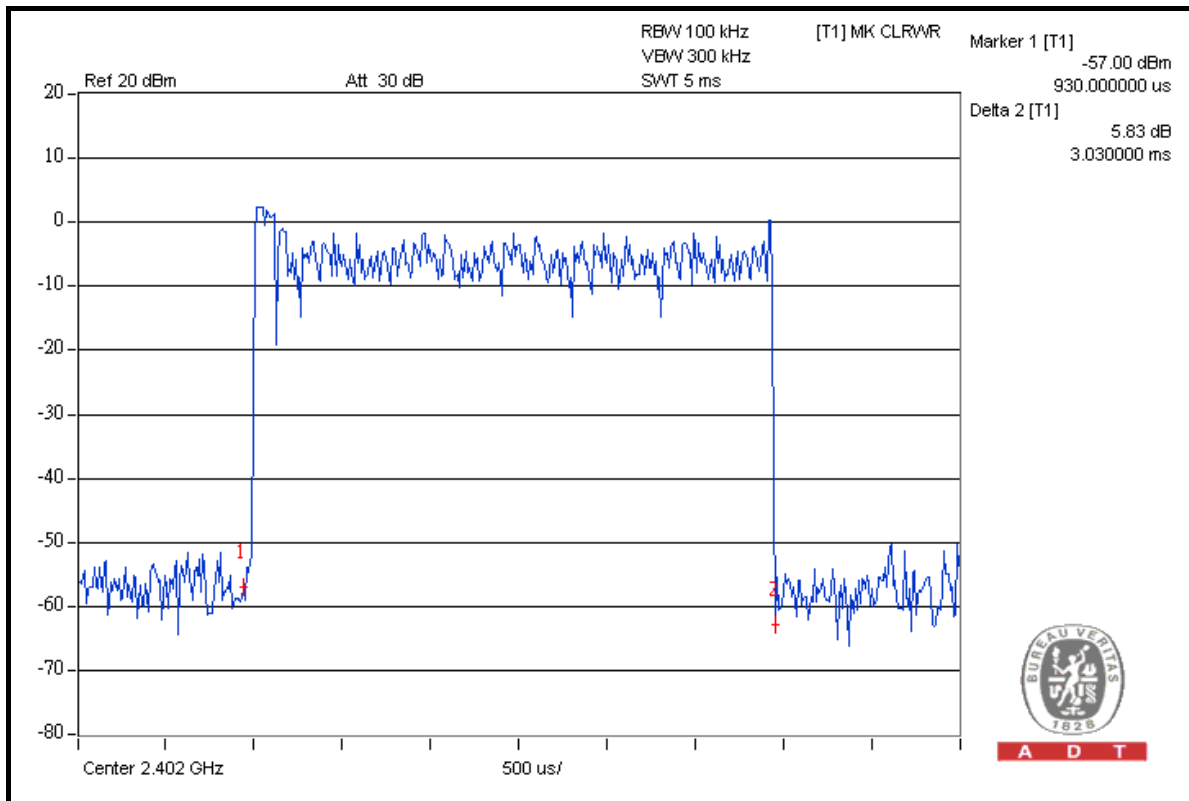

A D T

4.4 CHANNEL BANDWIDTH

4.4.1 LIMITS OF CHANNEL BANDWIDTH

For frequency hopping system operating in the 2400-2483.5MHz, If the 20dB bandwidth of hopping channel is greater than 25kHz, two-thirds 20dB bandwidth of hopping channel shall be a minimum limit for the hopping channel separation.

4.4.2 TEST INSTRUMENTS

DESCRIPTION & MANUFACTURER	MODEL NO.	SERIAL NO.	DATE OF CALIBRATION	DUE DATE OF CALIBRATION
R&S SPECTRUM ANALYZER	FSP40	100040	Jul. 07, 2009	Jul. 06, 2010

NOTE: The calibration interval of the above test instruments is 12 months and the calibrations are traceable to NML/ROC and NIST/USA.

4.4.3 TEST PROCEDURE

- a. Check the calibration of the measuring instrument using either an internal calibrator or a known signal from an external generator.
- b. Turn on the EUT and connect it to measurement instrument. Then set it to any one convenient frequency within its operating range. Set a reference level on the measuring instrument equal to the highest peak value.
- c. Measure the frequency difference of two frequencies that were attenuated 20dB from the reference level. Record the frequency difference as the emission bandwidth.
- d. Repeat above procedures until all frequencies measured were complete.

4.4.4 DEVIATION FROM TEST STANDARD

No deviation.

4.4.5 TEST SETUP

Same as 4.3.5.

4.4.6 EUT OPERATING CONDITION

The software provided by client enabled the EUT to transmit and receive data at lowest, middle and highest channel frequencies individually.



A D T

4.4.7 TEST RESULTS

GFSK MODULATION

MODULATION TYPE	GFSK	ENVIRONMENTAL CONDITIONS	25deg. C, 65% RH, 973 hPa
INPUT POWER	120 Vac, 60 Hz	TESTED BY	Match Tsui

CHANNEL	CHANNEL FREQUENCY (MHz)	20dB BANDWIDTH (MHz)
0	2402	0.933
39	2441	0.933
78	2480	0.948

CH 0

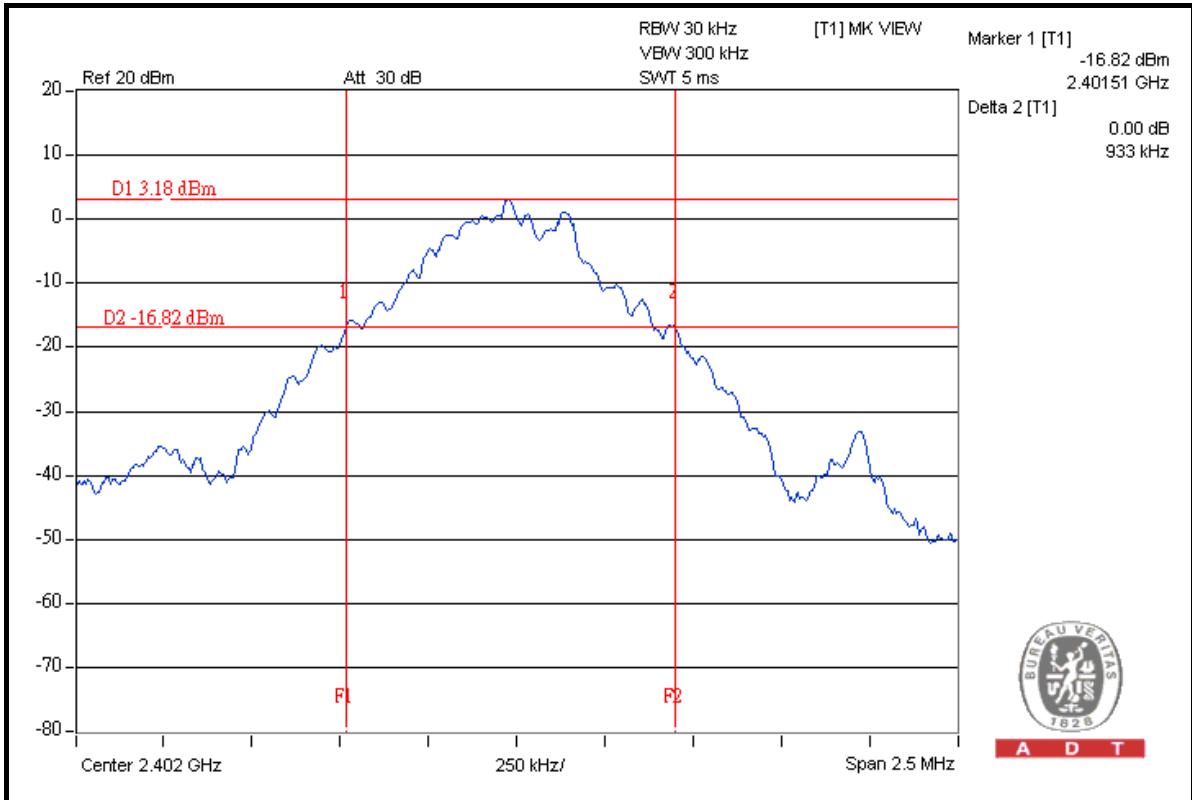



A D T

CH 39

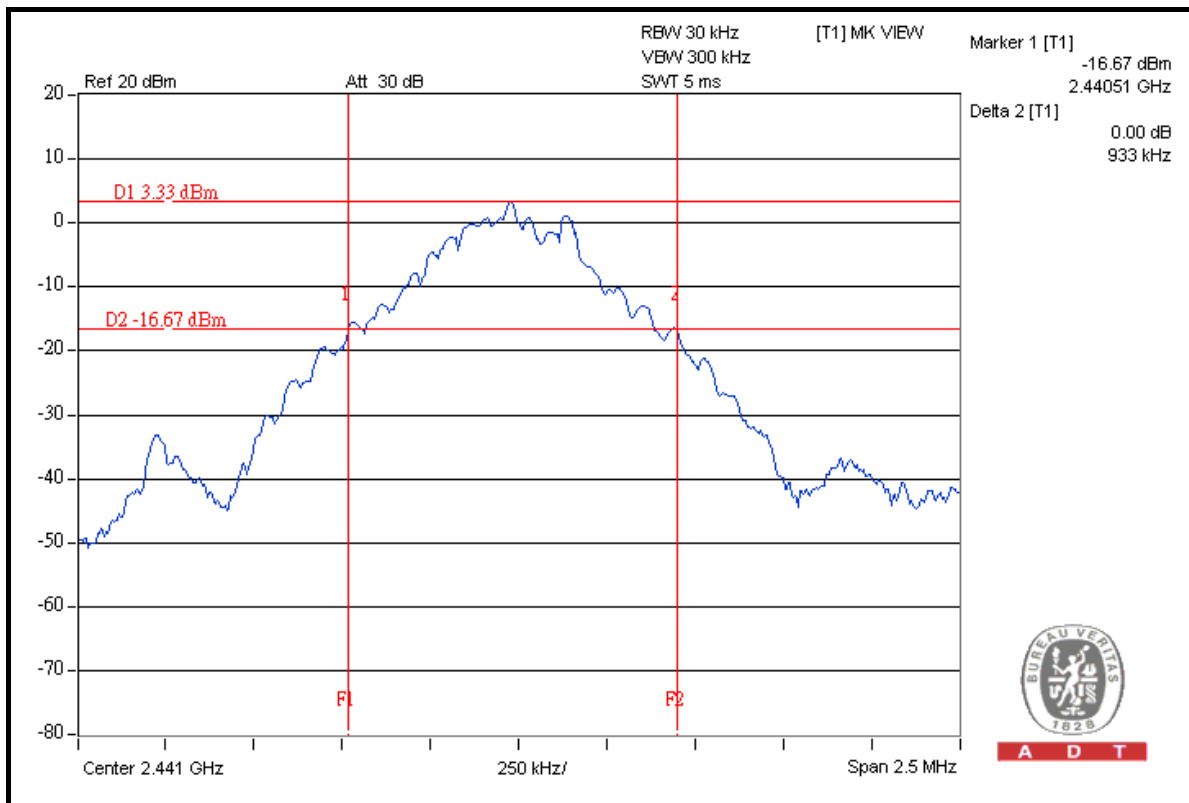

A D T

CH 78

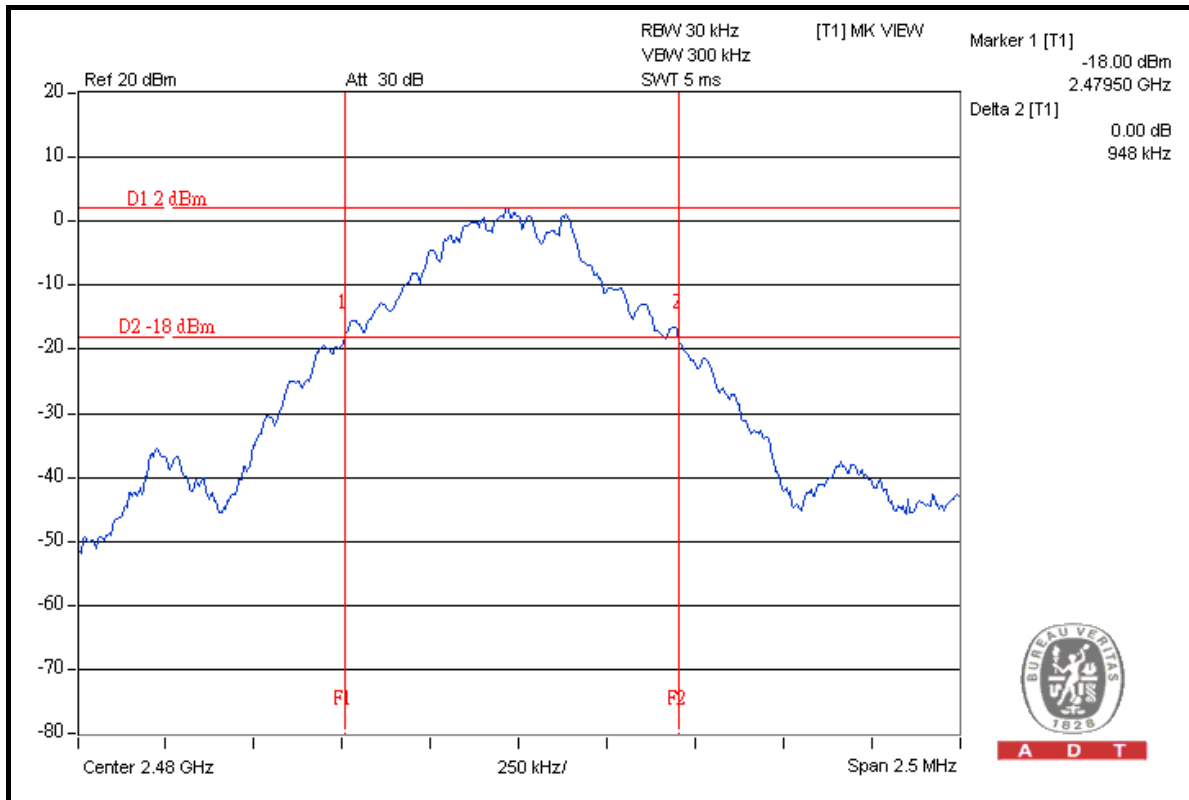

A D T



A D T

8DPSK MODULATION

MODULATION TYPE	8DPSK	ENVIRONMENTAL CONDITIONS	25 deg. C, 65% RH, 973 hPa
INPUT POWER	120 Vac, 60 Hz	TESTED BY	Match Tsui

CHANNEL	CHANNEL FREQUENCY (MHz)	20dB BANDWIDTH (MHz)
0	2402	1.260
39	2441	1.260
78	2480	1.260

CH 0

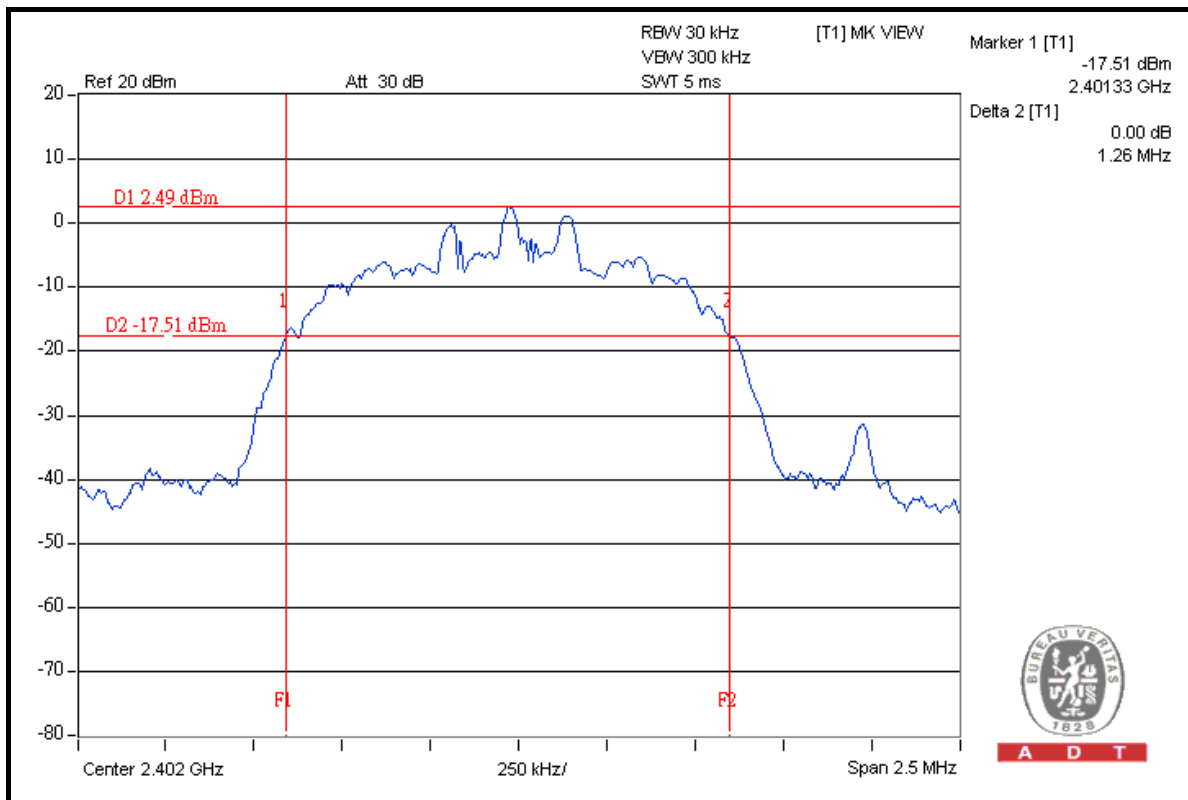



A D T

CH 39

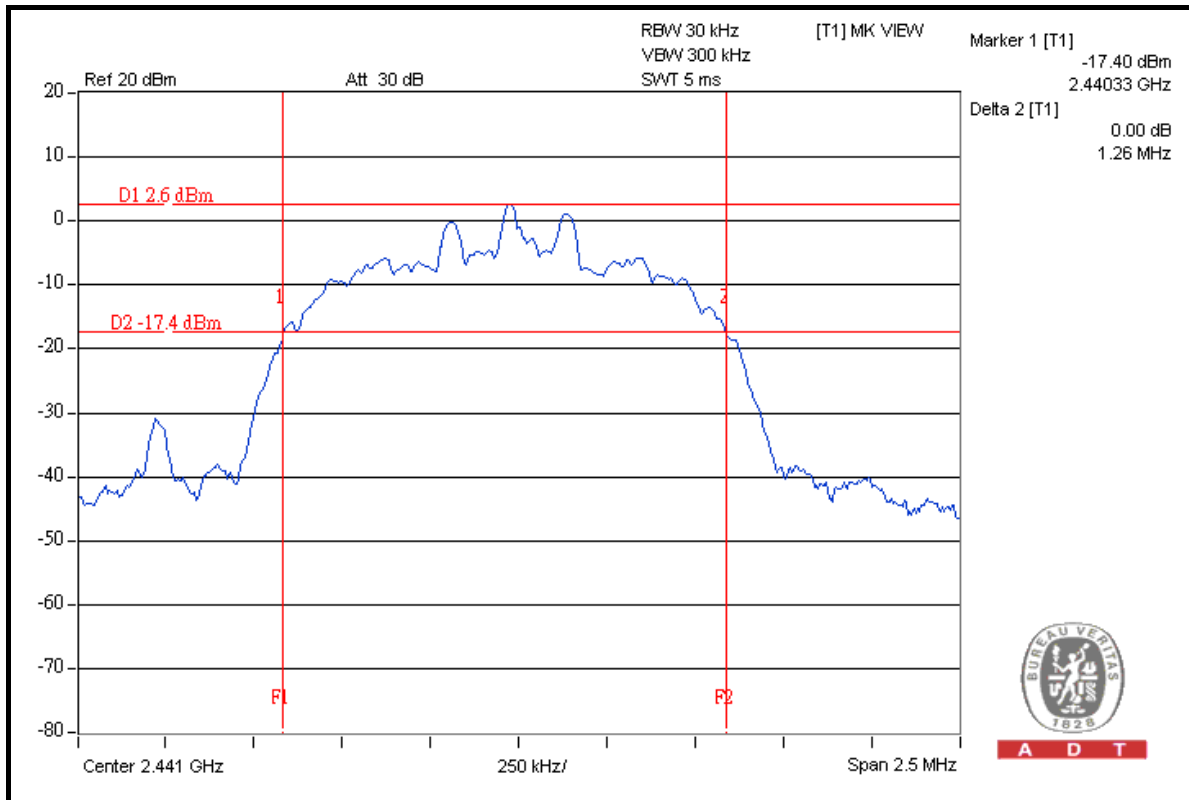

CH 78

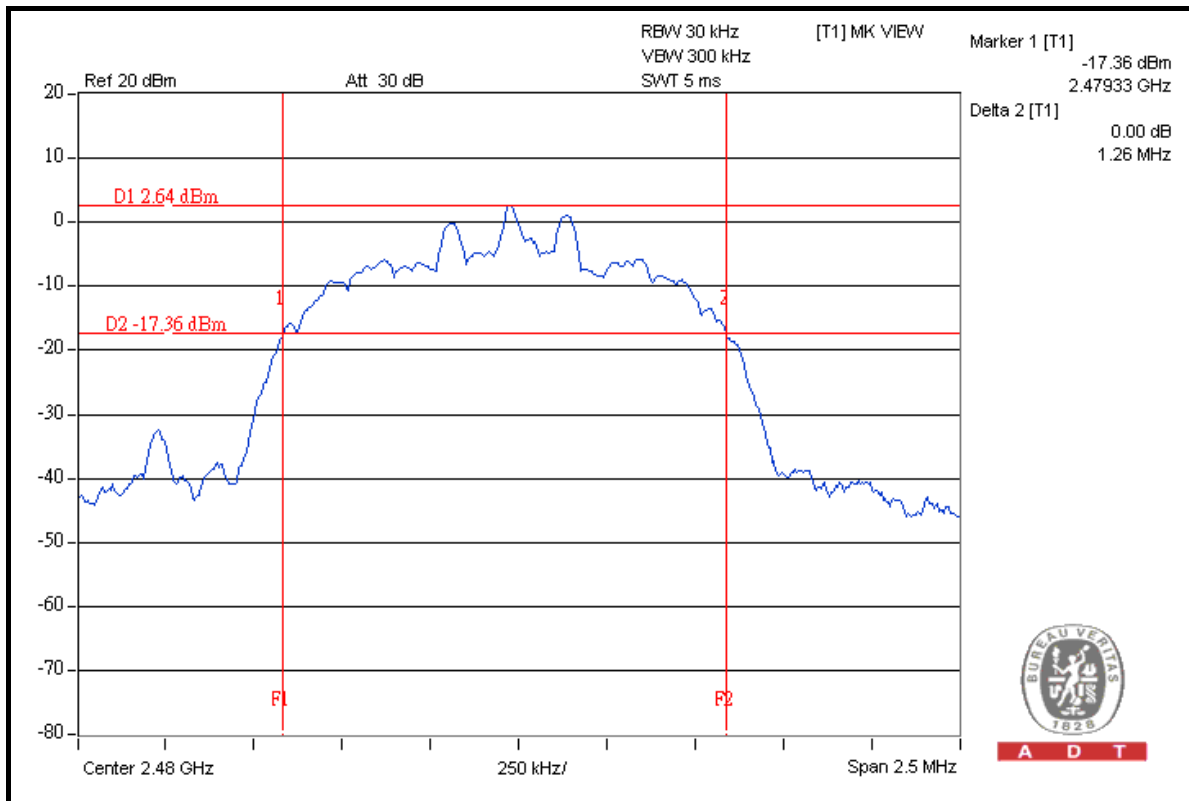

4.5 HOPPING CHANNEL SEPARATION

4.5.1 LIMIT OF HOPPING CHANNEL SEPARATION

At least 25kHz or two-third of 20dB hopping channel bandwidth (whichever is greater).

4.5.2 TEST INSTRUMENTS

DESCRIPTION & MANUFACTURER	MODEL NO.	SERIAL NO.	DATE OF CALIBRATION	DUE DATE OF CALIBRATION
R&S SPECTRUM ANALYZER	FSP40	100040	Jul. 07, 2009	Jul. 06, 2010

NOTE: The calibration interval of the above test instruments is 12 months and the calibrations are traceable to NML/ROC and NIST/USA.

4.5.3 TEST PROCEDURES

1. Check the calibration of the measuring instrument using either an internal calibrator or a known signal from an external generator.
2. Turn on the EUT and connect it to measurement instrument. Then set it to any one convenient frequency within its operating range.
3. By using the MaxHold function record the separation of two adjacent channels.
4. Measure the frequency difference of these two adjacent channels by SA MARK function. And then plot the result on SA screen.
5. Repeat above procedures until all frequencies measured were complete.

4.5.4 DEVIATION FROM TEST STANDARD

No deviation.

4.5.5 TEST SETUP

Same as 4.3.5.

4.5.6 TEST RESULTS

GFSK MODULATION

MODULATION TYPE	GFSK	ENVIRONMENTAL CONDITIONS	25 deg. C, 65% RH, 973 hPa
INPUT POWER	120 Vac, 60 Hz	TESTED BY	Match Tsui

CHANNEL	FREQUENCY (MHz)	ADJACENT CHANNEL SEPARATION (MHz)	20dB BANDWIDTH (MHz)	MINIMUM LIMIT (MHz)	PASS / FAIL
0	2402	1.010	0.933	0.622	PASS
39	2441	1.010	0.933	0.622	PASS
78	2480	1.010	0.948	0.632	PASS

NOTE: The minimum limit is two-third 20dB bandwidth. Test results please refer to next two pages.

CH 0

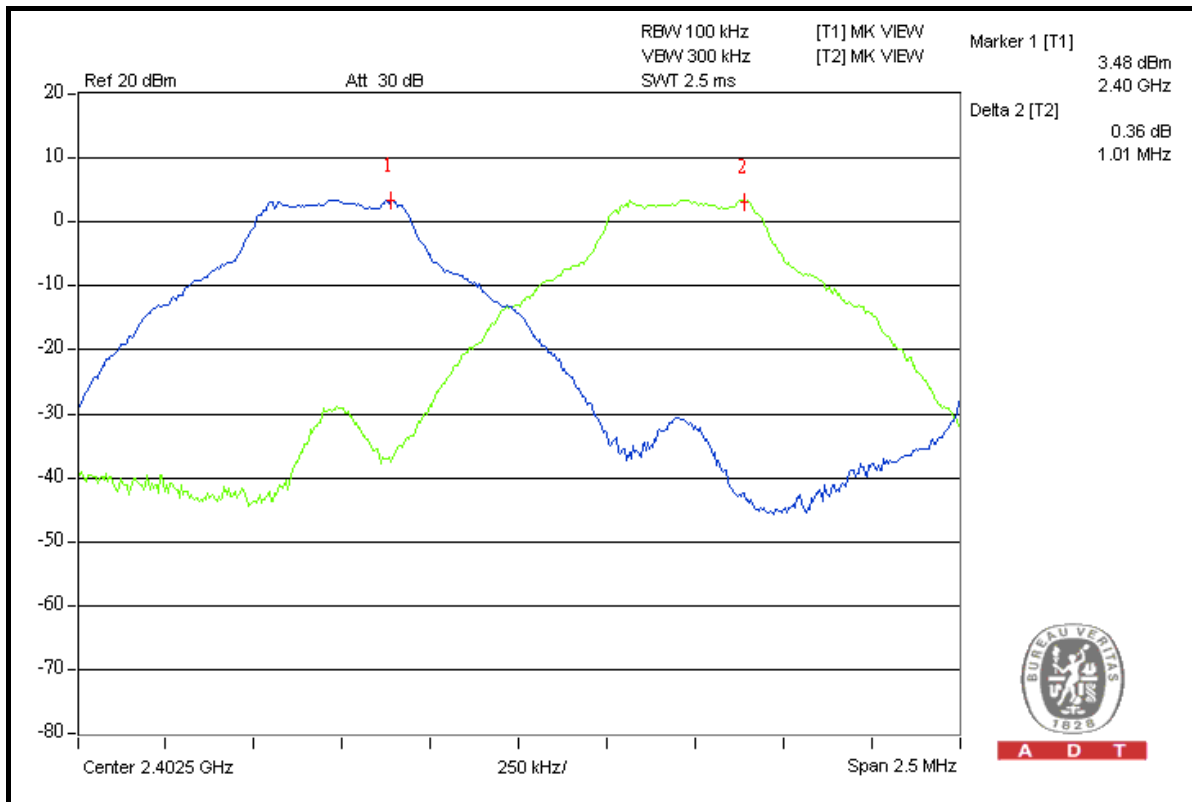



A D T

CH 39

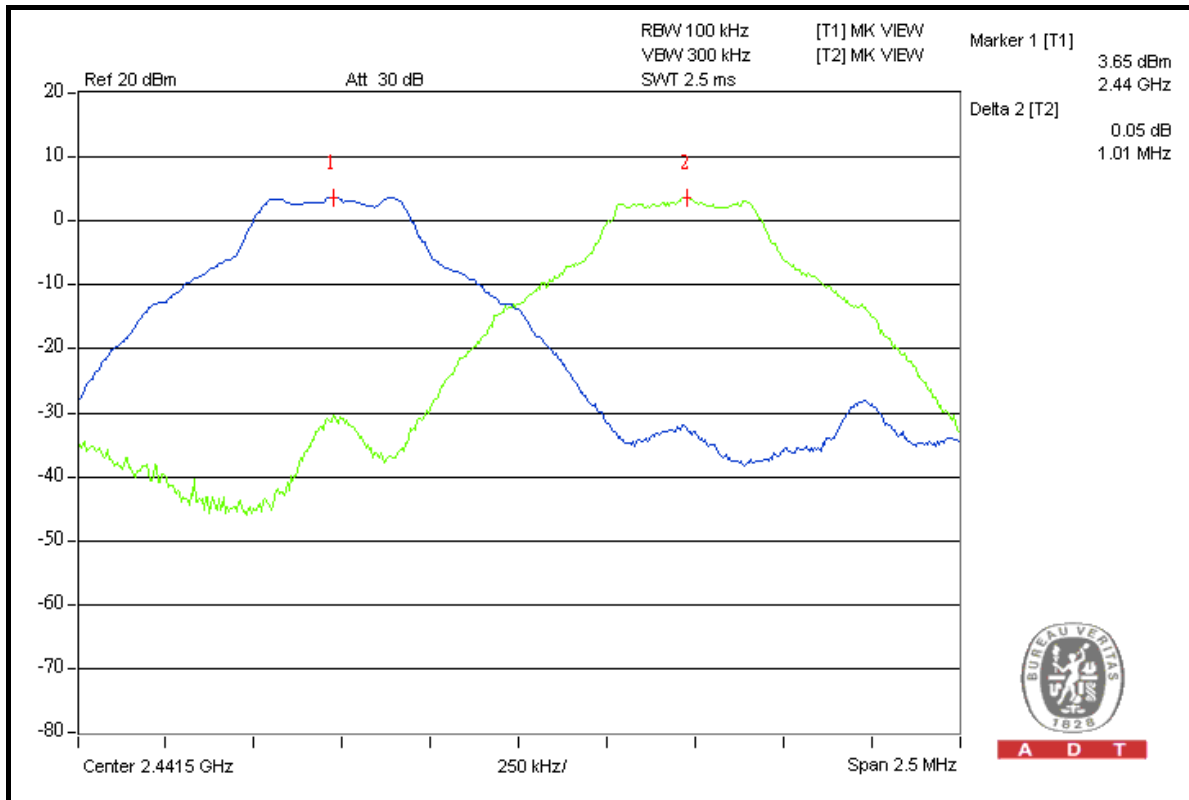

CH 78

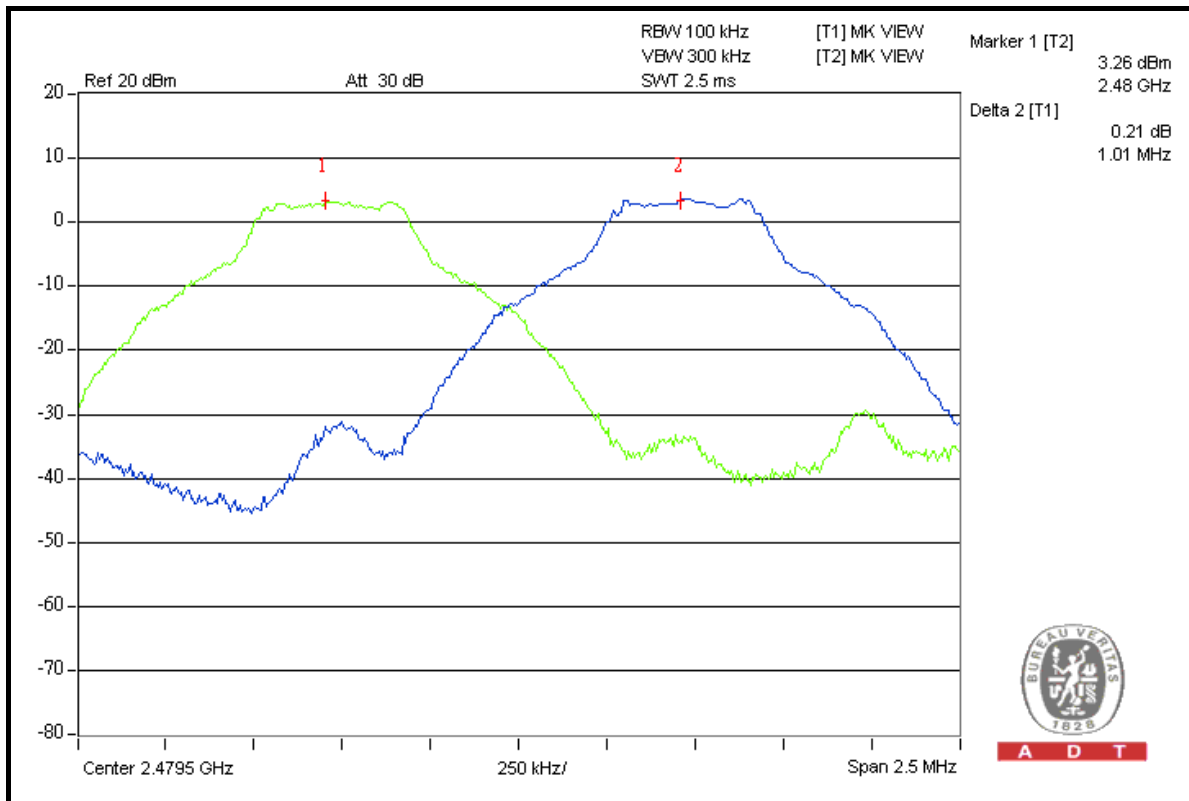



A D T

8DPSK MODULATION

MODULATION TYPE	8DPSK	ENVIRONMENTAL CONDITIONS	25deg. C, 65%RH, 1018hPa
INPUT POWER	120Vac, 60 Hz	TESTED BY	Match Tsui

CHANNEL	FREQUENCY (MHz)	ADJACENT CHANNEL SEPARATION (MHz)	20dB BANDWIDTH (MHz)	MINIMUM LIMIT (MHz)	PASS / FAIL
0	2402	1.000	1.260	0.840	PASS
39	2441	1.000	1.260	0.840	PASS
78	2480	1.000	1.260	0.840	PASS

NOTE: The minimum limit is two-third 20dB bandwidth. Test results please refer to next two pages.

CH 0

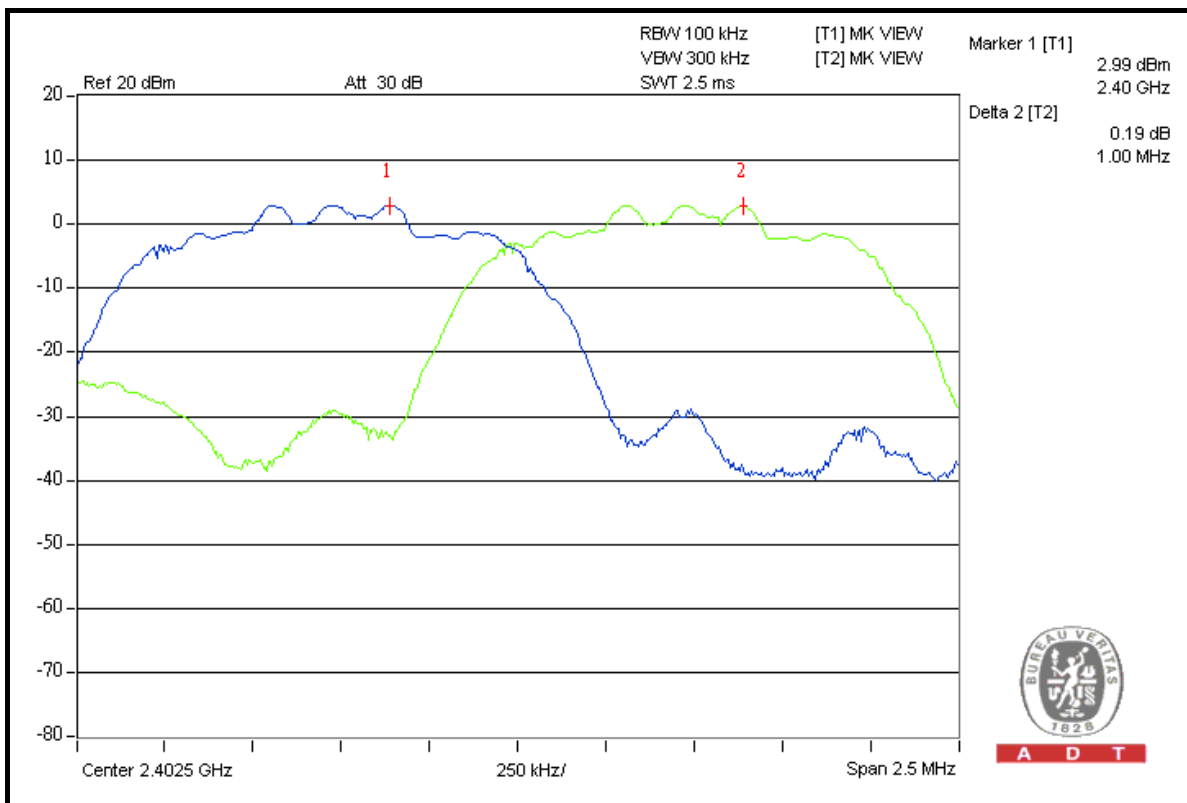



A D T

CH 39

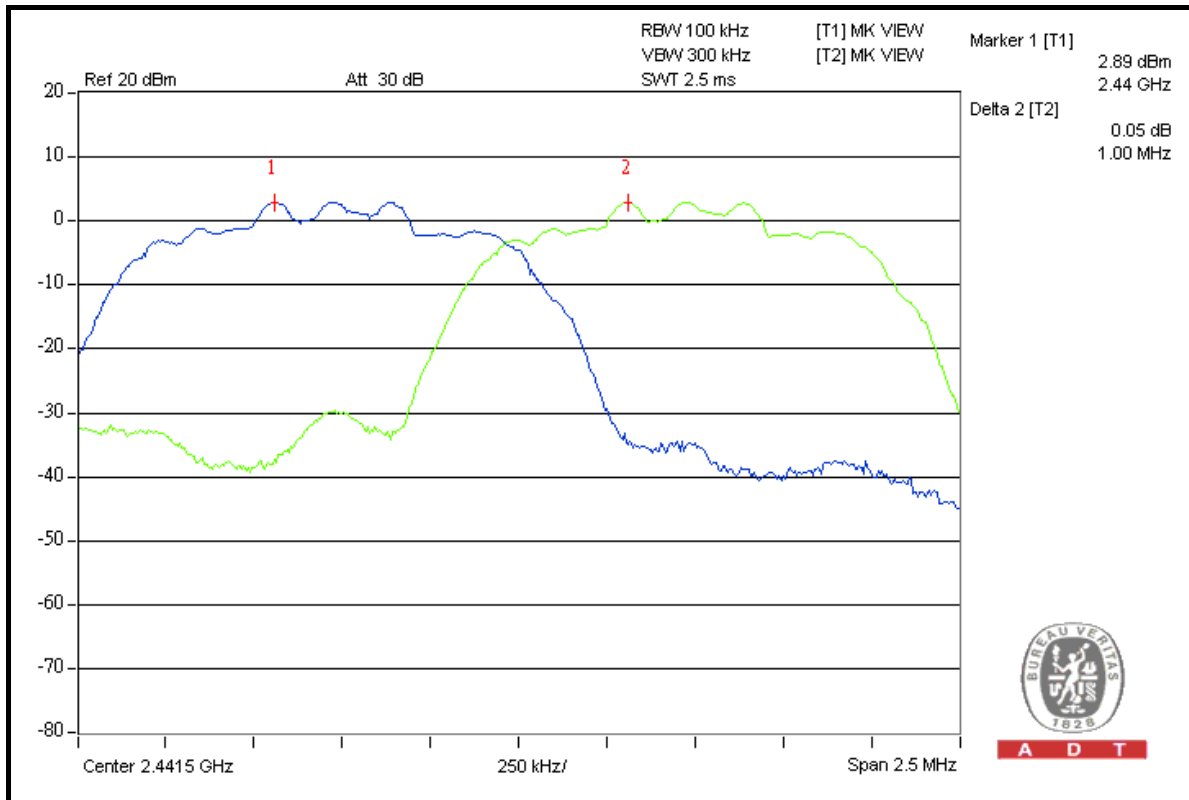

CH 78

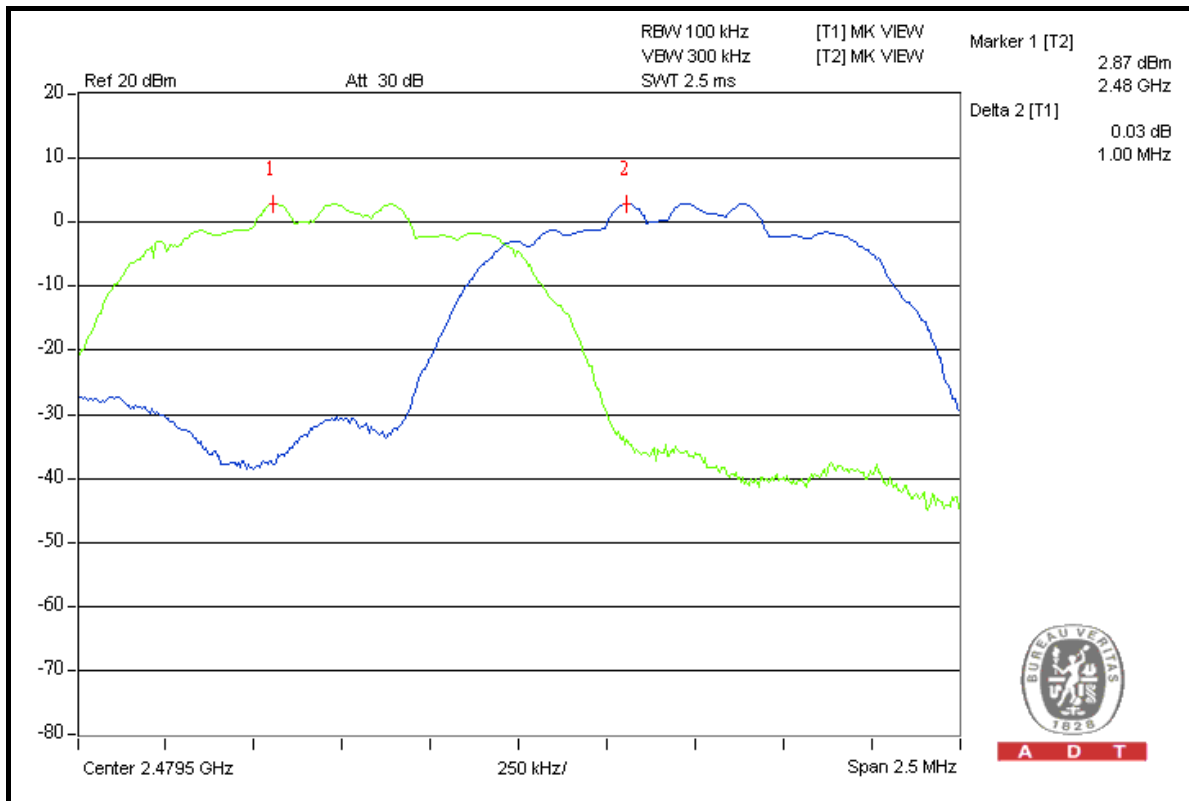



4.6 MAXIMUM PEAK OUTPUT POWER

4.6.1 LIMITS OF MAXIMUM PEAK OUTPUT POWER MEASUREMENT

The Maximum Peak Output Power Measurement is 125mW.

4.6.2 TEST INSTRUMENTS

DESCRIPTION & MANUFACTURER	MODEL NO.	SERIAL NO.	DATE OF CALIBRATION	DUE DATE OF CALIBRATION
R&S SPECTRUM ANALYZER	FSP40	100040	Jul. 07, 2009	Jul. 06, 2010

NOTE: The calibration interval of the above test instruments is 12 months and the calibrations are traceable to NML/ROC and NIST/USA.

4.6.3 TEST PROCEDURES

- a. Check the calibration of the measuring instrument using either an internal calibrator or a known signal from an external generator.
- b. Turn on the EUT and connect it to measurement instrument. Then set it to any one convenient frequency within its operating range. Set a reference level on the measuring instrument equal to the highest peak value.
- c. The center frequency of the spectrum analyzer is set to the fundamental frequency and using 3MHz RBW and 10 MHz VBW.
- d. Measure the captured power within the band and recording the plot.
- e. Repeat above procedures until all frequencies required were complete.

4.6.4 DEVIATION FROM TEST STANDARD

No deviation.

4.6.5 TEST SETUP

Same as 4.3.5.

4.6.6 EUT OPERATING CONDITION

The software provided by client enabled the EUT to transmit and receive data at lowest, middle and highest channel frequencies individually.



A D T

CH 39

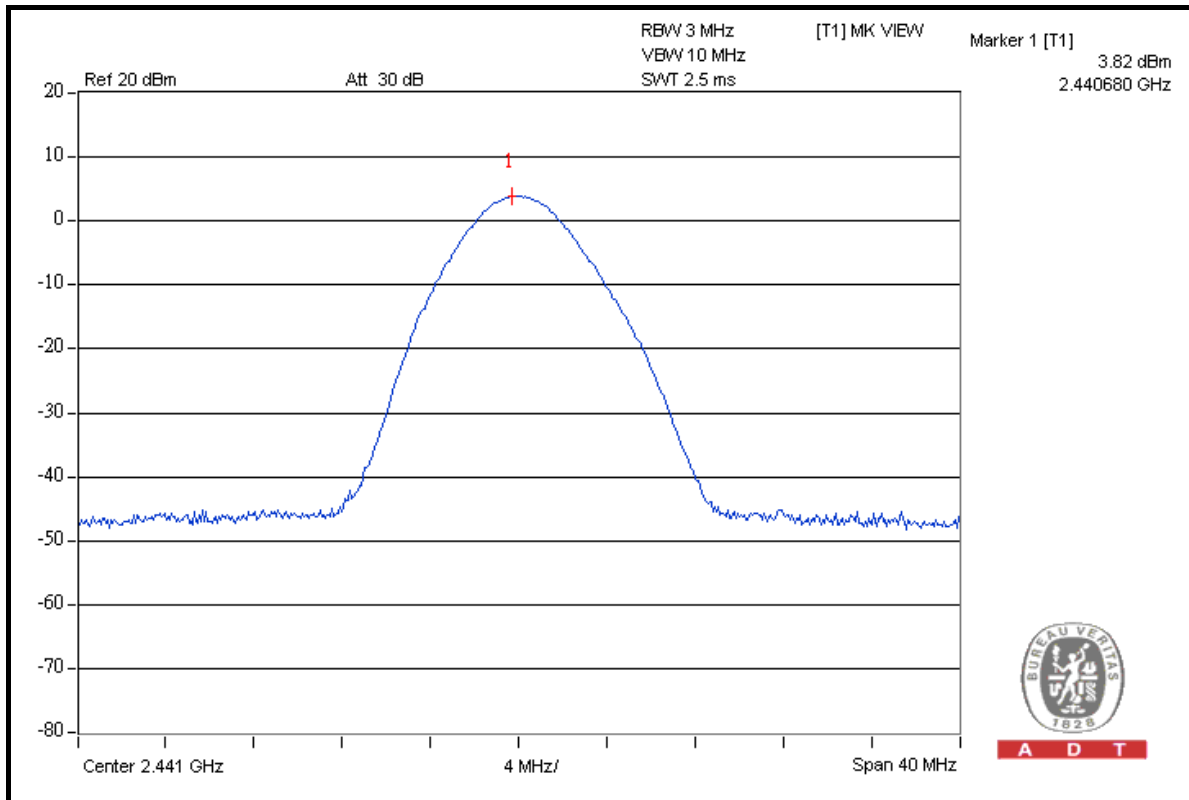

CH 78

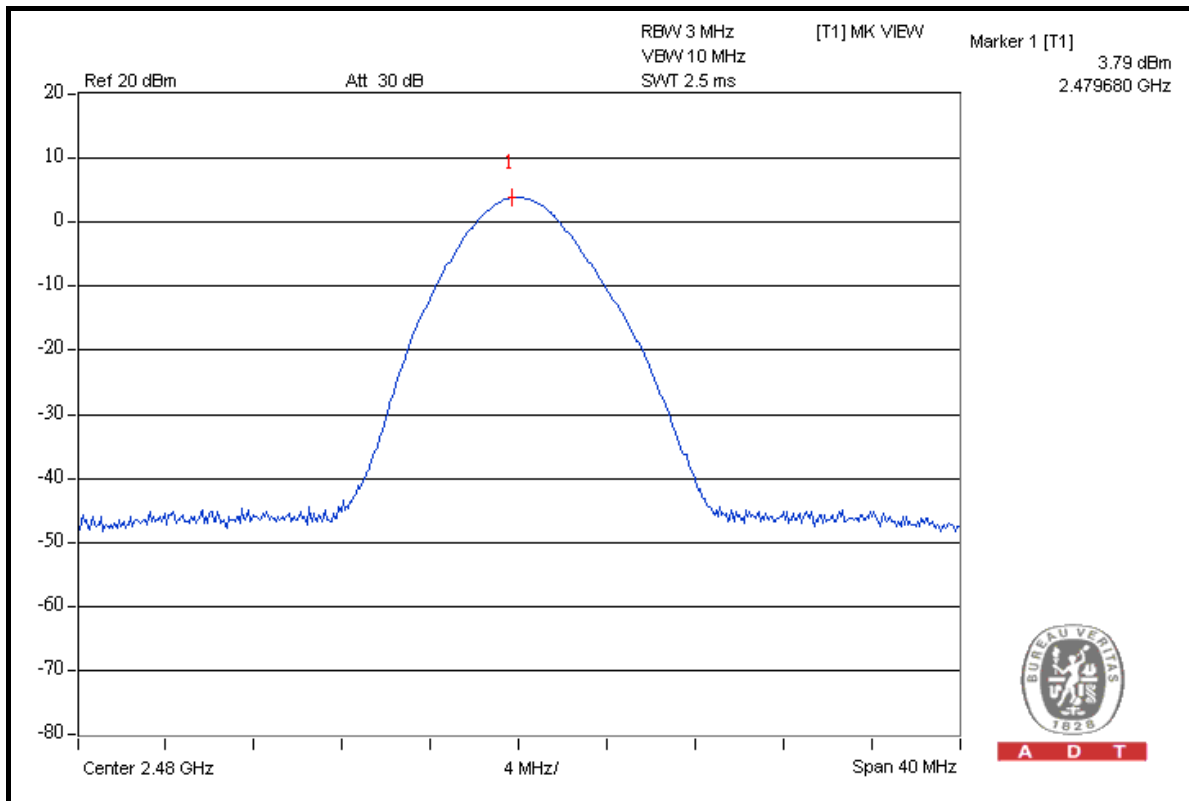



A D T

8DPSK MODULATION

MODULATION TYPE	8DPSK	ENVIRONMENTAL CONDITIONS	25deg. C, 65%RH, 1018hPa
INPUT POWER	120Vac, 60 Hz	TESTED BY	Match Tsui

CHANNEL	CHANNEL FREQUENCY (MHz)	PEAK POWER OUTPUT (mW)	PEAK POWER OUTPUT (dBm)	PEAK POWER LIMIT (mW)	PASS/FAIL
0	2402	2.344	3.70	125	PASS
39	2441	2.377	3.76	125	PASS
78	2480	2.360	3.73	125	PASS

CH 0

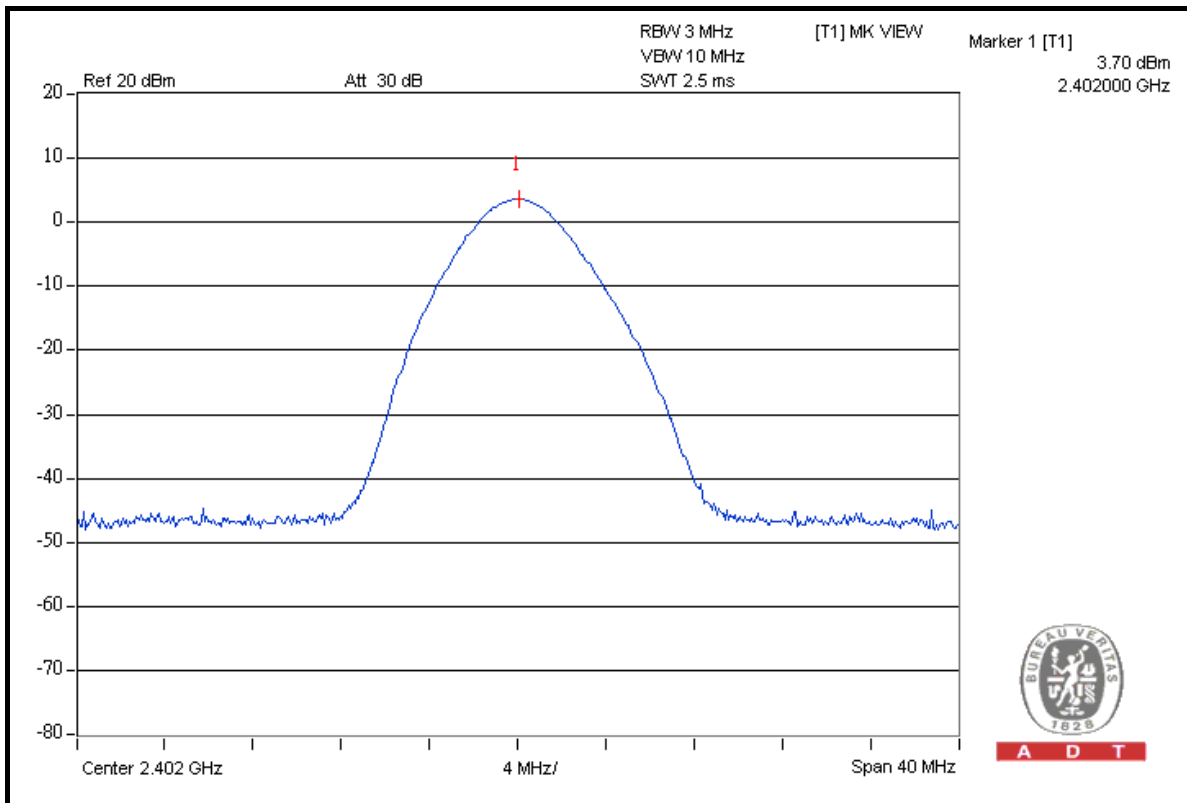

A D T



A D T

CH 39

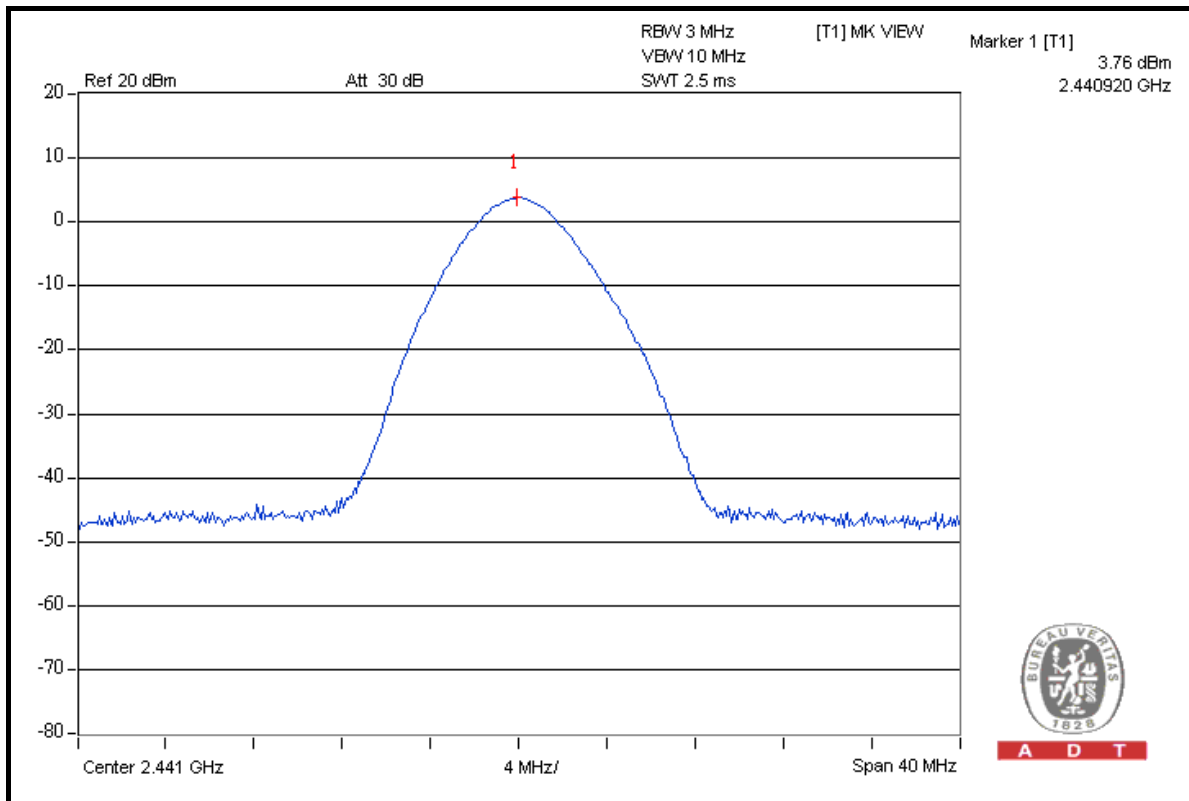

CH 78

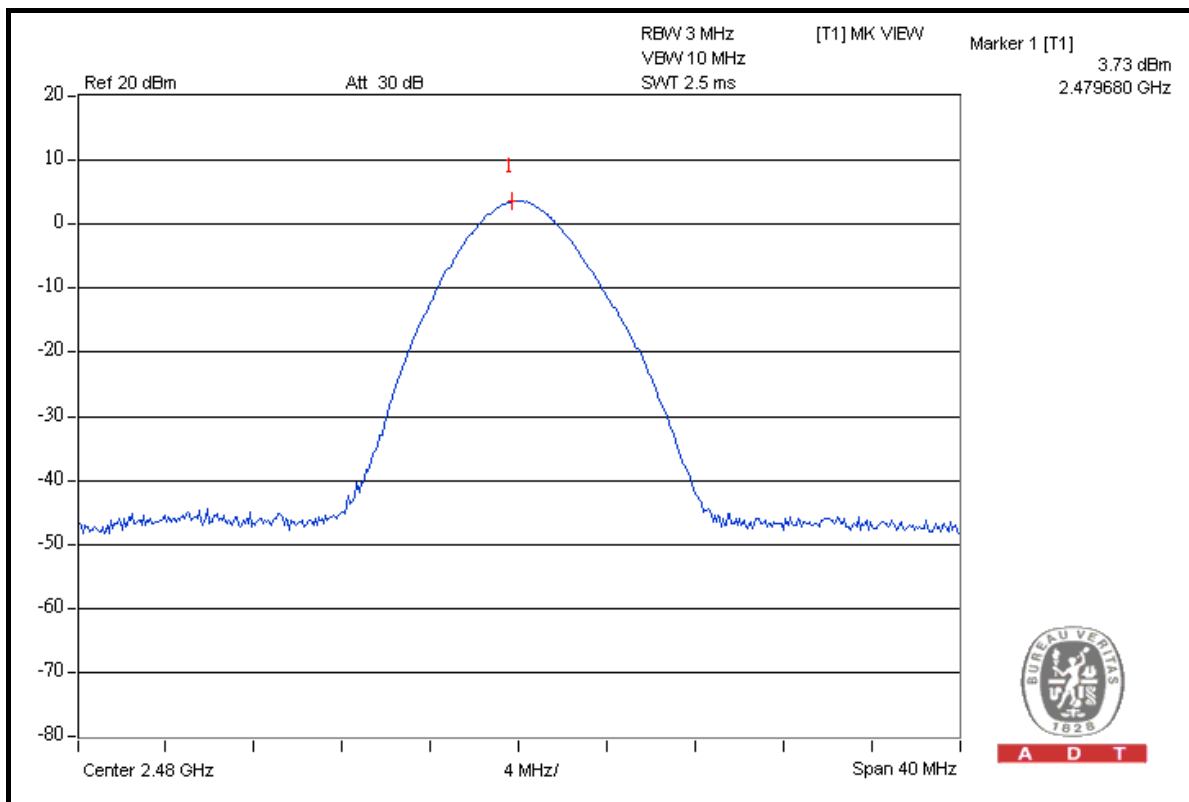



4.7 BAND EDGES MEASUREMENT

4.7.1 LIMITS OF BAND EDGES MEASUREMENT

Below -20dB of the highest emission level of operating band (in 100KHz RBW).

4.7.2 TEST INSTRUMENTS

DESCRIPTION & MANUFACTURER	MODEL NO.	SERIAL NO.	DATE OF CALIBRATION	DUE DATE OF CALIBRATION
R&S SPECTRUM ANALYZER	FSP40	100040	Jul. 07, 2009	Jul. 06, 2010

NOTE: The calibration interval of the above test instruments is 12 months and the calibrations are traceable to NML/ROC and NIST/USA.

4.7.3 TEST PROCEDURE

The transmitter output was connected to the spectrum analyzer via a low lose cable. Set both RBW and VBW of spectrum analyzer to 100 kHz / 300kHz with suitable frequency span including 100 MHz bandwidth from band edge. The band edges was measured and recorded.

4.7.4 DEVIATION FROM TEST STANDARD

No deviation.

4.7.5 EUT OPERATING CONDITION

The software provided by client enabled the EUT to transmit and receive data at lowest and highest channel frequencies individually.

4.7.6 TEST RESULTS

The spectrum plots are attached on the following 8 images. D1 line indicates the highest level, D2 line indicates the 20dB offset below D1. It shows compliance with the requirement in part 15.247(d).

GFSK MODULATION

NOTE 1: The band edge emission plot on the next page shows 51.60dBc between carrier maximum power and local maximum emission in restrict band (2.3182GHz). The emission of carrier strength list in the test result of channel 0 at the item 4.1.7 is 96.28dBuV/m (Peak), so the maximum field strength in restrict band is $96.28 - 51.60 = 44.68$ dBuV/m, which is under 74dBuV/m limit.

Average value = $44.68 - 30.10 = 14.58$ dBuV/m, which is under 54dBuV/m limit.

*The DH5 packet was the worse case duty cycle for a transmit dwell time on a channel, based upon bluetooth theory the transmitter is on $0.625 * 5$ per 296.25 ms per channel. Therefore, the duty cycle correction factor be equal to: $20\log(3.125/100) = -30.1$ dB.

Average value = peak reading – 30.1

NOTE 2: The band edge emission plot on the next second page shows 52.90dBc between carrier maximum power and local maximum emission in restrict band (2.4966GHz). The emission of carrier strength list in the test result of channel 78 at the item 4.1.7 is 96.088 dBuV/m (Peak), so the maximum field strength in restrict band is $96.08 - 52.90 = 43.18$ dBuV/m, which is under 74 dBuV/m limit.

Average value = $43.18 - 30.10 = 13.08$ dBuV/m, which is under 54dBuV/m limit.

*The DH5 packet was the worse case duty cycle for a transmit dwell time on a channel, based upon bluetooth theory the transmitter is on $0.625 * 5$ per 296.25 ms per channel. Therefore, the duty cycle correction factor be equal to: $20\log(3.125/100) = -30.1$ dB.

Average value = peak reading – 30.1



A D T

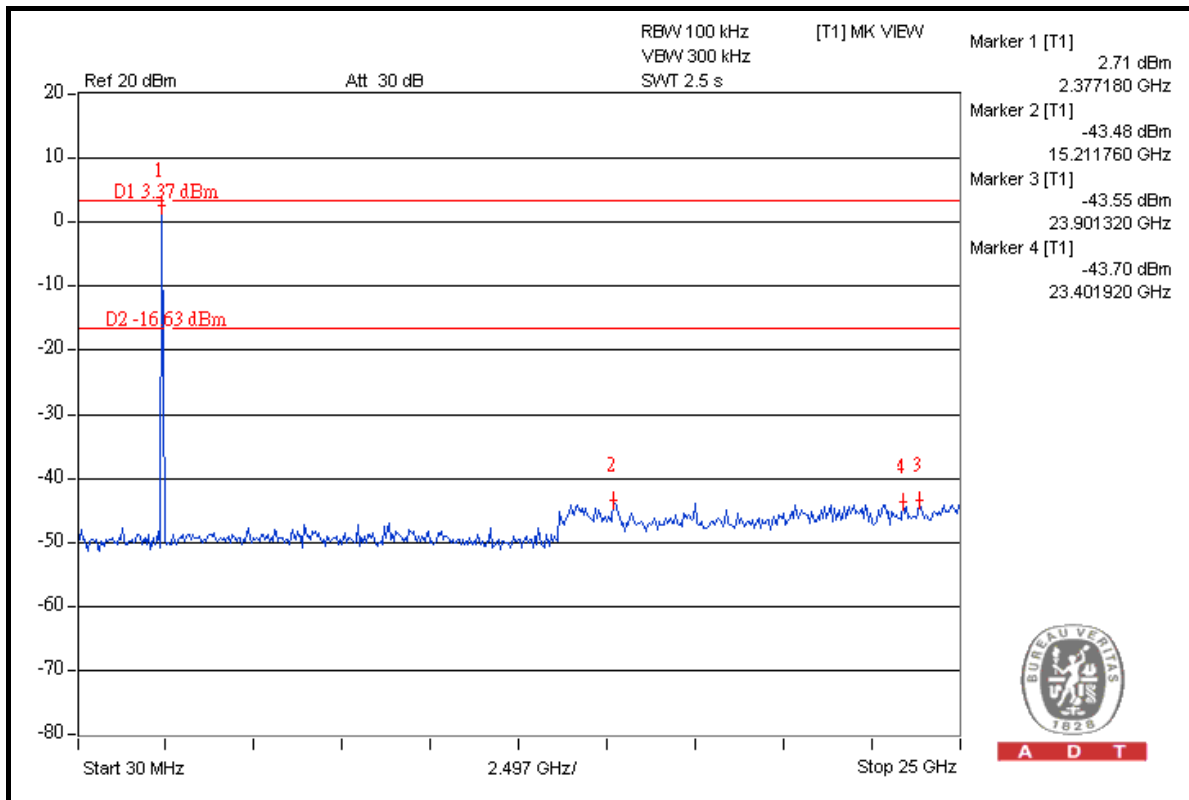
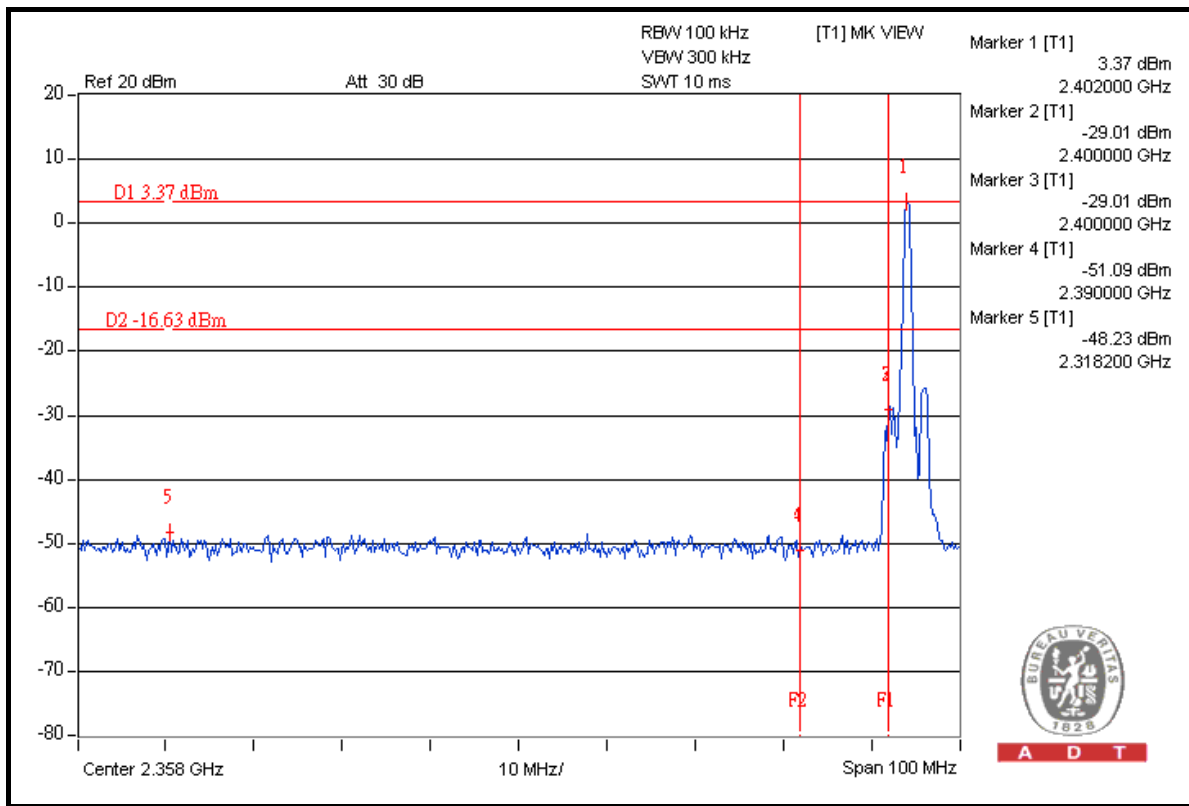



A D T

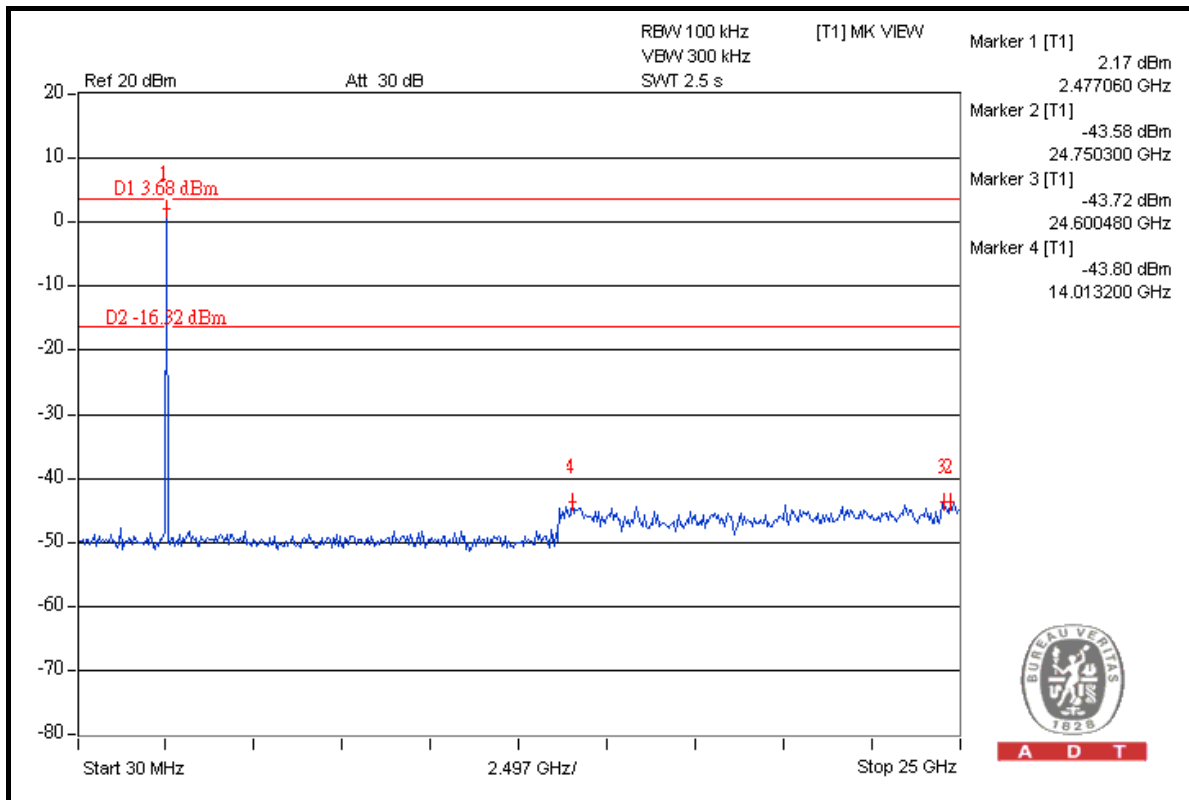
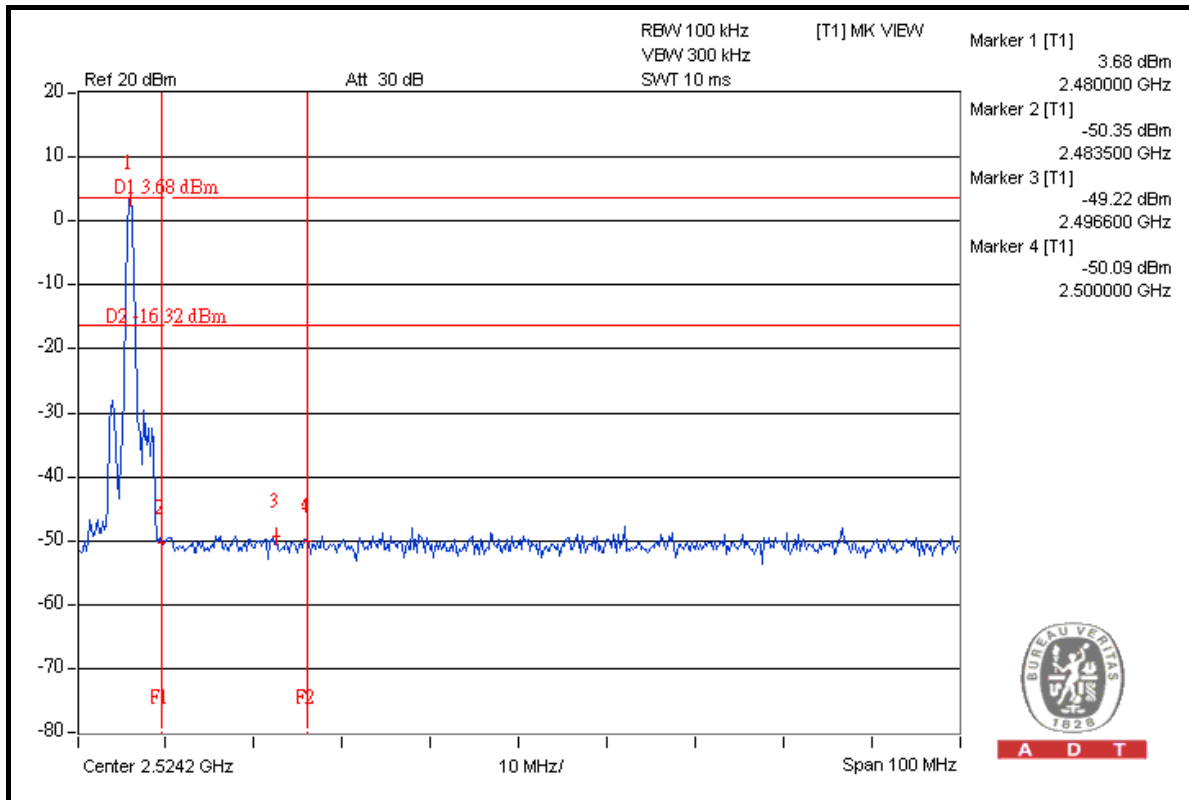

8DPSK MODULATION

NOTE 1: The band edge emission plot on the next page shows 50.31dBc between carrier maximum power and local maximum emission in restrict band (2.3536GHz). The emission of carrier strength list in the test result of channel 0 at the item 4.1.7 is 94.97dBuV/m (Peak), so the maximum field strength in restrict band is $94.97 - 50.31 = 44.66$ dBuV/m, which is under 74 dBuV/m limit.

Average value = $44.66 - 30.10 = 14.56$ dBuV/m, which is under 54dBuV/m limit.

*The DH5 packet was the worse case duty cycle for a transmit dwell time on a channel, based upon bluetooth theory the transmitter is on $0.625 * 5$ per 296.25 ms per channel. Therefore, the duty cycle be equal to: $20\log(3.125/100) = -30.1$ dB.

Average value = peak reading – 30.1

NOTE 2: The band edge emission plot on the next second page shows 50.05dBc between carrier maximum power and local maximum emission in restrict band (2.4936GHz). The emission of carrier strength list in the test result of channel 78 at the item 4.1.7 is 94.46dBuV/m (Peak), so the maximum field strength in restrict band is $94.46 - 50.05 = 44.41$ dBuV/m, which is under 74 dBuV/m limit.

Average value = $44.41 - 30.10 = 14.31$ dBuV/m, which is under 54dBuV/m limit.

*The DH5 packet was the worse case duty cycle for a transmit dwell time on a channel, based upon bluetooth theory the transmitter is on $0.625 * 5$ per 296.25 ms per channel. Therefore, the duty cycle be equal to: $20\log(3.125/100) = -30.1$ dB.

Average value = peak reading – 30.1



A D T

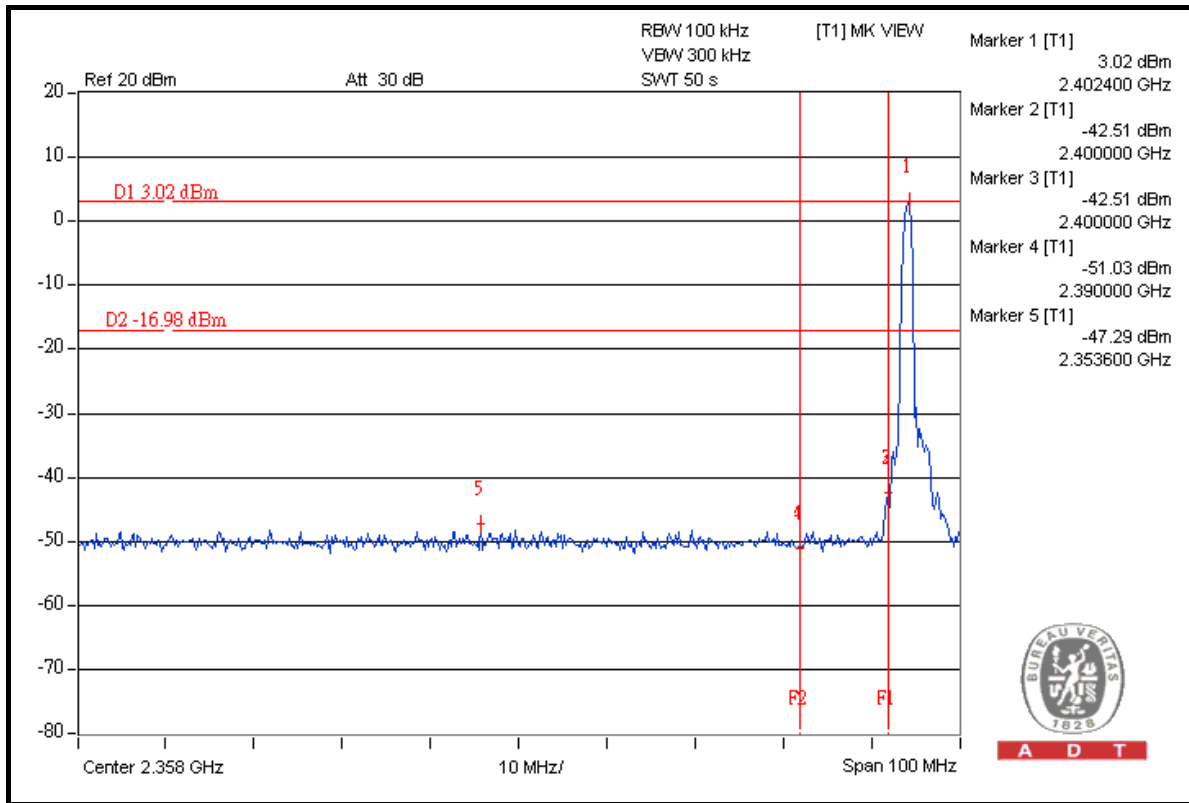

A D T

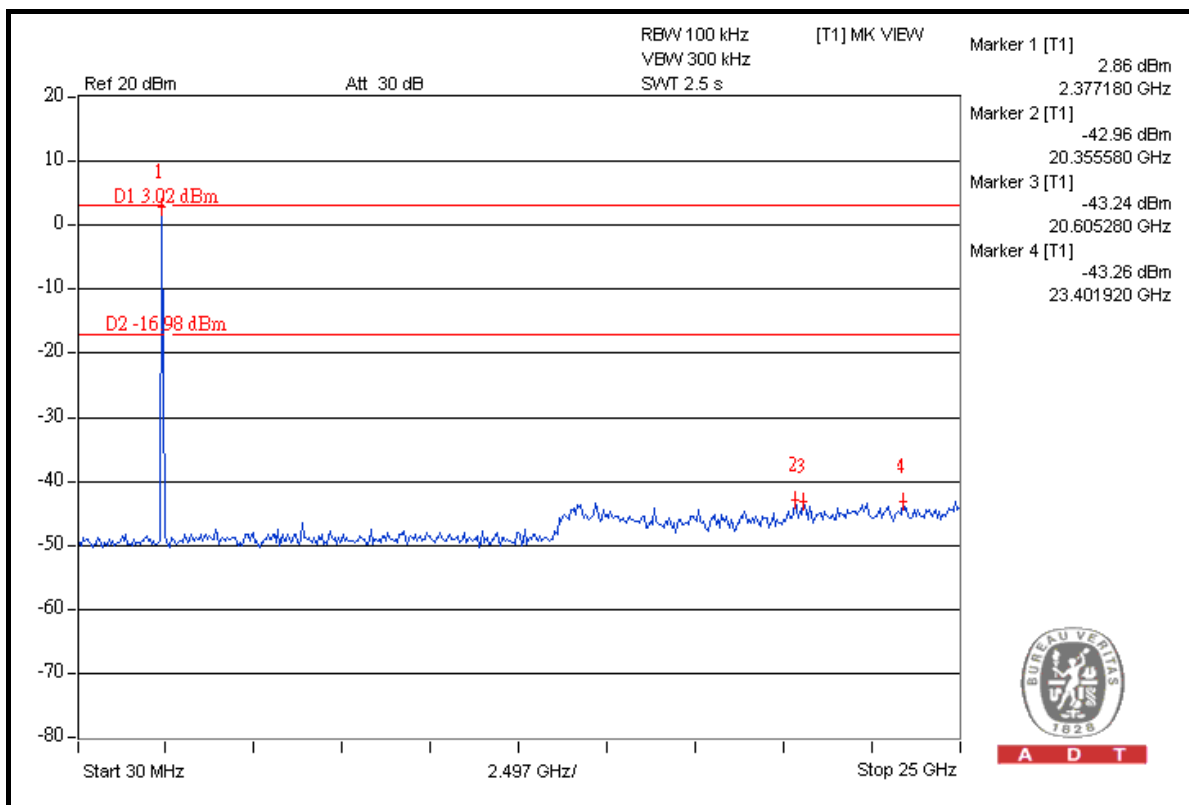

A D T



A D T

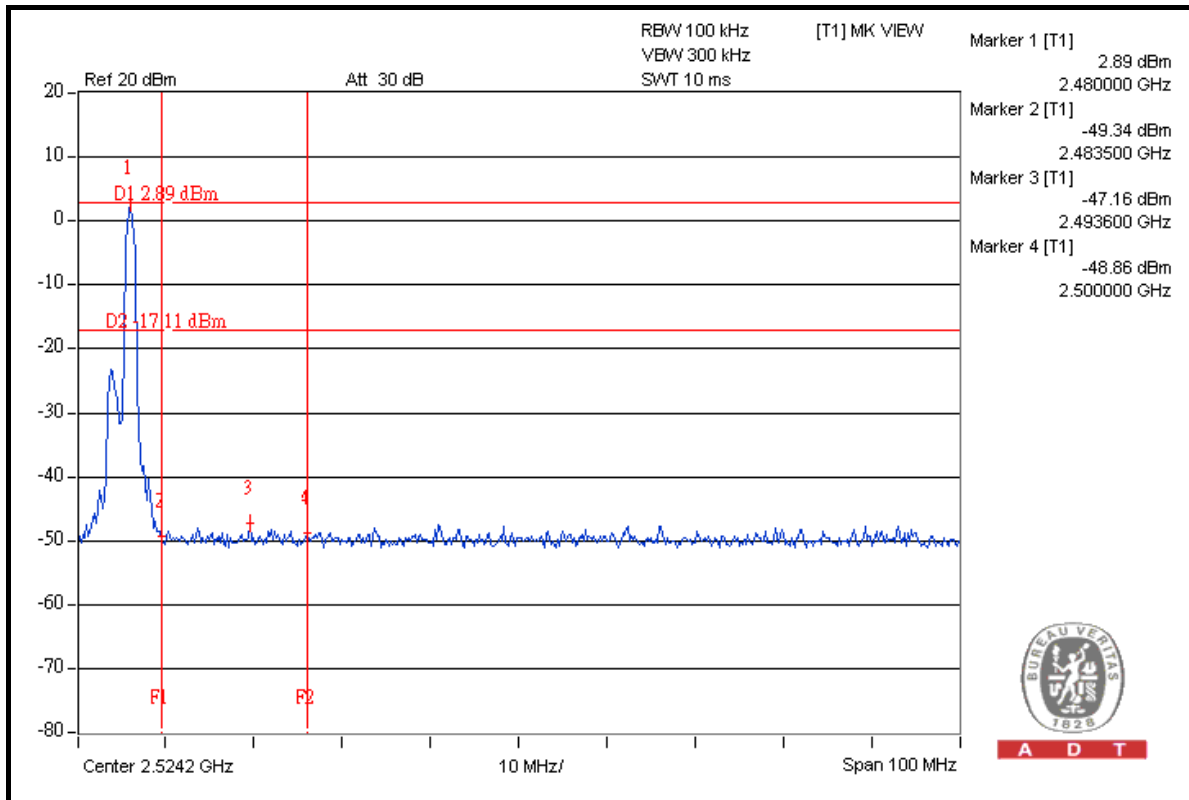

A D T

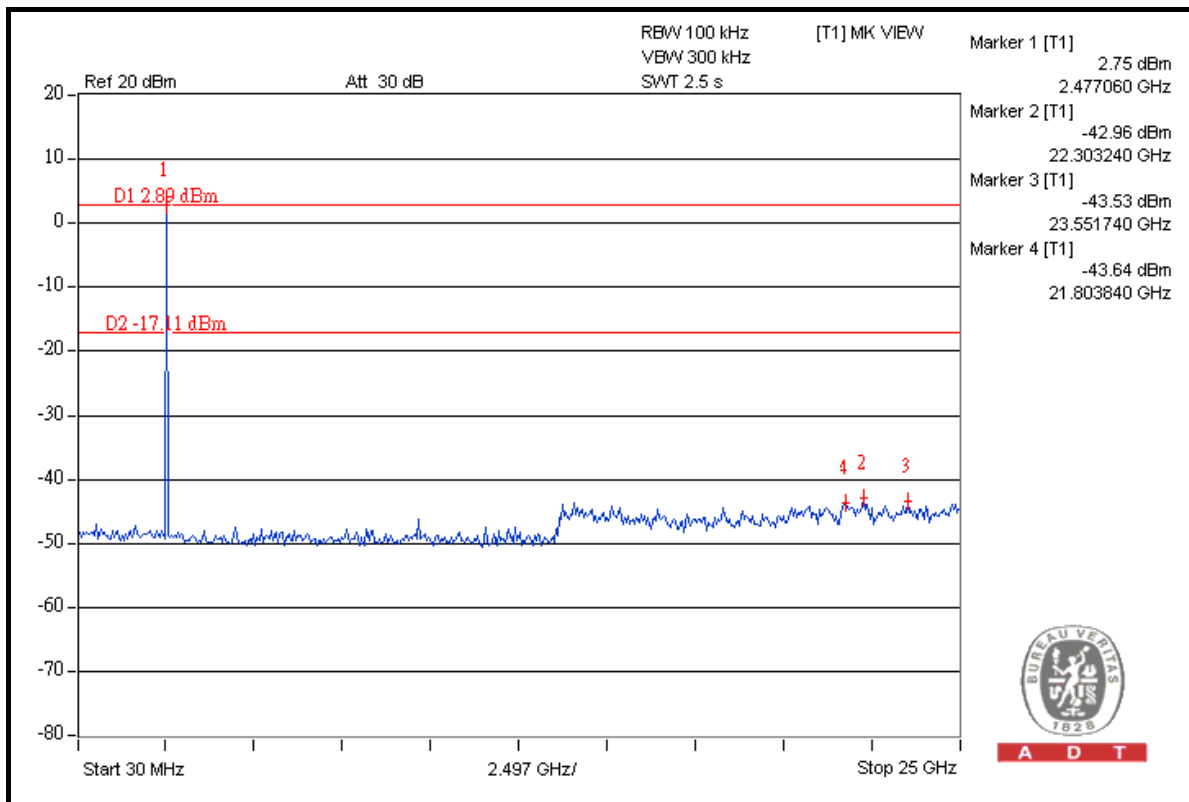

A D T

4.8 ANTENNA REQUIREMENT

4.8.1 STANDARD APPLICABLE

For intentional device, according to FCC 47 CFR Section 15.203, an intentional radiator shall be designed to ensure that no antenna other than that furnished by the responsible party shall be used with the device.

And according to FCC 47 CFR Section 15.247 (b), if transmitting antennas of directional gain greater than 6dBi are used, the power shall be reduced by the amount in dB that the directional gain of the antenna exceeds 6dBi.

4.8.2 ANTENNA CONNECTED CONSTRUCTION

The antenna used in this product is PIFA antenna that without antenna connector. The maximum gain of this antenna is 2.0dBi.

5. PHOTOGRAPHS OF THE TEST CONFIGURATION

Please refer to the attached file (Test Setup Photo).

6. INFORMATION ON THE TESTING LABORATORIES

We, Bureau Veritas Consumer Products Services (H.K.) Ltd., Taoyuan Branch, were founded in 1988 to provide our best service in EMC, Radio, Telecom and Safety consultation. Our laboratories are accredited and approved by the following approval agencies according to ISO/IEC 17025.

USA	FCC, NVLAP
Germany	TUV Rheinland
Japan	VCCI
Norway	NEMKO
Canada	INDUSTRY CANADA , CSA
R.O.C.	TAF, BSMI, NCC
Netherlands	Telefication
Singapore	GOST-ASIA(MOU)
Russia	CERTIS(MOU)

Copies of accreditation certificates of our laboratories obtained from approval agencies can be downloaded from our web site: www.adt.com.tw/index.5/phtml.
If you have any comments, please feel free to contact us at the following:

Linko EMC/RF Lab:

Tel: 886-2-26052180

Fax: 886-2-26051924

Hsin Chu EMC/RF Lab:

Tel: 886-3-5935343

Fax: 886-3-5935342

Hwa Ya EMC/RF/Safety Telecom Lab:

Tel: 886-3-3183232

Fax: 886-3-3185050

Web Site: www.adt.com.tw

The address and road map of all our labs can be found in our web site also.

7. APPENDIX A - MODIFICATIONS RECORDERS FOR ENGINEERING CHANGES TO THE EUT BY THE LAB

No any modifications are made to the EUT by the lab during the test.

--- END ---