

FCC Test Report

APPLICANT : Motorola Mobility Inc.
EQUIPMENT : Quad-Band GSM/GPRS/EDGE and Dual-Band
WCDMA Mobile Phone with BT/Wifi
BRAND NAME : Motorola
MODEL NAME /
MARKETING NAME : XT535
TYPE NAME : M0C86
GPPD Number : 3206
FCC ID : IHDP56MR1
STANDARD : FCC 47 CFR FCC Part 15 Subpart B
CLASSIFICATION : Certification

The product was received on Dec. 08, 2011 and completely tested on Dec. 13, 2011. We, SPORTON INTERNATIONAL INC., would like to declare that the tested sample has been evaluated in accordance with the procedures given in ANSI C63.4-2003 and shown the compliance with the applicable technical standards.

The test results in this report apply exclusively to the tested model / sample. Without written approval of SPORTON INTERNATIONAL INC., the test report shall not be reproduced except in full.

Reviewed by:



Jones Tsai / Manager



SPORTON INTERNATIONAL INC.

No. 52, Hwa Ya 1st Rd., Hwa Ya Technology Park, Kwei-Shan Hsiang, Tao Yuan Hsien, Taiwan, R.O.C.

SPORTON INTERNATIONAL INC.

TEL : 886-3-327-3456

FAX : 886-3-328-4978

FCC ID : IHDP56MR1

Page Number : 1 of 22

Report Issued Date : Jan. 02, 2012

Report Version : Rev. 01



TABLE OF CONTENTS

REVISION HISTORY 3

SUMMARY OF TEST RESULT 4

1. GENERAL DESCRIPTION 5

 1.1. Applicant 5

 1.2. Manufacturer 5

 1.3. Feature of Equipment Under Test 6

 1.4. Test Site 7

 1.5. Applied Standards 7

 1.6. Ancillary Equipment List 7

2. TEST CONFIGURATION OF EQUIPMENT UNDER TEST 8

 2.1. Test Mode 8

 2.2. Connection Diagram of Test System 10

 2.3. Test Software 11

3. TEST RESULT 12

 3.1. Test of AC Conducted Emission Measurement 12

 3.2. Test of Radiated Emission Measurement 16

4. LIST OF MEASURING EQUIPMENT 20

5. UNCERTAINTY OF EVALUATION 21



SUMMARY OF TEST RESULT

Report Section	FCC Rule	IC Rule	Description	Limit	Result	Remark
3.1	15.107	7.2.4	AC Conducted Emission	< 15.107 limits < RSS-Gen table 2 limits	PASS	Under limit 5.18 dB at 1.930 MHz
3.2	15.109	7.2.3.2	Radiated Emission	< 15.109 limits or < RSS-Gen table 1 limits (Section 6)	PASS	Under limit 5.08 dB at 240.060 MHz



1. General Description

1.1. Applicant

Motorola Mobility Inc.

No. 1, Wang Jing East Road, Chao Yang District, 100102 Beijing, P. R. China

1.2. Manufacturer

Foxconn (TianJin) Precision Industry Co., Ltd.

No. 207, Nanhai Road, TEDA, Tianjin, P.R. China, 300457

1.3. Feature of Equipment Under Test

Product Feature & Specification	
Equipment	Quad-Band GSM/GPRS/EDGE and Dual-Band WCDMA Mobile Phone with BT/Wifi
Brand Name	Motorola
Model Name / Marketing Name	XT535
Type Name	M0C86
FCC ID	IHDP56MR1
Tx Frequency Range	GSM850 : 824 MHz ~ 849 MHz GSM1900 : 1850 MHz ~ 1910 MHz WCDMA Band V : 824 MHz ~ 849 MHz Bluetooth : 2400 MHz ~ 2483.5 MHz WLAN : 2400 MHz ~ 2483.5 MHz
Rx Frequency Range	GSM850 : 869 MHz ~ 894 MHz GSM1900 : 1930 MHz ~ 1990 MHz WCDMA Band V : 869 MHz ~ 894 MHz Bluetooth : 2400 MHz ~ 2483.5 MHz WLAN : 2400 MHz ~ 2483.5 MHz GPS : 1.57542 GHz
Antenna Type	WWAN: Monopole Antenna WLAN/Bluetooth: Monopole Antenna
HW Version	PR2.5
SW Version	1_400_9000
Type of Modulation	GSM: GMSK GPRS: GMSK EDGE: GMSK / 8PSK WCDMA: QPSK (Uplink) HSDPA: QPSK (Uplink) HSUPA: QPSK (Uplink) Bluetooth (1Mbps) : GFSK Bluetooth EDR (2Mbps) : $\pi/4$ -DQPSK Bluetooth EDR (3Mbps) : 8-DPSK 802.11b : DSSS (BPSK / QPSK / CCK) 802.11g/n : OFDM (BPSK / QPSK / 16QAM / 64QAM) GPS : BPSK
EUT Stage	Production Unit

Remark: The above EUT's information was declared by manufacturer. Please refer to the specifications or user's manual for more detailed description.

1.4. Test Site

Test Site	SPORTON INTERNATIONAL (KUNSHAN) INC.
Test Site Location	No. 3-2, PingXiang Road, Kunshan, Jiangsu Province, P.R.C. TEL: +86-0512-5790-0158 FAX: +86-0512-5790-0958
Test Site No.	Sporton Site No. : 03CH01-KS ; CO01-KS

1.5. Applied Standards

According to the specifications of the manufacturer, the EUT must comply with the requirements of the following standards:

- FCC 47 CFR FCC Part 15 Subpart B
- ANSI C63.4-2003
- IC RSS-Gen Issue 3

Remark: All test items were verified and recorded according to the standards and without any deviation during the test.

1.6. Ancillary Equipment List

Item	Equipment	Trade Name	Model Name	FCC ID	Data Cable	Power Cord
1.	System Simulator	R&S	CMU 200	N/A	N/A	Unshielded, 1.8 m
2.	GPS Station	T&E	GS-50	N/A	N/A	Unshielded, 1.8 m
3.	Router	D-Link	DIR-855	KA2DIR855A2	N/A	Shielded cable DC O/P 1.8m, Unshielded cable AC I/P 1.8m
4.	Bluetooth Earphone	Nokia	BH-102	PYAHS-107W	N/A	N/A
5.	Monitor	DELL	ST2220Lb	FCC DoC	Shielded, 1.2 m	Unshielded, 1.8 m
6.	(USB)Keyboard	DELL	SK-8115	FCC DoC	Shielded, 1.8 m with core	N/A
7.	(USB)Mouse	DELL	MO56UC	FCC DoC	Shielded, 1.8 m	N/A
8.	Printer	HP	Laser Jet 1018	FCC DoC	Shielded, 1.8 m	Unshielded, 1.8 m
9.	iPod	Apple	A1199	FCC DoC	Unshielded, 1.2 m	N/A
10.	PC	DELL	MT320	FCC DoC	N/A	Unshielded, 1.8 m

2. Test Configuration of Equipment Under Test

2.1. Test Mode

The EUT has been associated with peripherals pursuant to ANSI C63.4-2003 and configuration operated in a manner tended to maximize its emission characteristics in a typical application.

Frequency range investigated: conduction (150 kHz to 30 MHz), radiation (30MHz to the 5th harmonic of the highest fundamental frequency or to 40 GHz, whichever is lower).

The EUT uses a USB interface and microprocessor operating 1GHz which is the maximum frequency used.

The following tables are showing the test modes as the worst cases and recorded in this report.

Item	EUT Configuration	Test Condition		
		EMI AC	EMI RE<1G	EMI RE≥1G
1.	Charging Mode (EUT with adapter)	☒	☒	Note 1
2.	Data application transferred mode (EUT with PC)	☒	☒	☒

Abbreviations:

- EMI AC: AC conducted emissions
- EMI RE ≥ 1G: EUT radiated emissions ≥ 1GHz
- EMI RE < 1G: EUT radiated emissions < 1GHz

Note 1: Testing for this mode is not required or not the worst case.

Remark: For signal above 1GHZ, the worst case was test item 2.

Test Items	EUT Configure Mode	Function Type
AC Conducted Emission	1/2	Mode 1 : GSM850 Idle + Bluetooth Idle + WLAN Idle + USB Cable (Charging from Adapter) + Earphone + Camera <Fig. 1> Mode 2 : GSM1900 Idle + Bluetooth Idle + WLAN Idle + USB Cable (Charging from Adapter) + Earphone + MP3 <Fig. 1> Mode 3 : WCDMA Band V Idle + Bluetooth Idle + WLAN Idle + Earphone + USB Cable (Data Link with PC) + GPS Rx <Fig. 2>
Radiated Emissions < 1GHz	1/2	Mode 1 : GSM850 Idle + Bluetooth Idle + WLAN Idle + USB Cable (Charging from Adapter) + Earphone + Camera <Fig. 1> Mode 2 : GSM1900 Idle + Bluetooth Idle + WLAN Idle + USB Cable (Charging from Adapter) + Earphone + MP3 <Fig. 1> Mode 3 : WCDMA Band V Idle + Bluetooth Idle + WLAN Idle + Earphone + USB Cable (Data Link with PC) + GPS Rx <Fig. 2>
Radiated Emissions ≥ 1GHz	2	Mode 1 : WCDMA Band V Idle + Bluetooth Idle + WLAN Idle + Earphone + USB Cable (Data Link with PC) + GPS Rx <Fig. 2>
Remark: <ol style="list-style-type: none"> 1. The worst case of AC is mode 2; only the test data of this mode was reported. 2. The worst case of RE < 1G is mode 3; only the test data of this mode was reported. 3. Link with PC means data application transferred mode between EUT and PC. 		

2.2. Connection Diagram of Test System

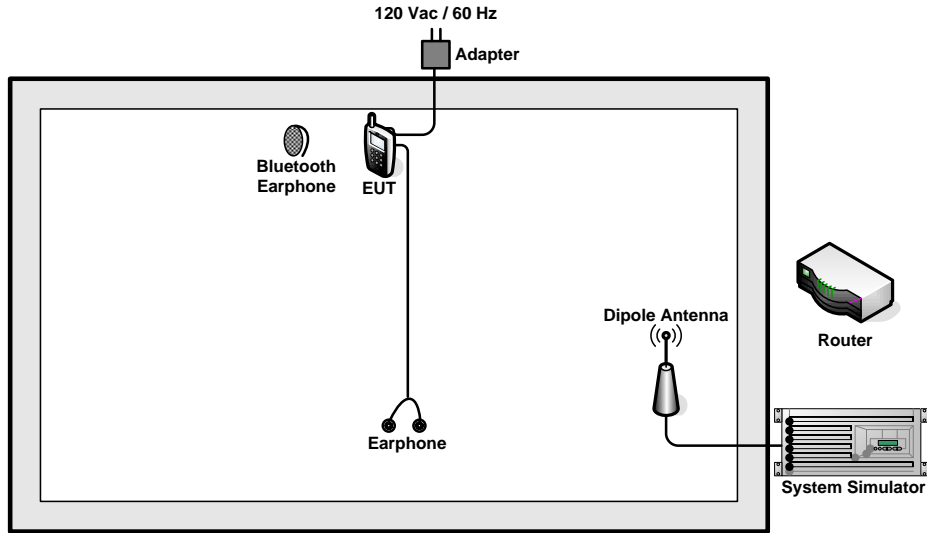

<Fig. 1>

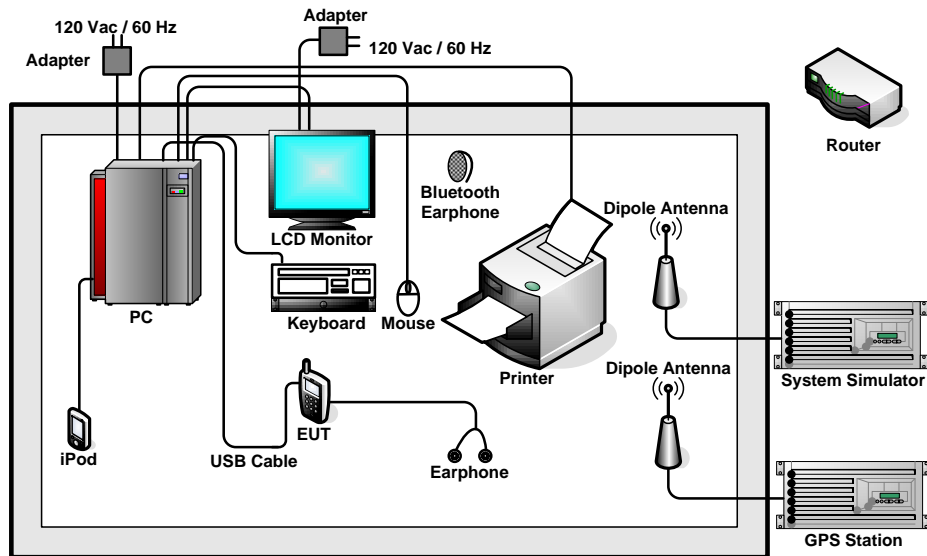

<Fig. 2>



2.3. Test Software

The EUT was in GSM or WCDMA idle mode during the testing. The EUT was synchronized to the BCCH, and is in continuous receiving mode by setting system simulator's paging reorganization.

At the same time, the EUT was attached to the Bluetooth earphone or WLAN AP, and the following programs installed in the EUT were programmed during the test.

1. Execute the program, "WINTHRAX.EXE" installed in PC for active sync files transfer with EUT via USB cable.
2. Receive signals from GPS station continuously.
3. Execute "Music Player" to play MP3 file.
4. Turn on camera to capture images.

3. Test Result

3.1. Test of AC Conducted Emission Measurement

3.1.1 Limits of AC Conducted Emission

For equipment that is designed to be connected to the public utility (AC) power line, the radio frequency voltage that is conducted back onto the AC power line on any frequency or frequencies within the band 150 kHz to 30 MHz shall not exceed the limits in the following table.

Frequency of emission (MHz)	Conducted limit (dBuV)	
	Quasi-peak	Average
0.15-0.5	66 to 56*	56 to 46*
0.5-5	56	46
5-30	60	50

*Decreases with the logarithm of the frequency.

3.1.2 Measuring Instruments

See list of measuring instruments of this test report.

3.1.3 Test Procedure

1. The EUT was placed 0.4 meter from the conducting wall of the shielding room was kept at least 80 centimeters from any other grounded conducting surface.
2. Connect EUT to the power mains through a line impedance stabilization network (LISN).
3. All the support units are connecting to the other LISN.
4. The LISN provides 50 ohm coupling impedance for the measuring instrument.
5. The FCC states that a 50 ohm, 50 microhenry LISN should be used.
6. Both sides of AC line were checked for maximum conducted interference.
7. The frequency range from 150 KHz to 30 MHz was searched.
8. Set the test-receiver system to Peak Detect Function and specified bandwidth with Maximum Hold Mode.

3.1.4 Test Setup

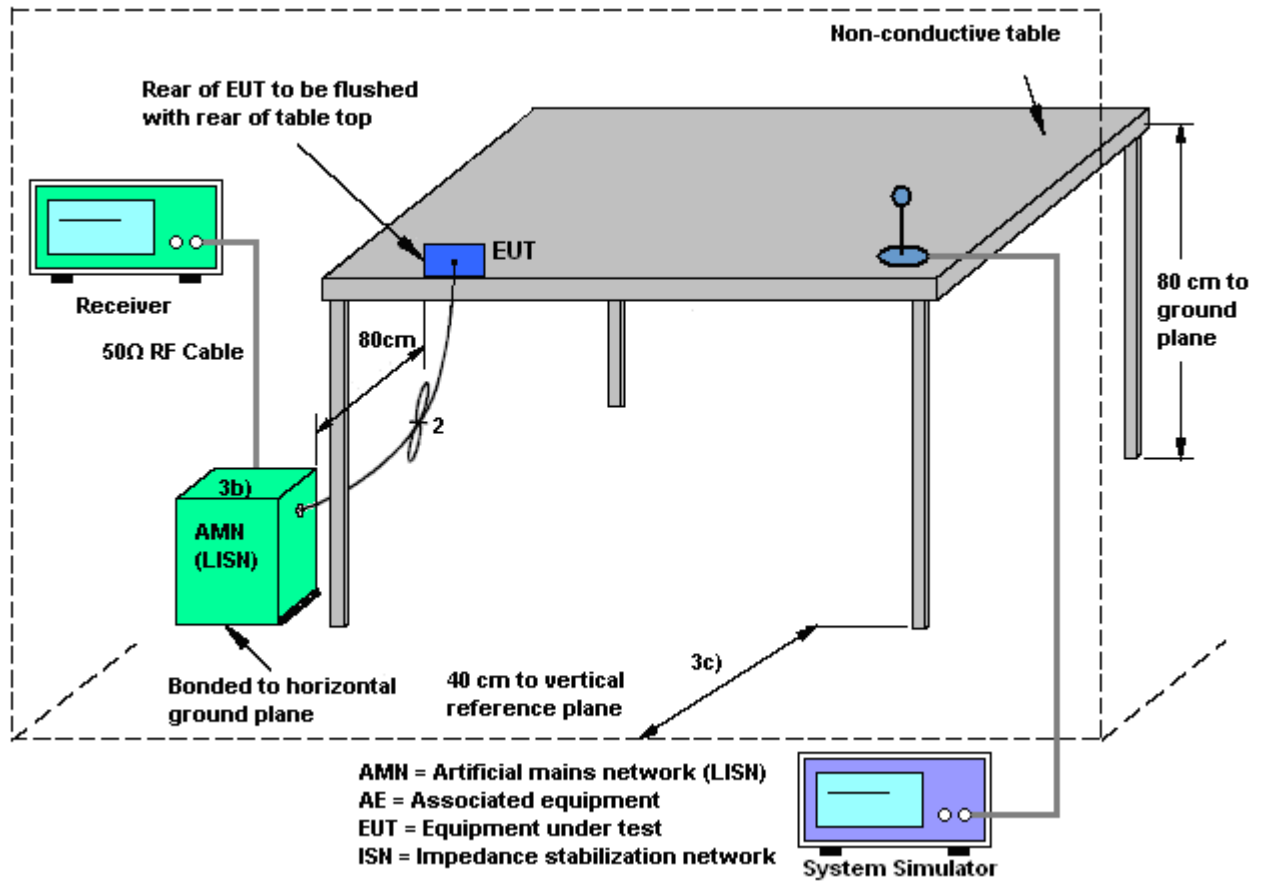



3.1.5 Test Result of AC Conducted Emission

Test Mode :	Mode 2	Temperature :	20~21°C
Test Engineer :	Jack Li	Relative Humidity :	40~41%
Test Voltage :	120Vac / 60Hz	Phase :	Line
Function Type :	GSM1900 Idle + Bluetooth Idle + WLAN Idle + USB Cable (Charging from Adapter) + Earphone + MP3		
Remark :	All emissions not reported here are more than 10 dB below the prescribed limit.		

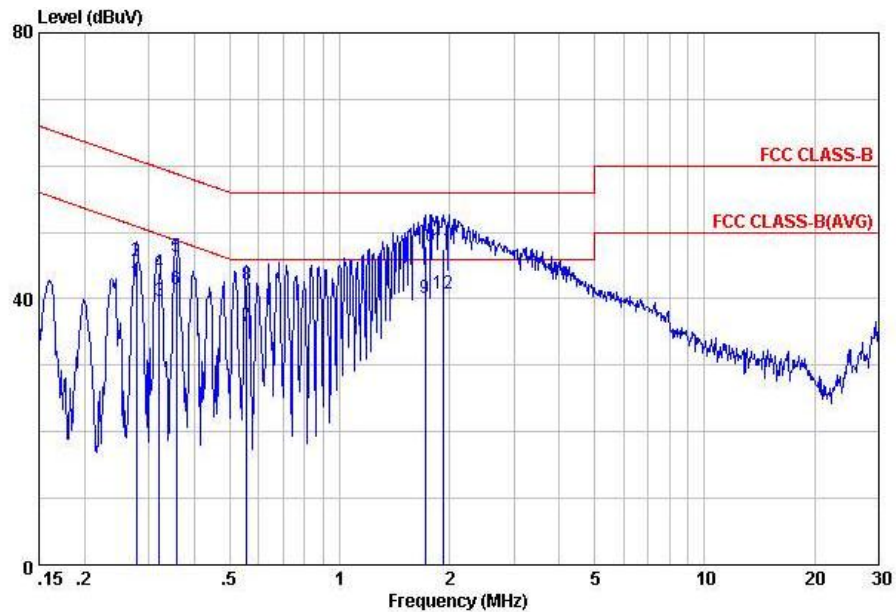

Site : C001-KS
 Condition: FCC CLASS-B LISN-100807 LINE

mode : Mode 2
 IMEI : 358980040010622

	Freq	Level	Over	Limit	Read	LISN	Cable	Remark
	MHz	dBuV	Limit	Line	Level	Factor	Loss	
			dB	dBuV	dBuV	dB	dB	
1	0.28	42.59	-8.31	50.90	32.49	-0.07	10.17	Average
2	0.28	45.69	-15.21	60.90	35.59	-0.07	10.17	QP
3	0.32	39.70	-10.01	49.71	29.60	-0.08	10.18	Average
4	0.32	44.00	-15.71	59.71	33.90	-0.08	10.18	QP
5	0.36	46.31	-12.47	58.78	36.21	-0.08	10.18	QP
6	0.36	41.41	-7.37	48.78	31.31	-0.08	10.18	Average
7	0.56	35.93	-10.07	46.00	25.79	-0.08	10.22	Average
8	0.56	42.03	-13.97	56.00	31.89	-0.08	10.22	QP
9	1.72	40.10	-5.90	46.00	29.90	-0.11	10.31	Average
10	1.72	47.90	-8.10	56.00	37.70	-0.11	10.31	QP
11	1.93	47.42	-8.58	56.00	37.20	-0.11	10.33	QP
12	1.93	40.82	-5.18	46.00	30.60	-0.11	10.33	Average



Test Mode :	Mode 2	Temperature :	20~21°C
Test Engineer :	Jack Li	Relative Humidity :	40~41%
Test Voltage :	120Vac / 60Hz	Phase :	Neutral
Function Type :	GSM1900 Idle + Bluetooth Idle + WLAN Idle + USB Cable (Charging from Adapter) + Earphone + MP3		
Remark :	All emissions not reported here are more than 10 dB below the prescribed limit.		

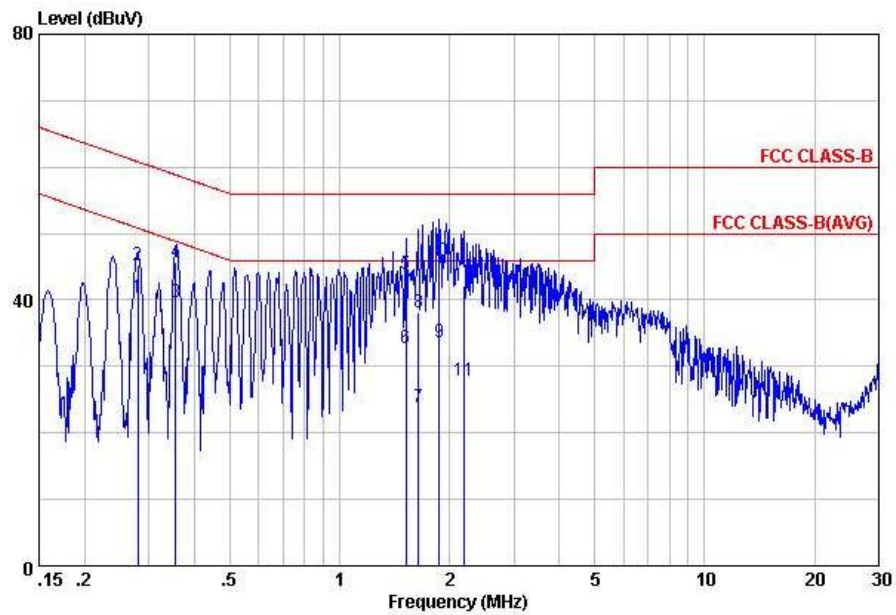

Site : C001-KS
 Condition: FCC CLASS-B LISN-100807 NEUTRAL

mode : Mode 2
 IMEI : 358980040010622

	Freq	Level	Over	Limit	Read	LISN	Cable	Remark
	MHz	dBuV	Limit	Line	Level	Factor	Loss	
			dB	dBuV	dBuV	dB	dB	
1	0.28	40.39	-10.42	50.81	30.29	-0.07	10.17	Average
2	0.28	45.29	-15.52	60.81	35.19	-0.07	10.17	QP
3	0.36	39.61	-9.22	48.83	29.51	-0.08	10.18	Average
4	0.36	45.71	-13.12	58.83	35.61	-0.08	10.18	QP
5	1.52	43.80	-12.20	56.00	33.60	-0.10	10.30	QP
6	1.52	32.70	-13.30	46.00	22.50	-0.10	10.30	Average
7	1.64	23.80	-22.20	46.00	13.60	-0.11	10.31	Average
8	1.64	38.00	-18.00	56.00	27.80	-0.11	10.31	QP
9	1.88	33.61	-12.39	46.00	23.40	-0.11	10.32	Average
10	1.88	46.01	-9.99	56.00	35.80	-0.11	10.32	QP
11	2.20	27.83	-18.17	46.00	17.60	-0.11	10.34	Average
12	2.20	42.13	-13.87	56.00	31.90	-0.11	10.34	QP

3.2. Test of Radiated Emission Measurement

3.2.1. Limit of Radiated Emission

The emissions from an intentional radiator shall not exceed the field strength levels specified in the following table:

Frequency (MHz)	Field Strength (microvolts/meter)	Measurement Distance (meters)
0.009 – 0.490	2400/F(KHz)	300
0.490 – 1.705	24000/F(KHz)	30
1.705 – 30.0	30	30
30 – 88	100	3
88 – 216	150	3
216 - 960	200	3
Above 960	500	3

3.2.2. Measuring Instruments

See list of measuring instruments of this test report.

3.2.3. Test Procedures

1. The EUT was placed on a turntable with 0.8 meter above ground.
2. The EUT was set 3 meters from the interference receiving antenna, which was mounted on the top of a variable height antenna tower.
3. The table was rotated 360 degrees to determine the position of the highest radiation.
4. The antenna is a Bi-Log antenna and its height is adjusted between one meter and four meters above ground to find the maximum value of the field strength for both horizontal polarization and vertical polarization of the antenna.
5. For each suspected emission, the EUT was arranged to its worst case and then tune the antenna tower (from 1 m to 4 m) and turntable (from 0 degree to 360 degrees) to find the maximum reading.
6. Set the test-receiver system to Peak Detect Function and specified bandwidth with Maximum Hold Mode.
7. If the emission level of the EUT in peak mode was 3 dB lower than the limit specified, then testing will be stopped and peak values of EUT will be reported, otherwise, the emissions will be repeated one by one using the quasi-peak method and reported
8. Emission level (dBuV/m) = 20 log Emission level (uV/m)
9. Corrected Reading: Antenna Factor + Cable Loss + Read Level - Preamp Factor = Level

3.2.4. Test Setup of Radiated Emission

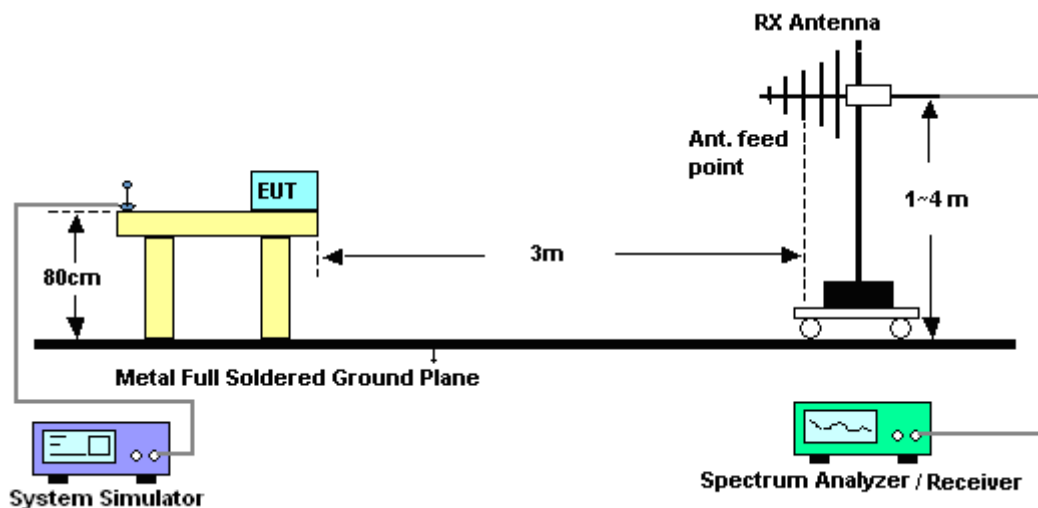



3.2.5. Test Result of Radiated Emission

Test Mode :	Mode 3	Temperature :	21~22°C
Test Engineer :	Chenmy Cheng	Relative Humidity :	40~41%
Test Distance :	3m	Polarization :	Horizontal
Function Type :	WCDMA Band V Idle + Bluetooth Idle + WLAN Idle + Earphone + USB Cable (Data Link with PC) + GPS Rx		

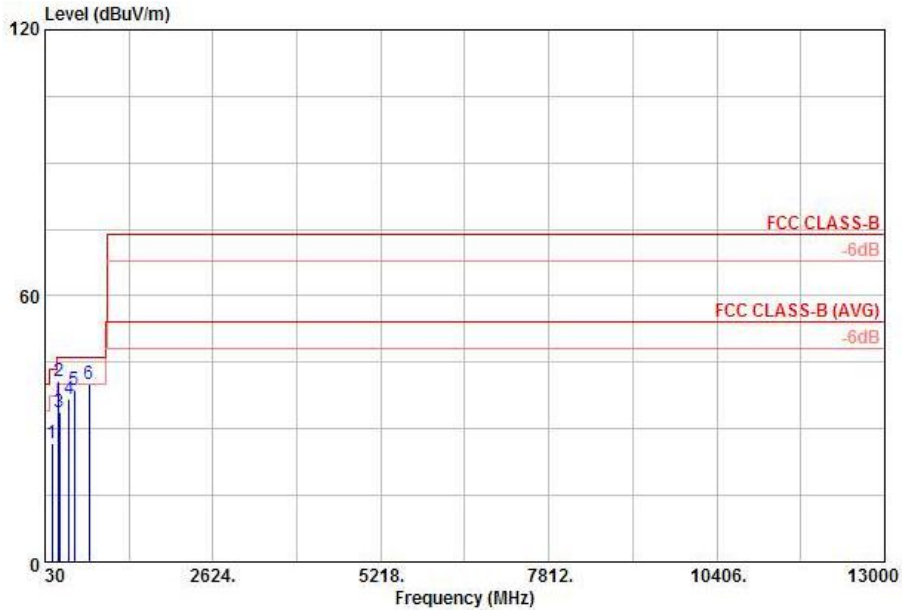

Site : 03CH01-KS
 Condition: FCC CLASS-B 3m LF_ANT_100803 HORIZONTAL

Mode : mode 3
 IMEI : 358980040010622

	Freq	Level	Over	Limit	ReadAntenna	Cable	Preamp	Ant	Table	Remark	
	MHz	dBuV/m	dB	dBuV/m	dBuV	dB/m	dB	dB	cm	deg	
1	135.03	26.77	-16.73	43.50	44.98	11.30	0.48	29.99	---	---	Peak
2 !	240.06	40.92	-5.08	46.00	58.52	11.56	0.66	29.82	100	116	Peak
3	251.40	33.72	-12.28	46.00	50.88	12.01	0.67	29.84	---	---	Peak
4	396.60	36.68	-9.32	46.00	49.73	15.94	0.84	29.83	---	---	Peak
5	478.50	38.84	-7.16	46.00	50.82	16.83	0.94	29.75	---	---	Peak
6 !	710.90	40.13	-5.87	46.00	49.29	19.40	1.14	29.70	---	---	Peak



Test Mode :	Mode 3	Temperature :	21~22°C
Test Engineer :	Chenmy Cheng	Relative Humidity :	40~41%
Test Distance :	3m	Polarization :	Vertical
Function Type :	WCDMA Band V Idle + Bluetooth Idle + WLAN Idle + Earphone + USB Cable (Data Link with PC) + GPS Rx		

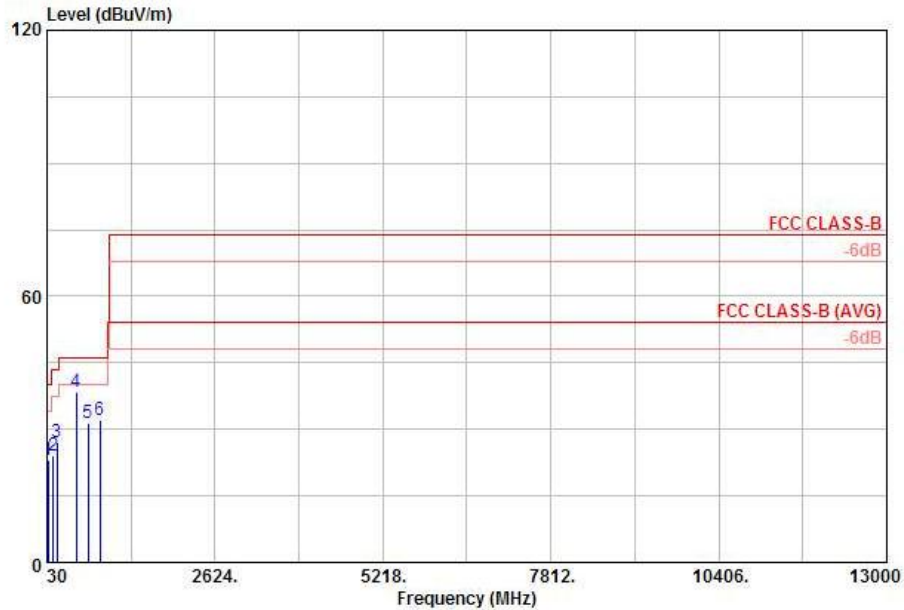

Site : 03CH01-KS
 Condition: FCC CLASS-B 3m LF_ANT_100803 VERTICAL

Mode : mode 3
 IMEI : 358980040010622

	Freq	Level	Over	Limit	ReadAntenna	Cable	Preamp	Ant	Table	Remark
	MHz	dBuV/m	Limit	Line	Level	Loss	Factor	Pos	Pos	
			dB	dBuV/m	dBuV	dB	dB	cm	deg	
1	45.12	23.22	-16.78	40.00	43.83	9.25	0.27	30.13	---	Peak
2	127.74	24.17	-19.33	43.50	41.96	11.72	0.47	29.98	---	Peak
3	184.71	27.10	-16.40	43.50	47.99	8.44	0.57	29.90	---	Peak
4	480.60	38.57	-7.43	46.00	50.49	16.89	0.94	29.75	100	336 Peak
5	670.30	31.59	-14.41	46.00	41.12	19.05	1.10	29.68	---	Peak
6	848.80	31.96	-14.04	46.00	39.84	20.50	1.28	29.66	---	Peak



4. List of Measuring Equipment

Instrument	Manufacturer	Model No.	Serial No.	Characteristics	Calibration Date	Test Date	Due Date	Remark
EMI Test Receiver	R&S	ESCI7	100768	9kHz~7GHz	Jun. 02, 2011	Dec. 12, 2011	Jun. 01, 2012	Conduction (CO01-KS)
LISN	MessTec	AN3016	60103	9kHz~30MHz	Jan. 07, 2011	Dec. 12, 2011	Jan. 06, 2012	Conduction (CO01-KS)
LISN	MessTec	AN3016	60105	9kHz~30MHz	Jan. 07, 2011	Dec. 12, 2011	Jan. 06, 2012	Conduction (CO01-KS)
AC Power Source	Chroma	61602	ABP0000008 11	N/A	Nov. 16, 2011	Dec. 12, 2011	Nov. 15, 2012	Conduction (CO01-KS)
EMI Test Receiver	R&S	ESCI	100534	9kHz~3GHz	Nov. 09, 2011	Dec. 13, 2011	Nov. 08, 2012	Radiation (03CH01-KS)
Spectrum Analyzer	R&S	FSP40	100319	9kHz~40GHz	Jan. 07, 2011	Dec. 13, 2011	Jan. 06, 2012	Radiation (03CH01-KS)
Spectrum Analyzer	R&S	FSP30	101400	9kHz~30GHz	Jun. 02, 2011	Dec. 13, 2011	Jun. 01, 2012	Radiation (03CH01-KS)
Bilog Antenna	SCHAFFNER	CBL6112D	23182	25MHz~2GHz	Dec. 08, 2011	Dec. 13, 2011	Dec. 07, 2012	Radiation (03CH01-KS)
Double Ridge Horn Antenna	EMCO	3117	00075959	1GHz~18GHz	Jan. 07, 2011	Dec. 13, 2011	Jan. 06, 2012	Radiation (03CH01-KS)
Amplifier	Wireless	FPA-6592G	060029	9kHz~2GHz	Jan. 10, 2011	Dec. 13, 2011	Jan. 09, 2012	Radiation (03CH01-KS)
Amplifier	Agilent	8449B	3008A02370	1GHz~26.5GHz	Jan. 07, 2011	Dec. 13, 2011	Jan. 06, 2012	Radiation (03CH01-KS)
Active Horn Antenna	com-power	AHA-118	701023	1G-18GHz	Nov. 07, 2011	Dec. 13, 2011	Nov. 06, 2012	Radiation (03CH01-KS)
SHF-EHF Horn	Schwarzbeck	BBHA 9170	BBHA170249	15-40GHz	Oct. 11, 2011	Dec. 13, 2011	Oct. 10, 2012	Radiation (03CH01-KS)
System Simulator	R&S	CMU200	837587/066	Full-Band	Jan. 07, 2011	Dec. 12, 2011~ Dec. 13, 2011	Jan. 06, 2012	-
GPS Station	T&E	GS-50	N/A	N/A	N/A	Dec. 12, 2011~ Dec. 13, 2011	N/A	-

5. Uncertainty of Evaluation

Uncertainty of Conducted Emission Measurement (150 KHz ~ 30 MHz)

Contribution	Uncertainty of X_i		$u(X_i)$
	dB	Probability Distribution	
Receiver Reading	0.10	Normal (k=2)	0.05
Cable Loss	0.10	Normal (k=2)	0.05
AMN Insertion Loss	2.50	Rectangular	0.63
Receiver Specification	1.50	Rectangular	0.43
Site Imperfection	1.39	Rectangular	0.80
Mismatch	+0.34 / -0.35	U-Shape	0.24
Combined Standard Uncertainty $U_c(y)$	1.13		
Measuring Uncertainty for a Level of Confidence of 95% ($U = 2U_c(y)$)	2.26		

Uncertainty of Radiated Emission Measurement (30 MHz ~ 1000 MHz)

Contribution	Uncertainty of X_i		$u(X_i)$
	dB	Probability Distribution	
Receiver Reading	0.41	Normal (k=2)	0.21
Antenna Factor Calibration	0.83	Normal (k=2)	0.42
Cable Loss Calibration	0.25	Normal (k=2)	0.13
Pre-Amplifier Gain Calibration	0.27	Normal (k=2)	0.14
RCV/SPA Specification	2.50	Rectangular	0.72
Antenna Factor Interpolation for Frequency	1.00	Rectangular	0.29
Site Imperfection	1.43	Rectangular	0.83
Mismatch	+0.39 / -0.41	U-Shape	0.28
Combined Standard Uncertainty $U_c(y)$	1.27		
Measuring Uncertainty for a Level of Confidence of 95% ($U = 2U_c(y)$)	2.54		



Uncertainty of Radiated Emission Measurement (1 GHz ~ 40 GHz)

Contribution	Uncertainty of X_i		$u(X_i)$	C_i	$C_i * u(X_i)$
	dB	Probability Distribution			
Receiver Reading	± 0.10	Normal (k=2)	0.10	1	0.10
Antenna Factor Calibration	± 1.70	Normal (k=2)	0.85	1	0.85
Cable Loss Calibration	± 0.50	Normal (k=2)	0.25	1	0.25
Receiver Correction	± 2.00	Rectangular	1.15	1	1.15
Antenna Factor Directional	± 1.50	Rectangular	0.87	1	0.87
Site Imperfection	± 2.80	Triangular	1.14	1	1.14
Mismatch Receiver VSWR $\Gamma_1 = 0.197$ Antenna VSWR $\Gamma_2 = 0.194$ Uncertainty = $20\text{Log}(1-\Gamma_1*\Gamma_2)$	+0.34 / -0.35	U-Shape	0.244	1	0.244
Combined Standard Uncertainty $U_c(y)$	2.36				
Measuring Uncertainty for a Level of Confidence of 95% ($U = 2U_c(y)$)	4.72				