

FCC RF Test Report

APPLICANT : Motorola Mobility Inc.
EQUIPMENT : Quad-Band GSM/GPRS/EDGE and Dual-Band WCDMA Mobile Phone with BT/Wifi
BRAND NAME : Motorola
MODEL NAME : XT320
MARKETING NAME : MOTOROLA DEFY MINI
TYPE NAME : M0C5B
GPPD Number : 3163
FCC ID : IHDP56MK3
STANDARD : FCC 47 CFR Part 2, 22(H), 24(E)
CLASSIFICATION : PCS Licensed Transmitter Held to Ear (PCE)
Tx/Rx FREQUENCY RANGE : GSM850 : 824.2 ~ 848.8 MHz /
869.2 ~ 893.8 MHz
GSM1900 : 1850.2 ~ 1909.8 MHz /
1930.2 ~ 1989.8 MHz
MAX. ERP/EIRP POWER : GSM850 (GPRS 8) : 1.256 W
GSM850 (EDGE 8) : 0.387 W
GSM1900 (GPRS 8) : 1.219 W
GSM1900 (EDGE 8) : 0.568 W

The product was received on Dec. 01, 2011 and completely tested on Dec. 24, 2011. We, SPORTON INTERNATIONAL INC., would like to declare that the tested sample has been evaluated in accordance with the procedures given in ANSI / TIA / EIA-603-C-2004 and shown compliance with the applicable technical standards.

The test results in this report apply exclusively to the tested model / sample. Without written approval of SPORTON INTERNATIONAL INC., the test report shall not be reproduced except in full.

Reviewed by:



Jones Tsai / Manager



SPORTON INTERNATIONAL INC.

No. 52, Hwa Ya 1st Rd., Hwa Ya Technology Park, Kwei-Shan Hsiang, Tao Yuan Hsien, Taiwan, R.O.C.



TABLE OF CONTENTS

REVISION HISTORY 3
SUMMARY OF TEST RESULT 4
1 GENERAL DESCRIPTION 5
1.1 Applicant 5
1.2 Manufacturer 5
1.3 Feature of Equipment Under Test 5
1.4 Emission Designator and Maximum ERP/EIRP Power 6
1.5 Testing Site 6
1.6 Applied Standards 6
1.7 Ancillary Equipment List 7
2 TEST CONFIGURATION OF EQUIPMENT UNDER TEST 8
2.1 Test Mode 8
2.2 Connection Diagram of Test System 9
3 TEST RESULT 10
3.1 Conducted Output Power Measurement 10
3.2 Effective Radiated Power and Effective Isotropic Radiated Power Measurement 12
3.3 Occupied Bandwidth Measurement 16
3.4 Band Edge Measurement 21
3.5 Conducted Emission Measurement 26
3.6 Field Strength of Spurious Radiation Measurement 37
3.7 Frequency Stability Measurement 47
4 LIST OF MEASURING EQUIPMENT 51
5 UNCERTAINTY OF EVALUATION 52



SUMMARY OF TEST RESULT

Report Section	FCC Rule	IC Rule	Description	Limit	Result	Remark
3.1	§2.1046	N/A	Conducted Output Power	N/A	PASS	-
3.2	§22.913(a)(2)	RSS-132(4.4) SRSP-503(5.1.3)	Effective Radiated Power	< 7 Watts	PASS	-
3.2	§24.232(c)	RSS-133 (6.4) SRSP-510(5.1.2)	Equivalent Isotropic Radiated Power	< 2 Watts	PASS	-
3.3	§2.1049 §22.917(a) §24.238(a)	N/A	Occupied Bandwidth	N/A	PASS	-
3.4	§2.1051 §22.917(a) §24.238(a)	RSS-132 (4.5.1) RSS-133 (6.5.1)	Band Edge Measurement	< 43+10log ₁₀ (P[Watts])	PASS	-
3.5	§2.1051 §22.917(a) §24.238(a)	RSS-132 (4.5.1) RSS-133 (6.5.1)	Conducted Emission	< 43+10log ₁₀ (P[Watts])	PASS	-
3.6	§2.1053 §22.917(a) §24.238(a)	RSS-132 (4.5.1) RSS-133 (6.5.1)	Field Strength of Spurious Radiation	< 43+10log ₁₀ (P[Watts])	PASS	Under limit 23.86 dB at 2510.000 MHz
3.7	§2.1055 §22.355 §24.235	RSS-132(4.3) RSS-133(6.3)	Frequency Stability for Temperature & Voltage	< 2.5 ppm	PASS	-



1 General Description

1.1 Applicant

Motorola Mobility Inc.

No. 1, Wang Jing East Road, Chao Yang District, 100102 Beijing, P. R. China

1.2 Manufacturer

Gongqingcheng Cellon Communication Technology Co., LTD.

New industrial park, GongQingCheng, Jiujiang city, Jiangxi Province, China. Postal code: 332020

1.3 Feature of Equipment Under Test

Product Feature & Specification	
Equipment	Quad-Band GSM/GPRS/EDGE and Dual-Band WCDMA Mobile Phone with BT/Wifi
Brand Name	Motorola
Model Name	XT320
Marketing Name	MOTOROLA DEFY MINI
Type Name	M0C5B
FCC ID	IHDP56MK3
Tx Frequency	GSM850 : 824 MHz ~ 849 MHz GSM1900 : 1850 MHz ~ 1910 MHz
Rx Frequency	GSM850 : 869 MHz ~ 894 MHz GSM1900 : 1930 MHz ~ 1990 MHz
Maximum Output Power to Antenna	GSM850 : 33.36 dBm GSM1900 : 30.38 dBm
Antenna Type	Fixed Internal Antenna
HW Version	B3
SW Version	TNBST_4_0A.12.10.RDD
Type of Modulation	GSM: GMSK GPRS: GMSK EDGE: GMSK / 8PSK WCDMA: QPSK (Uplink) HSDPA: QPSK (Uplink)
EUT Stage	Production Unit

Remark: The above EUT's information was declared by manufacturer. Please refer to the specifications or user's manual for more detailed description.

1.4 Emission Designator and Maximum ERP/EIRP Power

FCC Rule	System	Type of Modulation	Emission Designator	Maximum ERP/EIRP
Part 22	GSM850 GPRS 8	GMSK	250KGXW	1.256 W
Part 22	GSM850 EDGE 8	GMSK / 8PSK	240KG7W	0.387 W
Part 24	GSM1900 GPRS 8	GMSK	246KGXW	1.219 W
Part 24	GSM1900 EDGE 8	GMSK / 8PSK	248KG7W	0.568 W

1.5 Testing Site

Test Site	SPORTON INTERNATIONAL INC.		
Test Site Location	No. 3-2, PingXiang Road, Kunshan, Jiangsu Province, P.R.C. TEL: +86-0512-5790-0158 FAX: +86-0512-5790-0958		
Test Site No.	Sporton Site No.		FCC/IC Registration No.
	TH01-KS	03CH01-KS	722060/4086B-1

1.6 Applied Standards

According to the specifications of the manufacturer, the EUT must comply with the requirements of the following standards:

- ♦ Preliminary Guidance for Receiving Applications for Certification of 3G Device. May 9, 2006.
- ♦ FCC 47 CFR Part 2, 22(H), 24(E)
- ♦ ANSI / TIA / EIA-603-C-2004
- ♦ IC RSS-132 Issue 2
- ♦ IC RSS-133 Issue 5

Remark:

1. All test items were verified and recorded according to the standards and without any deviation during the test.
2. This EUT has also been tested and complied with the requirements of FCC Part 15, Subpart B, recorded in a separate test report.



1.7 Ancillary Equipment List

Item	Equipment	Trade Name	Model No.	FCC ID	Data Cable	Power Cord
1.	System Simulator	R&S	CMU200	N/A	N/A	Unshielded, 1.8 m
2.	DC Power Supply	GW	GPC-60300	N/A	N/A	Unshielded, 1.8 m

2 Test Configuration of Equipment Under Test

2.1 Test Mode

During all testing, EUT is in link mode with base station emulator at maximum power level. The spurious emission measurements were carried out in semi-anechoic chamber with 3-meter test range, and EUT is rotated on three test planes to find out the worst emission.

Frequency range investigated for radiated emission is as follows:

1. 30 MHz to 9000 MHz for GSM850.
2. 30 MHz to 19000 MHz for GSM1900.

Test Modes		
Band	Radiated TCs	Conducted TCs
GSM 850	<ul style="list-style-type: none"> ■ GPRS 8 Link ■ EDGE 8 Link 	<ul style="list-style-type: none"> ■ GPRS 8 Link ■ EDGE 8 Link
GSM 1900	<ul style="list-style-type: none"> ■ GPRS 8 Link ■ EDGE 8 Link 	<ul style="list-style-type: none"> ■ GPRS 8 Link ■ EDGE 8 Link

Note:

1. The maximum power levels are GSM or GPRS multi-slot class 8 mode for GMSK link, EDGE multi-slot class 8 mode for 8PSK link, only these modes were used for all tests.
2. Because there are individual antennas for each WWAN, WLAN, and Bluetooth, the co-location test modes are not required.

The conducted power tables are as follows:

Band	GSM850			GSM1900		
	128	189	251	512	661	810
Channel	824.2	836.4	848.8	1850.2	1880.0	1909.8
Frequency (MHz)	824.2	836.4	848.8	1850.2	1880.0	1909.8
GSM (1 Uplink)	33.33	33.26	33.14	30.16	30.28	30.37
GPRS 8 (1 Uplink)	33.36	33.25	33.17	30.17	30.30	30.38
GPRS 10 (2 Uplink)	30.52	30.45	30.31	28.06	28.13	28.28
GPRS 12 (4 Uplink)	27.40	27.31	27.22	24.39	24.51	24.58
EDGE 8 (MCS9) (1 Uplink)	27.37	27.28	27.11	26.14	26.23	26.35
EDGE 10 (MCS9) (2 Uplink)	26.48	26.36	26.20	26.11	26.19	26.28
EDGE 12 (MCS9) (4 Uplink)	24.39	24.25	24.15	24.22	24.40	24.42

2.2 Connection Diagram of Test System

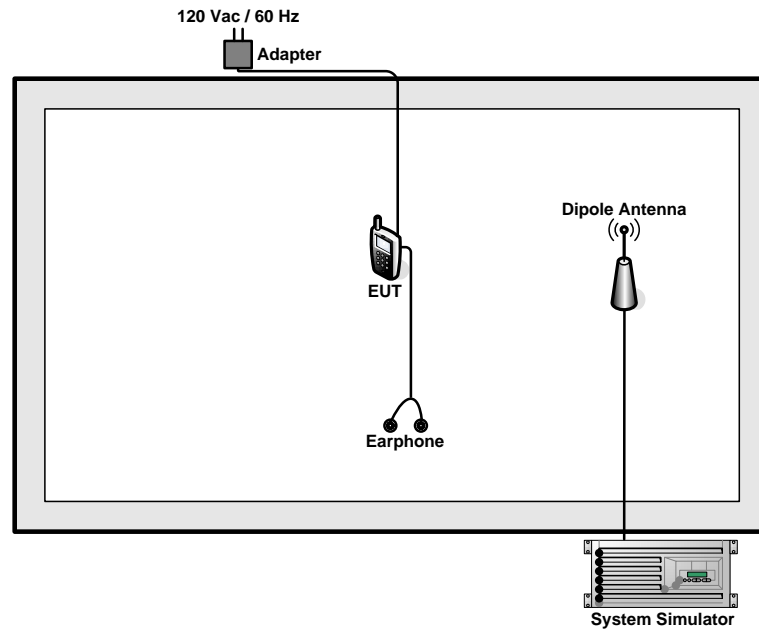

3 Test Result

3.1 Conducted Output Power Measurement

3.1.1 Description of the Conducted Output Power Measurement

A base station simulator was used to establish communication with the EUT. Its parameters were set to transmit the maximum power on the EUT. The measured power in the radio frequency on the transmitter output terminals shall be reported.

3.1.2 Measuring Instruments

See list of measuring instruments of this test report.

3.1.3 Test Procedures

1. The transmitter output port was connected to base station.
2. Set EUT at maximum power through base station.
3. Select lowest, middle, and highest channels for each band and different modulation.

3.1.4 Test Setup

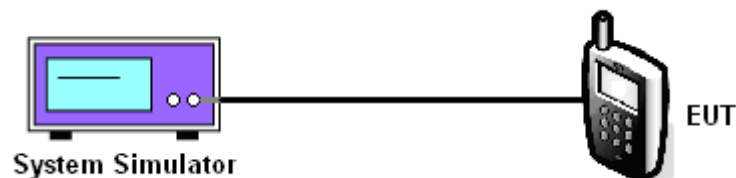



3.1.5 Test Result of Conducted Output Power

Cellular Band						
Modes	GSM850 (GPRS 8)			GSM850 (EDGE 8)		
Channel	128 (Low)	189 (Mid)	251 (High)	128 (Low)	189 (Mid)	251 (High)
Frequency (MHz)	824.2	836.4	848.8	824.2	836.4	848.8
Conducted Power (dBm)	33.36	33.25	33.17	27.37	27.28	27.11
Conducted Power (Watts)	2.17	2.11	2.07	0.55	0.53	0.51

PCS Band						
Modes	GSM1900 (GPRS 8)			GSM1900 (EDGE 8)		
Channel	512 (Low)	661 (Mid)	810 (High)	512 (Low)	661 (Mid)	810 (High)
Frequency (MHz)	1850.2	1880	1909.8	1850.2	1880	1909.8
Conducted Power (dBm)	30.17	30.30	30.38	26.14	26.23	26.35
Conducted Power (Watts)	1.04	1.07	1.09	0.41	0.42	0.43

3.2 Effective Radiated Power and Effective Isotropic Radiated Power Measurement

3.2.1 Description of the ERP/EIRP Measurement

ERP/EIRP is measured by substitution method according to ANSI / TIA / EIA-603-C-2004. The ERP of mobile transmitters must not exceed 7 Watts and the EIRP of mobile transmitters are limited to 2 Watts.

3.2.2 Measuring Instruments

See list of measuring instruments of this test report.

3.2.3 Test Procedures

1. The EUT was placed on a turntable with 1.0 meter height in a fully anechoic chamber.
2. The EUT was set at 1.2 meters from the receiving antenna, which was mounted on the antenna tower.
3. The table was rotated 360 degrees to determine the position of the highest radiated power.
4. The height of the receiving antenna is adjusted to look for the maximum ERP/EIRP.
5. Taking the record of maximum ERP/EIRP.
6. A dipole antenna was substituted in place of the EUT and was driven by a signal generator.
7. The conducted power at the terminal of the dipole antenna is measured.
8. Repeat step 3 to step 5 to get the maximum ERP/EIRP of the substitution antenna.
9. $ERP/EIRP = P_s + E_t - E_s + G_s = P_s + R_t - R_s + G_s$
Ps (dBm) : Input power to substitution antenna.
Gs (dBi or dBd) : Substitution antenna Gain.
 $E_t = R_t + AF$
 $E_s = R_s + AF$
AF (dB/m) : Receive antenna factor
Rt : The highest received signal in spectrum analyzer for EUT.
Rs : The highest received signal in spectrum analyzer for substitution antenna.

3.2.4 Test Setup

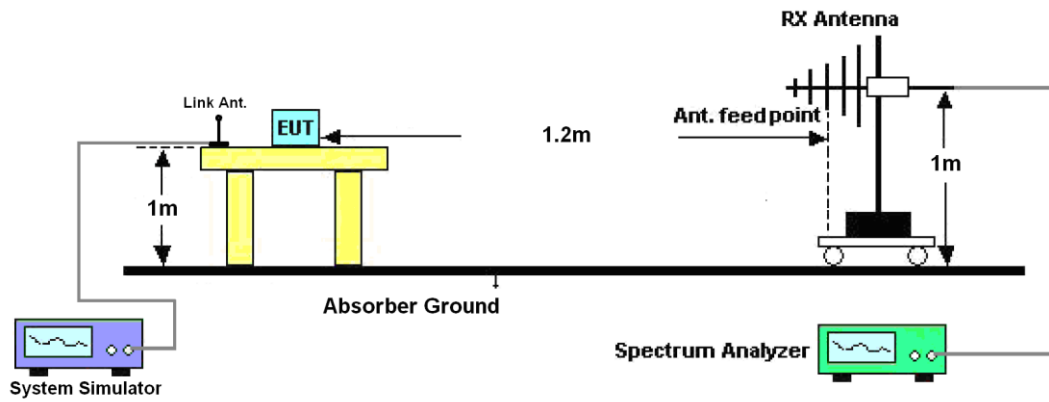



3.2.5 Test Result of ERP

GSM850 (GPRS 8) Radiated Power ERP						
Horizontal Polarization						
Frequency (MHz)	Rt (dBm)	Rs (dBm)	Ps (dBm)	Gs (dBd)	ERP (dBm)	ERP (W)
824.20	-17.90	-48.12	0.00	-1.08	29.14	0.820
836.40	-16.53	-48.28	0.00	-0.93	30.82	1.208
848.80	-16.60	-48.35	0.00	-0.76	30.99	1.256
Vertical Polarization						
Frequency (MHz)	Rt (dBm)	Rs (dBm)	Ps (dBm)	Gs (dBd)	ERP (dBm)	ERP (W)
824.20	-32.17	-47.97	0.00	-1.08	14.72	0.030
836.40	-30.25	-48.01	0.00	-0.93	16.83	0.048
848.80	-30.17	-48.05	0.00	-0.76	17.12	0.052

GSM850 (EDGE 8) Radiated Power ERP						
Horizontal Polarization						
Frequency (MHz)	Rt (dBm)	Rs (dBm)	Ps (dBm)	Gs (dBd)	ERP (dBm)	ERP (W)
824.20	-21.90	-48.12	0.00	-1.08	25.14	0.327
836.40	-21.47	-48.28	0.00	-0.93	25.88	0.387
848.80	-21.91	-48.35	0.00	-0.76	25.68	0.370
Vertical Polarization						
Frequency (MHz)	Rt (dBm)	Rs (dBm)	Ps (dBm)	Gs (dBd)	ERP (dBm)	ERP (W)
824.20	-36.36	-47.97	0.00	-1.08	10.53	0.011
836.40	-35.06	-48.01	0.00	-0.93	12.02	0.016
848.80	-35.83	-48.05	0.00	-0.76	11.46	0.014



3.2.6 Test Result of EIRP

GSM1900 (GPRS 8) Radiated Power EIRP						
Horizontal Polarization						
Frequency (MHz)	Rt (dBm)	Rs (dBm)	Ps (dBm)	Gs (dBi)	EIRP (dBm)	EIRP (W)
1850.20	-23.33	-51.88	0.00	1.96	30.51	1.125
1880.00	-24.46	-52.99	0.00	2.00	30.53	1.130
1909.80	-26.10	-54.28	0.00	1.98	30.16	1.038
Vertical Polarization						
Frequency (MHz)	Rt (dBm)	Rs (dBm)	Ps (dBm)	Gs (dBi)	EIRP (dBm)	EIRP (W)
1850.20	-23.23	-52.13	0.00	1.96	30.86	1.219
1880.00	-24.84	-53.17	0.00	2.00	30.33	1.079
1909.80	-25.91	-54.13	0.00	1.98	30.20	1.047

GSM1900 (EDGE 8) Radiated Power EIRP						
Horizontal Polarization						
Frequency (MHz)	Rt (dBm)	Rs (dBm)	Ps (dBm)	Gs (dBi)	EIRP (dBm)	EIRP (W)
1850.20	-26.52	-51.88	0.00	1.96	27.32	0.540
1880.00	-28.05	-52.99	0.00	2.00	26.94	0.494
1909.80	-29.54	-54.28	0.00	1.98	26.72	0.470
Vertical Polarization						
Frequency (MHz)	Rt (dBm)	Rs (dBm)	Ps (dBm)	Gs (dBi)	EIRP (dBm)	EIRP (W)
1850.20	-26.55	-52.13	0.00	1.96	27.54	0.568
1880.00	-28.37	-53.17	0.00	2.00	26.80	0.479
1909.80	-29.57	-54.13	0.00	1.98	26.54	0.451

3.3 Occupied Bandwidth Measurement

3.3.1 Description of Occupied Bandwidth Measurement

The emission bandwidth is defined as the width of the signal between two points, located at the 2 sides of the carrier frequency, outside of which all emissions are attenuated at least 26 dB below the transmitter power.

3.3.2 Measuring Instruments

See list of measuring instruments of this test report.

3.3.3 Test Procedures

1. The EUT was connected to Spectrum Analyzer and Base Station via power divider.
2. The 99% and 26 dB occupied bandwidth (BW) of the middle channel for the highest RF powers were measured.

3.3.4 Test Setup

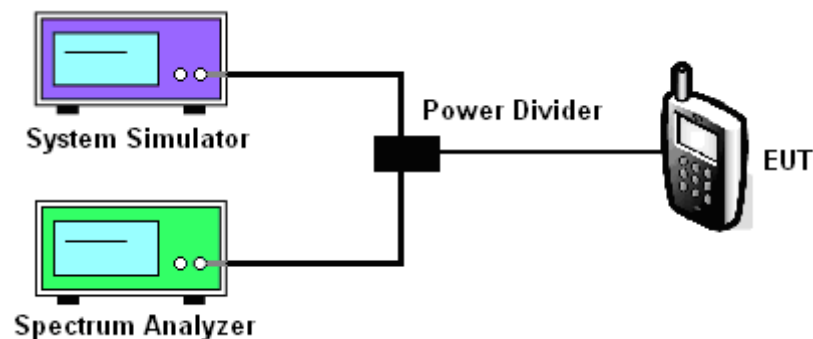



3.3.5 Test Result (Plots) of Occupied Bandwidth

Band :	GSM 850	Power Stage :	High
Test Mode :	GPRS 8 Link		

99% Occupied Bandwidth Plot on Channel 189

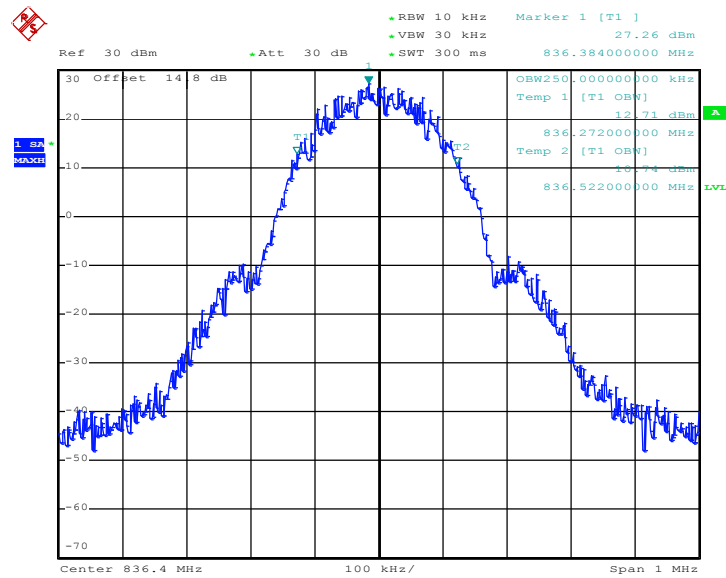

Date: 24.DEC.2011 01:23:24

26dB Bandwidth Plot on Channel 189

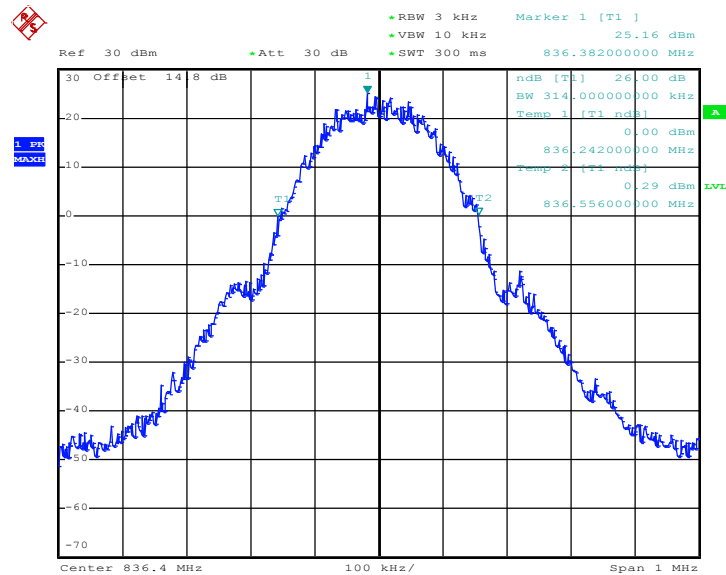

Date: 6.DEC.2011 00:30:07



Band :	GSM 1900	Power Stage :	High
Test Mode :	GPRS 8 Link		

99% Occupied Bandwidth Plot on Channel 661

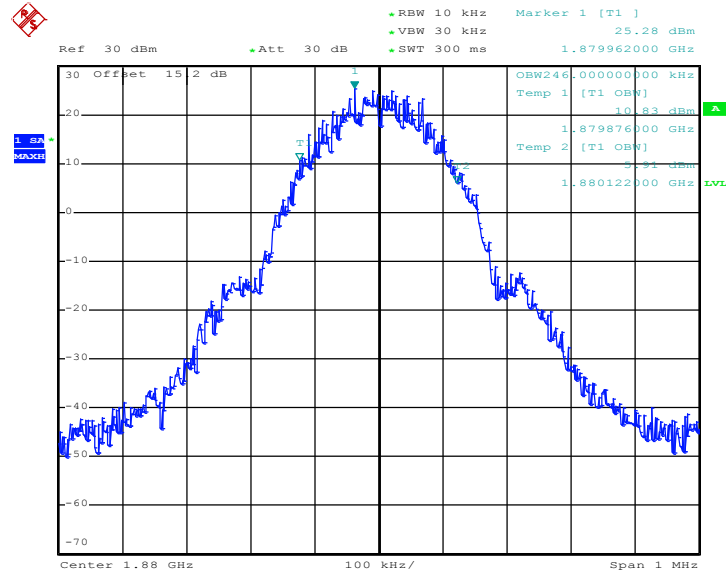

Date: 24.DEC.2011 01:28:52

26dB Bandwidth Plot on Channel 661

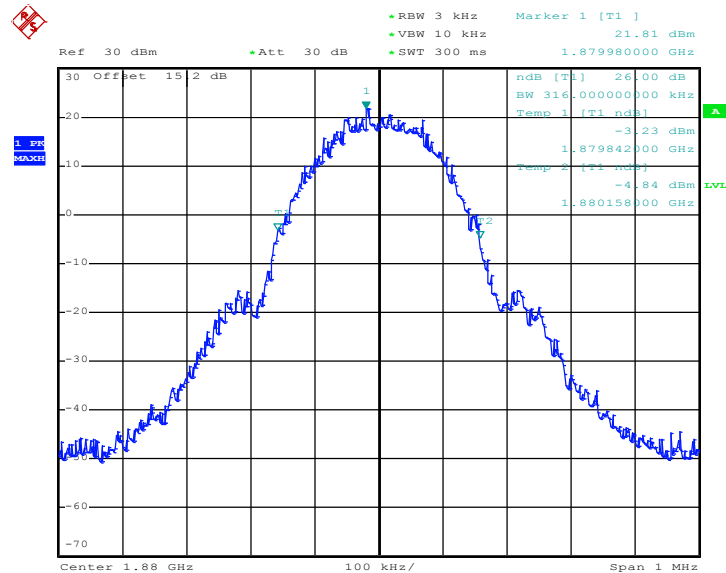

Date: 6.DEC.2011 00:51:58



Band :	GSM 1900	Power Stage :	High
Test Mode :	EDGE 8 Link		

99% Occupied Bandwidth Plot on Channel 661

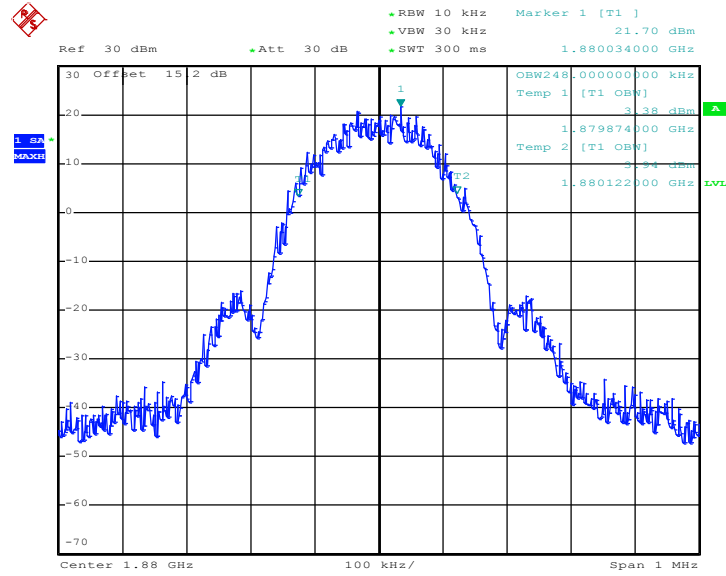

Date: 24.DEC.2011 00:10:58

26dB Bandwidth Plot on Channel 661

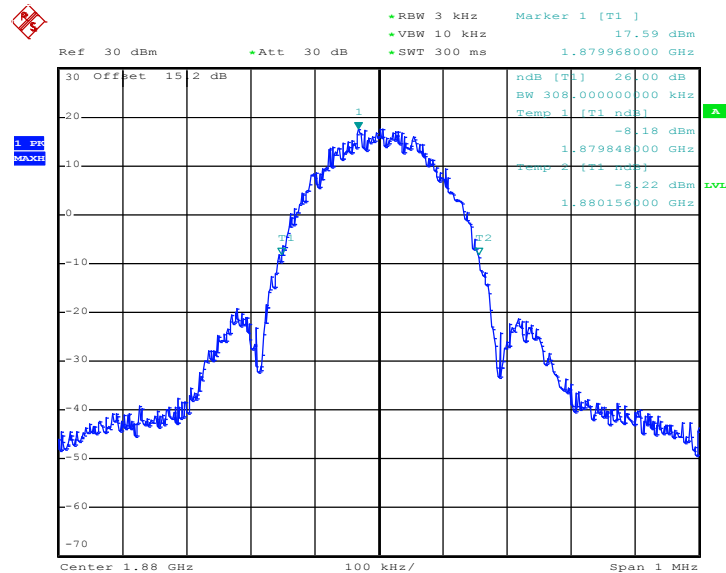

Date: 6.DEC.2011 18:45:38

3.4 Band Edge Measurement

3.4.1 Description of Band Edge Measurement

The power of any emission outside of the authorized operating frequency ranges must be lower than the transmitter power (P) by a factor of at least $43 + 10 \log (P)$ dB.

3.4.2 Measuring Instruments

See list of measuring instruments of this test report.

3.4.3 Test Procedures

1. The EUT was connected to Spectrum Analyzer and Base Station via power divider.
2. The band edges of low and high channels for the highest RF powers were measured. Setting RBW as roughly BW/100.

3.4.4 Test Setup

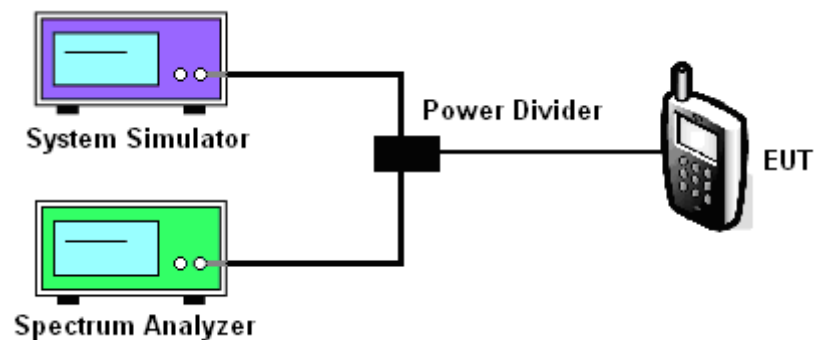

3.4.5 Test Result (Plots) of Conducted Band Edge

Band :	GSM850	Power Stage :	High
Test Mode :	GPRS 8 Link		

Lower Band Edge Plot on Channel 128

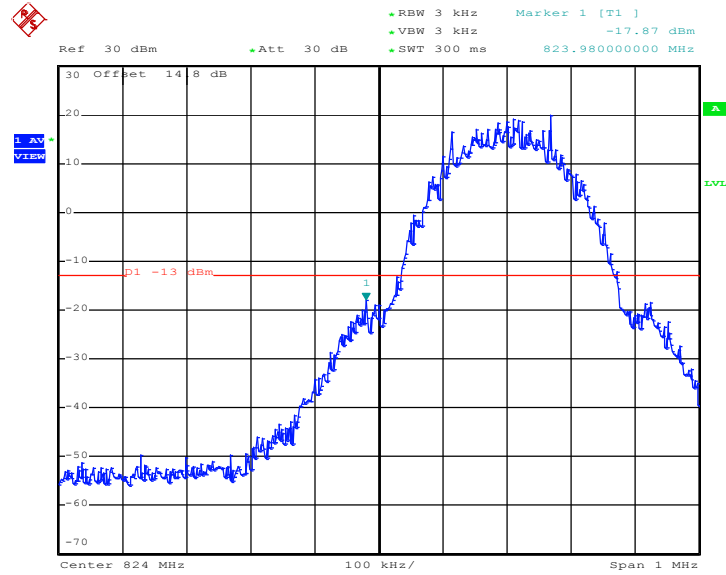

Date: 6.DEC.2011 00:33:16

Higher Band Edge Plot on Channel 251

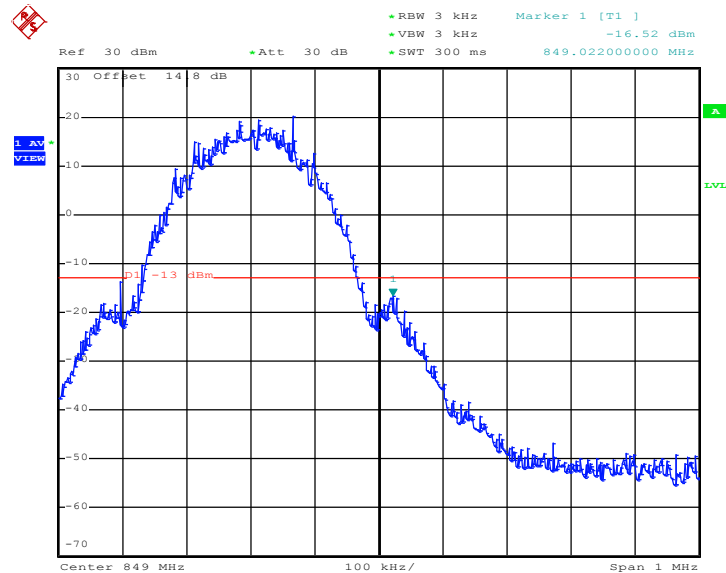

Date: 6.DEC.2011 00:33:42



Band :	GSM850	Power Stage :	High
Test Mode :	EDGE 8 Link		

Lower Band Edge Plot on Channel 128

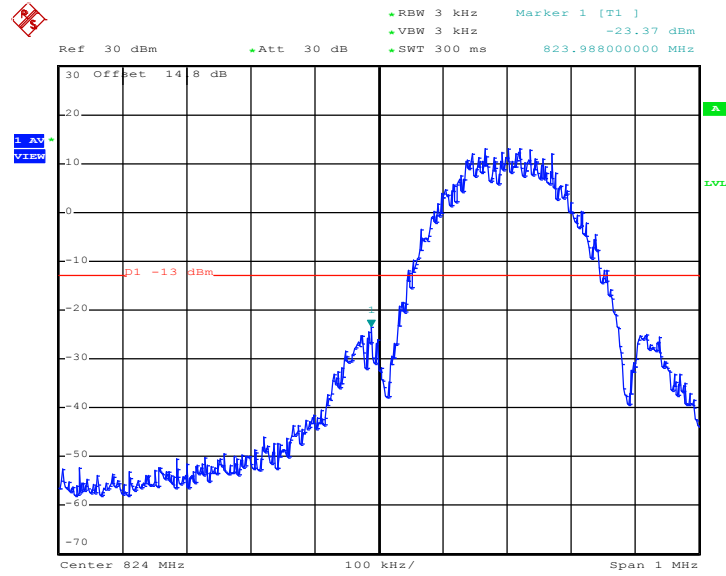

Date: 6.DEC.2011 18:26:24

Higher Band Edge Plot on Channel 251

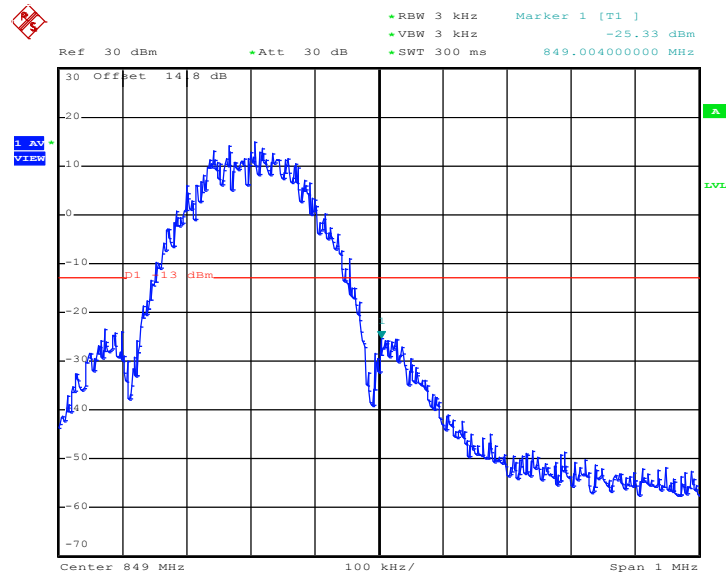

Date: 6.DEC.2011 18:26:51



Band :	GSM1900	Power Stage :	High
Test Mode :	GPRS 8 Link		

Lower Band Edge Plot on Channel 512

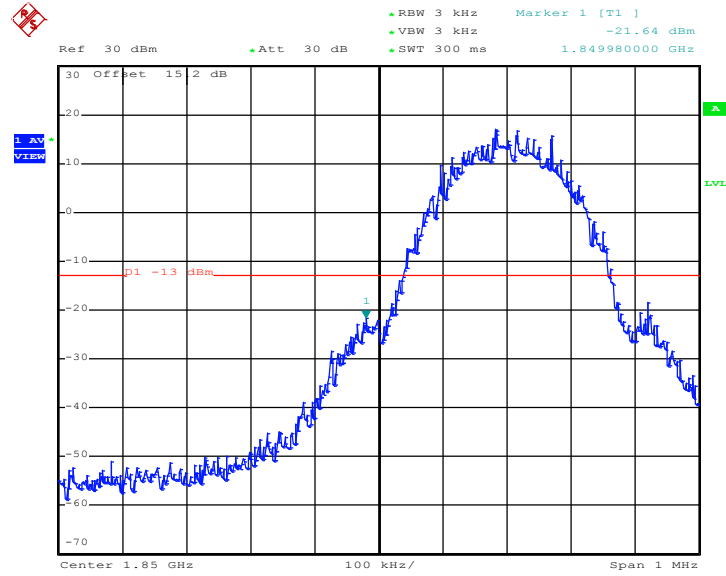

Date: 6.DEC.2011 00:55:08

Higher Band Edge Plot on Channel 810

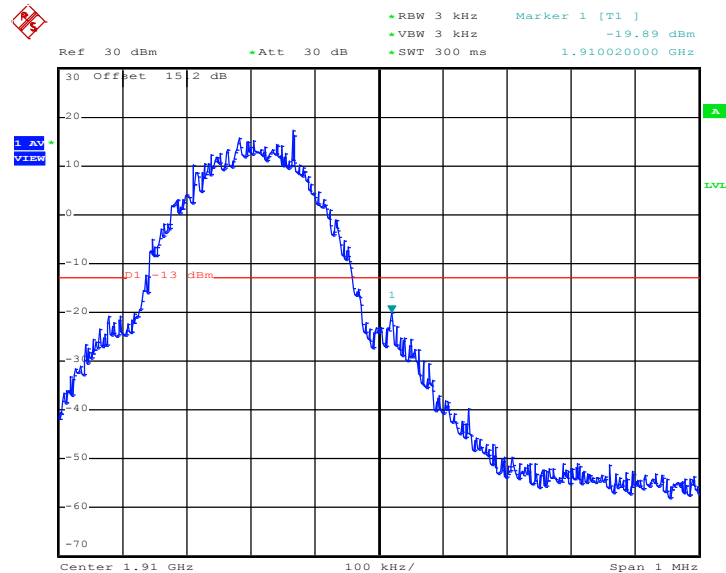

Date: 6.DEC.2011 00:55:34



Band :	GSM1900	Power Stage :	High
Test Mode :	EDGE 8 Link		

Lower Band Edge Plot on Channel 512

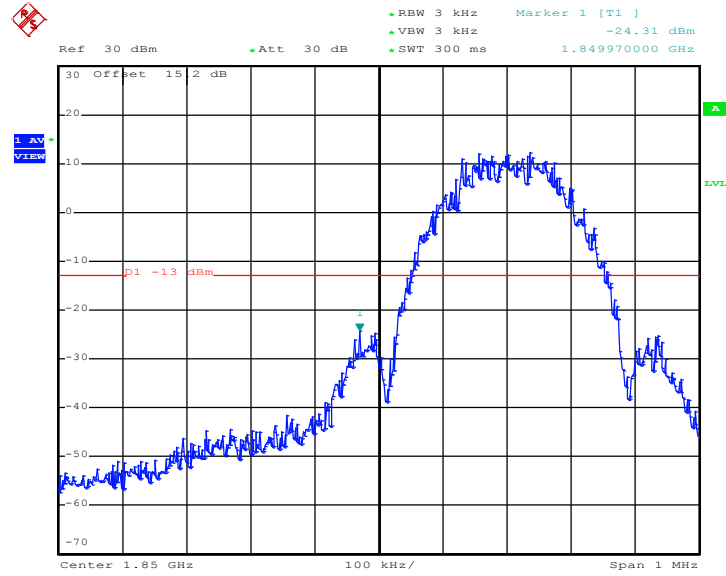

Date: 6.DEC.2011 18:48:53

Higher Band Edge Plot on Channel 810

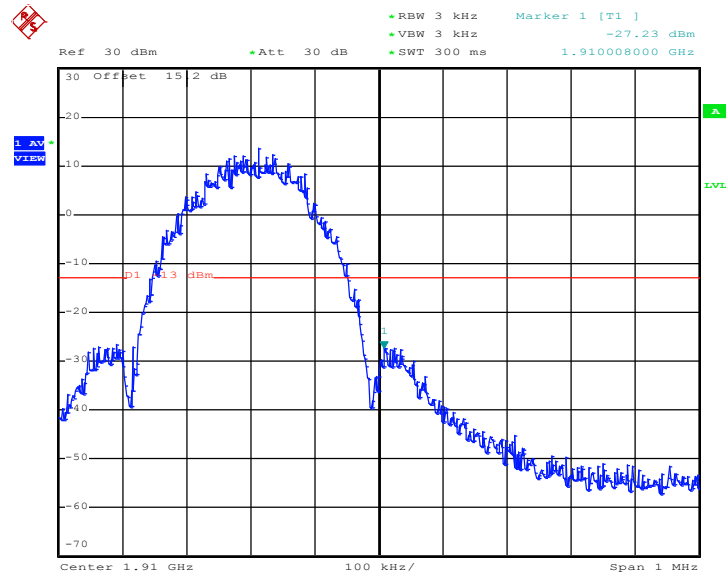

Date: 6.DEC.2011 18:49:20

3.5 Conducted Emission Measurement

3.5.1 Description of Conducted Emission Measurement

The power of any emission outside of the authorized operating frequency ranges must be lower than the transmitter power (P) by a factor of at least $43 + 10 \log (P)$ dB.

It is measured by means of a calibrated spectrum analyzer and scanned from 30 MHz up to a frequency including its 10th harmonic.

3.5.2 Measuring Instruments

See list of measuring instruments of this test report.

3.5.3 Test Procedures

1. The EUT was connected to spectrum analyzer and base station via power divider.
2. The middle channel for the highest RF power within the transmitting frequency was measured.
3. The conducted spurious emission for the whole frequency range was taken.

3.5.4 Test Setup

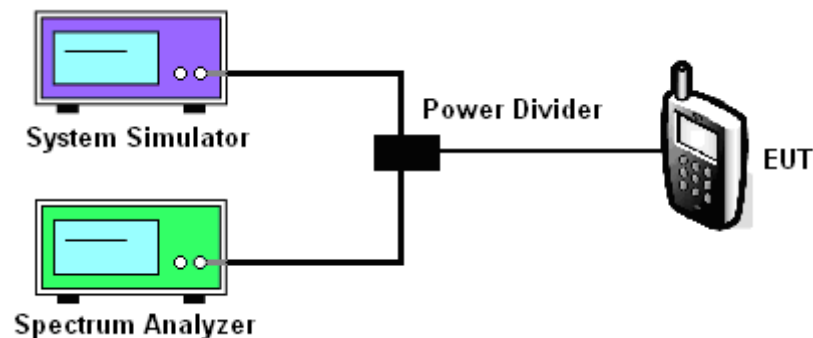

3.5.5 Test Result (Plots) of Conducted Emission

Band :	GSM850	Channel :	CH189
Test Mode :	GPRS 8 Link		

Conducted Emission Plot between 30MHz ~ 1GHz

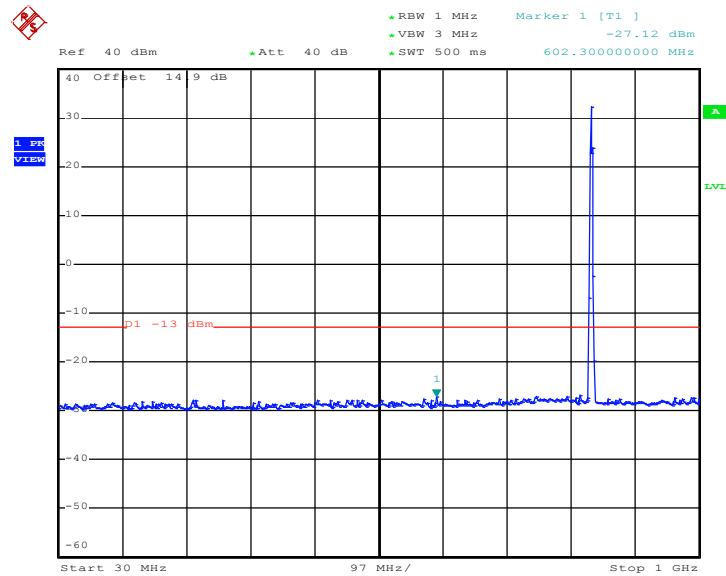

Date: 6.DEC.2011 19:36:12

Conducted Emission Plot between 1GHz ~ 3GHz

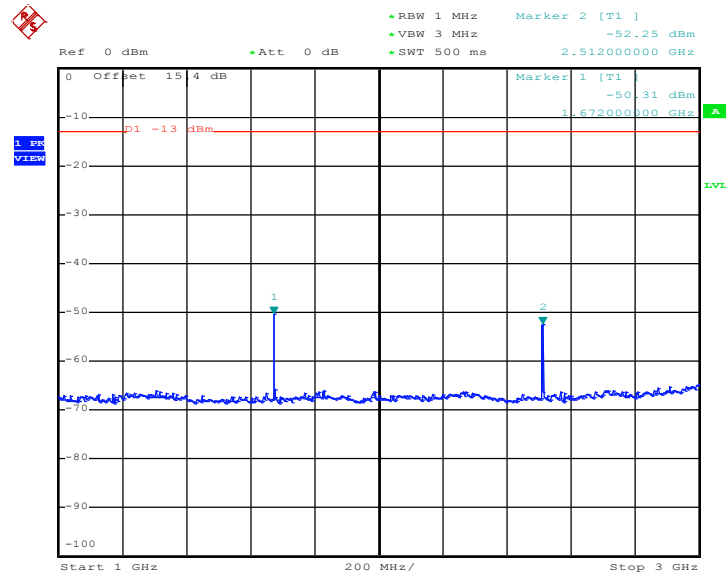

Date: 6.DEC.2011 19:37:40



Conducted Emission Plot between 3GHz ~ 7GHz

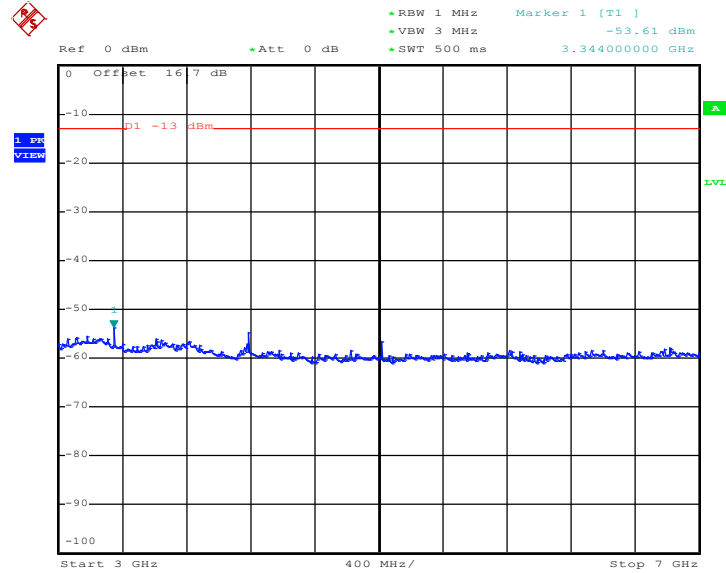

Date: 6.DEC.2011 19:38:58

Conducted Emission Plot between 7GHz ~ 9GHz

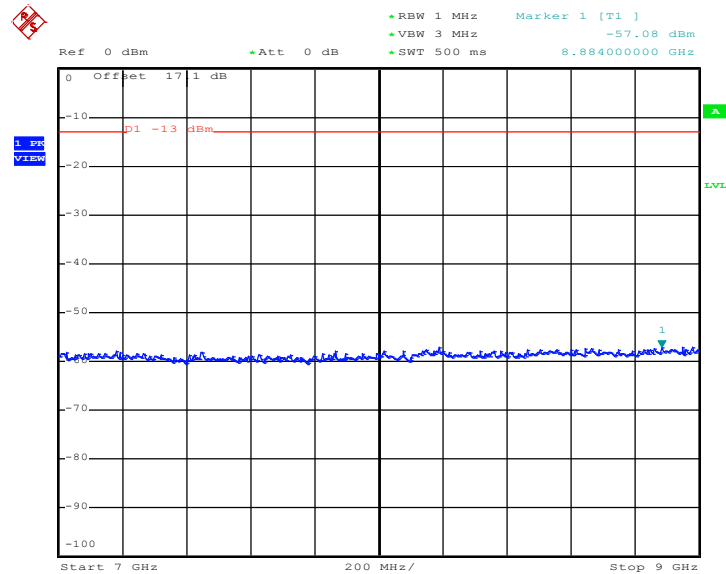

Date: 6.DEC.2011 19:40:16



Band :	GSM850	Channel :	CH189
Test Mode :	EDGE 8 Link		

Conducted Emission Plot between 30MHz ~ 1GHz

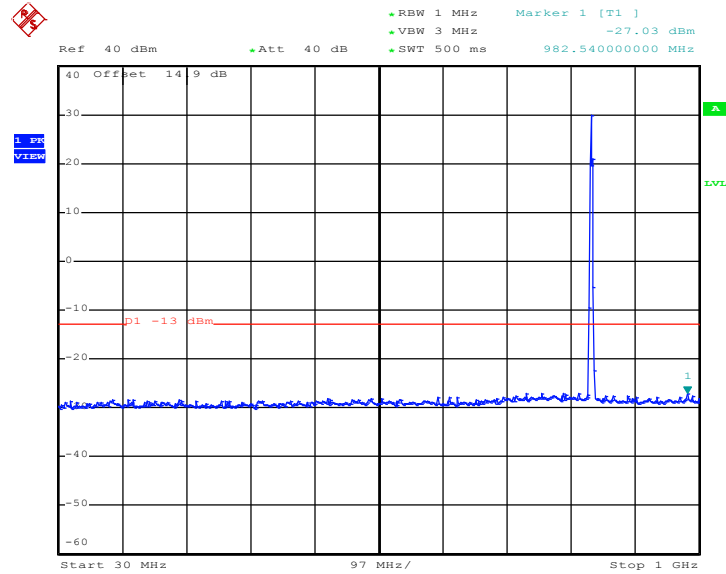

Date: 6.DEC.2011 19:26:51

Conducted Emission Plot between 1GHz ~ 3GHz

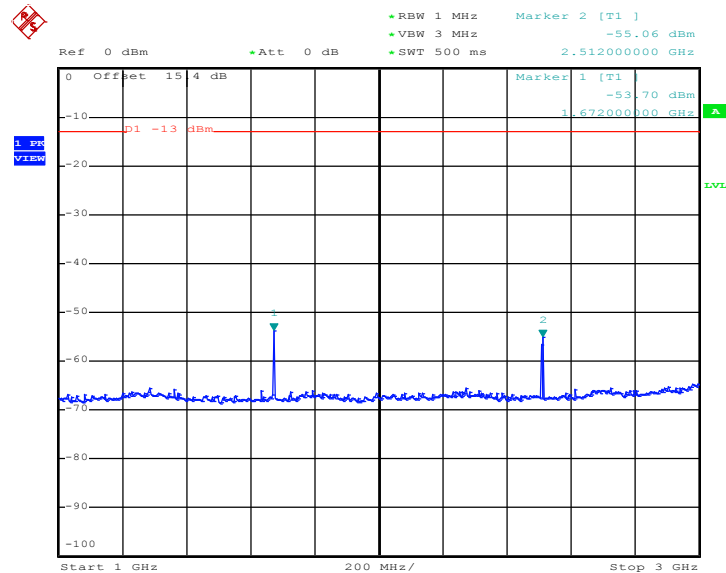

Date: 6.DEC.2011 19:28:51



Conducted Emission Plot between 3GHz ~ 7GHz

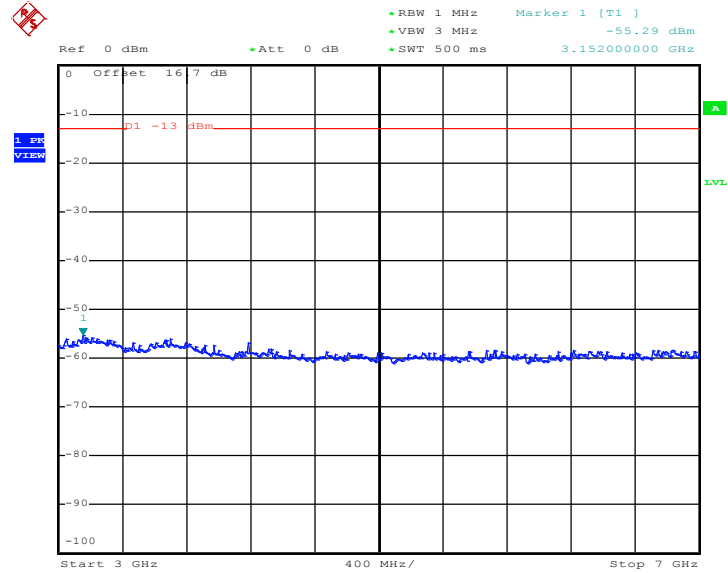

Date: 6.DEC.2011 19:30:10

Conducted Emission Plot between 7GHz ~ 9GHz

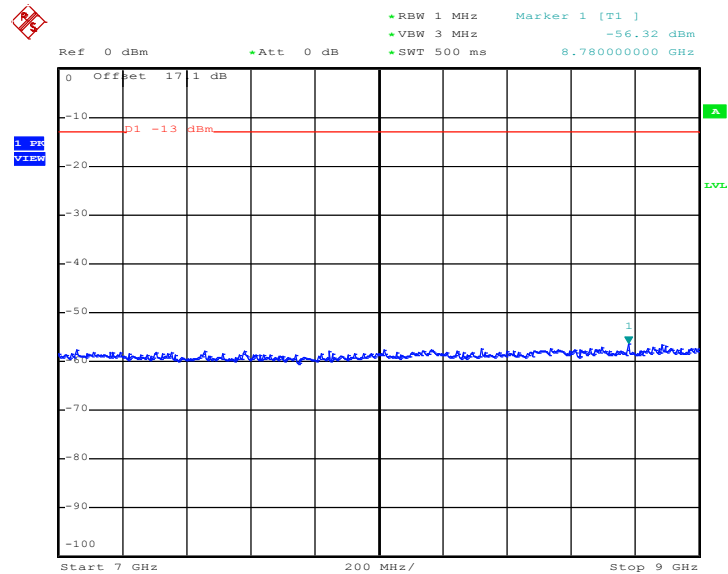

Date: 6.DEC.2011 19:31:56



Band :	GSM1900	Channel :	CH661
Test Mode :	GPRS 8 Link		

Conducted Emission Plot between 30MHz ~ 1GHz

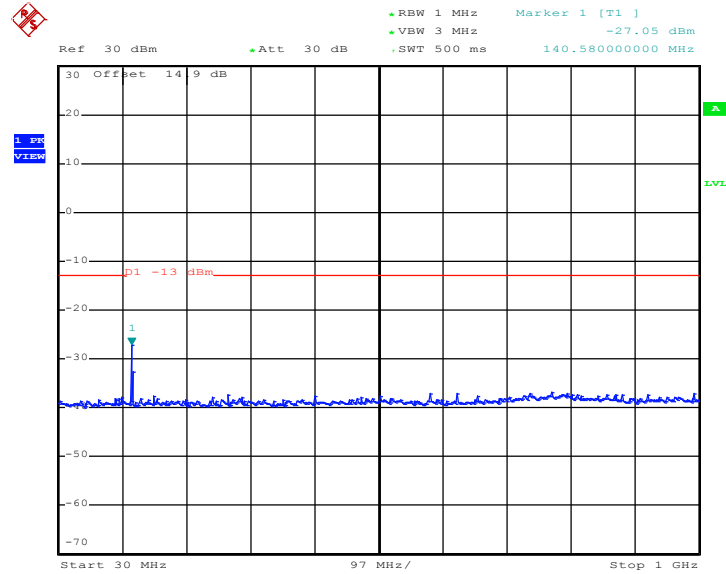

Date: 6.DEC.2011 19:43:55

Conducted Emission Plot between 1GHz ~ 3GHz

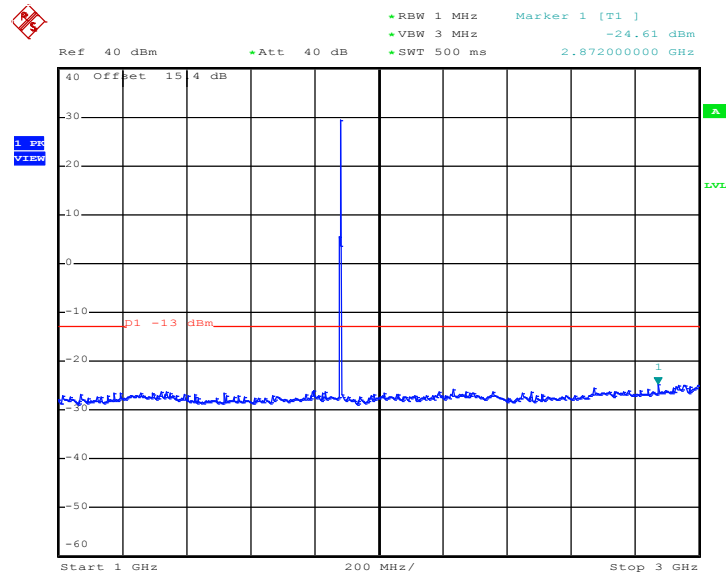

Date: 6.DEC.2011 19:44:45



Conducted Emission Plot between 3GHz ~ 7GHz

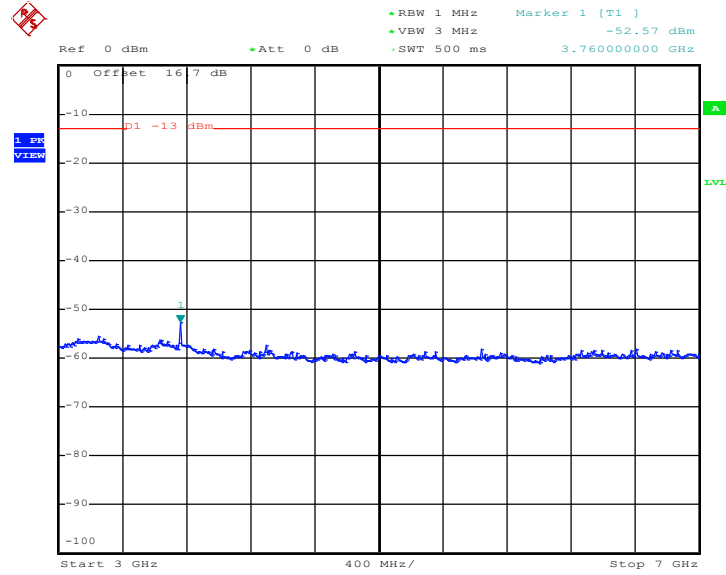

Date: 6.DEC.2011 19:46:15

Conducted Emission Plot between 7GHz ~ 13.6GHz

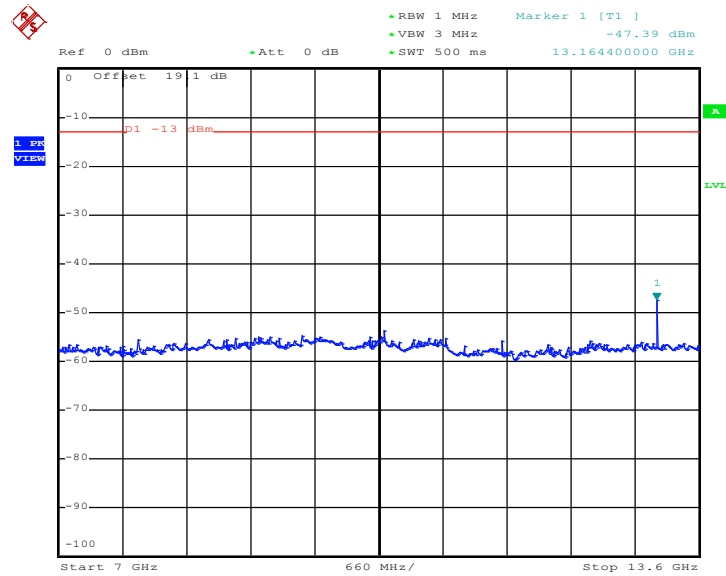

Date: 6.DEC.2011 19:47:00



Conducted Emission Plot between 13.6GHz ~ 19.1GHz

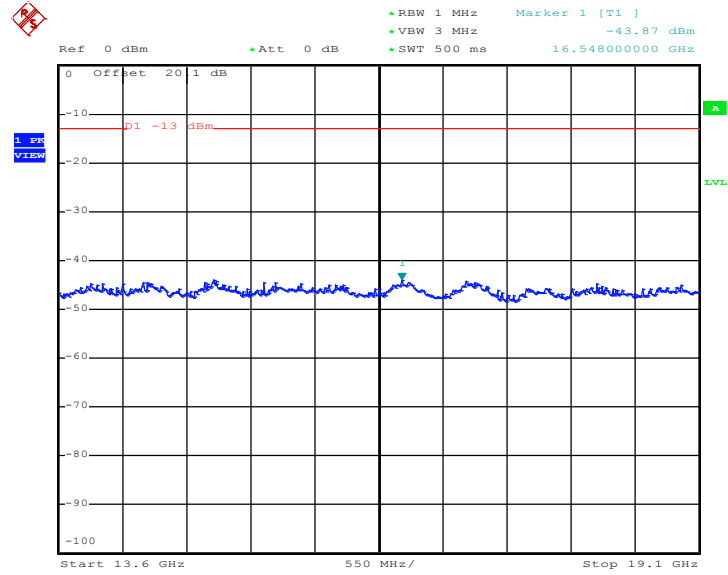

Date: 6.DEC.2011 19:47:40



Band :	GSM1900	Channel :	CH661
Test Mode :	EDGE 8 Link		

Conducted Emission Plot between 30MHz ~ 1GHz

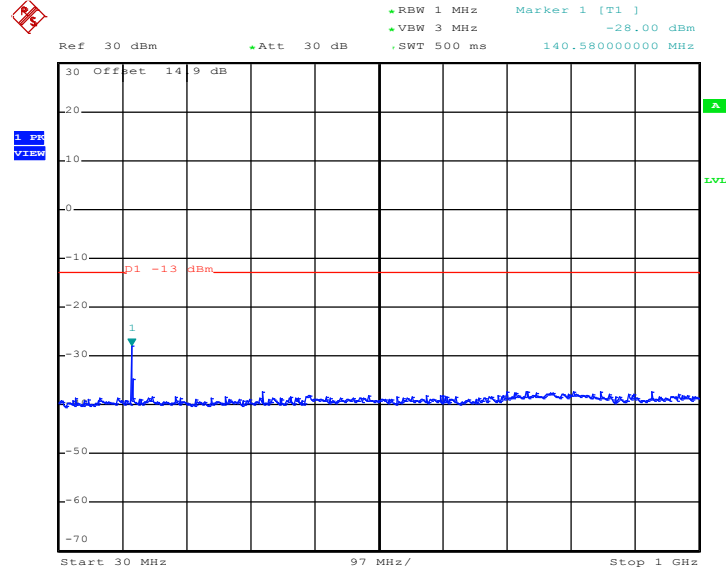

Date: 6.DEC.2011 19:16:04

Conducted Emission Plot between 1GHz ~ 3GHz

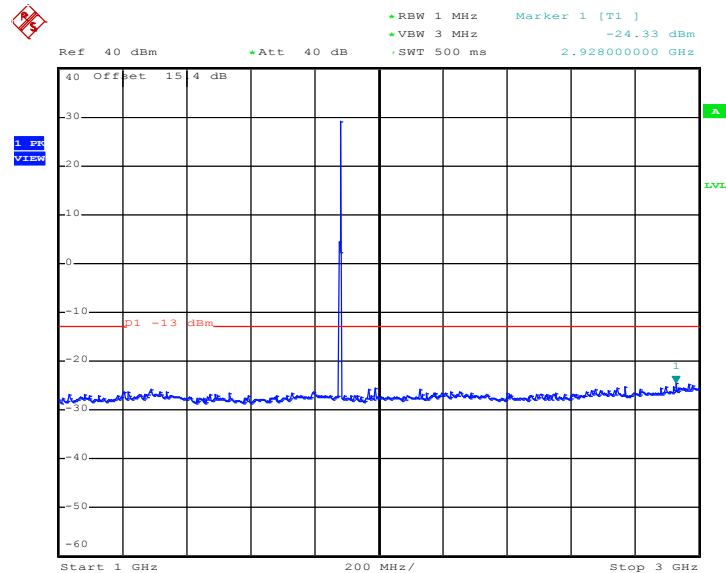

Date: 6.DEC.2011 19:17:23



Conducted Emission Plot between 3GHz ~ 7GHz

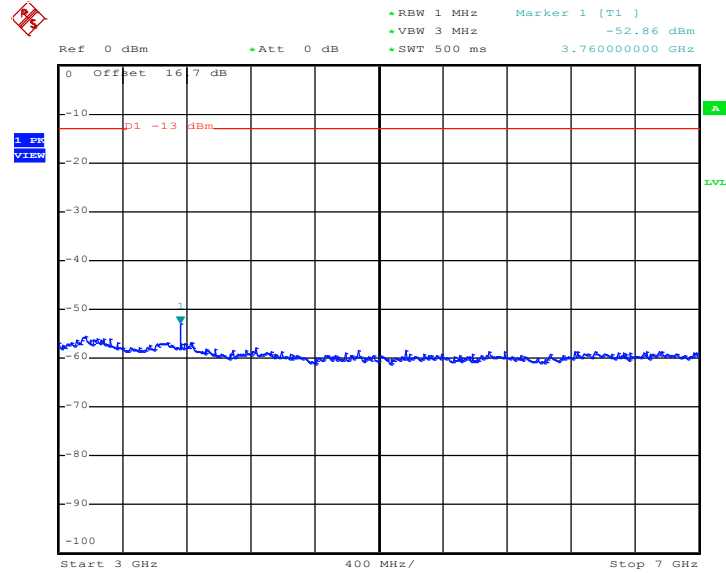

Date: 6.DEC.2011 19:19:18

Conducted Emission Plot between 7GHz ~ 13.6GHz

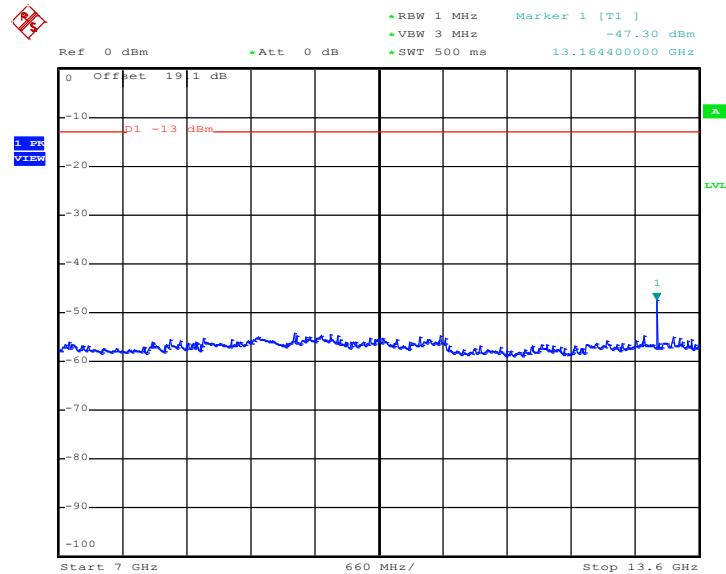

Date: 6.DEC.2011 19:21:09



Conducted Emission Plot between 13.6GHz ~ 19.1GHz

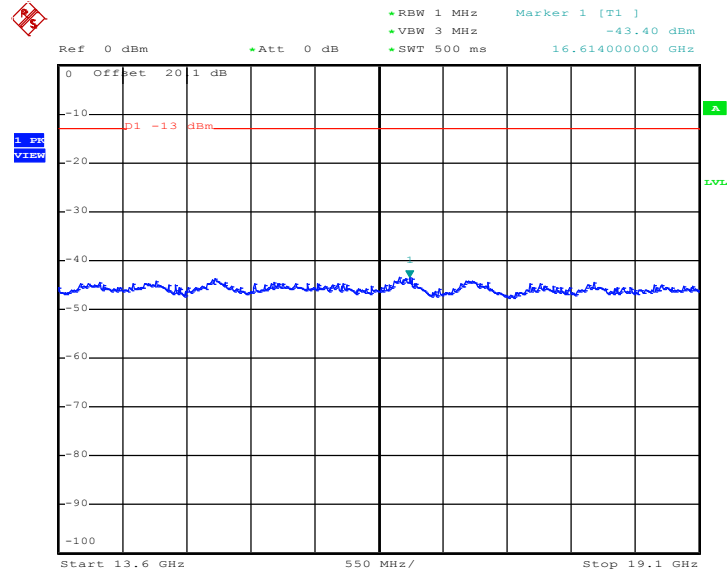

Date: 6.DEC.2011 19:22:55



3.6 Field Strength of Spurious Radiation Measurement

3.6.1 Description of Field Strength of Spurious Radiated Measurement

The radiated spurious emission was measured by substitution method according to ANSI / TIA / EIA-603-C-2004. The power of any emission outside of the authorized operating frequency ranges must be attenuated below the transmitter power (P) by a factor of at least $43 + 10 \log (P)$ dB. The spectrum is scanned from 30 MHz up to a frequency including its 10th harmonic.

3.6.2 Measuring Instruments

See list of measuring instruments of this test report.

3.6.3 Test Procedures

4. The EUT was placed on a rotatable wooden table with 0.8 meter about ground.
5. The EUT was set 3 meters from the receiving antenna, which was mounted on the antenna tower.
6. The table was rotated 360 degrees to determine the position of the highest spurious emission.
7. The height of the receiving antenna is varied between one meter and four meters to search the maximum spurious emission for both horizontal and vertical polarizations.
8. Make the measurement with the spectrum analyzer's RBW = 1MHz, VBW = 3MHz, Sweep = 500ms, Taking the record of maximum spurious emission.
9. A horn antenna was substituted in place of the EUT and was driven by a signal generator.
10. Tune the output power of signal generator to the same emission level with EUT maximum spurious emission.
11. Taking the record of output power at antenna port.
12. Repeat step 7 to step 8 for another polarization.
13. $EIRP (dBm) = S.G. Power - Tx Cable Loss + Tx Antenna Gain$
14. $ERP (dBm) = EIRP - 2.15$

3.6.4 Test Setup

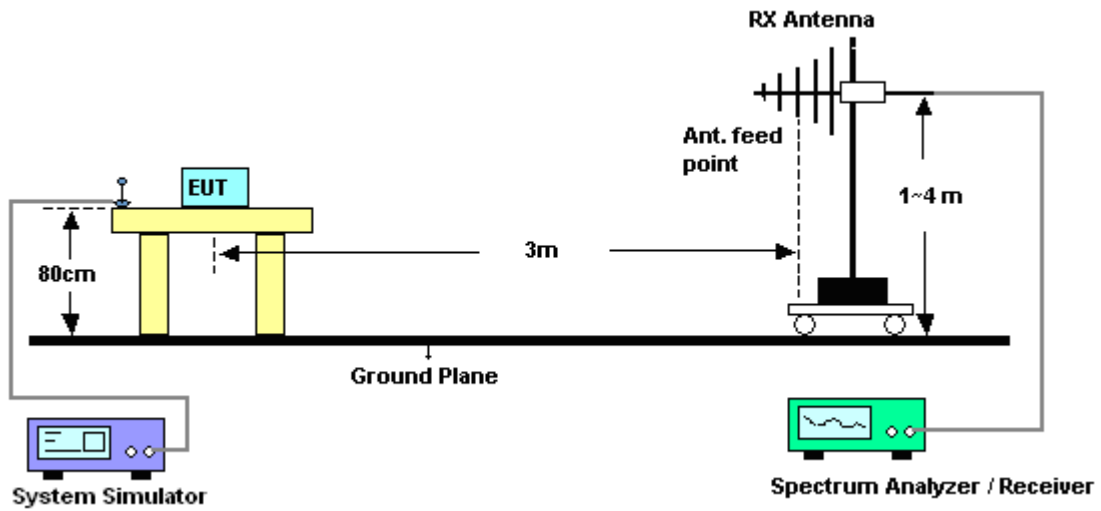



3.6.5 Test Result of Field Strength of Spurious Radiated

Band :	GSM850	Temperature :	20~21°C
Test Mode :	GPRS 8 Link	Relative Humidity :	41~43%
Test Engineer :	Jack Li	Polarization :	Horizontal
Remark :	Spurious emissions within 30-1000MHz were found more than 20dB below limit line.		

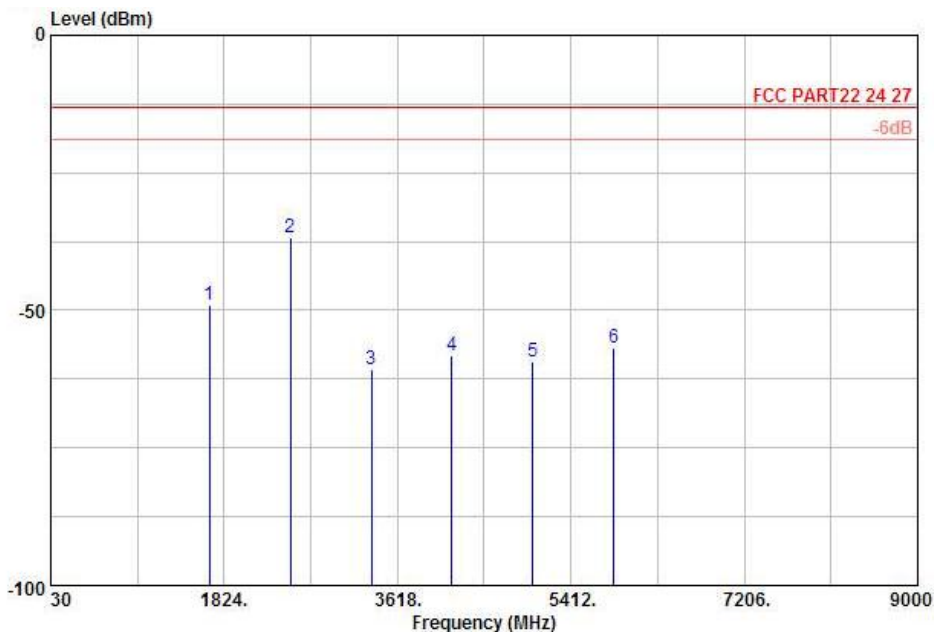

Site : 03CH01-KS
 Condition: FCC PART22 24 27 HF EIRP FACTOR-09020 HORIZONTAL

Plan : H

Frequency (MHz)	ERP (dBm)	Limit (dBm)	Over Limit (dB)	SPA Reading (dBm)	S.G. Power (dBm)	TX Cable loss (dB)	TX Antenna Gain (dBi)	Polarization (H/V)	Result
1672	-49.00	-13	-36.00	-48.00	-49.65	0.57	3.37	H	Pass
2510	-36.86	-13	-23.86	-41.37	-39.09	0.78	5.16	H	Pass
3345	-60.81	-13	-47.81	-62.75	-64.45	0.87	6.66	H	Pass
4182	-58.25	-13	-45.25	-60.99	-62.84	0.97	7.71	H	Pass
5018	-59.28	-13	-46.28	-65.48	-64.95	1.09	8.91	H	Pass
5854	-56.79	-13	-43.79	-65.50	-63.23	1.22	9.81	H	Pass



Band :	GSM850	Temperature :	20~21°C
Test Mode :	GPRS 8 Link	Relative Humidity :	41~43%
Test Engineer :	Jack Li	Polarization :	Vertical
Remark :	Spurious emissions within 30-1000MHz were found more than 20dB below limit line.		

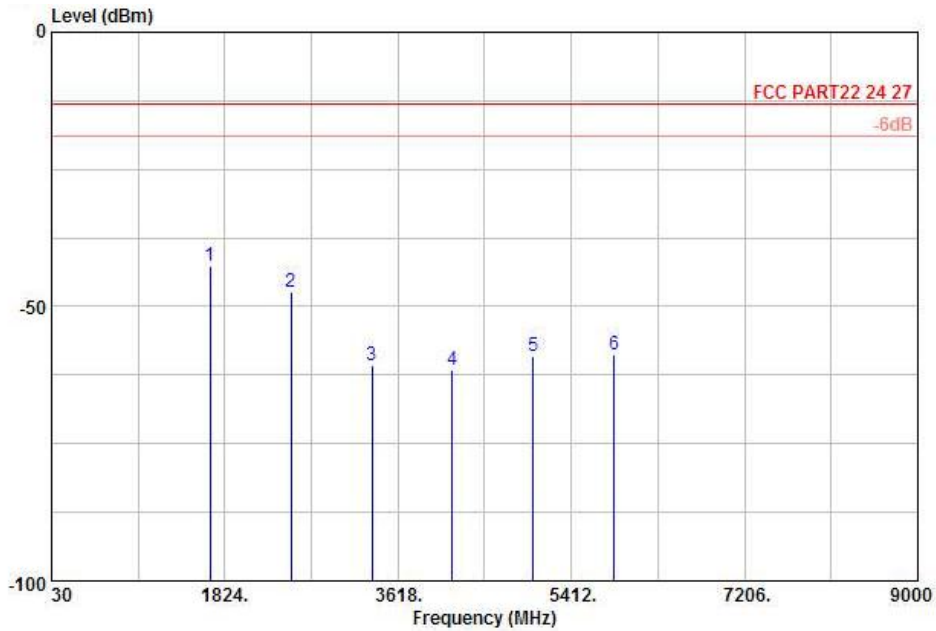

Site : 03CH01-KS
 Condition: FCC PART22 24 27 HF EIRP FACTOR-09020 VERTICAL

Plan : H

Frequency (MHz)	ERP (dBm)	Limit (dBm)	Over Limit (dB)	SPA Reading (dBm)	S.G. Power (dBm)	TX Cable loss (dB)	TX Antenna Gain (dBi)	Polarization (H/V)	Result
1672	-42.65	-13	-29.65	-46.65	-43.30	0.57	3.37	V	Pass
2510	-47.36	-13	-34.36	-51.48	-49.59	0.78	5.16	V	Pass
3345	-60.72	-13	-47.72	-62.70	-64.36	0.87	6.66	V	Pass
4182	-61.44	-13	-48.44	-65.28	-66.03	0.97	7.71	V	Pass
5018	-58.98	-13	-45.98	-63.92	-64.65	1.09	8.91	V	Pass
5854	-58.65	-13	-45.65	-66.64	-65.09	1.22	9.81	V	Pass



Band :	GSM850	Temperature :	20~21°C
Test Mode :	EDGE 8 Link	Relative Humidity :	41~43%
Test Engineer :	Jack Li	Polarization :	Horizontal
Remark :	Spurious emissions within 30-1000MHz were found more than 20dB below limit line.		

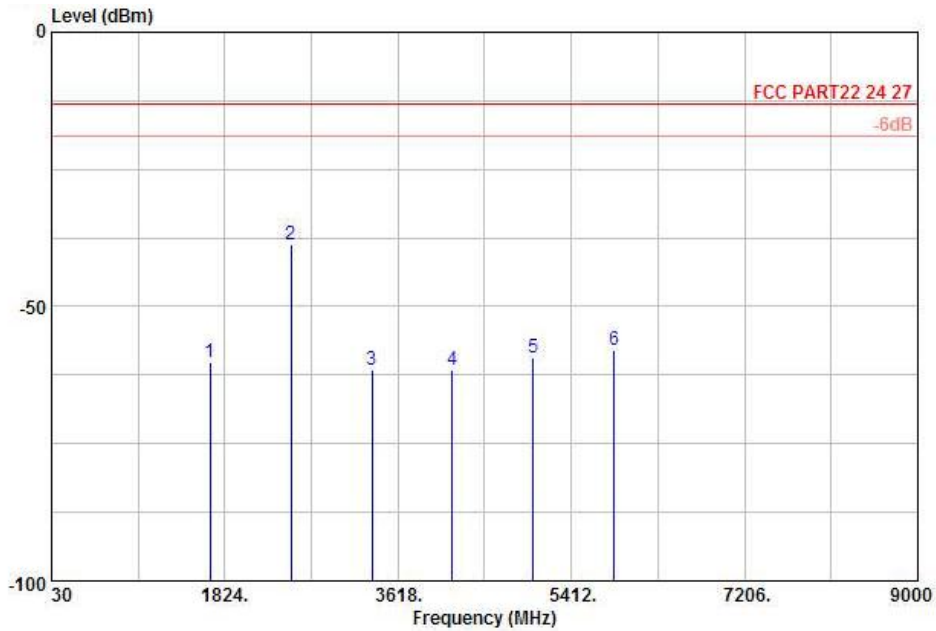

Site : 03CH01-KS
 Condition: FCC PART22 24 27 HF EIRP FACTOR-09020 HORIZONTAL
 Plan : H

Frequency (MHz)	ERP (dBm)	Limit (dBm)	Over Limit (dB)	SPA Reading (dBm)	S.G. Power (dBm)	TX Cable loss (dB)	TX Antenna Gain (dBi)	Polarization (H/V)	Result
1672	-60.10	-13	-47.10	-55.88	-60.75	0.57	3.37	H	Pass
2510	-38.82	-13	-25.82	-43.18	-41.05	0.78	5.16	H	Pass
3345	-61.47	-13	-48.47	-63.41	-65.11	0.87	6.66	H	Pass
4182	-61.67	-13	-48.67	-64.41	-66.26	0.97	7.71	H	Pass
5018	-59.43	-13	-46.43	-65.63	-65.10	1.09	8.91	H	Pass
5854	-57.92	-13	-44.92	-66.63	-64.36	1.22	9.81	H	Pass



Band :	GSM850	Temperature :	20~21°C
Test Mode :	EDGE 8 Link	Relative Humidity :	41~43%
Test Engineer :	Jack Li	Polarization :	Vertical
Remark :	Spurious emissions within 30-1000MHz were found more than 20dB below limit line.		

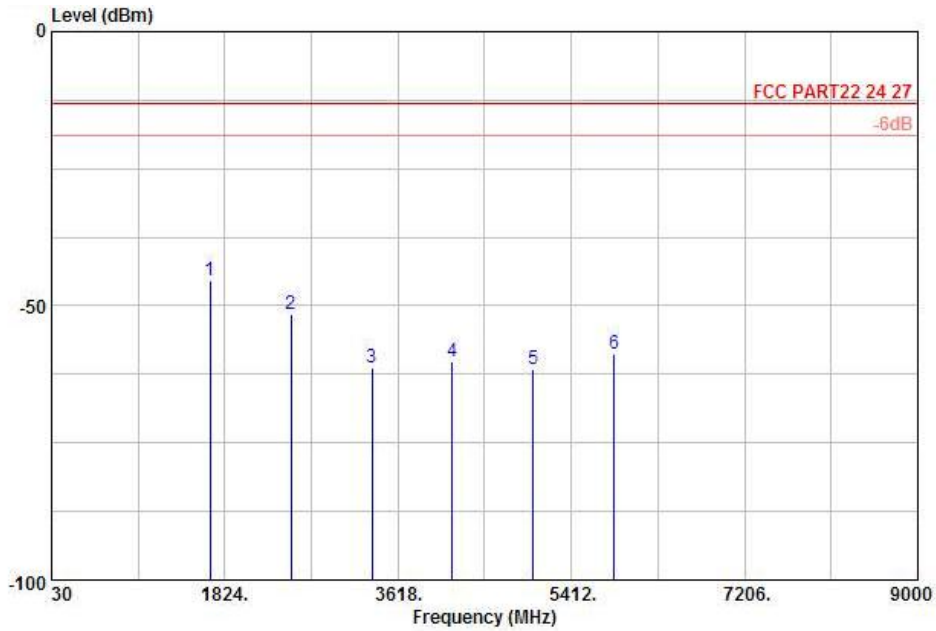

Site : 03CH01-KS
 Condition: FCC PART22 24 27 HF EIRP FACTOR-09020 VERTICAL
 Plan : H

Frequency (MHz)	ERP (dBm)	Limit (dBm)	Over Limit (dB)	SPA Reading (dBm)	S.G. Power (dBm)	TX Cable loss (dB)	TX Antenna Gain (dBi)	Polarization (H/V)	Result
1672	-45.50	-13	-32.50	-49.22	-46.15	0.57	3.37	V	Pass
2510	-51.56	-13	-38.56	-54.67	-53.79	0.78	5.16	V	Pass
3345	-61.19	-13	-48.19	-63.17	-64.83	0.87	6.66	V	Pass
4182	-60.27	-13	-47.27	-64.11	-64.86	0.97	7.71	V	Pass
5018	-61.45	-13	-48.45	-66.39	-67.12	1.09	8.91	V	Pass
5854	-58.74	-13	-45.74	-66.73	-65.18	1.22	9.81	V	Pass



Band :	GSM1900	Temperature :	20~21°C
Test Mode :	GPRS 8 Link	Relative Humidity :	41~43%
Test Engineer :	Jack Li	Polarization :	Horizontal
Remark :	Spurious emissions within 30-1000MHz were found more than 20dB below limit line.		

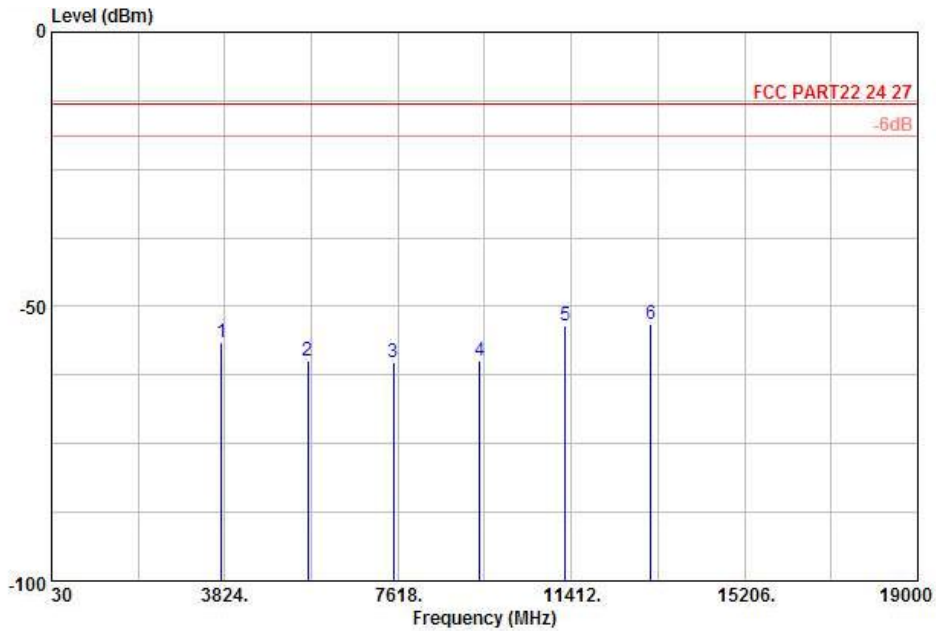

Site : 03CH01-KS
 Condition: FCC PART22 24 27 HF EIRP FACTOR-09020 HORIZONTAL
 Plan : E2

Frequency (MHz)	EIRP (dBm)	Limit (dBm)	Over Limit (dB)	SPA Reading (dBm)	S.G. Power (dBm)	TX Cable loss (dB)	TX Antenna Gain (dBi)	Polarization (H/V)	Result
3760	-56.54	-13	-43.54	-57.51	-62.92	0.78	7.16	H	Pass
5640	-59.82	-13	-46.82	-64.00	-68.36	1.04	9.58	H	Pass
7520	-60.19	-13	-47.19	-65.32	-70.30	1.35	11.46	H	Pass
9400	-59.86	-13	-46.86	-63.12	-70.92	1.75	12.81	H	Pass
11280	-53.43	-13	-40.43	-64.92	-64.52	2	13.09	H	Pass
13160	-53.17	-13	-40.17	-64.47	-64.88	2.04	13.75	H	Pass



Band :	GSM1900	Temperature :	20~21°C
Test Mode :	GPRS 8 Link	Relative Humidity :	41~43%
Test Engineer :	Jack Li	Polarization :	Vertical
Remark :	Spurious emissions within 30-1000MHz were found more than 20dB below limit line.		

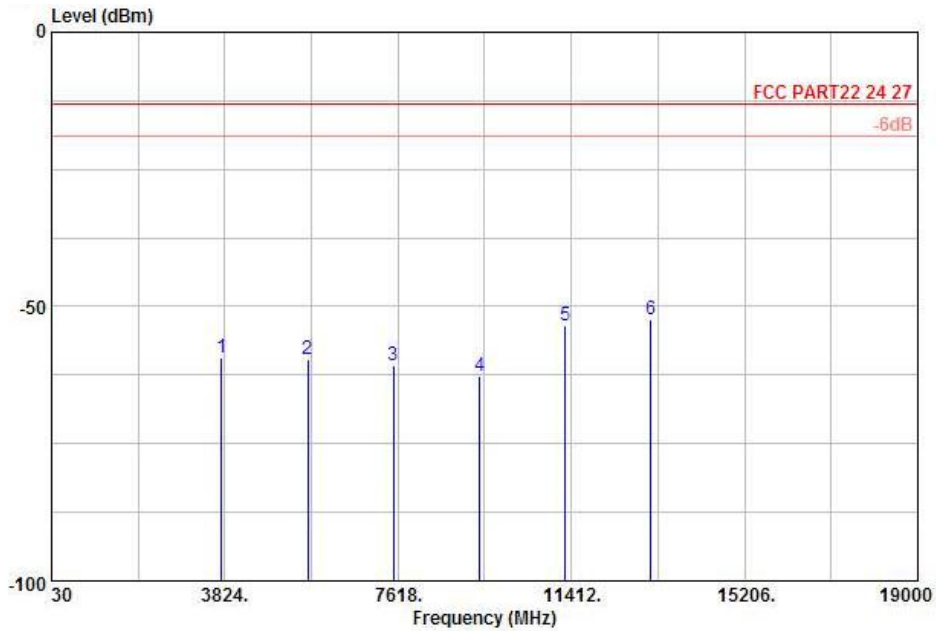

Site : 03CH01-KS
 Condition: FCC PART22 24 27 HF EIRP FACTOR-09020 VERTICAL

Plan : E2

Frequency (MHz)	EIRP (dBm)	Limit (dBm)	Over Limit (dB)	SPA Reading (dBm)	S.G. Power (dBm)	TX Cable loss (dB)	TX Antenna Gain (dBi)	Polarization (H/V)	Result
3760	-59.27	-13	-46.27	-60.64	-65.65	0.78	7.16	V	Pass
5640	-59.52	-13	-46.52	-62.74	-68.06	1.04	9.58	V	Pass
7520	-60.74	-13	-47.74	-65.23	-70.85	1.35	11.46	V	Pass
9400	-62.75	-13	-49.75	-63.97	-73.81	1.75	12.81	V	Pass
11280	-53.35	-13	-40.35	-64.59	-64.44	2	13.09	V	Pass
13160	-52.23	-13	-39.23	-63.42	-63.94	2.04	13.75	V	Pass



Band :	GSM1900	Temperature :	20~21°C
Test Mode :	EDGE 8 Link	Relative Humidity :	41~43%
Test Engineer :	Jack Li	Polarization :	Horizontal
Remark :	Spurious emissions within 30-1000MHz were found more than 20dB below limit line.		

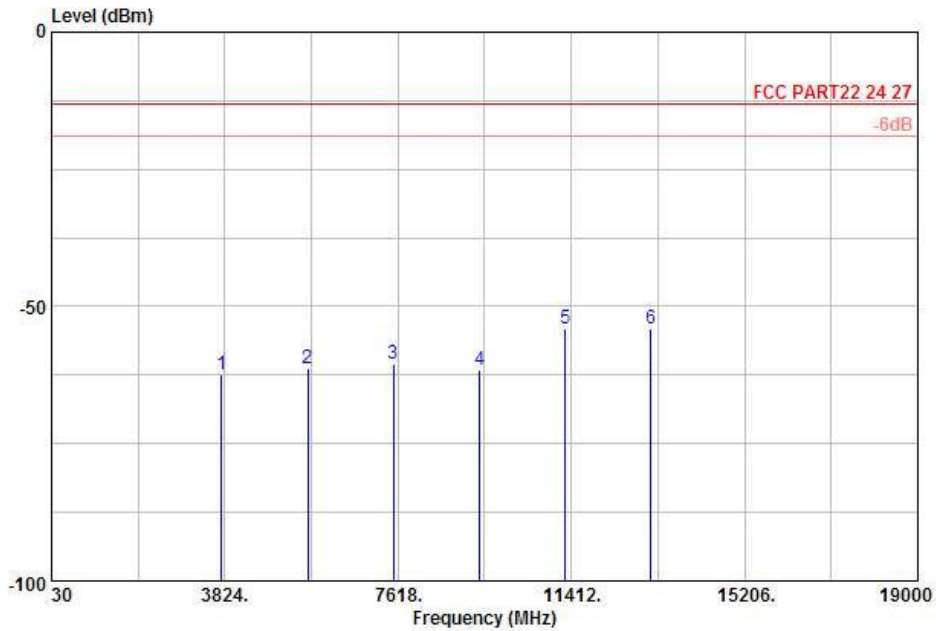

Site : 03CH01-KS
 Condition: FCC PART22 24 27 HF EIRP FACTOR-09020 HORIZONTAL
 Plan : E2

Frequency (MHz)	EIRP (dBm)	Limit (dBm)	Over Limit (dB)	SPA Reading (dBm)	S.G. Power (dBm)	TX Cable loss (dB)	TX Antenna Gain (dBi)	Polarization (H/V)	Result
3760	-62.46	-13	-49.46	-63.43	-68.84	0.78	7.16	H	Pass
5640	-61.38	-13	-48.38	-65.56	-69.92	1.04	9.58	H	Pass
7520	-60.57	-13	-47.57	-65.70	-70.68	1.35	11.46	H	Pass
9400	-61.57	-13	-48.57	-64.83	-72.63	1.75	12.81	H	Pass
11280	-54.08	-13	-41.08	-65.57	-65.17	2	13.09	H	Pass
13160	-54.01	-13	-41.01	-65.31	-65.72	2.04	13.75	H	Pass



Band :	GSM1900	Temperature :	20~21°C
Test Mode :	EDGE 8 Link	Relative Humidity :	41~43%
Test Engineer :	Jack Li	Polarization :	Vertical
Remark :	Spurious emissions within 30-1000MHz were found more than 20dB below limit line.		

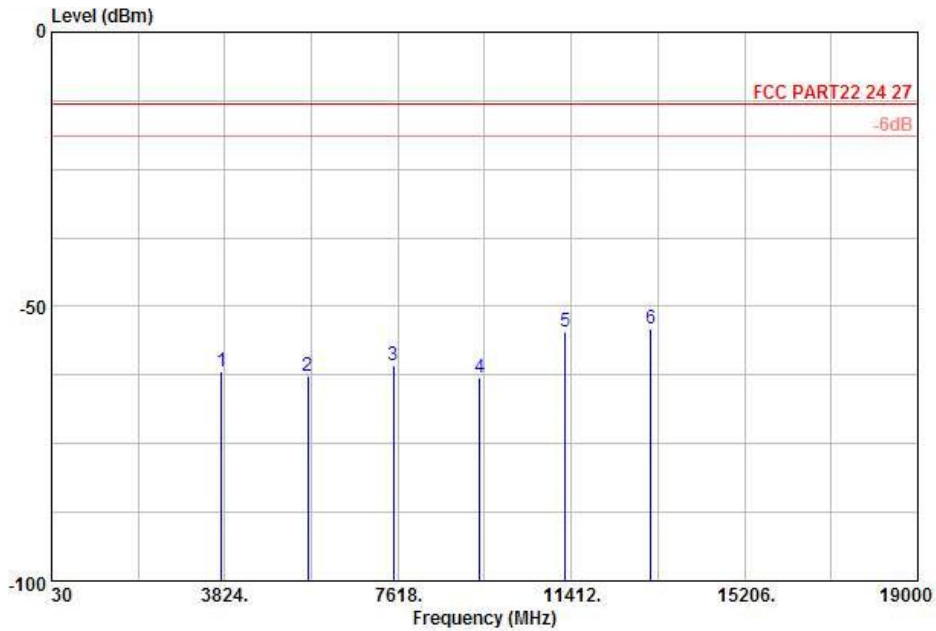

Site : 03CH01-KS
 Condition: FCC PART22 24 27 HF EIRP FACTOR-09020 VERTICAL

Plan : E2

Frequency (MHz)	EIRP (dBm)	Limit (dBm)	Over Limit (dB)	SPA Reading (dBm)	S.G. Power (dBm)	TX Cable loss (dB)	TX Antenna Gain (dBi)	Polarization (H/V)	Result
3760	-61.71	-13	-48.71	-63.08	-68.09	0.78	7.16	V	Pass
5640	-62.79	-13	-49.79	-66.01	-71.33	1.04	9.58	V	Pass
7520	-60.86	-13	-47.86	-65.35	-70.97	1.35	11.46	V	Pass
9400	-63.05	-13	-50.05	-64.27	-74.11	1.75	12.81	V	Pass
11280	-54.66	-13	-41.66	-65.9	-65.75	2	13.09	V	Pass
13160	-53.92	-13	-40.92	-65.11	-65.63	2.04	13.75	V	Pass

3.7 Frequency Stability Measurement

3.7.1 Description of Frequency Stability Measurement

The frequency stability shall be measured by variation of ambient temperature and variation of primary supply voltage to ensure that the fundamental emission stays within the authorized frequency block. The frequency stability of the transmitter shall be maintained within $\pm 0.00025\%$ ($\pm 2.5\text{ppm}$) of the center frequency.

3.7.2 Measuring Instruments

See list of measuring instruments of this test report.

3.7.3 Test Procedures for Temperature Variation

1. The EUT was set up in the thermal chamber and connected with the base station.
2. With power OFF, the temperature was decreased to -30°C and the EUT was stabilized for three hours. Power was applied and the maximum change in frequency was recorded within one minute.
3. With power OFF, the temperature was raised in 10°C step up to 50°C . The EUT was stabilized at each step for at least half an hour. Power was applied and the maximum frequency change was recorded within one minute.
4. If the EUT cannot be turned on at -30°C , the testing lowest temperature will be raised in 10°C step until the EUT can be turned on.

3.7.4 Test Procedures for Voltage Variation

1. The EUT was placed in a temperature chamber at $25\pm 5^{\circ}\text{C}$ and connected with the base station.
2. The power supply voltage to the EUT was varied from BEP to 115% of the nominal value measured at the input to the EUT.
3. The variation in frequency was measured for the worst case.

3.7.5 Test Setup

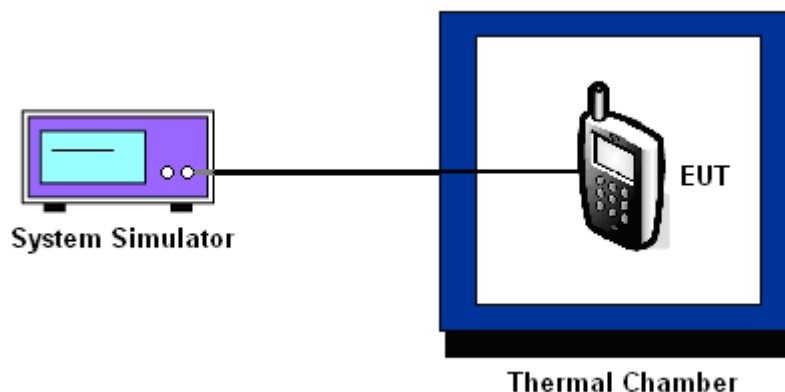

3.7.6 Test Result of Temperature Variation

Band :	GSM 850		Channel :	189	
Limit (ppm) :	2.5				
Temperature (°C)	GPRS 8		EDGE 8		Result
	Freq. Dev. (Hz)	Deviation (ppm)	Freq. Dev. (Hz)	Deviation (ppm)	
-30	N/A	N/A	N/A	N/A	PASS
-20	N/A	N/A	N/A	N/A	
-15	-35	-0.04	25	0.03	
-10	-24	-0.03	-24	-0.03	
0	-28	-0.03	-30	-0.04	
10	-33	-0.04	-38	-0.04	
20	-16	-0.02	-66	-0.08	
30	-23	-0.03	-47	-0.06	
40	-28	-0.03	-40	-0.05	
50	-35	-0.04	-26	-0.03	
55	-52	-0.06	-46	-0.05	

Note: The manufacturer declared that the EUT could work properly between temperatures -15°C~55°C.



Band :	GSM 1900	Channel :	661
Limit (ppm) :	2.5		

Temperature (°C)	GPRS 8		EDGE 8		Result
	Freq. Dev. (Hz)	Deviation (ppm)	Freq. Dev. (Hz)	Deviation (ppm)	
-30	N/A	N/A	N/A	N/A	PASS
-20	N/A	N/A	N/A	N/A	
-15	-60	-0.03	-54	-0.03	
-10	-47	-0.02	-65	-0.03	
0	-58	-0.03	-39	-0.02	
10	-53	-0.03	-73	-0.04	
20	-37	-0.02	-79	-0.04	
30	-45	-0.02	-85	-0.04	
40	-39	-0.02	-73	-0.04	
50	-51	-0.03	-25	-0.01	
55	-78	-0.04	-40	-0.02	

Note: The manufacturer declared that the EUT could work properly between temperatures -15°C~55°C.

3.7.7 Test Result of Voltage Variation

Band & Channel	Mode	Voltage (Volt)	Freq. Dev. (Hz)	Deviation (ppm)	Limit (ppm)	Result
GSM 850 CH189	GPRS 8	3.8	-42	-0.05	2.5	PASS
		BEP	-34	-0.04		
		4.2	-37	-0.04		
	EDGE 8	3.8	-31	-0.04		
		BEP	-31	-0.04		
		4.2	-27	-0.03		
GSM 1900 CH661	GPRS 8	3.8	-73	-0.04		
		BEP	-65	-0.03		
		4.2	-72	-0.04		
	EDGE 8	3.8	-58	-0.03		
		BEP	-49	-0.03		
		4.2	-56	-0.03		

Note:

1. Normal Voltage = 3.8V.
2. Battery End Point (BEP) = 3.5 V.



4 List of Measuring Equipment

Instrument	Manufacturer	Model No.	Serial No.	Characteristics	Calibration Date	Test Date	Due Date	Remark
Spectrum Analyzer	R&S	FSP40	100319	9kHz~40GHz	Jan. 07, 2011	Dec. 06, 2011~ Dec. 24, 2011	Jan. 06, 2012	Conducted (TH01-KS)
Power Meter	Agilent	E4416A	MY45101555	N/A	Aug. 23, 2011	Dec. 06, 2011~ Dec. 24, 2011	Aug. 22, 2012	Conducted (TH01-KS)
Power Sensor	Agilent	E9327A	MY44421198	N/A	Aug. 23, 2011	Dec. 06, 2011~ Dec. 24, 2011	Aug. 22, 2012	Conducted (TH01-KS)
Thermal Chamber	Ten Billion	TTC-B3S	TBN-960502	N/A	Jan. 17, 2011	Dec. 06, 2011~ Dec. 24, 2011	Jan. 16, 2012	Conducted (TH01-KS)
DC Power Supply	TOPWARD	GPS-3030D	E1884515	N/A	Aug. 23, 2011	Dec. 06, 2011~ Dec. 24, 2011	Aug. 22, 2012	Conducted (TH01-KS)
EMI Test Receiver	R&S	ESCI	100534	9kHz~3GHz	Nov. 09, 2011	Dec. 03, 2011~ Dec. 06, 2011	Nov. 08, 2012	Radiation (03CH01-KS)
Spectrum Analyzer	R&S	FSP40	100319	9kHz~40GHz	Jan. 07, 2011	Dec. 03, 2011~ Dec. 06, 2011	Jan. 06, 2012	Radiation (03CH01-KS)
Spectrum Analyzer	R&S	FSP30	101400	9kHz~30GHz	Jun. 02, 2011	Dec. 03, 2011~ Dec. 06, 2011	Jun. 01, 2012	Radiation (03CH01-KS)
Bilog Antenna	SCHAFFNER	CBL6112D	23182	25MHz~2GHz	Dec. 10, 2010	Dec. 03, 2011~ Dec. 06, 2011	Dec. 09, 2011	Radiation (03CH01-KS)
Double Ridge Horn Antenna	EMCO	3117	00075959	1GHz~18GHz	Jan. 07, 2011	Dec. 03, 2011~ Dec. 06, 2011	Jan. 06, 2012	Radiation (03CH01-KS)
Amplifier	Wireless	FPA-6592G	060029	9KHz~2GHz	Jan. 10, 2011	Dec. 03, 2011~ Dec. 06, 2011	Jan. 09, 2012	Radiation (03CH01-KS)
Amplifier	Agilent	8449B	3008A02370	1GHz~26.5GHz	Jan. 07, 2011	Dec. 03, 2011~ Dec. 06, 2011	Jan. 06, 2012	Radiation (03CH01-KS)
Active Horn Antenna	com-power	AHA-118	701023	1G-18GHz	Nov. 07, 2011	Dec. 03, 2011~ Dec. 06, 2011	Nov. 06, 2012	Radiation (03CH01-KS)
SHF-EHF Horn	Schwarzbeck	BBHA 9170	BBHA170249	15-40GHz	Oct. 11, 2011	Dec. 03, 2011~ Dec. 06, 2011	Oct. 10, 2012	Radiation (03CH01-KS)
System Simulator	R&S	CMU200	837587/066	Full-Band	Jan. 07, 2011	Dec. 03, 2011~ Dec. 24, 2011	Jan. 06, 2012	-

5 Uncertainty of Evaluation

Uncertainty of Radiated Emission Measurement (30 MHz ~ 1000 MHz)

Contribution	Uncertainty of X_i		$u(X_i)$
	dB	Probability Distribution	
Receiver Reading	0.41	Normal (k=2)	0.21
Antenna Factor Calibration	0.83	Normal (k=2)	0.42
Cable Loss Calibration	0.25	Normal (k=2)	0.13
Pre-Amplifier Gain Calibration	0.27	Normal (k=2)	0.14
RCV/SPA Specification	2.50	Rectangular	0.72
Antenna Factor Interpolation for Frequency	1.00	Rectangular	0.29
Site Imperfection	1.43	Rectangular	0.83
Mismatch	+0.39 / -0.41	U-Shape	0.28
Combined Standard Uncertainty $U_c(y)$	1.27		
Measuring Uncertainty for a Level of Confidence of 95% ($U = 2U_c(y)$)	2.54		

Uncertainty of Radiated Emission Measurement (1 GHz ~ 40 GHz)

Contribution	Uncertainty of X_i		$u(X_i)$	C_i	$C_i * u(X_i)$
	dB	Probability Distribution			
Receiver Reading	± 0.10	Normal (k=2)	0.10	1	0.10
Antenna Factor Calibration	± 1.70	Normal (k=2)	0.85	1	0.85
Cable Loss Calibration	± 0.50	Normal (k=2)	0.25	1	0.25
Receiver Correction	± 2.00	Rectangular	1.15	1	1.15
Antenna Factor Directional	± 1.50	Rectangular	0.87	1	0.87
Site Imperfection	± 2.80	Triangular	1.14	1	1.14
Mismatch Receiver VSWR $\Gamma_1 = 0.197$ Antenna VSWR $\Gamma_2 = 0.194$ Uncertainty = $20\text{Log}(1-\Gamma_1*\Gamma_2)$	+0.34 / -0.35	U-Shape	0.244	1	0.244
Combined Standard Uncertainty $U_c(y)$	2.36				
Measuring Uncertainty for a Level of Confidence of 95% ($U = 2U_c(y)$)	4.72				