

FCC Test Report

APPLICANT : Motorola Mobility Inc.
EQUIPMENT : Quad-Band GSM/GPRS/EDGE and Dual-Band
WCDMA Mobile Phone with BT/Wifi
BRAND NAME : Motorola
MODEL NAME : XT320
MARKETING NAME : MOTOROLA DEFY MINI
TYPE NAME : M0C5A
GPPD NUMBER : 3162
FCC ID : IHDP56MK2
STANDARD : FCC 47 CFR FCC Part 15 Subpart B
CLASSIFICATION : Certification

The product was received on Dec. 02, 2011 and completely tested on Dec. 29, 2011. We, SPORTON INTERNATIONAL INC., would like to declare that the tested sample has been evaluated in accordance with the procedures given in ANSI C63.4-2003 and shown the compliance with the applicable technical standards.

The test results in this report apply exclusively to the tested model / sample. Without written approval of SPORTON INTERNATIONAL INC., the test report shall not be reproduced except in full.

Reviewed by:



Jones Tsai / Manager



SPORTON INTERNATIONAL INC.

No. 52, Hwa Ya 1st Rd., Hwa Ya Technology Park, Kwei-Shan Hsiang, Tao Yuan Hsien, Taiwan, R.O.C.



TABLE OF CONTENTS

REVISION HISTORY 3

SUMMARY OF TEST RESULT 4

1. GENERAL DESCRIPTION 5

 1.1. Applicant..... 5

 1.2. Manufacturer 5

 1.3. Feature of Equipment Under Test..... 6

 1.4. Test Site 7

 1.5. Applied Standards 7

 1.6. Ancillary Equipment List..... 7

2. TEST CONFIGURATION OF EQUIPMENT UNDER TEST 8

 2.1. Test Mode 8

 2.2. Connection Diagram of Test System 10

 2.3. Test Software 11

3. TEST RESULT 12

 3.1. Test of AC Conducted Emission Measurement 12

 3.2. Test of Radiated Emission Measurement 16

4. LIST OF MEASURING EQUIPMENT 21

5. UNCERTAINTY OF EVALUATION 22



SUMMARY OF TEST RESULT

Report Section	FCC Rule	IC Rule	Description	Limit	Result	Remark
3.1	15.107	7.2.4	AC Conducted Emission	< 15.107 limits < RSS-Gen table 2 limits	PASS	Under limit 6.28 dB at 2.030 MHz
3.2	15.109	7.2.3.2	Radiated Emission	< 15.109 limits or < RSS-Gen table 1 limits (Section 6)	PASS	Under limit 7.70 dB at 824.300 MHz



1. General Description

1.1. Applicant

Motorola Mobility Inc.

No. 1, Wang Jing East Road, Chao Yang District, 100102 Beijing, P. R. China

1.2. Manufacturer

Gongqingcheng Cellon Communication Technology Co., LTD.

New industrial park, GongQingCheng, Jiujiang city, Jiangxi Province, China. Postal code : 332020

1.3. Feature of Equipment Under Test

Product Feature & Specification	
Equipment	Quad-Band GSM/GPRS/EDGE and Dual-Band WCDMA Mobile Phone with BT/Wifi
Brand Name	Motorola
Model Name	XT320
Type Name	M0C5A
FCC ID	IHDP56MK2
Tx Frequency Range	GSM850 : 824 MHz ~ 849 MHz GSM1900 : 1850 MHz ~ 1910 MHz WCDMA Band V : 824 MHz ~ 849 MHz WCDMA Band II : 1850 MHz ~ 1910 MHz Bluetooth : 2400 MHz ~ 2483.5 MHz WLAN : 2400 MHz ~ 2483.5 MHz
Rx Frequency Range	GSM850 : 869 MHz ~ 894 MHz GSM1900 : 1930 MHz ~ 1990 MHz WCDMA Band V : 869 MHz ~ 894 MHz WCDMA Band II : 1930 MHz ~ 1990 MHz Bluetooth : 2400 MHz ~ 2483.5 MHz WLAN : 2400 MHz ~ 2483.5 MHz GPS : 1.57542 GHz
Antenna Type	WWAN : Fixed Internal Antenna WLAN/Bluetooth : PIFA Antenna
HW Version	B3
SW Version	TNBST_4_0A.12.10.RDD
Type of Modulation	GSM: GMSK GPRS: GMSK EDGE: GMSK / 8PSK WCDMA: QPSK (Uplink) HSDPA: QPSK (Uplink) Bluetooth (1Mbps) : GFSK Bluetooth EDR (2Mbps) : $\pi/4$ -DQPSK Bluetooth EDR (3Mbps) : 8-DPSK 802.11b : DSSS (BPSK / QPSK / CCK) 802.11g/n : OFDM (BPSK / QPSK / 16QAM / 64QAM) GPS : BPSK
EUT Stage	Production Unit

Remark: The above EUT's information was declared by manufacturer. Please refer to the specifications or user's manual for more detailed description.

1.4. Test Site

Test Site	SPORTON INTERNATIONAL (KUNSHAN) INC.		
Test Site Location	No. 3-2, PingXiang Road, Kunshan, Jiangsu Province, P.R.C. TEL: +86-0512-5790-0158 FAX: +86-0512-5790-0958		
Test Site No.	Sporton Site No.		FCC/IC Registration No.
	CO01-KS	03CH01-KS	722060/4086B-1

1.5. Applied Standards

According to the specifications of the manufacturer, the EUT must comply with the requirements of the following standards:

- FCC 47 CFR FCC Part 15 Subpart B
- ANSI C63.4-2003
- IC RSS-Gen Issue 3

Remark: All test items were verified and recorded according to the standards and without any deviation during the test.

1.6. Ancillary Equipment List

Item	Equipment	Trade Name	Model Name	FCC ID	Data Cable	Power Cord
1.	System Simulator	R&S	CMU 200	N/A	N/A	Unshielded, 1.8 m
2.	GPS Station	T&E	GS-50	N/A	N/A	Unshielded, 1.8 m
3.	PC	DELL	MT320	FCC DoC	N/A	Unshielded, 1.8 m
4.	Monitor	DELL	E1910Hc	FCC DoC	Shielded, 1.2 m	Unshielded, 1.8 m
5.	(USB)Mouse	DELL	MO56UC	FCC DoC	Shielded, 1.8 m	N/A
6.	(USB)Keyboard	DELL	SK-8115	FCC DoC	Shielded, 1.8 m with core	N/A
7.	Printer	HP	Laser Jet 1018	FCC DoC	Shielded, 1.8 m	Unshielded, 1.8 m
8.	Bluetooth Earphone	Nokia	BH-102	PYAHS-107W	N/A	N/A
9.	Router	D-Link	DIR-855	KA2DIR855A2	N/A	Unshielded, 1.8 m
10.	iPod	Apple	A1199	FCC DoC	Unshielded, 1.2 m	N/A

2. Test Configuration of Equipment Under Test

2.1. Test Mode

The EUT has been associated with peripherals pursuant to ANSI C63.4-2003 and configuration operated in a manner tended to maximize its emission characteristics in a typical application.

Frequency range investigated: conduction (150 kHz to 30 MHz), radiation (30MHz to the 5th harmonic of the highest fundamental frequency or to 40 GHz, whichever is lower).

The EUT uses a USB interface and microprocessor operating 600MHz which is the maximum frequency used.

The following tables are showing the test modes as the worst cases and recorded in this report.

Item	EUT Configuration	Test Condition		
		EMI AC	EMI RE<1G	EMI RE≥1G
1.	Charging Mode (EUT with adapter)	☒	☒	Note 1
2.	Data application transferred mode (EUT with PC)	☒	☒	☒

Abbreviations:

- EMI AC: AC conducted emissions
- EMI RE ≥ 1G: EUT radiated emissions ≥ 1GHz
- EMI RE < 1G: EUT radiated emissions < 1GHz

Note 1: Testing for this mode is not required or not the worst case.

Remark: For signal above 1GHZ, the worst case was test item 2.

Test Items	EUT Configure Mode	Function Type
AC Conducted Emission	1/2	Mode 1 : GSM850 Idle + Bluetooth Idle + WLAN Idle + Camera + Earphone + Adapter Mode 2 : GSM1900 Idle + Bluetooth Idle + WLAN Idle + MPEG4 + Earphone + Adapter Mode 3 : WCDMA Band V Idle + Bluetooth Idle + WLAN Idle + Earphone + GPS Rx + USB Cable (Data Link with PC) Mode 4 : WCDMA Band II Idle + Bluetooth Idle + WLAN Idle + Earphone + GPS Rx + USB Cable (Data Link with PC)
Radiated Emissions < 1GHz	1/2	Mode 1 : GSM850 Idle + Bluetooth Idle + WLAN Idle + Camera + Earphone + Adapter Mode 2 : GSM1900 Idle + Bluetooth Idle + WLAN Idle + MPEG4 + Earphone + Adapter Mode 3 : WCDMA Band V Idle + Bluetooth Idle + WLAN Idle + Earphone + GPS Rx + USB Cable (Data Link with PC) Mode 4 : WCDMA Band II Idle + Bluetooth Idle + WLAN Idle + Earphone + GPS Rx + USB Cable (Data Link with PC)
Radiated Emissions ≥ 1GHz	2	Mode 1 : WCDMA Band V Idle + Bluetooth Idle + WLAN Idle + Earphone + GPS Rx + USB Cable (Data Link with PC)

Remark:

1. The worst case of AC is mode 1; only the test data of this mode was reported.
2. The worst case of RE < 1G is mode 3; only the test data of this mode was reported.
3. Link with PC means data application transferred mode between EUT and PC.

2.2. Connection Diagram of Test System

<EUT with Adapter Mode>

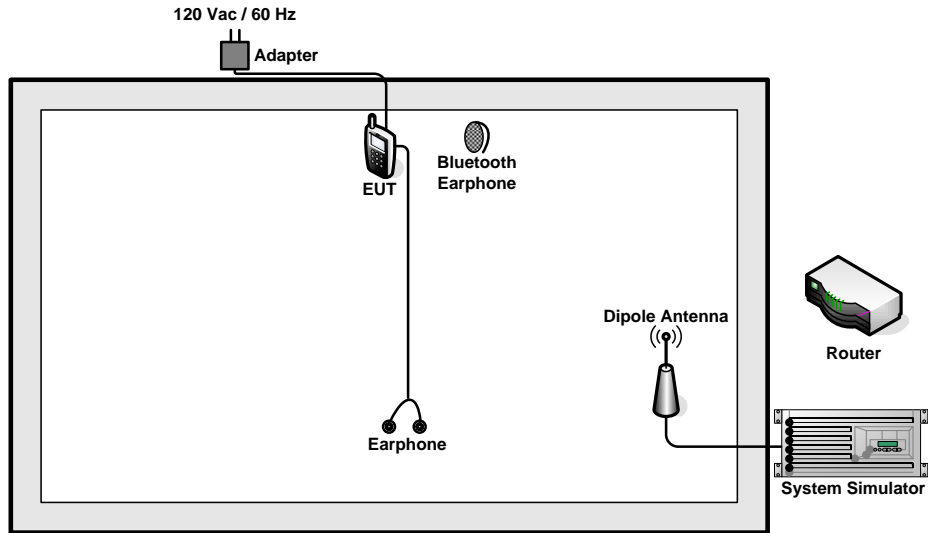

<EUT with USB Cable (Data Link with PC) Mode>

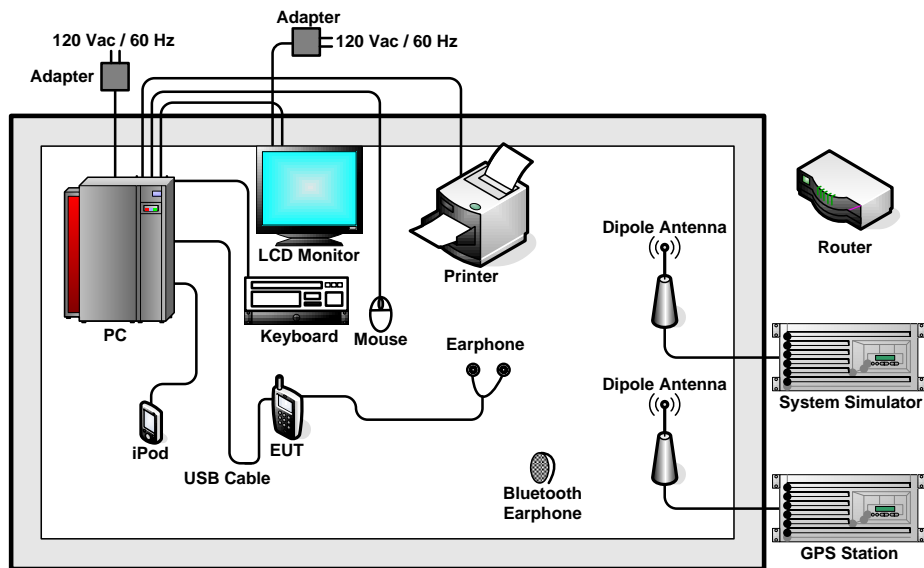



2.3. Test Software

The EUT was in GSM or WCDMA idle mode during the testing. The EUT was synchronized to the BCCH, and is in continuous receiving mode by setting system simulator's paging reorganization.

At the same time, the EUT was attached to the Bluetooth earphone and router the following programs installed in the EUT were programmed during the test.

1. Execute the programs, "Winthrax.exe", installed in PC for active sync files transfer with EUT via USB cable.
2. Receive signals from GPS station continuously.
3. Execute "Video Player" to play MPEG4 files.
4. Turn on camera to capture images.

3. Test Result

3.1. Test of AC Conducted Emission Measurement

3.1.1 Limits of AC Conducted Emission

For equipment that is designed to be connected to the public utility (AC) power line, the radio frequency voltage that is conducted back onto the AC power line on any frequency or frequencies within the band 150 kHz to 30 MHz shall not exceed the limits in the following table.

Frequency of emission (MHz)	Conducted limit (dBuV)	
	Quasi-peak	Average
0.15-0.5	66 to 56*	56 to 46*
0.5-5	56	46
5-30	60	50

*Decreases with the logarithm of the frequency.

3.1.2 Measuring Instruments

See list of measuring instruments of this test report.

3.1.3 Test Procedure

1. The EUT was placed 0.4 meter from the conducting wall of the shielding room was kept at least 80 centimeters from any other grounded conducting surface.
2. Connect EUT to the power mains through a line impedance stabilization network (LISN).
3. All the support units are connecting to the other LISN.
4. The LISN provides 50 ohm coupling impedance for the measuring instrument.
5. The FCC states that a 50 ohm, 50 microhenry LISN should be used.
6. Both sides of AC line were checked for maximum conducted interference.
7. The frequency range from 150 KHz to 30 MHz was searched.
8. Set the test-receiver system to Peak Detect Function and specified bandwidth with Maximum Hold Mode.

3.1.4 Test Setup

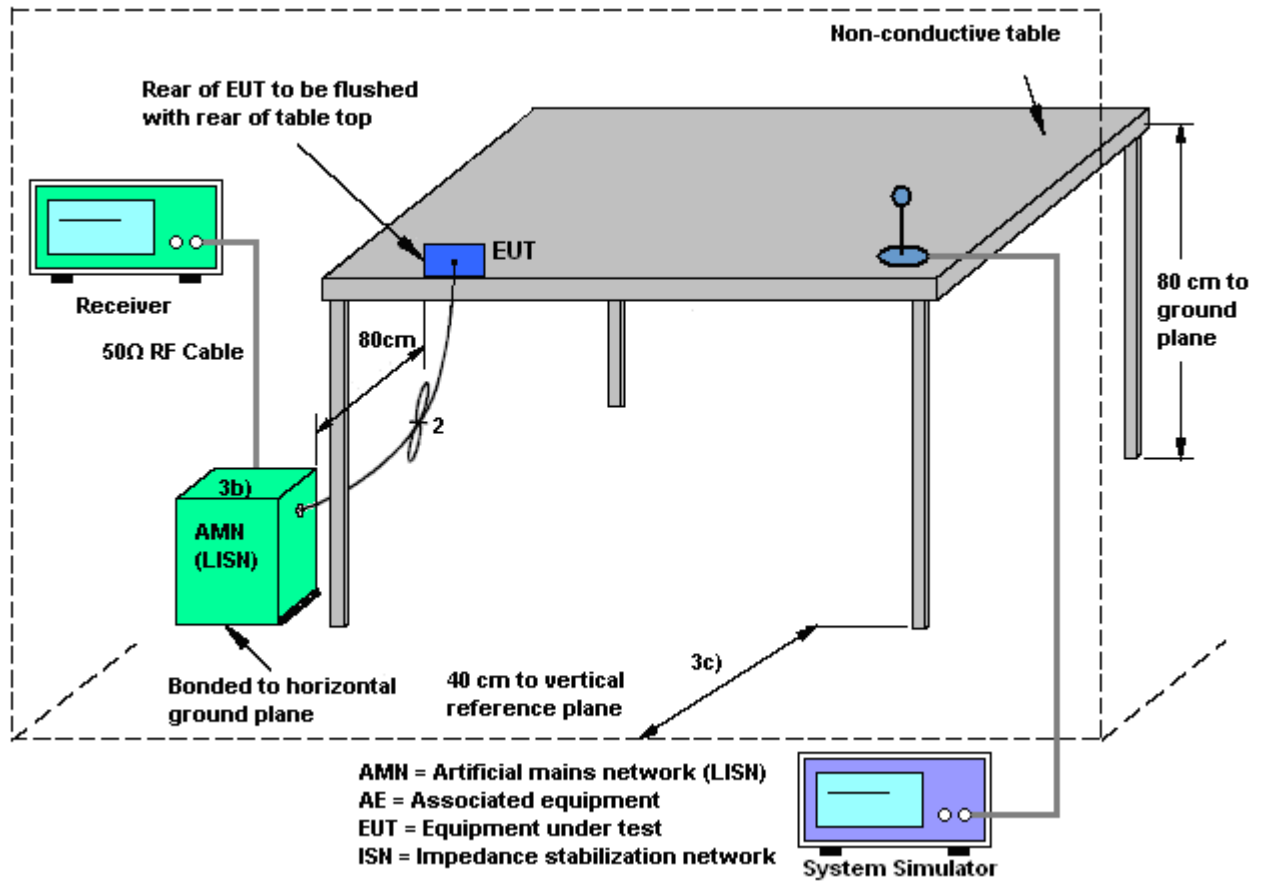



3.1.5 Test Result of AC Conducted Emission

Test Mode :	Mode 1	Temperature :	22~23°C
Test Engineer :	Ming Cheng	Relative Humidity :	45~46%
Test Voltage :	120Vac / 60Hz	Phase :	Line
Function Type :	GSM850 Idle + Bluetooth Idle + WLAN Idle + Camera + Earphone + Adapter		
Remark :	All emissions not reported here are more than 10 dB below the prescribed limit.		

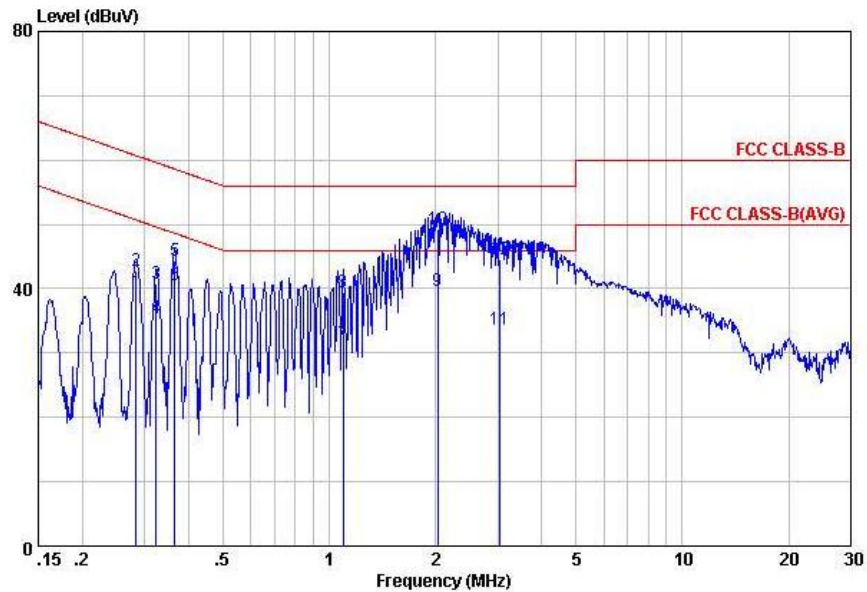

Site : C001-KS
 Condition: FCC CLASS-B LISN-100807 LINE

mode : Mode 1

	Freq	Level	Over Limit	Limit Line	Read Level	LISN Factor	Cable Loss	Remark
	MHz	dBuV	dB	dBuV	dBuV	dB	dB	
1	0.28	39.39	-11.33	50.72	29.29	-0.07	10.17	Average
2	0.28	42.69	-18.03	60.72	32.59	-0.07	10.17	QP
3	0.32	40.80	-18.82	59.62	30.70	-0.08	10.18	QP
4	0.32	35.50	-14.12	49.62	25.40	-0.08	10.18	Average
5	0.37	44.41	-14.20	58.61	34.31	-0.08	10.18	QP
6	0.37	40.51	-8.10	48.61	30.41	-0.08	10.18	Average
7	1.09	31.47	-14.53	46.00	21.30	-0.10	10.27	Average
8	1.09	39.37	-16.63	56.00	29.20	-0.10	10.27	QP
9	2.03	39.72	-6.28	46.00	29.50	-0.11	10.33	Average
10	2.03	49.32	-6.68	56.00	39.10	-0.11	10.33	QP
11	3.04	33.75	-12.25	46.00	23.50	-0.12	10.37	Average
12	3.04	44.65	-11.35	56.00	34.40	-0.12	10.37	QP



Test Mode :	Mode 1	Temperature :	22~23°C
Test Engineer :	Ming Cheng	Relative Humidity :	45~46%
Test Voltage :	120Vac / 60Hz	Phase :	Neutral
Function Type :	GSM850 Idle + Bluetooth Idle + WLAN Idle + Camera + Earphone + Adapter		
Remark :	All emissions not reported here are more than 10 dB below the prescribed limit.		

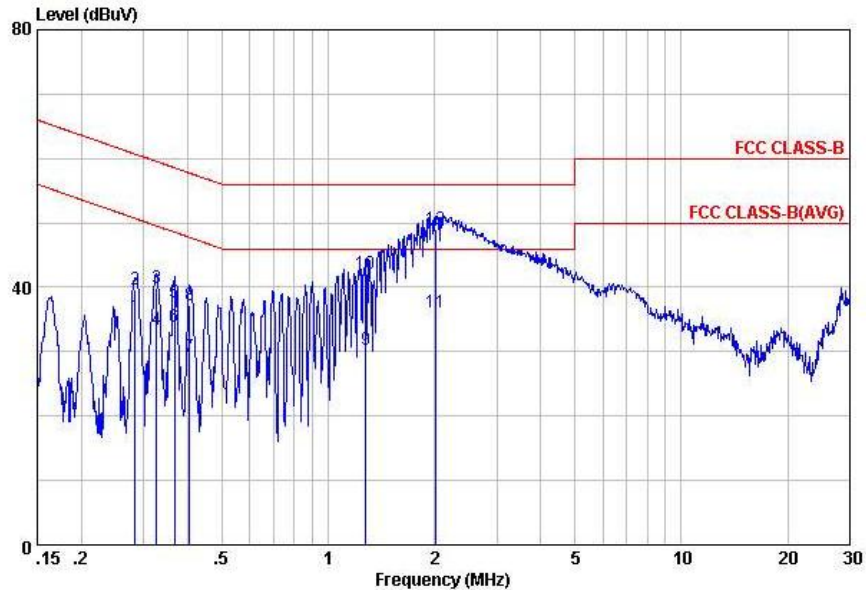

Site : C001-KS
 Condition: FCC CLASS-B LISN-100807 NEUTRAL

mode : Mode 1

	Freq	Level	Over	Limit	Read	LISN	Cable	Remark
	MHz	dBuV	Limit	Line	Level	Factor	Loss	
			dB	dBuV	dBuV	dB	dB	
1	0.28	35.39	-15.33	50.72	25.29	-0.07	10.17	Average
2	0.28	39.59	-21.13	60.72	29.49	-0.07	10.17	QP
3	0.33	39.80	-19.73	59.53	29.70	-0.08	10.18	QP
4	0.33	33.50	-16.03	49.53	23.40	-0.08	10.18	Average
5	0.37	37.61	-20.95	58.56	27.51	-0.08	10.18	QP
6	0.37	33.81	-14.75	48.56	23.71	-0.08	10.18	Average
7	0.40	29.21	-18.56	47.77	19.10	-0.08	10.19	Average
8	0.40	37.11	-20.66	57.77	27.00	-0.08	10.19	QP
9	1.28	30.29	-15.71	46.00	20.11	-0.10	10.28	Average
10	1.28	42.19	-13.81	56.00	32.01	-0.10	10.28	QP
11	2.01	36.12	-9.88	46.00	25.90	-0.11	10.33	Average
12	2.01	49.02	-6.98	56.00	38.80	-0.11	10.33	QP

3.2. Test of Radiated Emission Measurement

3.2.1. Limit of Radiated Emission

The emissions from an intentional radiator shall not exceed the field strength levels specified in the following table:

Frequency (MHz)	Field Strength (microvolts/meter)	Measurement Distance (meters)
0.009 – 0.490	2400/F(KHz)	300
0.490 – 1.705	24000/F(KHz)	30
1.705 – 30.0	30	30
30 – 88	100	3
88 – 216	150	3
216 - 960	200	3
Above 960	500	3

3.2.2. Measuring Instruments

See list of measuring instruments of this test report.

3.2.3. Test Procedures

1. The EUT was placed on a turntable with 0.8 meter above ground.
2. The EUT was set 3 meters from the interference receiving antenna, which was mounted on the top of a variable height antenna tower.
3. The table was rotated 360 degrees to determine the position of the highest radiation.
4. The antenna is a Bi-Log antenna and its height is adjusted between one meter and four meters above ground to find the maximum value of the field strength for both horizontal polarization and vertical polarization of the antenna.
5. For each suspected emission, the EUT was arranged to its worst case and then tune the antenna tower (from 1 m to 4 m) and turntable (from 0 degree to 360 degrees) to find the maximum reading.
6. Set the test-receiver system to Peak Detect Function and specified bandwidth with Maximum Hold Mode.
7. If the emission level of the EUT in peak mode was 3 dB lower than the limit specified, then testing will be stopped and peak values of EUT will be reported, otherwise, the emissions will be repeated one by one using the quasi-peak method and reported
8. Emission level (dBuV/m) = 20 log Emission level (uV/m)
9. Corrected Reading: Antenna Factor + Cable Loss + Read Level - Preamp Factor = Level

3.2.4. Test Setup of Radiated Emission

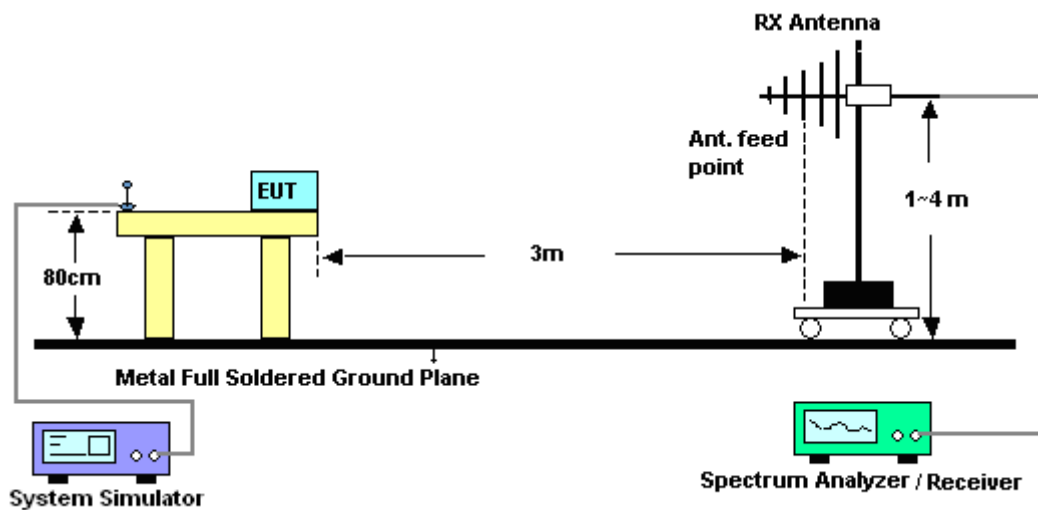



3.2.5. Test Results of Radiated Emissions (9 kHz ~ 30 MHz)

Test Engineer :	David Yang	Temperature :	21~23°C
		Relative Humidity :	50~52%

<Part15C>

Frequency	Measurement Distance	Field Strength	Antenna Factor	Distance Factor	Limit Distance	Field Strength at Limit Distance (30m)	Limit (30m)	Remark
(MHz)	(m)	(dBuV/m)	(dB/m)	(dB/decade)	(m)	(dBuV/m)	(dBuV/m)	-
0.03277	3	-4.76	19.7	40	30	-44.76	29.54	-

Note:

- The low frequency 32.768KHz was performed under Part15C, and the result was 20dB lower than the limit line.
- In accordance with 15.33 (a): For each frequency at which a measurement is made at only one distance, the square of an inverse linear distance extrapolation factor (40 dB/decade) is applied.
 Distance extrapolation factor = 40 log (specific distance / test distance) (dB);
 Limit line = specific limits (dBuV) + distance extrapolation factor.
- The field strength measured is direct conversion of all parameters (antenna factor and distance extrapolation factor) and loaded into the spectrum.
- For example 1:
 Field Strength at 3m=10 (dBuV/m)
 Field Strength at 30m=10- 40*log(30m/3m)=-30 (dBuV/m)
 For example 2:
 Field Strength at 10m=10 (dBuV/m)
 Field Strength at 30m=10- 40*log(30m/10m)=-9.08 (dBuV/m)

<Part15B>

Frequency	Measurement Distance	Field Strength	Antenna Factor	Distance Factor	Limit Distance	Field Strength at Limit Distance (30m)	Limit (30m)	Remark
(MHz)	(m)	(dBuV/m)	(dB/m)	(dB/decade)	(m)	(dBuV/m)	(dBuV/m)	-
-	-	-	-	-	-	-	-	-

Note:

The low frequency, which started from 32.768 KHz to 30MHz, was pre-scanned and the result which was 20dB lower than the limit line per 15.31(o) was not reported.



3.2.6. Test Result of Radiated Emission

Test Mode :	Mode 3	Temperature :	22~23°C
Test Engineer :	Ming Cheng	Relative Humidity :	45~46%
Test Distance :	3m	Polarization :	Horizontal
Function Type :	WCDMA Band V Idle + Bluetooth Idle + WLAN Idle + Earphone + GPS Rx + USB Cable (Data Link with PC)		

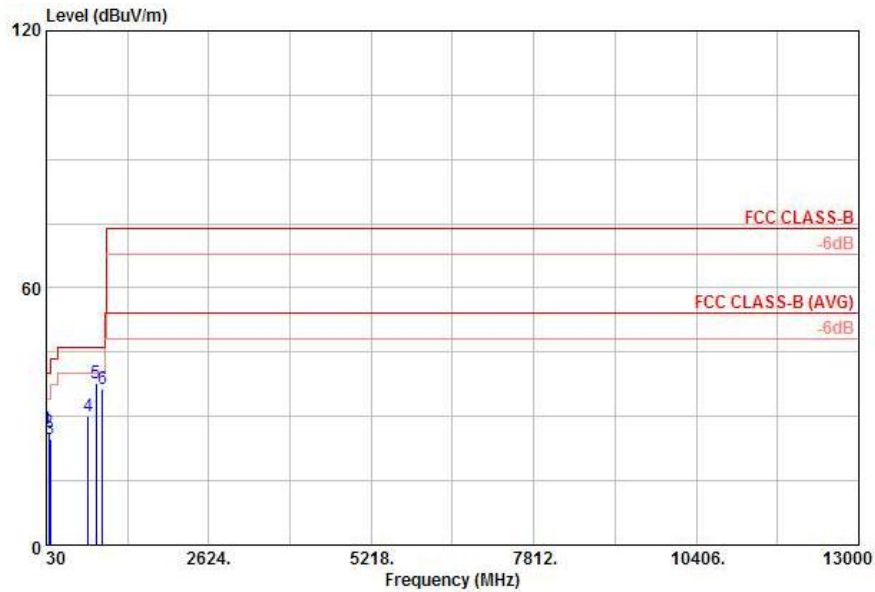

Site : 03CH01-KS
 Condition: FCC CLASS-B 3m LF_ANT_100803 HORIZONTAL

Mode : mode 3
 IMEI : 358546040002123

	Freq	Level	Over	Limit	Readantenna	Cable	Preamp	Ant	Table	Remark
	MHz	dBuV/m	Limit	Line	Level	Loss	Factor	Pos	Pos	
			dB	dBuV/m	dBuV	Factor	dB	cm	deg	
1	32.43	27.09	-12.91	40.00	40.90	16.04	0.24	30.09	---	Peak
2	69.42	26.29	-13.71	40.00	50.73	5.30	0.34	30.08	---	Peak
3	91.83	24.68	-18.82	43.50	44.92	9.35	0.39	29.98	---	Peak
4	699.00	30.03	-15.97	46.00	39.34	19.29	1.13	29.73	---	Peak
5	824.30	37.81	-8.19	46.00	46.01	20.16	1.26	29.62	100	203 Peak
6	930.00	36.48	-9.52	46.00	44.05	20.63	1.32	29.52	---	Peak



Test Mode :	Mode 3	Temperature :	22~23°C
Test Engineer :	Ming Cheng	Relative Humidity :	45~46%
Test Distance :	3m	Polarization :	Vertical
Function Type :	WCDMA Band V Idle + Bluetooth Idle + WLAN Idle + Earphone + GPS Rx + USB Cable (Data Link with PC)		

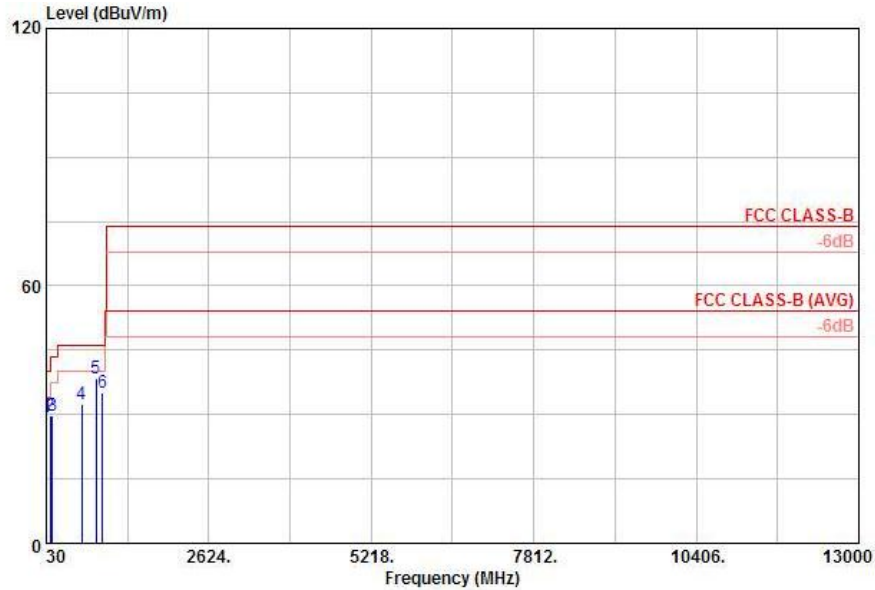

Site : 03CH01-KS
 Condition: FCC CLASS-B 3m LF_ANT_100803 VERTICAL

Mode : mode 3
 IMEI : 358546040002123

	Freq	Level	Over	Limit	ReadAntenna	Cable	Preamp	Ant	Table		
	MHz	dBuV/m	dB	dBuV/m	dBuV	dB/m	dB	dB	cm	deg	
1	32.43	29.39	-10.61	40.00	43.20	16.04	0.24	30.09	---	---	Peak
2	92.37	29.71	-13.79	43.50	49.95	9.35	0.39	29.98	---	---	Peak
3	122.07	29.92	-13.58	43.50	47.66	11.78	0.45	29.97	---	---	Peak
4	594.00	32.49	-13.51	46.00	42.47	18.59	1.06	29.63	---	---	Peak
5	824.30	38.30	-7.70	46.00	46.50	20.16	1.26	29.62	100	228	Peak
6	931.40	35.20	-10.80	46.00	42.76	20.64	1.32	29.52	---	---	Peak



4. List of Measuring Equipment

Instrument	Manufacturer	Model No.	Serial No.	Characteristics	Calibration Date	Test Date	Due Date	Remark
EMI Test Receiver	R&S	ESCI7	100768	9kHz~7GHz	Jun. 02, 2011	Dec. 05, 2011	Jun. 01, 2012	Conduction (CO01-KS)
LISN	MessTec	AN3016	60103	9kHz~30MHz	Jan. 07, 2011	Dec. 05, 2011	Jan. 06, 2012	Conduction (CO01-KS)
LISN	MessTec	AN3016	60105	9kHz~30MHz	Jan. 07, 2011	Dec. 05, 2011	Jan. 06, 2012	Conduction (CO01-KS)
AC Power Source	Chroma	61602	ABP0000008 11	N/A	Nov. 16, 2011	Dec. 05, 2011	Nov. 15, 2012	Conduction (CO01-KS)
Spectrum Analyzer	R&S	FSP30	101067	9KHz ~ 30GHz	Dec. 06, 2011	Dec. 29, 2011	Dec. 05, 2012	Radiation (03CH07-HY)
Pre Amplifier	COM-POWER	PA-103A	161241	10-1000MHz.32 dB.GAIN	Mar. 29, 2011	Dec. 29, 2011	Mar. 28, 2012	Radiation (03CH07-HY)
EMI TEST RECEIVER	R&S	ESCI 7	100724	9kHz~7GHz	Aug. 22, 2011	Dec. 29, 2011	Aug. 21, 2012	Radiation (03CH07-HY)
Loop Antenna	R&S	HFH2-Z2	860004/001	9 kHz~30 MHz	Jul. 29, 2010	Dec. 29, 2011	Jul. 28, 2012	Radiation (03CH07-HY)
EMI Test Receiver	R&S	ESCI	100534	9kHz~3GHz	Nov. 09, 2011	Dec. 05, 2011	Nov. 08, 2012	Radiation (03CH01-KS)
Spectrum Analyzer	R&S	FSP40	100319	9kHz~40GHz	Jan. 07, 2011	Dec. 05, 2011	Jan. 06, 2012	Radiation (03CH01-KS)
Spectrum Analyzer	R&S	FSP30	101400	9kHz~30GHz	Jun. 02, 2011	Dec. 05, 2011	Jun. 01, 2012	Radiation (03CH01-KS)
Bilog Antenna	SCHAFFNER	CBL6112D	23182	25MHz~2GHz	Dec. 07, 2010	Dec. 05, 2011	Dec. 06, 2011	Radiation (03CH01-KS)
Double Ridge Horn Antenna	EMCO	3117	00075959	1GHz~18GHz	Jan. 07, 2011	Dec. 05, 2011	Jan. 06, 2012	Radiation (03CH01-KS)
Amplifier	Wireless	FPA-6592G	060029	9KHz~2GHz	Jan. 10, 2011	Dec. 05, 2011	Jan. 09, 2012	Radiation (03CH01-KS)
Amplifier	Agilent	8449B	3008A02370	1GHz~26.5GHz	Jan. 07, 2011	Dec. 05, 2011	Jan. 06, 2012	Radiation (03CH01-KS)
Active Horn Antenna	com-power	AHA-118	701023	1G-18GHz	Nov. 07, 2011	Dec. 05, 2011	Nov. 06, 2012	Radiation (03CH01-KS)
SHF-EHF Horn	Schwarzbeck	BBHA 9170	BBHA170249	15-40GHz	Oct. 11, 2011	Dec. 05, 2011	Oct. 10, 2012	Radiation (03CH01-KS)
GPS Station	T&E	GS-50	N/A	N/A	N/A	Dec. 05, 2011	N/A	-
System Simulator	R&S	CMU200	837587/066	Full-Band	Jan. 07, 2011	Dec. 05, 2011	Jan. 06, 2012	-

5. Uncertainty of Evaluation

Uncertainty of Conducted Emission Measurement (150 KHz ~ 30 MHz)

Contribution	Uncertainty of X_i		$u(X_i)$
	dB	Probability Distribution	
Receiver Reading	0.10	Normal (k=2)	0.05
Cable Loss	0.10	Normal (k=2)	0.05
AMN Insertion Loss	2.50	Rectangular	0.63
Receiver Specification	1.50	Rectangular	0.43
Site Imperfection	1.39	Rectangular	0.80
Mismatch	+0.34 / -0.35	U-Shape	0.24
Combined Standard Uncertainty $Uc(y)$	1.13		
Measuring Uncertainty for a Level of Confidence of 95% ($U = 2Uc(y)$)	2.26		

Uncertainty of Radiated Emission Measurement (30 MHz ~ 1000 MHz)

Contribution	Uncertainty of X_i		$u(X_i)$
	dB	Probability Distribution	
Receiver Reading	0.41	Normal (k=2)	0.21
Antenna Factor Calibration	0.83	Normal (k=2)	0.42
Cable Loss Calibration	0.25	Normal (k=2)	0.13
Pre-Amplifier Gain Calibration	0.27	Normal (k=2)	0.14
RCV/SPA Specification	2.50	Rectangular	0.72
Antenna Factor Interpolation for Frequency	1.00	Rectangular	0.29
Site Imperfection	1.43	Rectangular	0.83
Mismatch	+0.39 / -0.41	U-Shape	0.28
Combined Standard Uncertainty $Uc(y)$	1.27		
Measuring Uncertainty for a Level of Confidence of 95% ($U = 2Uc(y)$)	2.54		



Uncertainty of Radiated Emission Measurement (1 GHz ~ 40 GHz)

Contribution	Uncertainty of X_i		$u(X_i)$	C_i	$C_i * u(X_i)$
	dB	Probability Distribution			
Receiver Reading	± 0.10	Normal (k=2)	0.10	1	0.10
Antenna Factor Calibration	± 1.70	Normal (k=2)	0.85	1	0.85
Cable Loss Calibration	± 0.50	Normal (k=2)	0.25	1	0.25
Receiver Correction	± 2.00	Rectangular	1.15	1	1.15
Antenna Factor Directional	± 1.50	Rectangular	0.87	1	0.87
Site Imperfection	± 2.80	Triangular	1.14	1	1.14
Mismatch Receiver VSWR $\Gamma_1 = 0.197$ Antenna VSWR $\Gamma_2 = 0.194$ Uncertainty = $20\text{Log}(1-\Gamma_1*\Gamma_2)$	+0.34 / -0.35	U-Shape	0.244	1	0.244
Combined Standard Uncertainty $U_c(y)$	2.36				
Measuring Uncertainty for a Level of Confidence of 95% ($U = 2U_c(y)$)	4.72				