



MOTOROLA

HAC Test Report for Near Field Emissions IHDP56MH1

Tests Requested By: Motorola Mobility, Inc.
600 N. US Highway 45
Libertyville, IL 60048

Date of Tests: Jul-05-2011 to Jul-06-2011
Date of Report: Jul-27-2011

Test Laboratory: Motorola Mobility, Inc. - ADR Test Services Laboratory
600 N. US Highway 45
Libertyville, Illinois 60048

Report Author: Thomas Knipple
Senior RF Engineer

Statement of Compliance: Motorola declares under its sole responsibility that portable cellular telephone FCC ID IHDP56MH1 to which this declaration relates, complies with recommendations and guidelines per FCC 47 CFR §20.19. The measurements were performed to ensure compliance to ANSI C63.19-2007. It also declares that the product was tested in accordance with the appropriate measurement standards, guidelines and recommended practices. Any deviations from these standards, guidelines and recommended practices are noted below:

(none)

Results Summary: M Category = M3

©MOTOROLA MOBILITY, INC. 2011

This test report shall not be reproduced except in full, without written approval of the laboratory.

The results and statements contained herein relate only to the items tested. The names of individuals involved may be mentioned only in connection with the statements or results from this report.

Motorola encourages all feedback, both positive and negative, on this test report.

Table of Contents

1. INTRODUCTION3

2. DESCRIPTION OF THE DEVICE UNDER TEST.....3

3. TEST EQUIPMENT USED.....4

4. VALIDATION5

5. PROBE MODULATION FACTOR6

6. TEST RESULTS.....8

Appendix 1: Details justifying the conversion to peak
A1.1 Procedure for PMF measurements
A1.2 0-span spectrum plots for PMF measurements

Appendix 2: HAC Distribution Plots for Validation

Appendix 3: HAC Distribution Plots for E-Field and H-Field

Appendix 4: Motorola Uncertainty Budget
A4.1 Motorola Uncertainty Budget for RF HAC testing
A4.2 Probe Rotation Contributions to Isotropy Error

Appendix 5: Pictures of Test Setup

Appendix 6: Probe Calibration Certificates

Appendix 7: Dipole Characterization Certificates

1. Introduction

The Motorola Mobility ADR Test Services Laboratory has performed Hearing Aid Compatibility (HAC) measurements for the portable cellular phone (FCC ID IHDP56MH1). The portable cellular phone was tested in accordance with the ANSI C63.19-2007 standard. The test results presented herein clearly demonstrate compliance per FCC 47 CFR § 20.19. This report demonstrates compliance for near-field emissions only and not for Telecoil HAC performance compliance.

2. Description of the Device Under Test

Table 1: Information for the Device Under Test

Serial number (Used For)	364VML0DQ3 (All HAC testing, Conducted power measurements)					
Mode(s) of Operation	800 iDEN (Interconnect / Dispatch)	800 iDEN (Packet Data)	900 iDEN (Interconnect/ Dispatch)	900 iDEN (Packet Data)	Wi-Fi 802.11b/g	Bluetooth
Modulation Mode(s)	M16-QAM	M64-QAM, M16-QAM, QPSK	M16-QAM	M64-QAM, M16-QAM, QPSK	BPSK	GFSK
Maximum Output Power Setting	28.06 dBm		28.06 dBm		18.0 dBm	10.0 dBm
Duty Cycle	2:6 / 1:6	81:120	2:6 / 1:6	81:120	1:1	1:1
Transmitting Frequency Range(s)	806.0125 – 824.9875 MHz		896.01875 – 901.98125 MHz		2412.0 - 2462.5 MHz	2400.0 – 2483.5 MHz
Production Unit or Identical Prototype (47 CFR §2.908)	Identical Prototype					
Device Category	Portable					
Supports Voice on Interface	YES	NO	YES	NO	YES (VOIP)	NO
Test requirements defined in C63.19-2007	YES	NO	YES	NO	NO	NO
Supports Simultaneous Operation With	Wi-Fi, Bluetooth	Bluetooth	Wi-Fi, Bluetooth	Bluetooth	iDEN	iDEN

Note: No Bluetooth profile exists in this phone that will allow a Bluetooth link while in a cellular call that passes audio to the earpiece. If the user had Bluetooth enabled and a link established, they could not be listening to the phone through the earpiece.

Note: Wi-Fi capability is included in this phone without measurements for hearing aid compatibility based on the interim ruling by the FCC according to paragraph 37 of the Federal Register, Volume 3, Number 89, as of May 7, 2008. Users shall be informed of this via the product user guide per the same FCC ruling.

3. Test Equipment Used

The Motorola Mobility ADR Test Services Laboratory utilizes a Dosimetric Assessment System (DASY4™ v4.7) manufactured by Schmid & Partner Engineering AG (SPEAG™), of Zurich Switzerland. All the HAC measurements are taken within a shielded enclosure. The measurement uncertainty budget is given in Appendix 4. The list of calibrated equipment used for the measurements is shown below.

Table 2: Dosimetric System Equipment

Description	Serial Number	Cal Date	Cal Due Date
E-Field Probe ER3DV6R	2248	Apr-15-2011	Apr-15-2012
DAE4	376	Jul-13-2010	Jul-13-2011
H-Field Probe H3DV6	6074	Apr-11-2011	Apr-11-2012
DAE4	661	Jan-13-2011	Jan-13-2012
835 MHz Dipole CD835V3	1076	Feb-16-2010	Feb-16-2012

Table 3: Additional Test Equipment

Description	Serial Number	Cal Date	Cal Due Date
Power Supply 6623A	US37360829	Nov-02-2009	Nov-05-2011
Signal Generator E4438C	MY45090104	Aug-22-2009	Aug-22-2011
Amplifier ZHL-42-SMA	1040		
3 dB Attenuator 8491A	50579	Nov-13-2009	Nov-13-2011
Directional Coupler 778D	18578	Jun-07-2010	Jun-07-2012
Power Meter E4417A	MY45100140	Dec-23-2009	Dec-23-2011
Power Sensor #1 – E9323A	MY44420341	Aug-30-2010	Aug-30-2011
Power Sensor #2 - E9323A	MY44420342	Aug-30-2010	Aug-30-2011
10 dB Attenuator 8491A	3929M50712	Nov-12-2009	Nov-12-2011
Spectrum Analyzer E4403B	US39440480	Oct-26-2010	Oct-26-2011
Power Splitter ZAPD-21-S(+)	SU327300437		

4. Validation

Validations of the DASY4 v4.7 test system were performed using the measurement equipment listed in Section 3.1. All validations occur in free space using the DASY4 test arch. Note that the 10 mm probe-to-dipole separation is measured from the top edge of the dipole to the calibration reference point of the probe. SPEAG uses the center point of the probe sensor(s) as the reference point when establishing targets for their dipoles. Therefore, because SPEAG’s dipoles and targets are used, it is appropriate to measure the 10 mm separation distance to the center of the sensors as they do. This reference point was used for validation only. Validations were performed at 835 MHz and/or 898 MHz. The results obtained from the validations are displayed in the table below. The field contour plots are included in Appendix 2.

Validations were performed to verify that measured E-field and H-field values are within $\pm 25\%$ from the target reference values provided by the manufacturer (Ref: Appendix 7). Per Section 4.3.2.1 of the C63.19 standard, “Values within $\pm 25\%$ are acceptable, of which 12% is deviation and 13% is measurement uncertainty”. Therefore, the E-field and H-field dipole verification results shown in Table 4 are in accordance with the acceptable parameters defined by the standard.

Table 4: Dipole Measurement Summary

Dipole	Date	f (MHz)	Protocol	Input Power (mW)	E-Field Results (V/m)	Target for Dipole (V/m)	% Deviation
1076	Jul-05-2011	835	CW	100	168.7	164.8	+2.4%
1076	Jul-05-2011	898	CW	100	155.6	155.3	+0.2%

Dipole	Date	f (MHz)	Protocol	Input Power (mW)	H-Field Results (A/m)	Target for Dipole (A/m)	% Deviation
1076	Jul-05-2011	835	CW	100	0.450	0.459	-2.0%
1076	Jul-05-2011	898	CW	100	0.416	0.434	-4.1%

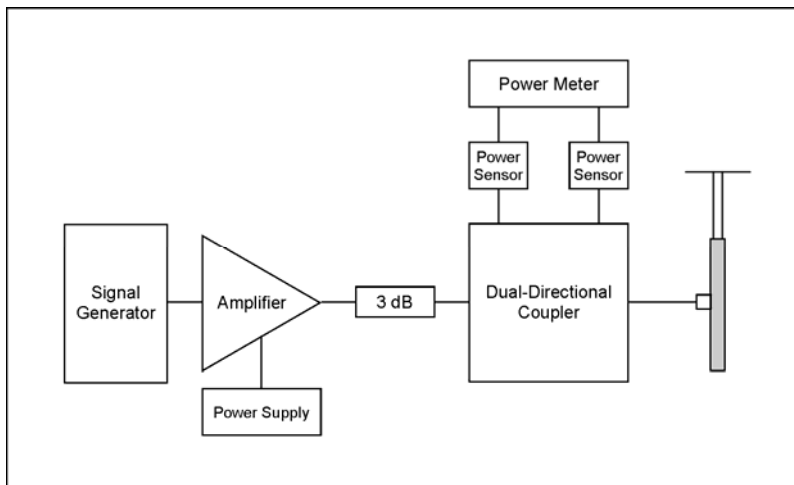

Figure 1: Setup for Validation measurements

5. Probe Modulation Factor

After every probe calibration, the response of the probe to each applicable modulated signal (CDMA, GSM, etc) must be assessed at the frequencies of operation. The response of the probe system to a CW field at each frequency of interest is compared to its response to a modulated signal with equal peak amplitude. For each PMF assessment, a signal generator was used to replace the original CW signal with the desired modulated signal. The PMF results applicable to this test document are shown in Table 5.

RF Field Probe Modulation Response was measured with the field probe and associated measurement equipment. The PMF was measured using a signal generator as follows:

1. Illuminate a dipole with a CW signal at the intended measured frequency.
2. Fix the probe at a set location relative to the dipole, typically located at the field reference point.
3. Record the reading of the probe measurement system of the CW signal.
4. Substitute a modulated signal of the same amplitude, using the same modulation as that used by the intended WD for the CW signal.
5. Record the reading of the probe measurement system of the modulated signal.
6. The ratio of the CW to modulated signal reading is the probe modulation factor.

Using a dual-directional coupler, the forward power and reverse power are measured and adjusted when connected to the dipole and spectrum analyzer through a power splitter and matched cables. The spectrum analyzer is used to set the peak amplitude of the modulated signal equal to the amplitude of the CW signal. The procedure used to ensure that the amplitudes are the same is given in Appendix 1. 0-Span spectrum plots for each signal type measured are also provided in Appendix 1.



Figure 2: Setup for PMF measurements

To measure the PMF for an iDEN signal, the modulated signal is injected into the dipole. When the peak power level produces a field strength less than or equal to the M3 category limit, this power level is used. If this peak power level produces a field strength much greater than the M3 category limit, a power level which produces a field strength approximately equal to the M3 category limit is used instead.

Table 5: PMF Measurement Summary

f (MHz)	Protocol	E-Field Probe SN 2248		H-Field Probe SN 6074	
		E-Field (V/m)	E-Field Modulation Factor	H-Field (A/m)	H-Field Modulation Factor
813	CW	335.1		1.101	
	iDEN (2:6 Rate)	95.6	3.51	0.3665	3.00
	iDEN (1:6 Rate)	66.63	5.03	0.2591	4.25
898	CW	273.3		1.042	
	iDEN (2:6 Rate)	79.56	3.44	0.3503	2.97
	iDEN (1:6 Rate)	56.50	4.84	0.2472	4.22

f (MHz)	Protocol	E-Field Probe SN 2248		H-Field Probe SN 6074	
		E-Field (V/m)	E-Field Modulation Factor	H-Field (A/m)	H-Field Modulation Factor
813	CW	133.2		0.5181	
	80% AM	82.79	1.61	0.3364	1.54
898	CW	108.2		0.4377	
	80% AM	67.63	1.60	0.2844	1.54

6. Test Results

The phone was tested in normal configurations for against-the-ear use. When applicable, configurations are tested with the antenna in its fully-extended position. These test configurations are tested at the high, middle and low frequency channels of each applicable operating band and mode; for example, GSM, CDMA, WCDMA, or iDEN.

The DUT is capable of operation in a test mode that allows control of the transmitter without the need to place actual phone calls. This guarantees that the unit does not change its transmitter power, and that the resultant measured field values will not be affected by external connections. For the purposes of this testing the unit is commanded to test mode and manually set to the proper channel, transmitter power level and transmit mode of operation. For the purposes of these tests, the transmitter was operated at the highest power level available.

The cellular phone model tested in this report uses the following default battery:

Battery #1 – SNN5843A – 1420 mAH Battery

The phone is placed in the HAC measurement system with a fully charged battery. At the end of each test the DASY™ system measures the drift of the field strength at a fixed reference point to ensure that the DUT has not changed in transmitter power.

The DASY4 v4.7 measurement system specified in section 3.1 was utilized within the intended operations as set by the SPEAG™ setup. The default settings for the grid spacing of the scan were set to 5 mm as shown in the Field plots included in Appendix 2 and 3. The 5 cm x 5 cm area measurement grid is centered on the acoustic output of the device. The Test Arch provided by SPEAG is used to position the DUT. The pictures of the setup are included in Appendix 5. The WD reference plane is parallel to the device and contains the highest point on its contour in the area of the phone that normally rests against the user's ear. The measurement plane contains the center point of the probe sensor(s). The device is positioned such that the WD reference plane is located 15 mm from, and parallel to, the measurement plane. This is in accordance with section 4.4 of the standard, which states that "The WD reference plane is a plane parallel with the front "face" of the WD and containing the highest point on its contour in the area of the phone that normally rests against the user's ear."

During testing, the DUT is placed into a polystyrene block (3-pound expanded polystyrene) which is machined to precisely fit the DUT's shape. The test positioner, provided by SPEAG, is used to grip the block. This positioning conforms to the specifications given in the paragraph above. The addition of the block does not increase the uncertainty budget, which is provided in Appendix 4. The pictures of the measurement setup are included in Appendix 5.

The HAC Rating results for E-Field and H-field are shown in Tables 6 through 9. Also shown are the measured conducted output powers, the measured drifts, excluded areas, and the peak field values. PMF measurements are taken from Section 5. The worst-case test conditions are indicated with **bold numbers** in the tables and are detailed in Appendix 3: HAC distribution plots for E-Field and H-Field.

Drift was measured using the typical DASY4 v4.7 measurement routines. The field is measured at the reference location (center of the ear piece) at the beginning of the test. After completion of the E-field or H-field measurement, the probe returns to the same reference location and takes another measurement. The drift is the delta between these two values and is included in the test report scans.

Per SPEAG's recommendation, the phone plots in Appendix 3 use the following standard transmitter ratios as "Duty Cycle": 1:8 for GSM transmitters; 1:1 for full-rate CDMA and 1:8 for 1/8th rate CDMA; 1:1 for WCDMA; 1:6 for 1:6 rate iDEN and 1:3 for 2:6 rate iDEN. Per SPEAG's recommendation, in order to account for probe modulation response, PMF is applied during post-processing of the measured data in SEMCAD. PMF also appears in the phone plots in Appendix 3.

DUT Emissions Limits (AWF = 0) f < 960 MHz	
Rating	E-Field
M3	199.5 – 354.8 V/m
M4	< 199.5 V/m

Table 6: HAC E-Field measurement results for the portable cellular telephone at highest possible output power (2:6 Rate).

Band	Antenna Position	Frequency Setting (MHz)	Conducted Output Power (dBm)	Measured PMF	Drift (dB)	Excluded Cells	Peak Field (V/m)	Rating
iDEN 800	Internal	806.0125	27.95	3.51	0.006	2,3	185.7	M4
		815.5125	27.97		-0.107	2,3	216.7	M3
		824.9875	27.94		-0.121	2,3	240.0	M3
iDEN 900	Internal	896.0188	27.94	3.44	-0.006	2,3	213.7	M3
		901.9813	28.12		0.101	2,3	222.1	M3

Table 7: HAC E-Field measurement results for the portable cellular telephone at highest possible output power (1:6 Rate).

Band	Antenna Position	Frequency Setting (MHz)	Conducted Output Power (dBm)	Measured PMF	Drift (dB)	Excluded Cells	Peak Field (V/m)	Rating
iDEN 800	Internal	806.0125	28.01	5.03	-0.021	2,3	185.8	M4
		815.5125	27.94		-0.192	2,3	221.8	M3
		824.9875	28.02		0.035	2,3	247.0	M3
iDEN 900	Internal	896.0188	27.94	4.84	0.065	2,3	210.5	M3
		901.9813	27.93		0.108	2,3	221.4	M3

DUT Emissions Limits (AWF = 0) f < 960 MHz	
Rating	H-Field
M3	0.60 – 1.07 A/m
M4	< 0.60 A/m

Table 8: HAC H-Field measurement results for the portable cellular telephone at highest possible output power (2:6 Rate).

Band	Antenna Position	Frequency Setting (MHz)	Conducted Output Power (dBm)	Measured PMF	Drift (dB)	Excluded Cells	Peak Field (A/m)	Rating
iDEN 800	Internal	806.0125	27.95	3.00	-0.001	1,4,7	0.231	M4
		815.5125	27.97		-0.018	1,4,7	0.264	M4
		824.9875	27.94		0.127	1,4,7	0.252	M4
iDEN 900	Internal	896.0188	27.94	2.97	-0.098	1,4,7	0.303	M4
		901.9813	28.12		-0.188	1,4,7	0.313	M4

Table 9: HAC H-Field measurement results for the portable cellular telephone at highest possible output power (1:6 Rate).

Band	Antenna Position	Frequency Setting (MHz)	Conducted Output Power (dBm)	Measured PMF	Drift (dB)	Excluded Cells	Peak Field (A/m)	Rating
iDEN 800	Internal	806.0125	28.01	4.25	-0.032	1,4,7	0.241	M4
		815.5125	27.94		0.140	1,4,7	0.273	M4
		824.9875	28.02		-0.066	1,4,7	0.284	M4
iDEN 900	Internal	896.0188	27.94	4.22	-0.084	1,4,7	0.304	M4
		901.9813	27.93		-0.188	1,4,7	0.317	M4

Appendix 1

Details justifying the conversion to peak

A1.1 Procedure for PMF measurements

1. Set up and calibrate the HAC validation rack as noted in Figure 2; a power splitter is connected to the dual-directional coupler, which is then connected to both the spectrum analyzer and dipole on the output side of the splitter using matched cables. This cabling arrangement will remain in place throughout the following steps.
2. Command the HAC validation rack as you would for a normal CW HAC validation with forward power per Table A1 for the mode, frequency, and field probe type of interest.
3. Set up the dipole and phantom as you would for a normal CW HAC validation.
4. In the DASY software, open appropriate job template and verify the following parameters:
Medium = "Air";
Communication System = "HAC – Dipole";
Ensure the proper probe & DAE are installed and laser aligned
5. **Measure the CW signal:** With the CW signal transmitting through the dipole, command the DASY system to run the appropriate field measurement job.
6. Do **not** turn off the signal generator power.
7. **Setting the CW Reference Level on the Spectrum Analyzer:**
 - a. Set up the Spectrum Analyzer for the following Settings:
Frequency: Freq. being tested (EX: 835/1880)
Span: Zero Span
Res BW: iDEN – 100 kHz; GSM – 300 kHz; CDMA – 3 MHz; WCDMA – 5 MHz;
Video BW: iDEN – 300 kHz; GSM – 1MHz; CDMA and WCDMA – 30 kHz**;
Sweep Time: 20 ms; 120 ms for iDEN
Scale: 1 dB
Detector: PEAK / Manual
 - b. Adjust the REF level until the CW signal is aligned with the Center Line (approx. 15 dB). NOTE: After this point, the Reference Line must remain fixed. Do not change it.
8. **Measure the modulated signal(s):**
 - a. Command the signal generator to the desired modulation.
 - b. Set the Spectrum Analyzer Sweep Time to 20 ms.
 - c. Adjust the amplitude of the power on the signal generator so that the PEAK of the modulated signal is at the CW Reference Line:
 - i. On the Spectrum Analyzer, press the [View Trace] button and then select (Max Hold), this will show only the Peak output.
 - ii. Press (Clear Write) and then (Max Hold) each time an amplitude adjustment is made.
 - d. Allow the Max Hold line to stabilize. Then check that the highest peak of the Max Hold line corresponds with the CW Reference Line (without going over). If not correct, repeat the steps beginning with step 8c.
9. Command the DASY system to run the appropriate field measurement job.
10. Repeat steps 2 through 9 until all PMF measurements have been completed.

**The use of 30 kHz VBW is validated. The power measurements are verified using an average power meter.

Table A1: PMF Measurement, CW Signal Dipole Input Power

Mode	f (MHz)	Field Probe Type	Dipole Input Power	Notes
80% AM	813	E and H	100 mW	
	835			
	898			
	1730			
	1880			
CDMA (Full & 1/8 th)	835	E and H	320 mW	1
	1730		50 mW	2
	1880		50 mW	2
WCDMA	835	E and H	250 mW	1
	1730		50 mW	2
	1880		50 mW	2
GSM	835	E-Field	690 mW	2
		H-Field	270 mW	2
	1880	E-Field	35 mW	2
		H-Field	27 mW	2
iDEN (1:6 & 2:6)	813	E-Field	640 mW	1
		H-Field	460 mW	2
	898	E-Field	640 mW	1
		H-Field	580 mW	2

Note 1: The power level shown represents the typical DUT peak power level for this configuration.

Note 2: The typical peak power level for this configuration results in a field strength significantly higher than the relevant M3 category limit field strength, and is therefore not realistic. The power level shown results in a field strength approximating the M3 category limit value.

A1.2 0-Span Spectrum Plots for PMF measurements

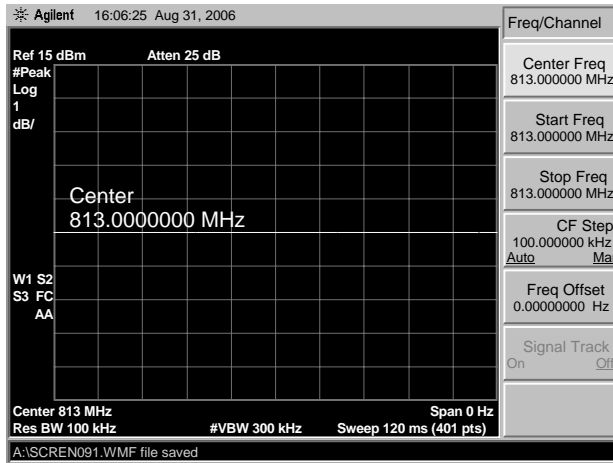

CW 813 MHz

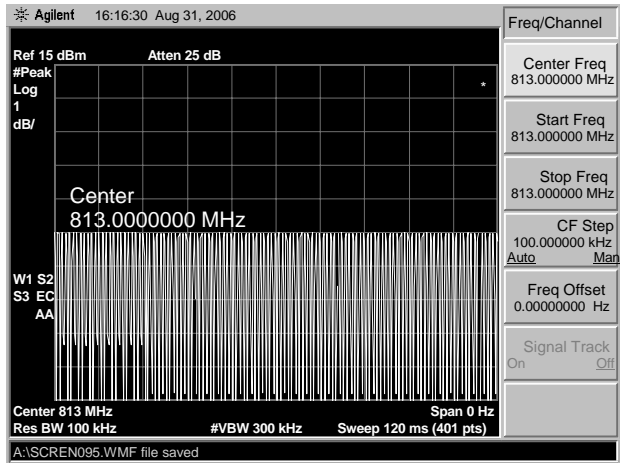

80% AM 813 MHz

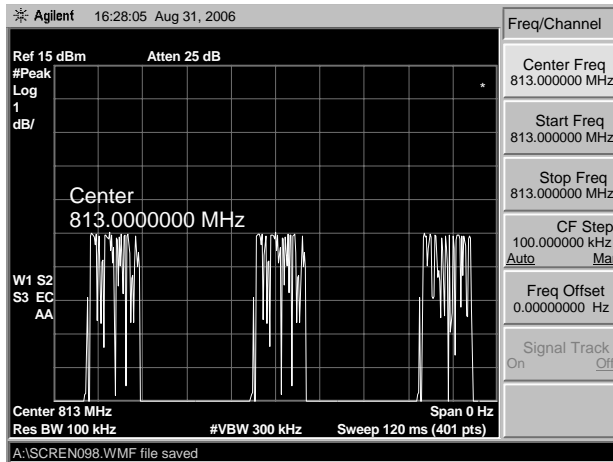

iDEN 813 MHz (2:6 rate)

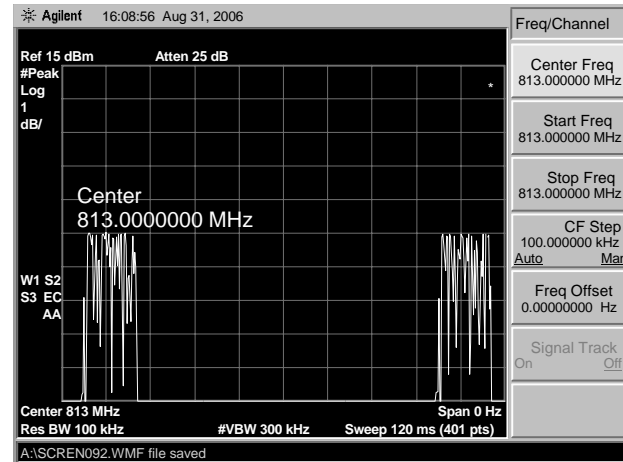

iDEN 813 MHz (1:6 rate)

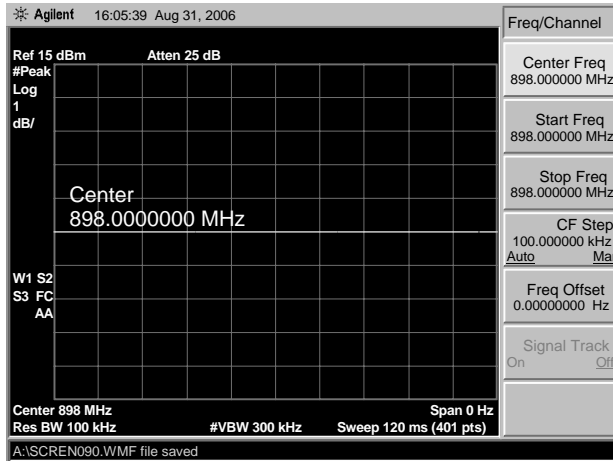

CW 898 MHz

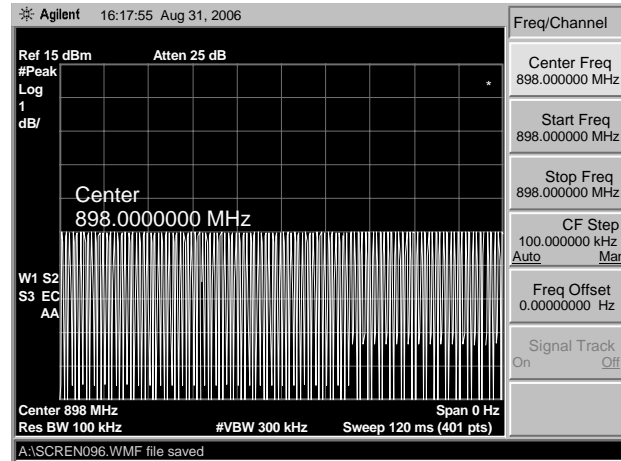

80% AM 898 MHz

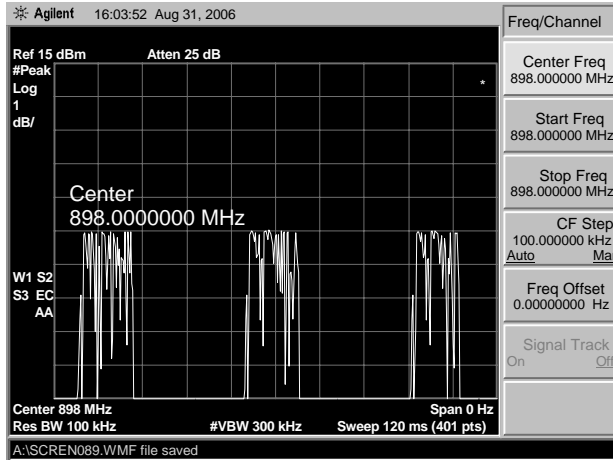

iDEN 898 MHz (2:6 rate)

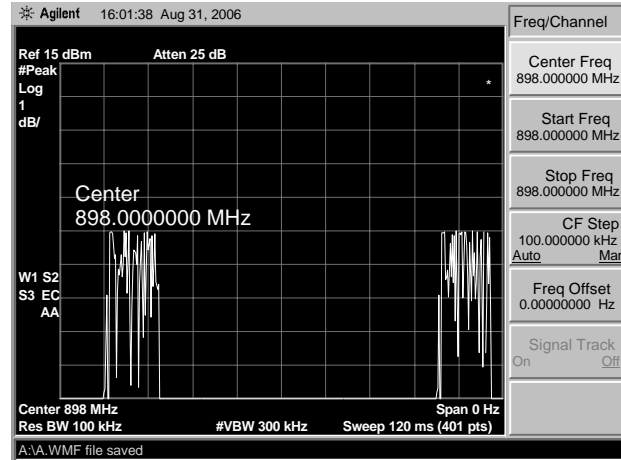

iDEN 898 MHz (1:6 rate)

Appendix 2

HAC distribution plots for Validation

Date/Time: 7/5/2011 7:26:13 PM

Test Laboratory: Motorola - Jul-05-2011 E-Field 835 MHz

DUT: HAC-Dipole 835 MHz; Type: CD835V3; Serial: 1076; FCC ID: IHDP56MH1

Procedure Notes: 835 MHz HAC Validation; Dipole Sn# 1076; Input Power = 100 mW

Communication System: CW - HAC; Frequency: 835 MHz; Duty Cycle: 1:1

Medium: Air; Medium parameters used: $\sigma = 0$ mho/m, $\epsilon_r = 1$; $\rho = 0$ kg/m³

DASY4 Configuration:

- Probe: ER3DV6R - SN2248; ConvF(1, 1, 1); Calibrated: 4/15/2011
- Sensor-Surface: 0mm (Fix Surface)Sensor-Surface: (Fix Surface)
- Electronics: DAE4 Sn376; Calibrated: 7/13/2010
- Phantom: R-3, HAC Test Arch (rev.2); Type: SD HAC P01 BA; Serial: 1071;
- Measurement SW: DASY4, V4.7 Build 80; Postprocessing SW: SEMCAD, V1.8 Build 186

E Scan - Probe center 10mm above Dipole/Hearing Aid Compatibility Test (41x361x1):

Measurement grid: dx=5mm, dy=5mm; Probe Modulation Factor = 1.00

Device Reference Point: 0.000, 0.000, -6.30 mm; Reference Value = 123.9 V/m; Power Drift = -0.010 dB

Maximum value of Total (interpolated) = 173.2 V/m

Average value of Total (interpolated) = $(173.2 + 164.2) / 2 = 168.7$ V/m

Peak E-field in V/m

Grid 1 163.5 M4	Grid 2 173.2 M4	Grid 3 169.8 M4
Grid 4 85.6 M4	Grid 5 88.4 M4	Grid 6 87.0 M4
Grid 7 159.1 M4	Grid 8 164.2 M4	Grid 9 161.1 M4

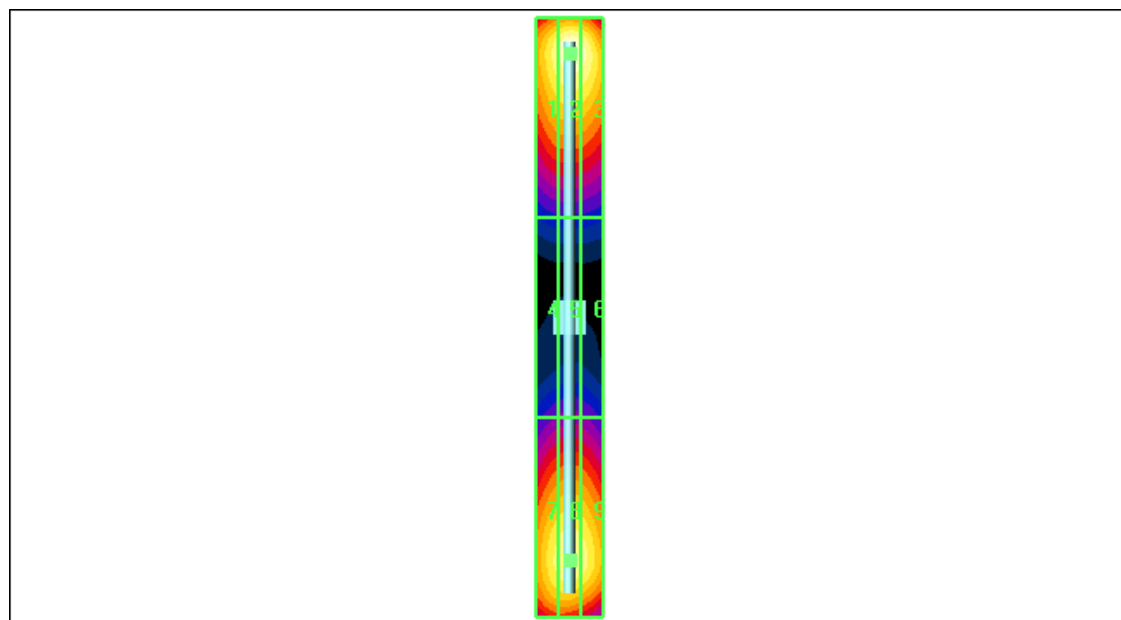
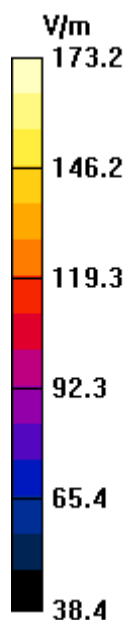

Date/Time: 7/5/2011 7:40:50 PM

Test Laboratory: Motorola - Jul-05-2011 E-Field 898 MHz

DUT: HAC-Dipole 898 MHz; Type: CD835V3; Serial: 1076; FCC ID: IHDP56MH1

Procedure Notes: 898 MHz HAC Validation; Dipole Sn# 1076; Input Power = 100 mW

Communication System: CW - HAC; Frequency: 898 MHz; Duty Cycle: 1:1

Medium: Air; Medium parameters used: $\sigma = 0$ mho/m, $\epsilon_r = 1$; $\rho = 0$ kg/m³

DASY4 Configuration:

- Probe: ER3DV6R - SN2248; ConvF(1, 1, 1); Calibrated: 4/15/2011
- Sensor-Surface: 0mm (Fix Surface)Sensor-Surface: (Fix Surface)
- Electronics: DAE4 Sn376; Calibrated: 7/13/2010
- Phantom: R-3, HAC Test Arch (rev.2); Type: SD HAC P01 BA; Serial: 1071;
- Measurement SW: DASY4, V4.7 Build 80; Postprocessing SW: SEMCAD, V1.8 Build 186

E Scan - Probe center 10mm above Dipole/Hearing Aid Compatibility Test (41x361x1):

Measurement grid: dx=5mm, dy=5mm; Probe Modulation Factor = 1.00

Device Reference Point: 0.000, 0.000, -6.30 mm; Reference Value = 110.5 V/m; Power Drift = -0.038 dB

Maximum value of Total (interpolated) = 158.2 V/m

Average value of Total (interpolated) = $(158.2 + 153.0) / 2 = 155.6$ V/m

Peak E-field in V/m

Grid 1 149.7 M4	Grid 2 158.2 M4	Grid 3 155.1 M4
Grid 4 74.0 M4	Grid 5 76.4 M4	Grid 6 75.3 M4
Grid 7 148.7 M4	Grid 8 153.0 M4	Grid 9 149.9 M4

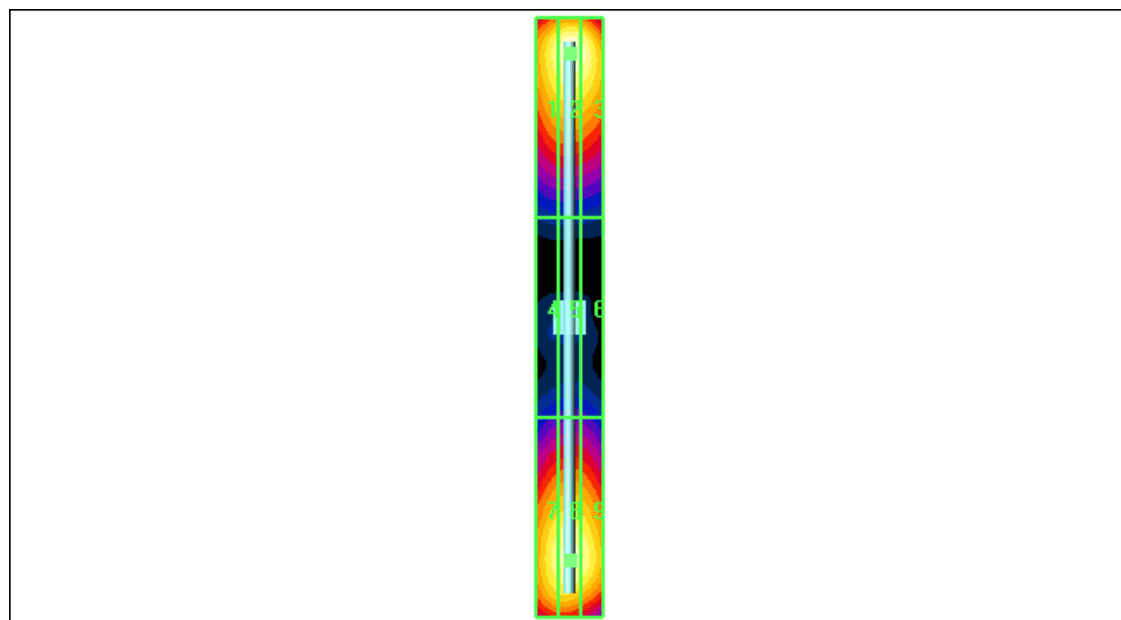
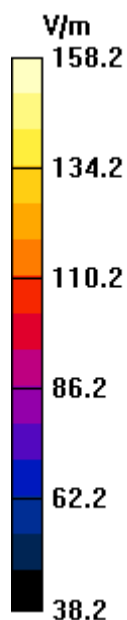

Date/Time: 7/5/2011 4:51:22 PM

Test Laboratory: Motorola - Jul-05-2011 H-Field 835 MHz

DUT: HAC-Dipole 835 MHz; Type: CD835V3; Serial: 1076; FCC ID: IHDP56MH1

Procedure Notes: 835 MHz HAC Validation; Dipole Sn# 1076; Input Power = 100 mW

Communication System: CW - HAC; Frequency: 835 MHz; Duty Cycle: 1:1

Medium: Air; Medium parameters used: $\sigma = 0$ mho/m, $\epsilon_r = 1$; $\rho = 0$ kg/m³

DASY4 Configuration:

- Probe: H3DV6 - SN6074; ; Calibrated: 4/11/2011
- Sensor-Surface: 0mm (Fix Surface)Sensor-Surface: (Fix Surface)
- Electronics: DAE4 Sn661; Calibrated: 1/13/2011
- Phantom: R-3, HAC Test Arch (rev.2); Type: SD HAC P01 BA; Serial: 1071;
- Measurement SW: DASY4, V4.7 Build 80; Postprocessing SW: SEMCAD, V1.8 Build 186

H Scan - Probe center 10mm above Dipole/Hearing Aid Compatibility Test (41x361x1):

Measurement grid: dx=5mm, dy=5mm; Probe Modulation Factor = 1.00

Device Reference Point: 0.000, 0.000, -6.30 mm; Reference Value = 0.476 A/m; Power Drift = 0.032 dB

Maximum value of Total (interpolated) = 0.450 A/m

Peak H-field in A/m

Grid 1 0.391 M4	Grid 2 0.406 M4	Grid 3 0.390 M4
Grid 4 0.426 M4	Grid 5 0.450 M4	Grid 6 0.433 M4
Grid 7 0.373 M4	Grid 8 0.395 M4	Grid 9 0.384 M4

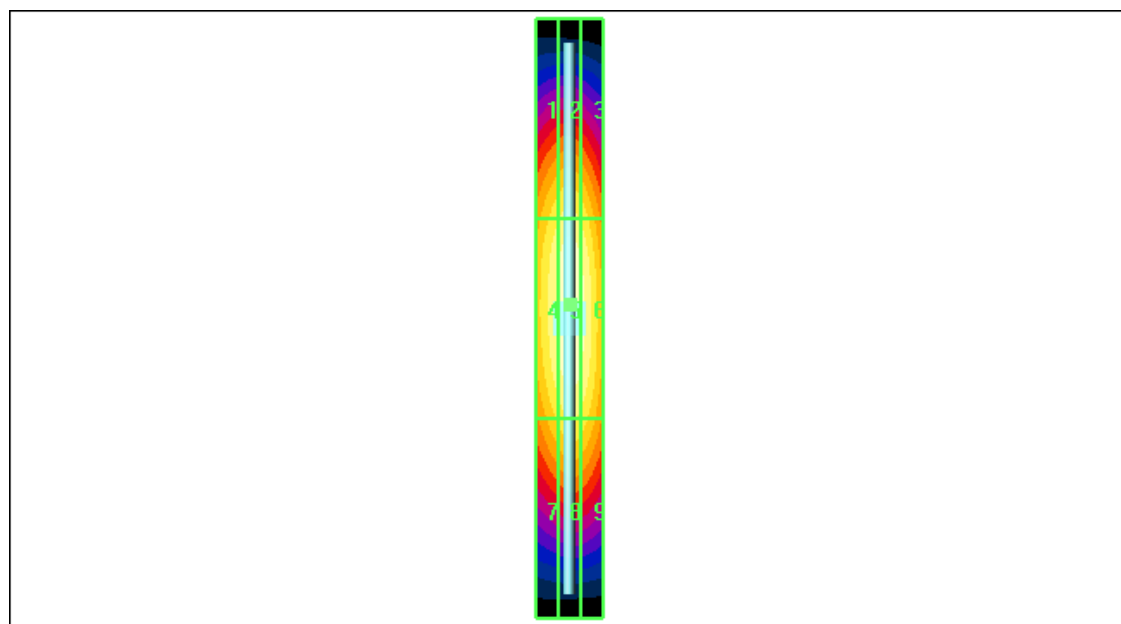
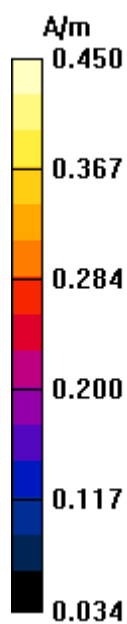

Date/Time: 7/5/2011 5:11:13 PM

Test Laboratory: Motorola - Jul-05-2011 H-Field 898 MHz

DUT: HAC-Dipole 898 MHz; Type: CD835V3; Serial: 1076; FCC ID: IHDP56MH1

Procedure Notes: 898 MHz HAC Validation; Dipole Sn# 1076; Input Power = 100 mW

Communication System: CW - HAC; Frequency: 898 MHz; Duty Cycle: 1:1

Medium: Air; Medium parameters used: $\sigma = 0$ mho/m, $\epsilon_r = 1$; $\rho = 0$ kg/m³

DASY4 Configuration:

- Probe: H3DV6 - SN6074; ; Calibrated: 4/11/2011
- Sensor-Surface: 0mm (Fix Surface)Sensor-Surface: (Fix Surface)
- Electronics: DAE4 Sn661; Calibrated: 1/13/2011
- Phantom: R-3, HAC Test Arch (rev.2); Type: SD HAC P01 BA; Serial: 1071;
- Measurement SW: DASY4, V4.7 Build 80; Postprocessing SW: SEMCAD, V1.8 Build 186

H Scan - Probe center 10mm above Dipole/Hearing Aid Compatibility Test (41x361x1):

Measurement grid: dx=5mm, dy=5mm; Probe Modulation Factor = 1.00

Device Reference Point: 0.000, 0.000, -6.30 mm; Reference Value = 0.433 A/m; Power Drift = 0.017 dB

Maximum value of Total (interpolated) = 0.416 A/m

Peak H-field in A/m

Grid 1 0.377 M4	Grid 2 0.391 M4	Grid 3 0.374 M4
Grid 4 0.395 M4	Grid 5 0.416 M4	Grid 6 0.399 M4
Grid 7 0.358 M4	Grid 8 0.378 M4	Grid 9 0.367 M4

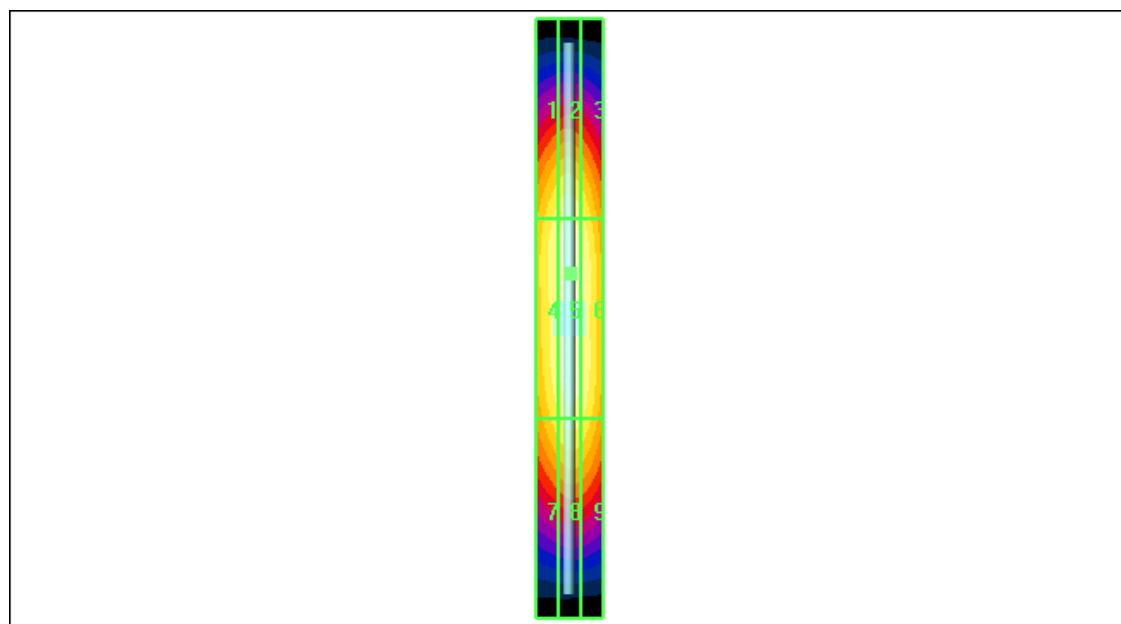
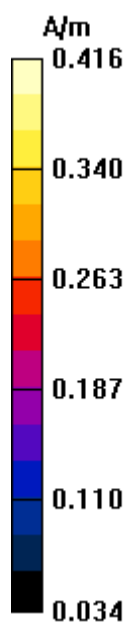

Appendix 3

HAC distribution plots for E-Field and H-Field

Date/Time: 7/5/2011 11:23:27 PM

Test Laboratory: Motorola - iDEN 800 E-Field, 2:6 Vocoder

Serial: 364VML0DQ3; FCC ID: IHDP56MH1

Procedure Notes: Pwr Step: N/A; Antenna Position: Internal; Accessory Model #: N/A
 Battery Model #: SNN5843A; Vocoder Rate: 2:6; Device Positioner: Polystyrene Block
 Communication System: iDEN 800; Frequency: 824.98 MHz; Duty Cycle: 1:3
 Medium: Air; Medium parameters used: $\sigma = 0$ mho/m, $\epsilon_r = 1$; $\rho = 0$ kg/m³

DASY4 Configuration:

- Probe: ER3DV6R - SN2248; ConvF(1, 1, 1); Calibrated: 4/15/2011
- Sensor-Surface: (Fix Surface)
- Electronics: DAE4 Sn376; Calibrated: 7/13/2010
- Phantom: R-3, HAC Test Arch (rev.2); Type: SD HAC P01 BA; Serial: 1071;
- Measurement SW: DASY4, V4.7 Build 80; Postprocessing SW: SEMCAD, V1.8 Build 186

E Scan - Sensor center 15mm above WD, Hearing Aid Compatibility Test (101x101x1):

Measurement grid: dx=5mm, dy=5mm

Maximum value of peak Total field = 240.0 V/m; Probe Modulation Factor = 3.51

Device Reference Point: 0.000, 0.000, -6.30 mm; Reference Value = 83.9 V/m; Power Drift = -0.121 dB

Hearing Aid Near-Field Category: M3 (AWF 0 dB)

Peak E-field in V/m

Grid 1 218.9 M3	Grid 2 237.5 M3	Grid 3 236.9 M3
Grid 4 216.0 M3	Grid 5 240.0 M3	Grid 6 238.5 M3
Grid 7 205.5 M3	Grid 8 228.2 M3	Grid 9 223.2 M3

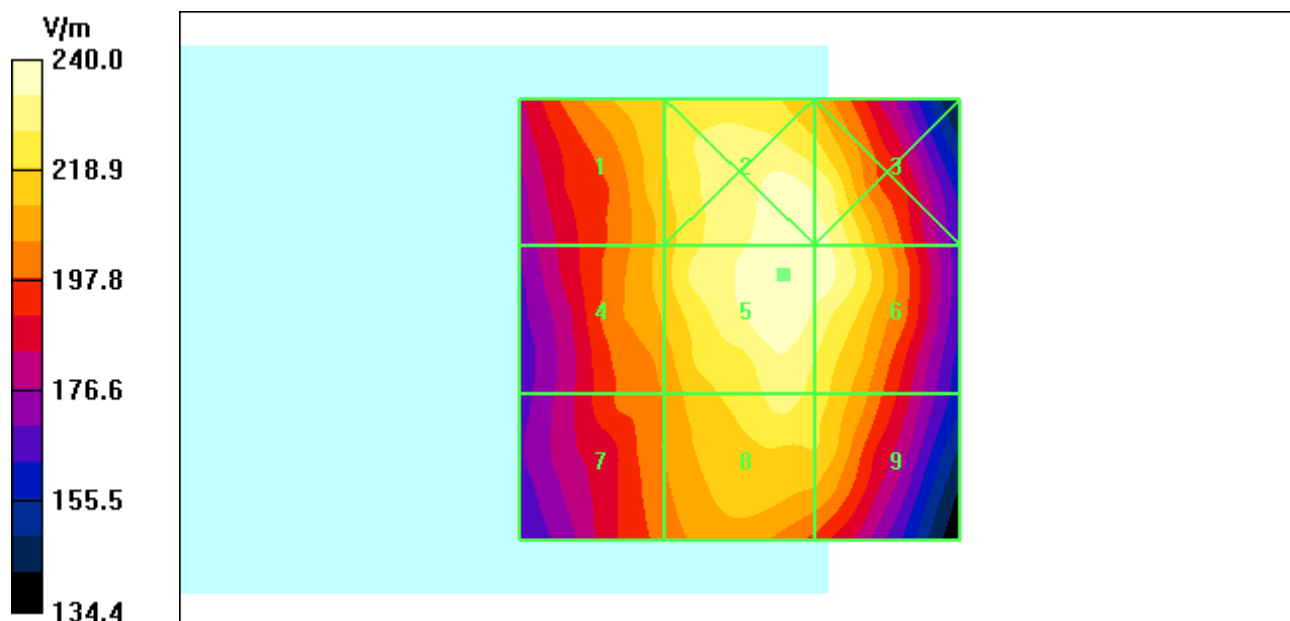

Date/Time: 7/6/2011 1:48:55 AM

Test Laboratory: Motorola - iDEN 900 E-Field, 2:6 Vocoder

Serial: 364VML0DQ3; FCC ID: IHDP56MH1

Procedure Notes: Pwr Step: N/A; Antenna Position: Internal; Accessory Model #: N/A
 Battery Model #: SNN5843A; Vocoder Rate: 2:6; Device Positioner: Polystyrene Block
 Communication System: iDEN 900; Frequency: 901.98 MHz; Duty Cycle: 1:3
 Medium: Air; Medium parameters used: $\sigma = 0$ mho/m, $\epsilon_r = 1$; $\rho = 0$ kg/m³

DASY4 Configuration:

- Probe: ER3DV6R - SN2248; ConvF(1, 1, 1); Calibrated: 4/15/2011
- Sensor-Surface: (Fix Surface)
- Electronics: DAE4 Sn376; Calibrated: 7/13/2010
- Phantom: R-3, HAC Test Arch (rev.2); Type: SD HAC P01 BA; Serial: 1071;
- Measurement SW: DASY4, V4.7 Build 80; Postprocessing SW: SEMCAD, V1.8 Build 186

E Scan - Sensor center 15mm above WD, Hearing Aid Compatibility Test (101x101x1):

Measurement grid: dx=5mm, dy=5mm

Maximum value of peak Total field = 222.1 V/m; Probe Modulation Factor = 3.44

Device Reference Point: 0.000, 0.000, -6.30 mm; Reference Value = 78.4 V/m; Power Drift = 0.101 dB

Hearing Aid Near-Field Category: M3 (AWF 0 dB)

Peak E-field in V/m

Grid 1 203.8 M3	Grid 2 222.2 M3	Grid 3 222.3 M3
Grid 4 197.2 M4	Grid 5 222.1 M3	Grid 6 222.0 M3
Grid 7 186.5 M4	Grid 8 212.0 M3	Grid 9 211.6 M3

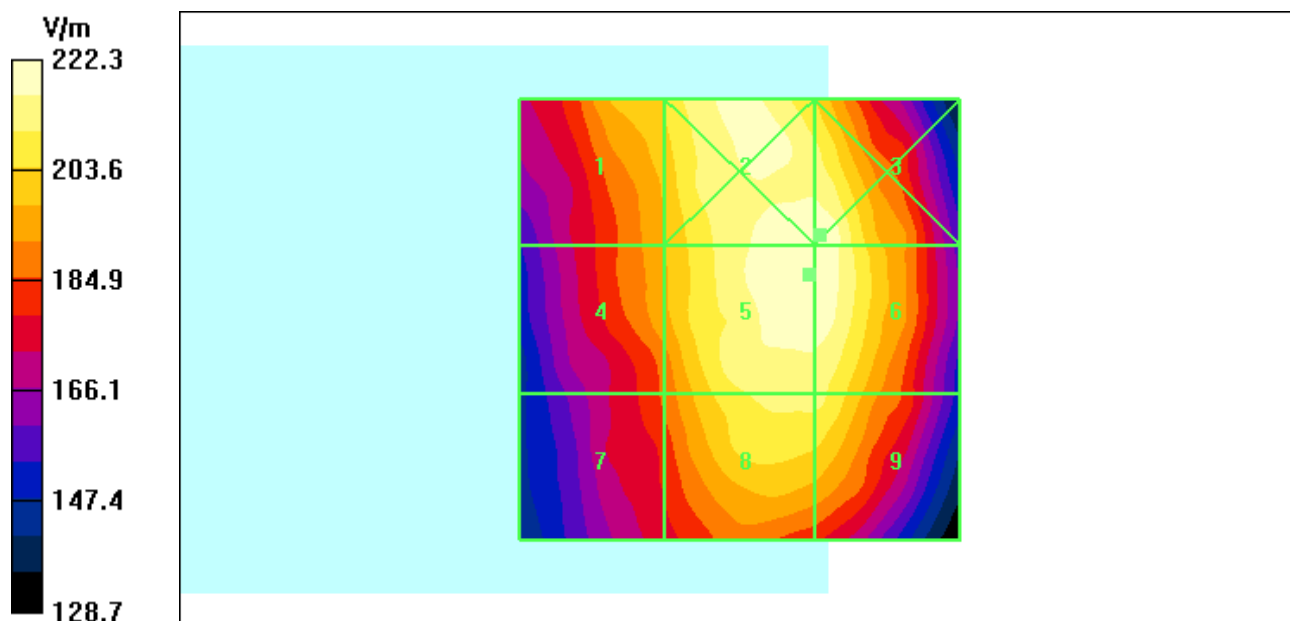

Date/Time: 7/6/2011 12:15:10 AM

Test Laboratory: Motorola - iDEN 800 E-Field, 1:6 Vocoder

Serial: 364VML0DQ3; FCC ID: IHDP56MH1

Procedure Notes: Pwr Step: N/A; Antenna Position: Internal; Accessory Model #: N/A
 Battery Model #: SNN5843A; Vocoder Rate: 1:6; Device Positioner: Polystyrene Block
 Communication System: iDEN 800; Frequency: 824.98 MHz; Duty Cycle: 1:6
 Medium: Air; Medium parameters used: $\sigma = 0$ mho/m, $\epsilon_r = 1$; $\rho = 0$ kg/m³

DASY4 Configuration:

- Probe: ER3DV6R - SN2248; ConvF(1, 1, 1); Calibrated: 4/15/2011
- Sensor-Surface: (Fix Surface)
- Electronics: DAE4 Sn376; Calibrated: 7/13/2010
- Phantom: R-3, HAC Test Arch (rev.2); Type: SD HAC P01 BA; Serial: 1071;
- Measurement SW: DASY4, V4.7 Build 80; Postprocessing SW: SEMCAD, V1.8 Build 186

E Scan - Sensor center 15mm above WD, Hearing Aid Compatibility Test (101x101x1):

Measurement grid: dx=5mm, dy=5mm

Maximum value of peak Total field = 247.0 V/m; Probe Modulation Factor = 5.03

Device Reference Point: 0.000, 0.000, -6.30 mm; Reference Value = 58.6 V/m; Power Drift = 0.035 dB

Hearing Aid Near-Field Category: M3 (AWF 0 dB)

Peak E-field in V/m

Grid 1 227.2 M3	Grid 2 247.7 M3	Grid 3 239.4 M3
Grid 4 216.2 M3	Grid 5 247.0 M3	Grid 6 243.3 M3
Grid 7 205.4 M3	Grid 8 231.5 M3	Grid 9 231.5 M3

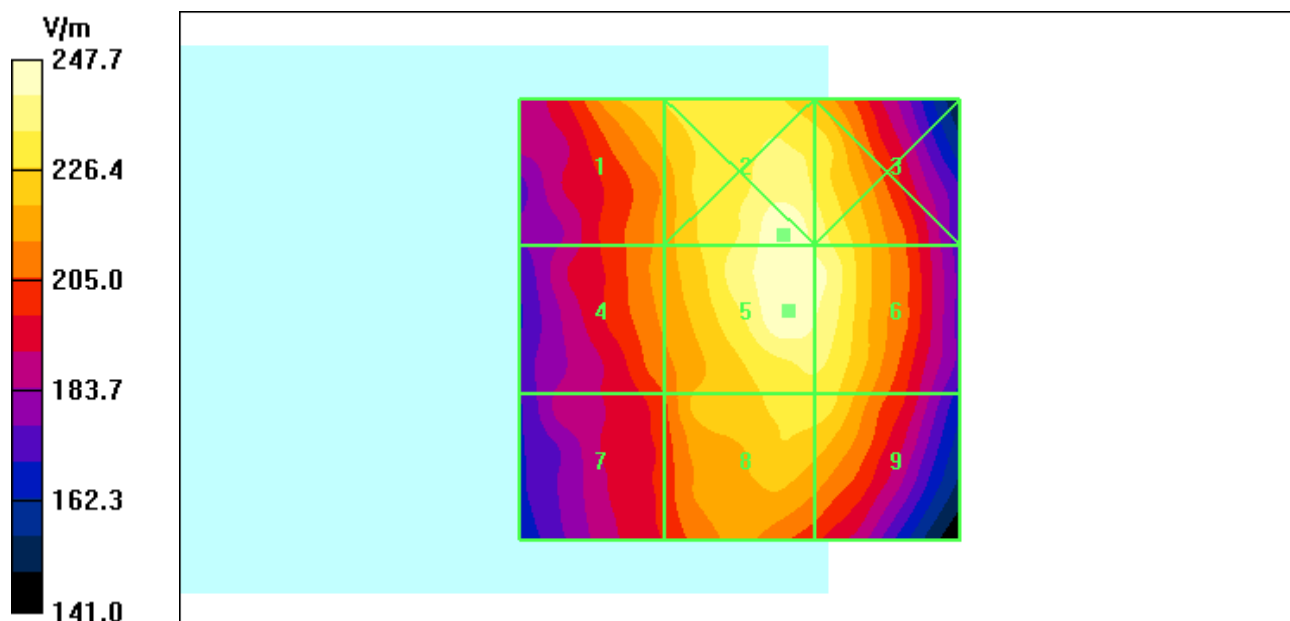

Date/Time: 7/6/2011 1:07:57 AM

Test Laboratory: Motorola - iDEN 900 E-Field, 1:6 Vocoder

Serial: 364VML0DQ3; FCC ID: IHDP56MH1

Procedure Notes: Pwr Step: N/A; Antenna Position: Internal; Accessory Model #: N/A
 Battery Model #: SNN5843A; Vocoder Rate: 1:6; Device Positioner: Polystyrene Block
 Communication System: iDEN 900; Frequency: 901.98 MHz; Duty Cycle: 1:6
 Medium: Air; Medium parameters used: $\sigma = 0$ mho/m, $\epsilon_r = 1$; $\rho = 0$ kg/m³

DASY4 Configuration:

- Probe: ER3DV6R - SN2248; ConvF(1, 1, 1); Calibrated: 4/15/2011
- Sensor-Surface: (Fix Surface)
- Electronics: DAE4 Sn376; Calibrated: 7/13/2010
- Phantom: R-3, HAC Test Arch (rev.2); Type: SD HAC P01 BA; Serial: 1071;
- Measurement SW: DASY4, V4.7 Build 80; Postprocessing SW: SEMCAD, V1.8 Build 186

E Scan - Sensor center 15mm above WD, Hearing Aid Compatibility Test (101x101x1):

Measurement grid: dx=5mm, dy=5mm

Maximum value of peak Total field = 221.4 V/m; Probe Modulation Factor = 4.84

Device Reference Point: 0.000, 0.000, -6.30 mm; Reference Value = 54.2 V/m; Power Drift = 0.108 dB

Hearing Aid Near-Field Category: M3 (AWF 0 dB)

Peak E-field in V/m

Grid 1 201.9 M3	Grid 2 220.6 M3	Grid 3 220.2 M3
Grid 4 197.3 M4	Grid 5 221.4 M3	Grid 6 219.8 M3
Grid 7 182.7 M4	Grid 8 211.1 M3	Grid 9 207.8 M3

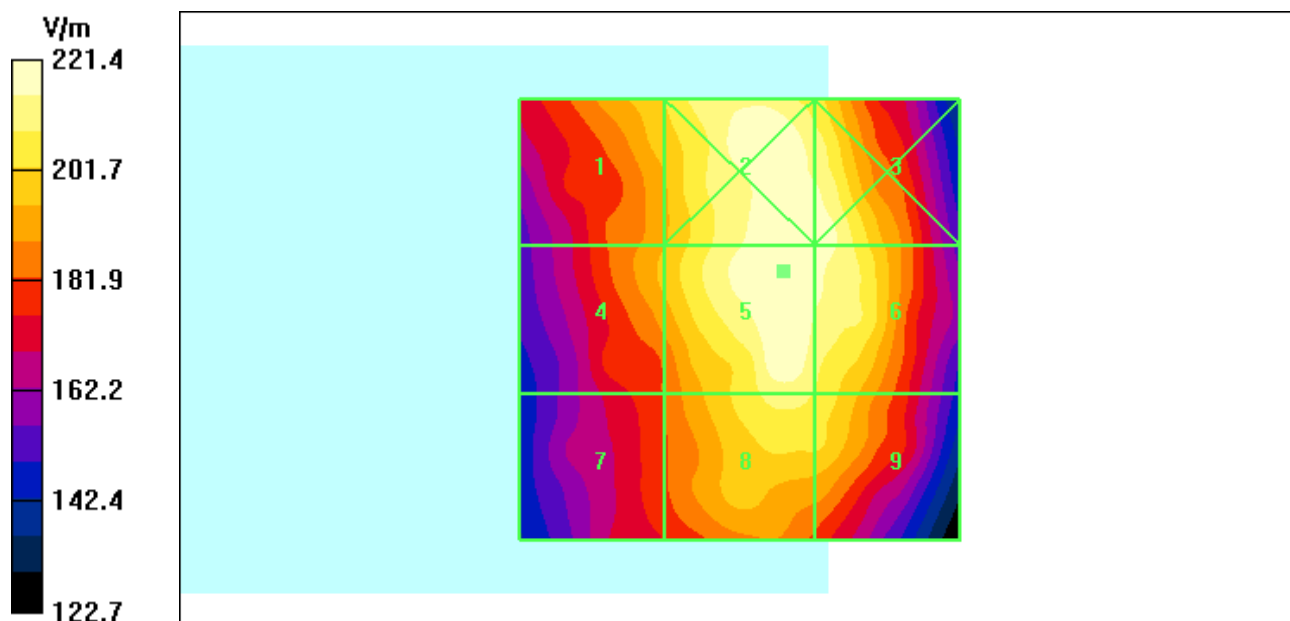

Date/Time: 7/6/2011 9:39:06 AM

Test Laboratory: Motorola - iDEN 800 H-Field, 2:6 Vocoder

Serial: 364VML0DQ3; FCC ID: IHDP56MH1

Procedure Notes: Pwr Step: N/A; Antenna Position: Internal; Accessory Model #: N/A
 Battery Model #: SNN5843A; Vocoder Rate: 2:6; Device Positioner: Polystyrene Block
 Communication System: iDEN 800; Frequency: 815.51 MHz; Duty Cycle: 1:3
 Medium: Air; Medium parameters used: $\sigma = 0$ mho/m, $\epsilon_r = 1$; $\rho = 0$ kg/m³

DASY4 Configuration:

- Probe: H3DV6 - SN6074; ; Calibrated: 4/11/2011
- Sensor-Surface: (Fix Surface)
- Electronics: DAE4 Sn661; Calibrated: 1/13/2011
- Phantom: R-3, HAC Test Arch (rev.2); Type: SD HAC P01 BA; Serial: 1071;
- Measurement SW: DASY4, V4.7 Build 80; Postprocessing SW: SEMCAD, V1.8 Build 186

H Scan - Sensor center 15mm above WD, Hearing Aid Compatibility Test (101x101x1):

Measurement grid: dx=5mm, dy=5mm

Maximum value of peak Total field = 0.264 A/m; Probe Modulation Factor = 3.00

Device Reference Point: 0.000, 0.000, -6.30 mm; Reference Value = 0.066 A/m; Power Drift = -0.018 dB

Hearing Aid Near-Field Category: M4 (AWF 0 dB)

Peak H-field in A/m

Grid 1 0.343 M4	Grid 2 0.247 M4	Grid 3 0.146 M4
Grid 4 0.343 M4	Grid 5 0.248 M4	Grid 6 0.143 M4
Grid 7 0.362 M4	Grid 8 0.264 M4	Grid 9 0.151 M4

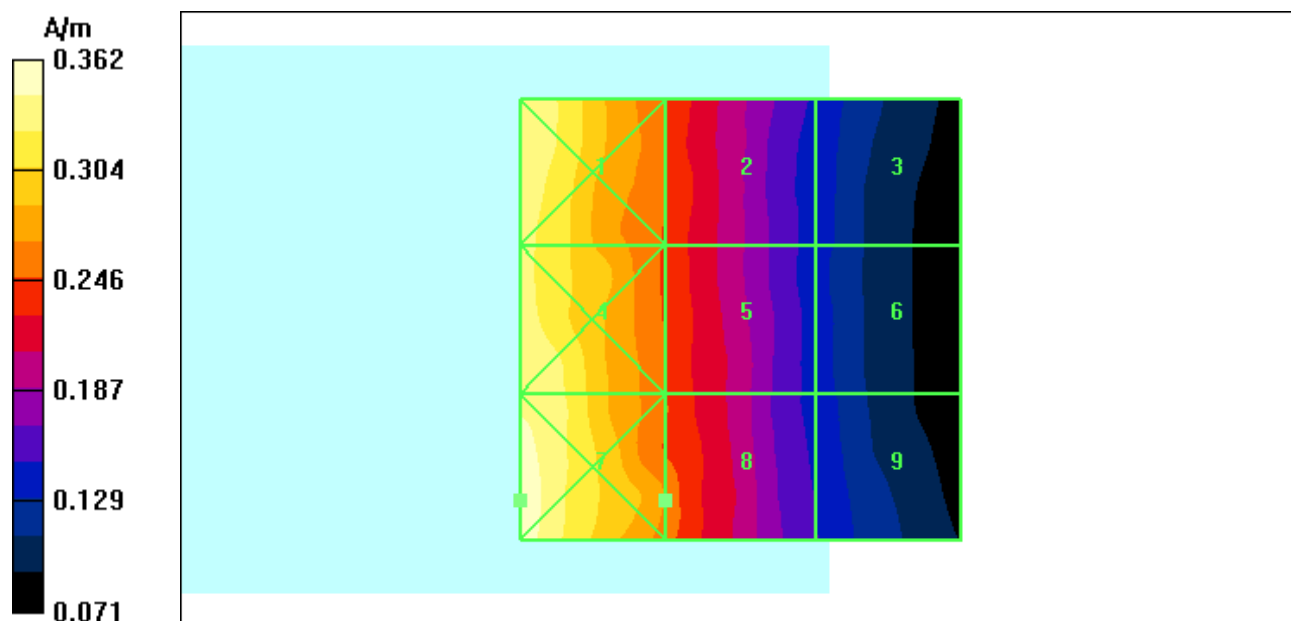

Date/Time: 7/6/2011 1:19:05 PM

Test Laboratory: Motorola - iDEN 900 H-Field, 2:6 Vocoder

Serial: 364VML0DQ3; FCC ID: IHDP56MH1

Procedure Notes: Pwr Step: N/A; Antenna Position: Internal; Accessory Model #: N/A
 Battery Model #: SNN5843A; Vocoder Rate: 2:6; Device Positioner: Polystyrene Block
 Communication System: iDEN 900; Frequency: 901.98 MHz; Duty Cycle: 1:3
 Medium: Air; Medium parameters used: $\sigma = 0$ mho/m, $\epsilon_r = 1$; $\rho = 0$ kg/m³

DASY4 Configuration:

- Probe: H3DV6 - SN6074; ; Calibrated: 4/11/2011
- Sensor-Surface: (Fix Surface)
- Electronics: DAE4 Sn661; Calibrated: 1/13/2011
- Phantom: R-3, HAC Test Arch (rev.2); Type: SD HAC P01 BA; Serial: 1071;
- Measurement SW: DASY4, V4.7 Build 80; Postprocessing SW: SEMCAD, V1.8 Build 186

H Scan - Sensor center 15mm above WD, Hearing Aid Compatibility Test (101x101x1):

Measurement grid: dx=5mm, dy=5mm

Maximum value of peak Total field = 0.313 A/m; Probe Modulation Factor = 2.97

Device Reference Point: 0.000, 0.000, -6.30 mm; Reference Value = 0.083 A/m; Power Drift = -0.188 dB

Hearing Aid Near-Field Category: M4 (AWF 0 dB)

Peak H-field in A/m

Grid 1 0.427 M4	Grid 2 0.313 M4	Grid 3 0.187 M4
Grid 4 0.419 M4	Grid 5 0.308 M4	Grid 6 0.176 M4
Grid 7 0.429 M4	Grid 8 0.309 M4	Grid 9 0.177 M4

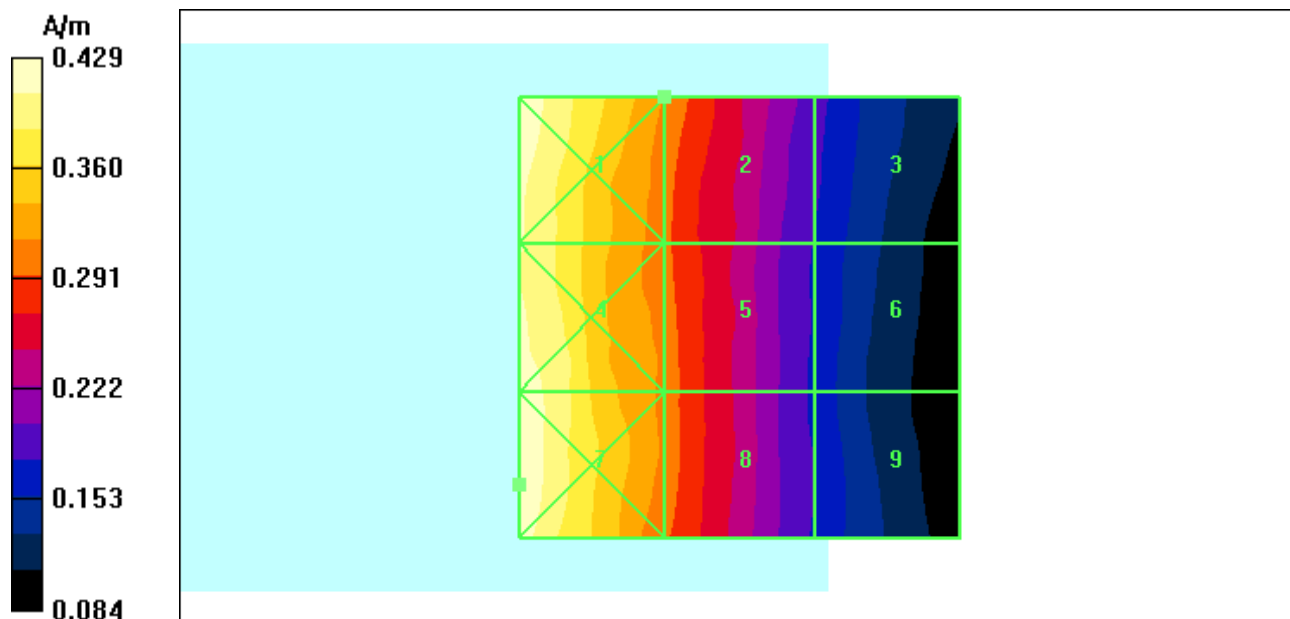

Date/Time: 7/6/2011 11:10:07 AM

Test Laboratory: Motorola - iDEN 800 H-Field, 1:6 Vocoder

Serial: 364VML0DQ3; FCC ID: IHDP56MH1

Procedure Notes: Pwr Step: N/A; Antenna Position: Internal; Accessory Model #: N/A
 Battery Model #: SNN5843A; Vocoder Rate: 1:6; Device Positioner: Polystyrene Block
 Communication System: iDEN 800; Frequency: 824.98 MHz; Duty Cycle: 1:6
 Medium: Air; Medium parameters used: $\sigma = 0$ mho/m, $\epsilon_r = 1$; $\rho = 0$ kg/m³

DASY4 Configuration:

- Probe: H3DV6 - SN6074; ; Calibrated: 4/11/2011
- Sensor-Surface: (Fix Surface)
- Electronics: DAE4 Sn661; Calibrated: 1/13/2011
- Phantom: R-3, HAC Test Arch (rev.2); Type: SD HAC P01 BA; Serial: 1071;
- Measurement SW: DASY4, V4.7 Build 80; Postprocessing SW: SEMCAD, V1.8 Build 186

H Scan - Sensor center 15mm above WD, Hearing Aid Compatibility Test (101x101x1):

Measurement grid: dx=5mm, dy=5mm

Maximum value of peak Total field = 0.284 A/m; Probe Modulation Factor = 4.25

Device Reference Point: 0.000, 0.000, -6.30 mm; Reference Value = 0.052 A/m; Power Drift = -0.066 dB

Hearing Aid Near-Field Category: M4 (AWF 0 dB)

Peak H-field in A/m

Grid 1 0.393 M4	Grid 2 0.277 M4	Grid 3 0.163 M4
Grid 4 0.387 M4	Grid 5 0.276 M4	Grid 6 0.152 M4
Grid 7 0.409 M4	Grid 8 0.284 M4	Grid 9 0.166 M4

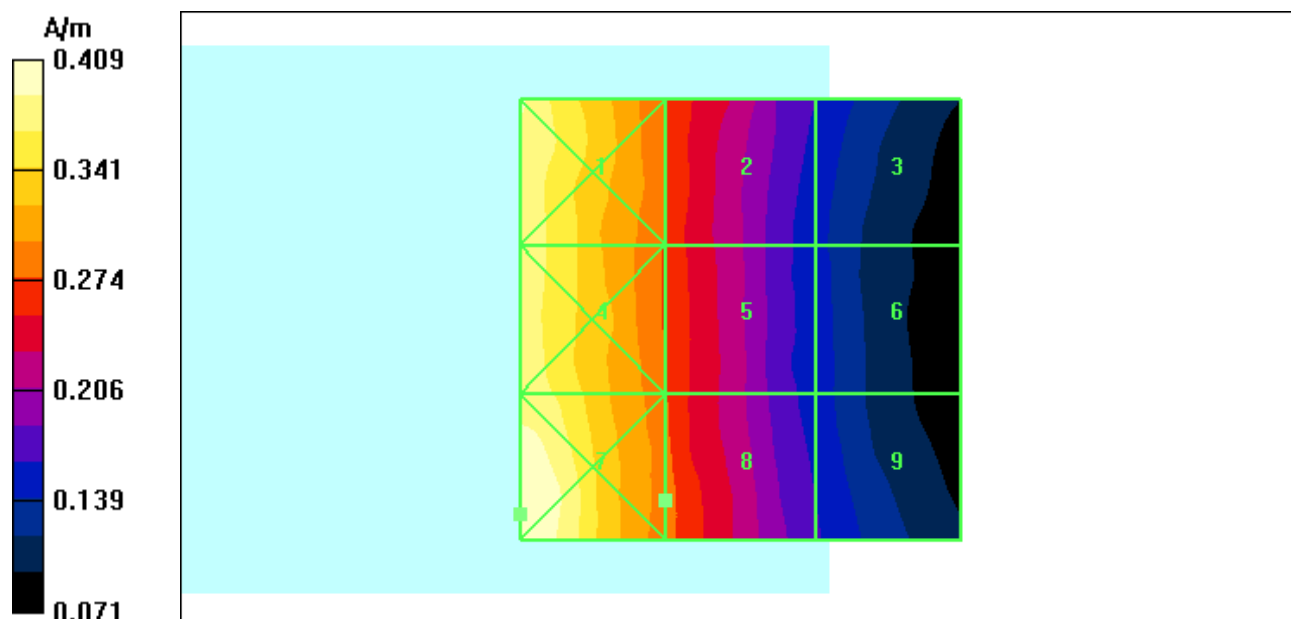

Date/Time: 7/6/2011 1:49:44 PM

Test Laboratory: Motorola - iDEN 900 H-Field, 1:6 Vocoder

Serial: 364VML0DQ3; FCC ID: IHDP56MH1

Procedure Notes: Pwr Step: N/A; Antenna Position: Internal; Accessory Model #: N/A

Battery Model #: SNN5843A; Vocoder Rate: 1:6; Device Positioner: Polystyrene Block

Communication System: iDEN 900; Frequency: 901.98 MHz; Duty Cycle: 1:6

Medium: Air; Medium parameters used: $\sigma = 0$ mho/m, $\epsilon_r = 1$; $\rho = 0$ kg/m³

DASY4 Configuration:

- Probe: H3DV6 - SN6074; ; Calibrated: 4/11/2011
- Sensor-Surface: (Fix Surface)
- Electronics: DAE4 Sn661; Calibrated: 1/13/2011
- Phantom: R-3, HAC Test Arch (rev.2); Type: SD HAC P01 BA; Serial: 1071;
- Measurement SW: DASY4, V4.7 Build 80; Postprocessing SW: SEMCAD, V1.8 Build 186

H Scan - Sensor center 15mm above WD, Hearing Aid Compatibility Test (101x101x1):

Measurement grid: dx=5mm, dy=5mm

Maximum value of peak Total field = 0.317 A/m; Probe Modulation Factor = 4.22

Device Reference Point: 0.000, 0.000, -6.30 mm; Reference Value = 0.060 A/m; Power Drift = -0.188 dB

Hearing Aid Near-Field Category: M4 (AWF 0 dB)

Peak H-field in A/m

Grid 1 0.420 M4	Grid 2 0.317 M4	Grid 3 0.197 M4
Grid 4 0.427 M4	Grid 5 0.313 M4	Grid 6 0.186 M4
Grid 7 0.429 M4	Grid 8 0.312 M4	Grid 9 0.177 M4

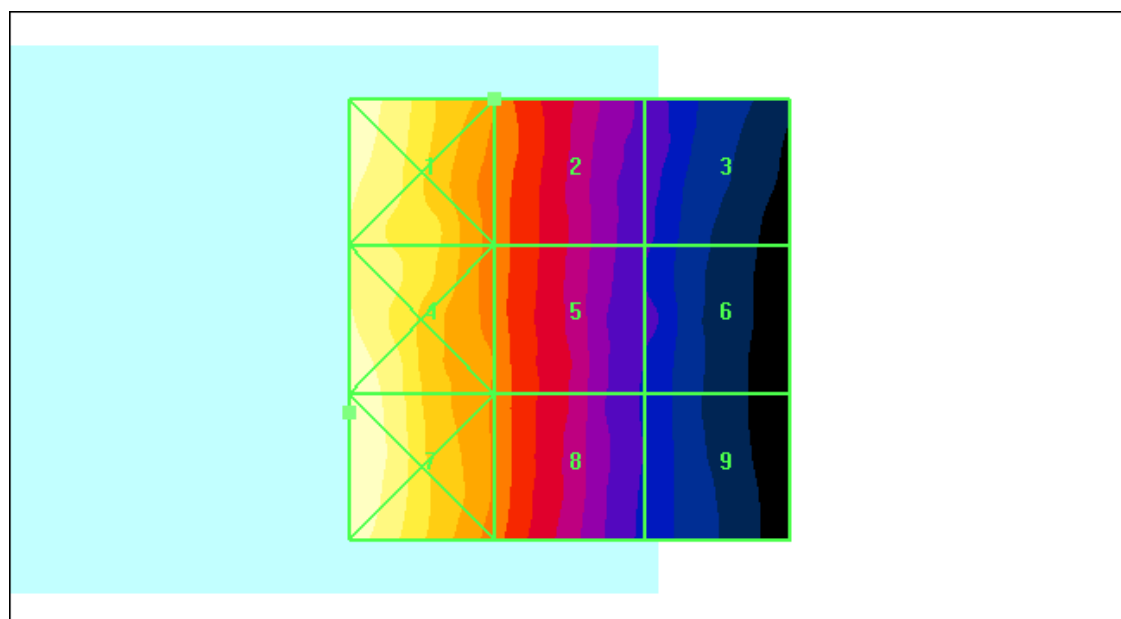
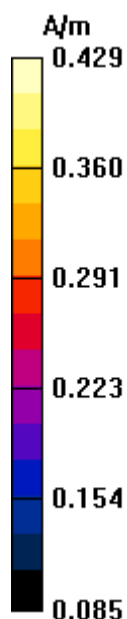

Appendix 4

Measurement Uncertainty Budget

A4.1 Motorola Uncertainty Budget for RF HAC Testing

TABLE A4.1: Motorola Uncertainty Budget

UNCERTAINTY DESCRIPTION	Uncertainty Value (± %)	Prob. Dist.	Div.	(ci) E	(ci) H	Std. Unc. E	Std. Unc. H
MEASUREMENT SYSTEM							
Probe Calibration	5.1%	N	1.0000	1	1	5.1%	5.1%
Axial Isotropy	7.8%	R	1.7321	1	0.786	4.5%	3.5%
Sensor Displacement	16.5%	R	1.7321	1	0.145	9.5%	1.4%
Test Arch	7.2%	R	1.7321	1	0	4.2%	0.0%
Linearity	4.7%	R	1.7321	1	1	2.7%	2.7%
Scaling to Peak Envelope Power	2.0%	R	1.7321	1	1	1.2%	1.2%
System Detection Limit	1.0%	R	1.7321	1	1	0.6%	0.6%
Readout Electronics	0.3%	N	1.0000	1	1	0.3%	0.3%
Response Time	0.8%	R	1.7321	1	1	0.5%	0.5%
Integration Time	2.6%	R	1.7321	1	1	1.5%	1.5%
RF Reflections	5.6%	R	1.7321	1	1	3.2%	3.2%
Probe Positioner	1.2%	R	1.7321	1	0.67	0.7%	0.5%
Probe Positioning	4.7%	R	1.7321	1	0.67	2.7%	1.8%
Extrap. & Interpolation	1.0%	R	1.7321	1	1	0.6%	0.6%
TEST SAMPLE RELATED							
Total Device Positioning	3.2%	R	1.7321	1	1.306	1.8%	2.4%
Device Holder & Phantom	2.4%	R	1.7321	1	1	1.4%	1.4%
Power Drift	5.0%	R	1.7321	1	1	2.9%	2.9%
PHANTOM AND SETUP RELATED							
Phantom Thickness	2.4%	R	1.7321	1	0.67	1.4%	0.9%
Combined Std.Uncertainty on Power						14.1%	9.1%
Combined Std.Uncertainty on Field						7.1%	4.6%
Expanded Std. Uncertainty on Power						28.3%	18.2%
Expanded Std. Uncertainty on Field						14.1%	9.1%

A4.2 Probe Rotation Contributions to Isotropy Error

Probe rotation data was taken “for special focus on spherical isotropicity in measurement uncertainty and perturbation of EM fields.” This data was taken at the interpolated maximum and directly accounted for in the uncertainty budget as “Axial Isotropy.” Thirteen mobile devices were used to determine the probe isotropy uncertainty factors in section A4.1. Based on the resulting 82 E-Field probe rotations and 82 H-Field probe rotations, the upper 95% confidence interval value was calculated for each. These values represent a conservative assessment of the effect of the probe isotropy and have been appropriately included in the respective E- and H-uncertainty budgets.

TABLE A4.2: Probe Rotation Data Summary

	AVE	ST. DEV	Sample Size (n)	2σ	(ci)	Standard Uncertainty
E-field	4.4%	1.7%	82	7.8%	1	4.5%
H-field	3.8%	1.2%	82	6.1%	0.786	3.5%

Isotropy error measurements were taken for 13 products across the respective frequency bands. The +2σ values of all measurements was used as a worst case value for the uncertainty budget. Any significant differences between bands were also evaluated.

Appendix 5

Pictures of Test Setup

See Exhibit 7B

Appendix 6

Probe Calibration Certificates



Accredited by the Swiss Accreditation Service (SAS)
The Swiss Accreditation Service is one of the signatories to the EA
Multilateral Agreement for the recognition of calibration certificates

Accreditation No.: **SCS 108**

Client **Motorola MDb**

Certificate No: **ER3-2248_Apr11**

CALIBRATION CERTIFICATE

Object **ER3DV6R - SN:2248**

Calibration procedure(s) **QA CAL-02.v6, QA CAL-25.v3
Calibration procedure for E-field probes optimized for close near field
evaluations in air**

Calibration date: **April 15, 2011**

This calibration certificate documents the traceability to national standards, which realize the physical units of measurements (SI).
The measurements and the uncertainties with confidence probability are given on the following pages and are part of the certificate.

All calibrations have been conducted in the closed laboratory facility: environment temperature (22 ± 3)°C and humidity < 70%.

Calibration Equipment used (M&TE critical for calibration)

Primary Standards	ID	Cal Date (Certificate No.)	Scheduled Calibration
Power meter E4419B	GB41293874	31-Mar-11 (No. 217-01372)	Apr-12
Power sensor E4412A	MY41495277	31-Mar-11 (No. 217-01372)	Apr-12
Power sensor E4412A	MY41498087	31-Mar-11 (No. 217-01372)	Apr-12
Reference 3 dB Attenuator	SN: S5054 (3c)	29-Mar-11 (No. 217-01369)	Apr-12
Reference 20 dB Attenuator	SN: S5086 (20b)	29-Mar-11 (No. 217-01367)	Apr-12
Reference 30 dB Attenuator	SN: S5129 (30b)	29-Mar-11 (No. 217-01370)	Apr-12
Reference Probe ER3DV6	SN: 2328	4-Oct-10 (No. ER3-2328_Oct10)	Oct-11
DAE4	SN: 789	16-Feb-11 (No. DAE4-789_Feb11)	Feb-12
Secondary Standards	ID	Check Date (in house)	Scheduled Check
RF generator HP 8648C	US3642U01700	4-Aug-99 (in house check Oct-09)	In house check: Oct-11
Network Analyzer HP 8753E	US37390585	18-Oct-01 (in house check Oct-10)	In house check: Oct-11

	Name	Function	Signature
Calibrated by:	Dimce Iliev	Laboratory Technician	
Approved by:	Katja Pokovic	Technical Manager	

Issued: April 18, 2011

This calibration certificate shall not be reproduced except in full without written approval of the laboratory.



Accredited by the Swiss Accreditation Service (SAS)
The Swiss Accreditation Service is one of the signatories to the EA
Multilateral Agreement for the recognition of calibration certificates

Accreditation No.: **SCS 108**

Glossary:

NORM _{x,y,z}	sensitivity in free space
DCP	diode compression point
CF	crest factor (1/duty_cycle) of the RF signal
A, B, C	modulation dependent linearization parameters
Polarization φ	φ rotation around probe axis
Polarization ϑ	ϑ rotation around an axis that is in the plane normal to probe axis (at measurement center), i.e., $\vartheta = 0$ is normal to probe axis
Connector Angle	information used in DASY system to align probe sensor X to the robot coordinate system

Calibration is Performed According to the Following Standards:

- IEEE Std 1309-2005, "IEEE Standard for calibration of electromagnetic field sensors and probes, excluding antennas, from 9 kHz to 40 GHz", December 2005.

Methods Applied and Interpretation of Parameters:

- NORM_{x,y,z}*: Assessed for E-field polarization $\vartheta = 0$ for XY sensors and $\vartheta = 90$ for Z sensor ($f \leq 900$ MHz in TEM-cell; $f > 1800$ MHz: R22 waveguide).
- NORM(f)_{x,y,z}* = *NORM_{x,y,z}* * *frequency_response* (see Frequency Response Chart).
- DCP_{x,y,z}*: DCP are numerical linearization parameters assessed based on the data of power sweep with CW signal (no uncertainty required). DCP does not depend on frequency nor media.
- A_{x,y,z}; B_{x,y,z}; C_{x,y,z}; VR_{x,y,z}*: *A, B, C* are numerical linearization parameters assessed based on the data of power sweep for specific modulation signal. The parameters do not depend on frequency nor media. *VR* is the maximum calibration range expressed in RMS voltage across the diode.
- Spherical isotropy (3D deviation from isotropy)*: in a locally homogeneous field realized using an open waveguide setup.
- Sensor Offset*: The sensor offset corresponds to the offset of virtual measurement center from the probe tip (on probe axis). No tolerance required.
- Connector Angle*: The angle is assessed using the information gained by determining the *NORM_x* (no uncertainty required).

Probe ER3DV6R

SN:2248

Manufactured: January 1, 2000
Calibrated: April 15, 2011

Calibrated for DASYS/EASY Systems
(Note: non-compatible with DASYS2 system!)

DASY/EASY - Parameters of Probe: ER3DV6R - SN:2248

Basic Calibration Parameters

	Sensor X	Sensor Y	Sensor Z	Unc (k=2)
Norm ($\mu\text{V}/(\text{V}/\text{m})^2$)	2.04	2.04	2.11	$\pm 10.1 \%$
DCP (mV) ^B	99.5	97.6	99.6	

Modulation Calibration Parameters

UID	Communication System Name	PAR		A dB	B dB	C dB	VR mV	Unc ^E (k=2)
10000	CW	0.00	X	0.00	0.00	1.00	100.5	$\pm 2.5 \%$
			Y	0.00	0.00	1.00	95.9	
			Z	0.00	0.00	1.00	89.2	

The reported uncertainty of measurement is stated as the standard uncertainty of measurement multiplied by the coverage factor $k=2$, which for a normal distribution corresponds to a coverage probability of approximately 95%.

^B Numerical linearization parameter: uncertainty not required.

^E Uncertainty is determined using the max. deviation from linear response applying rectangular distribution and is expressed for the square of the field value.

Frequency Response of E-Field (TEM-Cell:ifi110 EXX, Waveguide: R22)

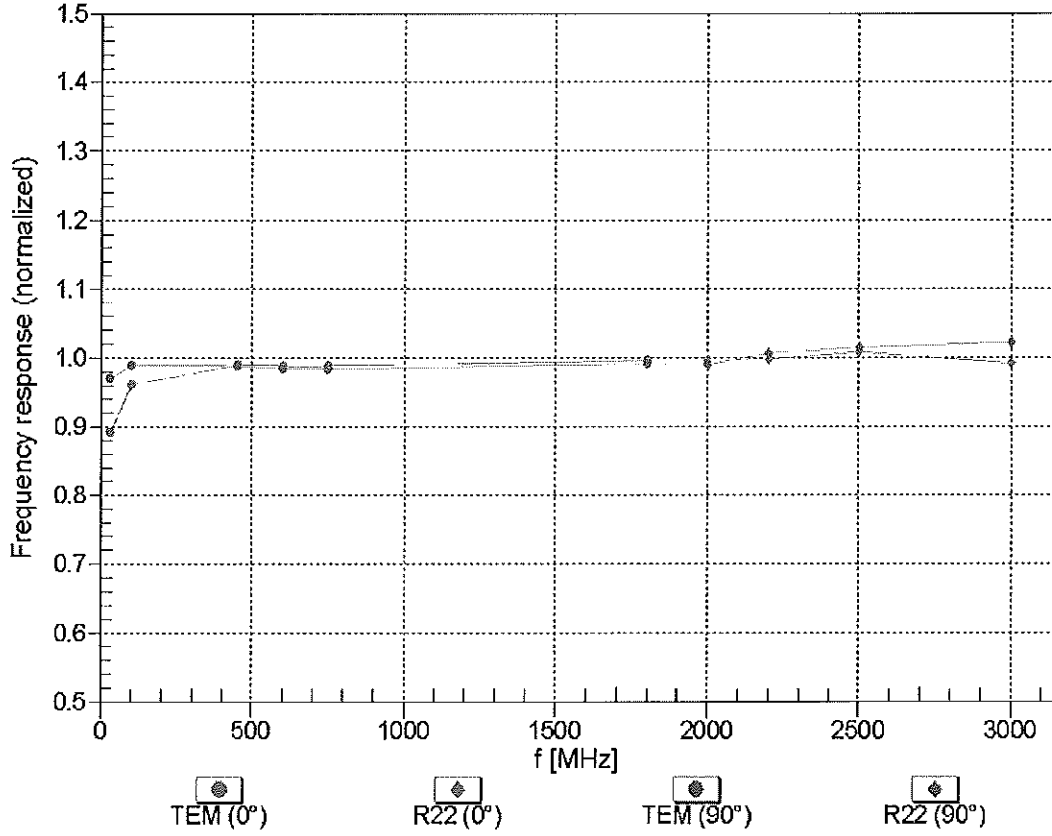

Uncertainty of Frequency Response of E-field: $\pm 6.3\%$ (k=2)

Receiving Pattern (ϕ), $\vartheta = 0^\circ$

f=600 MHz, TEM, 0°

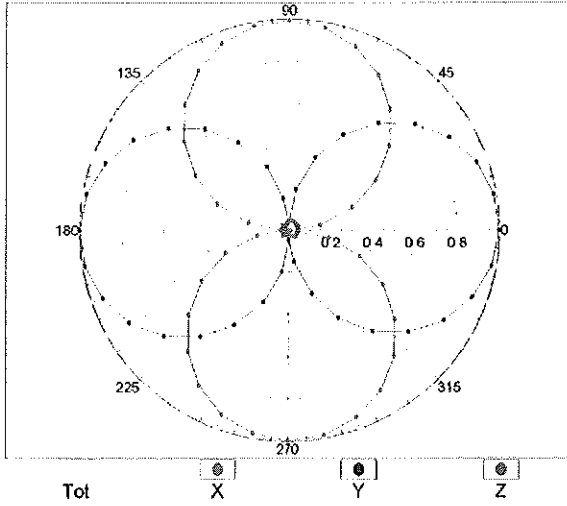

f=2500 MHz, R22, 0°

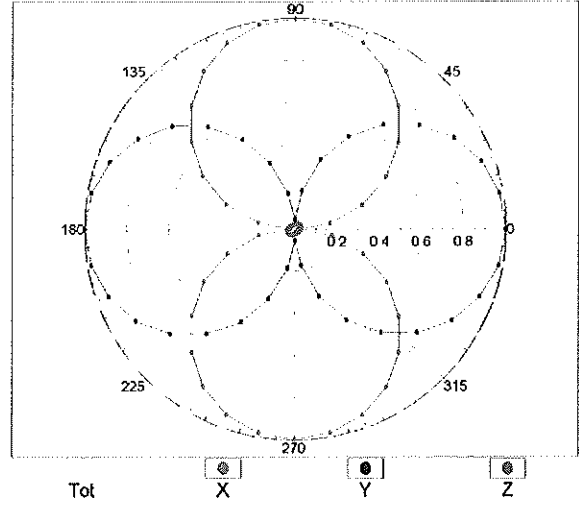

Receiving Pattern (ϕ), $\vartheta = 90^\circ$

f=600 MHz, TEM, 90°

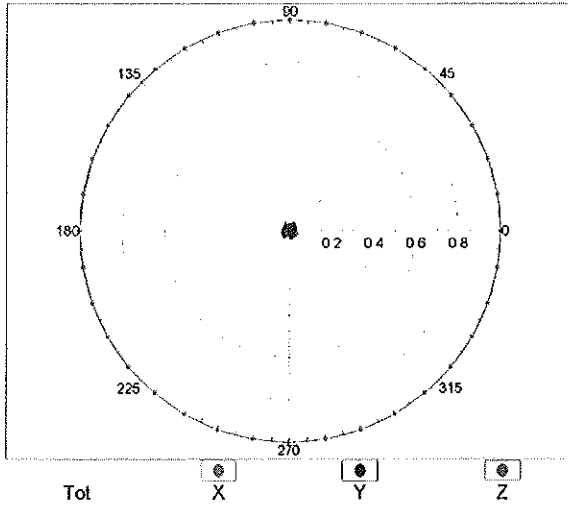

f=2500 MHz, R22, 90°

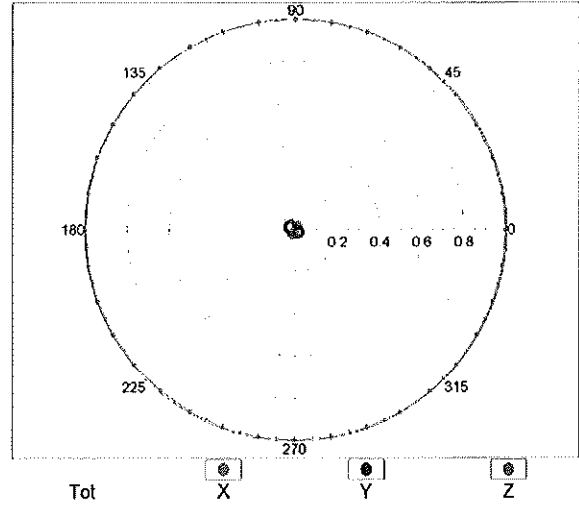

Receiving Pattern (ϕ), $\vartheta = 0^\circ$

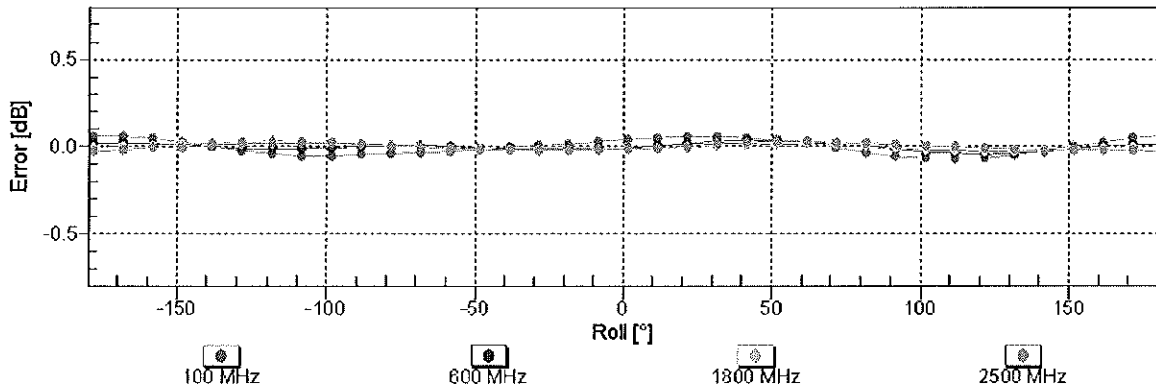

Uncertainty of Axial Isotropy Assessment: $\pm 0.5\%$ ($k=2$)

Receiving Pattern (ϕ), $\vartheta = 90^\circ$

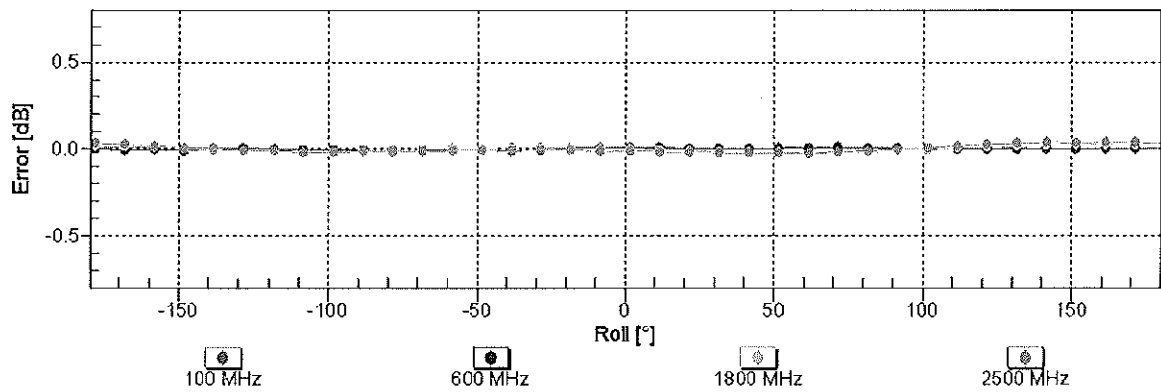

Uncertainty of Axial Isotropy Assessment: $\pm 0.5\%$ ($k=2$)

Dynamic Range f(E-field)

(TEM cell , f = 900 MHz)

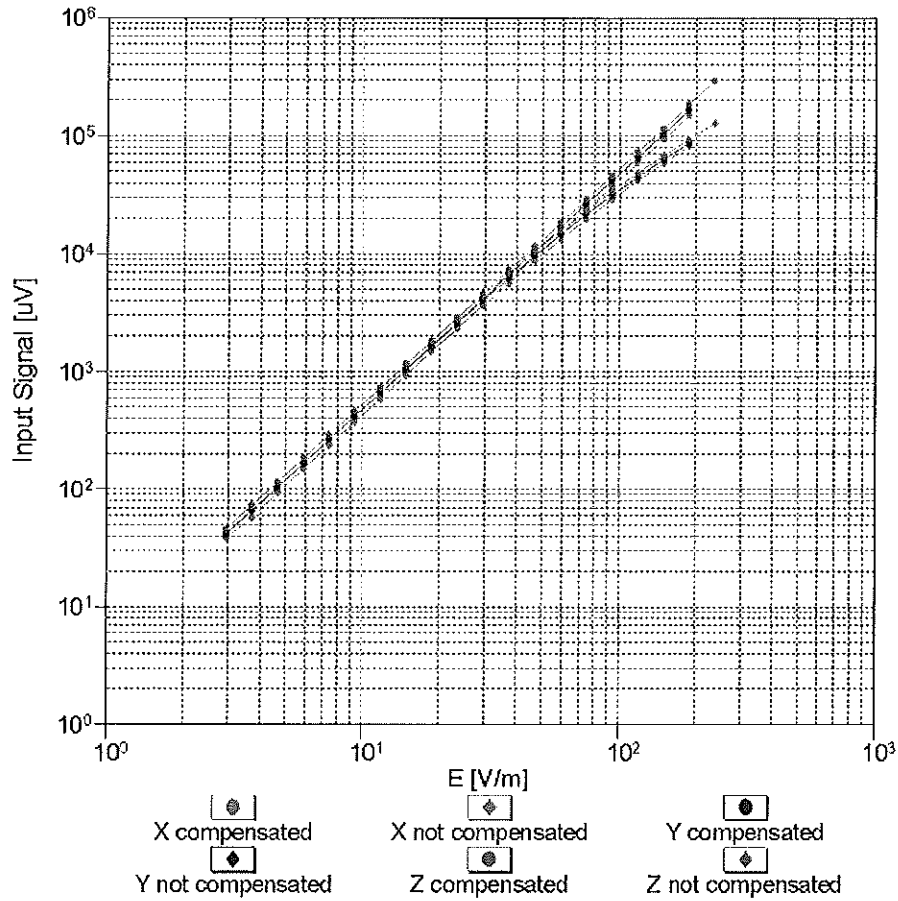

Uncertainty of Linearity Assessment: ± 0.6% (k=2)

Deviation from Isotropy in Air

Error (ϕ , θ), $f = 900$ MHz

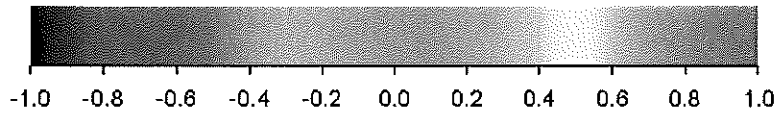
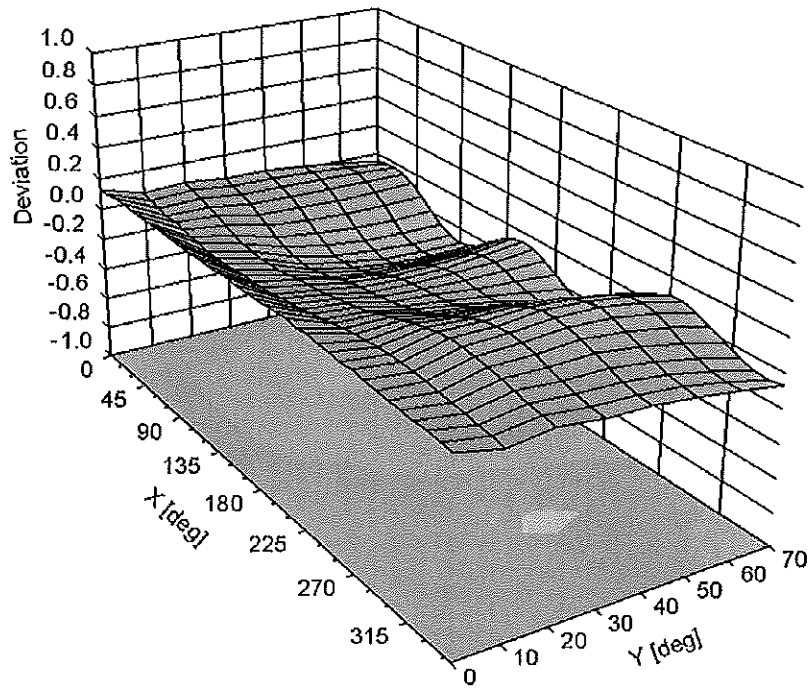

Uncertainty of Spherical Isotropy Assessment: $\pm 2.6\%$ ($k=2$)

DASY/EASY - Parameters of Probe: ER3DV6R - SN:2248

Other Probe Parameters

Sensor Arrangement	Rectangular
Connector Angle (°)	21.6
Mechanical Surface Detection Mode	enabled
Optical Surface Detection Mode	disabled
Probe Overall Length	337 mm
Probe Body Diameter	10 mm
Tip Length	10 mm
Tip Diameter	8 mm
Probe Tip to Sensor X Calibration Point	2.5 mm
Probe Tip to Sensor Y Calibration Point	2.5 mm
Probe Tip to Sensor Z Calibration Point	2.5 mm



Accredited by the Swiss Accreditation Service (SAS)
The Swiss Accreditation Service is one of the signatories to the EA
Multilateral Agreement for the recognition of calibration certificates

Accreditation No.: **SCS 108**

Client **Motorola MDb**

Certificate No: **H3-6074_Apr11**

CALIBRATION CERTIFICATE

Object **H3DV6 - SN:6074**

Calibration procedure(s) **QA CAL-03.v6, QA CAL-25.v3
Calibration procedure for H-field probes optimized for close near field
evaluations in air**

Calibration date: **April 11, 2011**

This calibration certificate documents the traceability to national standards, which realize the physical units of measurements (SI).
The measurements and the uncertainties with confidence probability are given on the following pages and are part of the certificate.

All calibrations have been conducted in the closed laboratory facility: environment temperature (22 ± 3)°C and humidity < 70%.

Calibration Equipment used (M&TE critical for calibration)

Primary Standards	ID	Cal Date (Certificate No.)	Scheduled Calibration
Power meter E4419B	GB41293874	31-Mar-11 (No. 217-01372)	Apr-12
Power sensor E4412A	MY41495277	31-Mar-11 (No. 217-01372)	Apr-12
Power sensor E4412A	MY41498087	31-Mar-11 (No. 217-01372)	Apr-12
Reference 3 dB Attenuator	SN: S5054 (3c)	29-Mar-11 (No. 217-01369)	Apr-12
Reference 20 dB Attenuator	SN: S5086 (20b)	29-Mar-11 (No. 217-01367)	Apr-12
Reference 30 dB Attenuator	SN: S5129 (30b)	29-Mar-11 (No. 217-01370)	Apr-12
Reference Probe H3DV6	SN: 6182	4-Oct-10 (No. H3-6182_Oct10)	Oct-11
DAE4	SN: 789	16-Feb-11 (No. DAE4-789_Feb11)	Feb-12
Secondary Standards	ID	Check Date (in house)	Scheduled Check
RF generator HP 8648C	US3642U01700	4-Aug-99 (in house check Oct-09)	In house check: Oct-11
Network Analyzer HP 8753E	US37390585	18-Oct-01 (in house check Oct-10)	In house check: Oct-11

Calibrated by:	Name Claudio Leubler	Function Laboratory Technician	Signature
Approved by:	Name Katja Pokovic	Function Technical Manager	Signature

Issued: April 18, 2011

This calibration certificate shall not be reproduced except in full without written approval of the laboratory.



Accredited by the Swiss Accreditation Service (SAS)
The Swiss Accreditation Service is one of the signatories to the EA
Multilateral Agreement for the recognition of calibration certificates

Accreditation No.: **SCS 108**

Glossary:

NORM _{x,y,z}	sensitivity in free space
DCP	diode compression point
CF	crest factor (1/duty_cycle) of the RF signal
A, B, C	modulation dependent linearization parameters
Polarization φ	φ rotation around probe axis
Polarization ϑ	ϑ rotation around an axis that is in the plane normal to probe axis (at measurement center), i.e., $\vartheta = 0$ is normal to probe axis
Connector Angle	information used in DASY system to align probe sensor X to the robot coordinate system

Calibration is Performed According to the Following Standards:

- a) IEEE Std 1309-2005, "IEEE Standard for calibration of electromagnetic field sensors and probes, excluding antennas, from 9 kHz to 40 GHz", December 2005.

Methods Applied and Interpretation of Parameters:

- *NORM_{x,y,z}*: Assessed for E-field polarization $\vartheta = 0$ for XY sensors and $\vartheta = 90$ for Z sensor ($f \leq 900$ MHz in TEM-cell; $f > 1800$ MHz: R22 waveguide).
- *X,Y,Z(f)_a0a1a2*= X,Y,Z_a0a1a2* *frequency_response* (see Frequency Response Chart).
- *DCP_{x,y,z}*: DCP are numerical linearization parameters assessed based on the data of power sweep with CW signal (no uncertainty required). DCP does not depend on frequency nor media.
- *A_{x,y,z}; B_{x,y,z}; C_{x,y,z}, VR_{x,y,z}*: A, B, C are numerical linearization parameters assessed based on the data of power sweep for specific modulation signal. The parameters do not depend on frequency nor media. VR is the maximum calibration range expressed in RMS voltage across the diode.
- *Spherical isotropy (3D deviation from isotropy)*: in a locally homogeneous field realized using an open waveguide setup.
- *Sensor Offset*: The sensor offset corresponds to the offset of virtual measurement center from the probe tip (on probe axis). No tolerance required.
- *Connector Angle*: The angle is assessed using the information gained by determining the *X_a0a1a2* (no uncertainty required).

Probe H3DV6

SN:6074

Manufactured: October 2, 2000
Calibrated: April 11, 2011

Calibrated for DASY/EASY Systems
(Note: non-compatible with DASY2 system!)

DASY/EASY - Parameters of Probe: H3DV6 - SN:6074

Basic Calibration Parameters

		Sensor X	Sensor Y	Sensor Z	Unc (k=2)
Norm (A/m / $\sqrt{\text{mV}}$)	a0	2.72E-003	2.74E-003	3.25E-003	$\pm 5.1 \%$
Norm (A/m / $\sqrt{\text{mV}}$)	a1	-6.60E-005	-1.78E-004	-3.72E-004	$\pm 5.1 \%$
Norm (A/m / $\sqrt{\text{mV}}$)	a2	2.82E-005	-3.23E-005	1.76E-005	$\pm 5.1 \%$
DCP (mV) ^B		91.1	92.7	93.6	

Modulation Calibration Parameters

UID	Communication System Name	PAR		A dB	B dB	C dB	VR mV	Unc ^E (k=2)
10000	CW	0.00	X	0.00	0.00	1.00	93.9	$\pm 2.5 \%$
			Y	0.00	0.00	1.00	100.8	
			Z	0.00	0.00	1.00	93.4	

The reported uncertainty of measurement is stated as the standard uncertainty of measurement multiplied by the coverage factor k=2, which for a normal distribution corresponds to a coverage probability of approximately 95%.

^B Numerical linearization parameter: uncertainty not required.

^E Uncertainty is determined using the max. deviation from linear response applying rectangular distribution and is expressed for the square of the field value.

Frequency Response of H-Field (TEM-Cell:ifi110 EXX, Waveguide: R22)

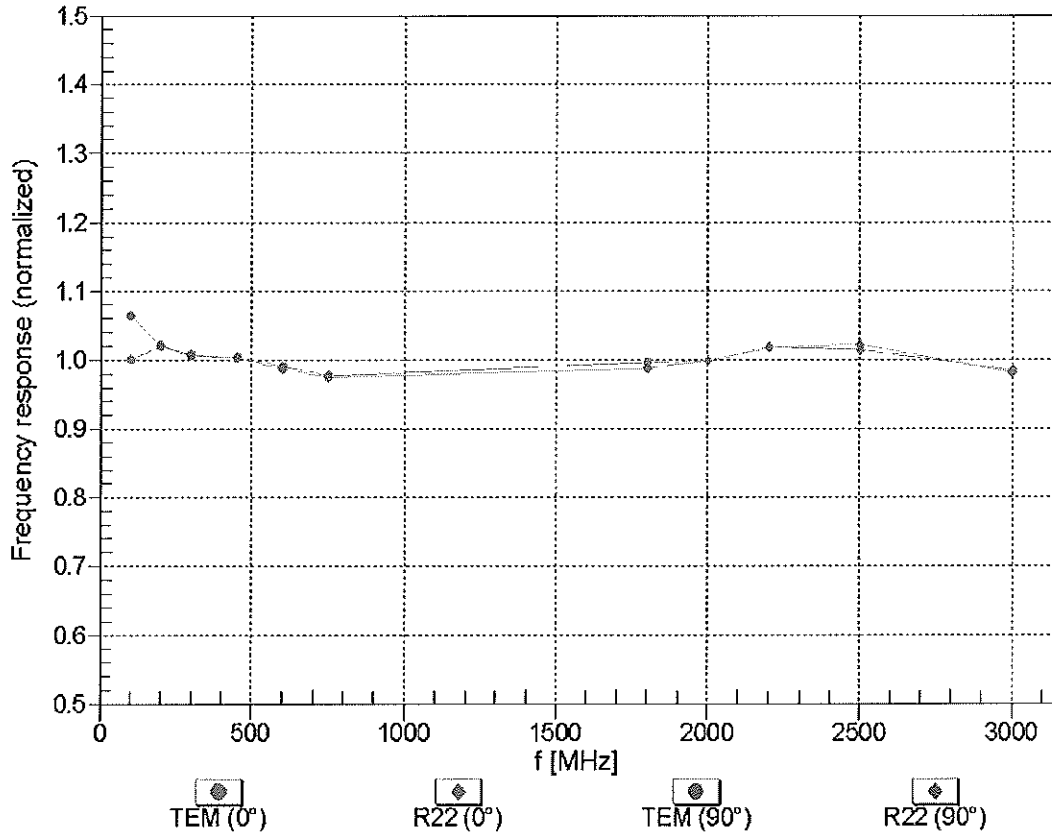

Uncertainty of Frequency Response of H-field: $\pm 6.3\%$ (k=2)

Receiving Pattern (ϕ), $\vartheta = 0^\circ$

f=600 MHz, TEM, 0°

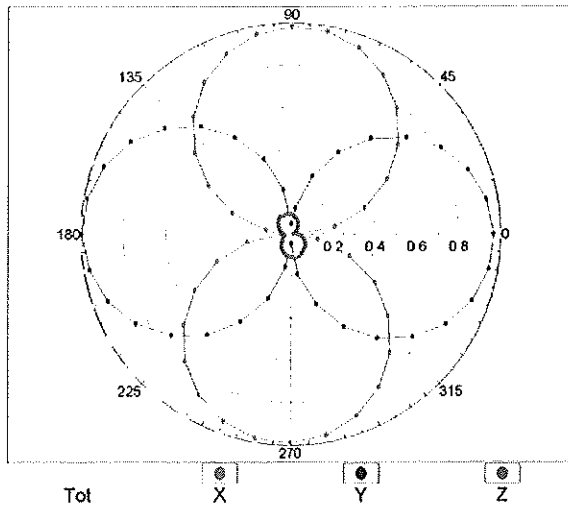

f=2500 MHz, R22, 0°

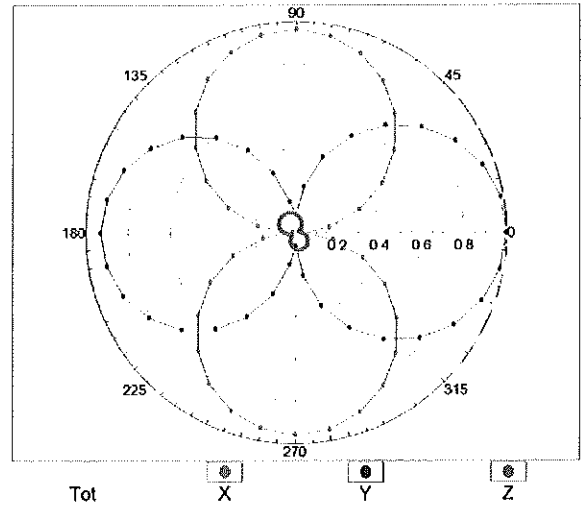

Receiving Pattern (ϕ), $\vartheta = 90^\circ$

f=600 MHz, TEM, 90°

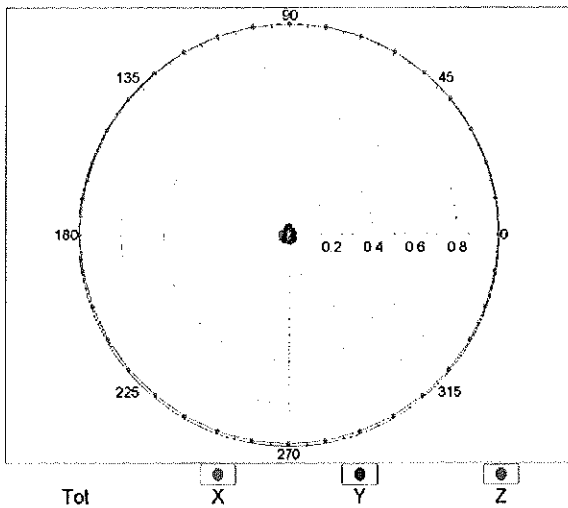

f=2500 MHz, R22, 90°

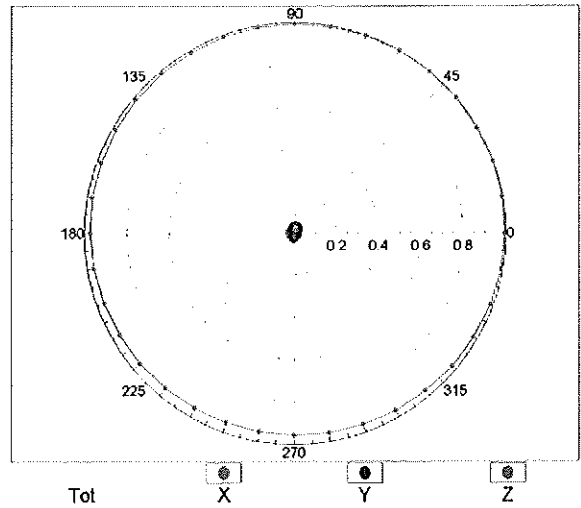

Receiving Pattern (ϕ), $\vartheta = 0^\circ$

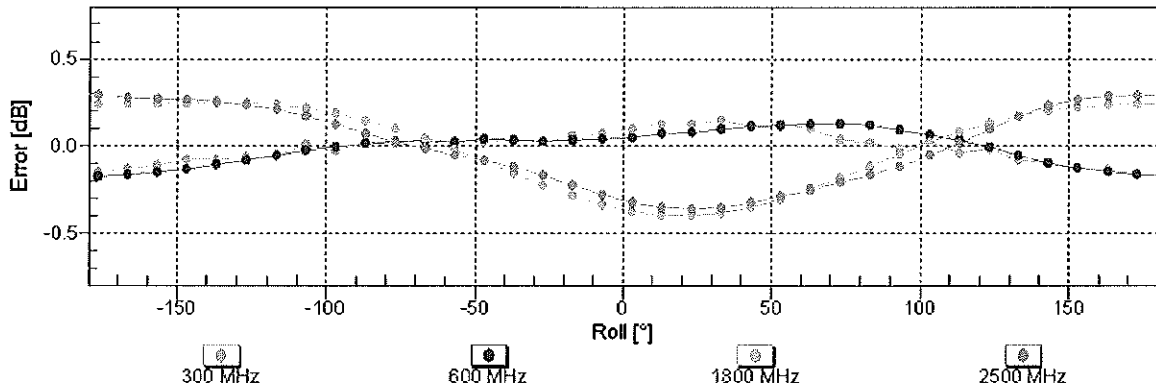

Uncertainty of Axial Isotropy Assessment: $\pm 0.5\%$ ($k=2$)

Receiving Pattern (ϕ), $\vartheta = 90^\circ$

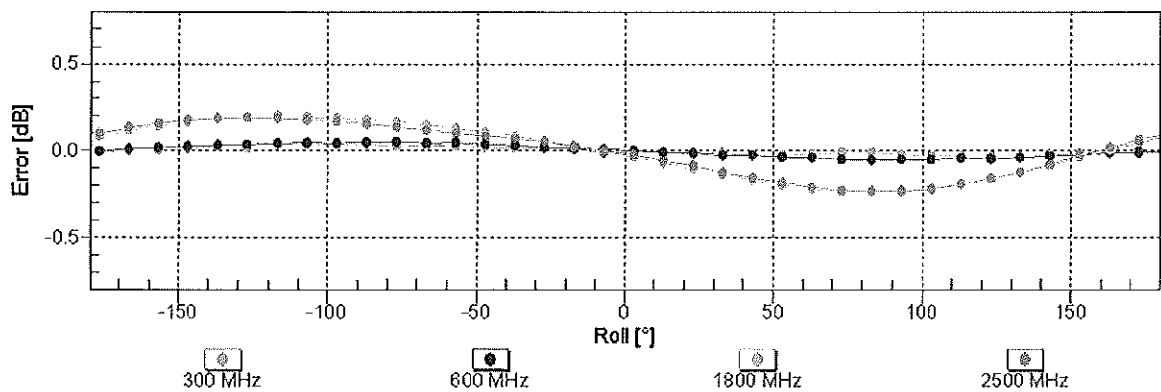

Uncertainty of Axial Isotropy Assessment: $\pm 0.5\%$ ($k=2$)

Dynamic Range f(H-field)

(TEM cell, f = 900 MHz)

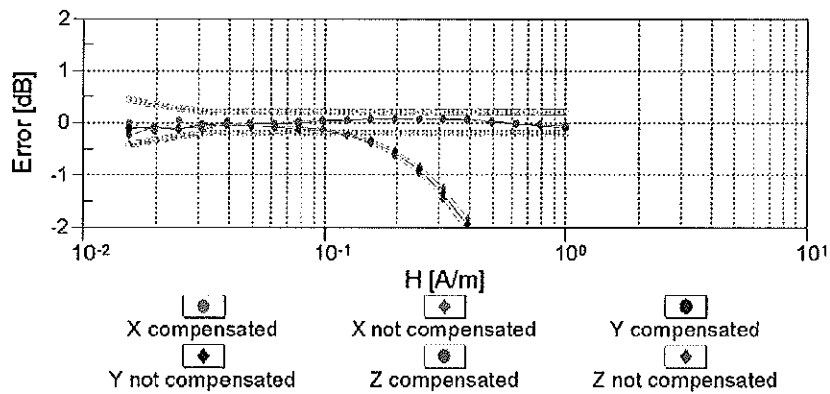
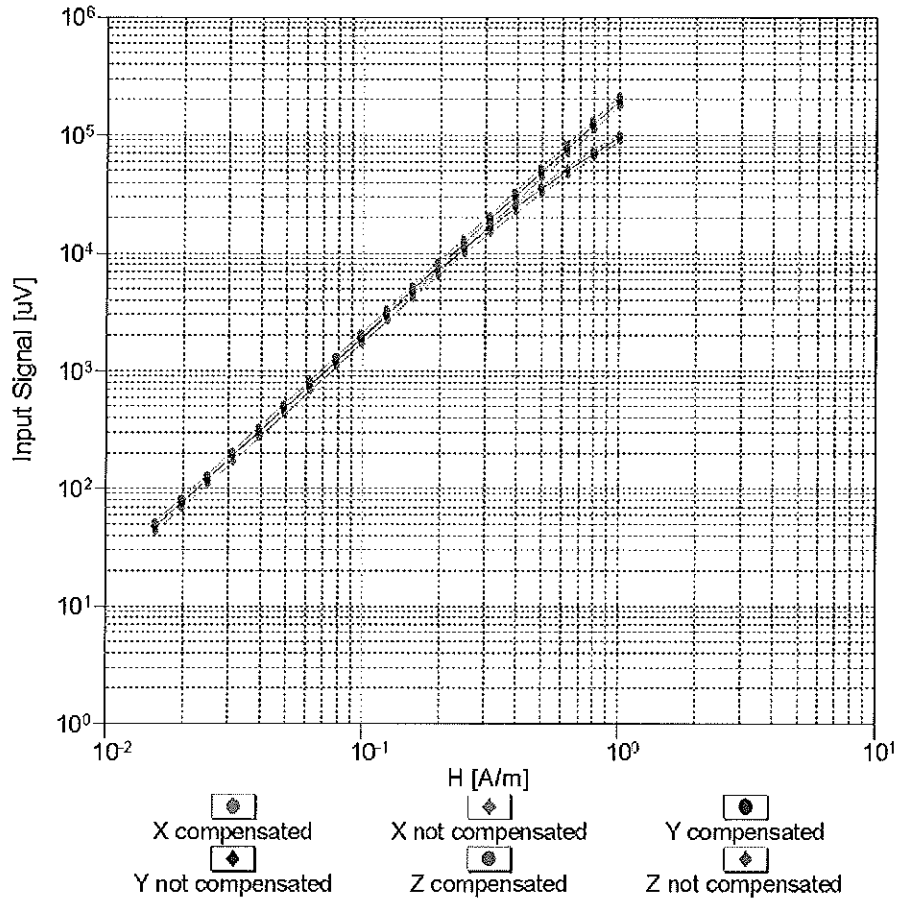

Uncertainty of Linearity Assessment: ± 0.6% (k=2)

Deviation from Isotropy in Air

Error (ϕ , θ), $f = 900$ MHz

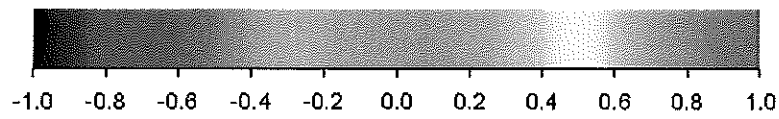
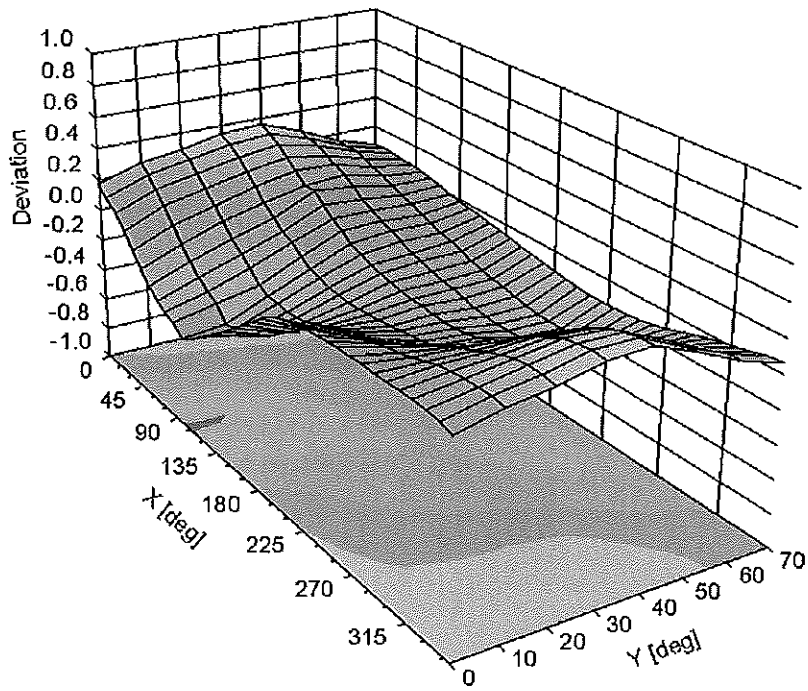

Uncertainty of Spherical Isotropy Assessment: $\pm 2.6\%$ ($k=2$)

DASY/EASY - Parameters of Probe: H3DV6 - SN:6074

Other Probe Parameters

Sensor Arrangement	Rectangular
Connector Angle (°)	-167
Mechanical Surface Detection Mode	enabled
Optical Surface Detection Mode	disabled
Probe Overall Length	337 mm
Probe Body Diameter	10 mm
Tip Length	20 mm
Tip Diameter	6 mm
Probe Tip to Sensor X Calibration Point	3 mm
Probe Tip to Sensor Y Calibration Point	3 mm
Probe Tip to Sensor Z Calibration Point	3 mm

Appendix 7

Dipole Characterization Certificates



Accredited by the Swiss Accreditation Service (SAS)
The Swiss Accreditation Service is one of the signatories to the EA
Multilateral Agreement for the recognition of calibration certificates

Accreditation No.: **SCS 108**

Client **Motorola MDb**

Certificate No: **CD835V3-1076_Feb10**

CALIBRATION CERTIFICATE

Object **CD835V3 - SN: 1076**

Calibration procedure(s) **QA CAL-20.v5
Calibration procedure for dipoles in air**

Calibration date: **February 16, 2010**

This calibration certificate documents the traceability to national standards, which realize the physical units of measurements (SI).
All calibrations have been conducted in the closed laboratory facility: environment temperature (22 ± 3)°C and humidity < 70%.

Calibration Equipment used (M&TE critical for calibration)

Primary Standards	ID #	Cal Date (Certificate No.)	Scheduled Calibration
Power meter EPM-442A	GB37480704	06-Oct-09 (No. 217-01086)	Oct-10
Power sensor HP 8481A	US37292783	06-Oct-09 (No. 217-01086)	Oct-10
Probe ER3DV6	SN: 2336	30-Dec-09 (No. ER3-2336_Dec09)	Dec-10
Probe H3DV6	SN: 6065	30-Dec-09 (No. H3-6065_Dec09)	Dec-10
DAE4	SN: 781	22-Jan-10 (No. DAE4-781_Jan10)	Jan-11
Secondary Standards	ID #	Check Date (in house)	Scheduled Check
Power meter Agilent 4419B	SN: GB42420191	09-Oct-09 (in house check Oct-09)	In house check: Oct-10
Power sensor HP 8482H	SN: 3318A09450	09-Oct-09 (in house check Oct-09)	In house check: Oct-10
Power sensor HP 8482A	SN: US37295597	09-Oct-09 (in house check Oct-09)	In house check: Oct-10
Network Analyzer HP 8753E	US37390585	18-Oct-01 (in house check Oct-09)	In house check: Oct-10
RF generator E4433B	MY 41000675	03-Nov-04 (in house check Oct-09)	In house check: Oct-11

Calibrated by:	Name Claudio Leubler	Function Laboratory Technician	Signature
Approved by:	Name Fin Bomholt	Function Technical Director	Signature

Issued: February 23, 2010

This calibration certificate shall not be reproduced except in full without written approval of the laboratory.



Accredited by the Swiss Accreditation Service (SAS)
The Swiss Accreditation Service is one of the signatories to the EA
Multilateral Agreement for the recognition of calibration certificates

Accreditation No.: **SCS 108**

References

- [1] ANSI-C63.19-2006
American National Standard for Methods of Measurement of Compatibility between Wireless Communications Devices and Hearing Aids.
- [2] ANSI-C63.19-2007
American National Standard for Methods of Measurement of Compatibility between Wireless Communications Devices and Hearing Aids.

Methods Applied and Interpretation of Parameters:

- *Coordinate System:* y-axis is in the direction of the dipole arms. z-axis is from the basis of the antenna (mounted on the table) towards its feed point between the two dipole arms. x-axis is normal to the other axes. In coincidence with the standards [1, 2], the measurement planes (probe sensor center) are selected to be at a distance of 10 mm above the top edge of the dipole arms.
- *Measurement Conditions:* Further details are available from the hardcopies at the end of the certificate. All figures stated in the certificate are valid at the frequency indicated. The forward power to the dipole connector is set with a calibrated power meter connected and monitored with an auxiliary power meter connected to a directional coupler. While the dipole under test is connected, the forward power is adjusted to the same level.
- *Antenna Positioning:* The dipole is mounted on a HAC Test Arch phantom using the matching dipole positioner with the arms horizontal and the feeding cable coming from the floor. The measurements are performed in a shielded room with absorbers around the setup to reduce the reflections. It is verified before the mounting of the dipole under the Test Arch phantom, that its arms are perfectly in a line. It is installed on the HAC dipole positioner with its arms parallel below the dielectric reference wire and able to move elastically in vertical direction without changing its relative position to the top center of the Test Arch phantom. The vertical distance to the probe is adjusted after dipole mounting with a DASY5 Surface Check job. Before the measurement, the distance between phantom surface and probe tip is verified. The proper measurement distance is selected by choosing the matching section of the HAC Test Arch phantom with the proper device reference point (upper surface of the dipole) and the matching grid reference point (tip of the probe) considering the probe sensor offset. The vertical distance to the probe is essential for the accuracy.
- *Feed Point Impedance and Return Loss:* These parameters are measured using a HP 8753E Vector Network Analyzer. The impedance is specified at the SMA connector of the dipole. The influence of reflections was eliminating by applying the averaging function while moving the dipole in the air, at least 70cm away from any obstacles.
- *E- field distribution:* E field is measured in the x-y-plane with an isotropic ER3D-field probe with 100 mW forward power to the antenna feed point. In accordance with [1, 2], the scan area is 20mm wide, its length exceeds the dipole arm length (180 or 90mm). The sensor center is 10 mm (in z) above the top of the dipole arms. Two 3D maxima are available near the end of the dipole arms. Assuming the dipole arms are perfectly in one line, the average of these two maxima (in subgrid 2 and subgrid 8) is determined to compensate for any non-parallelity to the measurement plane as well as the sensor displacement. The E-field value stated as calibration value represents the maximum of the interpolated 3D-E-field, 10mm above the dipole surface.
- *H-field distribution:* H-field is measured with an isotropic H-field probe with 100mW forward power to the antenna feed point, in the x-y-plane. The scan area and sensor distance is equivalent to the E-field scan. The maximum of the field is available at the center (subgrid 5) above the feed point. The H-field value stated as calibration value represents the maximum of the interpolated H-field, 10mm above the dipole surface at the feed point.

1 Measurement Conditions

DASY system configuration, as far as not given on page 1.

DASY Version	DASY5	V5.2 B162
DASY PP Version	SEMCAD X	V14.0 B57
Phantom	HAC Test Arch	SD HAC P01 BA, #1070
Distance Dipole Top - Probe Center	10 mm	
Scan resolution	dx, dy = 5 mm	area = 20 x 180 mm
Frequency	835 MHz ± 1 MHz	
Forward power at dipole connector	20.0 dBm = 100mW	
Input power drift	< 0.05 dB	

2 Maximum Field values

H-field 10 mm above dipole surface	condition	interpolated maximum
Maximum measured	100 mW forward power	0.459 A/m

Uncertainty for H-field measurement: 8.2% (k=2)

E-field 10 mm above dipole surface	condition	Interpolated maximum
Maximum measured above high end-	100 mW forward power	170.0 V/m
Maximum measured above low end	100 mW forward power	159.5 V/m
Averaged maximum above arm	100 mW forward power	164.8 V/m

Uncertainty for E-field measurement: 12.8% (k=2)

3 Appendix

3.1 Antenna Parameters

Frequency	Return Loss	Impedance
800 MHz	16.1 dB	(44.1 – j13.7) Ohm
835 MHz	28.4 dB	(49.6 + j3.8) Ohm
900 MHz	17.7 dB	(56.0 – j12.6) Ohm
950 MHz	22.0 dB	(47.9 + j7.5) Ohm
960 MHz	16.1 dB	(54.7 + j16.0) Ohm

3.2 Antenna Design and Handling

The calibration dipole has a symmetric geometry with a built-in two stub matching network, which leads to the enhanced bandwidth.

The dipole is built of standard semirigid coaxial cable. The internal matching line is open ended. The antenna is therefore open for DC signals.

Do not apply force to dipole arms, as they are liable to bend. The soldered connections near the feedpoint may be damaged. After excessive mechanical stress or overheating, check the impedance characteristics to ensure that the internal matching network is not affected.

After long term use with 40W radiated power, only a slight warming of the dipole near the feedpoint can be measured.

3.3 Measurement Sheets

X

3.3.1 Return Loss and Smith Chart

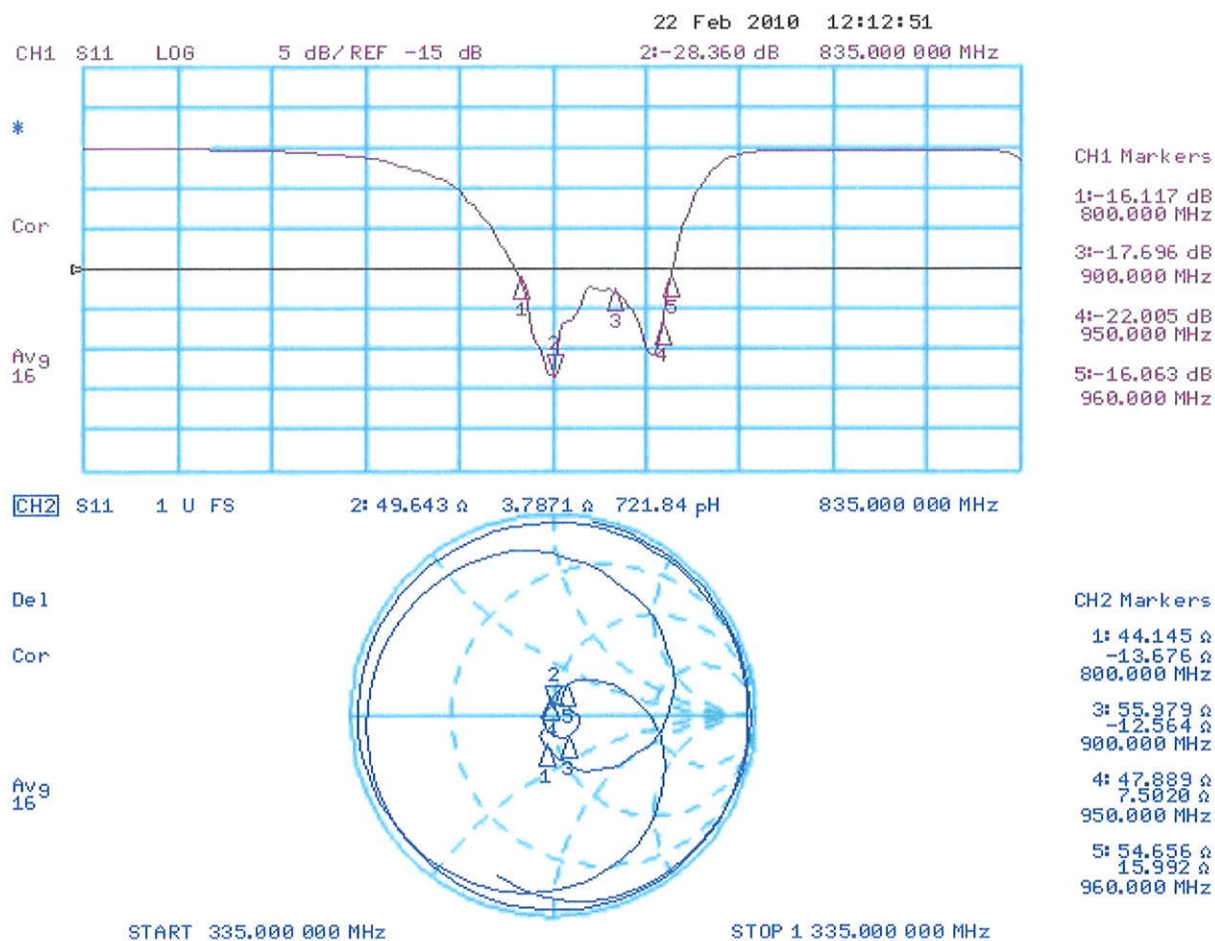

3.3.2 DASY4 H-field Result

Date/Time: 16.02.2010 13:12:57

Test Laboratory: SPEAG Lab2

HAC RF_CD835_1076_100216_H_CL

DUT: HAC-Dipole 835 MHz; Type: CD835V3; Serial: 1076

Communication System: CW; Frequency: 835 MHz;

Medium parameters used: $\sigma = 0$ mho/m, $\epsilon_r = 1$; $\rho = 1$ kg/m³

Phantom section: RF Section

Measurement Standard: DASY5 (IEEE/IEC/ANSI C63.19-2007)

DASY5 Configuration:

- Probe: H3DV6 - SN6065; ; Calibrated: 30.12.2009
- Sensor-Surface: (Fix Surface)
- Electronics: DAE4 Sn781; Calibrated: 22.01.2010
- Phantom: HAC Test Arch with AMCC; Type: SD HAC P01 BA; Serial: 1070
- Measurement SW: DASY5, V5.2 Build 162; SEMCAD X Version 14.0 Build 57

Dipole H-Field measurement @ 835MHz/H Scan - measurement distance from the probe sensor center to CD835 Dipole = 10mm/Hearing Aid Compatibility Test (41x361x1):

Measurement grid: dx=5mm, dy=5mm

Maximum value of peak Total field = 0.459 A/m

Probe Modulation Factor = 1

Device Reference Point: 0, 0, -6.3 mm

Reference Value = 0.487 A/m; Power Drift = 0.013 dB

Hearing Aid Near-Field Category: M4 (AWF 0 dB)

Peak H-field in A/m

Grid 1 0.386 M4	Grid 2 0.399 M4	Grid 3 0.371 M4
Grid 4 0.441 M4	Grid 5 0.459 M4	Grid 6 0.430 M4
Grid 7 0.395 M4	Grid 8 0.414 M4	Grid 9 0.388 M4

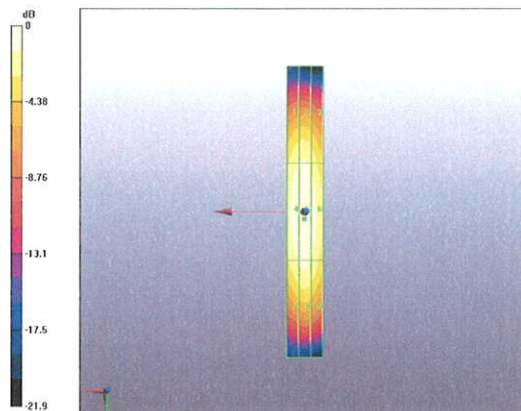

0 dB = 0.459A/m

3.3.3 DASY4 E-field Result

Date/Time: 16.02.2010 17:03:10

Test Laboratory: SPEAG Lab2

HAC RF_CD835_1076_100216_E_CL

DUT: HAC-Dipole 835 MHz; Type: CD835V3; Serial: 1076

Communication System: CW; Frequency: 835 MHz;

Medium parameters used: $\sigma = 0$ mho/m, $\epsilon_r = 1$; $\rho = 1000$ kg/m³

Phantom section: RF Section

Measurement Standard: DASY5 (IEEE/IEC/ANSI C63.19-2007)

DASY5 Configuration:

- Probe: ER3DV6 - SN2336; ConvF(1, 1, 1); Calibrated: 30.12.2009
- Sensor-Surface: (Fix Surface)
- Electronics: DAE4 Sn781; Calibrated: 22.01.2010
- Phantom: HAC Test Arch with AMCC; Type: SD HAC P01 BA; Serial: 1070
- Measurement SW: DASY5, V5.2 Build 162; SEMCAD X Version 14.0 Build 57

Dipole E-Field measurement @ 835MHz/E Scan - measurement distance from the probe sensor center to CD835 Dipole = 10mm/Hearing Aid Compatibility Test (41x361x1):

Measurement grid: dx=5mm, dy=5mm

Maximum value of peak Total field = 170.0 V/m

Probe Modulation Factor = 1

Device Reference Point: 0, 0, -6.3 mm

Reference Value = 106.0 V/m; Power Drift = 0.014 dB

Hearing Aid Near-Field Category: M4 (AWF 0 dB)

Peak E-field in V/m

Grid 1 156.9 M4	Grid 2 159.5 M4	Grid 3 154.8 M4
Grid 4 88.6 M4	Grid 5 90 M4	Grid 6 86.5 M4
Grid 7 161.9 M4	Grid 8 170.0 M4	Grid 9 166.6 M4

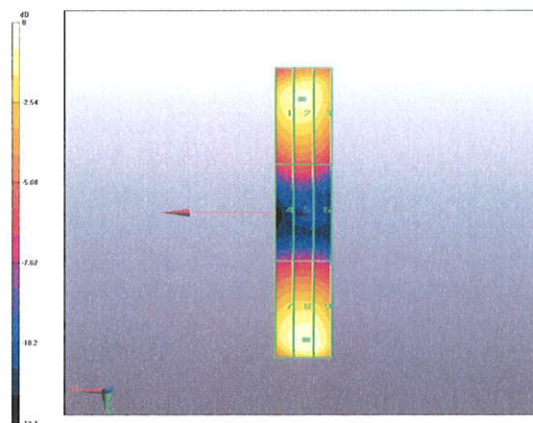

0 dB = 170.0V/m

4. Additional Measurements

4.1 Measurement Conditions

DASY system configuration, as far as not given on page 1.

DASY Version	DASY5	V5.2 B162
DASY PP Version	SEMCAD X	V14.0 B57
Phantom	HAC Test Arch	SD HAC P01 BA, #1070
Distance Dipole Top - Probe Center	10 mm	
Scan resolution	dx, dy = 5 mm	area = 20 x 180 mm
Frequency	813 MHz ± 1 MHz	
Forward power at dipole connector	20.0 dBm = 100mW	
Input power drift	< 0.05 dB	

4.1.1 Maximum Field values

H-field 10 mm above dipole surface	condition	interpolated maximum
Maximum measured	100 mW forward power	0.471 A/m

Uncertainty for H-field measurement: 8.2% (k=2)

E-field 10 mm above dipole surface	condition	Interpolated maximum
Maximum measured above high end-	100 mW forward power	169.1 V/m
Maximum measured above low end	100 mW forward power	168.6 V/m
Averaged maximum above arm	100 mW forward power	168.9 V/m

Uncertainty for E-field measurement: 12.8% (k=2)

4.1.2 DASY4 H-field result

Date/Time: 16.02.2010 12:50:00

Test Laboratory: SPEAG Lab2

HAC RF_CD835_1076_100216_H_CL

DUT: HAC-Dipole 835 MHz; Type: CD835V3; Serial: 1076

Communication System: CW; Frequency: 813 MHz;

Medium parameters used: $\sigma = 0$ mho/m, $\epsilon_r = 1$; $\rho = 1$ kg/m³

Phantom section: RF Section

Measurement Standard: DASY5 (IEEE/IEC/ANSI C63.19-2007)

DASY5 Configuration:

- Probe: H3DV6 - SN6065; ; Calibrated: 30.12.2009
- Sensor-Surface: (Fix Surface)
- Electronics: DAE4 Sn781; Calibrated: 22.01.2010
- Phantom: HAC Test Arch with AMCC; Type: SD HAC P01 BA; Serial: 1070
- Measurement SW: DASY5, V5.2 Build 162; SEMCAD X Version 14.0 Build 57

Dipole H-Field measurement @ 813MHz/H Scan - measurement distance from the probe sensor center to CD835 (813MHz) Dipole = 10mm/Hearing Aid Compatibility Test (41x361x1):

Measurement grid: dx=5mm, dy=5mm

Maximum value of peak Total field = 0.471 A/m

Probe Modulation Factor = 1

Device Reference Point: 0, 0, -6.3 mm

Reference Value = 0.500 A/m; Power Drift = -0.00617 dB

Hearing Aid Near-Field Category: M4 (AWF 0 dB)

Peak H-field in A/m

Grid 1 0.387 M4	Grid 2 0.403 M4	Grid 3 0.378 M4
Grid 4 0.452 M4	Grid 5 0.471 M4	Grid 6 0.440 M4
Grid 7 0.403 M4	Grid 8 0.420 M4	Grid 9 0.390 M4

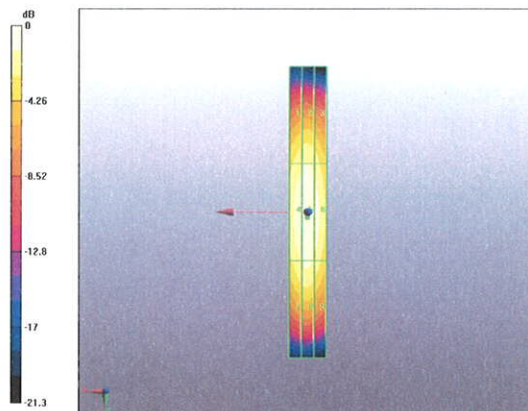

0 dB = 0.471A/m

4.1.3 DASY4 E-field result

Date/Time: 16.02.2010 16:47:06

Test Laboratory: SPEAG Lab2

HAC RF_CD835_1076_100216_E_CL

DUT: HAC-Dipole 835 MHz; Type: CD835V3; Serial: 1076

Communication System: CW; Frequency: 813 MHz

Medium parameters used: $\sigma = 0$ mho/m, $\epsilon_r = 1$; $\rho = 1000$ kg/m³

Phantom section: RF Section

Measurement Standard: DASY5 (IEEE/IEC/ANSI C63.19-2007)

DASY5 Configuration:

- Probe: ER3DV6 - SN2336; ConvF(1, 1, 1); Calibrated: 30.12.2009
- Sensor-Surface: (Fix Surface)
- Electronics: DAE4 Sn781; Calibrated: 22.01.2010
- Phantom: HAC Test Arch with AMCC; Type: SD HAC P01 BA; Serial: 1070
- Measurement SW: DASY5, V5.2 Build 162; SEMCAD X Version 14.0 Build 57

Dipole E-Field measurement @ 813MHz/E Scan - measurement distance from the probe sensor center to CD835 (813MHz) Dipole = 10mm/Hearing Aid Compatibility Test (41x361x1):

Measurement grid: dx=5mm, dy=5mm

Maximum value of peak Total field = 169.1 V/m

Probe Modulation Factor = 1

Device Reference Point: 0, 0, -6.3 mm

Reference Value = 109.2 V/m; Power Drift = 0.013 dB

Hearing Aid Near-Field Category: M4 (AWF 0 dB)

Peak E-field in V/m

Grid 1 165.2 M4	Grid 2 168.6 M4	Grid 3 164.0 M4
Grid 4 94.5 M4	Grid 5 96.4 M4	Grid 6 92.9 M4
Grid 7 161.6 M4	Grid 8 169.1 M4	Grid 9 165.2 M4

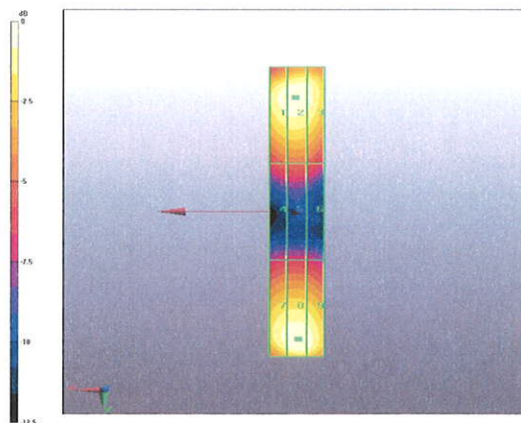

0 dB = 169.1V/m

4.2. Measurement Conditions

DASY system configuration, as far as not given on page 1.

DASY Version	DASY5	V5.2 B162
DASY PP Version	SEMCAD X	V14.0 B57
Phantom	HAC Test Arch	SD HAC P01 BA, #1070
Distance Dipole Top - Probe Center	10 mm	
Scan resolution	dx, dy = 5 mm	area = 20 x 180 mm
Frequency	898 MHz ± 1 MHz	
Forward power at dipole connector	20.0 dBm = 100mW	
Input power drift	< 0.05 dB	

4.2.1 Maximum Field values

H-field 10 mm above dipole surface	condition	interpolated maximum
Maximum measured	100 mW forward power	0.434 A/m

Uncertainty for H-field measurement: 8.2% (k=2)

E-field 10 mm above dipole surface	condition	Interpolated maximum
Maximum measured above high end-	100 mW forward power	160.5 V/m
Maximum measured above low end	100 mW forward power	150.0 V/m
Averaged maximum above arm	100 mW forward power	155.3 V/m

Uncertainty for E-field measurement: 12.8% (k=2)

4.2.2 DASY4 H-field result

Date/Time: 16.02.2010 12:25:41

Test Laboratory: SPEAG Lab2

HAC RF_CD835_1076_100216_H_CL

DUT: HAC-Dipole 835 MHz; Type: CD835V3; Serial: 1076

Communication System: CW; Frequency: 898 MHz;

Medium parameters used: $\sigma = 0$ mho/m, $\epsilon_r = 1$; $\rho = 1$ kg/m³

Phantom section: RF Section

Measurement Standard: DASY5 (IEEE/IEC/ANSI C63.19-2007)

DASY5 Configuration:

- Probe: H3DV6 - SN6065; ; Calibrated: 30.12.2009
- Sensor-Surface: (Fix Surface)
- Electronics: DAE4 Sn781; Calibrated: 22.01.2010
- Phantom: HAC Test Arch with AMCC; Type: SD HAC P01 BA; Serial: 1070
- Measurement SW: DASY5, V5.2 Build 162; SEMCAD X Version 14.0 Build 57

Dipole H-Field measurement @ 898MHz/H Scan - measurement distance from the probe sensor center to CD835 (898MHz) Dipole = 10mm/Hearing Aid Compatibility Test (41x361x1):

Measurement grid: dx=5mm, dy=5mm

Maximum value of peak Total field = 0.434 A/m

Probe Modulation Factor = 1

Device Reference Point: 0, 0, -6.3 mm

Reference Value = 0.455 A/m; Power Drift = -0.014 dB

Hearing Aid Near-Field Category: M4 (AWF 0 dB)

Peak H-field in A/m

Grid 1 0.389 M4	Grid 2 0.403 M4	Grid 3 0.375 M4
Grid 4 0.418 M4	Grid 5 0.434 M4	Grid 6 0.404 M4
Grid 7 0.390 M4	Grid 8 0.408 M4	Grid 9 0.381 M4

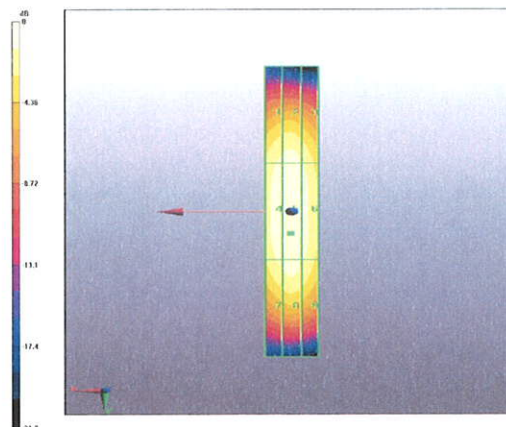

0 dB = 0.434A/m

4.2.3 DASY4 E-field result

Date/Time: 16.02.2010 15:45:32

Test Laboratory: SPEAG Lab2

HAC RF_CD835_1076_100216_E_CL

DUT: HAC-Dipole 835 MHz; Type: CD835V3; Serial: 1076

Communication System: CW; Frequency: 898 MHz;

Medium parameters used: $\sigma = 0$ mho/m, $\epsilon_r = 1$; $\rho = 1000$ kg/m³

Phantom section: RF Section

Measurement Standard: DASY5 (IEEE/IEC/ANSI C63.19-2007)

DASY5 Configuration:

- Probe: ER3DV6 - SN2336; ConvF(1, 1, 1); Calibrated: 30.12.2009
- Sensor-Surface: (Fix Surface)
- Electronics: DAE4 Sn781; Calibrated: 22.01.2010
- Phantom: HAC Test Arch with AMCC; Type: SD HAC P01 BA; Serial: 1070
- Measurement SW: DASY5, V5.2 Build 162; SEMCAD X Version 14.0 Build 57

Dipole E-Field measurement @ 898MHz/E Scan - measurement distance from the probe sensor center to CD835 (898MHz) Dipole = 10mm/Hearing Aid Compatibility Test (41x361x1):

Measurement grid: dx=5mm, dy=5mm

Maximum value of peak Total field = 160.5 V/m

Probe Modulation Factor = 1

Device Reference Point: 0, 0, -6.3 mm

Reference Value = 86.1 V/m; Power Drift = -0.00063 dB

Hearing Aid Near-Field Category: M4 (AWF 0 dB)

Peak E-field in V/m

Grid 1 149.9 M4	Grid 2 150.0 M4	Grid 3 137.3 M4
Grid 4 81 M4	Grid 5 81 M4	Grid 6 73.9 M4
Grid 7 156.7 M4	Grid 8 160.5 M4	Grid 9 148.9 M4

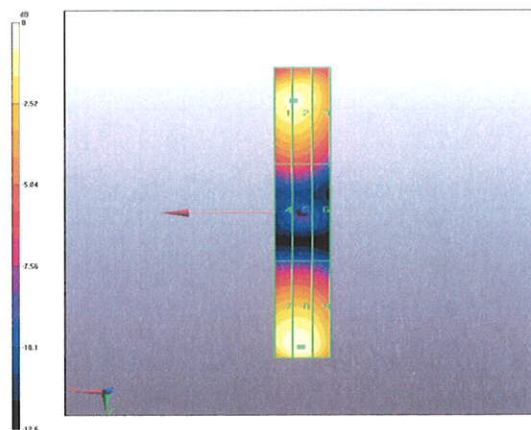

0 dB = 160.5V/m

END OF REPORT